

TargetCall: Eliminating the Wasted Computation in Basecalling via Pre-Basecalling Filtering

Meryem Banu Cavlak¹ Gagandeep Singh¹ Mohammed Alser¹ Can Firtina¹ Joël Lindegger¹
Mohammad Sadrosadati¹ Nika Mansouri Ghiasi¹ Can Alkan² Onur Mutlu¹

¹ETH Zürich

²Bilkent University

Basecalling is an essential step in nanopore sequencing analysis where the raw signals of nanopore sequencers are converted into nucleotide sequences, i.e., reads. State-of-the-art basecallers employ complex deep learning models to achieve high basecalling accuracy. This makes basecalling computationally inefficient and memory-hungry, bottlenecking the entire genome analysis pipeline. However, for many applications, the majority of reads do not match the reference genome of interest (i.e., target reference) and thus are discarded in later steps in the genomics pipeline, wasting the basecalling computation. To overcome this issue, we propose TargetCall, the first pre-basecalling filter to eliminate the wasted computation in basecalling. TargetCall's key idea is to discard reads that will not match the target reference (i.e., off-target reads) prior to basecalling. TargetCall consists of two main components: (1) LightCall, a lightweight neural network basecaller that produces noisy reads; and (2) Similarity Check, which labels each of these noisy reads as on-target or off-target by matching them to the target reference. Our thorough experimental evaluations show that TargetCall 1) improves the end-to-end basecalling runtime performance of the state-of-the-art basecaller by $3.31\times$ while maintaining high (98.88%) recall in keeping on-target reads, 2) maintains high accuracy in downstream analysis, and 3) achieves better runtime performance, throughput, recall, precision, and generality compared to prior works. TargetCall is available at <https://github.com/CMU-SAFARI/TargetCall>.

1. Introduction

Genome sequencing, which determines the nucleotide sequence of an organism's genome, plays a pivotal role in enabling many medical and scientific advancements [1–5]. Modern sequencing technologies produce increasingly large amounts of genomic data at low cost [6]. Leveraging this genomic data requires fast, efficient, and accurate analysis tools.

Current sequencing machines are unable to determine an organism's genome as a single contiguous sequence [7]. Instead, they sequence fragments of a genome, called *reads*. The length of the reads depends on the sequencing technology and significantly affects the performance (i.e., speed or runtime) and accuracy of genome analysis. The use of *long reads* can provide higher accuracy and performance on many genome analysis steps [8–13].

Nanopore sequencing technology is one of the most prominent and widely-used long read sequencing technologies [6, 14–18]. Nanopore sequencing relies on measuring the change in the electrical current when a nucleic acid molecule (DNA or RNA) passes through a pore of nanometer size [19]. The measurement of the electrical current, called a *raw signal*, is converted to a

nucleotide sequence, called a *read*, with a step called *basecalling* [6, 7, 20–23]. Basecalling commonly uses computationally expensive deep neural network (DNN)-based architectures to achieve high basecalling accuracy [24–26], which makes basecalling a computational bottleneck for genome analysis that consumes up to 84.2% of total execution time in genome analysis pipeline [27]. However, the majority of this computation is wasted for genome sequencing applications that do not require the majority of the basecalled reads. For example, in SARS-CoV-2 genome assembly, 96% of the total runtime is spent on basecalling, even though $\geq 99\%$ of the basecalled reads are not required after basecalling because they are not coming from the reference genome that is targeted by the application [28]. Therefore, it is important to eliminate wasted computation in basecalling.

Our **goal** in this work is to eliminate the wasted computation when basecalling the entire read while maintaining high accuracy and applicability to a wide range of genome sequencing applications. To this end, we propose TargetCall, the *first* pre-basecalling filter. TargetCall is based on the key observation that typically the reason for discarding basecalled reads is that they do not match some *target reference* (e.g., a reference genome of interest) [28, 29]. We call these *off-target* reads. Our **key idea** is to filter out off-target reads before basecalling by analyzing the *entire* read with a highly accurate and high-performance *pre-basecalling filter* to eliminate the wasted computation in basecalling of off-target reads.

Prior works in targeted sequencing [19, 28, 30–34] propose *adaptive sampling* techniques to discard off-target reads during sequencing to better utilize sequencers. Sequencers provided by Oxford Nanopore Technologies (ONT) can enable adaptive sampling with a feature known as *Read Until* [30, 35]. ONT sequencers that support Read Until can selectively remove a read from the nanopore while the read is being sequenced. This requires a method to identify which reads are off-target for further downstream analysis to decide which reads to remove from the nanopore. The state-of-the-art adaptive sampling methods can be classified into three groups on their methodology to label the read. The first group converts the target reference into a reference raw signal and performs raw signal-level alignment [19, 28, 35]. The second group generates noisy sequence representations of the raw signal to compare them with the target reference [30, 36]. The third group of works utilizes neural network classifiers to label the sequences [31, 37]. We provide a detailed background on different adaptive sampling approaches in Supplementary Section A.

Even though the labeling techniques of adaptive sampling can be repurposed for pre-basecalling filtering, the adaptive

sampling problem is different from pre-basecalling filtering for three main reasons. First, in adaptive sampling, reads must be labeled during sequencing, requiring only the initial portion of the raw signal to classify reads as off-target or on-target. Analyzing a sub-region or raw signals in adaptive sampling methods often leads to low recall (77.5%–90.40%) [19, 30] or poor basecalling [19, 36], meaning they can falsely reject many on-target reads. In contrast, a pre-basecalling filter can utilize the entire raw signal after the read is fully sequenced, enabling more accurate classification. Second, adaptive sampling has practical limitations, such as the risk of nanopores becoming blocked after a few seconds of sequencing [38], which limits the effectiveness of read ejection. A pre-basecalling filter addresses these limitations by processing the whole signal of all reads, even when adaptive sampling is not feasible. Third, some adaptive sampling methods require re-training classifiers for each different application and target reference [31], while a pre-basecalling filter can be applied without needing re-training, making it more flexible across different use cases. We conclude that pre-basecalling filtering is orthogonal to adaptive sampling and can complement it. Even when adaptive sampling is used to reject reads early, any remaining reads still need to be basecalled, and a pre-basecalling filter can further improve accuracy and efficiency by processing the entire signal of these remaining reads. This makes the pre-basecalling filter a versatile solution that can be applied both independently and in conjunction with adaptive sampling approaches. TargetCall aims to overcome the challenges of state-of-the-art methods by utilizing the entire raw signal for classification, making it a widely applicable solution.

TargetCall consists of two main components: 1) *LightCall*, a light-weight basecaller with a simple neural network model that outputs erroneous (i.e., noisy) reads with high performance; and 2) *Similarity Check* to compute the similarity of the noisy read to the target reference where the similarity is determined by conventional read mapping pipeline. LightCall’s model is $33.31\times$ smaller than the state-of-the-art basecaller, Bonito’s model [39]. This reduction in the model improves the basecalling speed substantially with a small (4.85%) reduction in basecalling accuracy. Although reducing the basecalling accuracy might cause LightCall to be not applicable to some of the downstream analyses that require high basecalling accuracy [40], it is sufficient for Similarity Check to perform pre-basecalling filtering. We use the state-of-the-art read mapper minimap2 [41] for Similarity Check. TargetCall overcomes all three limitations of prior methods. First, Similarity Check’s high accuracy enables TargetCall’s accuracy to be significantly higher than prior adaptive sampling approaches. Second, LightCall’s performance is independent of the target reference size, which enables TargetCall to be applicable to target reference sizes for which prior works were inapplicable. Third, unlike prior approaches that require re-training the network for each application and target reference, LightCall does not need to be re-trained.

Key Results. We evaluate the performance and accuracy impact of TargetCall on the state-of-the-art basecaller Bonito [39], and compare TargetCall with two state-of-the-art adaptive sam-

pling methods, UNCALLED [30] and Sigmap [19], repurposed as pre-basecalling filters. TargetCall 1) improves the end-to-end runtime performance (i.e., runtime of all the steps, including basecalling and read mapping, used in an analysis) by $3.31\times$ over Bonito, 2) precisely filters out 94.71% of the off-target reads, and 3) maintains high recall in keeping on-target reads with 98.88% recall. We show that TargetCall provides high accuracy in a specific downstream analysis that aims to estimate the relative abundance (RA) of organisms in a given sample even after losing 1.12% of on-target reads. We demonstrate that TargetCall improves 1) runtime performance by $1.46\times/9.72\times$, 2) throughput by $1124.03\times/42.08\times$, 3) recall by $+3.09\%/+23.15\%$, and 4) precision by $+58.48\%/+62.31\%$ over prior works UNCALLED/Sigmap while requiring much less peak memory (on average $5.76\times$) and maintaining scalability to longer target references.

This paper makes the following contributions:

- We introduce the problem of pre-basecalling filtering that aims to classify reads utilizing the entire raw signal information.
- We introduce the first pre-basecalling filter that eliminates the wasted computation in basecalling by leveraging the fact that the majority of reads are discarded after basecalling.
- We propose LightCall, a lightweight neural network model that significantly increases the performance of basecalling with minor reductions in basecalling accuracy.
- TargetCall provides larger runtime performance and accuracy benefits compared to the state-of-the-art adaptive sampling works for basecalling.
- To aid research and reproducibility, we freely open source our implementation of TargetCall at <https://github.com/CMU-SAFARI/TargetCall>.

2. Materials and Methods

Our goal in this work is to eliminate the wasted computation in basecalling using an accurate pre-basecalling filtering technique. To this end, we propose TargetCall, that can perform pre-basecalling filtering in *all* genome sequencing applications accurately and efficiently without any additional overhead. To our knowledge, TargetCall is the first pre-basecalling filter that is applicable to a wide range of use cases and makes use of entire raw signal information to classify nanopore raw signals. TargetCall’s key idea is to quickly filter out off-target reads (i.e., reads that are dissimilar to the *target reference*.) before the basecalling step to eliminate the wasted computation in basecalling. We present the high-level overview of TargetCall in Section 2.1, and explain its components in Sections 2.2 and 2.3.

2.1. High Level Overview

Figure 1 shows TargetCall’s workflow. First, TargetCall performs noisy basecalling on the raw signal using LightCall (1). The output sequence of LightCall is highly accurate but erroneous compared to the reads basecalled using state-of-the-art basecallers. Second, Similarity Check compares the noisy read of LightCall to the target reference for labeling the read as an on-target or off-target read (2). TargetCall stops the analysis of off-target reads by removing them from the pipeline (3), whereas

the analysis of the on-target reads continues with basecalling following the usual genomics pipeline to maintain basecalling accuracy¹ (4).

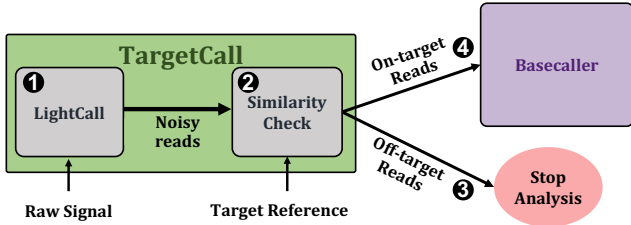

Figure 1: High-level overview of TargetCall.

The choice of the target reference depends on the specific genome sequencing application. The size of the target reference is a major constraint in most prior works, limiting the generality of the prior approaches. We design TargetCall such that its runtime performance scales well with the size of the target reference so that it is applicable to any genome sequencing application. We achieve our design goal because 1) the performance of LightCall is independent of the size of the target reference, and 2) the performance of Similarity Check module scales well with the increasing target reference size.

2.2. LightCall

LightCall, the first component of TargetCall, is a lightweight neural network-based basecaller that produces noisy reads. Although LightCall is not designed to be as accurate as the state-of-the-art basecallers, its combination with Similarity Check is effective in determining if the read is an on-target read with respect to the target reference. We develop LightCall by modifying the state-of-the-art basecaller Bonito’s architecture in three ways: 1) reducing the channel sizes of convolution layers, 2) removing the skip connections, and 3) reducing the number of basic convolution blocks. Prior work [26] shows that Bonito’s model is over-provisioned, and we can maintain very high accuracy with reduced model sizes. Following prior work’s insight, we generate different neural network models by pruning the channel sizes of convolution and convolution blocks. The specific LightCall configurations are tested and designed based on our intuition. We select the neural network architecture for LightCall that balances basecalling accuracy with the pre-basecalling filtering performance.

Figure 2 shows the architecture of LightCall. Each block consists of grouped 1-dimensional convolution and pointwise 1-dimensional convolution. The convolution operation is followed by batch normalization (Batch Norm) [42] and a rectified linear unit (ReLU) [43] activation function. The final output is passed through a connectionist temporal classification (CTC) [44] layer to produce the decoded sequence of nucleotides (A, C, G, T). The CTC layer acts as the loss function by providing the correct alignment between the input and the output sequence. The CTC loss allows the model to handle the variable-length sequences by aligning the model’s output to the target sequence while ignoring the blank or padding symbols. Our LightCall archi-

¹Basecalling accuracy is calculated as the ratio of the number of correctly identified bases to the total number of bases in the read, expressed as a percentage.

ture is composed of 18 convolution blocks containing ~ 292 thousand model parameters ($\sim 33.35\times$ lower parameters than Bonito).

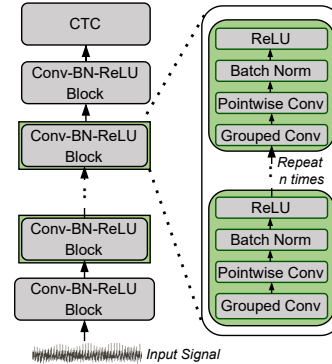

Figure 2: Overview of LightCall architecture.

Modern deep learning-based basecallers [20, 21, 26, 45–50] incorporate skip connections to help mitigate the vanishing gradient and saturation problems [51]. Removing skip connections has a higher impact on basecalling accuracy. However, adding skip connections introduces the following three issues for performance [26, 52]. First, the skip connections increase the data lifetime. The layers whose activations are reused in subsequent layers must wait for this activation reuse (or buffer the activations in memory) before accepting new input and continuing to compute. This leads to high resource and storage requirements due to data duplication. Second, skip connections introduce irregularity in neural network architecture as these connections span across non-adjacent layers. Third, skip connections require additional computation to adjust the channel size to match the channel size at the non-consecutive layer’s input. Therefore, we remove the skip connections as we can tolerate lower accuracy of LightCall to improve the performance of TargetCall.

LightCall works by splitting a long read in raw signal format (e.g., millions of samples) into multiple smaller chunks (e.g., thousands of samples per chunk) and basecalling these chunks. The CTC layer assigns a probability for all possible labels (i.e., A, C, G, T) at each sequence position for a chunk. The label with the highest probability is selected as the final output for a sequence position. LightCall merges the outputs of each position to produce the basecalled chunk and merges the basecalled chunks to output the basecalled read. Since LightCall’s algorithm is independent of the target reference, LightCall’s performance does not depend on the target reference length.

2.3. Similarity Check

After LightCall outputs the noisy read that approximately represents the raw signal, Similarity Check compares the noisy read to the target reference. For this task, we use a procedure common in genome analysis, known as sequence alignment. Sequence alignment computes the similarity between a read and a reference. To provide a scalable and fast solution for Similarity Check, we use minimap2, a well-optimized sequence aligner, as it is [41]. Similarity Check labels a read that is similar to the target reference, i.e., a read that maps to the target reference, as on-target. With the efficient index structure of

minimap2, the performance of sequence alignment is almost independent of the length of the target reference genome. Hence, TargetCall is scalable to large target reference genomes of Gbp (i.e., Giga base pair) length.

The accuracy of the computed sequence alignments is not high enough to represent the true alignment between the read and the target reference since the reads computed by LightCall are noisy. However, the labeling accuracy of Similarity Check for determining the on-target/off-target reads is high enough to provide recall up to 99.45% in filtering reads. The minor inaccuracy of Similarity Check can be compensated with the high sequencing depth-of-coverage, the average number of reads that align to a genomic region, required for confident genome sequence analysis [53–56].

3. Results

3.1. Experimental Setup

Evaluated Use Cases. To show the applicability of TargetCall, we evaluate it on use cases with varying target reference sizes without compromising accuracy. We describe three use cases we use to evaluate TargetCall: (1) Covid Detection, (2) Sepsis Detection, and (3) Viral Detection. All three use cases contain a significant fraction of off-target reads that are eliminated using TargetCall to show the benefits of pre-basecalling filtering.

Covid Detection. The first use case aims to accept reads coming from a small target reference. We choose SARS-CoV-2 detection as a sample biological application where the goal is to detect the reads coming from a SARS-CoV-2 reference genome (~30 Kbp) from a sample taken from a human and filter out the human reads in the sample as performed by [28, 57].

Sepsis Detection. The second use case aims to filter reads when the target reference is large (~3 Gbp) to show TargetCall is applicable to use cases with large target references. We choose sepsis detection, as used in [29, 58, 59], as a sample biological application where the goal is to delete the human reads from a human sample. Since the bacteria that is causing the disease is unknown, we cannot search for reads coming from a specific bacterial target. Instead, we apply TargetCall to filter out reads similar to the target reference.

Viral Detection. The third use case aims to filter reads when the target reference contains a collection of reference genomes to show TargetCall can correctly filter reads when the sample and the target reference have a wide variety of species. This is to test the specificity of TargetCall in filtering reads when the on-target and off-target reads resemble each other more compared to previous use cases. We choose disease-causing viral read detection as a sample biological application where the goal is to detect the viral reads from a metagenomic sample of bacterial & viral reads, and the target reference contains a collection of viral reference genomes as demonstrated by [60].

Evaluation System. We use NVIDIA TITAN V to train and evaluate LightCall and Bonito baseline. For our evaluations, we increase the batch size maximally such that the entire GPU memory is occupied (Sections 3.2, 3.3, 3.4, 3.5). We

use NVIDIA A100 to evaluate TargetCall against prior work. We evaluate UNCALLED and Sigmap on a high-end server (AMD EPYC 7742 CPU with 1TB DDR4 DRAM). For our evaluations, we optimize the number of threads (128) for UNCALLED/Sigmap and the batch size (128) for TargetCall such that all tools have the minimum execution time (Section 3.6). We use the state-of-the-art read mapper, minimap2 [41] for the Similarity Check module of TargetCall with -a and -x map-ont flags. The -a flag is used to compute sequence alignments, and -x map-ont is used to configure minimap2 parameters for ONT data.

Training Setting. We use the publicly available ONT dataset [39] sequenced using MinION Flow Cell (R9.4.1) [61] for the training and validation. The neural network weights are updated using Adam [62] optimizer with a learning rate of $2e^{-3}$, a beta value of 0.999, a weight decay of 0.01, and an epsilon of $1e^{-8}$.

Baseline Techniques. We evaluate TargetCall’s runtime performance and accuracy as a pre-basecalling filter by integrating it as a pre-basecalling filter to Bonito [39], which is one of the official basecalling tools developed by ONT. In Section 3.6, we evaluate two state-of-the-art, non-machine learning-based adaptive sampling methods, UNCALLED [30] and Sigmap [19] repurposed as pre-basecalling filters to compare against TargetCall. We repurposed UNCALLED and Sigmap by using their classification methods to classify the reads as on-target/off-target before the basecalling step without any change in their implementations. We identify the ground truth on-target and off-target by basecalling the reads using a high accuracy Bonito model followed by performing minimap2. We do not evaluate TargetCall against other adaptive sampling methods such as SquiggleNet [31] that cannot be trivially used as pre-basecalling filters.

LightCall Configurations Evaluated. To determine the final architecture of TargetCall, we test 5 different LightCall configurations. Table 1 lists the LightCall configurations evaluated.

Table 1: Different LightCall configurations.

Model Name	Number of Parameters	Model Size (MB)
Bonito	9,739K	37.14
<i>LC_{Main}×2</i>	565K	2.16
<i>LC_{Main}</i>	292K	1.11
<i>LC_{Main}/2</i>	146K	0.55
<i>LC_{Main}/4</i>	52K	0.19
<i>LC_{Main}/8</i>	21K	0.07

Evaluated Datasets. We sampled 287,767 reads from prior work [20, 63, 64] and simulated 35,000 reads using DeepSimulator [65, 66] to evaluate TargetCall. We use four reference genomes to evaluate TargetCall on three different genome sequencing applications. The details of the exact read datasets

and reference genomes used to produce all our results can be found in Supplementary Section B.

Evaluation Metrics. We evaluate TargetCall using five different metrics: 1) filtering accuracy, 2) basecalling accuracy, 3) relative abundance (RA) estimation accuracy, 4) basecalling execution time, and 5) end-to-end execution time. For the basecalling execution time, we compare the wall-clock time spent on pre-basecalling filtering followed by basecalling of the reads that are accepted by the filter and conventional basecalling. For the end-to-end execution time, we compare the wall-clock time spent on the entire genome analysis pipeline of basecalling, read mapping, and variant calling with and without the use of pre-basecalling filtering. The index generation time of minimap2 is excluded from end-to-end execution time, as this is a one-time task per reference genome. When comparing TargetCall with UNCALLED and Sigmap in terms of the end-to-end execution time, we acknowledge that TargetCall benefits from hardware acceleration as it uses GPUs while the other tools use CPUs. Implementing UNCALLED and Sigmap on GPUs could further improve their speed performance.

We evaluate the filtering accuracy of TargetCall by computing its precision and recall. We define precision as the number of reads that TargetCall correctly labels as on-target, divided by the total number of reads that TargetCall labels as on-target. We define recall as the number of reads that TargetCall correctly labels as on-target, divided by the overall number of on-target reads in the dataset. The ground truth on-target reads are determined by the conventional pipeline of basecalling with Bonito and read mapping. An ideal pre-basecalling filter should have 100% recall to maintain accuracy in the downstream analyses and 100% precision to provide the maximum runtime performance improvement possible.

For basecalling accuracy, we use Bonito’s training and evaluation procedure to extract the median identity as basecalling accuracy [39]. For relative abundance (RA) accuracy, we calculate the difference in relative abundances of viral species after 1) pre-basecalling filtering and 2) conventional basecalling. We compute how much RA deviates from the true RAs after pre-basecalling filtering. RA is defined as the proportion of reads corresponding to a particular species relative to the total number of reads. The true RA refers to the RA obtained after conventional basecalling, which is considered the benchmark. Equation (1) provides the calculation of the deviation in RAs where TC_RA_i is the RA of species i after TargetCall; and B_RA_i is the RA of species i after conventional basecalling with Bonito.

$$RA\ Deviation = \sum_{\text{for each species } i} 100 * \frac{|TC_RA_i - B_RA_i|}{B_RA_i} \quad (1)$$

3.2. Filtering Accuracy

In Figures 3 and 4, we assess the precision and recall of TargetCall with different LightCall configurations for all use cases explained in Section 3.1, respectively. We make four key observations. First, TargetCall’s precision and recall are

between 73.59%-96.03% and 42.57%-99.45% for different configurations of LightCall on average across all three use cases tested, respectively. Second, the precision and recall of TargetCall increases as the model complexity of LightCall increases. Third, increasing the model complexity provides diminishing precision and recall improvements beyond the complexity of the LC_{Main} model. Fourth, models smaller than LC_{Main} are sufficient for use cases with small-to-medium target reference sizes, whereas more complex models are required for use cases with large target reference sizes. We conclude that LC_{Main*2} provides the highest precision and highest recall compared to other LightCall configurations.

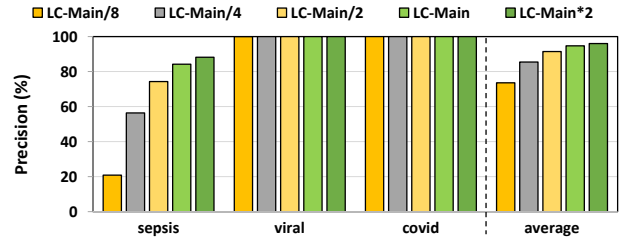

Figure 3: Precision for our evaluated use-cases while using TargetCall with different LightCall configurations.

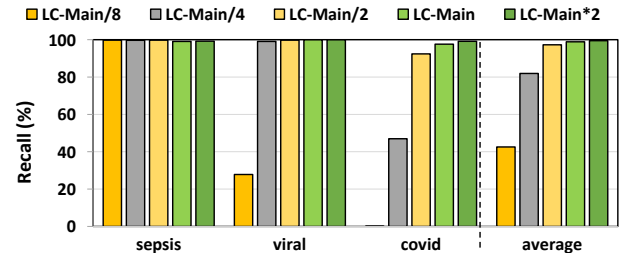

Figure 4: Recall for our evaluated use-cases while using TargetCall with different LightCall configurations.

3.3. Basecalling and Relative Abundance Accuracy

Table 2 shows the basecalling accuracy and the relative abundance (RA) deviation from the ground truth relative abundance estimation calculated for each LightCall configuration and using Bonito without pre-basecalling filtering. We evaluate the RA accuracy of TargetCall in the viral detection use case. We use Equation (1) to calculate the RA deviation as the RA accuracy metric.

Table 2: Basecalling Accuracy and Relative Abundance (RA) Deviation.

Model Name	Basecalling Accuracy	RA Deviation
Bonito	94.60%	0.00%
LC_{Main*2}	90.91%	0.03%
LC_{Main}	89.75%	0.08%
$LC_{Main/2}$	86.83%	0.23%
$LC_{Main/4}$	80.82%	0.91%
$LC_{Main/8}$	70.42%	72.19%

We make the following two key observations. First, the RA deviation results are negligible ($\leq 0.1\%$) for TargetCall config-

urations with recall higher than 98.5%. The only exception to this observation is our results when using the $LC_{Main/8}$ model. Although the basecalling accuracy drop is around 10% between $LC_{Main/8}$ and $LC_{Main/4}$, the deviation increases substantially because most of the reads cannot be mapped (see the low recall result in Figure 4), which affects the relative abundance estimations. Furthermore, as the read accuracy decreases, the read deviates from its original viral genome while it can still map to other viral genomes. We note that a similar issue is not observed in the precision results of the filtering use case (see Figure 3) as the goal of the filtering is to differentiate a viral genome from a bacterial genome (Section 3.2), rather than correctly mapping a read to its original viral genome compared to other viral genomes.

Second, TargetCall’s minor inaccuracy is not biased toward any specific portion of the target reference. Otherwise, the deviation of the relative abundances would be higher. Losing a small number of on-target reads randomly enables sequencing depth-of-coverage to compensate for the loss of reads. We conclude that TargetCall’s high recall enables accurate estimation for relative abundance calculations.

3.4. Basecalling Execution Time

Figure 5 provides the total execution time of Bonito and Bonito with TargetCall. We make three key observations. First, TargetCall improves runtime performance of Bonito by $2.13\times$ - $3.31\times$. Second, both precision and model complexity of LightCall affect the runtime performance of TargetCall, resulting in a non-linear relationship between model complexity and runtime performance. Precision affects the runtime performance of the filter as lower precision results in a higher number of falsely accepted reads to be basecalled using conventional basecallers. Model complexity affects the runtime performance of the filter as lower model complexity results in higher LightCall runtime performance with lower precision. Third, decreasing the model complexity increases the runtime performance up to the point where read filtering accuracy is no longer sufficient to filter out reads correctly. This results in a significant number of reads being falsely accepted by the filter, reducing the runtime performance of TargetCall significantly. We conclude that TargetCall significantly improves the execution time of basecalling.

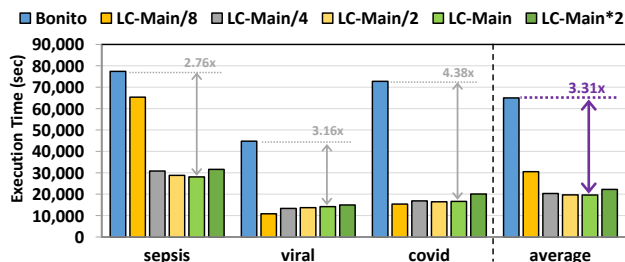

Figure 5: Basecalling execution time for our evaluated use-cases while using TargetCall with different LightCall configurations.

3.5. End-to-End Execution Time

Figure 6 provides the total time spent on the genome analysis pipeline of basecalling, read mapping, and variant calling with

and without the use of pre-basecalling filtering. We used minimap2 [41] and DeepVariant [67] for read mapping and variant calling, respectively. We make three key observations. First, TargetCall improves the runtime performance of the entire genome sequence analysis pipeline by $2.03\times$ - $3.00\times$. Second, the choice of the variant callers affects the end-to-end runtime performance improvement of TargetCall. Since we used a highly accurate neural network-based variant caller, the execution time of variant calling dominated read mapping (not shown). This reduces the end-to-end runtime performance benefits of TargetCall, as the variant calling is performed only on the alignments of on-target reads (i.e., on the reduced dataset) determined during a relatively lightweight read mapping step. Third, similar to basecalling execution time, multiple factors affect the runtime performance of TargetCall with different LightCall configurations, which results in a non-linear relationship between the runtime performance and model complexity of LightCall. We conclude that TargetCall significantly improves the end-to-end execution time of the genome sequence analysis pipeline by providing up to $3.00\times$ speedup.

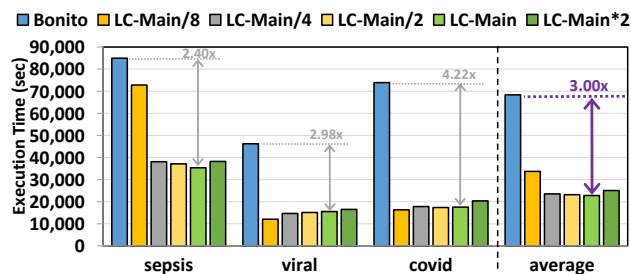

Figure 6: End-to-end execution time for our evaluated use-cases while using TargetCall with different LightCall configurations.

3.6. Comparison to Prior Work

We compare TargetCall with the best LightCall configuration (LC_{Main}) with two state-of-the-art adaptive sampling methods UNCALLED and Sigmap. Supplementary Section C.1 explains the best model selection procedure. We used two different reference genomes for the sepsis use case, but UNCALLED failed to generate the index structure for our default human reference genome (hg38) in a high-end server with 1TB of main memory. We evaluate only these two methods, as they can readily be repurposed as pre-basecalling filters. The other methods are either not open-sourced fully [36] or cannot be repurposed as pre-basecalling filters as is [31].

We compare the recall of TargetCall with that of Sigmap and UNCALLED. The ground truth on-target reads are determined by the conventional pipeline. In our analysis, we observe that UNCALLED could not be executed on the hg38 reference genome. To ensure a fair assessment, we excluded hg38 from the performance evaluation of UNCALLED. Figure 7 shows the recall of Sigmap, UNCALLED and TargetCall. We make two key observations. First, TargetCall provides significantly higher recall, $+3.09\%$ / $+23.15\%$, than UNCALLED/Sigmap on average. Second, TargetCall provides consistently the best recall than both methods across all use cases except covid detection, for which adaptive sampling methods are optimized.

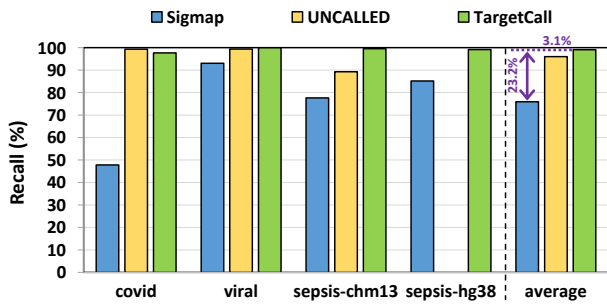

Figure 7: Recall of Sigmap, UNCALLED and TargetCall

We compare the precision of TargetCall with that of Sigmap and UNCALLED. Figure 8 shows the precision of Sigmap, UNCALLED, and TargetCall. We make two key observations. First, TargetCall provides significantly higher precision, +58.48%/+62.31%, than UNCALLED/Sigmap on average. Second, TargetCall maintains high precision as the target reference size increases, unlike prior methods. We conclude that TargetCall significantly achieves higher recall and precision in all use cases independent of the target reference size.

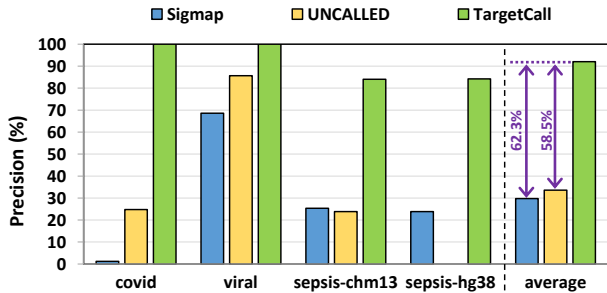

Figure 8: Precision of Sigmap, UNCALLED and TargetCall

We compare the end-to-end execution time of TargetCall with that of Sigmap and UNCALLED, the results are shown in Figure 9. We make two key observations. First, we observe that TargetCall outperforms Sigmap by 9.72 \times and UNCALLED by 1.46 \times . TargetCall’s higher runtime performance benefits come from its higher precision in filtering out off-target reads. Second, TargetCall’s runtime performance improvements become more significant as the target reference size increases.

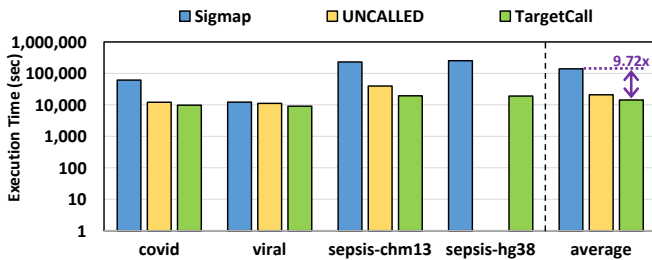

Figure 9: End-to-end execution time of Sigmap, UNCALLED, and TargetCall

We evaluate the throughput of TargetCall and compare it with that of Sigmap and UNCALLED. We evaluate throughput as the base pairs tools process per second. We use `uncalled pafstats` for evaluating the throughput of UNCALLED and Sigmap and bonito output for evaluating the throughput of

LightCall. We only evaluate the throughput of LightCall component of TargetCall as it has a significantly lower throughput than Similarity Check and is the bottleneck of TargetCall. Figure 10 shows the throughput of Sigmap, UNCALLED, and LightCall. We make three key observations. First, we observe that LightCall improves the throughput of UNCALLED/Sigmap by 1124.03 \times /42.08 \times . Second, we observe that throughput of LightCall is consistently high unlike other tools (e.g., Sigmap) whose throughput reduce with target reference length. Third, LightCall’s high throughput does not reflect its execution time. The reason for this discrepancy between LightCall’s throughput and execution time is likely because, unlike Sigmap and UNCALLED, TargetCall processes the entire read before labeling it as on-target/off-target. We conclude that TargetCall’s benefits can be amplified by optimizing it further via integrating early filtering of reads that will match/not match to the target reference without processing the entire read.

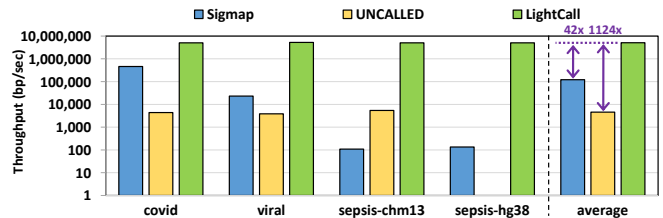

Figure 10: Throughput of Sigmap, UNCALLED, and LightCall

Overall, we conclude that TargetCall 1) significantly improves the end-to-end execution time of basecalling compared to prior methods by filtering out higher fraction of the off-target reads with its higher precision, 2) improves the recall of prior methods in filtering reads, 3) has a consistently higher throughput than all prior works, and 4) can be accurately applied to target reference lengths that prior methods are unable to be applied accurately while requiring much less (on average 5.76 \times , see Supplementary Section C.2) peak memory compared to prior works. We believe TargetCall can be used as a lightweight real-time sequence classification and filtering tool due to its high throughput if it is optimized to work with the first few chunks of a read.

3.7. TargetCall Execution Time Breakdown

We analyzed the execution time breakdown of a pipeline that includes TargetCall as the pre-basecalling filter in Figure 11. We make four key observations. First, LightCall is the bottleneck of the new basecalling pipeline that includes pre-basecalling filtering by consuming 61.44% of the total execution time on average. Second, basecalling is still an important computational overhead for the pipeline by consuming 35.04% of the total execution time on average. Third, the computational overhead of basecalling increases with the increased ratio of on-target reads in the dataset, such as in the viral use case. Fourth, the Similarity Check component consumes less than 3.4% of the total execution time on average and does not bottleneck the pipeline that includes TargetCall as the pre-basecalling filter even when used in the expensive alignment mode.

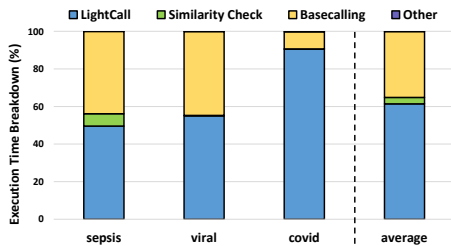

Figure 11: Execution Time Breakdown of TargetCall

4. Discussion

We propose TargetCall, a pre-basecalling filtering mechanism for eliminating the wasted computation in basecalling. TargetCall performs light-weight basecalling to compute noisy reads using LightCall, and labels these noisy reads as on-target/off-target using Similarity Check. TargetCall eliminates the wasted computation in basecalling by performing basecalling only on the on-target reads. We focus on convolution-based networks for TargetCall architecture for two reasons: (a) matrix multiplication, the core operation in these networks, is highly suitable for hardware acceleration, facilitating improved performance, and (b) the training and inference of RNN and LSTM models involve sequential computation tasks, which pose significant challenges for acceleration on modern hardware such as GPUs and field-programmable gate arrays (FPGAs) [26]. We evaluate TargetCall for three different genome sequence analysis use cases of pre-basecalling filtering with varying requirements: covid detection, sepsis detection, and viral detection. We show that TargetCall reduces the execution time of basecalling by filtering out the majority of the off-target reads and is more applicable compared to the state-of-the-art adaptive sampling methods. We hope that TargetCall inspires future work in pre-basecalling filtering and real-time sequence classification that accelerate other bioinformatics workloads and emerging applications with its high throughput and recall. We explain future work and optimizations that can build upon TargetCall in Supplementary Section D.

Acknowledgments

SAFARI Research Group acknowledges the generous gift funding provided by our industrial partners (especially by Google, Huawei, Intel, Microsoft, VMware), which has been instrumental in enabling the 15+ year-long research SAFARI Research Group has been conducting on accelerating genome analysis. This work is also partially supported by the Semiconductor Research Corporation (SRC), the European Union’s Horizon programme for research and innovation [101047160 - BioPIM] and the Swiss National Science Foundation (SNSF) [200021_213084].

References

- [1] C. Alkan *et al.*, “Personalized Copy Number and Segmental Duplication Maps Using Next-Generation Sequencing,” *Nat Genet*, 2009.
- [2] E. A. Ashley, “Towards Precision Medicine,” *Nature Reviews Genetics*, 2016.
- [3] L. Chin *et al.*, “Cancer Genomics: from Discovery Science to Personalized Medicine,” *Nat Med*, 2011.
- [4] H. Ellegren, “Genome Sequencing and Population Genomics in Non-Model Organisms,” *Trends in Ecology & Evolution*, 2014.
- [5] M. J. Alvarez-Cubero *et al.*, “Next Generation Sequencing: an Application in Forensic Sciences?” *Ann Hum Biol*, 2017.
- [6] Y. Wang *et al.*, “Nanopore Sequencing Technology, Bioinformatics and Applications,” *Nature Biotechnology*, 2021.
- [7] M. Alser *et al.*, “Technology Dictates Algorithms: Recent Developments in Read Alignment,” *Genome Biology*, 2021.
- [8] T. J. Treangen and S. L. Salzberg, “Repetitive DNA and Next-Generation Sequencing: Computational Challenges and Solutions,” *Nat Rev Genet*, 2011.
- [9] C. Firtina and C. Alkan, “On Genomic Repeats and Reproducibility,” *Bioinformatics*, 2016.
- [10] C. Alkan *et al.*, “Limitations of Next-Generation Genome Sequence Assembly,” *Nat Methods*, 2010.
- [11] H. Lu *et al.*, “Oxford Nanopore MinION Sequencing and Genome Assembly,” *Genomics Proteomics Bioinformatics*, 2016.
- [12] A. Magi *et al.*, “Nanopore Sequencing Data Analysis: State of the Art, Applications and Challenges,” *Brief Bioinform*, 2018.
- [13] C. Firtina *et al.*, “BLEND: a fast, memory-efficient and accurate mechanism to find fuzzy seed matches in genome analysis,” *NAR Genomics and Bioinformatics*, 2023.
- [14] D. Branton *et al.*, “The potential and challenges of nanopore sequencing,” *Nature biotechnology*, 2008.
- [15] L. Gong *et al.*, “Ultra-Long Read Sequencing for Whole Genomic DNA Analysis,” *JoVE*, 2019.
- [16] M. Jain *et al.*, “Nanopore Sequencing and Assembly of a Human Genome with Ultra-Long Reads,” *Nature Biotechnology*, 2018.
- [17] G. A. Logsdon *et al.*, “Long-Read Human Genome Sequencing and its Applications,” *Nature Reviews Genetics*, 2020.
- [18] S. L. Amarasinghe *et al.*, “Opportunities and Challenges in Long-Read Sequencing Data Analysis,” *Genome biology*, 2020.
- [19] H. Zhang *et al.*, “Real-Time Mapping of Nanopore Raw Signals,” *Bioinformatics*, 2021.
- [20] R. R. Wick *et al.*, “Performance of Neural Network Basecalling Tools for Oxford Nanopore Sequencing,” *Genome biology*, 2019.
- [21] M. Pagès-Gallego and J. de Ridder, “Comprehensive benchmark and architectural analysis of deep learning models for nanopore sequencing basecalling,” *Genome Biol.*, 2023.
- [22] M. Alser *et al.*, “From Molecules to Genomic Variations: Accelerating Genome Analysis via Intelligent Algorithms and Architectures,” *Computational and Structural Biotechnology Journal*, 2022.
- [23] Wan, Yuk Kei and Hendra, Christopher and Pratanwanich, Ploy N and Göke, Jonathan, “Beyond Sequencing: Machine Learning Algorithms Extract Biology Hidden in Nanopore Signal Data,” *Trends Genet*, 2021.
- [24] D. Senol Cali *et al.*, “Nanopore Sequencing Technology and Tools for Genome Assembly: Computational Analysis of the Current State, Bottlenecks and Future Directions,” *Brief Bioinform*, 2019.
- [25] F. J. Rang *et al.*, “From Squiggle to Basepair: Computational Approaches for Improving Nanopore Sequencing Read Accuracy,” *Genome Biology*, 2018.
- [26] G. Singh *et al.*, “RUBICON: a framework for designing efficient deep learning-based genomic basecallers,” *Genome Biology*, 2024.
- [27] R. Bowden *et al.*, “Sequencing of Human Genomes with Nanopore Technology,” *Nature Communications*, 2019.
- [28] T. Dunn *et al.*, “SquiggleFilter: An accelerator for portable virus detection,” in *MICRO*, 2021.
- [29] S. Grumaz *et al.*, “Next-Generation Sequencing Diagnostics of Bacteremia in Septic Patients,” *Genome Medicine*, 2016.
- [30] S. Kovaka *et al.*, “Targeted Nanopore Sequencing by Real-Time Mapping of Raw Electrical Signal with UNCALLED,” *Nature Biotechnology*, 2021.
- [31] Y. Bao *et al.*, “SquiggleNet: Real-Time, Direct Classification of Nanopore Signals,” *Genome Biology*, 2021.

- [32] C. Firtina *et al.*, “RawHash: enabling fast and accurate real-time analysis of raw nanopore signals for large genomes,” *Bioinformatics*, 2023.
- [33] J. Lindegger *et al.*, “RawAlign: Accurate, Fast, and Scalable Raw Nanopore Signal Mapping via Combining Seeding and Alignment,” *arXiv*, 2023.
- [34] C. Firtina *et al.*, “RawHash2: Mapping Raw Nanopore Signals Using Hash-Based Seeding and Adaptive Quantization,” *Bioinformatics*, 2024.
- [35] M. Loose *et al.*, “Real-Time Selective Sequencing Using Nanopore Technology,” *Nature Methods*, 2016.
- [36] A. Payne *et al.*, “Readfish Enables Targeted Nanopore Aequencing of Gigabase-Sized Genomes,” *Nat Biotechnol*, 2020.
- [37] B. Noordijk *et al.*, “baseLess: lightweight detection of sequences in raw MinION data,” *Bioinformatics Advances*, 2023.
- [38] R. Munro *et al.*, “Icarust, a real-time simulator for Oxford Nanopore adaptive sampling,” *Bioinformatics*, 2024.
- [39] Bonito, “Bonito, <https://github.com/nanoporetech/bonito>,” 2022.
- [40] D. Frei *et al.*, “Ultralong Oxford Nanopore Reads Enable the Development of a Reference-Grade Perennial Ryegrass Genome Assembly,” *Genome Biology and Evolution*, 2021.
- [41] H. Li, “Minimap2: Pairwise Alignment for Nucleotide Sequences,” *Bioinformatics*, 2018.
- [42] S. Ioffe and C. Szegedy, “Batch Normalization: Accelerating Deep Network Training by Reducing Internal Covariate Shift,” in *ICML*, 2015.
- [43] A. F. Agarap, “Deep Learning Using Rectified Linear Units (ReLU),” *arXiv*, 2018.
- [44] A. Graves *et al.*, “Connectionist Temporal Classification: Labelling Unsegmented Sequence Data with Recurrent Neural Networks,” in *ICML*, 2006.
- [45] D. Neumann *et al.*, “RODAN: A Fully Convolutional Architecture for Basecalling Nanopore RNA Sequencing Data,” *BMC bioinformatics*, 2022.
- [46] H. Konishi *et al.*, “Halcyon: an Accurate Basecaller Exploiting an Encoder-Decoder Model with Monotonic Attention,” *Bioinformatics*, 2021.
- [47] Z. Xu *et al.*, “Fast-bonito: A Faster Deep Learning Based Basecaller for Nanopore Sequencing,” *Artificial Intelligence in the Life Sciences*, 2021.
- [48] Q. Lou *et al.*, “Helix: Algorithm/Architecture Co-design for Accelerating Nanopore Genome Base-calling,” in *Proceedings of the ACM International Conference on Parallel Architectures and Compilation Techniques*, 2020.
- [49] P. Perešini *et al.*, “Nanopore Base Calling on the Edge,” *Bioinformatics*, 2021.
- [50] Z. Zhang *et al.*, “An Automated Framework for Efficiently Designing Deep Convolutional Neural Networks in Genomics,” *Nature Machine Intelligence*, 2021.
- [51] A. V. and A. G. Kiran, “Synthnet: A skip connected depthwise separable neural network for novel view synthesis of solid objects,” *Results in Engineering*, 2022.
- [52] T. Shahroodi *et al.*, “Swordfish: A framework for evaluating deep neural network-based basecalling using computation-in-memory with non-ideal memristors,” in *Proceedings of the 56th Annual IEEE/ACM International Symposium on Microarchitecture*, 2023, pp. 1437–1452.
- [53] M. A. Quail *et al.*, “A Tale of Three Next Generation Sequencing Platforms: Comparison of Ion Torrent, Pacific Biosciences and Illumina MiSeq Sequencers,” *BMC Genomics*, 2012.
- [54] S. E. Levy and R. M. Myers, “Advancements in Next-Generation Sequencing,” *Annu Rev Genomics Hum Genet*, 2016.
- [55] T. Hu *et al.*, “Next-Generation Sequencing Technologies: An overview,” *Hum Immunol*, 2021.
- [56] D. Sims *et al.*, “Sequencing Depth and Coverage: Key Considerations in Genomic Analyses,” *Nature Reviews Genetics*, 2014.
- [57] J. L. Geoghegan *et al.*, “Use of Genomics to Track Coronavirus Disease Outbreaks, New Zealand,” *Emerg Infect Dis*, 2021.
- [58] I. H. Celik *et al.*, “Diagnosis of Neonatal Sepsis: the Past, Present and Future,” *Pediatric Research*, 2022.
- [59] K. Sands *et al.*, “Characterization of Antimicrobial-Resistant Gram-Negative Bacteria That Cause Neonatal Sepsis in Seven Low- and Middle-Income Countries,” *Nature Microbiology*, 2021.
- [60] J. L. Mokili *et al.*, “Metagenomics and Future Perspectives in Virus Discovery,” *Current Opinion in Virology*, 2012.
- [61] ONT, “MinION Flow Cell (R9.4.1), <https://store.nanoporetech.com/flow-cell-r9-4-1.html>,” 2022.
- [62] D. P. Kingma and J. Ba, “Adam: A Method for Stochastic Optimization,” *arXiv*, 2014.
- [63] J. M. Zook *et al.*, “An Open Resource for Accurately Benchmarking Small Variant and Reference Calls,” *Nat Biotechnol*, 2019.
- [64] “Brazil-UK Centre for Arbovirus Discovery, Diagnosis, Genomics and Epidemiology, <https://www.caddecentre.org>,” 2020.
- [65] Y. Li *et al.*, “DeepSimulator: A Deep Simulator for Nanopore Sequencing,” *Bioinformatics*, 2018.
- [66] Y. Li *et al.*, “DeepSimulator1. 5: A More Powerful, Quicker and Lighter Simulator for Nanopore Sequencing,” *Bioinformatics*, 2020.
- [67] R. Poplin *et al.*, “A Universal SNP and Small-Indel Variant Caller Using Deep Neural Networks,” *Nature Biotechnology*, 2018.

Supplementary Material for TargetCall: Eliminating the Wasted Computation in Basecalling via Pre-Basecalling Filtering

A. Adaptive Sampling Background

Targeted sequencing is a method to selectively sequence reads from the reference genome of interest (i.e., target reference) during sequencing time [1–3]. ONT devices have the potential to enable computational targeted sequencing without the need for library preparation with a feature, known as *Read Until* [1, 4]. ONT sequencers that support Read Until can selectively remove a read from the nanopore while the read is being sequenced, called as the adaptive sampling. Read Until can be used to remove off-target reads during sequencing, eliminating wasted computation on off-target reads in basecalling. All adaptive sampling approaches work by labeling a read as on-target or off-target and stopping the sequencing of off-target reads immediately after labeling using Read Until. We discuss three groups of works that perform Read Until, classified based on their methodology to label the read. The first group converts the target reference into a reference raw signal and performs raw signal-level alignment [4–6]. The second group generates noisy sequence representations of the raw signal to compare them with the target reference [1, 3]. The third group of works utilize neural network classifiers to label the sequences [7, 8]. To our knowledge, none of these works can be fully repurposed as widely-applicable pre-basecalling filters to eliminate the wasted computation in basecalling for a wide range of genome applications as their accuracy drops significantly with the increasing target reference size.

The first group of work compares the raw electrical signals to a target reference without basecalling the signals in two steps [4]. The first step converts the bases of the reference genome into their *synthetic* raw signal representation. The second step identifies similarities between the raw read signal and the synthetic reference signal. Prior work [4] used the Dynamic Time Warping (DTW) algorithm that measures the similarity of a pair of signals to find the similarity. If the read is not similar to target reference, it is labeled as off-target. Unlike TargetCall, this method is not applicable to large target references of millions of base pairs (bp) long due the quadratic time complexity of DTW with respect to the length of the sequences. To address the computational bottleneck of DTW, Sigmap [5] propose to generate an index for the synthetic reference signal. Sigmap queries the generated index as the reads are being sequenced to find the potential similarity positions between the read and the reference signal, avoiding the DTW calculation. These positions refer to matches of short subsequences of the read and the reference signal, and the final labelling is determined based on chaining these match locations. The use of index structure enables Sigmap to be applicable to target references of length up to ~ 100 Mbp, however, Sigmap is still significantly less applicable compared to TargetCall. Recently, SquiggleFilter proposed to design an accelerator to make DTW calculation faster [6] but it was unable to make DTW scalable for large target references.

The second group of works is based on converting the raw signal into a set of bases and comparing these bases to the reference to label the raw signal [1, 3]. Readfish uses a real-time basecalling method to basecall the read as it is being sequenced and perform read mapping on the basecalled portion of the raw signal [3]. Since basecallers are optimized to work on complete reads, this method results in suboptimal base sequences hence may incorrectly label the reads [5]. To mitigate these drawbacks, UNCALLED uses an index of the reference genome to probabilistically convert the raw signal into a set of short nucleotide subsequences called seeds and cluster them [1]. The read is classified as on-target read if there is a location in the target reference that has significantly more seeds mapping to that region than the others [1]. UNCALLED is also designed to work *only* on small reference genomes with the goal of performing adaptive sampling [1, 5].

The third group of works uses machine learning to label the raw signals in a sample without performing basecalling and costly analyses in the base space [7, 8]. SquiggleNet [7] can identify a certain class of species with a high accuracy where the class membership is determined based on the target reference. However, this approach requires training the machine learning model for each target reference, which cannot be practically applied to classify any type of species due to the high computational costs of training. Therefore, unlike TargetCall, SquiggleNet cannot be used as a widely-applicable pre-basecalling filter. BaseLess [8] utilizes an array of small neural networks to detect a small subsequences from raw signals and match these subsequences with a target reference that share the same subsequence. This design choice provides a flexible solution that can define the set of pre-trained neural network models of subsequences to identify a certain target reference instead of retraining the neural network model for each species. Unfortunately, none of these works can avoid the cost of training the models multiple times (i.e., for each subsequence or species) to identify the target references in raw signals.

Limitations of Adaptive Sampling Approaches. Even though these approaches can discard off-target reads from the genome analysis pipeline hence eliminating the wasted computation in basecalling, all have at least one of the following three key limitations, preventing them to be used as *widely applicable* pre-basecalling filters. First, some [1, 3, 5] have low (77.5%-90.40%) recall which affects the accuracy of downstream analysis. These tools falsely reject a significant portion ($\sim 10\%$ - $\sim 23\%$) of the on-target reads. Second, some [1, 4–6] are not scalable to the long target references. This happens due to one of the following reasons: 1) use of signal-signal alignment algorithms whose complexity increases linearly with the target reference length [4, 6], 2) use of complex data structures to represent target reference in signal domain that are not scalable to long target reference lengths [5], and 3) use of probabilistic algorithms that scale poorly with the increasing target reference length [1]. These tools cannot be used for applications that require long target references, such as human reference. Third, some require neural network classifiers to be re-trained for each different application and target reference [7]. The re-training is required since the classifier is trained depending on the specific set of on-target and off-target reads. These approaches cannot be used in a wide range of pre-basecalling filtering applications without significant overheads.

B. Evaluated Datasets

Evaluated Read Datasets. We use four real and one simulated dataset to evaluate TargetCall. Table S1 provides details on the evaluated datasets. Datasets D1 & D2, D1 & D4 and D3 & D5 are used for covid detection, sepsis detection and viral detection use cases respectively. For real datasets we randomly sample the datasets provided by prior research to keep a tractable experiment time. We use DeepSimulator to generate the simulated reads [9, 10]. We simulate the dataset D5 due to unavailability of open access raw signal files for viral reads.

Evaluated Reference Genomes. We use four reference genomes to evaluate TargetCall on three applications. Table S2 lists the details of these reference genomes.

For testing viral detection use case, we used 10 viral reference genomes from NCBI RefSeq (with IDs NC_003977.2, AC_000007.1, NC_009334.1, NC_001526.4, NC_010277.2, NC_001731.1, NC_063383.1, NC_055231.1, NC_045512.2,

Table S1: Evaluated read datasets.

List of Read Datasets	Dataset Type	Number of Reads	Source	DOI Accession
(D1) Human	Real	196,000	[11]	10.5281/zenodo.7334648
(D2) SARS-CoV-2	Real	4,000	[12]	10.5281/zenodo.7335539
(D3) Bacterial Mixture (n=7)	Real	72,567	[13]	10.5281/zenodo.7335525
(D4) Bacterial Mixture (n=9)	Real	15,200	[13]	10.5281/zenodo.7335517
(D5) Viral Mixture (n=7)	Simulated	35,000	[9, 10]	10.5281/zenodo.7334592

Table S2: List of Reference Genomes Used for each Use Case.

Reference Genome	Reference Length (bp)	Use Case	Datasets Compared	% of On-Target Reads
Human (GRCh38)	3,088,286,401	Sepsis Detection	D1 & D4	17.64%
Human (Chm13)	3,117,292,070	Sepsis Detection	D1 & D4	17.64%
SARS-CoV-2 (NC_045512.2)	29,903	Covid Detection	D1 & D2	2%
Viral Combined (n=10)	861,552	Viral Detection	D3 & D5	32.51%

NC_014361.1); and combined them to use as the target reference [14]. Only 7 of these 10 reference genomes are used for simulating reads of dataset D5².

C. Results

C.1. Best Model Selection

We evaluate the performance-recall trade-off of TargetCall to determine the best LightCall architecture for TargetCall. Figure S1 aggregates the recall and performance improvement (i.e., basecalling speedup) of all LightCall configurations evaluated (except $LC_{Main/8}$). We make the following three key observations. First, LC_{Main} provides the highest ($3.31\times$) speedup in basecalling. Second, LC_{Main*2} provides the highest (99.45%) recall in basecalling. Third, LC_{Main} provides significantly higher (13.36%) speedup than LC_{Main*2} with minimal (0.57%) reductions in recall. Therefore, we select LC_{Main} as the LightCall component of TargetCall. We conclude that TargetCall by using LC_{Main} improves the performance of basecalling by $3.31\times$ by precisely filtering 94.71% of the on-target reads while maintaining high (98.88%) recall in filtering.

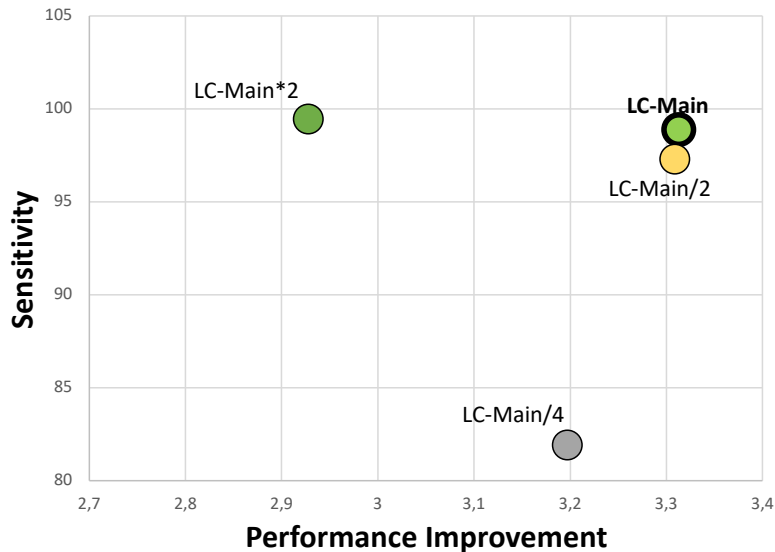

Figure S1: Overall recall and performance (basecalling speedup) improvement for TargetCall with different LightCall configurations

C.2. Peak Memory

We evaluate the peak memory of TargetCall and compare it against with that of Sigmap and UNCALLED. We subsample 4000 human reads from the dataset to evaluate the peak memory usage of these tools since adding more reads to the experiment does

²Reference Genomes tested can be accessed with DOI 10.5281/zenodo.7335545

not change the results. We use the linux time command for evaluating the peak memory usage of UNCALLED, Sigmap and Similarity Check. We use the nvidia-smi command to evaluate the peak memory usage of LightCall. The peak memory usage of TargetCall is equal to the maximum peak memory usage of its components: LightCall and Similarity Check. Table S3 demonstrates the peak memory usage of Sigmap, UNCALLED, TargetCall and its components. We make four observations. First, LightCall’s peak memory usage is the same across different use cases, since the basecalling algorithm is independent of the target reference. Second, for use cases with small target reference, the peak memory usage of TargetCall is determined by the peak memory usage of LightCall, whereas its peak memory usage is determined by the peak memory usage of Similarity Check for large target references. Third, TargetCall’s peak memory usage is always less than Sigmap’s peak memory usage, and it becomes more efficient in terms of peak memory compared to Sigmap as the target reference length increases. Fourth, both UNCALLED’s and TargetCall’s peak memory usage are low for all use cases ($\leq 20\text{GB}$). We conclude that TargetCall is the only tool that both has low peak memory usage for all target reference lengths and is applicable to all target references.

Table S3: Peak Memory (MB).

Use Case	UNCALLED	Sigmap	LightCall	Similarity Check	TargetCall
Covid	1329.1	3455.0	2005.0	139.6	2005.0
Viral	1385.4	3546.8	2005.0	274.9	2005.0
Sepsis_chm13	8126.4	234504.3	2005.0	16593.9	16593.9
Sepsis_hg38	-	225746.5	2005.0	16974.7	16974.7

D. Future Work and Optimizations

The performance and accuracy of TargetCall can be further optimized in three main directions. The first direction is to optimize the LightCall component to achieve higher basecalling accuracy with significant performance improvements. Currently, the LightCall model is designed based on pruning a state-of-the-art basecaller, Bonito’s model. The specific model configurations evaluated are chosen based on the insight we developed from prior work. We believe the accuracy and performance of LightCall can be optimized even better with a more methodological approach in specifying the precise configurations, such as neural architecture search [15].

The second direction is to optimize the Similarity Check component to achieve higher recall, precision and/or performance. Currently, the state-of-the-art read mapper, minimap2, is used as the Similarity Check component of TargetCall. TargetCall’s recall can be improved by manually tuning the minimap2 parameters, and its performance can be improved by using it with large window size or without the expensive alignment mode. We left this analysis as part of future work for the following three reasons. First, although the recall and precision of TargetCall can be improved by changing the minimap2 parameters, the TargetCall’s precision and recall are already very high (92.1%/99.1% averaged over 4 use cases in Section 3.6). Second, as we show in section 3.7 of the paper that minimap2 consumes less than 3.4% of the execution time of a basecalling pipeline that includes TargetCall as the pre-basecalling filter. Therefore, the performance of TargetCall will not be significantly improved by optimizing the minimap2 parameters. Third, changing the minimap2 parameters will change the reads labeled as on-target, so the reads that needed to be basecalled using state-of-the-art basecallers to evaluate the execution time of TargetCall in addition to its precision/recall. This will increase the experimental time extensively. Therefore, we left this optimization as part of our future work considering the already high recall, precision and performance of TargetCall.

The third direction is to replace the Similarity Check component with a less expensive filter. Read mapping problem aims to match a read to its position in a reference genome. However, the goal of Similarity Check, predicting if a read is coming from a target reference, is simpler than read mapping. Therefore, TargetCall can be optimized by using k-mer or sketch based methods as its Similarity Check component such as KrakenUnique [16] and Mash [17]. Similar to the second direction, we left this as part of future work, as TargetCall is not bottlenecked by its Similarity Check component.

We hope that TargetCall inspires future work in pre-basecalling filtering and raw signal classification that accelerate other bioinformatics workloads and emerging applications with its high throughput and recall. One such application is adaptive sampling where the raw signals are classified in real-time while the reads are being sequenced. We show in Section 3.6 of the paper that TargetCall’s throughput is on par with sequencing throughput of ONT devices, and much higher (up to 1124x) than the adaptive sampling approaches we compared against. Further analysis is required to understand to what extent TargetCall can be used for adaptive sampling such as evaluating the recall and precision of TargetCall when only the initial portions of the raw signals are available for classification. We believe the optimizations explained above can be useful for future work that applies TargetCall to adaptive sampling problem.

Supplementary References

- [1] S. Kovaka *et al.*, “Targeted nanopore sequencing by real-time mapping of raw electrical signal with UNCALLED,” *Nature Biotechnology*, vol. 39, no. 4, pp. 431–441, Apr. 2021.
- [2] T. Gilpatrick *et al.*, “Targeted nanopore sequencing with Cas9-guided adapter ligation,” *Nature Biotechnology*, vol. 38, no. 4, pp. 433–438, Apr. 2020.
- [3] A. Payne *et al.*, “Readfish enables targeted nanopore sequencing of gigabase-sized genomes,” *Nature Biotechnology*, vol. 39, no. 4, pp. 442–450, Apr. 2021.
- [4] M. Loose *et al.*, “Real-time selective sequencing using nanopore technology,” *Nature Methods*, vol. 13, no. 9, pp. 751–754, Sep. 2016.
- [5] H. Zhang *et al.*, “Real-time mapping of nanopore raw signals,” *Bioinformatics*, vol. 37, no. Supplement_1, pp. i477–i483, Jul. 2021.
- [6] T. Dunn *et al.*, “SquiggleFilter: An accelerator for portable virus detection,” in *MICRO*, 2021.
- [7] Y. Bao *et al.*, “SquiggleNet: real-time, direct classification of nanopore signals,” *Genome Biology*, vol. 22, no. 1, p. 298, Oct. 2021.
- [8] B. Noordijk *et al.*, “baseLess: lightweight detection of sequences in raw MinION data,” *Bioinformatics Advances*, 2023.
- [9] Y. Li *et al.*, “DeepSimulator: A Deep Simulator for Nanopore Sequencing,” *Bioinformatics*, 2018.
- [10] Y. Li *et al.*, “DeepSimulator1. 5: A More Powerful, Quicker and Lighter Simulator for Nanopore Sequencing,” *Bioinformatics*, 2020.

- [11] J. M. Zook *et al.*, “An Open Resource for Accurately Benchmarking Small Variant and Reference Calls,” *Nature Biotechnology*, 2019.
- [12] “Brazil-UK Centre for Arbovirus Discovery, Diagnosis, Genomics and Epidemiology, <https://www.caddecentre.org/>,” 2020.
- [13] R. R. Wick *et al.*, “Performance of Neural Network Basecalling Tools for Oxford Nanopore Sequencing,” *Genome biology*, 2019.
- [14] “RefSeq: NCBI Reference Sequence Database, <https://www.ncbi.nlm.nih.gov/refseq/>.”
- [15] B. Zoph and Q. V. Le, “Neural Architecture Search with Reinforcement Learning,” *arXiv*, 2017.
- [16] F. P. Breitwieser *et al.*, “KrakenUniq: confident and fast metagenomics classification using unique k-mer counts,” *Genome Biology*, vol. 19, no. 1, p. 198, Nov. 2018.
- [17] B. D. Ondov *et al.*, “Mash: fast genome and metagenome distance estimation using MinHash,” *Genome Biology*, vol. 17, no. 1, p. 132, Jun. 2016.