

COLORED BOSONIC MODELS AND MATRIX COEFFICIENTS

DANIEL BUMP AND SLAVA NAPRIENKO

ABSTRACT. We develop the theory of colored bosonic models (initiated by Borodin and Wheeler). We will show how a family of such models can be used to represent the values of Iwahori vectors in the “spherical model” of representations of $\mathrm{GL}_r(F)$, where F is a nonarchimedean local field. Among our results are a *monochrome factorization*, which is the realization of the Boltzmann weights by fusion of simpler weights, a *local lifting* property relating the colored models with uncolored models, and an action of the Iwahori Hecke algebra on the partition functions of a particular family of models by Demazure-Lusztig operators. As an application of the local lifting property we reprove a theorem of Korff evaluating the partition functions of the uncolored models in terms of Hall-Littlewood polynomials. Our results are very closely parallel to the theory of fermionic models representing Iwahori Whittaker functions developed by Brubaker, Buciumas, Bump and Gustafsson, with many striking relationships between the two theories, confirming the philosophy that the spherical and Whittaker models of principal series representations are dual.

CONTENTS

1. Introduction	1
2. Demazure operators	5
3. The uncolored bosonic models	10
4. The colored bosonic models	15
5. The local lifting property	21
6. Spherical models of p -adic representations	24
References	29

1. INTRODUCTION

In Brubaker, Buciumas, Bump and Gustafsson [6] it is proved that for a basis $\{\omega_w\}$ of Iwahori Whittaker functions on $G = \mathrm{GL}_r(F)$ over a nonarchimedean local field, and for all $g \in G$, there is a solvable lattice model whose partition function equals $\omega_w(g)$. The lattice models are “fermionic” and are associated with the quantum affine supergroup $U_{\sqrt{q}}(\widehat{\mathfrak{gl}}(r|1))$. On the other hand, in this paper we will consider bosonic models, associated to the quantum group $U_{\sqrt{q}}(\widehat{\mathfrak{sl}}_{r+1})$ whose partition functions are Iwahori spherical matrix coefficients. The two theories are very closely parallel, as we will now explain.

Before specializing to the case where $G = \mathrm{GL}_r$, let G be a split reductive algebraic group over a nonarchimedean local field F . Let K be a special maximal compact subgroup. The group G has a family $\{(\pi_{\mathbf{z}}, I(\mathbf{z}))\}$ of representations, the *spherical principal series*, parametrized by an element \mathbf{z} of a complex torus \hat{T} , the maximal torus of the Langland dual group. If \mathbf{z} is in general position, $\pi_{\mathbf{z}}$ is irreducible. The space $I(\mathbf{z})$ is infinite dimensional, but we will focus on the $|W|$ -dimensional space $I(\mathbf{z})^J$ of vectors invariant under the Iwahori

subgroup J . Here W is the Weyl group. The space $I(\mathbf{z})^J$ has a standard basis $\phi_w^{\mathbf{z}}$ indexed by elements w of W .

There are two noteworthy linear functionals on $I(\mathbf{z})$, the Whittaker functional $\mathcal{W}_{\mathbf{z}}$, and the spherical functional which we will denote $\mathcal{S}_{\mathbf{z}}$. Both functionals are unique up to constant multiple, and have natural normalizations as integrals. We may use them to define ‘‘special functions,’’ which are functions $\omega_w^{\mathbf{z}}$ and $\sigma_w^{\mathbf{z}}$ on G defined by

$$(1) \quad \omega_w^{\mathbf{z}}(g) = \mathcal{W}_{\mathbf{z}}(\pi_{\mathbf{z}}(g)\phi_w^{\mathbf{z}}), \quad \sigma_w^{\mathbf{z}}(g) = \mathcal{S}_{\mathbf{z}}(\pi_{\mathbf{z}}(g)\phi_w^{\mathbf{z}}).$$

We will call these *Iwahori Whittaker functions* and *Iwahori-Spherical functions*, respectively. The spaces of functions $\mathcal{W}_{\mathbf{z}}(\pi_{\mathbf{z}}(g)\phi)$ and $\mathcal{S}_{\mathbf{z}}(\pi_{\mathbf{z}}(g)\phi)$ for $\phi \in I(\mathbf{z})$ are the *Whittaker model* and *spherical model* of the representation $\pi_{\mathbf{z}}$, and the functions (1) are the Iwahori-fixed vectors in the models.

There is a significant parallel between these two types of special functions. It is explained in [12, 13, 11, 5] that these two models are related to representations of the affine Hecke algebra. This is the algebra generated by T_i (corresponding to the simple reflections $s_i \in W$) subject to the quadratic relations

$$T_i^2 = (q - 1)T_i + q$$

and the braid relations, together with another subalgebra isomorphic to the group algebra of the weight lattice Λ of the Langlands dual group \hat{G} . We will denote by \mathcal{H} the finite-dimensional algebra generated by the T_i , and by $\tilde{\mathcal{H}}$ the full affine Hecke algebra.

The two representations of \mathcal{H} in question are called the *antispherical* and *spherical* representations, and are induced from the characters of \mathcal{H} that send T_i to -1 and q , respectively. They can be realized as actions of $\tilde{\mathcal{H}}$ on the ring $\mathcal{O}(\hat{T})$ of (Laurent) polynomials in \mathbf{z} . To this end, define operators \mathfrak{T}_i and \mathcal{L}_i on $\mathcal{O}(\hat{T})$ by

$$\mathfrak{T}_i f(\mathbf{z}) = \frac{f(\mathbf{z}) - f(s_i \mathbf{z})}{\mathbf{z}^{\alpha_i} - 1} - q \frac{f(\mathbf{z}) - \mathbf{z}^{-\alpha_i} f(s_i \mathbf{z})}{\mathbf{z}^{\alpha_i} - 1}$$

and

$$\mathcal{L}_i f(\mathbf{z}) = \frac{f(\mathbf{z}) - f(s_i \mathbf{z})}{\mathbf{z}^{\alpha_i} - 1} - q \frac{f(\mathbf{z}) - \mathbf{z}^{\alpha_i} f(s_i \mathbf{z})}{\mathbf{z}^{\alpha_i} - 1}.$$

The operators \mathcal{L}_i are called *Demazure-Lusztig operators*, and we will call the \mathfrak{T}_i *Demazure-Whittaker operators*. These lead to recursions for the Iwahori Whittaker and spherical functions ([12]), namely

$$(2) \quad \omega_{s_i w}^{\mathbf{z}}(g) = \begin{cases} \mathfrak{T}_i \omega_w^{\mathbf{z}}(g) & \text{if } s_i w > w, \\ \mathfrak{T}_i^{-1} \omega_w^{\mathbf{z}}(g) & \text{if } s_i w < w \end{cases}$$

and similarly

$$(3) \quad \sigma_{s_i w}^{\mathbf{z}}(g) = \begin{cases} \mathcal{L}_i \sigma_w^{\mathbf{z}}(g) & \text{if } s_i w > w, \\ \mathcal{L}_i^{-1} \sigma_w^{\mathbf{z}}(g) & \text{if } s_i w < w. \end{cases}$$

These actions of \mathcal{H} by Demazure-like operators can be extended to actions of the affine Hecke algebra \tilde{H} by complementing them with an action of a large abelian subalgebra isomorphic to the weight lattice. See [12, 11] for this point. The spherical representation of \tilde{H} , in which the Hecke generators act by Demazure-Lusztig operators, was shown by Lusztig [26] to be an action on the equivariant K-theory of flag varieties, a fact that was applied by Kazhdan and Lusztig [24] to the Deligne-Lusztig conjecture.

Equation (2) means that if we know the value $\omega_w(g)$ for one w , then obtaining the rest is a matter of applying the \mathfrak{T}_i . Now for the Whittaker model, it was shown in [6] that there is a w for which $\omega_w(g)$ is in fact a monomial, but which w depends on $g \in G$. Specifically, $\omega_w(g)$ depends essentially only on the coset of g in $N \backslash G / J$, where N is a maximal unipotent subgroup, and as coset representatives we may take $g = \varpi^\lambda w_2$ where $\varpi^\lambda = \text{diag}(\varpi^{\lambda_1}, \dots, \varpi^{\lambda_r})$, and ϖ is a prime element, and $w_2 \in W$.

Remark 1.1. *If $w = w_2$, it is shown in [6] that $\omega_w(g)$ is a monomial, as a consequence of support considerations for the Jacquet integral defining the Whittaker function. Furthermore $\omega_w(g) = 0$ unless λ is w_2 -almost dominant, a technical condition.*

In Brubaker, Buciumas, Bump and Gustafsson [6] the following fact is proved. It is reproved using a different technique in Naprienko [30].

Theorem 1.2 ([6], Theorem A, [30], Section 3.3.1). *For every $g \in G$, and for every $w \in W$ there is a solvable lattice model whose partition function is $\omega_w(g)$.*

There is an intricacy here, that the boundary conditions for the model must encode three pieces of data, namely w, w_2 and λ , which is assumed to be w_2 -almost dominant. There are therefore three things that must be encoded in the boundary conditions of the model, namely w, w_2 and λ . If $w = w_2$, then the model has a unique state, and its partition function is a monomial, which may be compared with the base case for the Iwahori Whittaker functions (Remark 1.1). Then the general case follows from (2), because the lattice models satisfy the same Demazure-Whittaker recursion. This is proved using the Yang-Baxter equation.

The purpose of this paper is to show that all of the above features extend to the spherical model. Our main result (Corollary 6.10) is that for the basis σ_w of Iwahori fixed vectors in the spherical model, and for any $g \in G$ there is a solvable lattice model whose partition function is $\sigma_w(g)$.

The models, it turns out, are essentially known, for they are specializations of models previously investigated by Borodin and Wheeler [3]. Although they are a special case of these more general models, it is a special case that warrants separate treatment.

The p -adic side of the story was previously investigated by Ion [21] (who showed that the Iwahori-spherical functions are nonsymmetric Macdonald polynomials) and Brubaker, Bump and Friedberg [11]. Related work includes Opdam [31], Cherednik and Ostrik [20] Section 10, Cherednik [17] and Cherednik and Ma [18, 19] relating p -adic matrix coefficients theory with nonsymmetric Macdonald polynomials and the DAHA.

Returning to the comparison of the results of this paper, where bosonic models represent values of Iwahori vectors in the spherical model, and those of [6], where fermionic models represent the values of Iwahori Whittaker functions. An important point for us is to show how remarkably similar the two examples are, and also to show how they are different.

We will describe two kinds of *uncolored* bosonic models, whose partition functions are, respectively, the Hall-Littlewood P - and R -polynomials ([28] Chapter III). The uncolored P -models are the same as those in Korff [25]. The R -models are close relatives of the P -model, but have more favorable locality properties. The Hall-Littlewood P - and R -polynomials differ by a constant, but that constant (denoted $v_\lambda(t)$ in [28]) depends on λ , this is an important distinction. The P - and R -models are related to each other by a simple transformation of the Boltzmann weights, called *change of basis* in [4], Section 4. This does not affect the R -matrix, so both models use the same R -matrix (Figures 5 and 7).

After we define the uncolored R - and P -systems, we will define *colored* variants, which we will apply to describe matrix coefficients of principal series representations of GL_r over a nonarchimedean local field.

These bosonic models are very close analogs of the fermionic models in Brubaker, Bump, Buciumas and Gustafsson [6] which represent Iwahori Whittaker functions for $GL_r(F)$, and we will emphasize these significant parallels. In particular:

- The R -matrices in this paper are *identical* to those in [6] except for *one value* (Figures 5 and 7). This minor change alters the underlying quantum group from $U_{\sqrt{q}}(\widehat{\mathfrak{gl}}(r|1))$ (in [6]) to $U_{\sqrt{q}}(\widehat{\mathfrak{gl}}(r+1))$ (in this paper).
- There is a *local lifting property* that relates the weights of the uncolored model to the colored model. In [6] this is Properties A and B in Section 8. In this paper, see Section 5. This is most clear in the case of the R -models; for the P -models, it persists in a local lifting property for the column transfer matrices.
- The vertices and vertical edges admit a factorization into *monochrome vertices*. There are thus two versions of the model. The vertices of the colored model will be called *fused* weights and are obtained from the monochrome vertices by *fusion*. This simplifies the proof of the Yang-Baxter equation and the local lifting property. We will use fusion in the very definition of the Boltzmann weights for the colored model.

It was realized independently by Macfarlane [29] and Biedenharn [2] that the q -harmonic oscillator is related to the quantum group $U_{\sqrt{q}}(\mathfrak{sl}_2)$. A Verma module for this quantum group has a ladder structure like the quantum mechanical harmonic oscillator, and the different energy levels may be regarded as states with different numbers of bosons. Hall-Littlewood polynomials then appeared in Tsilevich [32] and Korff [25]. For solvable lattice models, there is a paradigm that the edges of the model each correspond to a module for a quantum group. (For the models in this paper and [6], this paradigm applies to the fused versions of the models.) The partition functions in [25] are made with the $U_{\sqrt{q}}(\widehat{\mathfrak{sl}}_2)$ Verma module, and they are the symmetric Hall-Littlewood polynomials. However in [3], colored models based on $U_{\sqrt{q}}(\widehat{\mathfrak{sl}}_{r+1})$ Verma modules were introduced, and the resulting partition functions are nonsymmetric Hall-Littlewood (Macdonald) functions. The models in this paper are the special case where the spin parameter of Borodin and Wheeler $s = 0$, and these are Verma modules with respect to a maximal parabolic subgroup whose radical is abelian (before quantization). This may account for the monochrome factorization property.

The Iwahori spherical functions are special cases of *matrix coefficients* which are functions of the form $\langle \pi_{\mathbf{z}}(g)\phi, \psi \rangle$ where $\phi \in I(\mathbf{z})$ and $\psi \in I(-\mathbf{z})$, where the pairing \langle , \rangle comes from the fact that $I(-\mathbf{z})$ is the contragredient representation of $I(\mathbf{z})$. In this paper we are taking ψ to be the K -fixed vector in the contragredient module and ϕ to be J -fixed. It would be good to have lattice models whose partition functions are arbitrary (smooth) matrix coefficients of an arbitrary irreducible representation of G , which would be a full recasting of the representation theory of G . A more modest goal that seems in reach would be to represent the matrix coefficients for the principal series representations in which both ϕ and ψ are Iwahori-fixed vectors. The results of this paper, and the philosophy of Iwahori-Metaplectic duality explained in [9] suggests that such models would be bosonic models similar to the fermionic models in [7] (see also [1]) but for the quantum group $U_{\sqrt{q}}(\widehat{\mathfrak{sl}}_{2r})$ instead of the super quantum group $U_{\sqrt{q}}(\widehat{\mathfrak{sl}}(r|n))$. We hope to consider such models in a later paper.

Acknowledgements: We would like to thank Amol Aggarwal, Alexei Borodin, Ben Brubaker, Valentin Buciumas, Henrik Gustafsson, Andy Hardt and Christian Korff for helpful conversations about bosonic models and the subject of this paper.

2. DEMAZURE OPERATORS

We begin by recalling some properties of Demazure operators. Let \hat{G} be a reductive complex algebraic group, and let \hat{T} be its maximal torus. Let $\Lambda = X^*(\hat{T})$ be the weight lattice of \hat{G} , and let $\Phi \subset \Lambda$ be the root system, with Weyl group W acting on Λ . We partition Φ into positive and negative roots Φ^\pm , and will denote by $\alpha_1, \dots, \alpha_r$ the simple positive roots, and by s_i the simple reflections. An element $\lambda \in \Lambda$ is called *dominant* if $\langle \alpha, \lambda \rangle \geq 0$ for positive roots α with respect to a fixed W -invariant inner product $\langle \cdot, \cdot \rangle$. Let w_0 be the longest element of W . Let $\mathcal{O}(\hat{T})$ be the ring of polynomial functions on \hat{T} . If $\lambda \in \Lambda$ and $\mathbf{z} \in \hat{T}$ we will denote by \mathbf{z}^λ the application of λ to \mathbf{z} . The functions \mathbf{z}^λ generate the ring $\mathcal{O}(\hat{T})$, which is thus isomorphic to the group algebra of Λ . Ultimately we will be interested in the case where \hat{T} is the diagonal torus in $\mathrm{GL}_{r+1}(\mathbb{C})$ and Φ is the Type A root system, but in this section, we may work more generally.

If $f \in \mathcal{O}(\hat{T})$ we will denote

$$\partial_i f(\mathbf{z}) = \frac{f(\mathbf{z}) - \mathbf{z}^{-\alpha_i} f(s_i \mathbf{z})}{1 - \mathbf{z}^{-\alpha_i}},$$

and

$$\partial_i^\circ f(\mathbf{z}) = \frac{f(\mathbf{z}) - f(s_i \mathbf{z})}{\mathbf{z}^{\alpha_i} - 1}.$$

These divided difference operators do not introduce denominators, since the numerators vanishes when $\mathbf{z}^{\alpha_i} = 1$. It is easy to check that

$$(4) \quad \partial_i = \partial_i^\circ + 1$$

Proposition 2.1. *The operators ∂_i and ∂_i° satisfy the braid relations for the Weyl group W . Consequently if $w = s_{i_1} \cdots s_{i_k}$ is a reduced expression we may define*

$$\partial_w f = \partial_{i_1} \cdots \partial_{i_k} f, \quad \partial_w^\circ f = \partial_{i_1}^\circ \cdots \partial_{i_k}^\circ f.$$

Thus if D_i denotes either ∂_i or ∂_i° , and if $1 \leq i, j \leq r$, then the braid relation asserts that

$$D_i D_j D_i \cdots = D_j D_i D_j \cdots$$

where the number of terms on both sides is the order of $s_i s_j$ in W .

Proof. This is proved in Chapter 25 of [14], where ∂_i° is denoted D_i . For ∂_i° , this is Proposition 25.1, while for ∂_i it is Proposition 25.3. (There is a typo, where the wrong font D_i is used instead of ∂_i for the statement of this proposition.) The implication that ∂_w and ∂_w° are well-defined as a consequence of the braid relations is ‘‘Matsumoto’s theorem,’’ Theorem 25.2 in [14]. \square

If $f \in \mathcal{O}(\hat{T})$, define

$$\Omega(f) = \prod_{\alpha \in \Phi^+} (1 - \mathbf{z}^{-\alpha})^{-1} \mathbf{z}^{-\rho} \sum_{w \in W} (-1)^{\ell(w)} w(\mathbf{z}^\rho f).$$

If $\lambda \in \Lambda$ is dominant, then by the Weyl character formula $\Omega(\mathbf{z}^\lambda) = \chi_\lambda(\mathbf{z})$ if λ , where $\chi_\lambda(\mathbf{z})$ is the character of the irreducible representation of \hat{G} with highest weight λ . In the Type A case, if λ is a partition (which is a dominant weight) this is just the Schur polynomial $s_\lambda(\mathbf{z})$.

The next result makes use of the strong Bruhat order \leq on W .

Proposition 2.2. *Let $w \in W$. Then*

$$\partial_w = \sum_{y \leq w} \partial_y^\circ.$$

Proof. See [8], Theorem 2.1. □

Proposition 2.3 (Demazure). *We have*

$$\Omega = \partial_{w_0}, \quad \Omega = \sum_{w \in W} \partial_w^\circ.$$

Proof. By Proposition 25.3 in [14] we have $\Omega = \partial_{w_0}$. The identity $\Omega = \sum_{w \in W} \partial_w^\circ$ follows from Proposition 2.2 with $w = w_0$. □

Lemma 2.4. *We have*

$$\Omega(\mathbf{z}^{w(\lambda+\rho)-\rho}) = (-1)^{\ell(w)} \Omega(\mathbf{z}^\lambda).$$

As a particular case

$$\Omega(\mathbf{z}^{w_0\lambda-2\rho}) = (-1)^{\ell(w_0)} \Omega(\mathbf{z}^\lambda).$$

Proof. We will use the dot action of the Weyl group on Λ :

$$w \bullet \lambda = w(\lambda + \rho) - \rho.$$

We may then write

$$\Omega(\mathbf{z}^\mu) = \prod_{\alpha \in \Phi^+} (1 - \mathbf{z}^{-\alpha})^{-1} \sum_{w \in W} (-1)^{\ell(w)} \mathbf{z}^{w \bullet \lambda}$$

and from this the statement follows from a change of variables, using the fact that \bullet is a group action. □

Now let q be a parameter, which can be an element of \mathbb{C}^\times or an indeterminate. If $\lambda \in \Lambda$ is a dominant weight, define

$$(5) \quad R_\lambda(\mathbf{z}; q) = \Omega \left(\prod_{\alpha \in \Phi^+} (1 - q\mathbf{z}^{-\alpha}) \mathbf{z}^\lambda \right).$$

It is easy to show that

$$(6) \quad R_\lambda(\mathbf{z}; q) = \sum_{w \in W} w \left(\prod_{\alpha \in \Phi^+} \frac{1 - q\mathbf{z}^{-\alpha}}{1 - \mathbf{z}^{-\alpha}} \mathbf{z}^\lambda \right).$$

In the Type A case, if λ is a partition, these are the Hall-Littlewood R-polynomials (Macdonald [28], Chapter 3). We will avoid using the notation R_λ if λ is not dominant, even though expressions such as the right hand side of (5) will arise. A special case is given by the following result.

Proposition 2.5. *If λ is dominant, then*

$$\Omega \left(\prod_{\alpha \in \Phi^+} (1 - q\mathbf{z}^{-\alpha}) \mathbf{z}^{w_0\lambda} \right) = q^{|\Phi^+|} R_\lambda(\mathbf{z}; q^{-1}).$$

Proof. Expanding the product gives the sum over subsets of Φ^+ :

$$\sum_{S \subseteq \Phi^+} (-q)^{|S|} \Omega(\mathbf{z}^{w_0 \lambda - \sum_{\alpha \in S} \alpha}).$$

Replacing S by $T = \Phi^+ - S$ this equals

$$(-q)^{|\Phi^+|} \sum_{T \subseteq \Phi^+} (-q)^{-|T|} \Omega(\mathbf{z}^{w_0 \lambda - 2\rho + \sum_{\alpha \in T} \alpha}).$$

Let $U = -w_0 T$. Then

$$\sum_{\alpha \in T} \alpha = -w_0 \left(\sum_{\alpha \in U} \alpha \right).$$

The map $T \mapsto -w_0 T$ permutes the subsets of Φ^+ and using Lemma 2.4 we obtain

$$(-q)^{|\Phi^+|} \sum_{U \subseteq \Phi^+} (-q)^{-|U|} \Omega(\mathbf{z}^{w_0(\lambda - \sum_{\alpha \in U} \alpha) - 2\rho}) = q^{|\Phi^+|} \sum_{U \subseteq \Phi^+} (-q)^{-|U|} \Omega(\mathbf{z}^{\lambda - \sum_{\alpha \in U} \alpha}).$$

This equals

$$q^{|\Phi^+|} \Omega \left(\prod_{\alpha \in \Phi^+} (1 - q^{-1} \mathbf{z}^{-\alpha}) \mathbf{z}^\lambda \right) = q^{|\Phi^+|} R_\lambda(\mathbf{z}; q^{-1}). \quad \square$$

Let $\mathcal{O}_q(\hat{T}) = \mathcal{O}(\hat{T})[q, q^{-1}]$. If we regard q as an indeterminate, this is a Laurent polynomial ring in q over $\mathcal{O}(\hat{T})$. For $f \in \mathcal{O}_q(\hat{T})$, the Demazure-Lusztig operators are defined by

$$(7) \quad \mathcal{L}_{i,q} f(\mathbf{z}) = \mathcal{L}_{i,q}^{\mathbf{z}} f(\mathbf{z}) = \frac{f(\mathbf{z}) - f(s_i \mathbf{z})}{\mathbf{z}^{\alpha_i} - 1} - q \frac{f(\mathbf{z}) - \mathbf{z}^{\alpha_i} f(s_i \mathbf{z})}{\mathbf{z}^{\alpha_i} - 1}.$$

They map $\mathcal{O}(\hat{T})$ into $\mathcal{O}_q(\hat{T})$. They satisfy the quadratic relations

$$\mathcal{L}_{i,q}^2 = (q - 1) \mathcal{L}_{i,q} + q.$$

The inverse operator equals

$$(8) \quad \mathcal{L}_{i,q}^{-1} f(\mathbf{z}) = \left(\frac{f(\mathbf{z}) - f(s_i \mathbf{z})}{\mathbf{z}^{-\alpha_i} - 1} \right) - q^{-1} \left(\frac{f(\mathbf{z}) - \mathbf{z}^{-\alpha_i} f(s_i \mathbf{z})}{\mathbf{z}^{-\alpha_i} - 1} \right).$$

The \mathcal{L}_i satisfy the braid relations by Lusztig [26] equation (5.2), proved in Section 8. Consequently if $w = s_{i_1} \cdots s_{i_k}$ is a reduced expression for $w \in W$, we may write

$$\mathcal{L}_{w,q} = \mathcal{L}_{w,q}^{\mathbf{z}} = \mathcal{L}_{i_1,q} \cdots \mathcal{L}_{i_k,q},$$

and this is well-defined.

Lemma 2.6. *We have*

$$(9) \quad \mathcal{L}_{i,q} + 1 = v(\mathcal{L}_{i,q}^{-1} + 1) = \partial_i(1 - q\mathbf{z}^{-\alpha_i}).$$

Proof. Each operator in (9) may be computed to equal

$$(\mathbf{z}^{\alpha_i} - 1)^{-1} (\mathbf{z}^{\alpha_i} - s_i - v + v\mathbf{z}^{\alpha_i} s_i). \quad \square$$

Proposition 2.7. *Let $f \in \mathcal{O}(\hat{T})$. Then*

$$\sum_{w \in W} \mathcal{L}_{w,q} f = \Omega \left(\prod_{\alpha \in \Phi^+} (1 - q\mathbf{z}^{-\alpha}) f \right).$$

In particular, if λ is dominant,

$$\sum_{w \in W} \mathcal{L}_{w,q} \mathbf{z}^\lambda = R_\lambda(\mathbf{z}; q).$$

Proof. See [12], Theorem 14 for a statement that includes this fact. For completeness, we give a proof here. Let Θ be the operator

$$(10) \quad \Theta = \sum_{w \in W} \mathcal{L}_{w,q}.$$

First we argue that if $w \in W$ then $w\Theta = \Theta$. It is enough to check this when $w = s_i$ is a simple reflection. We write

$$\Theta = (1 + \mathcal{L}_{i,q}) \sum_{\substack{w \in W \\ s_i w > w}} \mathcal{L}_{w,q} = \partial_i (1 - q\mathbf{z}^{-\alpha_i}) \sum_{\substack{w \in W \\ s_i w > w}} \mathcal{L}_{w,q},$$

and since $s_i \partial_i = \partial_i$ (as is easily checked) the statement follows. On the other hand let

$$\Theta' = \Omega \prod_{\alpha \in \Phi^+} (1 - q\mathbf{z}^{-\alpha}).$$

We wish to show $\Theta = \Theta'$. Since $w\Omega = \Omega$ we also have $w\Theta' = \Theta'$.

We may expand Θ and Θ' and write

$$\Theta = \sum_{w \in W} h_{w,q}(\mathbf{z}) w, \quad \Theta' = \sum_{w \in W} h'_{w,q}(\mathbf{z}) w.$$

If $y \in W$ then since $y\Theta = \Theta$ we must have

$$y(h_{w,q}(\mathbf{z})) = h_{yw,q}(\mathbf{z}),$$

and similarly for $h'_{w,q}$. Thus to show $\Theta = \Theta'$ we need only show $h_{w,q} = h'_{w,q}$ for one w . We will prove this when $w = w_0$.

Only $\mathcal{L}_{w_0,q}$ can contribute to the coefficient of w_0 . Let $w_0 = s_{i_1} \cdots s_{i_N}$ be a reduced expression. We write

$$\mathcal{L}_{w_0,q} = \mathcal{L}_{i_1,q} \cdots \mathcal{L}_{i_N,q} = \prod_{j=1}^N \left(\left(\frac{1-q}{\mathbf{z}^{\alpha_{i_j}} - 1} \right) + \frac{1 - q\mathbf{z}^{\alpha_{i_j}}}{1 - \mathbf{z}^{\alpha_{i_j}}} s_{i_j} \right).$$

In multiplying this out, the only way to get w_0 is to take the term involving s_{i_j} from each factor and therefore

$$h_{w_0,q}(\mathbf{z}) = \left(\frac{1 - q\mathbf{z}^{\alpha_{i_1}}}{1 - \mathbf{z}^{\alpha_{i_1}}} s_{i_1} \right) \cdots \left(\frac{1 - q\mathbf{z}^{\alpha_{i_N}}}{1 - \mathbf{z}^{\alpha_{i_N}}} s_{i_N} \right).$$

Moving the s_{i_j} to the right,

$$\prod_{j=1}^N \left(\frac{1 - q\mathbf{z}^{\beta_1}}{1 - \mathbf{z}^{\beta_1}} \right) \cdots \left(\frac{1 - q\mathbf{z}^{\beta_N}}{1 - \mathbf{z}^{\beta_N}} \right) s_{i_1} \cdots s_{i_N},$$

where $\beta_1 = \alpha_{i_1}$, $\beta_2 = s_{i_1}(\alpha_{i_2})$, $\beta_3 = s_{i_1}s_{i_2}(\alpha_{i_3}), \dots$. It is well-known that β_1, \dots, β_N is an enumeration of the positive roots ([14] Proposition 20.10), so

$$h_{w_0, q}(\mathbf{z}) = \prod_{\alpha \in \Phi^+} \left(\frac{1 - q\mathbf{z}^\alpha}{1 - \mathbf{z}^\alpha} \right) = w_0 \left(\prod_{\alpha \in \Phi^+} \left(\frac{1 - q\mathbf{z}^{-\alpha}}{1 - \mathbf{z}^{-\alpha}} \right) \right)$$

which also equals $h'_{w_0, q}$. □

Theorem 2.8. *Let $y \in W$ and let $\lambda \in \Lambda$. Then there exists a family of functions $\tau_{w, y}^\lambda(\mathbf{z}; q) \in \mathcal{O}_q(\hat{T})$ indexed by $w \in W$ such that if $s = s_i$ is a simple reflection*

$$(11) \quad \tau_{sw, y}^\lambda(\mathbf{z}; q) = \begin{cases} \mathcal{L}_{i, q} \tau_{w, y}^\lambda(\mathbf{z}; q) & \text{if } sw > w, \\ \mathcal{L}_{i, q}^{-1} \tau_{w, y}^\lambda(\mathbf{z}; q) & \text{if } sw < w, \end{cases}$$

and such that $\tau_{y, y}^\lambda(\mathbf{z}; q) = q^{\ell(y)} \mathbf{z}^\lambda$. Moreover, we have

$$\sum_{w \in W} \tau_{w, y}^\lambda(\mathbf{z}; q) = \Omega \left(\prod_{\alpha \in \Phi^+} (1 - q\mathbf{z}^{-\alpha}) \mathbf{z}^\lambda \right).$$

In particular, if λ is dominant, then

$$(12) \quad \sum_{w \in W} \tau_{w, y}^\lambda(\mathbf{z}; q) = R_\lambda(\mathbf{z}; q),$$

and if λ is antidominant, then

$$(13) \quad \sum_{w \in W} \tau_{w, y}^\lambda(\mathbf{z}; q) = q^{|\Phi^+|} R_{w_0 \lambda}(\mathbf{z}; q^{-1}).$$

Furthermore, we have

$$(14) \quad \tau_{w, y}^\lambda(\mathbf{z}; q) = q^{|\Phi^+|} \tau_{w w_0, y w_0}^{-\lambda}(\mathbf{z}^{-1}; q^{-1}).$$

Thus summing over w in (12) produces *two* W invariance properties that $\tau_{w, y}^\lambda(\mathbf{z})$ does not possess: the sum becomes symmetric, invariant under the action of W on \mathbf{z} , and it also becomes independent on the Weyl group element y .

Proof. We may define $\tau_{w, y}^\lambda(\mathbf{z}; q) = q^{\ell(w)} \mathcal{L}_{w, q} \mathcal{L}_{y, q}^{-1} \mathbf{z}^\lambda$ and the identity (11) follows easily. The problem will be to prove (12) and (13). Both are cases of the identity

$$(15) \quad \sum_{w \in W} \tau_{w, y}^\lambda(\mathbf{z}; q) = \Omega \left(\prod_{\alpha \in \Phi^+} (1 - q\mathbf{z}^{-\alpha}) \mathbf{z}^\lambda \right),$$

which we will prove for any λ . If λ is dominant, then (15) implies (12) from the definition of R_λ , while if λ is antidominant, then it implies (13) by Proposition 2.5.

If $y = 1$, then Proposition 2.7 implies (15) in this case. To prove the more general case it suffices to show that

$$q^{\ell(w)} \Theta \mathcal{L}_{y, q}^{-1} = \Theta$$

where Θ is defined by (10). This reduces immediately to the case where $y = s_i$ is a simple reflection. Then we have

$$q \Theta \mathcal{L}_{i, q}^{-1} = q \left(\sum_{\substack{w \in W \\ w s_i > w}} \mathcal{L}_{w, q} \right) (1 + \mathcal{L}_{i, q}) \mathcal{L}_i^{-1} = q \left(\sum_{\substack{w \in W \\ w s_i > w}} \mathcal{L}_{w, q} \right) (1 + \mathcal{L}_{i, q}^{-1}).$$

Using (9), this equals

$$\left(\sum_{\substack{w \in W \\ ws_i > w}} \mathcal{L}_{w,q} \right) (1 + \mathcal{L}_{i,q}) = \Theta.$$

To prove the involution identity (14), define by $c : \mathcal{O}(\hat{T}) \rightarrow \mathcal{O}(\hat{T})$ the map $cf(\mathbf{z}) = f(\mathbf{z}^{-1})$. Comparing (7) and (8) shows that

$$(16) \quad \mathcal{L}_{i,q}^{-1} = c \mathcal{L}_{i,q^{-1}} c,$$

And using this identity, together with the fact that the map $w \mapsto ww_0$ is order-reversing for the Bruhat order, it is easy to check that the right-hand side of (14) satisfies the defining properties of $\tau_{w,y}^\lambda$. \square

3. THE UNCOLORED BOSONIC MODELS

We recall some basics about solvable lattice models. We will describe a system \mathfrak{S} with an ensemble of states \mathfrak{s} . For every state $\mathfrak{s} \in \mathfrak{S}$ there is assigned a *Boltzmann weight* $\beta(\mathfrak{s})$. The *partition function* is then

$$(17) \quad Z(\mathfrak{S}) = \sum_{\mathfrak{s} \in \mathfrak{S}} \beta(\mathfrak{s}).$$

To specify the system \mathfrak{S} we begin with a planar array consisting of vertices and edges, such as an $r \times N$ grid. We will assume that each vertex is adjacent to four edges. The edges are divided into *boundary edges* at the boundary of the array, and *interior edges* in the interior. Every interior edge is adjacent to four vertices, and every boundary edge is adjacent to a single vertex. Every edge E is assigned a *spinset* Σ_E of allowable states. Every boundary edge is assigned a fixed element of its spinset, which is fixed and is part of the data defining the system. To specify a state $\mathfrak{s} \in \mathfrak{S}$, we assign spins to the internal edges, picking for each edge E a spin $s \in \Sigma_E$. Now as part of the data specifying the system \mathfrak{S} , for each vertex v we assign a set of *local Boltzmann weights*, which is a function from the set of possible spins of its four adjacent edges to \mathbb{C} . Thus given a state \mathfrak{s} every vertex is assigned a local Boltzmann weight, and the product of these over all vertices is the Boltzmann weight $\beta(\mathfrak{s})$ appearing in (17). The model is *solvable* or *integrable* if it is amenable to study using the Yang-Baxter equation.

In this section we describe the uncolored models, based on a single boson type \ominus . The spinset of the horizontal edges is $\Sigma_{\text{h}}^{\text{unc}} = \{\oplus, \ominus\}$, where \oplus denotes the absence of a particle, and \ominus denotes the presence. The spinset of the vertical edge is

$$\Sigma_{\text{v}}^{\text{unc}} = \{\textcircled{n} | n \in \mathbb{N}\}, \quad \mathbb{N} = \{0, 1, 2, \dots\},$$

where \textcircled{n} represents a state with n identical particles present. Now the Boltzmann weights are described in Figure 2. These depend on a parameter $z = z_i \in \mathbb{C}^\times$. Note that there are alternative weights, which we call P - and R - weights, respectively. The P -weights are the same as those in Korff [25].

We will (for the remainder of the paper) take Λ to be the GL_r root system, which can be identified with \mathbb{Z}^r . The Weyl group W is then the symmetric group S_r . A weight $\lambda \in \Lambda$ is dominant if $\lambda_1 \geq \dots \geq \lambda_r$. If $\lambda_r \geq 0$, then λ is just a partition of length $\leq r$. We will at first describe the systems when λ is a partition, then in Remark 3.4 discuss the minor modifications required when λ_r is allowed to be negative.

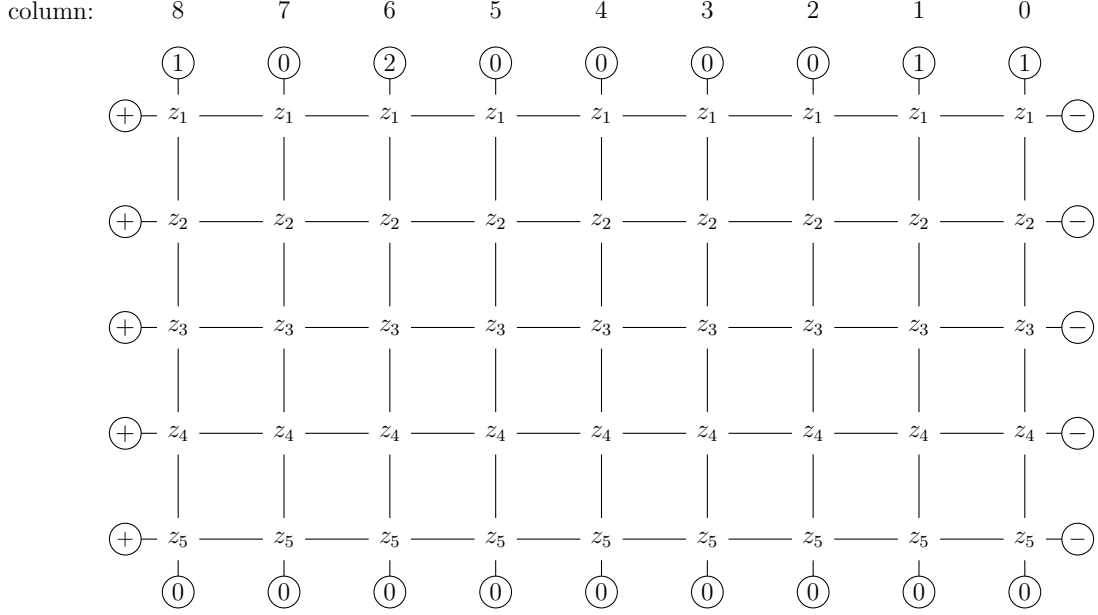


FIGURE 1. The grid with boundary conditions for the uncolored model, $\mathfrak{S}_\lambda^P(\mathbf{z})$ or $\mathfrak{S}_\lambda^R(\mathbf{z})$, corresponding to the partition $\lambda = (8, 6, 6, 1, 0)$, with $r = 5$. A state of the model will assign spins to the interior model.

name	$A(n)$	$B(n)$	$C(n)$	$D(n)$
P -weights	1	z_i	$z_i(1 - t^{n+1})$	1
R -weights	1	z_i	$z_i(1 - t)$	$\frac{1 - t^{n+1}}{1 - t}$

FIGURE 2. Uncolored Boltzmann weights of two types: the P -weights (which coincide with those in [25]), and the R -weights.

Let $\lambda = (\lambda_1, \dots, \lambda_r)$ be a partition. Then we will describe two uncolored systems $\mathfrak{S}_\lambda^P(\mathbf{z}; t)$ and $\mathfrak{S}_\lambda^R(\mathbf{z}; t)$ where $\mathbf{z} = (z_1, \dots, z_r) \in \hat{T}(\mathbb{C}) = \mathbb{C}^r$. (We will often omit t from the notation.) The uncolored system will have r rows, and N columns, where $N \geq \lambda_1$. The rows are labeled from 1 to r from top to bottom, and the columns are labeled from 0 to N from right to left. The boundary conditions are as follows. The boundary edges are assigned spins as follows. On the left edge, the horizontal edge of every row is assigned spin \oplus , and on the right edge every horizontal edge is assigned spin \ominus . On the bottom, the vertical edge of every column is assigned spin \ominus , and on the top, the edge in the column labeled j is assigned spin $\circledast m_j$ where m_j is the number of parts λ_i of λ equal to j . See Figure 1 for an example of these boundary conditions.

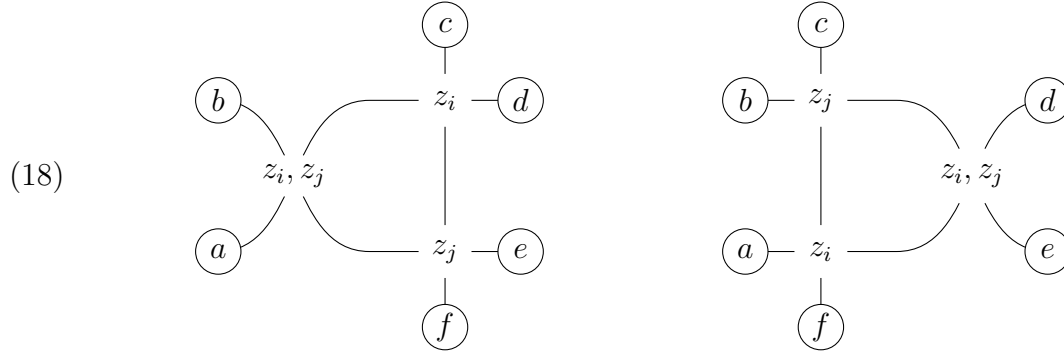


FIGURE 3. The Yang-Baxter equation. The partition functions of the two small 3-vertex systems are the same. Here a, b, c, d, e, f are the fixed boundary spins, and in each case we sum over the possible spins of the three interior edges. We may use either the P - or the R -weights. **Uncolored case:** Use the weights from Figure 2 and the R -matrix from 4. **Colored case:** Use the colored weights obtained by fusion (Figure 9) from the monochrome weights (Figure 8).

We use the Boltzmann weights from Figure 2, which covers both the P - and the R -weights. We will use the notations β_R and β_P to distinguish the two cases. We may also write β_R^{unc} or β_R^{col} to distinguish the weights for the uncolored and colored models.

Proposition 3.1. *The following Yang-Baxter equation is satisfied: given spins $a, b, d, e \in \Sigma_h$ and $c, f \in \Sigma_v$ the partition functions of the small systems in Figure 3 are equal.*

Proof. This may be checked by examination of the individual cases. \square

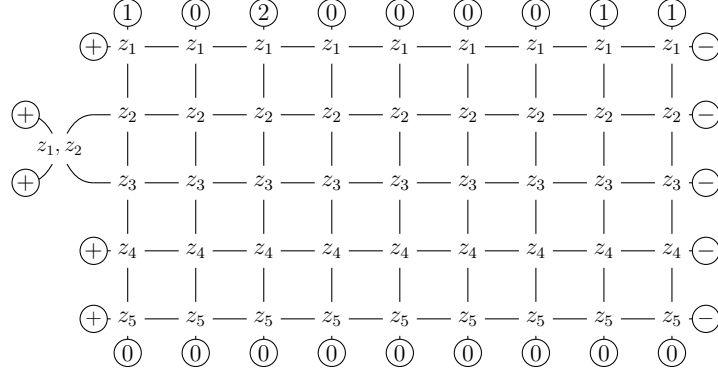
We will use the notations Z_P and Z_R to denote the partition functions of the various systems with respect to the P - and R -weights.

Proposition 3.2. *The partition functions $Z_R(\mathfrak{S}_\lambda(\mathbf{z}; t))$ and $Z_P(\mathfrak{S}_\lambda(\mathbf{z}; t))$ are symmetric polynomials in the z_i .*

$z_i - tz_j$	$z_i - tz_j$	$(1-t)z_i$
$(1-t)z_j$	$t(z_i - z_j)$	$z_i - z_j$

FIGURE 4. The uncolored R -matrix. This works for either the uncolored R - or P -models.

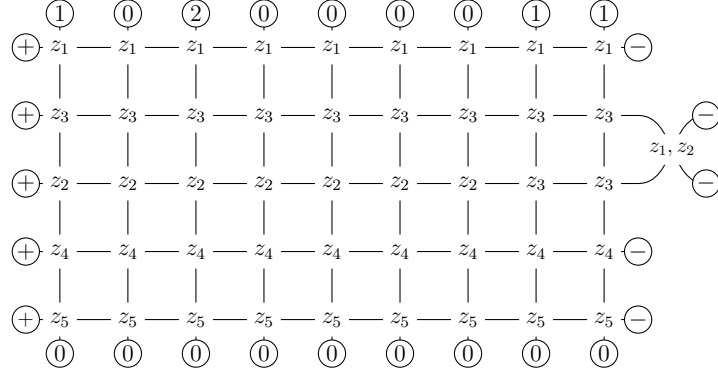
Proof. We will denote by $Z(\mathfrak{S}_\lambda(\mathbf{z}; t))$ either $Z_P(\mathfrak{S}_\lambda(\mathbf{z}, t))$ or $Z_R(\mathfrak{S}_\lambda(\mathbf{z}; t))$, since both satisfy the Yang-Baxter equation for the same R-matrix, and the proof is identical for the two cases. We use the standard “train argument,” due to Baxter, and very similar to the argument in [10]. Let s_i be the simple reflection that acts on $\mathbf{z} = (z_1, \dots, z_r)$ by interchanging z_i and z_j . We attach the R-matrix to the grid between the i and $i + 1$ rows, with boundary conditions as follows:



Note that there is only one configuration for the R-matrix with nonzero Boltzmann weight, in which all adjacent edges have spin \oplus . The Boltzmann weight of this vertex is $z_i - tz_{i+1}$. Therefore the Boltzmann weight of this configuration is

$$(19) \quad (z_i - tz_{i+1})Z(\mathfrak{S}_\lambda(\mathbf{z}; t))$$

Now after using the Yang-Baxter equation N times, we arrive at the configuration:



Again there is only one possible configuration for the R-matrix, in which all adjacent edges have spin \ominus , and the Boltzmann weight of this vertex is again $z_i - tz_{i+1}$. Therefore (19) equals

$$(z_i - tz_{i+1})Z(\mathfrak{S}_\lambda(s_i \mathbf{z}; t))$$

since the z_i and z_{i+1} rows have been switched. Comparing, we see that $Z(\mathfrak{S}_\lambda(\mathbf{z}; t))$ is invariant under s_i , hence under all permutations of the z_i . \square

Theorem 3.3. *The partition functions of these systems equal the Hall-Littlewood P- and R-polynomials ([28], Chapter III):*

$$(20) \quad Z_P(\mathfrak{S}_\lambda(\mathbf{z}; t)) = P_\lambda(z_1, \dots, z_r; t), \quad Z_R(\mathfrak{S}_\lambda(\mathbf{z}; t)) = R_\lambda(z_1, \dots, z_r; t).$$

Proof (part 1). For the P-system, this is due to Korff [25], and for the R-system, we will give a new proof in Section 5. Here we will show how the evaluation of the P-model is equivalent

to the evaluation of the R -model, so that there are two proofs of both facts. This equivalence may be seen by comparing the *column transfer matrices*, which we define as follows. Let $0 \leq j \leq N$, and let $m = m_j$ be the number of entries in λ that are equal to j . Let

$$\delta_1, \dots, \delta_r, \varepsilon_1, \dots, \varepsilon_r \in \Sigma_{\mathfrak{h}} = \{\oplus, \ominus\}.$$

Now let us consider the contributions $C_m^P(\delta, \varepsilon)$ $C_m^R(\delta, \varepsilon)$ of the vertices in the j -th column of a state \mathfrak{s} of the model having spins δ_i to the left of the vertices and ε_i to the right. (With m fixed we may regard C_m^P or C_m^R as a matrix with indices δ, ε , and these are the column transfer matrices.) These values are zero unless the number of ε_i that are equal to \ominus exceeds the number of δ_i that are equal to \ominus by exactly m . From Figure 2 it is easy to see that if this is true, then

$$\frac{C_m^R(\delta, \varepsilon)}{C_m^P(\delta, \varepsilon)} = \prod_{i=1}^m \frac{1-t^i}{1-t},$$

which is denoted $v_m(t)$ in Macdonald [28], Section III.1. Multiplying this identity over all j gives

$$\frac{Z_R(\mathfrak{S}_\lambda(\mathbf{z}; t))}{Z_P(\mathfrak{S}_\lambda(\mathbf{z}; t))} = \prod_j v_{m_j}(t).$$

This is denoted $v_\lambda(t)$ in [28], where P_λ is defined to be $v_\lambda(t)^{-1}R_\lambda$. Therefore the two evaluations in (20) are equivalent. \square

The uncolored models do satisfy Yang-Baxter equations, but these do not seem to give enough information to determine the partition functions without some other input. The uncolored Yang-Baxter equation tells us that these partition functions are symmetric in the z_i , and it is clear from the definitions that these are polynomials in the z_i and t that are homogeneous of degree k in the z_i when λ is a partition of k . But this information is not enough to evaluate them without being supplemented with some other information. In [10] this information consisted of information about degree of the partition function as a polynomial in t and divisibility facts. This would not work in the present situation. However one could argue inductively as in [25] or in Izergin's proof [22] of the Izergin-Korepin determinant formula. But in any case some extra ingredient will be needed. Here we take a different approach, which works for both fermionic and bosonic colored models, obtaining the evaluation of the partition function from a local lifting property of the Boltzmann weights. Thus we will give a proof of Theorem 3.3 using the Yang-Baxter equation, by relating the uncolored model to the colored model.

Remark 3.4. *We have assumed so far that λ is a partition, and that the grid has columns labeled from 0 to N where N is any integer $\geq \lambda_1$. However we will eventually want to consider systems indexed by dominant weights $\lambda_1 \geq \dots \geq \lambda_r$ with λ_r possibly negative. Let N and M be any integers such that $N \geq \lambda_1 \geq \lambda_r \geq M$. Let us consider what happens if we increase N or decrease M . Let $\mathfrak{S}_{\lambda, M, N}(\mathbf{z}; t)$ be the resulting (P - or R -) system. There is a bijection between the states of $\mathfrak{S}_{\lambda, M, N}(\mathbf{z}; t)$ and $\mathfrak{S}_{\lambda, M, N+1}(\mathbf{z}; t)$; adding a column to the left only adds $A(0)$ in the left added column and does not change the partition function. On the other hand, adding a column to the right adds a $B(0)$ pattern in each row, and multiplies the partition function by $z_1 \cdots z_r$. Therefore we may define*

$$(21) \quad Z(\mathfrak{S}_{\lambda, M, N}(\mathbf{z}; t)) = (z_1 \cdots z_r)^M Z(\mathfrak{S}_{\lambda, M, N}(\mathbf{z}; t))$$

and this definition is independent of M .

4. THE COLORED BOSONIC MODELS

Like the uncolored models, there are two variants of the colored models, called the R -models and the P -models. Both kinds of models have two different but equivalent realizations called *fused* and *unfused*. The two versions have the same partition function, and both are based on grids with r rows, but the unfused model has r times as many columns, and hence r times as many vertices and edges (both horizontal and vertical) as the fused model. Unless otherwise made plain, we will be describing the fused model in our explanations. We will use the unfused model in a few crucial places, to define the Boltzmann weights, and to prove the Yang-Baxter equations and the local lifting property.

Let us describe the spinsets of the colored models. There are separate spinsets for the horizontal and vertical edges. The horizontal spinset is

$$\Sigma_h^{\text{col}} = \{+, \gamma_1, \dots, \gamma_r\},$$

where $+$ is a special *vacuum color* and the elements γ_i are called colors. We give them an ordering so that $\gamma_1 > \gamma_2 > \dots > \gamma_r$. The vertical spinset Σ_v^{col} consists of all multisets on $\{\gamma_1, \dots, \gamma_r\}$. Thus an element b of Σ_v^{col} is a map $m : \{\gamma_1, \dots, \gamma_r\} \rightarrow \mathbb{N} = \{0, 1, 2, \dots\}$, where $m(\gamma_i)$ is interpreted as the multiplicity of γ_i in b . If $m_i = m(\gamma_i)$ we may write $b = \gamma_1^{m_1} \dots \gamma_r^{m_r}$. We may denote the “vacuum” state where all $m_i = 0$ as $\mathbb{0}$.

Let $c \in \{\gamma_1, \dots, \gamma_r\}$ be a color. In a state \mathfrak{s} of the model, we recall that every edge E is assigned a spin \mathfrak{s}_E from its spinset Σ_E . If E is a horizontal edge, so $\Sigma_E = \Sigma_h$, we will say that the edge *carries* the color c if $\mathfrak{s}_E = c$. On the other hand if E is a vertical edge, we will say that E *carries* the color c if $\mathfrak{s}_E = \gamma_1^{m_1} \dots \gamma_r^{m_r}$ where $c = \gamma_i$ and $m_i > 0$.

We next turn to the boundary conditions of the system. By a *flag* we mean a sequence $\mathbf{c} = (c_1, \dots, c_r)$ of colors, so $c_i \in \{\gamma_1, \dots, \gamma_r\}$. The colors may or may not repeat. There will be a *standard flag* $\mathbf{c}^\circ = (\gamma_1, \dots, \gamma_r)$.

$z_i - tz_j$	$z_i - tz_j$	$(1-t)z_i$ if $c < d$ $(1-t)z_j$ if $c > d$	$z_i - z_j$ if $c > d$ $t(z_i - z_j)$ if $c < d$
$(1-t)z_i$	$(1-t)z_j$	$t(z_i - z_j)$	$z_i - z_j$

FIGURE 5. The R-matrix. This R-matrix is nearly identical to Figure 6 in [6], with one difference: for the first entry $(++++)$, the R-matrix value is $z_i - tz_j$ here, but $z_j - tz_i$ in [6]. This small difference makes a difference in the quantum group: in [6] the quantum group is a Drinfeld twist of $U_{\sqrt{t}}(\widehat{\mathfrak{gl}}(r|1))$, but this R-matrix is that of $U_{\sqrt{t}}(\widehat{\mathfrak{sl}}(r+1))$. (Compare [23], equation (3.5).)

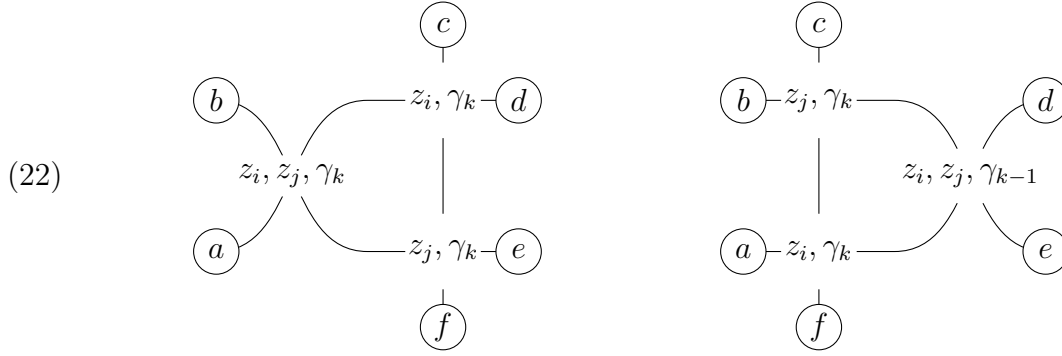


FIGURE 6. Auxiliary Yang-Baxter equations. The auxiliary R-matrix labeled z_i, z_j, γ_k is from Figure 7. Our convention is that $\gamma_0 = \gamma_k$, which agrees with the R-matrix in Figure 5. Note that we are using the monochrome vertices so $c, f \in \Sigma_{v, \gamma_k}^{\text{mon}}$. This Yang-Baxter equation may be proved by direct examination of the possible cases.

The (unfused) colored models, like the uncolored ones, are based on an $r \times N$ grid as in Figure 1, where N is any sufficiently large integer. As in the uncolored model, the columns are labeled in order increasing from right to left. To describe the boundary conditions, we need three pieces of data, a partition λ and two flags \mathbf{c} and \mathbf{d} . It is necessary that each color γ_i occurs equal number of times in \mathbf{c} and \mathbf{d} , since otherwise there will be no states with nonzero Boltzmann weight and the partition function will vanish. We then use the following boundary conditions.

For the horizontal boundary spins on the left edge, we take the boundary value \oplus . For the horizontal spins on the right edge in the i -th row, we take the boundary value d_i . The vertical spins on the bottom row have boundary values the vacuum \ominus . Now for the top boundary spins, in the j -th column we take the boson $\gamma_1^{m_1} \cdots \gamma_r^{m_r}$, where m_k is the number of pairs (λ_i, c_i) with $\lambda_i = j$, and $c_i = \gamma_i$.

To specify the Boltzmann weights, we will make use of a phenomenon previously noted in [6], namely the *monochrome factorization*, which we now explain. There will be two equivalent versions of the model, the colored or *fused* model, based on a grid with rN vertices, and another *unfused* model, in which every vertex of the fused model is replaced by r vertices, and every vertical edge is replaced by r vertical edges. Thus there are a total of r^2N vertices in the unfused model.

Therefore we begin by describing the vertices in the unfused model. Such a vertex is described by two pieces of data: a spectral parameter z_i and a color c . The vertical edge attached to the edge of type z_i, c can only carry the color c . For this reason the edge is described as *monochrome* (of color c). Its spinset $\Sigma_{v, c}^{\text{mon}}$ therefore resembles the uncolored spinset Σ_v^{unc} and is in bijection with \mathbb{N} . As in the uncolored case we will represent the m -th element of $\Sigma_{v, c}^{\text{mon}}$ as \textcircled{m} . The Boltzmann weights of the monochrome vertices are described in Figure 8.

Now we may describe the Boltzmann weights of the general colored vertices by fusion, following the scheme in Figure 9. Every vertex in the colored (fused) model is described by a single spectral parameter z_i . Expanded, it is the fusion of r distinct monochrome vertices of type $z_i, \gamma_r, \dots, z_i, \gamma_1$ arranged in order from left to right. (Our convention is that γ_r the

$z_i - tz_j$	$z_i - tz_j$ $c = d$ allowed.	$t(z_i - z_j)$ if $e > d$ $z_i - z_j$ if $d > e$ $c = d$ or e allowed	$(1-t)z_j$ if $e > c > d$ or $c > d > e$ or $d > e > c$ $(1-t)z_i$ if $d > c > e$ or $c > e > d$ or $e > d > c$
$(1-t)z_j$	$(1-t)z_i$	$t(z_i - z_j)$ $c = d$ allowed	$z_i - z_j$ $c = d$ allowed
	$(1-t)z_i$ $c = d$ allowed	$(1-t)z_j$ $c = d$ allowed	

FIGURE 7. R-vertices for auxiliary Yang-Baxter equations. These are labeled by the spectral parameters z_i , z_j and a color c . Except for the first entry, these weights are identical to the weights in [6], Figure 11, where $z_i - tz_j$ in this paper is replaced by $z_j - tz_i$. This seemingly minor difference changes the quantum group from $U_q(\widehat{\mathfrak{gl}}(1, r))$ in [6] to $U_q(\widehat{\mathfrak{gl}}(r + 1))$ in this paper.

smallest color, so this does not differ from the procedure in [6] – the apparent difference is just notational.)

Now let us use the *fusion* to define the Boltzmann weights for the colored P - and R -models. Let $(a, b, c, d) \in \Sigma_h^{\text{col}} \times \Sigma_v^{\text{col}} \times \Sigma_h^{\text{col}} \times \Sigma_v^{\text{col}}$. We write $b = \gamma_1^{b_1} \cdots \gamma_r^{b_r}$ and $d = \gamma_1^{d_1} \cdots \gamma_r^{d_r}$. Now consider the configuration on the right side of Figure 9. If there is a way of assigning boundary spins to the interior edges such that the spins of the r monochrome vertices are all nonzero, that way is unique, and if so we define the Boltzmann weight at the fused vertex to be the product of the Boltzmann weights at the unfused vertices. If there is no such way of assigning interior spins, the Boltzmann weight is zero.

Proposition 4.1. *The Yang-Baxter equation (Figure 3) is satisfied by the colored weights. For this, use the R-matrix in Figure 5 and the colored weights defined above. The same R-matrix works for both the P- and the R-weights.*

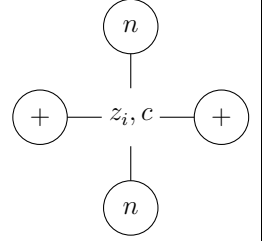
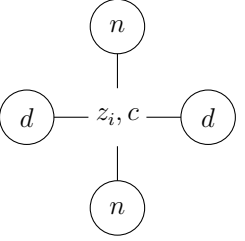
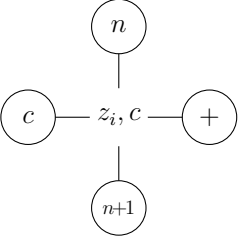
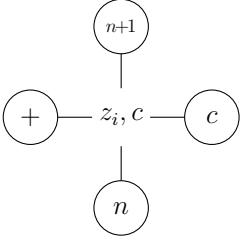
name	$A(n)$	$B(n)$	$C(n)$	$D(n)$
				
P -weights	1	$1 \quad c < d$ $z_i \quad c = d$ $t^n \quad c > d$	$z_i(1 - t^{n+1})$	1
R -weights	1	$1 \quad c < d$ $z_i \quad c = d$ $t^n \quad c > d$	$z_i(1 - t)$	$\frac{1-t^{n+1}}{1-t}$

FIGURE 8. Monochrome vertex type $z_{i,c}$. The vertical edge can carry only the color c . Thus the possible states of the horizontal edges are all colors and $+$. Possible spins of the vertical edges are labeled by integers n , representing n copies of the boson of color c .

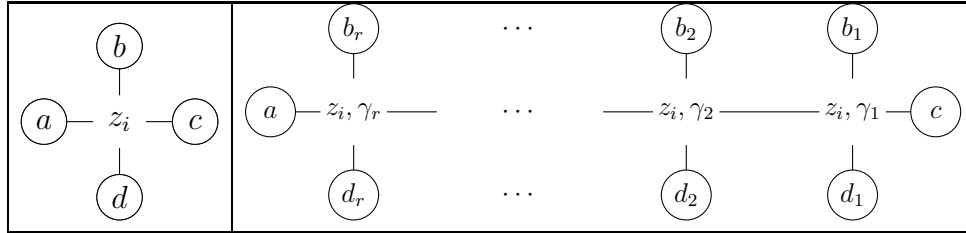


FIGURE 9. Fusion. The colors γ_i are ordered so that $\gamma_r < \gamma_{r-1} < \dots < \gamma_1$, so they are arranged in increasing order from left to right. This procedure replaces a sequence of vertices by a single vertex. Here z_i, γ_i is the “monochrome” vertex from Figure 8. The single fused vertex z_i replaces the r unfused vertices z_i, γ_i . If $b, d \in \Sigma_v^{\text{col}}$ then write $b = \gamma_1^{b_1} \dots \gamma_r^{b_r} \in \Sigma_v^{\text{col}}$ for $(b_1, \dots, b_r) \in \prod_{i=1}^r \Sigma_{v, \gamma_i}^{\text{mon}}$, and similarly write $d = \gamma_1^{d_1} \dots \gamma_r^{d_r} \in \Sigma_v^{\text{col}}$. The Boltzmann weight of the fused vertex (call it v) is just the partition function of the configuration on the right-hand side of the figure. That is, there will be a unique assignment of spins to the internal edges on the left such that the Boltzmann weights are nonzero, and $\beta(v)$ is the product of the Boltzmann weights of the monochrome vertices, from Figure 8.

Proof. We may replace the vertices by the corresponding unfused vertices, and now make use of the auxiliary Yang-Baxter equation in Figure 6. This may be checked by consideration of the possible cases. The auxiliary R-matrix z_i, z_j, γ_k is defined in Figure 7. Note that if $k = r$ this reduces to the R-matrix in Figure 5. The R-matrix changes after moving past the monochrome vertex, but when it has moved past all r vertices, it reverts to its original form. \square

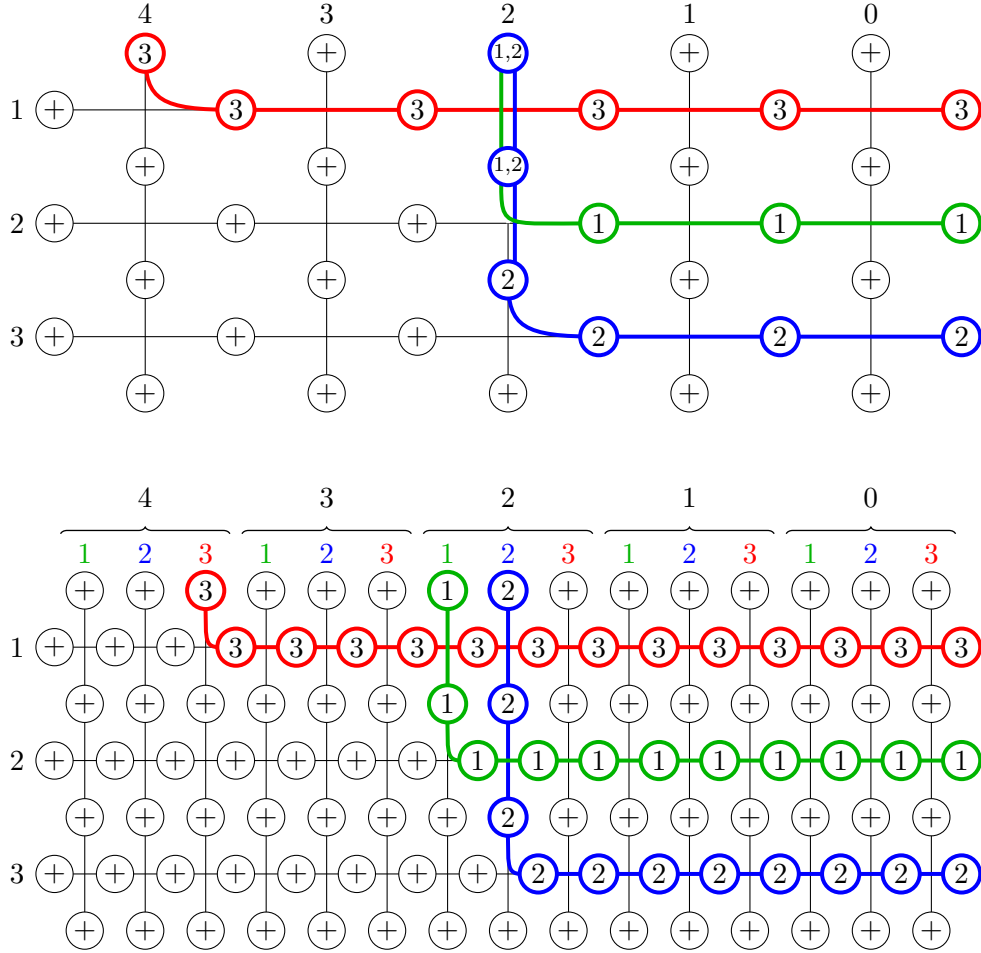


FIGURE 10. The unique state of $\mathfrak{S}_{\lambda, \mathbf{c}, \mathbf{c}}(\mathbf{z})$ for $G = GL_3$ where $\lambda = (4, 2, 2)$, $\mathbf{c} = s_2 \mathbf{c}_0 = (R, B, G)$ and $\mathbf{c}_0 = (\gamma_1, \gamma_2, \gamma_3) = (R, B, G)$. Top: the fused model. Bottom: the corresponding state in the unfused model.

Let us say that a flag $\mathbf{c} = (c_1, \dots, c_r)$ is *proper* if its colors are all distinct. If this is so, since we are working with a palette of only r colors, we must have $\mathbf{c} = w\mathbf{c}_0$ for some w in the symmetric group $W = S_r$, and similarly for \mathbf{d} . For the remainder of the section, we consider models $\mathfrak{S}_{\lambda, \mathbf{c}, \mathbf{d}}(\mathbf{z}; t)$ in which the flags \mathbf{c} and \mathbf{d} are proper. (We will often omit t from the notation.)

Remark 4.2. *If \mathbf{c} and \mathbf{d} are proper, we will use the notation $\mathfrak{S}_{\lambda, \mathbf{c}, \mathbf{d}}(\mathbf{z}; t)$ to denote either model. This is justified because*

$$Z_P(\mathfrak{S}_{\lambda, \mathbf{c}, \mathbf{d}}(\mathbf{z}; t)) = Z_R(\mathfrak{S}_{\lambda, \mathbf{c}, \mathbf{d}}(\mathbf{z}; t)).$$

Proof. Indeed, with this assumption the Boltzmann weights of types $C(n)$ and $D(n)$ in Figure 8 can only appear with $n = 0$, where they are the same in both models. So the Boltzmann weights are the same at every vertex for the P - and R -models. \square

If $\lambda = (\lambda_1, \dots, \lambda_r)$ is a partition, we will denote by W_λ the stabilizer of λ in W .

Proposition 4.3. *Let \mathbf{c} be a proper flag. Write $\mathbf{c} = w\mathbf{c}_0$. Then*

$$Z(\mathfrak{S}_{\lambda, \mathbf{c}, \mathbf{c}}(\mathbf{z}; t)) = t^{\ell(w)} \mathbf{z}^\lambda.$$

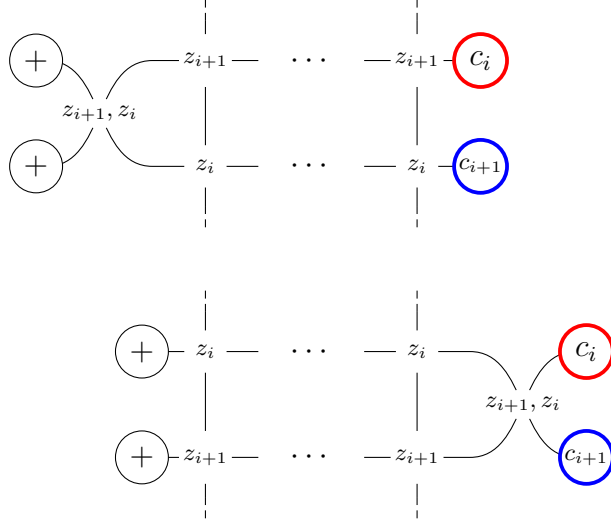


FIGURE 11. Proof of Proposition 4.4. Top: the system $\mathfrak{S}_{\lambda, \mathbf{c}, \mathbf{d}}(s_i \mathbf{z})$ with the R-matrix attached. Bottom: after using the Yang-Baxter equation.

$\begin{array}{cc} \textcircled{+} & \textcircled{+} \\ \diagdown & \diagup \\ z_{i+1}, z_i \end{array}$	$\begin{array}{cc} \textcircled{c_i} & \textcircled{c_i} \\ \diagdown & \diagup \\ z_{i+1}, z_i \end{array}$	$\begin{array}{cc} \textcircled{c_i} & \textcircled{c_{i+1}} \\ \diagdown & \diagup \\ z_{i+1}, z_i \end{array}$
$\begin{array}{cc} \textcircled{+} & \textcircled{+} \\ \diagup & \diagdown \\ z_{i+1}, z_i \end{array}$	$\begin{array}{cc} \textcircled{c_{i+1}} & \textcircled{c_{i+1}} \\ \diagup & \diagdown \\ z_{i+1}, z_i \end{array}$	$\begin{array}{cc} \textcircled{c_{i+1}} & \textcircled{c_i} \\ \diagup & \diagdown \\ z_{i+1}, z_i \end{array}$
$z_{i+1} - tz_i$	$(1-t)z_{i+1}$	$z_{i+1} - z_i$

FIGURE 12. R-values needed in the proof of Proposition 4.4. These may be read off from Figure 5 bearing in mind that $c_i > c_{i+1}$.

Proof. The assumption that $\mathbf{d} = \mathbf{c}$ guarantees that the system $\mathfrak{S}_{\lambda, \mathbf{c}, \mathbf{d}}(\mathbf{z}; t)$ has a unique state whose Boltzmann weight may be computed explicitly. See Figure 10 for an example. \square

Proposition 4.4. *Let \mathbf{c}, \mathbf{d} be a proper flags, and write $\mathbf{d} = w\mathbf{c}_0$ with $w \in W$. Let $s = s_i$ be the simple reflection $(i, i+1) \in W$. Then*

$$Z(\mathfrak{S}_{\lambda, \mathbf{c}, s_i \mathbf{d}}(\mathbf{z}; t)) = \begin{cases} \mathcal{L}_{i,t} Z(\mathfrak{S}_{\lambda, \mathbf{c}, \mathbf{d}}(\mathbf{z}; t)) & \text{if } s_i w > w, \\ \mathcal{L}_{i,t}^{-1} Z(\mathfrak{S}_{\lambda, \mathbf{c}, \mathbf{d}}(\mathbf{z}; t)) & \text{if } s_i w < w. \end{cases}$$

Proof. To simplify the notation we will write $\phi_w(\mathbf{z}) = Z(\mathfrak{S}_{\lambda, \mathbf{c}, w\mathbf{c}_0}(\mathbf{z}; t))$, so what we are trying to prove is that if $s_i w > w$ then $\phi_{s_i w} = \mathcal{L}_{i,t} \phi_w$ if $s_i w > w$. We consider the system $\mathfrak{S}_{\lambda, \mathbf{c}, \mathbf{d}}(s_i \mathbf{z}; t)$ where the effect of the s_i is to switch z_i and z_{i+1} . We attach the R-matrix to the left as in Figure 11. The meaning of the assumption $s_i w > w$ is that the color $c_i = c_{w^{-1}\gamma_i}$ is $> c_{i+1}$. These colors are red and blue, respectively in Figure 11. Referring to the figure the R-matrix on the left-hand side has only one possible state, while the R-matrix on the right has two. The values we need are in Figure 12. We obtain

$$(z_{i+1} - tz_i)\phi_w(s_i \mathbf{z}) = (1-t)z_{i+1}\phi_w(\mathbf{z}) + (z_{i+1} - z_i)\phi_{s_i w}(\mathbf{z}).$$

Rearranging,

$$\phi_{s_i w}(\mathbf{z}) = \frac{\phi_w(\mathbf{z}) - \phi_{s_i w}(s_i \mathbf{z}) - t(\phi_w(\mathbf{z}) - \mathbf{z}^{\alpha_i} \phi_w(s_i \mathbf{z}))}{\mathbf{z}^{\alpha_i} - 1}, \quad \mathbf{z}^{\alpha_i} = z_i / z_{i+1},$$

which is $\mathcal{L}_{i,t} \phi_w(\mathbf{z})$. □

Theorem 4.5. *Let $w \in W$. Then*

$$Z(\mathfrak{S}_{\lambda, c_0, w c_0}(\mathbf{z}; t)) = \mathcal{L}_{w,t} \mathbf{z}^\lambda.$$

More generally, if $w, y \in W$, then

$$Z(\mathfrak{S}_{\lambda, y c_0, w c_0}(\mathbf{z}; t)) = \tau_{w,y}^\lambda(\mathbf{z}; t)$$

where $\tau_{w,y}^\lambda$ is as in Theorem 2.8.

Proof. This follows immediately from the last two propositions and Theorem 2.8. □

5. THE LOCAL LIFTING PROPERTY

In this section we will prove the local lifting property for the R -weights, which is a relationship between the colored and uncolored models. The local lifting property is the analog of Properties A and B in [6], Section 8. As in that paper, the local lifting property has implications for the (global) partition functions. In particular, we will here apply it to reprove Korff's evaluation of the uncolored lattice models.

The P -weights also have a lifting property, but it is less strictly local, since it concerns column transfer matrices instead of individual vertices. The local lifting property as formulated here is strictly for the R -weights.

To formulate the local lifting property for the R -weights, we make use of both the (fused) colored and the uncolored spinsets for horizontal and vertical edges. We define maps $p_h : \Sigma_h^{\text{col}} \rightarrow \Sigma_h^{\text{unc}}$ and $p_v : \Sigma_v^{\text{col}} \rightarrow \Sigma_v^{\text{unc}}$. Specifically, $p_h : \Sigma_h^{\text{col}} \rightarrow \Sigma_h^{\text{unc}}$ is the map

$$p_h(+) = +, \quad p_h(c_i) = -,$$

and $p_v : \Sigma_v^{\text{col}} \rightarrow \Sigma_v^{\text{unc}}$ is the map that sends

$$\gamma_1^{m_1} \cdots \gamma_r^{m_r} \in \Sigma_v^{\text{col}} \quad \text{to} \quad \sum_{i=1}^r m_i \in \Sigma_h^{\text{unc}}.$$

Intuitively, these maps just change every colored boson to the uncolored boson represented by $-$ in the uncolored model.

Proposition 5.1. *Let $(A, B, C, D) \in \Sigma_h^{\text{unc}} \times \Sigma_v^{\text{unc}} \times \Sigma_h^{\text{unc}} \times \Sigma_v^{\text{unc}}$, and let $(a, b) \in \Sigma_h^{\text{col}} \times \Sigma_v^{\text{col}}$ such that $p_h(a) = A$ and $p_v(b) = B$. Then*

$$(23) \quad \beta_R^{\text{unc}} \left(\begin{array}{c} \textcircled{B} \\ | \\ \textcircled{A} \text{---} \textcircled{C} \\ | \\ \textcircled{D} \end{array} \right) = \sum_{\substack{(c,d) \in \Sigma_h^{\text{col}} \times \Sigma_v^{\text{col}} \\ p_h(c)=C \\ p_v(d)=D}} \beta_R^{\text{col}} \left(\begin{array}{c} \textcircled{b} \\ | \\ \textcircled{a} \text{---} \textcircled{c} \\ | \\ \textcircled{d} \end{array} \right).$$

before applying p''		after p''
zt^m	$z(1-t^m)$	z
z	z	z
t^{n+m} if $G < R, B$, 1 if $G > R, B$	t^{n+m} if $G < R, B$, 1 if $G > R, B$	t^{n+m} if $G < R, B$, 1 if $G > R, B$
$z(1-t)$	$z(1-t)$	$z(1-t)$
$z(1-t)$	$z(1-t)$	$z(1-t)$
$\frac{1-t^n}{1-t} t^m$	$\frac{1-t^m}{1-t}$	$\frac{1-t^{n+m}}{1-t}$
1	1	1

FIGURE 13. Verifying the local lifting property for the maps $p''_{i,h}$ and $p''_{i,v}$. This shows the *unfused* vertices in the columns of the monochrome edges for γ_i, γ_{i+1} . The monochrome vertex for the color γ_{i+1} (blue) is on the left, and the monochrome vertex for the color γ_i (red) is on the right. The maps $p_{i,h}$ and $p_{i+1,v}$ replace the color γ_{i+1} with γ_i , and the case-by-case analysis confirms that this procedure does not affect the Boltzmann weights. In the third row, green is any color that is not γ_i or γ_{i+1} .

Proof. First, we note that the uncolored R -weights actually coincide with the colored R -weights using only one color c . So we may work instead with maps $p'_h : \Sigma_h^{\text{col}} \rightarrow \Sigma_h^{\text{col}}$ and

$p'_v : \Sigma_v^{\text{col}} \longrightarrow \Sigma_v^{\text{col}}$ that replace every color by γ_1 . Thus

$$p'_h(+) = +, \quad p'_h(\gamma_i) = \gamma_1,$$

and p'_v

$$\gamma_1^{m_1} \cdots \gamma_r^{m_r} \in \Sigma_v^{\text{col}} \quad \text{to} \quad \gamma_1^m \in \Sigma_h^{\text{unc}}, \quad m = \sum_{i=1}^r c_i.$$

We may verify by comparing the weights in Figure 2 with the colored weights using only one color that if $(a, b, c, d) \in \Sigma_h^{\text{col}} \times \Sigma_v^{\text{col}} \times \Sigma_h^{\text{col}} \times \Sigma_v^{\text{col}}$ then the Boltzmann weights of $(p_h(a), p_v(b), p_h(c), p_v(d)) \in \Sigma_h^{\text{unc}} \times \Sigma_v^{\text{unc}} \times \Sigma_h^{\text{unc}} \times \Sigma_v^{\text{unc}}$ and $(p'_h(a), p'_v(b), p'_h(c), p'_v(d)) \in \Sigma_h^{\text{col}} \times \Sigma_v^{\text{col}} \times \Sigma_h^{\text{col}} \times \Sigma_v^{\text{col}}$ are the same. (To confirm this, observe that in the unfused weights corresponding to the fused weights $p'_v(b)$ and $p'_v(d)$ we may optionally discard the monochrome vertices for colors c_i with $i \neq 1$, since the Boltzmann weights at these vertices all equal 1.)

Now p' maps may themselves be factored into maps that change only one color at a time. Thus we consider the maps $p''_{i,h} : \Sigma_h^{\text{col}} \longrightarrow \Sigma_h^{\text{col}}$ and $p''_{i,v} : \Sigma_v^{\text{col}} \longrightarrow \Sigma_v^{\text{col}}$ that replace the color c_{i+1} by c_i , and leave the other colors c_j unaltered.

The maps $p''_{i,h}$ and $p''_{i,v}$ have the following local lifting property: if $(A, B, C, D) \in \Sigma_h^{\text{col}} \times \Sigma_v^{\text{col}} \times \Sigma_h^{\text{col}} \times \Sigma_v^{\text{col}}$ and $(a, b) \in \Sigma_h^{\text{col}} \times \Sigma_v^{\text{col}}$ such that $p''_{i,h}(a) = A$ and $p''_{i,v}(b) = B$, then

$$\beta_R^{\text{col}} \left(\begin{array}{ccc} & \textcircled{B} & \\ \textcircled{A} & \text{---} & \textcircled{C} \\ & \textcircled{D} & \end{array} \right) = \sum_{\substack{(c,d) \in \Sigma_h^{\text{col}} \times \Sigma_v^{\text{col}} \\ p''_{i,h}(c) = C \\ p''_{i,v}(d) = D}} \beta_R^{\text{col}} \left(\begin{array}{ccc} & \textcircled{b} & \\ \textcircled{a} & \text{---} & \textcircled{c} \\ & \textcircled{d} & \end{array} \right).$$

Now $p'_h = p''_{1,h} \circ \cdots \circ p''_{r-1,h}$ and $p'_v = p''_{1,v} \circ \cdots \circ p''_{r-1,v}$ has a local lifting property. Replacing the color c_1 by $+$ and (in the monochrome model) deleting the vertices labeled c_2, \dots, c_r we obtain the local lifting property for p_h and p_v . \square

The local lifting result implies the following *global lifting* property for partition functions. Using the maps p_h and p_v we may construct a map $\mathfrak{s} \mapsto p(\mathfrak{s})$ from states of the colored model $\mathfrak{S}_{\lambda, \mathbf{c}}(F; t)$, to the uncolored model $\mathfrak{S}_{\lambda}(\mathbf{z}; t)$. We simply apply p_h and p_v to the spins of every edge in \mathfrak{s} , obtaining a state of $\mathfrak{S}_{\lambda}(\mathbf{z}; t)$.

If \mathbf{c} is a flag let

$$\mathfrak{S}_{\lambda, \mathbf{c}}^{\text{col}}(\mathbf{z}; t) = \bigcup_{\mathbf{d}} \mathfrak{S}_{\lambda, \mathbf{c}, \mathbf{d}}^{\text{col}}(\mathbf{z}; t).$$

It is the disjoint union of all states with prescribed flag on the upper boundary, but arbitrary flag on the right boundary.

Proposition 5.2. *Let \mathfrak{s}_0 be a state of $\mathfrak{S}_{\lambda}(\mathbf{z}; t)$. Let \mathbf{c} be a flag.*

$$\beta_R^{\text{unc}}(\mathfrak{s}_0) = \sum_{\substack{\mathfrak{s} \in \mathfrak{S}_{\lambda, \mathbf{c}}^{\text{col}}(\mathbf{z}; t) \\ p(\mathfrak{s}) = \mathfrak{s}_0}} \beta_R^{\text{col}}(\mathfrak{s}).$$

Proof. A formal proof follows the method of Lemma 8.5 of [6], and we refer to that proof for details, giving here a brief intuitive explanation. We may construct all the liftings \mathfrak{s} of the state \mathfrak{s}_0 to $\mathfrak{S}_{\lambda, \mathbf{c}}^{\text{col}}(\mathbf{z}; t)$ algorithmically by assigning colored spins to the edges right and below each vertex, visiting the vertices in order, row by row, from left to right. In this procedure,

as each vertex is considered, the spins to the left and above the vertex are known either because of the condition that $\mathfrak{s} \in \mathfrak{S}_{\lambda, \mathbf{c}}^{\text{col}}(\mathbf{z}; t)$, which determines the left and top boundary spins, or because the spins above and left of the vertex have already been assigned at an earlier stage of the algorithm. Thus at the vertex under consideration if the spins of the adjacent edges are labeled a, b, c, d as in Proposition 5.1, the vertices a, b are known, while c and d must satisfy $p_h(c) = C$, $p_v(d) = D$, where C and D are the corresponding spins of the state \mathfrak{s}_0 , due to the requirement that $p(\mathfrak{s}) = \mathfrak{s}_0$. We see that the possible values for the spins at the given vertex are exactly those on the right-hand side of (23), and taking this into account, the sum of the Boltzmann weights of the possible configurations at the vertex equals the Boltzmann weight of the vertex in the corresponding uncolored state \mathfrak{s}_0 . The result follows from this observation. See Section 8 of [6] for a formal argument. \square

Corollary 5.3. *Let \mathbf{c} be any flag. Then*

$$Z_R(\mathfrak{S}_{\lambda}^{\text{unc}}(\mathbf{z}; t)) = \sum_{\mathbf{d}} Z_R(\mathfrak{S}_{\lambda, \mathbf{c}, \mathbf{d}}^{\text{col}}(\mathbf{z}; t)).$$

We emphasize that this statement is for the R -models only, and fails for the P -models, since the local lifting property is only valid for the R -models.

Proof. This follows from Proposition 5.2 by summing over all states \mathfrak{s}_0 of $\mathfrak{S}_{\lambda}^{\text{unc}}(\mathbf{z}; t)$. \square

Proof of Theorem 3.3 (part 2). Let us apply Corollary 5.3 in the special case where the flag \mathbf{c} equals $\mathbf{c}_0 = (\gamma_1, \dots, \gamma_r)$. Then using Theorem 4.5 and Proposition 2.7,

$$Z_R(\mathfrak{S}_{\lambda}^{\text{unc}}(\mathbf{z}; t)) = \sum_{w \in W} Z_R(\mathfrak{S}_{\lambda, \mathbf{c}_0, w\mathbf{c}_0}^{\text{unc}}(\mathbf{z}; t)) = \sum_{w \in W} \mathcal{L}_{w, t} \mathbf{z}^{\lambda} = R_{\lambda}(\mathbf{z}; t),$$

which is the second equation in (20). We have already shown that the two evaluations are equivalent. \square

6. SPHERICAL MODELS OF p -ADIC REPRESENTATIONS

Let F be a nonarchimedean local field with ring \mathfrak{o} of integers, and prime ideal \mathfrak{p} with a chosen generator ϖ . Let q be the cardinality of the residue field $\mathfrak{o}/\mathfrak{p}$. Let $G(F) = \text{GL}_r(F)$, with $K = \text{GL}_r(\mathfrak{o})$ a maximal compact subgroup. We will denote by J the Iwahori subgroup of K consisting of elements that are upper triangular modulo \mathfrak{p} . It will be convenient to identify the Weyl group $W \cong S_r$ of G with the subgroup of G consisting of permutation matrices. With this choice, every element of W is actually in K .

Let T be the *standard maximal torus* of the affine algebraic group $G = \text{GL}_r$, so $T(F)$ consists of diagonal matrices in $G(F)$. Let B be the *standard Borel subgroup* of upper triangular matrices. Let N be the unipotent radical of B consisting of unipotent upper triangular matrices, so $B = TN$.

The Langlands dual group \hat{G} is just $\text{GL}_r(\mathbb{C})$. We will denote $\Lambda = \mathbb{Z}^r$; it may be thought of as the weight lattice of \hat{G} . Let \hat{T} be the diagonal subgroup of the Langlands dual group $\text{GL}_r(\mathbb{C})$. We will identify $\hat{T} = (\mathbb{C}^{\times})^r$ in the obvious way, so an element $\mathbf{z} \in \hat{T}$ can be identified with a tuple $\mathbf{z} = (z_1, \dots, z_r)$ with $z_i \in \mathbb{C}^{\times}$. If $\mathbf{z} \in \hat{T}$ and $\lambda \in \Lambda$ we will denote by $\mathbf{z}^{\lambda} = \prod z_i^{\lambda_i}$. In particular if Φ is the root system of \hat{G} , and if $\alpha_1, \dots, \alpha_{r-1}$ are the simple roots, then $\mathbf{z}^{\alpha_i} = z_i/z_{i+1}$.

The lattice Λ may also be thought of as the coweight lattice of GL_r , which is isomorphic to $T(F)/T(\mathfrak{o})$. Thus if $\lambda \in \Lambda$ let $\varpi^{\lambda} = \text{diag}(\varpi^{\lambda_1}, \dots, \varpi^{\lambda_r}) \in T(F)$. A quasicharacter of $T(F)$

is *unramified* if it is trivial on $T(\mathfrak{o})$. Given $\mathbf{z} \in \hat{T}$ there is a unique unramified quasicharacter $\chi_{\mathbf{z}} : T(F) \rightarrow \mathbb{C}^\times$ such that $\chi_{\mathbf{z}}(\varpi^\lambda) = \mathbf{z}^\lambda$. We may extend it to a homomorphism $B(F) \rightarrow \mathbb{C}^\times$ by letting $N(F)$ be in the kernel. Let δ be the modular quasicharacter on $B(F)$.

The *unramified principal series representations* are the representations of $G(F)$ induced from these characters. Thus $I(\mathbf{z})$ denotes the space of functions f on $G(F)$ that are smooth (locally constant) and that satisfy $f(bg) = (\delta^{1/2}\chi_{\mathbf{z}}(b))f(g)$ for $b \in B(F)$. The action of $G(F)$ on this space is by right translation. The representation $I(\mathbf{z})$ is irreducible if \mathbf{z} is in general position, and if it is irreducible, $I(w\mathbf{z}) \cong I(\mathbf{z})$ for $w \in W$, due to the existence of intertwining integrals $\mathcal{A}_w^{\mathbf{z}} : I(\mathbf{z}) \rightarrow I(w\mathbf{z})$ ([16, 15]). These are defined by

$$\mathcal{A}_w^{\mathbf{z}} f(g) = \int_{N \cap wN^-w^{-1}} f(w^{-1}ng) dn,$$

where N^- is the group of unipotent lower triangular matrices. The integral is only convergent for \mathbf{z} in an open subset of \hat{T} , but can be extended by analytic continuation to the regular elements of \hat{T} .

We will follow the approach of Brubaker, Bump and Friedberg [11], where the action of the Hecke algebra by Demazure-Lusztig operators is related to the Iwahori fixed vectors in the spherical model. The proof relies on results of Casselman [15]. The results of Ion [21] are also closely related.

There is an error in [11], where Proposition 1 is only correct as stated if λ is antidominant. Moreover for the application the constant $c(\lambda)$ in the Proposition needs to be evaluated. See Propositions 6.3 and 6.6 and Remark 6.7.

We will write $g = (g_{ij})$ as a matrix, and if $I \subset \{1, 2, \dots, r\}$ we will write $a_I = a_I(g)$ for the minor of k formed with entries taken from the columns in I , and the last $|I|$ rows of k . For example if $n = 4$ and $I = \{1, 3\}$ then

$$a_I(g) = \begin{vmatrix} g_{31} & g_{33} \\ g_{41} & g_{43} \end{vmatrix}.$$

If $1 \leq m \leq r$, we will denote by I_m the particular subset $\{r - m + 1, r - m + 2, \dots, r\}$.

Lemma 6.1. *Let $g \in \mathrm{GL}_r(F)$. A necessary and sufficient condition for $g \in BJ$ is that for $1 \leq m \leq r$, and for every m element subset I of $\{1, 2, \dots, r\}$ except I_m , we have $a_{I_m}(g)^{-1}a_I(g) \in \mathfrak{p}$. Assuming this, $g \in NJ$ if and only if $a_{I_m}(g) \in \mathfrak{o}^\times$, so that $a_I(g) \in \mathfrak{p}$ when $|I| = m$ but $I \neq I_m$.*

Proof. We leave this to the reader. □

Let λ be a dominant partition, that is, a partition with no repeated parts. Let

$$J_\lambda = \{(k_{ij}) \in K \mid k_{ij} \in \mathfrak{p}^{1+\lambda_i-\lambda_j} \text{ when } i > j.\}$$

This is clearly a subgroup of J .

Lemma 6.2. *Assume that λ is dominant. Then the index of J_λ in J is $q^{(\lambda, 2\rho)}$.*

Proof. This group has an Iwahori factorization ([16] Section 1.4), which means in this particular case that we can write $J_\lambda = (N_-(\mathfrak{p}) \cap J_\lambda)B(\mathfrak{o})$. From this we can compute

$$(24) \quad [J : J_\lambda] = [N_-(\mathfrak{p}) : N_-(\mathfrak{p}) \cap J_\lambda] = \prod_{i>j} q^{\lambda_i-\lambda_j} = q^{(\lambda, 2\rho)}. \quad \square$$

Proposition 6.3. *Suppose that λ is antidominant. Then*

$$\{k \in K | \varpi^{-\lambda} k \varpi^\lambda \in BJ\} = J_{-\lambda}.$$

This is thus a subgroup of J , of index $q^{(-\lambda, 2\rho)}$.

Proof. Since BJ is not a group, it is not *a priori* clear that $\{k \in K | \varpi^{-\lambda} k \varpi^\lambda \in BJ\}$ is a group. We will show that if $k \in K$ and $\varpi^{-\lambda} k \varpi^\lambda \in BJ$, then $\varpi^{-\lambda} k \varpi^\lambda \in NJ$. Let $a_I(k)$ be the minors as above. We will also denote $S(\lambda, I) = \sum_{j \in I} \lambda_j$. We have

$$a_I(\varpi^{-\lambda} k \varpi^\lambda) = \varpi^{S(\lambda, I) - S(\lambda, I_m)} a_I(k).$$

If $I \neq I_m$, by Lemma 6.1 that $a_I(\varpi^{-\lambda} k \varpi^\lambda) \in \mathfrak{p}$ because $\varpi^{-\lambda} k \varpi^\lambda \in BJ$. Let $N_I = S(\lambda, I_m) - S(\lambda, I)$. Then $N_I \geq 0$ since λ is antidominant, so $a_I(k) = \varpi^{N_I} a_I(\varpi^{-\lambda} k \varpi^\lambda)$. In particular $a_I(k) \in \mathfrak{p}$.

With m fixed, the minors $a_I(k)$ with $|I| = m$ are coprime, since $k \in \mathrm{GL}_r(\mathfrak{o})$. We have shown that if $I \neq I_m$ then $a_I(k) \in \mathfrak{p}$ and it follows that $a_{I_m}(k)$ is a unit. But $a_{I_m}(\varpi^{-\lambda} k \varpi^\lambda) = a_{I_m}(k)$ and by Lemma 6.1, we learn that $\varpi^{-\lambda} k \varpi^\lambda \in NJ$.

Since $a_I(k) \in \mathfrak{p}$ for all $I \neq I_m$, the set $\{k \in K | \varpi^{-\lambda} k \varpi^\lambda \in BJ\}$ is contained in J , and we have proved that if g is in this set then $a_I(g)$ is in $\mathfrak{p}^{1+S(\lambda, I_m) - S(\lambda, I)}$. Furthermore, its diagonal entries are units. This implies that it is contained in $J_{-\lambda}$. The index is given by Lemma 6.2. \square

Let $\phi_w^{\mathbf{z}}$ be the basis of Iwahori fixed vectors in $I(\mathbf{z})$ defined by

$$\phi_w^{\mathbf{z}}(bw'k) = \begin{cases} \delta^{1/2} \chi_{\mathbf{z}}(b) & \text{if } w = w', \\ 0 & \text{otherwise,} \end{cases}$$

for $w, w' \in W$, $b \in B(F)$ and $k \in J$. Note that every element of $G(F)$ is in $B(F)w'J$ for a unique $w' \in W$, so this definition makes sense. Let $\phi_{\circ}^{\mathbf{z}}$ be the K -fixed vector, so

$$\phi_{\circ}^{\mathbf{z}}(bk) = \delta^{1/2} \chi_{\mathbf{z}}(b), \quad b \in B(F), k \in K.$$

We normalize the Haar integral so that J has volume 1, and K has volume

$$\sum_{w \in W} q^{\ell(w)} = \prod_{i=1}^r \frac{q^i - 1}{q - 1}.$$

Let $\mathcal{S}^{\mathbf{z}} : I(\mathbf{z}) \rightarrow \mathbb{C}$ be the spherical functional:

$$\mathcal{S}^{\mathbf{z}}(\phi) = \int_K \phi(k) dk$$

and for $w \in W$ let $\sigma_w^{\mathbf{z}} : G(F) \rightarrow \mathbb{C}$ be the function

$$\sigma_w^{\mathbf{z}}(g) = \mathcal{S}^{\mathbf{z}}(\pi_{\mathbf{z}}(g)\phi_w^{\mathbf{z}}) = \int_K \phi_w^{\mathbf{z}}(kg) dk.$$

The *spherical function* is defined by

$$\sigma_{\circ}^{\mathbf{z}}(g) = \mathcal{S}^{\mathbf{z}}(\pi_{\mathbf{z}}(g)\phi_{\circ}^{\mathbf{z}}) = \int_K \phi_{\circ}^{\mathbf{z}}(kg) dk.$$

It is both left and right invariant by K .

Theorem 6.4. *Let $w \in W$ and let s_i be a simple reflection such that $s_i w > w$. Then*

$$(25) \quad \sigma_{sw}^{\mathbf{z}}(g) = \mathcal{L}_{i,q} \sigma_w^{\mathbf{z}}(g).$$

Assume that λ is dominant. Then

$$(26) \quad \sigma_w^{\mathbf{z}}(\varpi^{w_0\lambda}) = q^{-\langle \lambda, \rho \rangle} \mathcal{L}_{w,q} \mathbf{z}^{w_0\lambda}.$$

Proof. The recursion (25) is proved in [11], Theorem 1, based on results of Casselman [15]. It is equivalent to [21], Proposition 5.8.

Now (26) follows by induction on $\ell(w)$ provided we first establish the base case where $w = 1$. Let $\mu = w_0\lambda$, so μ is antidominant. Then

$$\sigma_1^{\mathbf{z}}(\varpi^{w_0\lambda}) = \int_K \phi_1(k\varpi^\mu) dk = \delta^{1/2} \chi(\varpi^\mu) \int_K \phi_1(\varpi^{-\mu} k \varpi^\mu) dk.$$

We are normalizing the Haar measure so the volume of J is 1. By Proposition 6.3, the integrand is nonzero if and only if $\varpi^{-\mu} k \varpi^\mu \in BJ$ and since μ is antidominant, the condition for this is that $\varpi^{-\mu} k \varpi^\mu \in J_{-w_0\lambda}$, so the contribution is the volume $q^{-2\langle \rho, w_0\lambda \rangle} = q^{2\langle \rho, \lambda \rangle}$, which is the reciprocal of $J : J_{-w_0(\lambda)}$. On the other hand $\delta^{1/2}(\varpi^\mu) = q^{-\langle \rho, \mu \rangle} = q^{\langle \rho, \lambda \rangle}$, while $\chi_{\mathbf{z}}(\varpi^\mu) = \mathbf{z}^\mu = \mathbf{z}^{w_0\lambda}$. Thus we have the *base case*

$$\sigma_1^{\mathbf{z}}(\varpi^{w_0\lambda}) = q^{-\langle \lambda, \rho \rangle} \mathbf{z}^{w_0\lambda}.$$

This proves (26) when $w = 1$. □

We may now give a proof of the Macdonald formula.

Theorem 6.5 (Macdonald [27, 28, 15]). *Let λ be dominant. Then*

$$(27) \quad \sigma_{\circ}^{\mathbf{z}}(\varpi^\lambda) = q^{|\Phi^+|} q^{-\langle \lambda, \rho \rangle} R_\lambda(\mathbf{z}; q^{-1}).$$

Proof. Since $\sigma_{\circ}^{\mathbf{z}}$ is K -bi-invariant,

$$\sigma_{\circ}^{\mathbf{z}}(\varpi^\lambda) = \sigma_{\circ}^{\mathbf{z}}(w_0 \varpi^\lambda w_0^{-1}) = \sigma_{\circ}^{\mathbf{z}}(\varpi^{w_0\lambda})$$

Summing (26) over $w \in W$ and applying Proposition 2.7 and Proposition 2.5 gives

$$\sigma_{\circ}^{\mathbf{z}}(\varpi^{w_0\lambda}) = q^{-\langle \lambda, \rho \rangle} \Omega \left(\prod_{\alpha \in \Phi^+} (1 - q\mathbf{z}^{-\alpha}) \mathbf{z}^{w_0\lambda} \right) = q^{|\Phi^+|} q^{-\langle \lambda, \rho \rangle} R_\lambda(\mathbf{z}; q^{-1}). \quad \square$$

Proposition 6.6. *Suppose that $\lambda \in \Lambda$ and let $y \in W$ be such that $y(\lambda)$ is antidominant. Suppose that $k \in K$ such that $k\varpi^\lambda \in ByJ$. Then $\varpi^{-y(\lambda)} k \varpi^\lambda \in NK$.*

Proof. If α is a root, we will denote by $x_\alpha : F \rightarrow \mathrm{GL}_r$ the one-parameter subgroup corresponding to α . We may write $k\varpi^\lambda = \varpi^\mu n y j$ where $\mu \in \Lambda$, $n \in N$ and $j \in J$. We will show that $\mu = y(\lambda)$.

Using the Iwahori factorization ([16], we may write j as a product of an element t of $T(\mathfrak{o})$ and elements of the form $x_\alpha(u_\alpha)$ where $\alpha \in \Phi$ and $u_\alpha \in \mathfrak{o}$. (Actually $u_\alpha \in \mathfrak{p}$ if α is a negative root.) We may choose the order of these factors so that the factors where $y(\alpha)$ is a positive root are to the left of those for which it is a negative root. If $y(\alpha) \in \Phi^+$ we may conjugate $x_\alpha(u_\alpha)$ by y and absorb it into n , so we may write

$$k\varpi^\lambda = \varpi^\mu n y j_0 t, \quad t \in T(\mathfrak{o}), n \in N, j_0 = \prod_{\substack{\alpha \in \Phi \\ y(\alpha) \in \Phi^-}} x_\alpha(u_\alpha).$$

Now with $y(\alpha) \in \Phi^-$ we have

$$\varpi^\lambda x_\alpha(u_\alpha) \varpi^{-\lambda} = x_\alpha(\varpi^{\langle \alpha^\vee, \lambda \rangle} u_\alpha) = x_\alpha(\varpi^{\langle y(\alpha)^\vee, y(\lambda) \rangle} u_\alpha) \in K,$$

because $y(\lambda)$ is antidominant so $\langle y(\alpha)^\vee, y(\lambda) \rangle \geq 0$. Thus $\varpi^\lambda j_0 \varpi^{-\lambda} \in K$. Thus $k = \varpi^{\mu - y(\lambda)} n' \varpi^\lambda j_0 \varpi^{-\lambda}$ where $n' \in N$, which implies that $\varpi^{\mu - y(\lambda)} n' \in K$. This is possible only if $\mu = y(\lambda)$. Thus $\varpi^{-y(\lambda)} k \varpi^\lambda \in NK$. \square

Remark 6.7. *If we assume that y is minimal such that $y(\lambda)$ is antidominant, a refinement of this proof shows that $\varpi^{-y(\lambda)} k \varpi^\lambda \in NyJ$. We do not need this, so we do not prove it.*

We are normalizing the inner product on Λ so that the roots have length $\sqrt{2}$. With this normalization

$$\delta(\varpi^\lambda) = q^{-\langle 2\rho, \lambda \rangle}.$$

Theorem 6.8. *Let $\lambda \in \Lambda$ and let $y \in W$ be the element of minimal length such that $y(\lambda)$ is antidominant. Then for any $w \in W$ we have*

$$(28) \quad \sigma_w(\varpi^\lambda) = q^{-\langle \rho, \lambda \rangle} \tau_{w,y}^{y(\lambda)}(\mathbf{z}; q).$$

Equivalently,

$$(29) \quad \sigma_w(\varpi^\lambda) = q^{-\langle \rho, \lambda \rangle} q^{|\Phi^+|} \tau_{w w_0, y w_0}^{-y(\lambda)}(\mathbf{z}^{-1}, q^{-1}).$$

Proof. Note that (28) and (29) are equivalent by (14). We will prove (28). First we show that

$$(30) \quad \sigma_y(\varpi^\lambda) = v(\lambda, q) q^{\ell(y)} \mathbf{z}^{y(\lambda)}$$

where the constant $v(\lambda, q)$ is independent of \mathbf{z} ; later we will evaluate this constant. We have

$$\sigma_y(\varpi^\lambda) = \int_K \phi_y(k \varpi^\lambda) dk.$$

If $\phi_y(k \varpi^\lambda)$ is nonzero, then $k \varpi^\lambda \in ByJ$ and so by Proposition 6.6 we have $\varpi^{-y(\lambda)} k \varpi^\lambda \in NK$. It follows that

$$\phi_y(k \varpi^\lambda) = \delta^{1/2} \chi_{\mathbf{z}}(\varpi^{y(\lambda)}) \phi_y(\varpi^{-y(\lambda)} k \varpi^\lambda) = q^{-\langle \rho, y(\lambda) \rangle} \mathbf{z}^{w(\lambda)}.$$

Therefore

$$\sigma_y(\varpi^\lambda) = q^{-\langle \rho, y(\lambda) \rangle} \mathbf{z}^{y(\lambda)} \cdot V$$

where V is the volume of $\{k \in K | k \varpi^\lambda \in ByJ\}$. Therefore (30) is valid with

$$v(\lambda, q) = q^{\langle \rho, y(\lambda) \rangle} q^{\ell(y)} / V.$$

Now using Theorem 6.4 and the definition of τ (implicit in Theorem 2.8) we obtain

$$(31) \quad \sigma_w(\varpi^\lambda) = v(\lambda, q) \tau_{w,y}^{y(\lambda)}(\mathbf{z}; q)$$

for all $w \in W$. We may now evaluate the constant $v(\lambda, q)$ as follows. Since $y(\lambda)$ is antidominant, summing this identity over all $w \in W$ and using (13) gives

$$\sigma_\circ(\varpi^\lambda) = v(\lambda, q) q^{|\Phi^+|} R_{w_0 y(\lambda)}(\mathbf{z}; q^{-1}).$$

On the other hand since $w_0 y(\lambda)$ is dominant, by (27) we have

$$\sigma_\circ(\varpi^{w_0 y(\lambda)}) = q^{|\Phi^+|} q^{-\langle \lambda, \rho \rangle} R_{w_0 y(\lambda)}(\mathbf{z}; q^{-1}).$$

Now the spherical function σ_\circ is K -bi-invariant, so $\sigma_\circ(\varpi^\lambda) = \sigma_\circ(\varpi^{w_0y(\lambda)})$ and so

$$v(\lambda, \rho) = q^{-\langle \lambda, \rho \rangle}.$$

Combining this with (31) proves (28). □

We would now like to compare this with the partition functions of the colored models.

Theorem 6.9. *Let λ be a weight, and let $y \in W$ be minimal such that $y(\lambda)$ is antidominant. Then*

$$(32) \quad \sigma_w(\mathbf{z}^\lambda) = q^{-\langle \rho, \lambda \rangle} q^{|\Phi^+|} Z(\mathfrak{S}_{-y(\lambda), ww_0c_0, yw_0c_0}(\mathbf{z}^{-1}; q^{-1})).$$

Proof. The weight $y(\lambda)$ here is antidominant, whereas in Theorem 4.5, λ is dominant. Therefore we must use (29) instead of (28) for this comparison. With this in mind, the result follows from comparing (29) with Theorem 4.5. □

Corollary 6.10. *Let $w \in W$ and $g \in G$. Then there exists a solvable lattice model whose partition function equals $\sigma_w(g)$.*

Proof. Since ϕ_w is constant on the double cosets for $K \backslash G / J$ it is sufficient to prove this for a set of double coset representatives, which we take to be ϖ^λ with $\lambda \in \Lambda$. The result thus follows from Theorem 6.9. □

REFERENCES

- [1] A. Aggarwal, A. Borodin, and M. Wheeler. Colored fermionic vertex models and symmetric functions, 2021, arXiv:2101.01605.
- [2] L. C. Biedenharn. The quantum group $SU_q(2)$ and a q -analogue of the boson operators. *J. Phys. A*, 22(18):L873–L878, 1989.
- [3] A. Borodin and M. Wheeler. Coloured stochastic vertex models and their spectral theory, 2018, arXiv:1808.01866.
- [4] B. Brubaker, V. Buciumas, and D. Bump. A Yang-Baxter equation for metaplectic ice. Appendix joint with Nathan Gray. *Commun. Number Theory Phys.*, 13(1):101–148, 2019.
- [5] B. Brubaker, V. Buciumas, D. Bump, and S. Friedberg. Hecke modules from metaplectic ice. *Selecta Math. (N.S.)*, 24(3):2523–2570, 2018.
- [6] B. Brubaker, V. Buciumas, D. Bump, and H. P. A. Gustafsson. Colored vertex models and Iwahori Whittaker functions, 2019, arXiv:1906.04140.
- [7] B. Brubaker, V. Buciumas, D. Bump, and H. P. A. Gustafsson. Metaplectic Iwahori Whittaker functions and supersymmetric lattice models, 2020, arXiv:2012.15778.
- [8] B. Brubaker, V. Buciumas, D. Bump, and H. P. A. Gustafsson. Colored five-vertex models and Demazure atoms. *J. Combin. Theory Ser. A*, 178:105354, 48, 2021, arXiv:1902.01795.
- [9] B. Brubaker, V. Buciumas, D. Bump, and H. P. A. Gustafsson. Iwahori-metaplectic duality, 2021, arXiv:2112.14670.
- [10] B. Brubaker, D. Bump, and S. Friedberg. Schur polynomials and the Yang-Baxter equation. *Comm. Math. Phys.*, 308(2):281–301, 2011, arXiv:0912.0911.
- [11] B. Brubaker, D. Bump, and S. Friedberg. Unique functionals and representations of Hecke algebras. *Pacific J. Math.*, 260(2):381–394, 2012.
- [12] B. Brubaker, D. Bump, and S. Friedberg. Matrix coefficients and Iwahori-Hecke algebra modules. *Adv. Math.*, 299:247–271, 2016.
- [13] B. Brubaker, D. Bump, and A. Licata. Whittaker functions and Demazure operators. *J. Number Theory*, 146:41–68, 2015.
- [14] D. Bump. *Lie groups*, volume 225 of *Graduate Texts in Mathematics*. Springer, New York, second edition, 2013.
- [15] W. Casselman. The unramified principal series of \mathfrak{p} -adic groups. I. The spherical function. *Compositio Math.*, 40(3):387–406, 1980.

- [16] W. Casselman. Introduction to the theory of admissible representations of p -adic reductive groups, 1995, <https://personal.math.ubc.ca/~cass/research/pdf/p-adic-book.pdf>.
- [17] I. Cherednik. Double affine Hecke algebras and difference Fourier transforms. *Invent. Math.*, 152(2):213–303, 2003.
- [18] I. Cherednik and X. Ma. Spherical and Whittaker functions via DAHA I. *Selecta Math. (N.S.)*, 19(3):737–817, 2013.
- [19] I. Cherednik and X. Ma. Spherical and Whittaker functions via DAHA II. *Selecta Math. (N.S.)*, 19(3):819–864, 2013.
- [20] I. Cherednik and V. Ostrik. From double Hecke algebra to Fourier transform. *Selecta Math. (N.S.)*, 9(2):161–249, 2003.
- [21] B. Ion. Nonsymmetric Macdonald polynomials and matrix coefficients for unramified principal series. *Adv. Math.*, 201(1):36–62, 2006.
- [22] A. G. Izergin. Partition function of a six-vertex model in a finite volume. *Dokl. Akad. Nauk SSSR*, 297(2):331–333, 1987.
- [23] M. Jimbo. Quantum R matrix for the generalized Toda system. *Comm. Math. Phys.*, 102(4):537–547, 1986.
- [24] D. Kazhdan and G. Lusztig. Proof of the Deligne-Langlands conjecture for Hecke algebras. *Invent. Math.*, 87(1):153–215, 1987.
- [25] C. Korff. Cylindric versions of specialised Macdonald functions and a deformed Verlinde algebra. *Comm. Math. Phys.*, 318(1):173–246, 2013.
- [26] G. Lusztig. Equivariant K -theory and representations of Hecke algebras. *Proc. Amer. Math. Soc.*, 94(2):337–342, 1985.
- [27] I. G. Macdonald. *Spherical functions on a group of p -adic type*. Publications of the Ramanujan Institute, No. 2. University of Madras, Centre for Advanced Study in Mathematics, Ramanujan Institute, Madras, 1971.
- [28] I. G. Macdonald. *Symmetric functions and Hall polynomials*. Oxford Mathematical Monographs. The Clarendon Press, Oxford University Press, New York, second edition, 1995. With contributions by A. Zelevinsky, Oxford Science Publications.
- [29] A. J. Macfarlane. On q -analogues of the quantum harmonic oscillator and the quantum group $SU(2)_q$. *J. Phys. A*, 22(21):4581–4588, 1989.
- [30] S. Naprienko. Combinatorics of Iwahori Whittaker functions, 2021, arXiv:2110.10377.
- [31] E. M. Opdam. A generating function for the trace of the Iwahori-Hecke algebra. In *Studies in memory of Issai Schur (Chevaleret/Rehovot, 2000)*, volume 210 of *Progr. Math.*, pages 301–323. Birkhäuser Boston, Boston, MA, 2003.
- [32] N. V. Tsilevich. The quantum inverse scattering problem method for the q -boson model, and symmetric functions. *Funktsional. Anal. i Prilozhen.*, 40(3):53–65, 96, 2006.

DEPARTMENT OF MATHEMATICS, STANFORD UNIVERSITY, STANFORD, CA 94305-2125
Email address: bump@math.stanford.edu

DEPARTMENT OF MATHEMATICS, STANFORD UNIVERSITY, STANFORD, CA 94305-2125
Email address: slava@naprienko.com