

A DICHOTOMY THEORY FOR HEIGHT FUNCTIONS

PIET LAMMERS

ABSTRACT. *Height functions* are random functions on a given graph, in our case integer-valued functions on the two-dimensional square lattice. We consider gradient potentials which (informally) lie between the discrete Gaussian and solid-on-solid model (inclusive). The phase transition in this model, known as the *roughening transition*, *Berezinskii-Kosterlitz-Thouless transition*, or *localisation-delocalisation transition*, was established rigorously in the 1981 breakthrough work of Fröhlich and Spencer. It was not until 2005 that Sheffield derived *continuity* of the phase transition. First, we establish *sharpness*, in the sense that covariances decay exponentially in the localised phase. Second, we show that the model is *delocalised at criticality*, in the sense that the set of potentials inducing localisation is open in a natural topology. Third, we prove that the pointwise variance of the height function is at least $c \log n$ in the delocalised regime, where n is the distance to the boundary, and where $c > 0$ denotes a universal constant. This implies that the effective temperature of any potential cannot lie in the interval $(0, c)$ (whenever it is well-defined), and jumps from 0 to at least c at the critical point. We call this range of forbidden values the *effective temperature gap*.

CONTENTS

1. Introduction	1
2. Level lines and the thread expansion	12
3. Correlation inequalities	21
4. The RSW theory of Köhler-Schindler and Tassion	28
5. Percolation at boundary height zero	30
6. Symmetrisation arguments	35
7. The pushing lemma	41
8. The second coarse-graining inequality	56
9. The localised regime	60
10. The delocalised regime	62
11. Continuity of the finite-volume observable	64
Acknowledgements	67
References	67

1. INTRODUCTION

1.1. Preface.

1.1.1. *Height functions and their phase transition.* The interest is in random integer-valued *height functions* on the vertices of the two-dimensional square lattice graph. The appeal of this model lies in two facts. First, height functions are in direct correspondence with a zoo of other models in statistical mechanics of varying nature. Second, an increasingly precise general theory for the analysis of height functions has emerged over the past fifty

2020 *Mathematics Subject Classification.* Primary 82B20, 82B41; secondary 82B30.

Key words and phrases. Height functions, renormalisation group, coarse-graining, phase diagram, sharpness, effective temperature gap, finite-size criterion, BKT transition, discrete Gaussian model, solid-on-solid model, lattice models, statistical mechanics.

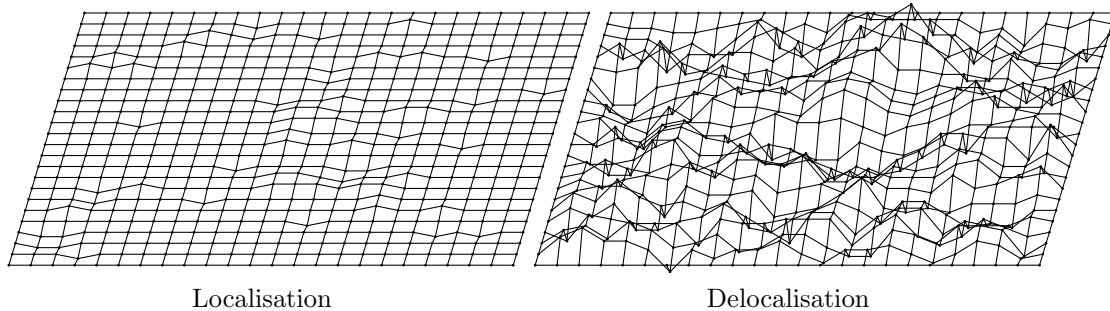

FIGURE 1. LEFT: A sample at low temperature from the discrete Gaussian model. The sample looks flat with a few local excitations. RIGHT: A sample at high temperature from the same model. The surface looks rougher and the heights tend to move away from zero.

years. The purpose of this article is to investigate the nature of the phase transition which occurs for height functions. There are two phases: either the variance of the height at the origin is bounded uniformly in the distance to the boundary of the domain; the *localised phase*, or this variance grows infinite as the domain is taken larger and larger; the *delocalised phase* (Figure 1). This phase transition is generically called the *localisation-delocalisation transition*. The *existence* of the delocalised phase was established rigorously in the breakthrough 1981 article of Fröhlich and Spencer [FS81]. That article also famously proves the *Berezinskii-Kosterlitz-Thouless (BKT) transition* in the XY model. Since the XY model shares its partition function with a height functions model, the phase transitions of the two models are believed to be closely related. For the same reason the term *BKT transition* is also sometimes used for the localisation-delocalisation transition itself. The BKT transition is still of interest to researchers today, as is illustrated by a number of beautiful recent works [GS20a, GS20b, AHPS21, EL22, BPR22a, BPR22b] discussed below in further detail (Subsection 1.4.1).

1.1.2. *Percolation theory and continuity of the phase transition.* The analysis of height functions has benefited hugely from the development of percolation theory, which was not available (in its current form) to Fröhlich and Spencer when publishing their article more than four decades ago. One could argue that the systematic application of percolation theory to height functions was pioneered in the seminal PhD thesis of Sheffield [She05], published in 2005. Sheffield observed that two-dimensional planar lattices are special: the planar geometry forbids simultaneous percolation of a random set and its dual. In other words, he ruled out *phase coexistence*. This is most elegantly illustrated by Bernoulli site percolation on the triangular lattice: at criticality, each open cluster is surrounded by a circuit of closed vertices, and each closed cluster is surrounded by a circuit of open vertices. Sheffield deduced from this phase coexistence result that the localisation-delocalisation transition is *continuous*. More precisely, he proved that for each potential, there exists exactly one ergodic gradient Gibbs measure (of zero slope). This unique gradient measure responds continuously to a change in the potential in the natural topologies on the spaces of distributions and potentials respectively. The isolated result on phase coexistence of planar percolation has an alternative proof due to Duminil-Copin, Raoufi, and Tassion [DRT19]. It is now becoming increasingly clear that in fact the existence of the delocalised phase itself can be proved using the same phase coexistence result (see Subsection 1.4.2). At the same time other methods exist, including the Fröhlich-Spencer method and variations and improvements thereof, methods using parafermionic observables, and the Bethe ansatz (also discussed below).

1.1.3. *Quantitative percolation through a renormalisation inequality.* The work of Sheffield relies on a qualitative analysis of the percolation clusters: are they finite or infinite? Such methods are not sufficient for answering more detailed, quantitative questions. A general strategy which relates percolation theory to the quantitative properties of the system was developed in the work of Duminil-Copin, Sidoravicius, and Tassion [DST17] in the context of the random-cluster model. They consider a specific observable $a_n(q) \in [0, 1]$ which is defined at any scale $n \in \mathbb{Z}_{\geq 1}$ and for any cluster weight $q \geq 1$, and use percolation theory to prove that there exists a universal constant $c_{\text{renorm}} > 0$ such that for any q ,

$$a_{7n}(q) \leq a_n(q)^2 / c_{\text{renorm}} \quad \forall n. \quad (1)$$

The beauty of this equation, called a *renormalisation inequality*, is that it holds true in all regimes simultaneously. Yet at the same time the inequality implies a dichotomy: iterating (1) yields that either $a_n(q) \geq c_{\text{renorm}}$ for all n , or $a_n(q) \rightarrow 0$ stretch-exponentially fast in n . It is precisely the side of the dichotomy that depends on q . The observable is chosen such that its asymptotic behaviour indicates the phase of the model. The equation is called a renormalisation inequality because it is inspired by the renormalisation group picture for percolation models, which is a well-developed theory in physics but which is (in general) hard to make rigorous mathematically. This renormalisation strategy was employed twice in the context of height functions: by Glazman and Manolescu [GM21] in the context of the loop $O(2)$ model (although for a spin representation of the height function rather than for the height function directly), and by Duminil-Copin, Harel, Laslier, Raoufi, and Ray for the square ice (the six-vertex model with uniform weights) [DHL⁺22]. In both cases, the dichotomy was derived at a single, isolated point of the phase diagram. Because of this and because these two points are not critical, the dichotomy does not give more information about the nature of the phase transition itself for these particular cases.

1.1.4. *A new coarse-graining inequality.* At the core of this article is a version of the renormalisation inequality introduced in [DST17]. More precisely, we derive the following lemma. The class Φ is the class of height function potentials V that lie (in some precise sense) between the discrete Gaussian model and the solid-on-solid model (inclusive); see Definition 1.3. The observable $p_n(V)$ which is defined at each scale $n \in \mathbb{Z}_{\geq 1}$ is the natural adaptation of the quantity $a_n(q)$ appearing in [DST17], see Figure 2. It is introduced formally in Section 8. The precise meaning of the lemma does not matter at this stage; we only state it in order to draw a comparison with the renormalisation inequality (1).

Lemma 1 (Second coarse-graining inequality). *There is a universal constant $c_{\text{dichot}} > 0$ with the following property. For any potential $V \in \Phi$, the observables $(p_n(V))_n \subset [0, 1]$ which are defined at each scale $n \in \mathbb{Z}_{\geq 1}$ satisfy, for each $n \in \mathbb{Z}_{\geq 1000}$, the equation*

$$p_{20kn}(V) \leq (p_n(V) / c_{\text{dichot}})^k \quad \forall k \in \mathbb{Z}_{\geq 1}. \quad (2)$$

In particular, for each potential $V \in \Phi$, either $p_n(V) \geq c_{\text{dichot}}$ for all $n \in \mathbb{Z}_{\geq 1000}$, or $(p_{kn}(V))_{k \geq 1}$ decays exponentially for some fixed $n \in \mathbb{Z}_{\geq 1}$.

Let us make two remarks before proceeding. First, this is—to the knowledge of the author—the first time that an inequality such as (1) is established for a *class* of height function potentials at once, rather than at a single point in the phase diagram. This enables one to study the topological properties of each map $p_n : \Phi \rightarrow [0, 1]$. Second, contrary to the renormalisation inequality (1) which has appeared in several settings, equation (2) of Lemma 1 directly yields exponential decay of the observable. It is not appropriate to call the new inequality a renormalisation inequality, because it does not correspond to *iterating* a scaling map in the renormalisation group picture. Rather, it should be thought of as a new coarse-graining inequality, in addition to the first coarse-graining inequality which was already known and which is also described in detail in this article. Therefore we call (2) the *second coarse-graining inequality*. Despite the similarity in name, the two coarse-graining

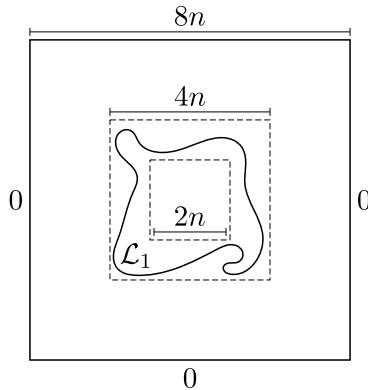

FIGURE 2. The (simplified version of the) observable $p_n(V)$ is defined as the probability of seeing a circuit at height ≥ 1 in the small annulus, in the measure with height 0 imposed on the boundary of the large box. The small annulus and the large box both scale linearly with n . Thus, the observable measures the ability of the model to transition from one height to another at the macroscopic scale. The formal definition is more convoluted due to technical complications: see Section 8 and Figure 18.

inequalities are quite different in spirit. The first inequality coarse-grains percolation clusters and holds in arbitrary dimension. The second inequality coarse-grains *interfaces* of percolation clusters and relies heavily on the planar structure that is lost in dimension three and higher. The two occupy a different place in the logical hierarchy (Figure 4). The new coarse-graining inequality also applies to the original planar random-cluster model (at least in the highly symmetric case of the square lattice), and therefore the separate proof that stretch-exponential decay implies exponential decay for $(a_n(q))_n$ which appears in [DST17] is no longer necessary.

1.2. Definitions and main results.

1.2.1. Height functions with super-Gaussian potentials.

Definition 1.1 (The square lattice). Let $(\mathbb{Z}^2, \mathbb{E})$ denote the square lattice graph. Write $\Lambda \Subset \mathbb{Z}^2$ to say that Λ is a finite subset of \mathbb{Z}^2 , and write $\mathbb{E}(\Lambda) \subset \mathbb{E}$ for the set of edges incident to at least one vertex in Λ . Use the shorthand $\Lambda_n := (-n, n)^2 \cap \mathbb{Z}^2$ for any $n \in \mathbb{Z}_{\geq 1}$, and observe that $\Lambda_n \uparrow \mathbb{Z}^2$ as $n \rightarrow \infty$.

Definition 1.2 (Height functions). Let $\Omega := \{h : \mathbb{Z}^2 \rightarrow \mathbb{Z}\}$ denote the set of height functions, and let Ω_Λ denote the set of height functions whose support is contained in $\Lambda \Subset \mathbb{Z}^2$. Define the probability measure μ_Λ on Ω to be the unique measure which has Ω_Λ as its support and which assigns a probability

$$\mu_\Lambda(h) := \frac{1}{Z_\Lambda} e^{-H_\Lambda(h)}; \quad H_\Lambda(h) := \sum_{xy \in \mathbb{E}(\Lambda)} V(h_y - h_x)$$

to each height function $h \in \Omega_\Lambda$, where $V : \mathbb{Z} \rightarrow \mathbb{R}$ is an unbounded convex symmetric *potential function*, and where H_Λ and Z_Λ denote the *Hamiltonian* and *partition function* in Λ respectively.

We are typically interested in the law of h in the family $(\mu_\Lambda)_{\Lambda \Subset \mathbb{Z}^2}$ for a fixed potential function V . In this article, we restrict to potential functions which are super-Gaussian.

Definition 1.3 (Super-Gaussian potentials). An unbounded convex symmetric potential function $V : \mathbb{Z} \rightarrow \mathbb{R}$ is *super-Gaussian* whenever its second derivative $V^{(2)} : \mathbb{Z} \rightarrow [0, \infty)$

defined by

$$V^{(2)}(a) := V(a - 1) - 2V(a) + V(a + 1)$$

satisfies $V^{(2)}(a + 1) \leq V^{(2)}(a)$ for all $a \geq 0$. Write Φ for the set of super-Gaussian potential functions. The class Φ is endowed with a natural topology \mathcal{T} , namely the pull-back along the map

$$V \mapsto \left(e^{-V+V(0)}, \lim_{a \rightarrow \infty} \frac{V(a)}{a} \right),$$

where the first component of the codomain is endowed with the ℓ^∞ topology and the second component with the natural topology on the extended number line $[0, \infty]$ (which makes the extended line connected). Observe that this topology does not distinguish potentials which differ by a constant, which is natural because such potentials induce the same probability measures $(\mu_\Lambda)_\Lambda$.

Examples include the discrete Gaussian model $V(a) = \beta a^2$ and the solid-on-solid model $V(a) = \beta|a|$, each defined at any inverse temperature $\beta > 0$. If V is any super-Gaussian potential with $V(0) = 0$ and $V(1) = \beta > 0$, then $(a \mapsto \beta|a|) \leq V \leq (a \mapsto \beta a^2)$, and therefore the discrete Gaussian model and the solid-on-solid model may informally be seen as the extremal points of the set of super-Gaussian potentials. Coincidentally, these two models are precisely the two height function models considered in the original work of Fröhlich and Spencer [FS81].

For super-Gaussian potentials it is known that $\text{Var}_{\mu_\Lambda}[h_x]$ is increasing in Λ , see [LO21]. This is due to the absolute-value-FKG property of such potentials (Lemma 3.2), which is of central importance in this article and will be discussed at great lengths. In particular, the above monotonicity implies that the variance converges to some limit in $[0, \infty]$ as $\Lambda \uparrow \mathbb{Z}^2$. We use this as a definition for the localisation-delocalisation transition.

Definition 1.4 (The two phases). A potential $V \in \Phi$ is said to be:

- *Localising* whenever $\lim_{\Lambda \uparrow \mathbb{Z}^2} \text{Var}_{\mu_\Lambda}[h_x] < \infty$,
- *Delocalising* whenever $\lim_{\Lambda \uparrow \mathbb{Z}^2} \text{Var}_{\mu_\Lambda}[h_x] = \infty$.

Write $\text{Loc}[\Phi]$ and $\text{Deloc}[\Phi]$ for the sets of localising and delocalising potentials in Φ .

Either set is nonempty: it is known that some potential $V \in \Phi$ belongs to $\text{Loc}[\Phi]$ when $V(\pm 1) \gg V(0)$ due to the Peierls argument [Pei36] which was implemented for height functions by Brandenberger and Wayne [BW82], while it was proved that $V \in \text{Deloc}[\Phi]$ for $V(a) := \beta a^2$ or $V(a) := \beta|a|$ with $\beta \approx 0$ in the original work of Fröhlich and Spencer [FS81]. The paragraphs below, which describe the main results, are illustrated by Figure 3.

1.2.2. Sharpness of the phase transition.

Theorem 2 (Sharpness of the phase transition). *If $V \in \text{Loc}[\Phi]$, then μ_Λ converges to an ergodic extremal Gibbs measure μ in the topology of local convergence as $\Lambda \uparrow \mathbb{Z}^2$. The covariance of the height function decays exponentially fast in this measure, in the sense that there exists a unique norm $\|\cdot\|_V$ on \mathbb{R}^2 such that*

$$\text{Cov}_\mu[h_x, h_y] = e^{-(1+o(1))\|y-x\|_V}$$

as $\|y - x\|_2 \rightarrow \infty$.

Exponential decay of the covariance functional was already known at low temperature due to [BW82]; we push this result all the way to the critical point. This is, by the knowledge of the author, the first time that sharpness is proved directly on the level of the height function, that is, not through a coupling with another model for which sharpness was already known.

The norm $\|\cdot\|_V$ is related directly to two classical quantities, namely the *mass* and its reciprocal, the *correlation length*, defined respectively by

$$\mathbf{m}(V) := \|e_1\|_V; \quad \xi(V) := 1/\mathbf{m}(V).$$

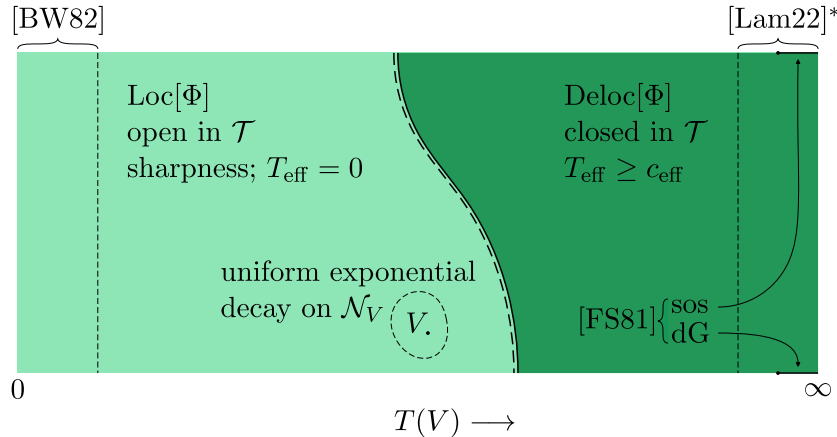

FIGURE 3. Schematic rendering of the main results in the phase diagram, realised as the topological space (Φ, \mathcal{T}) . The infinite-dimensional space is projected onto paper in such a way that the x -coordinate coincides precisely with $T(V) := (V(1) - V(0))^{-1}$. Unlike perhaps suggested, it is not proved that $\text{Loc}[\Phi]$ and $\text{Deloc}[\Phi]$ are connected in this topology. Some existing localisation-delocalisation results are drawn: localisation at low temperature (the Peierls argument [BW82]), and delocalisation at high temperature ([FS81] for the solid-on-solid and discrete Gaussian models, and [Lam22] for all super-Gaussian potentials on the hexagonal and octagonal lattices; the result is expected to generalise to the square lattice). The current article also applies to the hexagonal and octagonal lattices; see Subsection 1.3.

These quantities are extended to Φ by setting

$$\|\cdot\|_V \equiv 0; \quad \mathfrak{m}(V) := 0; \quad \xi(V) := \infty, \quad \forall V \in \text{Deloc}[\Phi].$$

1.2.3. *The effective temperature gap.* To state the following result in its simplest form, let H_n denote the average of h on $\Lambda_n \setminus \Lambda_{n-1}$; this variable may be seen as the discrete equivalent of the circle average which appears in the analysis of the Gaussian free field, and we also have $H_1 = h_{(0,0)}$. The letter Γ denotes the normalised Gaussian free field.

Theorem 3 (Effective temperature gap). *There exists a universal constant $c_{\text{eff}} > 0$ with the following property. If $V \in \text{Deloc}[\Phi]$ is any delocalised potential, then*

$$\text{Var}_{\mu_{\Lambda_n}}[H_m] \geq c_{\text{eff}} \times \log \frac{n}{m} \quad \forall n \in \mathbb{Z}_{\geq 8000}, \forall 1 \leq m \leq n/8.$$

In particular, if the model has the Gaussian free field $T_{\text{eff}}(V) \times \Gamma$ with effective temperature $T_{\text{eff}}(V) \in [0, \infty)$ as its scaling limit, then $T_{\text{eff}}(V) \geq c_{\text{eff}}$. Since $T_{\text{eff}}(V) = 0$ for $V \in \text{Loc}[\Phi]$, this means that there is a range $(0, c_{\text{eff}})$ of forbidden values for the effective temperature, which we call the effective temperature gap.

In fact, the lower bound is valid for the variance of any (weighted) average over the heights at vertices belonging to Λ_m , not just circle averages. The constant c_{eff} is universal: it does not depend on the choice of the potential V , and does not change even if we allow different edges to have different potential functions (in a sufficiently symmetric fashion); see Subsection 1.3. The constant seems to encode a fundamental property of two-dimensional Euclidean space, and arises naturally from the Russo-Seymour-Welsh theory.

1.2.4. *Continuity of the observable.* Finally, we address the topological features of the phase diagram, by proving that the observables appearing in Lemma 1 are in fact continuous in the choice of $V \in \Phi$ with respect to the natural topology \mathcal{T} . This leads to the following two results.

Theorem 4 (Height functions are delocalised at criticality). *The sets $\text{Loc}[\Phi]$ and $\text{Deloc}[\Phi]$ are respectively open and closed in (Φ, \mathcal{T}) .*

Theorem 5 (The decay rate is locally uniformly positive). *Each $W \in \text{Loc}[\Phi]$ admits a neighbourhood \mathcal{N}_W such that $\inf_{V \in \mathcal{N}_W} \|\cdot\|_V$ is a norm (in particular, it is positive definite), where the norms are those specified in Theorem 2.*

In fact, we expect the stronger statement that the map $V \mapsto \|\cdot\|_V$ is also continuous to hold true, but do not prove it here.

1.2.5. *One-arm exponent.* One may ultimately hope to understand the scaling limit of height functions through their coupling with the percolation structure. In this light, we state one minor result which is obtained early on in the analysis (after the first coarse-graining inequality).

Theorem 6 (Upper bound on the one-arm exponent). *There exists a universal constant $\alpha_1 < \infty$ with the property that, for any potential $V \in \Phi$,*

$$\mu_{\Lambda_n, 0, 0}(\mathbb{F}(\Lambda_m) \xleftarrow{\mathcal{L}_0} \mathbb{F}(\partial_v \Lambda_n)) \geq \left(\frac{m}{n}\right)^{\alpha_1} \quad \forall 1 \leq m \leq n/2.$$

The new objects appearing in this statement are (informally) described as follows.

- The law of h conditional on $|h|$ in μ_{Λ_n} is that of an Ising model, and \mathcal{L}_0 is precisely the dual-complement of the FK-Ising percolation of this Ising model in the Edwards-Sokal coupling (Definition 2.13 and Lemma 3.3).
- The measure $\mu_{\Lambda_n, 0, 0}$ is the product measure of μ_{Λ_n} with some external information in order to define rigorously this coupling (Definition 2.3).
- The event whose probability we lower bound is the event that some face of the square lattice adjacent to Λ_m is connected to the boundary of Λ_n by an \mathcal{L}_0 -open path (Definitions 2.11 and 4.1).

1.3. **Symmetries and generalisations.** The percolation arguments rely in an essential way on the symmetries of the square lattice. More precisely, these symmetries are:

1. Translational symmetry along a full-rank sublattice,
2. Flip symmetry around the y -axis,
3. Rotational symmetry by an angle of $\pi/2$.

The theory therefore extends immediately to models with the same symmetry group. Let us now give a formal account of this more general setup. Let $\mathbb{G} = (\mathbb{V}, \mathbb{E})$ denote a planar graph, and let $V = (V_{xy})_{xy \in \mathbb{E}} \subset \Phi$ denote an assignment of potentials to the edges of the graph. The *automorphism group* $\text{Aut}(\mathbb{G}, V)$ of the model contains the set of automorphisms φ of \mathbb{G} with the property that $V_{\varphi(xy)} = V_{xy}$ for all edges $xy \in \mathbb{E}$.

1.3.1. *To graphs with the same symmetry group.* All results in this article generalise immediately to all models (\mathbb{G}, V) such that $\text{Aut}(\mathbb{G}, V)$ contains a full-rank lattice, a flip symmetry around some axis, and a rotational symmetry by an angle of $\pi/2$. This is the precise symmetry group required in [DT19] and [KT23]. The previous discussion implies in particular that the theory holds true on the octagonal lattice (also known as the truncated square lattice). On this graph delocalisation is known for a range of potentials [Lam22]: that article implies that the height function is delocalised for any potential $V \in \Phi$ with

$$T(V)^{-1} := V(1) - V(0) \leq \log 2;$$

see also Figure 3.

1.3.2. *To graphs with other symmetry groups.* We claim (without giving a formal, complete justification) that the theory also generalises to models (\mathbb{G}, V) such that $\text{Aut}(\mathbb{G}, V)$ contains a full-rank sublattice, a flip symmetry around some axis, and a rotational symmetry by some angle $0 < \alpha < \pi$. In this case most of the arguments still work, except that parts of the Russo-Seymour-Welsh theory require adaptation. The details of this adaptation are beyond the scope of this article. We refer to [GM21] for an example of RSW theory on the triangular lattice. Thus, in particular, the theorems in this article also apply to height functions on the triangular and hexagonal lattice, which are invariant under rotation by an angle of $2\pi/3$. The delocalisation result in [Lam22] also applies to the hexagonal lattice.

1.3.3. *To the height function of the XY model.* Finally let us mention that our results also apply to the height function dual to the XY model. The potential function in this case is the modified Bessel function V_β ; refer to [EL22] for details. The super-Gaussian property is known to hold true for V_β for β small, but not for large values of β . However, since $e^{-V_{2\beta}} \propto e^{-V_\beta} \star e^{-V_\beta}$ where \star denotes convolution, one may realise the height function at inverse temperature $2^k\beta$ on some graph \mathbb{G} as the height function at inverse temperature β on a modified graph obtained from \mathbb{G} by replacing each edge by 2^k edges linked in series. All results apply to this modified graph, and since the two graphs have the same automorphism group, the universal constants obtained in the proofs do not depend on k or β . In fact, it is possible to take the $k \rightarrow \infty$ limit in order to obtain a height functions model on the metric graph; this may be useful but we do not rely on this construction here.

1.4. Historical context.

1.4.1. *The discrete Gaussian model and existence of the phase transition.* One of the earliest height function models to be studied is the discrete Gaussian model, already alluded to several times above. This integer-valued height functions model, which has a square potential associated to it, appears as the natural dual model to the Villain model which is a close cousin of the XY model (the model is essentially an XY model with a modified potential function in order to simplify its analysis). The model was proved to delocalise with logarithmic variance growth in [FS81]. That work proves the BKT transition for the XY and Villain models, which was predicted independently by Berezinskii [Ber71] and later Kosterlitz and Thouless [KT73]. The article of Fröhlich and Spencer [FS81] is perhaps one of the first works proving height function delocalisation. Kharash and Peled [KP17] recently revisited the original Fröhlich-Spencer proof. Height function localisation at low temperature is proved through the Peierls argument [BW82, Pei36].

Several works on the BKT transition and on the models surrounding it have recently appeared. Any Gibbs measure of the Villain model may be written as the independent product of a massless Gaussian free field (the *spin wave*) with a probability measure on vortices and antivortices. In [GS20a], Garban and Sepúlveda compare the fluctuations of the model coming from these two components, and derive that the fluctuations induced by the vortex-antivortex measure are at least of the same order of magnitude as those coming from the spin wave. The vortex-antivortex measure is in direct correspondence with yet another model of interest to physicists called the *Coulomb gas*; refer to the extensive review of Lewin [Lew22] for an overview of all (including recent) developments. In another work [GS20b], the same authors prove a quantitative lower bound on the delocalisation of the discrete Gaussian model when the height function is not \mathbb{Z} -valued, but rather $(a(x) + \mathbb{Z})$ -valued where for each vertex $x \in \mathbb{Z}^2$ the number $a(x) \in \mathbb{R}$ denotes an arbitrary constant. This is remarkable because the setup essentially lacks any symmetry.

Independently of these developments, the link between spin models and height functions was intensified in two articles: Aizenman, Harel, Peled, and Shapiro proved that height function delocalisation implies polynomial decay for the two-point function in the Villain model [AHPS21], and simultaneously Van Engelenburg and Lis proved the equivalent result

for the XY model [EL22]. Both articles use the delocalisation result in [Lam22] as an input; [AHP21] also extends this delocalisation proof to the discrete Gaussian model on the square lattice.

In a series of two papers, Bauerschmidt, Park, and Rodriguez [BPR22a, BPR22b] prove convergence to the Gaussian free field of the discrete Gaussian model through the renormalisation group flow. This is important because it is the first time that the scaling limit has been identified for a non-integrable height functions model. Moreover, the renormalisation group is a robust theory in physics, and it is an exciting prospect that this theory may apply more generally on a rigorous, mathematical level.

1.4.2. *An overview of quantitative delocalisation results.* Both the original Fröhlich-Spencer proof and the renormalisation strategy (exhibited in [DHL⁺22] and in this article) lead to logarithmic delocalisation, but there are several other routes that lead to the same result. In the case of the *dimer model*, Kenyon used integrable features of the model to prove that the scaling limit is the Gaussian free field [Ken01], which was later extended to small perturbations of the dimer model [GMT17]. This implies logarithmic delocalisation of the height function in particular. The dimer model is combinatorial in nature and has no internal temperature parameter. Moreover, the potential function for the height function is not symmetric, setting it apart slightly from the other models considered here. In the remainder of this section we restrict our attention to models whose potential function is convex and symmetric.

Consider now the *six-vertex model* with the parameters $a = b = 1$ and $c \geq 1$; see for example [DGH⁺18]. This implies two favourable properties for the model, namely invariance under $\pi/2$ rotation, and the FKG inequality for the height function. On the one hand, the model has a rich underlying combinatorial structure, while at the same time the parameter c serves as a sort of inverse temperature parameter, thus setting the model apart from the dimer model which has no natural temperature parameter. For $c = 1$, the uniform case also known as the *square ice*, delocalisation of the height function was first observed by Chandgotia, Peled, Sheffield, and Tassy in [CPST21], which mentions [She05] as already containing the more general statements that imply the result. Duminil-Copin, Harel, Laslier, Raoufi, and Ray independently implemented the dichotomy strategy to quantify the delocalisation as being logarithmic [DHL⁺22]. For $c > 1$ the interaction (as a height function) becomes non-planar, so that the uniqueness result of Sheffield [She05] (which requires either planarity or delocalisation) no longer applies in the localised regime. The full phase diagram of the six-vertex model with $a = b = 1$ and $c \geq 1$ is understood. For $1 \leq c \leq 2$, Duminil-Copin, Karrila, Manolescu, and Oulamara proved logarithmic delocalisation [DKMO20]; they use the Bethe ansatz as an input to derive macroscopic crossing estimates, then use Russo-Seymour-Welsh theory to turn these estimates into the desired delocalisation result. The strategy is thus very different from the renormalisation strategy exhibited in this article. For $c > 2$, Glazman and Peled [GP19] proved that there exist *two* ergodic gradient Gibbs measures (thus showing that the planar requirement is genuinely necessary for uniqueness). Their result relies on the Baxter-Kelland-Wu coupling with the critical random-cluster model for $q > 4$, together with the discontinuity result [DGH⁺21] mentioned above. There also exist other delocalisation arguments covering part of the interval $c \in [1, 2]$, namely the transition point $c = 2$ [GP19, DST17], the free-fermion point $c = \sqrt{2}$ [Ken01] and a small neighbourhood [GMT17], and the range $[(2 + 2^{1/2})^{1/2}, 2]$ [Lis21].

Next, we consider another model of interest to mathematical physicists: the *loop $O(2)$ model* which consists of random loops realised as the subset of the edges of the hexagonal lattice. Duminil-Copin, Glazman, Peled, and Spinka [DGPS20] proved the existence of large loops in the loop $O(n)$ model at the Nienhuis critical point for $n \in [1, 2]$. This results may be phrased as a height function delocalisation result (with logarithmic variance) at the

point $n = 2$; the corresponding value for x is $x_c = 1/\sqrt{2}$. The authors use the parafermionic observable to derive macroscopic crossing estimates, then use a Russo-Seymour-Welsh theory to turn the loop segments so obtained into large loops. By contrast, Glazman and Manolescu used planar percolation to prove delocalisation for the uniformly random 1-Lipschitz on the triangular lattice (that is, the loop $O(2)$ model with the parameter $x = 1$), together with the renormalisation strategy to quantify the delocalisation [GM21]. Finally, let us mention that Glazman and the current author are working on a manuscript [GL23] where they prove logarithmic height function delocalisation for the loop $O(2)$ model with $x \in [x_c = 1/\sqrt{2}, 1]$ and for the six-vertex model with $a = b = 1$ and $c \in [1, c_c = 2]$ using the phase coexistence result and the renormalisation strategy applied to a spin representation of the height function.

1.4.3. Localisation-delocalisation in higher dimension. Height functions are expected to localise in dimension $d \geq 3$ in a rather general setting. This has been proved rigorously for the discrete Gaussian model [FSS76, FILS78] and the solid-on-solid model [BFL82] in dimension three and higher, as well as for the uniformly random Lipschitz function in sufficiently high dimension [Pel17].

It is a general phenomenon that the critical dimension of a lattice model changes after introducing a random disorder. For example, it was proved recently that the two-dimensional Ising model exhibits exponential decay at all temperatures after the introduction of a random disorder [DX21, AHP20]. In the domain of height functions, Dario, Harel, and Peled showed that a typical *real-valued* height function delocalises in dimension $d \leq 4$ after introducing a random disorder [DHP23]. For the integer-valued discrete Gaussian model they prove however that the height function is already localised in dimension $d = 3$ when the disorder is weak; the localisation-delocalisation question is left open for a strong disorder.

1.5. Proof overview. There are three parts.

1. *Sections 2 and 3.* The first part contains a description of the coupling of the height function with various percolation structures, which are proved to exhibit positive association. More precisely: they satisfy monotonicity in boundary conditions and two FKG inequalities which are quite different in nature.
2. *Sections 4–8.* The second part contains abstract percolation arguments, whose details are by and large specific to height functions. This part culminates in the proof of the second coarse-graining inequality (Lemma 1), the motor of this article. Theorem 6 is derived *en passant*, after proving the first coarse-graining inequality.
3. *Sections 9–11.* The third part derives the main results (Theorems 2–5) from the second coarse-graining inequality in a relatively straightforward fashion.

Sections 2 and 3. Coupling with percolation. All our results effectively follow from the quantified percolation statement in Lemma 1. Our first objective in this article is to recover the percolation structures which are expressive enough for us to carry out the analysis for its proof.

Section 2 introduces these percolations. It is known that both h and $|h|$ satisfy the Fortuin-Kasteleyn-Ginibre (FKG) inequality in each measure μ_Λ , but this is not quite strong enough. Instead, we would like to define the *level lines* of a sample h . Level lines are defined at each height $a \in \mathbb{Z}$, and morally separate the lower level set $\{h \leq a\}$ from the upper level set $\{h \geq a\}$. A more or less formal definition of the level lines (at height zero) reads as follows: the law of h conditional on $|h|$ is that of an Ising model with explicit coupling constants in terms of $|h|$, and the set of *level lines at height zero* is the random set of dual edges $\mathcal{L}_0 \subset \mathbb{E}^*$ which arise as the dual-complement of the FK-Ising edges of this Ising model. Informally this means that the Ising model decorrelates over \mathcal{L}_0 -circuits. Recall that the FK-Ising coupling requires the input of external randomness on top of the

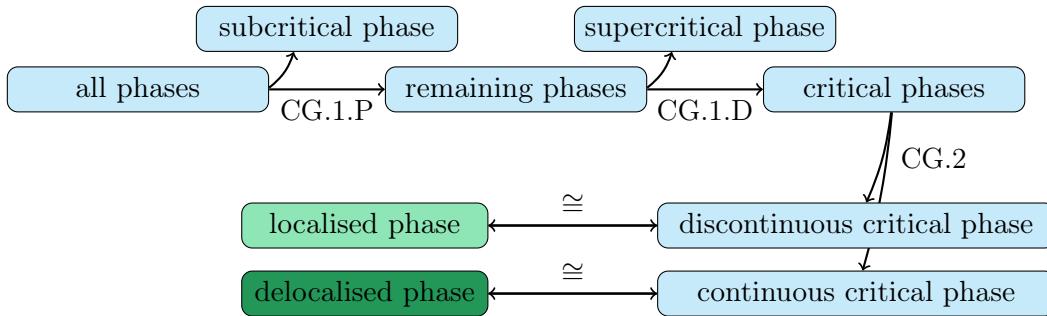

FIGURE 4. The coarse-graining inequalities separate the four phases of the random-cluster model through three dichotomies. The first coarse-graining inequality has a primal and a dual version. Since the subcritical and the supercritical regime do not occur for height functions, it is the second coarse-graining inequality that describes the localisation-delocalisation transition for height functions.

full knowledge of the height function h ; we must increase our probability space to formalise this construction.

On several occasions, we rely on exploration processes which attempt to explore these level lines, typically at the height zero or the height one. Of course, we would like to understand the conditional law following such an exploration process. For this reason, we generalise our notion of boundary condition. The interplay between the height function, the level lines, and the generalised boundary conditions becomes most transparent once we introduce the so-called *thread expansion*. This thread expansion was first mentioned by Sheffield in the proof of Lemma 8.6.4 in [She05].

Section 3 contains the proofs of all the FKG inequalities that we rely on in the article. We prove in particular that both h and $|h|$ satisfy the FKG inequality. The FKG inequality for the absolute value was first observed for a height function in the context of random graph homomorphisms by Benjamini, Häggström, and Mossel [BHM00]. Duminil-Copin, Harel, Laslier, Raoufi, and Ray were the first to utilise this new FKG inequality in the context of the square ice (the six-vertex model with uniform weights) in order to prove logarithmic delocalisation of the height function [DHL⁺22]. Ott and the current author [LO21] extended the FKG inequality for $|h|$ to super-Gaussian potentials, which is essentially the reason that we work with the class Φ in this article.

Sections 4–8. Proof of Lemma 1. Now that the relevant percolation structures have been extracted from the height function, we have access to the large corpus of existing research on planar percolation. Section 4 describes how the Russo-Seymour-Welsh theory developed in [KT23] applies generically to our setup. The remainder of this part is inspired by [DST17], [DT19], and [KT23], while it also deviates from those works in some essential aspects. Duminil-Copin and Tassion obtain a *quadrichotomy* of behaviours for the random cluster model in [DT19], essentially by deriving three dichotomies; see Figure 4. In this article, we proceed as follows. First, we prove the first coarse-graining inequality in Section 5. But, rather than deriving a dichotomy from this inequality, we immediately rule out one of the two behaviours using an argument specific to height functions. The dual version of the first coarse-graining inequality is somehow irrelevant because height functions automatically exhibit a form of self-similarity, namely invariance of the model under adding a constant to the height function. Thus, it remains to prove the second coarse-graining inequality. We do so in three steps: Section 6 contains a number of symmetry arguments, which serve as simple building blocks in the proof of the *pushing lemma* in Section 7. This lemma is considered the essential step in proving the renormalisation inequalities in [DST17] and [DT19], and it

is also the essential step in proving the corresponding inequality (Lemma 1) in the current work. Lemma 1 is proved in Section 8.

The proof of the pushing lemma in Section 7 requires considerable effort; in particular because we must develop an RSW theory which is inspired by [KT23], but in a setting where fewer symmetries are available. This section is the most interesting from the perspective of percolation theory but may also be used as a black box in the remainder of the article.

Sections 9–11. Conclusions: proofs of Theorems 2–5. Once Lemma 1 has been established, we can reap its rewards. The analysis is entirely straightforward subject to the technicalities related to our percolations. A description of the localised and delocalised phases is contained in Sections 9 and 10 respectively, thus proving Theorems 2 and 3 above. Finally, we prove that the finite-volume observable $p_n(V)$ appearing in Lemma 1 is continuous in V in Section 11. This leads immediately to the proof of Theorems 4 and 5.

We point out a remarkable detail in the proof of Theorem 3. Of course, we would like to prove not only that the height function delocalises uniformly, but rather describe this delocalisation in further detail by also specifying the corresponding behaviour of the percolation structures. This is not possible due to two complications:

1. The height functions are not almost surely K -Lipschitz for some fixed K ,
2. We have no a priori *upper bounds* on $\text{Var}_{\mu_{\Lambda_n}}[H_m]$.

We would like to argue that the delocalising percolation circuits appear at each scale in order to derive the logarithmic delocalisation. Instead, we shall argue by contradiction: if such circuits *do not* appear, then the variance of the circle average must grow *even more* (see Section 10). This complication may be avoided once one has access to the *upper bounds* on the variance; such upper bounds are well-known in the case of the discrete Gaussian model (see [AHPS21]).

2. LEVEL LINES AND THE THREAD EXPANSION

This section describes the *thread expansion*, which leads to an appropriate definition for the *level lines* of the random height function. The level lines are the protagonist of this story: they are interpreted as a planar bond percolation process satisfying the well-known Fortuin-Kasteleyn-Ginibre (FKG) inequality, which allows us to connect the current article to the existing body of research on planar percolation. The formalism is inspired by a construction appearing in the proof of Lemma 8.6.4 of the monograph *Random surfaces* of Sheffield [She05].

2.1. Introduction. We start with an informal account of a construction which illustrates the thread expansion. Our intuition comes from a model of real-valued height functions called the *discrete Gaussian free field*, see for example [WP20]. Let (V, E) denote the graph on which the model lives. The potential function of the discrete Gaussian free field is quadratic in the height difference between neighbours. Let C denote the topological space containing V which is obtained by replacing each edge $xy \in E$ by an interval of unit length, and whose endpoints are identified with x and y respectively. This is called the *cable system* or *metric graph* of the graph (V, E) . It is well-known that the height function h of the discrete Gaussian free field may be extended to a random continuous Gaussian height function \tilde{h} on the cable system by sampling independent Brownian bridges on the interval corresponding to each edge xy , conditioned to take the values h_x and h_y on the respective endpoints. The Markov property extends to this topological space: if we condition on the values of h on some finite set $X \subset C$, then the conditional law of \tilde{h} on each connected component of $C \setminus X$ is independent of the law of \tilde{h} on the remaining components.

The extension to the cable graph provides several advantages over the original setup. For us, the property of interest is *continuity*. Suppose that $x \in V$ is some distinguished vertex, and condition on the event $\{h_x > 0\}$. Let $A \subset C$ denote the connected component

of $\{\tilde{h} > 0\}$ containing x , and let $X \subset C$ denote its boundary. One may find the sets A and X by running an exploration process starting from the vertex x . Conditional on this exploration process, the law in $C \setminus A$ is that of a discrete Gaussian free field with zero boundary conditions at X . Indeed, $\tilde{h}|_X \equiv 0$ because \tilde{h} is continuous.

- Remark 2.1.**
1. It was not possible to find zero boundary conditions without the Brownian bridges, because the random function $h : V \rightarrow \mathbb{R}$ may jump from positive to negative values when comparing neighbours.
 2. When specifying boundary conditions (for example through the set X above), one must provide more information than before in order to determine the precise location of the boundary on the unit interval associated to each edge.
 3. The above is not a perfect analogy for the sequel: we shall not truly extend our models to the cable graph (even though this is possible in some specific cases).

2.2. Generalised boundary conditions. We first introduce boundary conditions that describe the conditional law following an exploration process.

Definition 2.2 (Truncated potentials). For any $\tau \in \mathbb{Z}_{\geq 0}$, define the potential function $V^{[\tau]} : \mathbb{Z} \rightarrow [0, \infty)$ by

$$V^{[\tau]}(a) := V(\tau + |a|).$$

This function is called a *truncated potential*. It is straightforward to work out that $V^{[\tau]}$ is an unbounded convex symmetric potential function with the super-Gaussian property whenever V satisfies these constraints. Note that $V^{[0]} = V$ and $V^{[\tau][\tau']} = V^{[\tau+\tau']}$.

The letter τ denotes the precise location of the exploration boundary on some fixed edge. Let $\mathbb{E}_o(\Lambda) \subset \mathbb{E}(\Lambda)$ denote the *interior edges* of Λ , that is, the set of edges which are entirely contained in Λ . Let $\partial_e \Lambda := \mathbb{E}(\Lambda) \setminus \mathbb{E}_o(\Lambda)$ denote the *edge boundary* of Λ . The edges in $\partial_e \Lambda$ are oriented by convention: the notation $xy \in \partial_e \Lambda$ indicates that y is the vertex contained in Λ . In other words, the edges in $\partial_e \Lambda$ point *into* Λ .

Definition 2.3 (Boundary conditions). A *boundary condition* is a triple (Λ, τ, ξ) with $\Lambda \Subset \mathbb{Z}^2$ and with $\tau, \xi : \partial_e \Lambda \rightarrow \mathbb{Z}$ such that $\tau \geq 0$. The functions τ and ξ are called the *truncation function* and *boundary height function* respectively. Write \mathbf{Bound} for the set of boundary conditions, and define $\mathbf{Bound}_{\geq 0} := \{(\Lambda, \tau, \xi) \in \mathbf{Bound} : \xi \geq 0\}$. The Hamiltonian associated to a boundary condition $(\Lambda, \tau, \xi) \in \mathbf{Bound}$ is

$$H_{\Lambda, \tau, \xi} : \mathbb{Z}^\Lambda \rightarrow [0, \infty), h \mapsto \left(\sum_{xy \in \partial_e \Lambda} V^{[\tau_{xy}]}(h_y - \xi_{xy}) \right) + \left(\sum_{xy \in \mathbb{E}_o(\Lambda)} V(h_y - h_x) \right).$$

The associated probability measure, defined on $\mathbb{Z}^\Lambda \times \mathbb{R}^{\mathbb{E}(\Lambda)}$, is given by the formula

$$\mu_{\Lambda, \tau, \xi} := \frac{1}{Z_{\Lambda, \tau, \xi}} e^{-H_{\Lambda, \tau, \xi}} \lambda^\Lambda \times \prod_{xy \in \mathbb{E}(\Lambda)} 1_{\{\rho_{xy} \geq 0\}} e^{-\rho_{xy}} d\rho_{xy}; \quad (3)$$

here λ denotes the counting measure on \mathbb{Z} , and $d\rho_{xy}$ is the Lebesgue measure on \mathbb{R} . The letter $Z_{\Lambda, \tau, \xi}$ denotes the partition function. Write (h, ρ) for the random pair in the measure $\mu_{\Lambda, \tau, \xi}$. The measure $\mu_{\Lambda, \tau, \xi}$ thus decomposes as a product of a probability measure on the height function h with an independent family of exponential random variables $(\rho_{xy})_{xy}$. These exponential random variables, called *residuals* or *residual energies*, serve as an external source of randomness that enables us to condition on events that depend on both h and ρ . The pair (Λ, τ) is also called a *geometric domain* because it describes precisely the geometric location of the boundary. Write \mathbf{Geom} for the set of geometric domains.

The definition of general boundary conditions is such that we must often distinguish between edges in $\partial_e \Lambda$ and those in $\mathbb{E}_o(\Lambda)$. This difficulty is purely administrative; it

does not add any fundamental physical complexity. Given a fixed boundary condition $(\Lambda, \tau, \xi) \in \text{Bound}$ and an edge $xy \in \mathbb{E}(\Lambda)$, we introduce the following two shorthands:

$$\nabla h_{xy} := \begin{cases} h_y - h_x & \text{if } xy \in \mathbb{E}_o(\Lambda), \\ h_y - \xi_{xy} & \text{if } xy \in \partial_e \Lambda, \end{cases} \quad \tau_{xy} := \begin{cases} 0 & \text{if } xy \in \mathbb{E}_o(\Lambda), \\ \tau_{xy} & \text{if } xy \in \partial_e \Lambda. \end{cases}$$

The Hamiltonian can be rewritten in this language as

$$H_{\Lambda, \tau, \xi}(h) := \sum_{xy \in \mathbb{E}(\Lambda)} V^{[\tau_{xy}]}(\nabla h_{xy}).$$

We now state two important observations.

Theorem 2.4. *Let $(\Lambda, \tau, \xi) \in \text{Bound}$ denote a boundary condition, and write $(\Lambda_k)_k$ for the decomposition of Λ into connected components. Then the following two statements hold true in the measure $\mu_{\Lambda, \tau, \xi}$.*

1. **Markov property.** *We have $\mu_{\Lambda, \tau, \xi} = \prod_k \mu_{\Lambda_k, \tau|_{\partial_e \Lambda_k}, \xi|_{\partial_e \Lambda_k}}$.*
2. **Flip symmetry.** *If for some component Λ_k and some integer $a \in \mathbb{Z}$, we have $\xi|_{\partial_e \Lambda_k} \equiv a$, then the functions $h|_{\Lambda_k}$ and $(2a - h)|_{\Lambda_k}$ have the same law.*

Proof. The Markov property follows from the definitions, noting that all interactions are on edges so that the behaviour of the model is independent on the distinct connected components of Λ . Flip symmetry is immediate from the fact that the Hamiltonian satisfies $H_{\Lambda, \tau, \xi}(h) = H_{\Lambda, \tau, \xi}(2a - h)$ whenever $\xi \equiv a$, which is a consequence of the symmetry of all (truncated) potential functions. \square

2.3. The thread length. Recall the definition of the measure $\mu_{\Lambda, \tau, \xi}$ in (3). If we decompose the Hamiltonian as a sum over edges, then the product of the factors corresponding to a single edge $xy \in \mathbb{E}(\Lambda)$ are given by

$$e^{-V^{[\tau_{xy}]}(\nabla h_{xy})} \mathbf{1}_{\{\rho_{xy} \geq 0\}} e^{-\rho_{xy}} d\rho_{xy}. \quad (4)$$

This subsection describes how this product may be rewritten in a meaningful way.

First, introduce a new random variable T_{xy} defined by

$$T_{xy} = V^{[\tau_{xy}]}(\nabla h_{xy}) + \rho_{xy}.$$

This random variable T_{xy} is called the *total energy* of the edge xy . Now

$$\begin{aligned} e^{-V^{[\tau_{xy}]}(\nabla h_{xy})} \mathbf{1}_{\{\rho_{xy} \geq 0\}} e^{-\rho_{xy}} d\rho_{xy} &= \mathbf{1}_{\{V^{[\tau_{xy}]}(\nabla h_{xy}) \leq T_{xy}\}} e^{-T_{xy}} d\rho_{xy} \\ &= \mathbf{1}_{\{V^{[\tau_{xy}]}(\nabla h_{xy}) \leq T_{xy}\}} e^{-T_{xy}} dT_{xy}; \end{aligned}$$

here dT_{xy} denotes the Lebesgue measure on the real line. The second equation follows by a simple change of measure, which we shall occasionally perform without further notice. To write the indicators on the right in a better form, we introduce yet another random variable $\ell(xy)$ defined by

$$\ell(xy) := \sup\{k \in \mathbb{Z} : V^{[\tau_{xy}]}(k) \leq T_{xy}\}.$$

This variable is called the *thread length* at the edge xy . Since each $V^{[\tau_{xy}]}$ is a convex symmetric function, this variable has the property that

$$\{V^{[\tau_{xy}]}(k) \leq T_{xy}\} = \{|k| \leq \ell(xy)\} \quad (5)$$

for any $k \in \mathbb{Z}$, so that (4) may be written as

$$\mathbf{1}_{\{|\nabla h_{xy}| \leq \ell(xy)\}} e^{-T_{xy}} dT_{xy}.$$

This means that the thread length $\ell(xy)$ is almost always at least $|\nabla h_{xy}|$ in $\mu_{\Lambda, \tau, \xi}$.

2.4. Thread arrangements. For simplicity, consider first an edge $xy \in \mathbb{E}_\circ(\Lambda)$. Imagine that we are given a thread of length $\ell(xy)$, and must use this thread to connect the heights h_x and h_y . This is almost surely possible because the thread length is almost always at least the absolute difference of the two numbers. If $\ell(xy) = |\nabla h_{xy}| = |h_y - h_x|$, then the thread is taut, while there is freedom in the arrangement of the thread whenever $\ell(xy) > |h_y - h_x|$. If $xy \in \partial_e \Lambda$, then the role of the height h_x is instead played by the boundary height ξ_{xy} .

Definition 2.5 (Thread arrangements). Replace a given directed edge $xy \in \mathbb{E}_\circ(\Lambda)$ by its *cable*, that is, the interval $[0, 1]$ with the endpoints 0 and 1 identified with the vertices x and y respectively. Given h_x, h_y , and $\ell(xy)$, a *thread arrangement* of the edge xy is a continuous function $f : [0, 1] \rightarrow \mathbb{R}$ such that

1. $f(0) = h_x$ and $f(1) = h_y$,
2. The total variation of f is at most $\ell(xy)$.

If $xy \in \partial_e \Lambda$, then a thread arrangement is defined with respect to ξ_{xy} rather than h_x .

Thread arrangements exist almost surely because the linear interpolation has total variation $|\nabla h_{xy}| \leq \ell(xy)$. We shall not prescribe a law on thread arrangements (this is where our construction essentially differs from the one for the discrete Gaussian free field). Instead, we use the definition of a thread arrangement to formulate a new type of event.

Definition 2.6 (Thread events). For $(a_1, \dots, a_n) \subset \mathbb{Z}/2$, define the event

$$\Theta_{xy}(a_1, \dots, a_n) := \left\{ \begin{array}{l} \text{the directed edge } xy \text{ has a thread arrangement} \\ \text{which visits the heights } a_1, \dots, a_n \text{ in that order} \end{array} \right\}.$$

Writing $\tau_\circ(a_1, \dots, a_n) := |a_2 - a_1| + \dots + |a_n - a_{n-1}|$, this event may also be written

$$\Theta_{xy}(a_1, \dots, a_n) = \{\tau_\circ(h_{xy}, a_1, \dots, a_n, h_y) \leq \ell(xy)\}; \quad h_{xy} := \begin{cases} h_x & \text{if } xy \in \mathbb{E}_\circ(\Lambda), \\ \xi_{xy} & \text{if } xy \in \partial_e \Lambda. \end{cases} \quad (6)$$

The definition even makes sense for a sequence of length zero, in which case we write

$$\begin{aligned} \Theta_{xy}(-) &= \{ \text{the edge } xy \text{ has a thread arrangement} \} \\ &= \{ |\nabla h_{xy}| \leq \ell(xy) \} = \{ V^{[\tau_{xy}]}(\nabla h_{xy}) \leq T_{xy} \}. \end{aligned} \quad (7)$$

We also write $\xi_\circ(a_1, \dots, a_n) := a_n$, which will be a useful notation later.

Remark 2.7. The entries a_k take integer values throughout, except in Definition 2.20 which defines the *absolute edge height* Δ . This may be useful in future work.

Observe that thread events satisfy the obvious relations

$$\Theta_{xy}(-) \supset \Theta_{xy}(a_1) \supset \Theta_{xy}(a_1, a_2) \supset \dots \quad (8)$$

Moreover, (4) may now be written

$$1_{\Theta_{xy}(-)} e^{-T_{xy}} dT_{xy},$$

its final form. By replacing (4) by this formula for each edge simultaneously, we obtain

$$\mu_{\Lambda, \tau, \xi} = \frac{1}{Z_{\Lambda, \tau, \xi}} \left(\prod_{xy \in \mathbb{E}(\Lambda)} 1_{\Theta_{xy}(-)} e^{-T_{xy}} dT_{xy} \right) \lambda^\Lambda.$$

2.5. Conditioning on thread events. We will now see how truncated potentials arise. Let $xy \in \mathbb{E}_\circ(\Lambda)$, so that h_x and h_y are well-defined and $\tau_{xy} = 0$. We shall often condition simultaneously on some thread event (with integer entries) and on $\{h_x = a_0\}$ for $a_0 \in \mathbb{Z}$. Observe that, writing

$$\tau' := \tau_\circ(a_0, \dots, a_n); \quad \xi' := \xi_\circ(a_0, \dots, a_n),$$

we have

$$\begin{aligned} \{h_x = a_0\} \cap \Theta_{xy}(a_1, \dots, a_n) &= \{h_x = a_0\} \cap \{\tau' + |h_y - \xi'| \leq \ell(xy)\} \\ &= \{h_x = a_0\} \cap \{V(\tau' + |h_y - \xi'|) \leq T_{xy}\} \\ &= \{h_x = a_0\} \cap \{V^{[\tau']}(h_y - \xi') \leq T_{xy}\}. \end{aligned} \quad (9)$$

What (9) makes clear is that conditioning on $\{h_x = a_0\}$ and on the thread event effectively replaces the potential function $V(h_y - h_x)$ by $V^{[\tau']}(h_y - \xi')$. This will be made explicit later, when introducing *exploration events*. Similarly, if $xy \in \partial_e \Lambda$, then

$$\begin{aligned} \Theta_{xy}(a_1, \dots, a_n) &= \{\tau' + |h_y - \xi'| \leq \ell(xy)\} \\ &= \{V^{[\tau_{xy}]}(\tau' + |h_y - \xi'|) \leq T_{xy}\} \\ &= \{V^{[\tau_{xy} + \tau']}(h_y - \xi') \leq T_{xy}\}, \end{aligned} \quad (10)$$

where $\tau' := \tau_o(\xi_{xy}, a_1, \dots, a_n)$ and $\xi' := \xi_o(\xi_{xy}, a_1, \dots, a_n)$.

2.6. Target height explorations. We want to describe the law of $\mu_{\Lambda, \tau, \xi}$ after running a particular type of exploration processes. This conditional law is given by conditioning $\mu_{\Lambda, \tau, \xi}$ on an *exploration event*.

Definition 2.8 (Exploration events). Let $\Lambda' \subset \Lambda$, and write $A := \Lambda \setminus \Lambda'$ for its complement. By an *exploration event* we mean an event that is the intersection of the following events:

1. The event $\{h|_A = f\}$ for some function f ,
2. An event Y which is measurable in terms of $h|_A$ and $(T_{xy})_{xy \in \mathbb{E}(\Lambda) \setminus \mathbb{E}(\Lambda')}$,
3. For each $xy \in \partial_e \Lambda'$, some event of the form $\Theta_{xy}(a^{xy})$, where

$$a^{xy} = (a_1^{xy}, \dots, a_{n(xy)}^{xy}) \subset \mathbb{Z}$$

is a possibly empty tuple of integers.

Observe that an exploration event appears at the end of an exploration process which first reveals the heights h_x of an arbitrary number of vertices, and then, at each step:

1. Selects an edge $xy \in \mathbb{E}(\Lambda)$ such that $xy \in \partial_e \Lambda$ or such that the value of h_x is known,
2. Selects a target height $a \in \mathbb{Z}$,
3. Reveals if the event Z occurs, where

$$Z := \begin{cases} \Theta_{xy}(a) & \text{if } xy \text{ was not considered before,} \\ \Theta_{xy}(a_1, \dots, a_n, a) & \text{if } xy \text{ was considered before,} \\ & \text{and the occurrence of } \Theta_{xy}(a_1, \dots, a_n) \\ & \text{was revealed on the last occasion,} \end{cases}$$

4. Reveals the height of h_y if Z does not occur.

The following lemma describes the conditional law of an exploration ending in an exploration event. The lemma may appear technical, but expresses a simple idea: that the conditional law within Λ' is that of an independent height functions model with truncated potentials on the boundary edges. Its proof relies on straightforward manipulations of measures; all we do is reordering the Radon-Nikodym derivatives, and making some simple replacements using the identities derived above.

Lemma 2.9 (Conditioning on exploration events). *Consider the measure $\mu := \mu_{\Lambda, \tau, \xi}$, and let X denote an exploration event defined in terms of Λ' , f , Y , and the family $(a^{xy})_{xy}$ as in the definition, and which occurs with positive probability. Define $\tau', \xi' : \partial_e \Lambda' \rightarrow \mathbb{Z}$ by*

$$\begin{aligned} \tau'_{xy} &:= \tau_{xy} + \tau_o(f_{xy}, a_1^{xy}, \dots, a_{n(xy)}^{xy}), & \xi'_{xy} &:= \xi_o(f_{xy}, a_1^{xy}, \dots, a_{n(xy)}^{xy}); \\ f_{xy} &:= \begin{cases} f_x & \text{if } xy \in \mathbb{E}_o(\Lambda), \\ \xi_{xy} & \text{if } xy \in \partial_e \Lambda, \end{cases} \end{aligned}$$

and write $A := \Lambda \setminus \Lambda'$ and $E := \mathbb{E}(\Lambda) \setminus \mathbb{E}(\Lambda')$. Then the measure $\mu(\cdot | X)$ is given by

$$\begin{aligned} \mu(\cdot | X) &= \frac{1}{\mu(X) Z_{\Lambda, \tau, \xi}} \left(1_Y \prod_{xy \in E} 1_{\{\rho_{xy} \geq 0\}} e^{-\rho_{xy}} d\rho_{xy} \right) \\ &\quad \left(\prod_{xy \in \partial_e \Lambda'} 1_{\Theta_{xy}(a^{xy})} e^{-T_{xy}} dT_{xy} \right) \left(\prod_{xy \in \mathbb{E}_o(\Lambda')} 1_{\Theta_{xy}(-)} e^{-T_{xy}} dT_{xy} \right) \left(\delta_f \times \lambda^{\Lambda'} \right) \\ &= \frac{Z_{\Lambda', \tau', \xi'}}{\mu(X) Z_{\Lambda, \tau, \xi}} \left(1_Y \prod_{xy \in E} 1_{\{\rho_{xy} \geq 0\}} e^{-\rho_{xy}} d\rho_{xy} \times \delta_f \right) \times \bar{\mu}_{\Lambda', \tau', \xi'} \end{aligned}$$

where $\bar{\mu}_{\Lambda', \tau', \xi'}$ is defined by

$$\bar{\mu}_{\Lambda', \tau', \xi'} := \frac{1}{Z_{\Lambda', \tau', \xi'}} e^{-H_{\Lambda', \tau', \xi'}} \lambda^{\Lambda'} \times \prod_{xy \in \mathbb{E}(\Lambda')} 1_{\{\bar{\rho}_{xy} \geq 0\}} e^{-\bar{\rho}_{xy}} d\bar{\rho}_{xy}.$$

Notice that this definition is equal to that of $\mu_{\Lambda', \tau', \xi'}$ except that the residuals are decorated with bars. The new residuals $\bar{\rho}$ arise directly in terms of the original residuals ρ through the identity

$$\bar{\rho}_{xy} := T_{xy} - \begin{cases} V(h_y - h_x) & \text{if } xy \in \mathbb{E}_o(\Lambda'), \\ V^{[\tau'_{xy}]}(h_y - \xi'_{xy}) & \text{if } xy \in \partial_e \Lambda', \end{cases} \quad (11)$$

where we recall that $T_{xy} = V^{[\tau_{xy}]}(\nabla h_{xy}) + \rho_{xy}$.

Proof. The proof is actually straightforward, even though there are many Radon-Nikodym derivatives. For the first equality, we absorb the conditioning event $\{h|_A = f\}$ into the measure δ_f , and insert all other conditioning events as indicators, noting that $\Theta_{xy}(a^{xy}) \subset \Theta_{xy}(-)$ for $xy \in \partial_e \Lambda'$ to justify the fact that we left out indicators for the latter event. The second equality follows from (7), (9), (10), and (11), and a careful rearrangement of variables. \square

Two measures appear in Lemma 2.9: the conditioned measure $\mu(\cdot | X)$, as well as the measure $\bar{\mu}_{\Lambda', \tau', \xi'}$. By convention, all random objects defined with respect to $(h|_{\Lambda'}, \bar{\rho})$ are marked with a bar. Let us quickly discuss how to relate thread events of the original measure μ to *adapted thread events*, namely those defined in terms of $(h|_{\Lambda'}, \bar{\rho})$. It is straightforward to work out from (11) that for the adapted thread event $\bar{\Theta}_{xy}(a_1, \dots, a_n)$, we have

$$X \cap \bar{\Theta}_{xy}(a_1, \dots, a_n) = X \cap \begin{cases} \Theta_{xy}(a_1, \dots, a_n) & \text{if } xy \in \mathbb{E}_o(\Lambda'), \\ \Theta_{xy}(a_1^{xy}, \dots, a_n^{xy}, a_1, \dots, a_n) & \text{if } xy \in \partial_e \Lambda'. \end{cases}$$

In other words, the event $\bar{\Theta}_{xy}(a_1, \dots, a_n)$ measures if we may extend the thread arrangement which we already know exists into one that also reaches to the heights a_1, \dots, a_n in that order. Recall from (8) that this implies the convenient inclusion

$$X \cap \bar{\Theta}_{xy}(a_1, \dots, a_n) \subset X \cap \Theta_{xy}(a_1, \dots, a_n). \quad (12)$$

Thus, if we find adapted thread events which occur for the measure $\bar{\mu}_{\Lambda', \tau', \xi'}$, then the corresponding thread events also occur for the original measure μ .

2.7. Level lines.

Definition 2.10 (The planar dual). Write $(\mathbb{F}, \mathbb{E}^*)$ for the dual graph of the square lattice $(\mathbb{Z}^2, \mathbb{E})$, with \mathbb{F} denoting the set of *faces*, and \mathbb{E}^* denoting the set of *dual edges*. The dual of an edge $xy \in \mathbb{E}$ is denoted $xy^* \in \mathbb{E}^*$. If \mathcal{X} is a subset of \mathbb{E} or \mathbb{E}^* , then \mathcal{X}^* denotes the set of edges dual to edges in \mathcal{X} . We shall also typically write \mathcal{X}° for the dual-complement of \mathcal{X} .

The pair $(\mathcal{X}, \mathcal{X}^\circ)$ is the pair to which classical planar duality arguments apply.

Definition 2.11 (Percolation events). For $A, B, R \subset \mathbb{Z}^2$ and for $\mathcal{X} \subset \mathbb{E}$, we say that A is \mathcal{X} -connected to B in R , and write

$$A \xleftrightarrow{\mathcal{X} \text{ in } R} B,$$

if \mathcal{X} contains a path from a vertex in A to a vertex in B which only visits vertices in R . If instead $\mathcal{X} \subset \mathbb{Z}^2$, then the notation indicates the existence of a path using only vertices in $\mathcal{X} \cap R$. If the R is omitted from the notation then it is tacitly understood that $R = \mathbb{Z}^2$. The complementary event is denoted

$$A \xleftrightarrow{\not\mathcal{X} \text{ in } R} B.$$

Similar notations are used for the dual graph.

Definition 2.12 (Increasing functions). Next, we define *increasing* and *decreasing* maps. A map $f : X \rightarrow Y$ between two partially ordered sets (X, \leq) and (Y, \leq) is called *increasing* if $x \leq x'$ implies $f(x) \leq f(x')$ and *decreasing* if $x \leq x'$ implies $f(x) \geq f(x')$. We shall sometimes say that f is *increasing in x* or *decreasing in x* without referring to the sets. The choice of partial orders is usually clear and left implicit: typically it is \subset (for set-valued maps) or \leq (for maps taking values in a set of real-valued functions). These properties behave well under composition of maps. An event is called *increasing* or *decreasing* if its indicator is increasing or decreasing respectively as a function on the (partially ordered) underlying sample space.

Throughout this subsection, we consider boundary conditions $(\Lambda, \tau, \xi) \in \text{Bound}$ and a random pair $(h, \rho) \in \mathbb{Z}^\Lambda \times \mathbb{R}^{\mathbb{E}(\Lambda)}$ with nonnegative residuals. For $\Lambda \subset \mathbb{Z}^2$, let $\partial_v \Lambda \subset \mathbb{Z}^2 \setminus \Lambda$ denote the *vertex boundary* of Λ , that is, the set of vertices adjacent to Λ . We now define all percolations which appear in this article; see also Figure 5.

Definition 2.13 (Level lines). Define the following five percolations for each $a \in \mathbb{Z}$:

1. The *level lines*

$$\mathcal{L}_a := \{xy^* \in \mathbb{E}^*(\Lambda) : (h, \rho) \in \Theta_{xy}(a)\} \subset \mathbb{E}^*(\Lambda),$$

2. The *FK-Ising percolation*

$$\mathcal{L}_a^\diamond := \{xy \in \mathbb{E}(\Lambda) : (h, \rho) \notin \Theta_{xy}(a)\} \subset \mathbb{E}(\Lambda),$$

3. The *invasion percolation*

$$\mathcal{K}_a := \{xy \in \mathcal{L}_a^\diamond : x \xleftrightarrow{\mathcal{L}_a^\diamond} \partial_v \Lambda\} \subset \mathcal{L}_a^\diamond \subset \mathbb{E}(\Lambda),$$

4. The *invasion dual*

$$\mathcal{K}_a^* := \{xy^* \in \mathbb{E}^* : xy \notin \mathcal{K}_a\} \subset \mathbb{E}^*,$$

5. The *symmetric invasion percolation*

$$\mathcal{K}_a^* := \mathbb{E} \setminus \{xy \in \mathbb{E} : x \in \Lambda \text{ and } xz \in \mathcal{K}_a \text{ for some } z \in \mathbb{Z}^2\} \subset \mathbb{E}.$$

Obviously \mathcal{L}_a^\diamond , \mathcal{K}_a , \mathcal{K}_a^\diamond , and \mathcal{K}_a^* are decreasing, decreasing, increasing, and increasing respectively in \mathcal{L}_a . We also define $\mathcal{L}_{\leq a} := \cup_{b \leq a} \mathcal{L}_b$, the *lower level lines*, and $\mathcal{L}_{\geq a} := \cup_{b \geq a} \mathcal{L}_b$, the *upper level lines*. We shall occasionally also consider the dual-complements of these percolations (marked with the symbol \diamond), which are subsets of $\mathbb{E}(\Lambda)$.

Observe that, by slight abuse of notation, \mathcal{L}_a and \mathcal{L}_a^\diamond are complementary to each other with respect to the edges around Λ , while \mathcal{K}_a and \mathcal{K}_a^\diamond are complementary to each other with respect to the entire square lattice.

The main interest is in the first three percolations. The last two percolations play important roles in the proofs. The remainder of this section derives a number of simple relations between the various percolations and the height function.

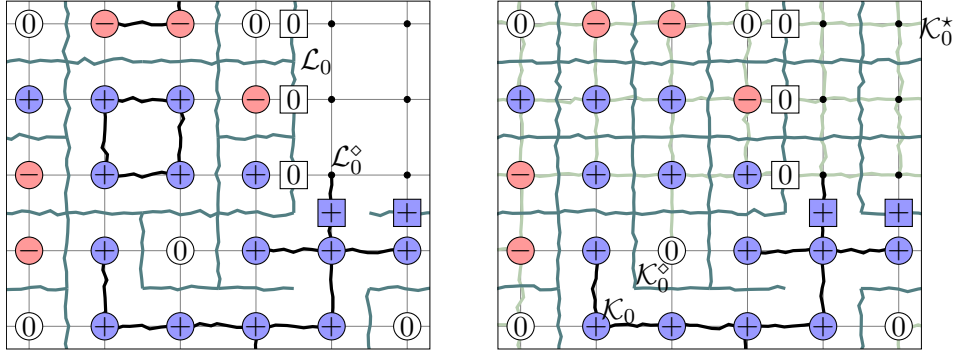

FIGURE 5. A sample from $\mu_{\Lambda, \tau, \xi}$ with the percolations, relative to the reference height $a = 0$. Only the signs of the heights are given. The heights on Λ are represented by circles; the heights on the boundary by squares. LEFT: The primal percolation (black) is \mathcal{L}_0^\diamond , the dual percolation (aquamarine) is \mathcal{L}_0 . Observe that each edge in \mathcal{L}_0^\diamond connects vertices of the same sign. The percolation $\mathcal{L}_{\leq 0}^\diamond$ (not drawn) contains precisely those edges of \mathcal{L}_0^\diamond which are incident to vertices of positive height. RIGHT: The black primal percolation is \mathcal{K}_0 , the light green primal percolation is \mathcal{K}_0^* , and the dual percolation (aquamarine) is \mathcal{K}_0^\diamond . Note that \mathcal{K}_0^* and \mathcal{K}_0^\diamond are also defined away from Λ . The percolations \mathcal{K}_0 and \mathcal{K}_0^* do not meet, except at $\partial_v \Lambda$. Moreover, if an edge xy belongs to \mathcal{K}_0^* and is not incident to $\partial_v \Lambda$, then its dual xy^* , as well as the six dual edges surrounding xy , are contained in \mathcal{K}_0^\diamond .

- Theorem 2.14** (Intermediate value theorem for threads). *1. If $a \in [h_x, h_y]$ for some edge $xy \in \mathbb{E}_o(\Lambda)$ (or $a \in [\xi_{xy}, h_y]$ for some $xy \in \partial_e \Lambda$), then any thread arrangement passes through a by the intermediate value theorem, and hence $xy^* \in \mathcal{L}_a$. Similarly, for each $xy \in \mathbb{E}(\Lambda)$, the set $\{a \in \mathbb{Z} : xy^* \in \mathcal{L}_a\}$ consists of finitely many consecutive integers.*
- 2. Since \mathcal{L}_a^\diamond is the dual-complement of \mathcal{L}_a , we observe that \mathcal{L}_a^\diamond connects vertices whose height lies strictly on the same side of a .*

The proof of the theorem is immediate from the definitions. We prove in Lemma 3.3 that $(h, \mathcal{L}_a^\diamond)$ is the Edwards-Sokal coupling of the Ising model that arises as the sign distribution of $h - a$ conditional on $|h - a|$. In particular, this implies that exploring a circuit of \mathcal{L}_a from the outside induces flip symmetry for the heights within this contour around the height a , which is consistent with Lemma 2.9 and Theorem 2.4.

Lemma 2.15 (The level lines conditional on the height function). *Conditional on h , \mathcal{L}_a is an independent bond percolation, with the probability of the event $\{xy^* \in \mathcal{L}_a\}$ given by*

$$e^{V^{[\tau_{xy}]}(h_y - h_{xy}) - V^{[\tau_{xy}]}(\tau_o(h_{xy}, a, h_y))}, \quad h_{xy} := \begin{cases} h_x & \text{if } xy \in \mathbb{E}_o(\Lambda), \\ \xi_{xy} & \text{if } xy \in \partial_e \Lambda. \end{cases}$$

In particular, this probability equals 1 whenever $a \in [h_{xy}, h_y]$.

Proof. Each event $\{xy^* \in \mathcal{L}_a\}$ depends only on h and ρ_{xy} , while the family ρ consists of independent exponential random variables. Therefore \mathcal{L}_a is an independent bond percolation after conditioning on h . We first rewrite the event $\Theta_{xy}(a)$ as

$$\begin{aligned} \Theta_{xy}(a) &= \{V^{[\tau_{xy}]}(\tau_o(h_{xy}, a, h_y)) \leq T_{xy}\} \\ &= \{V^{[\tau_{xy}]}(\tau_o(h_{xy}, a, h_y)) \leq V^{[\tau_{xy}]}(h_y - h_{xy}) + \rho_{xy}\} \\ &= \{\rho_{xy} \geq V^{[\tau_{xy}]}(\tau_o(h_{xy}, a, h_y)) - V^{[\tau_{xy}]}(h_y - h_{xy})\}. \end{aligned}$$

The first equality holds true because of (5) and (6); the others follow by expanding the definition of T_{xy} and rearranging. The lemma is now clear because ρ_{xy} is an exponential random variable. \square

We also collect some simple results regarding the percolation $\mathcal{L}_{\leq a}$.

Proposition 2.16 (Characterisation of lower level lines). *Note that $xy^* \in \mathcal{L}_{\leq a}$ if and only if one of the following two statements holds true:*

1. $\min\{h_x, h_y\} \leq a$,
2. $\min\{h_x, h_y\} > a$ and $xy^* \in \mathcal{L}_a$.

In particular, the percolation $\mathcal{L}_{\leq a}$ is an increasing function of $(-h, \rho)$. Moreover, by considering also the symmetric statements for the percolation $\mathcal{L}_{\geq a}$, we deduce that:

1. We have $\mathcal{L}_a = \mathcal{L}_{\leq a} \cap \mathcal{L}_{\geq a}$,
2. We can write \mathcal{L}_a^\diamond as the disjoint union of $\mathcal{L}_{\leq a}^\diamond$ and $\mathcal{L}_{\geq a}^\diamond$, where the first percolation contains the FK-Ising edges connecting vertices in $\{h > a\}$ and the second vertices in $\{h < a\}$.

Proof. The first statement follows from the intermediate value theorem. For the second statement, it suffices to show that the event $\{xy^* \in \mathcal{L}_{\leq a}\}$ is increasing in $(-h, \rho)$ when we restrict to height functions h which satisfy $h > a$. This follows from the previous lemma and convexity of $V^{[\tau_{xy}]}$. The final statements regarding \mathcal{L}_a and its dual-complement follow from the first two statements. \square

Consider the invasion percolation $\mathcal{K}_a \subset \mathcal{L}_a^\diamond$. Each connected component of \mathcal{K}_a connects vertices whose height lies strictly on the same side of a . However, since each connected component of \mathcal{K}_a intersects $\partial_v \Lambda$, it can be read off from the boundary height function ξ on which side of a these heights lie. This implies the following lemma. In practice, the interest is restricted to the height $a = 0$, which is why we specialise to this case.

Lemma 2.17 (Invasion percolation is twice measurable). *If $\xi \geq 0$, then \mathcal{K}_0 connects vertices with positive height. This means that \mathcal{K}_0 is measurable in terms of $\mathcal{L}_{\leq 0}$; it is*

$$\mathcal{K}_0 = \{xy \in \mathcal{L}_{\leq 0}^\diamond : x \xleftarrow{\mathcal{L}_{\leq 0}^\diamond} \partial_v \Lambda \rightarrow y\}.$$

In particular, \mathcal{K}_0 is measurable and decreasing in both \mathcal{L}_0 and $\mathcal{L}_{\leq 0}$.

This last fact is extremely useful because we shall establish *distinct* FKG inequalities for level lines and lower level lines. Next, we state some simple relations between different percolations. Observe that by definition, \mathcal{K}_a and \mathcal{K}_a^\diamond are the planar dual to one another, which means in particular that these percolations must respect the planarity of the square lattice. The following proposition follows from the fact that no vertex (except those in $\partial_v \Lambda$) can be incident to both an edge in \mathcal{K}_a and an edge in \mathcal{K}_a^\diamond (see Figure 5, RIGHT).

Proposition 2.18 (Relation between \mathcal{K}_a^\diamond , \mathcal{K}_a^* , and \mathcal{L}_a^\diamond). *If a primal edge $xy \in \mathcal{K}_a^*$ is not incident to $\partial_v \Lambda$, then xy^* , as well as the six dual edges in the circuit of minimal length surrounding the primal edge xy , are contained in \mathcal{K}_a^\diamond . Moreover, if $X \subset \mathcal{L}_a^\diamond$ is a connected component of \mathcal{L}_a^\diamond that does not connect to $\partial_v \Lambda$, then $X \subset \mathcal{K}_a^*$. This means that $X^* \subset \mathcal{K}_a^\diamond$, and the six dual edges surrounding any edge in X , are also contained in \mathcal{K}_a^\diamond .*

Equation (12) applies to the new context as follows.

Remark 2.19. Suppose that we first run some exploration process, and then explore level lines $\bar{\mathcal{L}}_a$ in the conditional measure. By (12), we know that $\bar{\mathcal{L}}_a \subset \mathcal{L}_a$, that is, level lines in the conditioned measure appear also as level lines of the original measure.

Finally, we associate an absolute height to each edge.

Definition 2.20 (The absolute edge height). For a given boundary condition $(\Lambda, \tau, \xi) \in \text{Bound}$ and for a given configuration (h, ρ) with nonnegative residuals, we define, for each $xy \in \mathbb{E}(\Lambda)$, the random variable

$$\Delta_{xy} = \min\{a \in \mathbb{Z}_{\geq 0}/2 : \text{the event } \Theta_{xy}(a) \cup \Theta_{xy}(-a) \text{ occurs}\}$$

Observe that $\mathcal{L}_0 = \{\Delta = 0\}^*$.

The random variable Δ_{xy} may be interpreted geometrically as follows: take the thread at xy of maximal length, pull it towards 0 as far as possible, and then set Δ_{xy} equal to the absolute value of the resulting height, with no rounding. We think of Δ_{xy} as denoting the *distance* of the thread towards the height 0. By definition of the level lines we have

$$\begin{aligned} \lceil \Delta_{xy} \rceil &= \min\{a \in \mathbb{Z}_{\geq 0} : xy^* \in \mathcal{L}_{-a} \cup \mathcal{L}_a\} \\ &= \min\{a \in \mathbb{Z}_{\geq 0} : xy^* \in \mathcal{L}_{\geq -a} \cap \mathcal{L}_{\leq a}\}. \end{aligned}$$

3. CORRELATION INEQUALITIES

3.1. Statements. This section establishes four results:

1. Positive association for the height function h (Lemma 3.1),
2. Positive association for the absolute value $|h|$ (Lemma 3.2),
3. An Ising model decomposition of the law of h conditional on $|h|$ (Lemma 3.3),
4. Monotonicity of the law of $|h|$ in the choice of the geometric domain (Lemma 3.6).

These are stated in this first subsection; the remaining subsections contain the proofs. Although the precise formulation of each lemma is new, the proofs were already in [LO21] in spirit; the challenge here lies merely in the technical details. The lemmas serve as black boxes in the remainder of the article and the reader may choose to skip the proofs on a first reading.

Lemma 3.1 (Positive association for heights). *1. **FKG inequality.** Let $(\Lambda, \tau, \xi) \in \text{Bound}$ and consider two functions $f, g : \mathbb{Z}^\Lambda \times \mathbb{R}^{\mathbb{E}(\Lambda)} \rightarrow \mathbb{R}$ which are increasing in $(-h, \rho)$ and square-integrable in $\mu_{\Lambda, \tau, \xi}$. Then f and g are positively correlated, in the sense that*

$$\mu_{\Lambda, \tau, \xi}(fg) \geq \mu_{\Lambda, \tau, \xi}(f)\mu_{\Lambda, \tau, \xi}(g).$$

2. **Monotonicity in the boundary heights.** Consider a fixed geometric domain $(\Lambda, \tau) \in \text{Geom}$ and two boundary height functions $\xi, \xi' : \partial_e \Lambda \rightarrow \mathbb{Z}$ with $\xi \leq \xi'$. Then for any function $f : \mathbb{Z}^\Lambda \times \mathbb{R}^{\mathbb{E}(\Lambda)} \rightarrow \mathbb{R}$ which is increasing in $(-h, \rho)$, we have

$$\mu_{\Lambda, \tau, \xi}(f) \geq \mu_{\Lambda, \tau, \xi'}(f)$$

whenever f is integrable with respect to both measures.

For the second part of the previous lemma, the inequality is in this direction because f is decreasing in $(h, -\rho)$. Recall from Proposition 2.16 that for fixed $a \in \mathbb{Z}$ the lower level line $\mathcal{L}_{\leq a}$ is increasing in $(-h, \rho)$, and therefore the lemma holds true for increasing functions and events of this percolation as well.

We now turn to the analysis of the law of $|h|$. For this it is important that the boundary height ξ takes nonnegative values.

Lemma 3.2 (Positive association for absolute heights). *1. **FKG inequality.** Fix a boundary condition $(\Lambda, \tau, \xi) \in \text{Bound}_{\geq 0}$. Consider two functions $f, g : \mathbb{Z}^\Lambda \times \mathbb{R}^{\mathbb{E}(\Lambda)} \rightarrow \mathbb{R}$ which are measurable and increasing in $(|h|, \Delta)$. Then f and g are positively correlated in $\mu_{\Lambda, \tau, \xi}$, in the sense that*

$$\mu_{\Lambda, \tau, \xi}(fg) \geq \mu_{\Lambda, \tau, \xi}(f)\mu_{\Lambda, \tau, \xi}(g).$$

2. **Monotonicity in the boundary heights.** Fix a geometric domain $(\Lambda, \tau) \in \text{Geom}$, and let $\xi, \xi' : \partial_e \Lambda \rightarrow \mathbb{Z}_{\geq 0}$ denote two functions which satisfy $\xi \leq \xi'$. Let $f : \mathbb{Z}^\Lambda \times \mathbb{R}^{\mathbb{E}(\Lambda)} \rightarrow \mathbb{R}$ denote a function which is measurable and increasing in $(|h|, \Delta)$. Then

$$\mu_{\Lambda, \tau, \xi}(f) \leq \mu_{\Lambda, \tau, \xi'}(f)$$

whenever f is integrable for both measures.

Recall that $\mathcal{L}_0 = \{\Delta = 0\}^*$; the lemma applies for decreasing functions in terms of this percolation as well. We shall also need one slight variation of this lemma, stated as Lemma 3.12 below.

The proof of the above lemma relies on an Ising model decomposition, which we state now because it is also occasionally used elsewhere.

Lemma 3.3 (Ising model decomposition). Consider $(\Lambda, \tau, \xi) \in \text{Bound}_{\geq 0}$ and fix $\zeta : \Lambda \rightarrow \mathbb{Z}_{\geq 0}$. Let $\sigma := \text{Sign } h : \Lambda \rightarrow \{\pm 1\}$, flipping a fair, independent coin for each vertex $x \in \Lambda$ where $h_x = 0$. Consider the conditioned measure

$$\mu := \mu_{\Lambda, \tau, \xi}(\cdot | \{|h| = \zeta\}).$$

Then the law of $(\sigma, \mathcal{L}_0^\otimes)$ is that of a ferromagnetic Ising model in Λ with coupling constants $(K_{xy}(\zeta))_{xy}$ (stated explicitly in (14) below) and + boundary conditions outside Λ , coupled with its natural FK-Ising percolation. Finally, the family $(K_{xy}(\Lambda, \tau, \xi, \zeta))_{xy}$ is increasing in the functions $\xi, \zeta \geq 0$.

Positive association for absolute heights allows us to draw a comparison between different geometric domains. We start with a formal definition of a partial order on the sets of domains and boundary conditions, then state our lemma.

Definition 3.4 (Comparison of geometric domains). Recall that Geom is the set of geometric domains (Λ, τ) , which we now turn into a partially ordered set (Geom, \preceq) . Let $(\Lambda, \tau), (\Lambda', \tau') \in \text{Geom}$. We say that (Λ, τ) is *smaller* than (Λ', τ') , and write $(\Lambda, \tau) \preceq (\Lambda', \tau')$, whenever $\Lambda \subset \Lambda'$ and if $\tau|_E \geq \tau'|_E$ on the set $E := \partial_e \Lambda \cap \partial_e \Lambda'$. For $n, m \in \mathbb{Z}_{\geq 1}$ with $n \leq m$, write

$$\text{Geom}_{n,m} := \{(\Lambda, \tau) \in \text{Geom} : (\Lambda_n, 0) \preceq (\Lambda, \tau) \preceq (\Lambda_m, 0)\}.$$

Intuitively, the definition means that $(\Lambda, \tau) \preceq (\Lambda', \tau')$ whenever the first domain is smaller in terms of vertices and more truncated in terms of the boundary truncation function.

Definition 3.5 (Comparison of boundary conditions). Recall that $\text{Bound}_{\geq 0}$ is the set of boundary conditions (Λ, τ, ξ) with $\xi \geq 0$. Let $(\Lambda, \tau, \xi), (\Lambda', \tau', \xi') \in \text{Bound}_{\geq 0}$. We say that (Λ, τ, ξ) is *smaller* than (Λ', τ', ξ') , and write $(\Lambda, \tau, \xi) \preceq (\Lambda', \tau', \xi')$, if all of the following hold true:

1. The first geometric domain is included in the second, that is,
 - $(\Lambda, \tau) \preceq (\Lambda', \tau')$,
2. The domains look geometrically identical on $E := \{\xi \neq 0\} \subset \partial_e \Lambda$, that is,
 - $E \subset \partial_e \Lambda'$,
 - $\tau|_E = \tau'|_E$,
3. The heights of the second domain dominate the heights of the first, that is,
 - $\xi|_E \leq \xi'|_E$.

Observe that $(\text{Bound}_{\geq 0}, \preceq)$ is a partially ordered set.

The second requirement—that the domains look the same geometrically in places where the first boundary height function takes strictly positive values—turns out to be a necessary condition which confronts us with several challenges throughout this article.

We are now ready to state our lemma.

Lemma 3.6 (Monotonicity in domains). *Consider $(\Lambda, \tau, \xi), (\Lambda', \tau', \xi') \in \text{Bound}_{\geq 0}$ with $(\Lambda, \tau, \xi) \preceq (\Lambda', \tau', \xi')$. Let f denote a real-valued function which is measurable and increasing in $(|h|_\Lambda, \Delta|_{\mathbb{E}(\Lambda)})$. Then*

$$\mu_{\Lambda, \tau, \xi}(f) \leq \mu_{\Lambda', \tau', \xi'}(f)$$

as soon as f is integrable in both measures.

We now define some simple constructions for creating larger boundary conditions from smaller ones. Suppose given a boundary condition $(\Lambda, \tau, \xi) \in \text{Bound}$. If Σ is a symmetry of the square lattice, then we write $\Sigma\tau := \tau \circ \Sigma^{-1}$ and $\Sigma\xi := \xi \circ \Sigma^{-1}$ so that $(\Sigma\Lambda, \Sigma\tau, \Sigma\xi) \in \text{Bound}$. We will occasionally combine a boundary condition with its symmetric counterpart.

Definition 3.7 (Union of boundary conditions). Suppose given $(\Lambda, \tau, \xi), (\Lambda', \tau', \xi') \in \text{Bound}_{\geq 0}$. Define the boundary condition

$$(\Lambda, \tau, \xi) \cup (\Lambda', \tau', \xi') := (\Lambda'', \tau'', \xi'') \in \text{Bound}_{\geq 0},$$

where $\Lambda'' := \Lambda \cup \Lambda'$ and where τ'' and ξ'' are defined by

$$\begin{aligned} \tau'' : \partial_e \Lambda'' \rightarrow \mathbb{Z}, xy \mapsto & \begin{cases} \tau_{xy} \wedge \tau'_{xy} & \text{if } xy \in \partial_e \Lambda \cap \partial_e \Lambda', \\ \tau_{xy} & \text{if } xy \in \partial_e \Lambda \setminus \partial_e \Lambda', \\ \tau'_{xy} & \text{if } xy \in \partial_e \Lambda' \setminus \partial_e \Lambda, \end{cases} \\ \xi'' : \partial_e \Lambda'' \rightarrow \mathbb{Z}, xy \mapsto & (1_{xy \in \partial_e \Lambda} \cdot \xi_{xy}) \vee (1_{xy \in \partial_e \Lambda'} \cdot \xi'_{xy}). \end{aligned}$$

Define $(\Lambda, \tau, \xi) \cup^* (\Lambda', \tau', \xi') \in \text{Bound}_{\geq 0}$ in the same way, except that in this case Λ'' is the smallest set containing $\Lambda \cup \Lambda'$ and whose complement is connected.

Remark 3.8. In a typical situation, we would like to take the union of two boundary conditions

$$(\Lambda'', \tau'', \xi'') := (\Lambda, \tau, \xi) \cup (\Lambda', \tau', \xi'),$$

and conclude that

$$(\Lambda, \tau, \xi) \preceq (\Lambda'', \tau'', \xi'').$$

To verify this inclusion, we must check the second requirement in Definition 3.5: that the two domains look geometrically identical on the set $\{\xi > 0\}$. It is easy to see that the remaining two requirements are automatically satisfied by the definition of the union. Similar considerations apply when \cup is replaced by \cup^* .

3.2. Inequalities for heights. We start with the proof of Lemma 3.1.

Lemma 3.9 (FKG lattice condition for heights). *Fix a geometric domain $(\Lambda, \tau) \in \text{Geom}$. Then*

$$(\xi, h) \mapsto H_{\Lambda, \tau, \xi}(h)$$

satisfies the FKG lattice condition, in the sense that

$$H_{\Lambda, \tau, \xi \wedge \xi'}(h \wedge h') + H_{\Lambda, \tau, \xi \vee \xi'}(h \vee h') \leq H_{\Lambda, \tau, \xi}(h) + H_{\Lambda, \tau, \xi'}(h')$$

for any $\xi, \xi' : \partial_e \Lambda \rightarrow \mathbb{Z}$ and $h, h' : \Lambda \rightarrow \mathbb{Z}$.

Proof. The proof follows immediately from the definition of $H_{\Lambda, \tau, \xi}$ and from convexity of each potential function $V^{[\tau_{xy}]}$. \square

The inequalities in Lemma 3.1 are direct corollaries of the FKG lattice condition; see the original work of Holley [Hol74] or the book on the random-cluster model of Grimmett [Gri06, Chapter 2] for details.

3.3. Inequalities for absolute heights. We now prove Lemma 3.2 and Lemma 3.3, and we also state and prove Lemma 3.12 which is slightly different from Lemma 3.2. The inequalities are harder to prove because several samples h correspond to the same value for $|h|$. We must also restrict to nonnegative boundary conditions $(\Lambda, \tau, \xi) \in \mathbf{Bound}_{\geq 0}$. The arguments presented adapt the proofs in [LO21], and are tailored to the more detailed setup with generalised boundary conditions.

Throughout this subsection, we write $M_{\Lambda, \tau, \xi}$ for the non-normalised version of $\mu_{\Lambda, \tau, \xi}$, that is, the measure defined by

$$M_{\Lambda, \tau, \xi} := Z_{\Lambda, \tau, \xi} \mu_{\Lambda, \tau, \xi}.$$

We first argue that h becomes an Ising model once we condition $\mu_{\Lambda, \tau, \xi}$ on the event $\{|h| = \zeta\}$ for some ζ . Fix $(\Lambda, \tau, \xi) \in \mathbf{Bound}_{\geq 0}$ and consider some function $\zeta : \Lambda \rightarrow \mathbb{Z}_{\geq 0}$. If $|h| = \zeta$, then $h = \sigma\zeta$ for some $\sigma \in \{\pm 1\}^\Lambda$, and if we agree on the convention that $\sigma_x := +1$ for $x \in \mathbb{Z}^2 \setminus \Lambda$, then $H_{\Lambda, \tau, \xi}(h)$ can be written

$$H_{\Lambda, \tau, \xi}(h) = H_{\Lambda, \tau, \xi}(\sigma\zeta) = \sum_{xy \in \mathbb{E}(\Lambda)} (F_{xy}(\zeta) - \sigma_x \sigma_y K_{xy}(\zeta)), \quad (13)$$

where

$$F_{xy}(\zeta) = F_{xy}(\Lambda, \tau, \xi, \zeta) := \frac{1}{2} \begin{cases} V(\zeta_y - \zeta_x) + V(\zeta_y + \zeta_x) & \text{if } xy \in \mathbb{E}_o(\Lambda), \\ V^{[\tau_{xy}]}(\zeta_y - \xi_{xy}) + V^{[\tau_{xy}]}(\zeta_y + \xi_{xy}) & \text{if } xy \in \partial_e \Lambda, \end{cases}$$

$$K_{xy}(\zeta) = K_{xy}(\Lambda, \tau, \xi, \zeta) := -\frac{1}{2} \begin{cases} V(\zeta_y - \zeta_x) - V(\zeta_y + \zeta_x) & \text{if } xy \in \mathbb{E}_o(\Lambda), \\ V^{[\tau_{xy}]}(\zeta_y - \xi_{xy}) - V^{[\tau_{xy}]}(\zeta_y + \xi_{xy}) & \text{if } xy \in \partial_e \Lambda. \end{cases} \quad (14)$$

Remark that $K_{xy}(\Lambda, \tau, \xi, \zeta)$ is always nonnegative because $\xi, \zeta \geq 0$ and because all potential functions are convex and symmetric, and that this number is increasing in ξ and ζ for the same reasons.

Proof of Lemma 3.3. The decomposition of the Hamiltonian in (13), which is valid once we set $\sigma_x := +1$ for $x \in \mathbb{Z}^2 \setminus \Lambda$, implies that σ has the law of an Ising model with the correct coupling constants and + boundary conditions. It was mentioned above that the coupling constants are nonnegative and increasing in ξ and ζ . Lemma 2.15 implies that conditional on both $|h|$ and σ , the probability of the event $\{xy \in \mathcal{L}_0^\circ\}$ for some edge $xy \in \mathbb{E}(\Lambda)$ is exactly

$$\begin{cases} 1 - e^{-2K_{xy}(\zeta)} & \text{if } \sigma_x = \sigma_y, \\ 0 & \text{if } \sigma_x \neq \sigma_y, \end{cases}$$

independently of the states of all other edges. This proves that $(\sigma, \mathcal{L}_0^\circ)$ is the desired coupling. \square

Next, we focus on calculating $M_{\Lambda, \tau, \xi}(|h| = \zeta)$. Write $Z_{\text{Ising}}(\zeta)$ for the partition function of the Ising model, that is,

$$Z_{\text{Ising}}(\zeta) := Z_{\text{Ising}}(\Lambda, \tau, \xi, \zeta) := \sum_{\sigma \in \{\pm 1\}^\Lambda} e^{\sum_{xy \in \mathbb{E}(\Lambda)} \sigma_x \sigma_y K_{xy}(\Lambda, \tau, \xi, \zeta)}.$$

We obtain

$$\begin{aligned} M_{\Lambda, \tau, \xi}(|h| = \zeta) &= \sum_{h \in \mathbb{Z}^\Lambda \text{ with } |h| = \zeta} e^{-H_{\Lambda, \tau, \xi}(h)} = 2^{-|\{\zeta=0\}|} \sum_{\sigma \in \{\pm 1\}^\Lambda} e^{-H_{\Lambda, \tau, \xi}(\sigma\zeta)} \\ &= 2^{-|\{\zeta=0\}|} Z_{\text{Ising}}(\Lambda, \tau, \xi, \zeta) \prod_{xy \in \mathbb{E}(\Lambda)} e^{-F_{xy}(\Lambda, \tau, \xi, \zeta)}. \end{aligned} \quad (15)$$

The power of two corrects for the $2^{|\{\zeta=0\}|}$ terms in the sum corresponding to the same height function h . We are now ready to state the first FKG lattice condition, which is similar in spirit to the FKG lattice condition for heights.

Lemma 3.10 (FKG lattice condition for absolute heights). *Fix $(\Lambda, \tau) \in \text{Geom}$. Then*

$$\mathbb{Z}_{\geq 0}^{\partial_e \Lambda} \times \mathbb{Z}_{\geq 0}^{\Lambda} \rightarrow \mathbb{R}, (\xi, \zeta) \mapsto M_{\Lambda, \tau, \xi}(|h| = \zeta)$$

satisfies the FKG lattice condition, in the sense that

$$M_{\Lambda, \tau, \xi \wedge \xi'}(|h| = \zeta \wedge \zeta') M_{\Lambda, \tau, \xi \vee \xi'}(|h| = \zeta \vee \zeta') \geq M_{\Lambda, \tau, \xi}(|h| = \zeta) M_{\Lambda, \tau, \xi'}(|h| = \zeta')$$

for any functions $\xi, \xi' : \partial_e \Lambda \rightarrow \mathbb{Z}_{\geq 0}$ and $\zeta, \zeta' : \Lambda \rightarrow \mathbb{Z}_{\geq 0}$.

We first state another FKG lattice condition before providing proofs. The advantage of studying the absolute height rather than the height, is that it allows us to manipulate not only the heights on the boundary but also the location of the boundary itself. The following technical lemma is a prerequisite for this manipulation.

Lemma 3.11 (FKG lattice condition for the truncation). *Consider $(\Lambda, \tau^*, \xi) \in \text{Bound}_{\geq 0}$ and write*

$$T := \{ \tau \in \mathbb{Z}_{\geq 0}^{\partial_e \Lambda} : \tau|_{\{\xi \neq 0\}} = \tau^*|_{\{\xi \neq 0\}} \}.$$

Then the map

$$T \times \mathbb{Z}_{\geq 0}^{\Lambda} \rightarrow \mathbb{R}, (\tau, \zeta) \mapsto M_{\Lambda, \tau, \xi}(|h| = \zeta)$$

satisfies the FKG lattice condition with respect to $(-\tau, \zeta)$, that is,

$$M_{\Lambda, \tau \vee \tau', \xi}(|h| = \zeta \wedge \zeta') M_{\Lambda, \tau \wedge \tau', \xi}(|h| = \zeta \vee \zeta') \geq M_{\Lambda, \tau, \xi}(|h| = \zeta) M_{\Lambda, \tau', \xi}(|h| = \zeta')$$

for all $\tau, \tau' \in T$ and for any $\zeta, \zeta' : \Lambda \rightarrow \mathbb{Z}_{\geq 0}$.

Proof of Lemmas 3.10 and 3.11. We follow closely the proof of [LO21, Section 6]. Observe that all factors appearing in the FKG lattice conditions are positive and finite. The idea is to factorise the value of $M_{\Lambda, \tau, \xi}(|h| = \zeta)$ as in (15), and prove the FKG lattice condition separately for each factor. For the first factor $2^{-|\{\zeta=0\}|}$ this is trivial, because

$$2^{-(|\{\zeta \wedge \zeta' = 0\}| + |\{\zeta \vee \zeta' = 0\}|)} = 2^{-(|\{\zeta=0\}| + |\{\zeta'=0\}|)}. \quad (16)$$

Next, we focus on the partition function of the Ising model. Our goal is to prove that

$$Z_{\text{Ising}}(\Lambda, \tau, \xi \wedge \xi', \zeta \wedge \zeta') Z_{\text{Ising}}(\Lambda, \tau, \xi \vee \xi', \zeta \vee \zeta') \geq Z_{\text{Ising}}(\Lambda, \tau, \xi, \zeta) Z_{\text{Ising}}(\Lambda, \tau, \xi', \zeta'), \quad (17)$$

$$Z_{\text{Ising}}(\Lambda, \tau \vee \tau', \xi, \zeta \wedge \zeta') Z_{\text{Ising}}(\Lambda, \tau \wedge \tau', \xi, \zeta \vee \zeta') \geq Z_{\text{Ising}}(\Lambda, \tau, \xi, \zeta) Z_{\text{Ising}}(\Lambda, \tau', \xi, \zeta'), \quad (18)$$

in the context of Lemma 3.10 and Lemma 3.11 respectively. The proof of the first inequality, Equation (17), may be found in [LO21, Subsection 6.3]. For the proof of the second inequality, Equation (18), we argue that in fact

$$Z_{\text{Ising}}(\Lambda, \tau, \xi, \zeta) = Z_{\text{Ising}}(\Lambda, \tau^*, \xi, \zeta)$$

for any $\tau \in T$, so that this inequality is implied immediately by the preceding inequality. In fact, we claim the stronger statement that the coupling constants of the two Ising models are the same. To see that this is true, observe that these coupling constants can only be different at edges $xy \in \partial_e \Lambda$ such that $\tau_{xy} \neq \tau_{xy}^*$. But the definition of T implies that we must have $\xi_{xy} = 0$ for such an edge, and consequently the two coupling constants of that edge are both equal to zero. This finishes the proof of (17) and (18).

Finally, we aim to prove that

$$F_{xy}(\Lambda, \tau, \xi \wedge \xi', \zeta \wedge \zeta') + F_{xy}(\Lambda, \tau, \xi \vee \xi', \zeta \vee \zeta') \leq F_{xy}(\Lambda, \tau, \xi, \zeta) + F_{xy}(\Lambda, \tau, \xi', \zeta'), \quad (19)$$

$$F_{xy}(\Lambda, \tau \vee \tau', \xi, \zeta \wedge \zeta') + F_{xy}(\Lambda, \tau \wedge \tau', \xi, \zeta \vee \zeta') \leq F_{xy}(\Lambda, \tau, \xi, \zeta) + F_{xy}(\Lambda, \tau', \xi, \zeta'), \quad (20)$$

for any $xy \in \mathbb{E}(\Lambda)$ in the context of Lemma 3.10 and Lemma 3.11 respectively. The proof is the same as in [LO21, Subsection 6.3] and relies on the super-Gaussian property of our potentials, except for the case of Equation (20) and $xy \in \partial_e \Lambda$, which is the only case that

we cover here. If $\xi_{xy} \neq 0$ then we automatically have $\tau_{xy} = \tau'_{xy}$ so that the proof is the same as for the other cases. Assume that $\xi_{xy} = 0$. Omitting subscripts, our goal is thus to prove that

$$V^{[\tau \vee \tau']}(\zeta \wedge \zeta') + V^{[\tau \wedge \tau']}(\zeta \vee \zeta') \leq V^{[\tau]}(\zeta) + V^{[\tau']}(\zeta'),$$

and since all these values are nonnegative this is equivalent to

$$V(\tau \vee \tau' + \zeta \wedge \zeta') + V(\tau \wedge \tau' + \zeta \vee \zeta') \leq V(\tau + \zeta) + V(\tau' + \zeta').$$

This inequality holds true because V is convex.

Both lemmas are thus obtained by factorising $M_{\Lambda, \tau, \xi}(|h| = \zeta)$ as in (15) and applying Equations (16), (17), (18), (19), and (20) to the separate factors. \square

Proof of Lemma 3.2. Let $\mu := \mu_{\Lambda, \tau, \xi}$. We first prove the FKG inequality for functions f and g which are measurable and increasing in $(|h|, \mathcal{L}_0^\circ)$ before addressing the FKG inequality for $(|h|, \Delta)$. Write μ_ζ for the measure μ conditioned on $\{|h| = \zeta\}$, and $d\mu(\zeta)$ for the measure in which ζ has the distribution of $|h|$ in μ . We claim that

$$\mu(fg) = \int \mu_\zeta(fg) d\mu(\zeta) \geq \int \mu_\zeta(f) \mu_\zeta(g) d\mu(\zeta) \geq \mu(f) \mu(g).$$

The first equality is the tower property of conditional expectation. The first inequality follows from the Ising model decomposition (Lemma 3.3), together with the observation that (conditional on $|h|$) the functions f and g are increasing in \mathcal{L}_0° . The percolation \mathcal{L}_0° is known to satisfy the FKG inequality in the Ising model. For the final inequality, it suffices to demonstrate that the maps $\zeta \mapsto \mu_\zeta(f)$ and $\zeta \mapsto \mu_\zeta(g)$ are increasing in ζ , so that we can apply the FKG lattice condition for absolute heights (Lemma 3.10). But if we increase ζ , then the coupling constants in the Ising model increase (see Lemma 3.3), which in turn stochastically increases the distribution of \mathcal{L}_0° . Since f and g are increasing in $(|h|, \mathcal{L}_0^\circ)$, it follows that the two maps are indeed increasing in ζ as asserted.

We focus again on the FKG inequality for $(|h|, \Delta)$. By reasoning as in the first part of the proof, it suffices to prove two claims:

1. The law of Δ satisfies the FKG inequality in μ_ζ ,
2. The law of Δ in μ_ζ is stochastically increasing in ζ .

Both claims are proved by analysing the Glauber dynamic which at each step selects an edge xy and then resamples the value of Δ_{xy} conditional on ζ and on all other values of Δ . Fix $xy \in \mathbb{E}(\Lambda)$ and write $E := \mathbb{E}(\Lambda) \setminus \{xy\}$. Assume that $xy \in \mathbb{E}_\circ(\Lambda)$ without loss of generality. Fix $D : E \rightarrow \mathbb{Z}_{\geq 0}/2$ and define

$$\mu_{\zeta, D} := \mu_\zeta(\cdot | \{\Delta|_E = D\});$$

it suffices to prove that the law of Δ_{xy} in $\mu_{\zeta, D}$ is stochastically increasing in ζ and D .

Observe that:

- If h_x and h_y have a different sign, then almost surely $\Delta_{xy} = 0$,
- If h_x and h_y have the same sign, then the conditional distribution of Δ_{xy} is measurable in terms of $|h_x|$, $|h_y|$, and the residual energy at xy , and is independent of the values of $\Delta|_E$.

A natural first question is to ask if the conditioning already forces the sign of h_x and h_y to be the same. For this purpose we define

$$C := \{x \xrightarrow{\mathcal{L}^\circ} y\} \cup \{x \xrightarrow{\mathcal{L}^\circ} \partial_v \Lambda \text{ and } y \xrightarrow{\mathcal{L}^\circ} \partial_v \Lambda\}; \quad \mathcal{L}^\circ := \mathcal{L}_0^\circ \setminus \{xy\} = \{D > 0\};$$

the equality on the right is almost surely true. The event C is clearly increasing in D . If the event C occurs, then h_x and h_y have the same sign, while if the event C does not occur, then the two signs do not interact except over the edge xy . This allows us to explicitly calculate the probability $\mu_{\zeta, D}(\Delta_{xy} \leq k)$ for $k \in \mathbb{Z}_{\geq 0}/2$. Assume first that $k \leq \zeta_x \wedge \zeta_y$.

- If the event C occurs, then we know a priori that the height function has the same sign on either endpoint of the edge xy . In this case, we simply calculate the desired probability by calculating the likelihood that the thread reaches from ζ_x to k and back to ζ_y :

$$\mu_{\zeta,D}(\Delta_{xy} \leq k) = \frac{e^{-V(\zeta_x + \zeta_y - 2k)}}{e^{-V(|\zeta_y - \zeta_x|)}} =: P_k(\zeta_x, \zeta_y, +).$$

- If the event C does not occur, then the height function may assign a different sign to the two endpoints of the edge xy . The remaining edges favour neither agreement nor disagreement, since the conditioning on the complement of C destroys the interaction between the two signs. This means that configurations with $\Delta_{xy} = 0$ carry *twice* their usual weight. Taking this extra weight into account, we obtain

$$\mu_{\zeta,D}(\Delta_{xy} \leq k) = \frac{e^{-V(\zeta_x + \zeta_y - 2k)} + e^{-V(\zeta_x + \zeta_y)}}{e^{-V(|\zeta_y - \zeta_x|)} + e^{-V(\zeta_x + \zeta_y)}} =: P_k(\zeta_x, \zeta_y, -).$$

For $k > \zeta_x \wedge \zeta_y$ we have

$$\mu_{\zeta,D}(\Delta_{xy} \leq k) = 1 =: P_k(\zeta_x, \zeta_y, \pm).$$

Since V is convex and symmetric, it is a technical but straightforward exercise to work out that P_k is decreasing in each of its three arguments. This implies that $\mu_{\zeta,D}(\Delta_{xy} \leq k)$ is decreasing in ζ and D , which is the desired stochastic monotonicity.

We still need to prove monotonicity in boundary heights. The FKG lattice condition for absolute heights (Lemma 3.10) implies that the distribution of $|h|$ responds positively to an increase in the boundary heights ξ . The remainder of the proof follows by reasoning as before, in particular by conditioning on the precise values of $|h|$. \square

We now state and prove a consequence of Lemma 3.2, which follows quite naturally when taking into account the fact that in the previous proofs the graph structure (of the square lattice) never really played a role.

Lemma 3.12. *Consider $(\Lambda, 0), (\Lambda', \tau') \in \text{Geom}$ with $\Lambda \cup \partial_v \Lambda \subset \Lambda'$. Let f denote a real-valued function which is measurable and increasing in $(|h|_\Lambda, \mathcal{L}_0^\circ)$. Then (as soon as f is integrable in either measure) we have*

$$\mu_{\Lambda,0,0}(f) \leq \mu_{\Lambda',\tau',0}(f|A)$$

for any event A which is measurable in terms of $(|h|_{\Lambda' \setminus \Lambda}, \Delta|_{\mathbb{E}(\Lambda') \setminus \mathbb{E}(\Lambda)})$.

Proof. Since $\mu_{\Lambda,0,0}$ -almost surely $\mathcal{L}_0^\circ \subset \mathbb{E}(\Lambda)$, it is enough to consider functions f which are measurable with respect to $(|h|_\Lambda, \mathcal{L}_0^\circ \cap \mathbb{E}(\Lambda))$. For the conditioning event it suffices to consider

$$A = \{|h|_{\Lambda' \setminus \Lambda} = \zeta, \Delta|_{\mathbb{E}(\Lambda') \setminus \mathbb{E}(\Lambda)} = D\}$$

for some (ζ, D) which makes this event have positive probability.

Our objective is to describe the conditional law $\mu := \mu_{\Lambda',\tau',0}(\cdot|A)$. Let us make a simplifying assumption: namely that ζ is constant, say equal to $k \in \mathbb{Z}_{\geq 0}$. In order to encode the effect of the conditioning on Δ , we modify the graph on which we work in two steps.

- First, the height function in μ does not interact over edges in $\{D = 0\}$, since the modulus of h is known on the endpoints of such edges and since the interaction between the signs over such edges is killed. Therefore we may simply delete the edges $\{D = 0\}$ from our graph (and most importantly: the Hamiltonians) without changing any of the (conditional) laws.
- Second, on each connected component of $\{D > 0\}$ we know that both the sign and the modulus of h is constant. Therefore we may simply identify vertices belonging to the same connected component without changing any of the (conditional) laws.

In the remainder of the proof we work on the modified graph but keep all notations the same: in particular, Λ' denotes the disjoint union of Λ with the set of contracted vertices. On the modified graph, the conditioning event may be written

$$A = \{|h|_{\Lambda' \setminus \Lambda} = k\};$$

the conditioning on Δ is absorbed in the modified graph structure. We now claim that

$$\mu_{\Lambda,0,0}(f) = \mu_{\Lambda',\tau',0}(f|\{|h|_{\Lambda' \setminus \Lambda} = 0\}) \leq \mu_{\Lambda',\tau',0}(f|\{|h|_{\Lambda' \setminus \Lambda} = k\}) = \mu_{\Lambda',\tau',0}(f|A).$$

The equality on the left is Lemma 2.9; the equality on the right holds true by definition of A . For the inequality, we compare the two conditioned measures. Note that $|h|$ satisfies the FKG lattice condition in $\mu_{\Lambda',\tau',0}$, and therefore its law is higher in the conditional measure on the right. Recall from the proof of Lemma 3.2 that this also increases the conditional law of Δ , thus completing the argument.

If the function ζ is not constant then one cannot contract vertices in the same way: this problem is solved by assigning the heights to the different edges going into the same contracted vertex. This complicates notation but does not introduce any essential difficulty. \square

3.4. Comparison of domains.

Proof of Lemma 3.6. First, by reducing ξ' if necessary and applying monotonicity in absolute heights (Lemma 3.2), we may assume without loss of generality that

$$\xi'_{xy} = \begin{cases} \xi_{xy} & \text{if } xy \in \partial_e \Lambda, \\ 0 & \text{otherwise.} \end{cases}$$

We will also consider a third domain $(\Lambda'', \tau'', \xi'')$ defined by $\Lambda'' := \Lambda$, $\xi'' := \xi$, and

$$\tau'' : \partial_e \Lambda \rightarrow \mathbb{Z}, xy \mapsto \begin{cases} \tau'_{xy} & \text{if } xy \in \partial_e \Lambda', \\ 0 & \text{otherwise.} \end{cases}$$

It is easy to see that $(\Lambda, \tau, \xi) \preceq (\Lambda'', \tau'', \xi'') \preceq (\Lambda', \tau', \xi')$. The proof that

$$\mu_{\Lambda,\tau,\xi}(f) \leq \mu_{\Lambda'',\tau'',\xi''}(f)$$

follows by reasoning as for monotonicity in absolute heights (Lemma 3.2): one first observes that the distribution of $|h|$ is smaller in $\mu_{\Lambda,\tau,\xi}$ than in $\mu_{\Lambda'',\tau'',\xi''}$ due to the FKG lattice condition for the truncation (Corollary 3.11), then applies the exact same argument.

It now suffices to prove that

$$\mu_{\Lambda'',\tau'',\xi''}(f) \leq \mu_{\Lambda',\tau',\xi'}(f). \tag{21}$$

Lemma 2.9 implies the equality

$$\mu_{\Lambda'',\tau'',\xi''}(f) = \mu_{\Lambda',\tau',\xi'}(f|\{|h|_{\Lambda' \setminus \Lambda''} \equiv 0\}).$$

But the event $\{|h|_{\Lambda' \setminus \Lambda''} \equiv 0\}$ is decreasing in $(|h|, \Delta)$, so that (21) is an immediate consequence of the FKG inequality for absolute heights (Lemma 3.2). \square

4. THE RSW THEORY OF KÖHLER-SCHINDLER AND TASSION

The purpose of this section is to describe how the RSW theory developed in [KT23] applies to our setting. We introduce some notation, state Theorem 2 of [KT23] in our setting, then address some details regarding the application of this result.

Definition 4.1 (Rectangles). Use the notation ∂A for the topological boundary of some set $A \subset \mathbb{R}^2$. A *rectangle* is a set $[x_1, x_2] \times [y_1, y_2] \subset \mathbb{R}^2$ for some $x_1 < x_2$ and $y_1 < y_2$. For the avoidance of doubt, we think of the vectors $e_1 = (1, 0)$ and $e_2 = (0, 1)$ as pointing to the right and top respectively. If A is a rectangle, then write

$$\text{Left}_A, \text{Right}_A, \text{Top}_A, \text{Bottom}_A$$

for the left, right, top, and bottom edge of A , which jointly partition ∂A except that the four corners appear twice. We shall sometimes use subsets A of \mathbb{R}^2 in place of subsets $\Lambda \in \mathbb{Z}^2$, in which case the relevant set is $A \cap \mathbb{Z}^2$. We shall write $\llbracket n \rrbracket := [-n, n]$, so that, for example, $\Lambda_n = \llbracket n-1 \rrbracket^2$. Each face $F \in \mathbb{F}$ is identified with the convex hull of the four vertices that it contains, which is a closed square whose sides have unit length. For $A \subset \mathbb{R}^2$, we write $\mathbb{F}(A)$ for the set of faces that intersect A .

Definition 4.2 (Rectangle crossings). For any rectangle R with corners in \mathbb{Z}^2 , define

$$\text{Hor}\{R\} := \{\omega \subset \mathbb{E} : \text{Left}_R \xleftarrow{\omega \text{ in } R} \text{Right}_R\} \subset \mathcal{P}(\mathbb{E});$$

$$\text{Ver}\{R\} := \{\omega \subset \mathbb{E} : \text{Top}_R \xleftarrow{\omega \text{ in } R} \text{Bottom}_R\} \subset \mathcal{P}(\mathbb{E}).$$

These are the *horizontal* and *vertical* crossing respectively. Their dual counterparts are

$$\text{Hor}^*\{R\} := \{\omega \subset \mathbb{E}^* : \omega^\diamond \notin \text{Ver}\{R\}\} \subset \mathcal{P}(\mathbb{E}^*);$$

$$\text{Ver}^*\{R\} := \{\omega \subset \mathbb{E}^* : \omega^\diamond \notin \text{Hor}\{R\}\} \subset \mathcal{P}(\mathbb{E}^*).$$

For any rectangle R , write

$$\text{Hor}^{\mathbb{F}}\{R\} := \{\omega \subset \mathbb{E}^* : \mathbb{F}(\text{Left}_R) \xleftarrow{\omega \text{ in } \mathbb{F}(R)} \mathbb{F}(\text{Right}_R)\} \subset \mathcal{P}(\mathbb{E}^*);$$

$$\text{Ver}^{\mathbb{F}}\{R\} := \{\omega \subset \mathbb{E}^* : \mathbb{F}(\text{Top}_R) \xleftarrow{\omega \text{ in } \mathbb{F}(R)} \mathbb{F}(\text{Bottom}_R)\} \subset \mathcal{P}(\mathbb{E}^*);$$

this definition makes sense even if R does not have corners in \mathbb{Z}^2 .

Definition 4.3 (The RSW homeomorphism). For $N \in \mathbb{Z}_{\geq 1}$, define the function ψ_N by

$$\psi_N : [0, 1] \rightarrow [0, 1], \quad x \mapsto (1 - \sqrt[N]{1-x})^N.$$

Remark 4.4. Observe that for any N , the map $\psi_N : [0, 1] \rightarrow [0, 1]$ is an increasing homeomorphism. Moreover, for any $x \in [0, 1]$ and $\alpha \geq 0$, we have:

1. $\psi_N(x) \geq (x/N)^N$,
2. $\psi_N(1 - e^{-\alpha}) = (1 - e^{-\alpha/N})^N \geq 1 - Ne^{-\alpha/N}$.

Definition 4.5. For $n \in \mathbb{Z}_{\geq 1}$ and $\Lambda, \Lambda' \in \mathbb{Z}^2$, write $\Lambda \ll_n \Lambda'$ if

$$\exists a \in \mathbb{Z}_{\geq 1}, \quad \Lambda \subset \Lambda_a; \quad \Lambda_{a+n} \subset \Lambda'.$$

We also write $(\Lambda, \tau) \ll_n (\Lambda', \tau')$ for two geometric domains whenever $\Lambda \ll_n \Lambda'$.

Note that if $(\Lambda, \tau) \ll_n (\Lambda', \tau')$, then $\Sigma(\Lambda, \tau) \preceq (\Lambda', \tau')$ whenever Σ is a symmetry of the square lattice mapping $(0, 0)$ to a vertex in Λ_n .

Theorem 4.6 ([KT23, Theorem 2]). *There exists a universal constant $N \in \mathbb{Z}_{\geq 1}$ with the following properties.*

1. *Suppose that \mathcal{X} is a random subset of \mathbb{E} which is defined in $\mu_{\Lambda, \tau, 0}$ for any geometric domain $(\Lambda, \tau) \in \text{Geom}$, and which has the following properties:*
 - a. *The percolation \mathcal{X} satisfies the FKG inequality in each measure $\mu_{\Lambda, \tau, 0}$,*
 - b. *The distribution of \mathcal{X} in $\mu_{\Lambda, \tau, 0}$ is increasing in the choice of the geometric domain,*
 - c. *If Σ is any symmetry of the square lattice, then the distribution of \mathcal{X} in $\mu_{\Sigma\Lambda, \Sigma\tau, 0}$ equals the distribution of $\Sigma\mathcal{X}$ in $\mu_{\Lambda, \tau, 0}$.*

Consider $n \in \mathbb{Z}_{\geq 1}$ and let $(\Lambda, \tau), (\Lambda', \tau') \in \text{Geom}$ with $(\Lambda, \tau) \ll_{8n} (\Lambda', \tau')$. Then

$$\mu_{\Lambda', \tau', 0}(\mathcal{X} \in \text{Hor}\{\llbracket 2n \rrbracket \times \llbracket n \rrbracket\}) \geq \psi_N(\mu_{\Lambda, \tau, 0}(\mathcal{X} \in \text{Ver}\{\llbracket 2n \rrbracket \times \llbracket n \rrbracket\})).$$

2. *Suppose now that \mathcal{Y} is a percolation with the exact same properties, except that $\mathcal{Y} \subset \mathbb{E}^*$ and that its distribution in $\mu_{\Lambda, \tau, 0}$ is decreasing rather than increasing in the choice of the geometric domain. Then we have instead*

$$\mu_{\Lambda, \tau, 0}(\mathcal{Y} \in \text{Hor}^*\{\llbracket 2n \rrbracket \times \llbracket n \rrbracket\}) \geq \psi_N(\mu_{\Lambda', \tau', 0}(\mathcal{Y} \in \text{Ver}^*\{\llbracket 2n \rrbracket \times \llbracket n \rrbracket\})).$$

The explicit form for ψ_N was recently communicated to the author by Köhler-Schindler and will appear in a later version of [KT23].

For any arbitrary (percolation) measure \mathbb{P} satisfying the FKG inequality and for any finite sequence A_1, \dots, A_n of increasing events, we have two fundamental inequalities at our disposal:

1. The FKG inequality $\mathbb{P}(A_1 \cap \dots \cap A_n) \geq \mathbb{P}(A_1) \dots \mathbb{P}(A_n)$, and
2. The *square root trick*, that is, $\max\{\mathbb{P}(A_1), \dots, \mathbb{P}(A_n)\} \geq 1 - \sqrt[n]{1 - \mathbb{P}(A_1 \cup \dots \cup A_n)}$.

The constructions in [KT23] use many times the FKG inequality and the square root trick, which is why the function ψ_N takes the form as specified in Definition 4.3. In fact, using the symmetries of the square lattice, it is easy to write horizontal crossings of $kn \times n$ rectangles as intersections of crossings of $2n \times n$ and $n \times 2n$ rectangles in the hard direction, and therefore we may lower bound the probability of the first event in terms of the probability of a crossing of a $2n \times n$ rectangle and the FKG inequality. Speaking more broadly: once we have access to the lower bound in Theorem 4.6, it is easy to lower bound the probability of other percolation events defined at the same scale. Similarly, one can lower bound the probability of the vertical crossing of a $2n \times n$ rectangle by using a lower bound on other percolation events defined at the same scale, the symmetries of the square lattice, and the square root trick as inputs.

Remark 4.7. 1. The essence of [KT23, Theorem 2] lies in the fact that one can go from crossing a rectangle with an aspect ratio strictly below one to crossing a rectangle with an aspect ratio strictly above one.

2. We shall occasionally use the fact that arbitrary percolation events at a certain scale imply the easy crossing at the same scale (using the square root trick), and that the hard crossing at a certain scale implies arbitrary percolation events at the same scale (using the FKG inequality). Combining with [KT23, Theorem 2], this implies that the occurrence of an arbitrary percolation event at some scale implies the occurrence of any percolation event at the same scale. The only price that we pay is the fact that the value of n in the comparison \ll_n and the value of N in the homomorphism ψ_N must be chosen larger, depending on the specific setup.

5. PERCOLATION AT BOUNDARY HEIGHT ZERO

5.1. Statements. This is the first section that considers the connectivity properties of the percolation \mathcal{L}_0 . If we define

$$\mathcal{L}'_0 := \mathcal{L}_0 \cup (\mathbb{E}^* \setminus \mathbb{E}^*(\Lambda)),$$

then \mathcal{L}'_0 is the true dual-complement of \mathcal{L}_0° in \mathbb{E}^* , and satisfies all the properties of the percolation \mathcal{Y} in Theorem 4.6, Part 2 due to monotonicity in domains (Lemma 3.6). Throughout this section we also write $\nu_\Lambda := \mu_{\Lambda,0,0}$ for brevity. Our first goal in this section is to prove the following lemma. The *diameter* of a set $A \subset \mathbb{R}^2$ is defined with respect to the Euclidean metric.

Lemma 5.1 (Net lemma). *There is a universal constant $c_{\text{net}} > 0$ such that for any potential $V \in \Phi$, any scale $n \in \mathbb{Z}_{\geq 1}$, and any rectangle width $w \in \mathbb{Z}_{\geq 1}$, we have*

$$\lim_{\alpha \rightarrow \infty} \nu_{[\alpha n] \times [n]} \left(\begin{array}{l} \text{all } \mathcal{L}_0^\circ\text{-clusters intersecting } [wn] \times [n] \\ \text{have a diameter strictly below } n/10^8 \end{array} \right) \geq c_{\text{net}}^w.$$

Importantly, the lower bound is independent of the potential V and the scale n . The lemma is used as a wild card which essentially provides a lower bound for any percolation event for \mathcal{L}'_0 at the macroscopic scale. The quantity on the left is decreasing in α by monotonicity in domains; the results is stated like this to avoid defining the $\alpha \rightarrow \infty$ limit of the measure on the left. We use the lemma to prove the following result.

Lemma 5.2 (Viaduct lemma). *There exists a universal constant $c_{\text{via}} > 0$ with the following property. For any potential $V \in \Phi$ and scales $n, m \in \mathbb{Z}_{\geq 1}$ with $m \leq n$, we have*

$$\forall k \in \mathbb{Z}, \quad \nu_{\llbracket n \rrbracket^2}(\mathcal{L}'_0 \in \text{Hor}^*\{\llbracket n \rrbracket \times [k, k+m]\}) \geq c_{\text{via}}^{n/m}.$$

This second lemma is obtained by iterating the first at exponentially decreasing scales. The lemma has an equivalent statement for FK percolation, but was to the best knowledge of the author not yet known in that context. It plays a pivotal role in proving the second coarse-graining inequality later on. The proof of Theorem 6 (the upper bound on the one-arm exponent) is an easier version of the proof of Lemma 5.2, and is included at the end of this section.

Remark 5.3.

1. By monotonicity in domains (Lemma 3.6), the lower bounds above remain true when the geometric domain is replaced by a smaller domain.
2. Since $\mathcal{L}_0 \subset \mathcal{L}_{\leq 0}$, the lower bounds remain true when \mathcal{L}_0 is replaced by $\mathcal{L}_{\leq 0}$.
3. By monotonicity in heights (Lemma 3.1), the lower bounds remain true when for some $a \in \mathbb{Z}$ the percolation $\mathcal{L}_{\leq 0}$ is replaced by $\mathcal{L}_{\leq a}$ and the boundary height function 0 by an arbitrary boundary height function ξ which does not exceed a .
4. In particular, we shall later consider boundary height functions which take values in $\{0, 1\}$, and which thus satisfy $\xi \leq 1$.

5.2. The first coarse-graining inequality.

Lemma 5.4 (First coarse-graining inequality). *There is a universal constant $c_{\text{coarse}} > 0$ such that one of the following two must hold true for each fixed super-Gaussian potential V .*

1. For any $n \in \mathbb{Z}_{\geq 1}$,

$$\nu_{\llbracket 2n \rrbracket^2}(\mathbb{F}(\llbracket n \rrbracket^2) \xleftarrow{\mathcal{L}'_0} \mathbb{F}(\partial\llbracket 2n \rrbracket^2)) \geq c_{\text{coarse}}.$$

2. For $x \in \mathbb{F}$, let $A_n(x)$ denote the random set of faces that are connected to x through an \mathcal{L}'_0 -open path that remains inside $\mathbb{F}(\llbracket n \rrbracket^2)$. Then there exist numbers $N \in \mathbb{Z}_{\geq 1}$ and $c > 0$ such that for all $x \in \mathbb{F}$ and for all $m, k \geq N$, we have

$$\nu_{\llbracket m \rrbracket^2}(|A_{m-N}(x)| \geq k) \leq e^{-ck}.$$

Proof. We first derive a simple inequality, then argue that the remainder of the proof is in fact the same as the proof of [DT19, Lemma 10]. Fix $n \in \mathbb{Z}_{\geq 1}$, and let

$$p := \nu_{\llbracket 2n \rrbracket^2}(\mathbb{F}(\llbracket n \rrbracket^2) \xleftarrow{\mathcal{L}'_0} \mathbb{F}(\partial\llbracket 2n \rrbracket^2)).$$

Now choose an integer m which is (possibly much) larger than n , and let $X \subset \mathbb{Z}^2$ denote some set of vertices which are at a graph distance at least $8n$ from each other and from the complement of $\llbracket m \rrbracket^2$. We claim that

$$\nu_{\llbracket m \rrbracket^2}(P(X, n)) \leq p^{|X|}; \quad P(X, n) := \{\forall x \in X, \mathbb{F}(\llbracket n \rrbracket^2 + x) \xleftarrow{\mathcal{L}'_0} \mathbb{F}(\partial\llbracket 2n \rrbracket^2 + x)\}.$$

First, let Z denote the event that $|h|$ equals zero on the set $\partial_v\llbracket 2n \rrbracket^2 + x$ for each $x \in X$. Clearly, this event is increasing in $(-|h|, \mathcal{L}_0)$, and therefore the FKG inequality for absolute heights (Lemma 3.2) asserts that conditioning on this event can only increase the probability of the event $P(X, n)$. But then the Markov property implies that

$$\nu_{\llbracket m \rrbracket^2}(P(X, n)) \leq \nu_{\llbracket m \rrbracket^2}(P(X, n)|Z) = p^{|X|}.$$

The proof is now the same as the proof of [DT19, Lemma 10], and runs roughly as follows. We would like to find a $c_{\text{coarse}} > 0$ such that we are in the second case if the value of p drops below c_{coarse} for some fixed $n \in \mathbb{Z}_{\geq 1}$. To see this, note that if the set $A_{m-16n}(x)$ is large, then we can find a large set $X \subset \mathbb{Z}^2$ such that the event $P(X, n)$ occurs. The set X can be chosen as a subset of $(n\mathbb{Z})^2$, and such that any two distinct vertices in X are at

a graph distance of at least $8n$ from each other, and connected by a path through X whose step size (in terms of graph distance) is at most $16n$. If X is chosen maximal (subject to the occurrence of the event), then it is called a *coarse-grained version* of $A_{m-16n}(x)$. For fixed n , the size of X is comparable to that of $A_{m-16n}(x)$. A standard study of lattice animals tells us that the number of such sets X of size z and containing some fixed vertex, grows at most exponentially in z with an explicit base. If p is strictly smaller than the reciprocal of this base, then it is easy to derive the exponential decay in the second case in the statement of the lemma. This yields the desired value for c_{coarse} . \square

5.3. Duality of height functions. The previous lemma expresses a very general and robust idea in the context of percolation, and separates the subcritical phase from the other phases. We now argue that in fact the subcritical phase cannot occur in the context of planar height functions, regardless of the choice of potential function V .

Lemma 5.5 (Duality of height functions). *For any potential, the second case in the previous lemma cannot hold true.*

Proof. The proof runs essentially as follows. First, we show that for any given height function h , we may find some $a \in \mathbb{Z}$ such that the percolation \mathcal{L}_a contains a large cluster. We (informally) consider the value a for which this happens to be a random variable. Assume that the second case in the previous lemma holds true, so that the event $\{a = 0\}$ has small probability. We then show that in fact the event $\{a = k\}$ is less likely to occur than the event $\{a = 0\}$. This can only be consistent with one another if the distribution of the random variable a is very much spread out, in the sense that $|a|$ is typically exponentially large in the scale at which boundary conditions are imposed, which is evidently absurd. This leads to a contradiction for height functions.

We now make this proof formal. Assume the setting of the second case in the lemma. Let $n' := n - N$ and $R := \llbracket n' \rrbracket^2$. Let $X_{a,n}$ denote the size of the largest set of faces which are connected through \mathcal{L}_a -paths that remain inside $\mathbb{F}(R)$. A union bound over vertices implies that for a suitable choice of N and c , we have

$$\nu_{\llbracket n \rrbracket^2}(X_{0,n} \geq n) \leq e^{-cn}$$

for any $n \geq N$. Notice that in fact for any $a \in \mathbb{Z}$ we have

$$\nu_{\llbracket n \rrbracket^2}(X_{a,n} \geq n) \leq \nu_{\llbracket n \rrbracket^2}(X_{0,n} \geq n) \leq e^{-cn}$$

because

$$\nu_{\llbracket n \rrbracket^2}(X_{a,n} \geq n) := \mu_{\llbracket n \rrbracket^2, 0, 0}(X_{a,n} \geq n) = \mu_{\llbracket n \rrbracket^2, 0, |a|}(X_{0,n} \geq n)$$

which is decreasing in $|a|$ because of monotonicity in absolute heights (Lemma 3.2).

Next, we prove that the event $\{X_{a,n} \geq n\}$ must occur for some a whenever $n \geq 8N$. Let h denote some height function. Fix $n \geq 8N$, and let $a \in \mathbb{Z}$ denote the smallest height so that

$$\text{Left}_R \xleftarrow{\{h \leq a\} \text{ in } R} \text{Right}_R. \quad (22)$$

Claim that for this height function and for any nonnegative family of residuals,

$$\mathcal{L}_a \in \text{Hor}^{\mathbb{F}}\{R\} \quad \text{or} \quad \mathcal{L}_a \in \text{Ver}^{\mathbb{F}}\{R\}.$$

The claim clearly implies the occurrence of the event $\{X_{a,n} \geq n\}$. To see that the claim is true, suppose that the connection event on the right does not occur. Then the dual-complement \mathcal{L}_a° must satisfy

$$\mathcal{L}_a^\circ \in \text{Hor}\{R\}.$$

Since this percolation connects vertices whose height lies strictly on the same side of a , this must be a left-right crossing of either $\{h < a\}$ or $\{h > a\}$. In fact, the first case is ruled out by choice of a . Thus, in addition to (22), we also have

$$\text{Left}_R \xleftarrow{\{h > a\} \text{ in } R} \text{Right}_R. \quad (23)$$

By the intermediate value theorem, it is easy to see that a left-right crossing of \mathcal{L}_a must lie in between the crossings in (22) and (23). In particular, this crossing can be realised on the interface of $\{h \leq a\}$ with $\{h > a\}$. This proves the claim.

Combining the occurrence of some event $\{X_{a,n} \geq n\}$ with the exponential upper bound and flip symmetry yields

$$\nu_{\llbracket n \rrbracket^2}(\cup_{a > e^{cn}/8} \{X_{a,n} \geq n\}) \geq 1/4.$$

Inclusion of events and the intermediate value theorem for threads yields

$$\nu_{\llbracket n \rrbracket^2}(\text{some thread in } \mathbb{E}(\llbracket n \rrbracket^2) \text{ reaches to } e^{cn}/8) \geq 1/4.$$

We derive a contradiction by obtaining very crude upper bounds on the probability of this event, which tell us that the probability must be below $1/4$.

For a thread to reach to height $e^{cn}/8$, either there is some vertex x such that $h_x \geq e^{cn}/16$, or $h < e^{cn}/16$ and some residual ρ_{xy} is so large that the thread of the corresponding edge still reaches to $e^{cn}/8$. We prove that for n large enough, either event has a probability strictly below $1/8$. Start with the latter event. In that case, there is some edge $xy \in \mathbb{E}(\llbracket n \rrbracket^2)$ such that the event

$$\begin{aligned} \{\ell(xy) \geq e^{cn}/8 + |h_y - h_x|\} &= \{T_{xy} \geq V(\lceil e^{cn}/8 \rceil + |h_y - h_x|)\} \\ &= \{\rho_{xy} \geq V(\lceil e^{cn}/8 \rceil + |h_y - h_x|) - V(h_y - h_x)\} \subset \{\rho_{xy} \geq \lceil e^{cn}/8 \rceil (V(1) - V(0))\} \end{aligned}$$

occurs. The inclusion is due to the fact that V is a convex symmetric function. Note that $V(1) - V(0)$ is strictly positive due to the super-Gaussian property. But the event on the right has probability exactly $e^{-\lceil e^{cn}/8 \rceil (V(1) - V(0))}$. Clearly, for n sufficiently large, the probability that one such event occurs for some edge in $\mathbb{E}(\llbracket n \rrbracket^2)$, is strictly below $1/8$. Finally, we focus on the event that the maximum of h is at least $e^{cn}/16$. Then the value of the Hamiltonian $H_{\llbracket n \rrbracket^2}$ is at least $(e^{cn}/16)(V(1) - V(0))$. But it is known from standard surface tension calculations that

$$\nu_{\llbracket n \rrbracket^2}(H_{\llbracket n \rrbracket^2}) = O(n^2)$$

as $n \rightarrow \infty$. A Markov bound yields the desired inequality on the probability of the event that the maximum of h exceeds $e^{cn}/16$. \square

5.4. Proof of the net lemma (Lemma 5.1).

Proof of Lemma 5.1 for $\alpha = w = 1$. We first prove the lower bound for $\alpha = 1$ rather than for $\alpha \rightarrow \infty$, which is strictly weaker since the left hand side of the inequality is decreasing in α . The previous two lemmas say that for any $n \in \mathbb{Z}_{\geq 1}$,

$$\nu_{\llbracket 16n \rrbracket^2}(\mathbb{F}(\llbracket 8n \rrbracket^2) \xleftarrow{\mathcal{L}'_0} \mathbb{F}(\partial \llbracket 16n \rrbracket^2)) \geq c_{\text{coarse}}.$$

By the generic RSW theory (Theorem 4.6 and Remark 4.7) there exists some large integer N such that

$$\nu_{\llbracket 4n \rrbracket^2}(\mathcal{L}'_0 \in \text{Hor}^* \{[0, 2\lceil n/10^{10} \rceil] \times [0, \lceil n/10^{10} \rceil]\}) \geq \psi_N(c_{\text{coarse}}).$$

By shrinking the domain further we extend this bound to arbitrary translates of this rectangle or its rotated version by $\pi/2$, and the FKG inequality then yields

$$\nu_{\llbracket n \rrbracket^2}(\text{all clusters of } \mathcal{L}_0^\diamond \text{ have a diameter below } n/10^9) \geq \psi_M(c_{\text{coarse}}),$$

where M is some large universally chosen integer. Indeed, the event in the display above is contained in the event that finitely many rectangles of dimension $2\lceil n/10^{10} \rceil \times \lceil n/10^{10} \rceil$ are crossed by \mathcal{L}'_0 in the hard direction. This implies the lemma for $\alpha = w = 1$ by setting $c'_{\text{net}} := \psi_M(c_{\text{coarse}})$. \square

Remark 5.6. In fact, we proved that

$$\begin{aligned} \nu_{\llbracket n \rrbracket^2}(\text{all clusters of } \mathcal{L}_0^\circ \text{ have a diameter below } n/10^9) \\ \geq \psi_M\left(\nu_{\llbracket 16n \rrbracket^2}(\mathbb{F}(\llbracket 8n \rrbracket^2) \xleftarrow{\mathcal{L}'_0} \mathbb{F}(\partial\llbracket 16n \rrbracket^2))\right). \end{aligned}$$

Remark 4.4, Statement 2 therefore asserts that the left hand side tends to one exponentially fast in n when the argument of ψ_M tends to one exponentially fast in n .

We now prove Lemma 5.1 for $\alpha \geq 1$ and $w = 1$. This implies the full lemma; the extension to $w \geq 1$ simply uses the FKG inequality.

Proof of Lemma 5.1 for $\alpha \geq 1$ and $w = 1$. Fix n and define, for $k \in \mathbb{Z}_{\geq 1}$, the event

$$A_k := \{\mathcal{L}'_0 \in \text{Ver}^*\{[-4kn, -2kn] \times \llbracket n \rrbracket\} \cap \text{Ver}^*\{[2kn, 4kn] \times \llbracket n \rrbracket\}\}.$$

Claim that there exists a universal constant $c > 0$ such that

$$\forall \alpha \geq 1, \quad \nu_{\llbracket \alpha n \rrbracket \times \llbracket n \rrbracket}(A_1) \geq c.$$

We first argue that the claim implies the lemma. Assume that α is large without loss of generality. Let (Λ, τ, ξ) denote the boundary conditions induced by running an exploration process which:

- First reveals the heights of h on the complement of $\llbracket 4n - 1 \rrbracket \times \llbracket n \rrbracket$,
- Then performs a target height exploration with the target height $a = 0$.

Observe that $\xi \equiv 0$ by definition of the exploration, and the claim implies that the event

$$B := \{(\llbracket 2n - 1 \rrbracket \times \llbracket n \rrbracket, 0) \preceq (\Lambda, \tau) \preceq (\llbracket 4n - 1 \rrbracket \times \llbracket n \rrbracket, 0)\}$$

has probability at least c . Then

$$\begin{aligned} \nu_{\llbracket \alpha n \rrbracket \times \llbracket n \rrbracket} \left(\begin{array}{l} \text{the } \mathcal{L}_0^\circ\text{-clusters intersecting } \llbracket n \rrbracket^2 \text{ have} \\ \text{a diameter strictly below } n/10^8 \end{array} \right) \\ \geq \int_B \bar{\mu}_{\Lambda, \tau, \xi} \left(\begin{array}{l} \text{the } \mathcal{L}_0^\circ\text{-clusters intersecting } \llbracket n \rrbracket^2 \text{ have} \\ \text{a diameter strictly below } n/10^8 \end{array} \right) d\nu_{\llbracket \alpha n \rrbracket \times \llbracket n \rrbracket}(\Lambda, \tau, \xi) \\ \geq \int_B \bar{\mu}_{\llbracket 4n-1 \rrbracket^2, 0, 0} \left(\begin{array}{l} \text{the } \mathcal{L}_0^\circ\text{-clusters intersecting } \llbracket n \rrbracket^2 \text{ have} \\ \text{a diameter strictly below } n/10^8 \end{array} \right) d\nu_{\llbracket \alpha n \rrbracket \times \llbracket n \rrbracket}(\Lambda, \tau, \xi) \\ \geq c \cdot c'_{\text{net}} =: c_{\text{net}}. \end{aligned}$$

For the first inequality, we simply observe that on the event B , each \mathcal{L}_0° -cluster intersecting $\llbracket n \rrbracket$ is contained in an \mathcal{L}_0° -cluster. The second inequality is monotonicity in domains and the fact that we replace the event of interest by a smaller event. For the final inequality, observe that the expectation within the integrand does not depend on the triple (Λ, τ, ξ) , so that we may apply the two known inequalities to the two separate factors. This finishes the proof of the lemma conditional on the claim.

It suffices to prove the claim. The proof of the claim is identical to the argument used in the proof of [DT19, Corollary 11] (see in particular [DT19, Figure 7]), using, in our setting, the same type of exploration process as the exploration process defined above. The argument asserts that

- For all $k \in \mathbb{Z}_{\geq 1}$, we have $\nu_{\llbracket \alpha n \rrbracket \times \llbracket n \rrbracket}(A_k | A_{2k}) \geq \sqrt[k]{c'_{\text{net}}}$,
- For $k \geq \alpha$, A_k occurs deterministically as $\mathbb{E}^* \setminus \mathbb{E}^*(\llbracket \alpha n \rrbracket \times \llbracket n \rrbracket) \subset \mathcal{L}'_0$.

These statements imply that the probability of A_1 is at least

$$c := (c'_{\text{net}})^2 = \prod_{k=0}^{\infty} \sqrt[2^k]{c'_{\text{net}}} > 0,$$

which proves the claim. \square

5.5. Proofs of Lemma 5.2 and Theorem 6.

Proof of Lemma 5.2. Assume the setting of the statement of the lemma. Assume also that $k = 0$; this really makes no difference to the argument. Let A_0 denote the event whose probability we aim to lower bound. For $s \in \mathbb{Z}_{\geq 1}$, define the event

$$A_s := \{\mathcal{L}'_0 \in \text{Hor}^*\{\llbracket n \rrbracket \times [sm, 3sm]\} \cap \text{Hor}^*\{\llbracket n \rrbracket \times [-3sm, -sm]\}\}.$$

We first prove the following three claims:

1. For all $s \in \mathbb{Z}_{\geq 1}$, we have $\nu_{\llbracket n \rrbracket^2}(A_s | A_{3s}) \geq c_{\text{net}}^{\lceil n/9sm \rceil}$,
2. We have $\nu_{\llbracket n \rrbracket^2}(A_0 | A_1) \geq c_{\text{net}}^{\lceil n/3m \rceil}$,
3. If $sm \geq n$, then $\nu_{\llbracket n \rrbracket^2}(A_s) = 1$.

The first claim follows by an exploration process similar to the one in the proof of Lemma 5.1. First, one explores the heights in the complement of $\llbracket n \rrbracket \times [9sm - 1]$, then one performs a target height exploration at the target height $a = 0$. Conditional on A_{3s} , this exploration ends before revealing the height of a vertex in $\llbracket n \rrbracket \times [3sm]$. The conditional probability of A_s is at least $c_{\text{net}}^{\lceil n/9sm \rceil}$ due to Lemma 5.1 applied to the resulting geometric domain, which is included in the infinite strip $\mathbb{R} \times [9sm]$ (the strategy is the same as in the proof of Lemma 5.1). The second claim follows by similar reasoning. The third claim is obvious because $\mathcal{L}'_0 \subset \mathbb{E}_o(\llbracket n \rrbracket^2)$.

Jointly the estimates imply that

$$\nu_{\llbracket n \rrbracket^2}(A_0) \geq c_{\text{net}}^{\sum_{k=1}^{\infty} 1_{\{3^k < 9n/m\}} \lceil n/(3^k m) \rceil}.$$

This proves the lemma with the constant $c_{\text{via}} = c_{\text{net}}^{9/2}$ since

$$\sum_{k=1}^{\infty} 1_{\{3^k < 9n/m\}} \lceil n/(3^k m) \rceil \leq \frac{9n}{m} \sum_{k=1}^{\infty} 3^{-k} = \frac{9n}{2m}.$$

□

Proof of Theorem 6. For any $k \in \mathbb{Z}_{\geq 1}$, let A_k denote the event

$$A_k := \{\text{all clusters of } \mathcal{L}'_0 \text{ which intersect } \llbracket k \rrbracket^2 \text{ have a diameter below } k/8\}.$$

By arguing as before, it is easy to see that, for any $0 \leq m \leq k$,

$$\nu_{\llbracket 2^k \rrbracket^2}(A_{2^k} \cap A_{2^{k-1}} \cap \cdots \cap A_{2^{k-m+1}}) \geq c_{\text{net}}^m,$$

which implies Theorem 6. □

6. SYMMETRISATION ARGUMENTS

The previous section studied the percolation \mathcal{L}_0 with boundary conditions at the most favourable height: the height zero. Proving percolation is significantly harder when part of the boundary height function assumes the height one. The purpose of this section is to create a number of fundamental building blocks (inequalities for the likelihood of percolation events) which allow us to prove the crucial lower bound in the next section. The ideas in this section rely on symmetry arguments: the bounds are obtained by combining the correlation inequalities of Section 3 with the symmetries of the square lattice. On one occasion, we shall also use the generic bounds obtained in Section 5.

Definition 6.1 (Quads). A *quad* is a triple $Q = (p, F, \Lambda)$ of the following type:

1. $p = (p_k)_{0 \leq k \leq n} \subset \mathbb{F}$ is a closed self-avoiding walk through $(\mathbb{F}, \mathbb{E}^*)$, oriented clockwise;
2. $F = (F_k)_{k \in \{0,1,2,3\}} \subset \mathbb{F}$ denotes four distinct faces visited by p in that order;
3. $\Lambda \in \mathbb{Z}^2$ encodes the set of vertices enclosed by the path p .

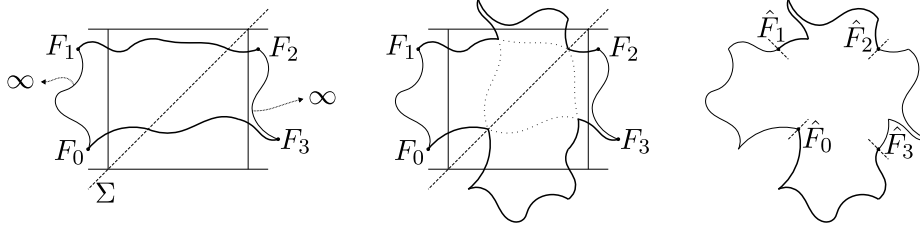

FIGURE 6. Quads with boundary conditions as appearing in Lemma 6.3. The boundary is thick where ξ equals zero and thin where ξ equals one. LEFT: A wide quad with height-one boundary conditions on the left and right. The paths to infinity for the technical condition are also drawn. MIDDLE: The union of the boundary condition with the symmetrised version of the geometric domain. The technical condition ensures that all faces $(F_k)_k$ remain on the boundary. RIGHT: In the last part of the proof, we move the position of the four marked faces. The quad and boundary conditions are now fully symmetric under Σ .

For the sake of intuition, we informally think of a quad as approximating a rectangle, with F_0 approximately in the lower-left corner, and with the other marked faces appearing close to the other corners of the rectangle, see Figure 6, LEFT. In this spirit, we shall write

$$\text{Left}_Q := E_0, \quad \text{Top}_Q := E_1, \quad \text{Right}_Q := E_2, \quad \text{Bottom}_Q := E_3,$$

where E_k denotes the set of dual edges that p uses to get from F_k to F_{k+1} , or from F_3 to F_0 in the case that $k = 3$. Let ∂Q denote the union of these sets. For $E \subset \mathbb{E}^*$, let $\mathbb{F}(E)$ denote the set of faces incident to an edge in E . Finally, if F is some set of faces and $R \subset \mathbb{R}^2$, then we write $F \subset R$ if all convex hulls of faces in F are contained in R .

6.1. Crossing quads.

Definition 6.2 (Wide quads). Let $a \in \mathbb{Z}_{\geq 1}$. A quad Q is called a -wide if for some $n \in \mathbb{Z}_{\geq 1}$,

$$\mathbb{F}(\partial Q) \subset \mathbb{R} \times \llbracket n \rrbracket, \quad \mathbb{F}(\text{Left}_Q) \subset (-\infty, -an] \times \llbracket n \rrbracket, \quad \mathbb{F}(\text{Right}_Q) \subset [an, \infty) \times \llbracket n \rrbracket.$$

We also impose a technical condition, namely that

- The set $\mathbb{F}(\text{Left}_Q)$ is connected to ∞ by a path which avoids $\mathbb{F}(\partial Q)$ except at its starting point, and whose faces lie in $(-\infty, -an] \times \llbracket n \rrbracket$, and that
- The set $\mathbb{F}(\text{Right}_Q)$ is connected to ∞ by a path which avoids $\mathbb{F}(\partial Q)$ except at its starting point, and whose faces lie in $[an, \infty) \times \llbracket n \rrbracket$.

A 1-wide quad is also called *wide*.

See Figure 6, LEFT for an example of a wide quad. The result presented below is also true without the technical condition, but is easier to prove with the technical condition present.

Lemma 6.3 (Crossing of wide quads). Let $Q = (p, F, \Lambda)$ denote a wide quad, and let (Λ, τ, ξ) denote a boundary condition where τ is arbitrary and $\xi := 1_{\text{Left}_Q^*} + 1_{\text{Right}_Q^*}$. Then

$$\mu_{\Lambda, \tau, \xi}(\mathbb{F}(\text{Top}_Q) \xleftarrow{\mathcal{L}_0} \mathbb{F}(\text{Bottom}_Q)) \geq \frac{1}{2}.$$

Proof. Let $\Sigma : (x, y) \mapsto (y, x)$ denote the flip symmetry through the diagonal, which is a symmetry of \mathbb{R}^2 and of the square lattice and its derived objects. The proof follows the following rough three-step sketch.

1. First, we replace the geometric domain by the union of the domain with its symmetric counterpart with zero boundary height, using monotonicity in domains to see that

this can only decrease the probability of the event of interest. This replacement is illustrated by Figure 6, LEFT and MIDDLE.

2. Then, we increase the boundary height on part of the boundary of the larger domain, using monotonicity in absolute heights to see that this can only decrease the probability of the event of interest; see Figure 6, MIDDLE and RIGHT.
3. Finally, we observe that the final domain is symmetric under Σ in two ways: it is geometrically invariant under Σ , and applying Σ to the boundary height function corresponds to interchanging its zeros and ones (see Figure 6, RIGHT). In particular, the probability of the events

$$\mathbb{F}(\text{Top}_{\hat{Q}}) \xleftrightarrow{\mathcal{L}_0} \mathbb{F}(\text{Bottom}_{\hat{Q}}); \quad \mathbb{F}(\text{Left}_{\hat{Q}}) \xleftrightarrow{\mathcal{L}_1} \mathbb{F}(\text{Right}_{\hat{Q}})$$

is the same under this final measure, where \hat{Q} is the symmetric quad. Since at least one of these two events must deterministically occur, each event has probability at least $1/2$.

We now make this sketch rigorous. First, recall Definition 3.7 for unions of boundary conditions, and define a new boundary condition by

$$(\hat{\Lambda}, \hat{\tau}, \hat{\xi}') := (\Lambda, \tau, \xi) \cup^* (\Sigma\Lambda, \Sigma\tau, 0).$$

Note that we use \cup^* rather than \cup ; this means that all vertices surrounded by $\Lambda \cup \Sigma\Lambda$ are also in $\hat{\Lambda}$. Let \hat{p} denote the unique (up to parametrisation) closed circuit tracing the edges in $(\partial_e \hat{\Lambda})^*$ in clockwise direction. The technical condition guarantees that $\text{Left}_{\hat{Q}}$ and $\text{Right}_{\hat{Q}}$ are traced by the path \hat{p} , and in particular this means that \hat{p} visits all faces in F . The triple $\hat{Q}' := (\hat{p}, F, \hat{\Lambda})$ is therefore well-defined as a quad, and satisfies

$$\text{Left}_{\hat{Q}'} = \text{Left}_{\hat{Q}}; \quad \text{Right}_{\hat{Q}'} = \text{Right}_{\hat{Q}};$$

see Figure 6, MIDDLE. The function $\hat{\tau}$ has the crucial property that it equals τ on $\text{Left}_{\hat{Q}}^* \cup \text{Right}_{\hat{Q}}^*$, and therefore $(\Lambda, \tau, \xi) \preceq (\hat{\Lambda}, \hat{\tau}, \hat{\xi}')$; see also Remark 3.8. In particular, monotonicity in domains (Lemma 3.6) and inclusion of events yields

$$\begin{aligned} \mu_{\Lambda, \tau, \xi}(\mathbb{F}(\text{Top}_{\hat{Q}}) \xleftrightarrow{\mathcal{L}_0} \mathbb{F}(\text{Bottom}_{\hat{Q}})) &\geq \mu_{\hat{\Lambda}, \hat{\tau}, \hat{\xi}'}(\mathbb{F}(\text{Top}_{\hat{Q}}) \xleftrightarrow{\mathcal{L}_0 \cap \mathbb{E}(\Lambda)^*} \mathbb{F}(\text{Bottom}_{\hat{Q}})) \\ &\geq \mu_{\hat{\Lambda}, \hat{\tau}, \hat{\xi}'}(\mathbb{F}(\text{Top}_{\hat{Q}'}) \xleftrightarrow{\mathcal{L}_0} \mathbb{F}(\text{Bottom}_{\hat{Q}'})). \end{aligned}$$

Now the second step. Define \hat{F} as follows: \hat{F}_0 and \hat{F}_2 are the last faces before F_0 and F_2 respectively in the path \hat{p} that lie on the diagonal $\{(x, y) : x = y\}$; \hat{F}_1 is the first face after F_1 that lies on the diagonal $\{(x, y) : x + y = 0\}$, and $\hat{F}_3 := \Sigma\hat{F}_1$; see Figure 6, RIGHT. Then $\hat{Q} := (\hat{p}, \hat{F}, \hat{\Lambda})$ is a quad, and

$$\text{Top}_{\hat{Q}'} \supset \text{Top}_{\hat{Q}}, \quad \text{Bottom}_{\hat{Q}'} \supset \text{Bottom}_{\hat{Q}}, \quad \text{Left}_{\hat{Q}} \subset \text{Left}_{\hat{Q}'}, \quad \text{Right}_{\hat{Q}} \subset \text{Right}_{\hat{Q}'}$$

Define $\hat{\xi} : \partial_e \hat{\Lambda} \rightarrow \mathbb{Z}$ by $\hat{\xi} := 1_{\text{Left}_{\hat{Q}}^*} + 1_{\text{Right}_{\hat{Q}}^*} \geq \hat{\xi}'$. We have

$$\begin{aligned} \mu_{\hat{\Lambda}, \hat{\tau}, \hat{\xi}'}(\mathbb{F}(\text{Top}_{\hat{Q}'}) \xleftrightarrow{\mathcal{L}_0} \mathbb{F}(\text{Bottom}_{\hat{Q}'})) &\geq \mu_{\hat{\Lambda}, \hat{\tau}, \hat{\xi}}(\mathbb{F}(\text{Top}_{\hat{Q}'}) \xleftrightarrow{\mathcal{L}_0} \mathbb{F}(\text{Bottom}_{\hat{Q}'})) \\ &\geq \mu_{\hat{\Lambda}, \hat{\tau}, \hat{\xi}}(\mathbb{F}(\text{Top}_{\hat{Q}}) \xleftrightarrow{\mathcal{L}_0} \mathbb{F}(\text{Bottom}_{\hat{Q}})); \end{aligned}$$

the first inequality follows by monotonicity in absolute heights (Lemma 3.2), the second by inclusion of events.

In the final step, we prove that the probability on the right in the previous display equals at least $1/2$. Note that the quad \hat{Q} is symmetric under Σ , and that the domain $(\hat{\Lambda}, \hat{\tau}, \hat{\xi})$ is symmetric under Σ except that $\Sigma\hat{\xi} = 1 - \hat{\xi}$. This means that

$$\mu_{\hat{\Lambda}, \hat{\tau}, \hat{\xi}}(\mathbb{F}(\text{Top}_{\hat{Q}}) \xleftrightarrow{\mathcal{L}_0} \mathbb{F}(\text{Bottom}_{\hat{Q}})) = \mu_{\hat{\Lambda}, \hat{\tau}, \hat{\xi}}(\mathbb{F}(\text{Left}_{\hat{Q}}) \xleftrightarrow{\mathcal{L}_1} \mathbb{F}(\text{Right}_{\hat{Q}})).$$

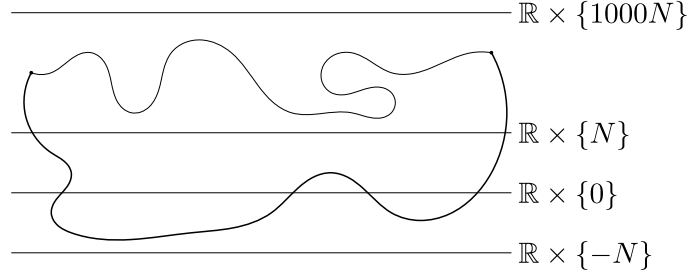

FIGURE 7. A T-quad Q : the thin line is Top_Q , the rest of ∂Q is thick.

To conclude, we show that in fact at least one of the two events must almost surely occur for any quad with the given boundary height function $\hat{\xi}$. Suppose that instead both events do not occur.

Focus on the left event. Since this event does not occur, there must exist a primal path p^0 which is open for \mathcal{L}_0° with the following properties:

- The first step lies in $\text{Left}_{\hat{Q}}^*$ and the last step lies in $\text{Right}_{\hat{Q}}^*$,
- All vertices except the first and last lie in $\hat{\Lambda}$.

This path is also open for \mathcal{K}_0 by definition of that percolation (Definition 2.13). Thus, Lemma 2.17 applies, and therefore p^0 only visits vertices in $\{h \geq 1\}$.

Similarly, if the event on the right does not occur, then there exists a similar path from $\text{Top}_{\hat{Q}}$ to $\text{Bottom}_{\hat{Q}}$ whose vertices except the first and last lie in $\{h \leq 0\}$. Planarity implies that the two paths must intersect at some vertex $x \in \hat{\Lambda}$, which is the desired contradiction because it implies that simultaneously $h_x \geq 1$ and $h_x \leq 0$. \square

6.2. Generic symmetrisation argument. This subsection captures some ideas in the previous proof in a more or less generic form. For concreteness we tailor our setup to the pushing lemma stated in the next section.

Definition 6.4 (T-Quads). A *T-quad* is a quad Q such that for some $N \in \mathbb{Z}_{\geq 1}$,

$$\mathbb{F}(\partial Q) \subset \mathbb{R} \times [-N, 1000N]; \quad \mathbb{F}(\text{Top}_Q) \subset \mathbb{R} \times [N, 1000N].$$

T-quads give us some (mild) control over the location of its top, hence the name; see Figure 7. We do not require an additional technical condition because the argument below uses \cup rather than \cup^* ; simply-connectedness plays no particular role.

Definition 6.5 (Compatible symmetries). Let $\Sigma_{x,y}^\circ$ denote the rotation of the plane around (x, y) by an angle of π for any $x, y \in \mathbb{Z}/2$. This is a symmetry of the plane, the square lattice, and all derived objects. Let Σ° denote the set of symmetries $\Sigma_{x,y}^\circ$ with $y \leq 0$. Such symmetries are called *compatible symmetries*.

The following proposition states in which way compatible symmetries are compatible with T-quads. Its proof follows from Remark 3.8.

Proposition 6.6. *Let $Q = (p, F, \Lambda)$ denote a T-quad, and let (Λ, τ, ξ) denote a boundary condition with τ arbitrary and $\xi = 1_{\text{Top}_Q^*}$. Then for any $\Sigma \in \Sigma^\circ$, we have*

$$(\Lambda, \tau, \xi) \preceq (\Lambda, \tau, \xi) \cup (\Sigma\Lambda, \Sigma\tau, 0).$$

For the statement of the following lemma, recall the definition of the symmetric invasion percolation from Definition 2.13.

Lemma 6.7 (Generic symmetrisation). *Let $Q = (p, F, \Lambda)$ denote a T-quad, and let (Λ, τ, ξ) denote a boundary condition with τ arbitrary and $\xi = 1_{\text{Top}_Q^*}$. Let $F \subset \mathcal{P}(\mathbb{E})$ denote an increasing family of percolation configurations. Then for any $\Sigma \in \Sigma^\circ$, we have*

$$\mu_{\Lambda, \tau, \xi}(\mathcal{K}_0 \in F) \leq \mu_{\Lambda, \tau, \xi}(\mathcal{K}_0^* \in \Sigma F).$$

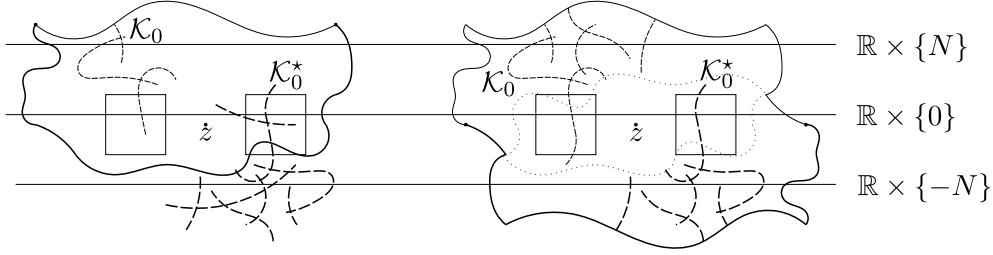

FIGURE 8. The generic symmetrisation argument. For F , we chose the vertical crossing event of the rectangle on the left. The point $z = (x, y)$ marks the symmetry point; ΣF is the crossing event of the rectangle on the right. The boundary conditions (Λ, τ, ξ) and (Λ', τ', ξ'') are represented by the figures on the left and right respectively. The change in boundary conditions increases \mathcal{K}_0 and decreases \mathcal{K}_0^* . Recall that \mathcal{K}_0^* is also defined outside $\mathbb{E}(\Lambda)$.

Proof. The proof is illustrated by Figure 8. Let $x, y \in \mathbb{Z}/2$ denote the coordinates used to define Σ . Suppose for now that y is not an integer. We will first define new boundary conditions in two stages. First, let

$$(\Lambda', \tau', \xi') := (\Lambda, \tau, \xi) \cup (\Sigma\Lambda, \Sigma\tau, 0),$$

and then let ξ'' denote the unique boundary height function on $\partial_e \Lambda'$ which assigns a 1 to all edges above the symmetry line $\mathbb{R} \times \{y\}$ and 0 to all edges below it. Clearly $\xi'' \geq \xi'$, and therefore

$$(\Lambda, \tau, \xi) \preceq (\Lambda', \tau', \xi') \preceq (\Lambda', \tau', \xi'').$$

Observe that replacing $\mu_{\Lambda, \tau, \xi}$ by $\mu_{\Lambda', \tau', \xi''}$ stochastically increases \mathcal{K}_0 , and therefore it also stochastically decreases \mathcal{K}_0^* . In other words, it suffices to prove that

$$\mu_{\Lambda', \tau', \xi''}(\mathcal{K}_0 \in F) \leq \mu_{\Lambda', \tau', \xi''}(\mathcal{K}_0^* \in \Sigma F).$$

But since $\mathcal{K}_1 \subset \mathcal{K}_0^*$, it suffices to prove that

$$\mu_{\Lambda', \tau', \xi''}(\mathcal{K}_0 \in F) \leq \mu_{\Lambda', \tau', \xi''}(\mathcal{K}_1 \in \Sigma F).$$

In fact, the two quantities must be equal by symmetry. This finishes the proof.

If y is an integer instead, then there may be boundary edges xy which lie exactly on the symmetry line $\mathbb{R} \times \{y\}$. To cover this case, one can simply flip a single fair coin taking values in $\{0, 1\}$ to decide on the value of all those edges, and average over the two outcomes. \square

Remark 6.8. The generic symmetrisation lemma may be used in two ways.

1. First, if the events $\{\mathcal{K}_0 \in F\}$ and $\{\mathcal{K}_0^* \in \Sigma F\}$ are disjoint, then the lemma implies that $\mu_{\Lambda, \tau, \xi}(\mathcal{K}_0 \in F) \leq 1/2$. This means that we have upper bounds on probabilities for certain geometrically constrained percolation events.
2. Second, if we know that $\mu_{\Lambda, \tau, \xi}(\mathcal{K}_0 \in F) \geq \varepsilon$, then we know that $\mu_{\Lambda, \tau, \xi}(\mathcal{K}_0^* \in \Sigma F) \geq \varepsilon$ for all $\Sigma \in \Sigma^\circ$. Informally, this means that good percolation of \mathcal{K}_0 *somewhere* in the lower half plane implies good percolation of \mathcal{K}_0^* *everywhere* in the lower half plane. This informal statement shall be given a more precise meaning in the proof of the pushing lemma in the next section.

The following proposition is an example of the first way of applying the lemma. For the proof, one considers the symmetry which rotates around the midpoint of the edge.

Proposition 6.9 (Bound on edge probabilities). *Let $Q = (p, F, \Lambda)$ denote a T -quad, and let (Λ, τ, ξ) denote a boundary condition with τ arbitrary and $\xi = 1_{\text{Top}_Q^*}$. If $xy \in \mathbb{E}$ is any*

edge whose midpoint lies on or below the line $\mathbb{R} \times \{0\}$, then

$$\mu_{\Lambda, \tau, \xi}(xy \in \mathcal{K}_0) \leq \frac{1}{2}.$$

6.3. Percolation on the mesoscopic scale.

Lemma 6.10 (Crossing of mesoscopic squares). *There exists a universal constant $c_{\text{meso}} > 0$ with the following properties. Suppose given an integer $N \in \mathbb{Z}_{\geq 1}$ and some boundary condition (Λ, τ, ξ) with $\Lambda \subset \mathbb{R} \times \llbracket 1000N \rrbracket$ and $\xi \leq 1$. Suppose also given an integer $n \in \mathbb{Z}_{\geq 1}$, and let R denote the square $\llbracket n \rrbracket^2$ or some translate thereof by integer coordinates, and which satisfies $\text{Dist}(R, \mathbb{Z}^2 \setminus \Lambda) \geq N/4$. Then*

$$\mu_{\Lambda, \tau, \xi}(\mathcal{L}_{\leq 1}^{\diamond} \in \text{Hor}\{R\}) \leq 1 - c_{\text{meso}}.$$

The same holds true when $\text{Hor}\{R\}$ is replaced by $\text{Ver}\{R\}$.

Recall that $\mathcal{L}_{\leq 1}^{\diamond}$ connects vertices whose height strictly exceeds one. At first sight, it might appear that this lemma is similar to the ideas in Section 5. An important aspect of this lemma, however, is that the upper bound does *not* degenerate as the ratio n/N tends to zero. Observe also that the lemma becomes false whenever $\mathcal{L}_{\leq 1}^{\diamond}$ is replaced by \mathcal{L}_1^{\diamond} . Indeed, if the height function is delocalised, then the probability of a horizontal crossing by either $\mathcal{L}_{\leq 1}^{\diamond}$ or $\mathcal{L}_{\geq 1}^{\diamond}$ should tend to one as n/N tends to zero. The proof must therefore somehow use the negative correlation between the two events to deduce that the crossing by one percolation bars the crossing by the other percolation.

Proof of Lemma 6.10. Without loss of generality, $R = \llbracket n \rrbracket^2$. By monotonicity in heights, we may assume that $\xi \equiv 1$. In fact, we shall prove the lemma instead for $\xi \equiv 0$ and for $\mathcal{L}_{\leq 1}^{\diamond}$ replaced by $\mathcal{L}_{\leq 0}^{\diamond}$. The lemma is immediate from Lemma 5.1 whenever $N \leq 1000$ as soon as we choose $c_{\text{meso}} \leq c_{\text{net}}$, and we focus on the remaining case. Let

$$R' := \llbracket m + N/12 \rrbracket^2 \cap \mathbb{Z}^2 \subset \Lambda.$$

We split the proof into two cases, depending on the value of

$$p := \mu_{R', 0, 0}(\mathcal{L}_0^{\diamond} \in \text{Hor}\{R\}).$$

First consider the case that $p > 2/3$. Observe that the vertical crossing has the same probability, and therefore

$$\mu_{\Lambda, \tau, \xi}(\mathcal{L}_{\geq 0}^{\diamond} \in \text{Ver}\{R\}) \geq \frac{1}{2} \mu_{\Lambda, \tau, \xi}(\mathcal{L}_0^{\diamond} \in \text{Ver}\{R\}) \geq \frac{1}{2} \mu_{R', 0, 0}(\mathcal{L}_0^{\diamond} \in \text{Ver}\{R\}) \geq \frac{1}{3},$$

where the second inequality is monotonicity in domains. Since the first event in the display is disjoint from the event whose probability we aim to upper bound, we observe that any choice $c_{\text{meso}} \leq 1/3$ suffices. Secondly, consider the case that $p \leq 2/3$. Let A denote the event that $\partial_v R'$ is not connected to R by a path in \mathcal{L}_0^{\diamond} . Then, writing μ for $\mu_{\Lambda, \tau, \xi}$, we have

$$\begin{aligned} \mu(\mathcal{L}_{\leq 0}^{\diamond} \in \text{Hor}\{R\}) &\leq \mu(\mathcal{L}_0^{\diamond} \in \text{Hor}\{R\}) \leq (1 - \mu(A)) + \mu(A)\mu(\mathcal{L}_0^{\diamond} \in \text{Hor}\{R\} | A) \\ &\leq (1 - \mu(A)) + \mu(A)\frac{2}{3} = 1 - \frac{1}{3}\mu(A). \end{aligned}$$

The last inequality is obtained as follows. If the event A occurs, then one runs a target height exploration with target height zero, starting from the complement of the rectangle R' . Conditional on the event A , such an exploration process terminates before reaching R . The conditional probability of the crossing event may now be compared to p through monotonicity in domains. Since $\mu(A) \geq c_{\text{net}}$ by the net lemma, the values in the previous display are bounded above by $1 - c_{\text{net}}/3$, so that the choice $c_{\text{meso}} := c_{\text{net}}/3$ suffices. \square

7. THE PUSHING LEMMA

7.1. Statement. The purpose of this section is to prove the following lemma.

Lemma 7.1 (The pushing lemma). *There exists a universal constant $c_{\text{push}} > 0$ with the following property. Let $Q = (p, F, \Lambda)$ denote a T -quad with N the corresponding integer in the definition. Let $(\Lambda, \tau, \xi) \in \text{Bound}_{\geq 0}$ with τ arbitrary and $\xi = 1_{\text{Top}_Q^*}$. Let $w \in \mathbb{Z}_{\geq 1}$ minimal subject to $\partial_v \Lambda \subset \llbracket wN \rrbracket \times \mathbb{R}$. Then*

$$\mu_{\Lambda, \tau, \xi}(\partial_v \Lambda \xleftarrow{\mathcal{K}_0} \mathbb{R} \times (-\infty, -\frac{N}{2}]) \geq c_{\text{push}}^w.$$

This lemma serves as a black box in the remainder of this article: its proof is completely independent of the line of reasoning in subsequent sections, and may be read independently. The proof of the lemma is hard, but not necessarily technical. Rather, it combines all the symmetries in Section 6 with a model-specific Russo-Seymour-Welsh theory built around Lemma 4 of [KT23], which is an inequality involving the probability of *quasicrossings* at different scales. Before starting the proof, we highlight one difficulty which complicates the proof relative to the proof of the pushing lemma in the work of Duminil-Copin and Tassion [DT19, Lemma 13]. In that work, the percolation behaves monotonously in the location of *both* the wired and the free boundary, see [DT19, Section 2.2]. If this were true in our setting, then we would argue that Top_Q is a straight, horizontal line, without loss of generality. This implies two symmetries of the model: invariance under horizontal translations and under reflections through vertical lines. The proof in [DT19] crucially relies on both symmetries. Since we can only change the location of the boundary where the boundary height equals zero, we cannot straighten Top_Q into a line. The challenge is thus to prove the pushing lemma in the less symmetric setup.

In fact, we shall not use the pushing lemma directly, but rather the following corollary. We omit its proof; the corollary follows exactly as Lemma 5.2 followed from Lemma 5.1: one iterates the pushing lemma at exponentially decreasing scales.

Corollary 7.2. *There exists a universal constant $c > 0$ with the following property. Suppose that $n, m \in \mathbb{Z}_{\geq 1}$ with $m \leq n$, and let $Q = (p, F, \Lambda)$ denote a quad such that*

$$\partial Q \subset \llbracket n \rrbracket \times [-n, 0]; \quad \text{Top}_Q \subset \llbracket n \rrbracket \times [-m, 0].$$

Let $(\Lambda, \tau, \xi) \in \text{Bound}_{\geq 0}$ with $\xi = 1_{\text{Top}_Q^}$ and τ arbitrary. Then*

$$\mu_{\Lambda, \tau, \xi}(\mathcal{K}_0 \notin \text{Ver}\{\llbracket n \rrbracket \times [-2m, -m]\}) \geq c^{n/m}.$$

7.2. Proof overview. This subsection introduces rigorously some of the key ideas for the derivation, but lacks a number of details which are explained later. The choice of Q and (Λ, τ, ξ) is fixed throughout this section. We first (rigorously) cover small values for N .

Proof of Lemma 7.1 for $N \leq N_{\text{small}} := 10^{12}$. By Proposition 6.9 and the FKG inequality, all edges crossing or having an endpoint on the line $\mathbb{R} \times \{-\frac{N}{2}\}$ are closed for \mathcal{K}_0 with probability at least 2^{-8wN} . Therefore any choice $c_{\text{push}} \leq 2^{-8N_{\text{small}}}$ suffices. \square

From now on we only consider $N \geq N_{\text{small}}$. Before we start, let us mention that the percolation \mathcal{K}_0 is compatible with both FKG inequalities (Lemma 2.17). At some points in the argument, we crucially take both viewpoints simultaneously. Now introduce some notation. Write $\mu := \mu_{\Lambda, \tau, \xi}$. For any $R \subset \mathbb{R}^2$ and for any $n, m \in \mathbb{Z}_{\geq 1}$, let $\text{Rect}[n \times m, R]$ denote the set of $n \times m$ rectangles with integer coordinates and which are contained in R . Define the following three rectangles:

$$\begin{aligned} U_{\text{out}} &:= [-10N, 10N] \times [-\frac{8}{16}N, -\frac{0}{16}N], \\ U_{\text{mid}} &:= [-9N, 9N] \times [-\frac{7}{16}N, -\frac{1}{16}N], \\ U_{\text{in}} &:= [-8N, 8N] \times [-\frac{6}{16}N, -\frac{2}{16}N]; \end{aligned}$$

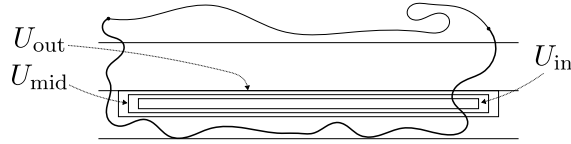

FIGURE 9. A T-quad with the universes U_{out} , U_{mid} , and U_{in} .

see Figure 9. These rectangles are called the *outer*, *middle*, and *inner universe* respectively. Their precise dimensions do not matter, but the following observations are important.

1. Each universe contains the next, with a margin of at least $N/16$ in the sense that the Euclidean distance from the boundary of one universe to the boundary of another universe is at least $N/16$.
2. The outer universe lies below $\mathbb{R} \times \{0\}$, and therefore each $R \in \text{Rect}[n \times m, U_{\text{out}}]$ has exactly one symmetry in Σ° which leaves R invariant: the symmetry which rotates R around its barycentre by an angle of π . In a similar spirit, each pair of rectangles $R, R' \in \text{Rect}[n \times m, U_{\text{out}}]$ has one symmetry which maps R to R' .

In this section we shall study the percolation of $\mathcal{B} := \mathcal{K}_0^\circ$ in U_{out} , where \mathcal{K}_0° is the dual-complement of \mathcal{K}_0 . Recall that $\mathcal{K}_0 \subset \mathbb{E}$ and therefore $\mathcal{B} \subset \mathbb{E}^*$. For a fixed universe $U \subset \mathbb{R}^2$ and for fixed $1 \leq m \leq N/10$ and $\alpha > 0$, we say that α -percolation occurs in U at scale m whenever

$$\mu(\mathcal{B} \in \text{Hor}^*\{R\}), \mu(\mathcal{B} \in \text{Ver}^*\{R\}) \geq \alpha$$

for all $R \in \text{Rect}[2m \times m, U] \cup \text{Rect}[m \times 2m, U]$. The statement that α -percolation occurs in U at scale m is also denoted $\text{Perc}[m, \alpha, U]$. We first reduce to the following lemma.

Lemma 7.3 (Macroscopic percolation lemma). *For some universal $\alpha_{\text{macro}} > 0$, we have $\text{Perc}[\lfloor N/20 \rfloor, \alpha_{\text{macro}}, U_{\text{in}}]$.*

Proof that Lemma 7.3 implies Lemma 7.1. Since the lemma does not impose restrictions on Q , it also applies to horizontal translates of Q (which are T-quads with the same value for N). But we may also translate U_{in} rather than Q , and therefore we observe that the lemma implies that in fact

$$\text{Perc}[\lfloor N/20 \rfloor, \alpha_{\text{macro}}, \mathbb{R} \times [-\frac{6}{16}N, -\frac{2}{16}N]]$$

holds true. By choosing $c_{\text{push}} := \alpha_{\text{macro}}^{100} \wedge 2^{-8N_{\text{small}}}$, one may use standard gluings to see that

$$\mu(\mathcal{B} \in \text{Hor}^*\{[wN] \times [[-\frac{6}{16}N], [-\frac{2}{16}N]]\}) \geq c_{\text{push}}^w$$

for $N \geq N_{\text{small}}$, where w is chosen as in the statement of Lemma 7.1. \square

Thus, it suffices to prove 7.3. We start with some lower bounds which come from the generic symmetrisation lemma. Define for each $n, m \in \mathbb{Z}_{\geq 1}$ the *global bound*

$$\chi(n, m) := \sup_{R \in \text{Rect}[n \times m, U_{\text{out}}]} \mu(\mathcal{K}_0 \in \text{Ver}\{R\}).$$

This quantity is clearly increasing in n and decreasing in m . By definition, $\chi(n, m)$ bounds the probability of top-bottom crossings by \mathcal{K}_0 . However, $\chi(n, m)$ crucially *also* bounds the probability of left-right crossings by the same percolation.

Proposition 7.4. *For any $n, m \in \mathbb{Z}_{\geq 1}$ and $R \in \text{Rect}[n \times m, U_{\text{out}}]$, we have*

$$\mu(\mathcal{K}_0 \in \text{Hor}\{R\}) \leq 1 - \chi(n, m).$$

Proof. The event in the statement of the lemma is disjoint from the event $\{\mathcal{K}_0^* \in \text{Ver}\{R\}\}$. Let R' denote the rectangle which makes the expression defining $\chi(n, m)$ reach its supremum. Since there is a symmetry $\Sigma \in \Sigma^\circ$ which maps R' to R , the generic symmetrisation lemma says that $\mu(\mathcal{K}_0^* \in \text{Ver}\{R\}) \geq \chi(n, m)$. \square

Since $\chi(n, m)$ is increasing in n , we may fix m and look for the corresponding value of n such that $\chi(n, m) \approx 1/2$, so that we have upper bounds on probabilities of both horizontal and vertical crossings of rectangles in $\text{Rect}[n \times m, U_{\text{out}}]$ by \mathcal{K}_0 . These upper bounds have associated lower bounds on rectangle crossing probabilities by \mathcal{B} . Formally, we first introduce a tiny constant $\delta_{\text{aspect}} := 2^{-600} > 0$, which plays the role of the number $1/2$ in the above story. To formalise the idea of choosing n dynamically in terms of m , we introduce the *aspect ratio at scale $m \in \mathbb{Z}_{\geq 1}$* , defined by

$$\rho(m) := \frac{1}{m} \inf \{n \in 24\mathbb{Z}_{\geq 1} : \chi(n, m) \geq 1 - \delta_{\text{aspect}}\}.$$

The appearance of the number 24 guarantees that $\rho(m)m/12$ is always even. For technical reasons, we also often prefer to choose m such that it is divisible by 10.

Proposition 7.5. *For any $m \in \mathbb{Z}_{\geq 1}$, the following statements hold true.*

1. For any $n \leq \rho(m)m - 24$, $R \in \text{Rect}[n \times m, U_{\text{out}}]$,

$$\mu(\mathcal{B} \in \text{Hor}^*\{R\}) \geq \delta_{\text{aspect}}.$$

2. For any $n \geq \rho(m)m$, $R \in \text{Rect}[n \times m, U_{\text{out}}]$,

$$\mu(\mathcal{B} \in \text{Ver}^*\{R\}) \geq 1 - \delta_{\text{aspect}}.$$

3. If $\rho(m) < \infty$, then

$$\mu(\mathcal{K}_0 \in \text{Ver}\{R_m\}) \geq 1 - \delta_{\text{aspect}}$$

for some $R_m \in \text{Rect}[\rho(m)m \times m, U_{\text{out}}]$.

The last item is considered a definition for R_m .

Proof. The first item follows from the definition of χ and ρ and duality of \mathcal{K}_0 and \mathcal{B} . The second item follows from the definitions, duality, monotonicity of $\chi(n, m)$ in n , and the previous proposition. The third item is immediate from the definition of ρ . \square

Let us now introduce the quasicrossing. The definitions come directly from [KT23], except that they are defined with the dynamical aspect ratio ρ . They are illustrated by Figure 10. The letter β denotes the fixed constant $\frac{1}{12}$ throughout this section.

Definition 7.6 (Boxes, arms, bridges, and quasicrossings). Let $x, y \in \mathbb{Z}^2$. Consider $m \in 10\mathbb{Z}_{\geq 1}$ with $\rho(m) < \infty$. Fix $a \in \mathbb{Z}_{> -12}$. First, let $\text{Box}_{a\beta}(x, y, m)$ denote the rectangle with side lengths $(1 + a\beta)\rho(m)m \times m$ centred at (x, y) . Note that both side lengths are even so that this rectangle has integer coordinates. Let $\text{High}(x, y, m)$ and $\text{Low}(x, y, m)$ denote closed horizontal line segments of length $\beta\rho(m)m$ centred and contained within the top and bottom of $\text{Box}_{a\beta}(x, y, m)$ respectively. These line segments are called *targets*. Define the *arm event*

$$\text{Arm}[x, y, m] := \{\omega \subset \mathbb{E} : \text{High}(x, y, m) \xrightarrow{\omega \text{ in } \text{Box}_{a\beta}(x, y, m)} \text{Low}(x, y, m)\} \subset \mathcal{P}(\mathbb{E}).$$

The boundary $\partial \text{Box}_{a\beta}(x, y, m) \setminus (\text{High}(x, y, m) \cup \text{Low}(x, y, m))$ contains two connected components; write L and R for the closure of the left and right connected component respectively throughout this definition. Define the *bridge event*

$$\text{Bridge}[x, y, m] := \{\omega \subset \mathbb{E} : L \xrightarrow{\omega \text{ in } \text{Box}_{a\beta}(x, y, m)} R\} \subset \mathcal{P}(\mathbb{E}).$$

The natural dual counterparts of these percolation events are given by

$$\text{Arm}^*[x, y, m] := \{\omega \subset \mathbb{E}^* : \omega^\diamond \notin \text{Bridge}[x, y, m]\} \subset \mathcal{P}(\mathbb{E}^*);$$

$$\text{Bridge}^*[x, y, m] := \{\omega \subset \mathbb{E}^* : \omega^\diamond \notin \text{Arm}[x, y, m]\} \subset \mathcal{P}(\mathbb{E}^*).$$

For $m, m' \in 10\mathbb{Z}_{\geq 1}$ with $m' \leq m$ and $\rho(m) < \infty$, the *quasicrossing* is the percolation event $\text{Quasi}^*[x, y, m, m'] \subset \mathcal{P}(\mathbb{E}^*)$ of percolations $\omega \subset \mathbb{E}^*$ such that $\omega \cap \mathbb{E}_\circ^*(\text{Box}_{3\beta}(x, y, m))$ contains two connected components $\omega', \omega'' \subset \mathbb{E}^*$ (which may be equal) such that

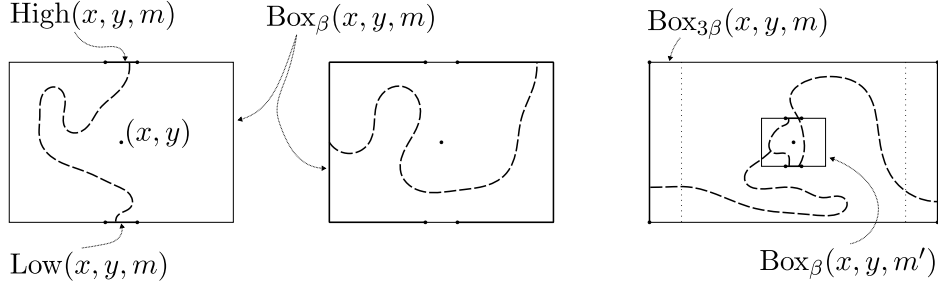

FIGURE 10. $\text{Arm}^*[x, y, m]$, $\text{Bridge}^*[x, y, m]$, and $\text{Quasi}^*[x, y, m, m']$

1. $\omega' \in \text{Arm}^*[x, y, m']$ and ω' contains an edge traversing $\text{Left}_{\text{Box}_{3\beta}(x, y, m)}$,
2. $\omega'' \in \text{Arm}^*[x, y, m']$ and ω'' contains an edge traversing $\text{Right}_{\text{Box}_{3\beta}(x, y, m)}$.

Our objective is to derive Lemma 7.3, which asserts that \mathcal{B} percolates on the macroscopic scale. Suppose that we want to derive $\text{Perc}[m, \alpha, U]$ for $m \approx N$. To prove this, we must essentially demonstrate that each rectangle $\text{Box}_{3\beta}(x, y, m) \in \text{Rect}[(1 + 3\beta)\rho(m)m \times m, U]$ can be crossed horizontally by \mathcal{B} with a sufficiently high probability, because standard gluings and Proposition 7.5, Statement 2 can then be used to create crossings of larger rectangles (although the situation is more delicate if $\rho(m)$ is very large or small). Using Proposition 7.5 and some ideas explained later in full detail, we are essentially able to deduce that at least one of the following two events must occur with sufficiently high probability:

1. The horizontal crossing event $\{\mathcal{B} \in \text{Hor}^*\{\text{Box}_{3\beta}(x, y, m)\}\}$,
2. The quasicrossing event $\{\mathcal{B} \in \text{Quasi}^*[x, y, m, m']\}$ for some well-chosen $m' \leq m$.

The definition of a quasicrossing is such that quasicrossings at different scales compose well: if $m \geq m' \geq m''$ for some $m, m', m'' \in 10\mathbb{Z}_{\geq 1}$, then the *topological lemma* of [KT23] asserts that

$$\text{Quasi}^*[x, y, m, m'] \cap \text{Quasi}^*[x, y, m', m''] \subset \text{Quasi}^*[x, y, m, m''].$$

Moreover, quasicrossings have the *closing property* [KT23], which asserts that

$$\begin{aligned} \text{Quasi}^*[x, y, m, m''] \cap \text{Bridge}^*[x, y, m''] &\subset \text{Hor}^*\{\text{Box}_{3\beta}(x, y, m)\} \\ &\subset \text{Bridge}^*[x - \beta\rho(m)m, y, m] \cap \text{Bridge}^*[x, y, m] \cap \text{Bridge}^*[x + \beta\rho(m)m, y, m]. \end{aligned}$$

In [KT23], one considers quasicrossings along a sequence of scales $m, m/4, m/16, \dots, m/4^k$. Crucially, it is shown that quasicrossings have the *cascading property* which means that the probability of the *intersection* of quasicrossings at consecutive scales $m, m/4, m/16, \dots, m/4^k$ does not decay with k , at least until k is so large that we can *close* the smallest quasicrossing with a bridge $\text{Bridge}^*[x, y, m/4^k]$ with a uniformly positive probability. The intersection of the quasicrossings at all scales up to $m/4^k$ with the occurrence of the bridge event at the scale $m/4^k$ implies the occurrence of the event $\text{Hor}^*\{\text{Box}_{3\beta}(x, y, m)\}$, which is thus shown to have uniformly positive probability.

Let us point out a number of details before starting the formal proof. Recall that our objective is to prove Lemma 7.3. The geometrical construction of the quasicrossing is hard, and may fail for several reasons. However, we show that at each scale m , either the construction of the quasicrossing at scale m succeeds, or it fails and we derive percolation at scale m for other reasons. This means that the event $\{\mathcal{B} \in \text{Bridge}^*[x, y, m]\}$ has a uniformly positive probability whenever the construction of the quasicrossing fails. This way we are able to implement the inductive scheme of [KT23], starting at the macroscopic scale $m \approx N$ all the way down to the scale $m \approx 1$, or until the construction fails at some scale in which case we are able to immediately close the quasicrossing instead.

We highlight three important aspects of the proof.

1. It will be very important for the proof to control the aspect ratio. We cannot construct the quasicrossing without a uniform bound on ρ . Therefore we prove that percolation occurs at the scale $9m$ whenever $\rho(m) \notin [1/12, 12]$ (Corollary 7.9).
2. Even though we obtain bounds on $\rho(m)$, the sequence $(\rho(m))_m$ is not approximately constant. This is inconvenient for the construction of the quasicrossing. The problem is circumvented by finding a sequence of *good scales* along which $\rho(\cdot)$ is sufficiently well-behaved for the construction of the quasicrossing. As a consequence, each next scale in the iteration is not smaller by a factor four as in [KT23], but rather by a (dynamical) factor which lies in between 260 and M each time, where M is a constant whose numerical value comes from Lemma 7.12.
3. The bounds in Proposition 7.5 are not sufficient to construct the quasicrossing, because the quasicrossing event is not an intersection of events appearing in that statement. Focus on the event $\{\mathcal{K}_0 \in \text{Ver}\{R_m\}\}$. A significant amount of effort is spent on *upgrading* this event, in the sense that we prove that either some subevent of the form $\{\mathcal{K}_0 \in F\}$ must also occur with a good probability, or that percolation occurs at some nearby scale for other reasons. In the former case, we transport the bound to a lower bound on $\{\mathcal{K}_0^* \in \Sigma F\}$ for any $\Sigma \in \Sigma^\circ$ using the generic symmetrisation lemma. The relation between \mathcal{K}_0^* and \mathcal{B} (Proposition 2.18) is then used to construct the quasicrossing. The upgrading is performed in Subsection 7.5.

The proof has some numerical constants whose value is chosen to make the geometric constructions fit. However, their precise value does often not matter, and the reader may choose to first read the argument without paying attention to these constants, before verifying that these constants make the proof work.

7.3. A uniform bound on the aspect ratio. Let us assume without loss of generality that $U \cap \mathbb{Z}^2 \subset \Lambda$ where $U = \llbracket 11N \rrbracket \times (-N, +N/2]$; to justify this, we simply replace the boundary condition by $(\Lambda, \tau, \xi) \cup^*(U, 0, 0)$, noting that this can only decrease the probability of the event whose likelihood we are aiming to lower bound. The distance from U_{out} to ∂U is larger than $N/4$. By definition of a T-quad, $\Lambda \subset \mathbb{R} \times \llbracket 1000N \rrbracket$, and therefore we may apply Lemma 6.10 for crossing mesoscopic squares in $\text{Rect}[n \times n, U_{\text{out}}]$. Let us first mention a near-trivial result which allows us to build crossings of large rectangles from crossings of small rectangles.

Proposition 7.7. *Suppose that $\text{Perc}[m, \alpha, U]$ for some $1 \leq m \leq N/10$, some $\alpha > 0$, and some universe U . Then $\text{Perc}[m', \alpha^{5m'/m}, U]$ for any $m \leq m' \leq N/10$.*

Proof. The proof is entirely standard. For each $R \in \text{Rect}[2m' \times m', U] \cup \text{Rect}[m' \times 2m', U]$, one may find $\lfloor 5m'/m \rfloor$ rectangles in $\text{Rect}[2m \times m, U] \cup \text{Rect}[m \times 2m, U]$ such that \mathcal{B} crosses the large rectangle R in the long direction whenever \mathcal{B} crosses all $\lfloor 5m'/m \rfloor$ small rectangles in the long direction. The FKG inequality yields the final result. \square

In the remainder of this subsection we essentially derive uniform bounds on $\rho(m)$, by asserting that percolation must occur (at a slightly larger scale) whenever $\rho(m)$ degenerates.

Lemma 7.8. *For $\alpha > 0$, let $\alpha' := (\alpha^2 c_{\text{meso}}^2 / 2)^{18}$. Let U and U' denote two universes with U' strictly contained in U . Then for any $1 \leq n, m \leq N/90$, we have*

$$\begin{aligned} (\forall R \in \text{Rect}[n \times 10n, U], \mu(\mathcal{B} \in \text{Ver}^*\{R\}) \geq \alpha) &\implies \text{Perc}[9n, \alpha', U']; \\ (\forall R \in \text{Rect}[10m \times m, U], \mu(\mathcal{B} \in \text{Hor}^*\{R\}) \geq \alpha) &\implies \text{Perc}[9m, \alpha', U']. \end{aligned}$$

Proof. We write the proof of the second implication. For $A \in \text{Rect}[9m \times 3m, U]$, let $A^-, A^+ \in \text{Rect}[9m \times m, U]$ denote the lowest and highest rectangles with the prescribed dimensions which are contained in A respectively, and let $H(A)$ denote the event that $\mathcal{B} \cap \mathbb{E}_\circ^*(A)$ contains a connected component which is contained in both $\text{Hor}^*\{A^-\}$ and

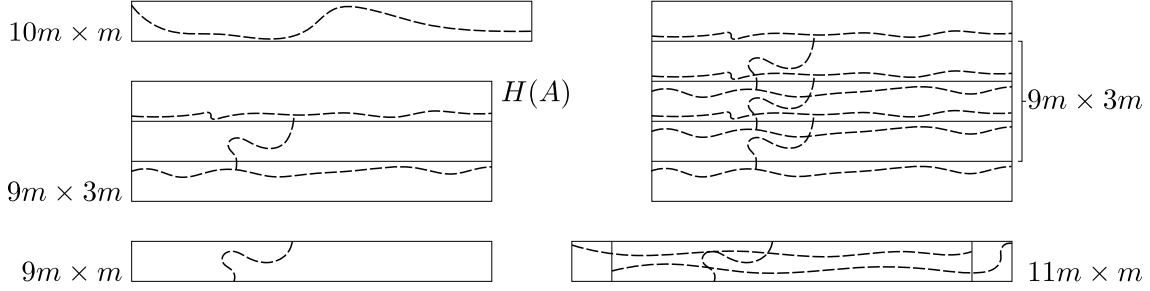

FIGURE 11. TOP LEFT: The horizontal crossing has probability at least α by assumption. MIDDLE LEFT: We claim that $\mu(H(A)) \geq \alpha^2 c_{\text{meso}}^2 / 2$. BOTTOM LEFT: The event $H(A)$ guarantees a vertical crossing of the middle rectangle by \mathcal{B} . TOP RIGHT: Intersections of events of the form $H(A)$ guarantee vertical crossings of taller rectangles by \mathcal{B} . BOTTOM RIGHT: Horizontal crossings of wider rectangles are created by combining events of the form $H(A)$ with vertical crossings of rectangles with dimensions $9m \times m$.

$\text{Hor}^*\{A^+\}$. Informally this means that \mathcal{B} contains at least a percolation cluster which has the shape of a rotated H, see Figure 11, MIDDLE LEFT. Claim that for any such rectangle A , we have

$$\mu(H(A)) \geq \alpha^2 c_{\text{meso}}^2 / 2. \quad (24)$$

The claim implies the lemma because vertical crossings of rectangles in $\text{Rect}[9m \times 18m, U']$ by \mathcal{B} are guaranteed by intersecting 18 events of the form $H(A)$ (see Figure 11, TOP RIGHT), while horizontal crossings of rectangles in $\text{Rect}[18m \times 9m, U']$ are guaranteed by 8 events of the form $H(A)$ and 9 horizontal crossings of rectangles in $\text{Rect}[10m \times m, U]$ which each occur with a probability of at least α (see Figure 11, BOTTOM RIGHT). We derive (24) in the remainder of the proof.

Introduce the following events:

$$X := \{\mathcal{B} \in \text{Hor}^*\{A^-\} \cap \text{Hor}^*\{A^+\}\};$$

$$Y := \{\mathcal{L}_{\leq 0} \in \text{Hor}^*\{A\}\};$$

$$Z := \{\mathcal{L}_{\leq 1}^\circ \notin \text{Hor}\{L\} \cup \text{Hor}\{R\}\},$$

where $L, R \in \text{Rect}[3m \times 3m, U]$ are the left- and rightmost squares contained in A respectively. Observe that all three events are increasing, and that

$$\mu(X) \geq \alpha^2; \quad \mu(Z) \geq c_{\text{meso}}^2$$

by the starting assumption and by Lemma 6.10 (for crossing mesoscopic squares) respectively. We shall not attempt to estimate the probability of Y , but rather prove that

$$X \setminus Y \subset H(A); \quad \mu(H(A) | X \cap Y \cap Z) \geq 1/2, \quad (25)$$

which readily implies (24).

Assume that the event X occurs. Let \mathcal{B}^+ and \mathcal{B}^- denote the highest and lowest self-avoiding \mathcal{B} -open paths in $\text{Hor}^*\{A\}$ respectively, which satisfy $\mathcal{B}^+ \in \text{Hor}^*\{A^+\}$ and $\mathcal{B}^- \in \text{Hor}^*\{A^-\}$.

We first prove the inclusion on the left in (25). If Y does not occur then $\mathcal{L}_{\leq 0}^\circ \in \text{Ver}\{A\}$. Write E for the edges of one such $\mathcal{L}_{\leq 0}^\circ$ -crossing. By definition of \mathcal{K}_0 and \mathcal{K}_0^* the set E is entirely contained in either \mathcal{K}_0 or \mathcal{K}_0^* . But since E crosses the path \mathcal{B}^+ , it is impossible that $E \subset \mathcal{K}_0$. Thus, we have $E \subset \mathcal{K}_0^*$, that is, $\mathcal{K}_0^* \in \text{Ver}\{A\}$. But then we also have $\mathcal{B} \in \text{Ver}^*\{A\}$; see Proposition 2.18 or Figure 5. This implies the occurrence of $H(A)$.

We now prove the right inequality in (25); Figure 12 illustrates this proof. Suppose that the event $X \cap Y \cap Z$ occurs. Let \mathcal{L}^+ and \mathcal{L}^- denote the highest and lowest horizontal

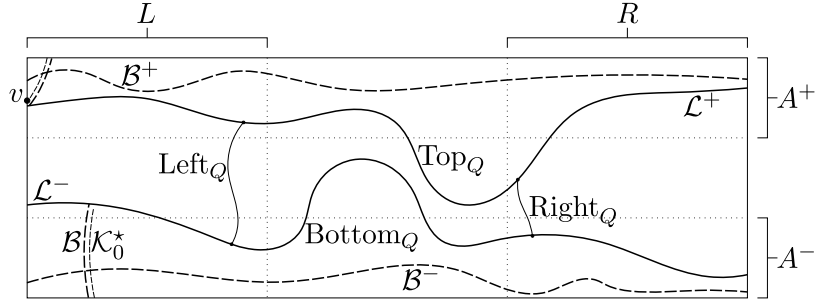

FIGURE 12. The paths \mathcal{L}^\pm trace (part of) the boundary of V^\pm . The quad Q is defined such that $\text{Top}_Q \subset \mathcal{L}^+$ and $\text{Bottom}_Q \subset \mathcal{L}^-$, and such that Left_Q and Right_Q , which are both contained in $\mathcal{L}_{\leq 1}$, run along the boundary of V_L and V_R respectively. The event Z guarantees that Left_Q and Right_Q remain strictly on the left and right respectively of the middle square, and also makes the technical condition work. The event $H(A)$ occurs with a conditional probability at least $1/2$ due to our crossing estimate for wide quads.

$\mathcal{L}_{\leq 0}$ -crossing of A , which exist due to occurrence of Y . Since $\mathcal{L}_{\leq 0} \subset \mathcal{B}$, these crossings are also \mathcal{B} -crossings.

Assertion. The crossing \mathcal{L}^\pm is \mathcal{B} -connected to \mathcal{B}^\pm within $\mathbb{E}_\circ^*(A)$.

Proof of the assertion. Focus on \mathcal{L}^+ and \mathcal{B}^+ , and assume, in order to derive a contradiction, that those two crossings are not \mathcal{B} -connected. Let $v \in \text{Left}_A \cap \mathbb{Z}^2$ denote the vertex immediately above the first edge of the path \mathcal{L}^+ (oriented left to right). By definition of \mathcal{L}^+ , there exists an $\mathcal{L}_{\leq 0}^\circ$ -open path $E \subset \mathbb{E}$ which connects v to Top_A , and which does not leave A . Observe that E must necessarily cross \mathcal{B}^+ . By reasoning as before we have $E \subset \mathcal{K}_0^*$. With Proposition 2.18 (see also Figure 5) it is then easy to construct a \mathcal{B} -open path connecting \mathcal{L}^+ and \mathcal{B}^+ (see Figure 12). This proves the assertion.

For the right inequality in (25) it now suffices to prove that

$$\mu(\mathcal{L}^+ \xrightarrow{\mathcal{B} \text{ in } \mathbb{E}_\circ^*(A)} \mathcal{L}^- | X \cap Y \cap Z) \geq 1/2.$$

The remainder of the proof runs as follows: we use the conditioning event to explore a wide quad Q such that its top and bottom belong to $\mathcal{L}_{\leq 0}$ and its left and right to $\mathcal{L}_{\leq 1}$; see Figure 12. We then apply the crossing estimate for wide quads in order to connect \mathcal{L}^\pm by a path in $\mathcal{L}_{\leq 0} \subset \mathcal{B}$ with probability at least $1/2$. We now write down the formalism, which is slightly technical and contains no surprises.

Introduce the random sets

$$V^+ := \{x \in A : x \xrightarrow{\mathcal{L}_{\leq 0}^\circ \text{ in } A} \text{Top}_A\}; \quad V^- := \{x \in A : x \xrightarrow{\mathcal{L}_{\leq 0}^\circ \text{ in } A} \text{Bottom}_A\},$$

and note that \mathcal{L}^\pm is contained in the boundary of V^\pm . Let $A' := A \setminus (V^+ \cup V^-)$ and

$$V_L := \{x \in A' : x \xrightarrow{\mathcal{L}_{\leq 1}^\circ \text{ in } A'} \text{Left}_A\}; \quad V_R := \{x \in A' : x \xrightarrow{\mathcal{L}_{\leq 1}^\circ \text{ in } A'} \text{Right}_A\}.$$

Observe that $V_L \subset L$ and $V_R \subset R$ since we conditioned on Z .

The sets V^+ and V^- are explored by first revealing the heights at Top_A and Bottom_A , then running a target height exploration process with target height $a = 0$ within A , started from all vertices with a height strictly above a . This exploration thus ends in $\mathcal{L}_{\leq 0}$ -level lines on the exploration boundary. Similarly, the sets V_L and V_R are explored by running a similar process started from Left_A and Right_A with the target height $a = 1$ which therefore ends in $\mathcal{L}_{\leq 1}$ -level lines. Write i for the information revealed by the process and (Λ', τ', ξ') for the

induced boundary conditions (see Lemma 2.9), noting that $\Lambda' = \Lambda \setminus (V^- \cup V^+ \cup V_L \cup V_R)$. Write $d\mu(i)$ for the law of i , and μ^i for μ conditional on the exploration.

It suffices to derive that μ -almost everywhere on $X \cap Y \cap Z$, the μ^i -probability that \mathcal{L}^+ and \mathcal{L}^- are connected, is at least $1/2$. Observe that \mathcal{L}^+ and \mathcal{L}^- are i -measurable since i explores V^+ and V^- , and those paths trace exactly the boundary of those sets. We distinguish two cases.

1. If \mathcal{L}^+ and \mathcal{L}^- share a vertex then they connect (deterministically) and there is nothing to prove.
2. Otherwise there is a unique quad $Q = (p, F, \Lambda'')$ such that Top_Q , Bottom_Q , Left_Q , and Right_Q belong to \mathcal{L}^+ , \mathcal{L}^- , $(\partial_e V_L)^*$, and $(\partial_e V_R)^*$ respectively; see Figure 12. Moreover, this quad is wide (up to translation), and Λ'' is a connected component of Λ' . By the Markov property and our crossing estimate for wide quads (Lemma 6.3), we have

$$\bar{\mu}_{\Lambda', \tau', \xi'}(\mathbb{F}(\text{Top}_Q) \xleftrightarrow{\bar{\mathcal{L}}_{\leq 0}} \mathbb{F}(\text{Bottom}_Q)) \geq 1/2.$$

By Remark 2.19 this also means that

$$\mu^i(\mathbb{F}(\text{Top}_Q) \xleftrightarrow{\mathcal{L}_{\leq 0}} \mathbb{F}(\text{Bottom}_Q)) \geq 1/2,$$

which is the desired estimate. \square

Corollary 7.9 (Uniform bound on ρ). *There exists a constant $\alpha_{\text{aspect}} > 0$ such that*

$$\text{Perc}[9m, \alpha_{\text{aspect}}, U_{\text{mid}}]$$

whenever $\rho(m) \notin [1/12, 12]$ for some $1 \leq m \leq N/90$.

Proof. Note that $199 = 11 \cdot 9 \cdot 2 + 1$. By choosing $\alpha_{\text{aspect}} \leq \alpha_0 := 2^{-199}$, we trivially have $\text{Perc}[9m, \alpha_{\text{aspect}}, U_{\text{mid}}]$ for all $m \leq 11$. Restrict now to $m \geq 12$ and recall that $\rho(m)m \geq 24$ by definition of $\rho(m)$. Focus first on the case that $\rho(m) < 1/12$. By Proposition 7.5, Statement 2, we have

$$\forall R \in \text{Rect}[\rho(m)m \times m, U_{\text{out}}], \quad \mu(\mathcal{B} \in \text{Ver}^*\{R\}) \geq 1 - \delta_{\text{aspect}}.$$

If we set $n := \lfloor m/10 \rfloor \geq \rho(m)m$, then $\frac{m}{2} \leq 10n \leq m$, and

$$\forall R \in \text{Rect}[n \times 10n, U_{\text{out}}], \quad \mu(\mathcal{B} \in \text{Ver}^*\{R\}) \geq 1 - \delta_{\text{aspect}}.$$

The previous lemma implies $\text{Perc}[9n, \alpha_1, U_{\text{mid}}]$ for $\alpha_1 := ((1 - \delta_{\text{aspect}})^2 c_{\text{meso}}^2 / 2)^{18}$. Since $n \leq m \leq 20n$, Proposition 7.7 asserts that $\text{Perc}[9m, \alpha_2, U_{\text{mid}}]$ for $\alpha_2 := \alpha_1^{100}$. Now we focus on $\rho(m) \geq 12$. Proposition 7.5, Statement 1 asserts

$$\forall R \in \text{Rect}[(\rho(m)m - 24) \times m, U_{\text{out}}], \quad \mu(\mathcal{B} \in \text{Hor}^*\{R\}) \geq \delta_{\text{aspect}}.$$

Since $\rho(m)m \geq 12$, we observe that $\rho(m)m - 24 \geq 10m$. Therefore we also have

$$\forall R \in \text{Rect}[10m \times m, U_{\text{out}}], \quad \mu(\mathcal{B} \in \text{Hor}^*\{R\}) \geq \delta_{\text{aspect}}.$$

The previous lemma thus implies $\text{Perc}[9m, \alpha_3, U_{\text{mid}}]$ for $\alpha_3 := (\delta_{\text{aspect}}^2 c_{\text{meso}}^2 / 2)^{18}$. Combining all estimates, we observe that the choice $\alpha_{\text{aspect}} := \alpha_0 \wedge \alpha_2 \wedge \alpha_3 > 0$ suffices. \square

We also mention another corollary of the lemma. At the start of the proof of Lemma 7.8, we combined horizontal and vertical crossings of rectangles of different dimensions to create crossings of wider rectangles; see Figure 11, BOTTOM RIGHT. Together with Lemma 7.8, this strategy yields the following corollary.

Lemma 7.13 (Normality assumptions). *There exists a constant $\alpha_{\text{normal}} > 0$ with the following properties. If $m \in 10\mathbb{Z}_{\geq 1}$ with $m \leq N/180$, then at least one of the following two holds true:*

1. $\text{Perc}[9m, \alpha_{\text{normal}}, U_{\text{mid}}]$,
2. All of the following hold true:
 - a. $m \geq M \vee (12 \cdot 1600)$,
 - b. $\rho(\tilde{m}) \in [1/12, 12]$ for all $\frac{m'}{M} \leq \tilde{m} \leq m$,
 - c. $\mu(\mathcal{K}_0 \in \text{DoubleArm}[R_{m'}, \tilde{m}]) \geq \frac{1}{2}$ for all $\tilde{m} \in 10\mathbb{Z}_{\geq 1}$ with $\frac{m}{M} \leq \tilde{m} \leq \frac{m}{260}$.

A scale m is called normal if it satisfies all requirements for the second case.

Proof that Lemma 7.13 implies Lemma 7.3. Assume Lemma 7.13. Let $(m_k)_{0 \leq k \leq \ell}$ denote a finite decreasing sequence of scales, defined as follows.

1. The first scale m_0 is the largest multiple of ten not exceeding $N/180$.
2. If $\text{Perc}[9m_k, \alpha_{\text{normal}}, U_{\text{mid}}]$ is false, then $m_{k+1} \in 10\mathbb{Z}_{\geq 1}$ is maximal subject to

$$\frac{m_k}{M} \leq m_{k+1} \leq \frac{m_k}{260}; \quad \rho(m'_{k+1}) \leq \frac{6}{5}\rho(m_{k+1}).$$

The existence of such a number is guaranteed by the two previous lemmas.

3. If $\text{Perc}[9m_k, \alpha_{\text{normal}}, U_{\text{mid}}]$ holds true, then we set $\ell := k$ and terminate the sequence. If $\ell \leq 4$ then $\lfloor N/20 \rfloor / 9m_\ell \leq 2M^4$, and therefore Proposition 7.7 asserts that

$$\text{Perc}[\lfloor N/20 \rfloor, \alpha'_{\text{macro}}, U_{\text{mid}}]; \quad \alpha'_{\text{macro}} = \alpha_{\text{normal}}^{10M^4}.$$

Therefore we restrict our attention to the case that $\ell \geq 5$. Define a new universe U'_{mid} by

$$U'_{\text{mid}} := [-10N, 10N] \times [-\frac{7}{16}N, -\frac{1}{16}N];$$

this universe equals U_{mid} except that it extends a bit more to the left and right. We first prove the following claim, which asserts that quasicrossings occur at all scales and that bridges occur at the smallest scale.

Claim. For any $1 \leq k < \ell - 1$, we have

$$\begin{aligned} \mu(\mathcal{B} \in \text{Quasi}^*[x, y, m_k, m_{k+1}]) &\geq c_1 & \forall \text{Box}_{3\beta}(x, y, m_k) &\subset U'_{\text{mid}}; \\ \mu(\mathcal{B} \in \text{Bridge}^*[x, y, m_{\ell-1}]) &\geq c_1 & \forall \text{Box}_{\beta}(x, y, m_{\ell-1}) &\subset U_{\text{mid}}, \end{aligned}$$

where $c_1 := \alpha_{\text{normal}}^{115M} \wedge \delta_{\text{aspect}}^2 / 4$ is a strictly positive constant.

Proof. We first prove that the bridge event satisfies the indicated lower bound, which is easier. By reasoning as before, we observe that

$$\text{Perc}[m_{\ell-1}, \alpha, U_{\text{mid}}]; \quad \alpha := \alpha_{\text{normal}}^{5M}.$$

Observe that $\{\mathcal{B} \in \text{Bridge}^*[x, y, m_{\ell-1}]\} \supset \{\mathcal{B} \in \text{Hor}^*\{\text{Box}_{\beta}(x, y, m_{\ell-1})\}\}$, and that the width of the rectangle $\text{Box}_{\beta}(x, y, m_{\ell-1})$ equals $(1 + \beta)\rho(m_{\ell-1})m_{\ell-1} \leq 13m_{\ell-1}$. Since the horizontal crossing event can be written as the intersection of at most 23 crossing events of rectangles with side lengths $m_{\ell-1} \times 2m_{\ell-1}$ or $2m_{\ell-1} \times m_{\ell-1}$, the bound in the claim follows.

Focus now on the quasicrossing event. We show that this event contains the intersection of four connection events whose probability we know how to lower bound; see Figure 14. Let

$$L, R \in \text{Rect}[(\rho(m_k)m_k - 24) \times m_k, U_{\text{out}}]$$

denote the left- and rightmost rectangles contained in $\text{Box}_{3\beta}(x, y, m_k)$ respectively. Write C for the smaller scale *centre box* $\text{Box}_{\beta}(x, y, m_{k+1})$, and let

$$T, B \in \text{Rect}[\rho(m'_k)m'_k \times m'_k, U_{\text{out}}]$$

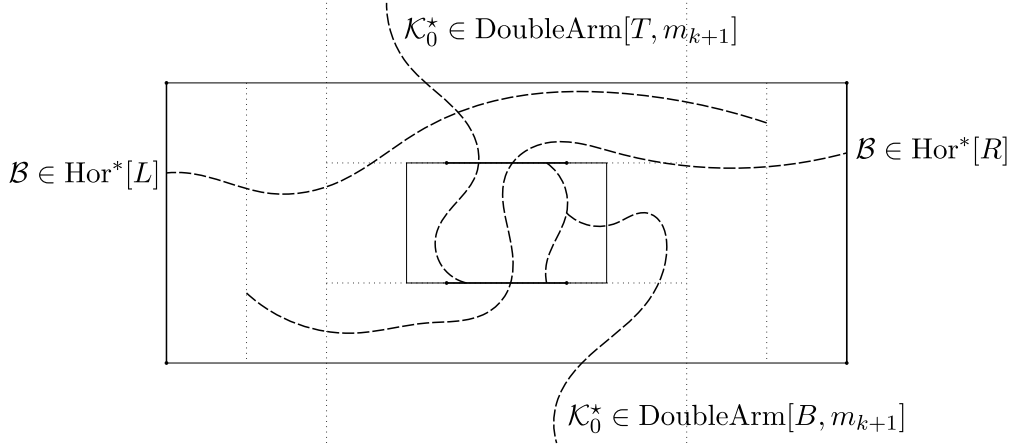

FIGURE 14. The event $\mathcal{B} \in \text{Quasi}^*[x, y, m_k, m_{k+1}]$ contains the intersection of four other events due to the *corridor construction* [KT23, Lemma 2]. If a primal edge is open for \mathcal{K}_0^* , then its dual edge and the six surrounding dual edges are open for \mathcal{B} ; see Proposition 2.18.

denote the unique rectangles such that the *lower* box $\text{Box}_\beta(x, y_b, m_{k+1})$ and the *upper* box $\text{Box}_\beta(x, y_t, m_{k+1})$ respectively in the definition of $\text{DoubleArm}[\cdot, m_{k+1}]$ coincide exactly with the centre box C . Assert that

$$\begin{aligned} & \{\mathcal{B} \in \text{Quasi}^*[x, y, m_k, m_{k+1}]\} \\ & \supset \{\mathcal{B} \in \text{Hor}^*\{L\} \cap \text{Hor}^*\{R\}\} \cap \{\mathcal{K}_0^* \in \text{DoubleArm}[T, m_{k+1}] \cap \text{DoubleArm}[B, m_{k+1}]\}. \end{aligned}$$

The assertion implies the claim because Proposition 7.5, Statement 1 implies that the events $\{\mathcal{B} \in \text{Hor}\{L\}\}$ and $\{\mathcal{B} \in \text{Hor}\{R\}\}$ occur with probability at least δ_{aspect} , while normality of the scale m_k and the generic symmetrisation lemma imply that the other two events have probability at least $\frac{1}{2}$, so that the FKG inequality yields the result.

The assertion is essentially proved by Figure 14, but we must prove that this figure is truthful for the *corridor construction* [KT23, Lemma 2] to work. In particular, we must demonstrate that:

1. Both L and R really reach over $T \cup R$ on the left and right,
2. The union $T \cup R$ really reaches over the box $\text{Box}_{3\beta}(x, y, m_k)$ on the top and bottom.

If both requirements are satisfied, then it is easy to see that each horizontal crossing either must intersect at least one of the two double arms, or must itself contain an arm event of the centre box. In either case, the left and right of $\text{Box}_{3\beta}(x, y, m_k)$ connect to an arm event of the centre box, which guarantees the quasicrossing. Observe that

- The rectangle $L \cap R$ has dimensions $(\frac{3}{4}\rho(m_k)m_k - 48) \times m_k$,
- The rectangle $T \cup B$ has dimensions $\rho(m'_k)m'_k \times (2m'_k - m_{k+1})$,

both centred at the vertex (x, y) . For the first requirement, observe that the rectangle $L \cap R$ is wider than $T \cup B$, because

$$\frac{3}{4}\rho(m_k)m_k - 48 \geq \frac{72}{100}\rho(m_k)m_k = \frac{6}{5}\rho(m_k)\frac{6}{10}m_k \geq \rho(m'_k)m'_k,$$

using the normality assumptions for the inequalities $\rho(m_k) \geq \frac{1}{12}$ and $m_k \geq 12 \cdot 1600$, as well as the fact that m_k is a good scale. For the second requirement, observe that $T \cup B$ is taller than $\text{Box}_{3\beta}(x, y, m_k)$, since

$$2m'_k - m_{k+1} \geq \left(\frac{12}{10} - \frac{1}{260}\right)m_k \geq m_k.$$

This proves the claim.

We now apply the inductive argument of [KT23].

Claim. For any $X = \text{Box}_{3\beta}(x, y, m_1) \subset U_{\text{mid}}$, we have $\mu(\mathcal{B} \in \text{Hor}^*\{X\}) \geq \delta_{\text{box}} := c_1^6/8$.

Proof. Fix $x, y \in \mathbb{Z}$ such that $\text{Box}_{3\beta}(x, y, m_1) \subset U_{\text{mid}}$. Define

$$\begin{aligned} q(i, j) &:= \mu(\mathcal{B} \in \text{Quasi}^*[x, y, m_i, m_j]); & 1 \leq i < j \leq \ell - 1, \\ b(i) &:= \mu(\mathcal{B} \in \text{Bridge}^*[x, y, m_i]); & 2 \leq i \leq \ell - 1. \end{aligned}$$

Observe that for any $1 \leq i < j \leq \ell - 1$ with $j \geq i + 2$,

$$\max \left\{ q(i, j), \frac{b(i)}{q(i+1, j) \cdot c_1^2} \right\} \geq c_2 := c_1/2,$$

by the exact same reasoning as in the proof of Theorem 3 in [KT23]. Note that in order to obtain this estimate, we also use horizontal shifts of quasicrossing events (not just those centred at (x, y)), which is why we established our previous claim for quasicrossing bounds in the slightly wider universe U'_{mid} . By reasoning exactly as in the proof of Theorem 3 in [KT23], we obtain $q(1, 2)b(2) \geq c_1^6/8$, which proves the claim due to the FKG inequality.

By Corollary 7.10, together with the previous claim, Proposition 7.5, Statement 2, and the inequality $\rho(m_1) \geq \frac{1}{12}$, we have

$$\text{Perc}[9m_1, \alpha, U_{\text{in}}]; \quad \alpha := ((\delta_{\text{box}}(1 - \delta_{\text{aspect}}))^{960} c_{\text{meso}}^2/2)^{18}.$$

Since $\lfloor N/20 \rfloor / 9m_1 \leq 2M$, this implies

$$\text{Perc}[\lfloor N/20 \rfloor, \alpha''_{\text{macro}}, U_{\text{in}}]; \quad \alpha''_{\text{macro}} := \alpha^{10M}.$$

This concludes the proof of Lemma 7.3 (and thus the proof of the pushing lemma) with $\alpha_{\text{macro}} := \alpha'_{\text{macro}} \wedge \alpha''_{\text{macro}}$, conditional on the normality assumptions (Lemma 7.13). \square

7.5. Proof of the normality assumptions. By rearranging the logic, it is easy to see that the following lemma implies Lemma 7.13 with $\alpha_{\text{normal}} := \alpha_1 \wedge \alpha_2 \wedge \alpha_3$.

Lemma 7.14. *Let $m \in 10\mathbb{Z}_{\geq 1}$ with $m \leq N/180$.*

1. *If $m \leq M \cdot 24 \cdot 1600$, then*

$$\text{Perc}[9m, \alpha_1, U_{\text{mid}}]; \quad \alpha_1 := 2^{-(18 \cdot M \cdot 24 \cdot 1600 + 1)}.$$

2. *If $\rho(\tilde{m}) \notin [1/12, 12]$ for some $\frac{m'}{M} \leq \tilde{m} \leq m$ then*

$$\text{Perc}[9m, \alpha_2, U_{\text{mid}}]; \quad \alpha_2 := \alpha_{\text{aspect}}^{\frac{50}{6}M}.$$

3. *There is a constant $\alpha_3 > 0$ with the following property. Suppose that $m \in 10\mathbb{Z}_{\geq 1}$ satisfies $m \geq M \cdot 24 \cdot 1600$ and $\rho(\tilde{m}) \in [1/12, 12]$ for all $\frac{m'}{M} \leq \tilde{m} \leq m$. Then for any $\tilde{m} \in 10\mathbb{Z}_{\geq 1}$ with $\frac{m}{M} \leq \tilde{m} \leq \frac{m}{260}$, at least one of the following two holds true:*

- a. $\text{Perc}[9m, \alpha_3, U_{\text{mid}}]$,
- b. $\mu(\mathcal{K}_0 \in \text{DoubleArm}[R_{m'}, \tilde{m}]) \geq \frac{1}{2}$.

Proof. The first two statements follow readily from Proposition 6.9 and a combination of Corollary 7.9 with Proposition 7.7 respectively. We focus this proof on the third statement. Fix the scales m and \tilde{m} as in the statement. We start from the observation that the rectangle $R_{m'} \in \text{Rect}[\rho(m')m' \times m', U_{\text{out}}]$ is defined such that

$$\mu(\mathcal{K}_0 \in \text{Ver}\{R_{m'}\}) \geq 1 - \delta_{\text{aspect}}.$$

Write

$$R_{m'} = [x - w, x + w] \times [y^-, y^+]$$

for some $x, w, y^-, y^+ \in \mathbb{Z}$. Without loss of generality, we suppose that $x = 0$.

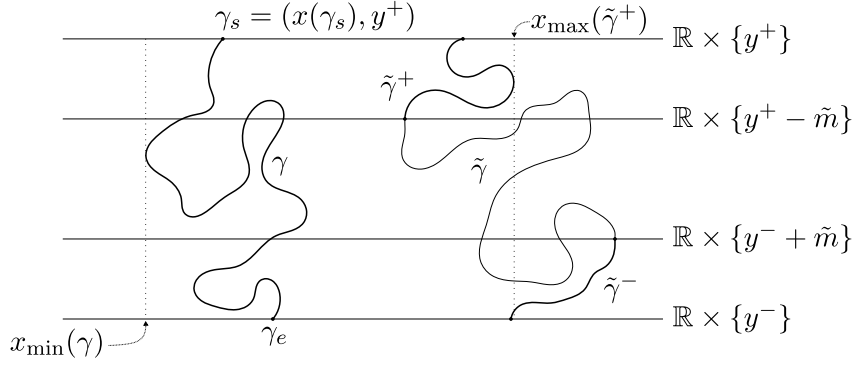
 FIGURE 15. Two paths $\gamma, \tilde{\gamma} \in \Gamma$.

Recall the square root trick from Section 4: if \mathbb{P} is any percolation measure satisfying the FKG inequality and if A_1, \dots, A_n are increasing events with $\cup_k A_k =: A$, then

$$\max\{\mathbb{P}(A_1), \dots, \mathbb{P}(A_n)\} \geq f_n(\mathbb{P}(A)); \quad f_n(x) := 1 - \sqrt[n]{1-x}.$$

Note that $f_a \circ f_b = f_{ab}$ and that $f_{8.8.9}(1 - \delta_{\text{aspect}}) > \frac{1}{2}$ because $\delta_{\text{aspect}} := 2^{-600}$.

We first introduce some notation which will make it easier to describe the events considered in this proof; the following definition is illustrated by Figure 15.

Definition. Let Γ denote the set of paths through $(\mathbb{Z}^2, \mathbb{E})$ which start in $\mathbb{R} \times \{y^+\}$ and end in $\mathbb{R} \times \{y^-\}$, and which remain in $\mathbb{R} \times [y^-, y^+]$. For any path $\gamma = (\gamma_k)_{0 \leq k \leq n}$ through $(\mathbb{Z}^2, \mathbb{E})$, we also introduce the following notations:

1. $\gamma_s := \gamma_0$ and $\gamma_e := \gamma_n$ denote its first and last vertex respectively,
2. $\gamma^+ := (\gamma_k)_{0 \leq k \leq n'}$ where n' is minimal subject to $\gamma_{n'} \in \mathbb{R} \times \{y^+ - \tilde{m}\}$,
3. $\gamma^- := (\gamma_{n'+k})_{0 \leq k \leq n-n'}$ where n' is maximal subject to $\gamma_{n'} \in \mathbb{R} \times \{y^- + \tilde{m}\}$,
4. $x((i, j)) := i$ is the x -coordinate of (i, j) for any $(i, j) \in \mathbb{Z}^2$,
5. $x_{\min}(\gamma)$ and $x_{\max}(\gamma)$ denote the min and max of $x(\gamma_k)$ over all k respectively.

Note that γ^- and γ^+ are well-defined for all paths $\gamma \in \Gamma$. If A_1, \dots, A_n are statements which assign a truth value to each path in $\gamma \in \Gamma$, then we use the shorthand notation

$$\Gamma[A_1, \dots, A_n] := \{\gamma \in \Gamma : A_1(\gamma), \dots, A_n(\gamma)\}.$$

Finally, we identify any $\Gamma' \subset \Gamma$ with the increasing percolation event in $\mathcal{P}(\mathcal{P}(\mathbb{E}))$ of all percolations $\omega \subset \mathbb{E}$ such that Γ' contains an ω -open path. (However, when we intersect subsets of Γ , then they are intersected as sets of paths, not as percolation events. These two perspectives have a different meaning.)

For example, the event $\{\mathcal{K}_0 \in \text{Ver}\{R_{m'}\}\}$ may now be written

$$\{\mathcal{K}_0 \in \Gamma[|x_{\min}(\gamma)|, |x_{\max}(\gamma)| \leq w]\}.$$

We first prove the following claim, which is illustrated by Figure 16.

Claim. Suppose that η represents the path γ, γ^+ , or γ^- . For any $k \in \mathbb{Z}, a \in \mathbb{Z}_{\geq 0}$, define

1. $\Gamma_c(\eta, k, +) := \Gamma[x(\eta_s) \leq k, x(\eta_e) \geq k]$,
2. $\Gamma_c(\eta, k, -) := \Gamma[x(\eta_s) \geq k, x(\eta_e) \leq k]$,
3. $\Gamma_d(\eta, k, a, +) := \Gamma[x(\eta_s), x(\eta_e) \leq k, x_{\min}(\eta) \geq k - a, x_{\max}(\eta) \geq k + a]$,
4. $\Gamma_d(\eta, k, a, -) := \Gamma[x(\eta_s), x(\eta_e) \geq k, x_{\min}(\eta) \leq k - a, x_{\max}(\eta) \leq k + a]$.

We call the first two events *crossing events* and the latter two *deviation events*. Then for any $\Gamma' \in \{\Gamma_c(\eta, k, \pm), \Gamma_d(\eta, k, a, \pm)\}$, we have

$$\mu(\mathcal{K}_0 \in \Gamma') \leq \frac{1}{2}.$$

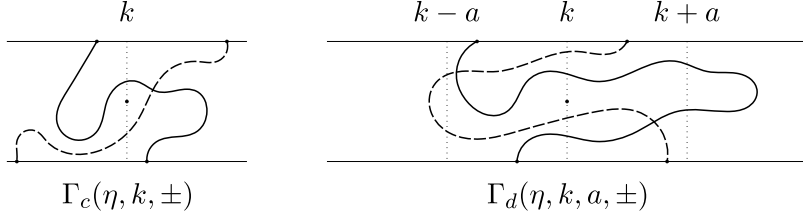

FIGURE 16. Crossing events and deviation events. The continuous and dashed lines represent a path in the $+$ and the $-$ set respectively on either side of the figure. The symmetry point is also marked. Observe that on either side any $+$ path must intersect any $-$ path.

Proof. We shall prove the claim for the case that η represents γ ; the other cases are the same. Let $\Sigma \in \Sigma^\circ$ denote the symmetry which rotates the plane around the vertex $(k, (y^- + y^+)/2)$. Recall that Σ is an involution and observe that

$$\Sigma\Gamma_c(\eta, k, \pm) = \Gamma_c(\eta, k, \mp); \quad \Sigma\Gamma_d(\eta, k, a, \pm) = \Gamma_d(\eta, k, a, \mp).$$

Focus first on crossing events. Generic symmetrisation implies

$$\mu(\mathcal{K}_0 \in \Gamma_c(\eta, k, \pm)) \leq \mu(\mathcal{K}_0^* \in \Gamma_c(\eta, k, \mp)).$$

Recall that paths in Γ have the crucial property that they are restricted to the strip $\mathbb{R} \times [y^-, y^+]$, starting in the top line $\mathbb{R} \times \{y^+\}$ and ending in the bottom line $\mathbb{R} \times \{y^-\}$. It is easy to see that any path $\Gamma_c(\eta, k, +)$ intersects any path in $\Gamma_c(\eta, k, -)$; see Figure 16, LEFT. In particular, the two events in the previous two displays are disjoint, and therefore

$$\mu(\mathcal{K}_0 \in \Gamma_c(\eta, k, \pm)) \leq \frac{1}{2}.$$

By reasoning in the exact same way for deviation events, we obtain

$$\mu(\mathcal{K}_0 \in \Gamma_d(\eta, k, a, \pm)) \leq \frac{1}{2}.$$

The proof for the case that η represents γ^+ or γ^- is the same, except that the restrictions of the paths live in different strips and that the symmetry Σ must be updated accordingly. This ends the proof of the claim.

In the remainder of the proof, we write $\varepsilon := \lceil m/1000M \rceil$. Recall that $R_{m'} = [-w, w] \times [y^-, y^+]$. We shall proceed in three steps, which are more or less the same: each time, we apply the square root trick to decompose our event into smaller events. Some of these events cannot have the probability given by the square root trick due to the claim. The other events either lead either to percolation at scale $9m$ (due to an application of Corollary 7.10 in combination with Proposition 7.5) or to the double arm event.

For the first step, observe that the event $\{\mathcal{K}_0 \in \text{Ver}\{R_{m'}\}\}$ is included in the union of the following nine events:

1. The event $\{\mathcal{K}_0 \in \Gamma[|x_{\min}(\gamma)|, |x_{\max}(\gamma)| \leq w, |x(\gamma_s)|, |x(\gamma_e)| \leq \varepsilon]\}$,
2. The event $\{\mathcal{K}_0 \in \Gamma[|x_{\min}(\gamma)|, |x_{\max}(\gamma)| \leq w, x_{\min}(\gamma) \geq -w + 2\varepsilon]\}$,
3. The event $\{\mathcal{K}_0 \in \Gamma[|x_{\min}(\gamma)|, |x_{\max}(\gamma)| \leq w, x_{\max}(\gamma) \leq w - 2\varepsilon]\}$,
4. The four crossing events $\{\mathcal{K}_0 \in \Gamma_c(\gamma, k, \pm)\}$ where $k \in \{-\varepsilon, \varepsilon\}$,
5. The deviation event $\{\mathcal{K}_0 \in \Gamma_d(\gamma, -\varepsilon, w - \varepsilon, +)\}$,
6. The deviation event $\{\mathcal{K}_0 \in \Gamma_d(\gamma, \varepsilon, w - \varepsilon, -)\}$.

Since $f_9(1 - \delta_{\text{aspect}}) > \frac{1}{2}$, the square root trick and the claim imply that one of the first three events must occur with probability at least $f_9(1 - \delta_{\text{aspect}})$. Assume first that the second event achieves this probability (similar arguments apply to the third event). Then

$$\mu(\mathcal{K}_0 \in \text{Ver}\{B\}) \geq \frac{1}{2}; \quad B := [-w + 2\varepsilon, w] \times [y^-, y^+].$$

The rectangle B has dimensions $(\rho(m')m' - 2\varepsilon) \times m'$. By generic symmetrisation, all rectangles in $\text{Rect}[(\rho(m')m' - 2\varepsilon) \times m', U_{\text{out}}]$ are crossed vertically by \mathcal{B} with probability at least one half. By Proposition 7.5, Statement 1, all rectangles in $\text{Rect}[(\rho(m')m' - 24) \times m', U_{\text{out}}]$ are crossed horizontally with probability at least δ_{aspect} . It is straightforward to work out that $2\varepsilon - 24 \geq \frac{m}{1000M}$. Corollary 7.10 therefore yields

$$\text{Perc}[9m, \alpha'_3, U_{\text{mid}}]; \quad \alpha'_3 := ((\delta_{\text{aspect}}/2)^{20000M} c_{\text{meso}}^2/2)^{18}. \quad (27)$$

The same holds true if the second event in the list has a probability of at least $1/2$. Thus, if (27) is false, then the first event must have a likelihood of at least $f_9(1 - \delta_{\text{aspect}})$. The next two steps cover this remaining case.

For the second step, write

$$\begin{aligned} \Gamma'[A_1, \dots, A_n] &:= \{\gamma \in \Gamma' : A_1(\gamma), \dots, A_n(\gamma)\}; \\ \Gamma' &:= \Gamma[|x_{\min}(\gamma)|, |x_{\max}(\gamma)| \leq w, |x(\gamma_s)|, |x(\gamma_e)| \leq \varepsilon]. \end{aligned}$$

Write $\tilde{w} := \rho(\tilde{m})\tilde{m}/2$. Note that the union of the following eight events contains $\{\mathcal{K}_0 \in \Gamma'\}$:

1. The event $\{\mathcal{K}_0 \in \Gamma'[|x_{\min}(\gamma^+)|, |x_{\max}(\gamma^+)| \leq \tilde{w} + 3\varepsilon, |x(\gamma_e^+)| \leq \varepsilon]\}$,
2. The event $\{\mathcal{K}_0 \in \Gamma'[|x_{\min}(\gamma^+)|, |x_{\max}(\gamma^+)| \geq \tilde{w} + \varepsilon]\}$,
3. The four crossing events $\{\mathcal{K}_0 \in \Gamma_c(\gamma^+, k, \pm)\}$ for $k \in \{-\varepsilon, \varepsilon\}$,
4. The deviation event $\{\mathcal{K}_0 \in \Gamma_d(\gamma^+, \varepsilon, \tilde{w} + 2\varepsilon, +)\}$,
5. The deviation event $\{\mathcal{K}_0 \in \Gamma_d(\gamma^+, -\varepsilon, \tilde{w} + 2\varepsilon, -)\}$.

Since $f_8 \circ f_9(1 - \delta_{\text{aspect}}) > \frac{1}{2}$, the square root trick and the claim tell us that one of the first two events must occur with probability at least $f_8 \circ f_9(1 - \delta_{\text{aspect}})$. Suppose that this probability is achieved by the second event. By applying the generic symmetrisation lemma as before, we observe that all rectangles in $\text{Rect}[(\rho(\tilde{m})\tilde{m} + 2\varepsilon) \times \tilde{m}, U_{\text{out}}]$ are crossed horizontally by \mathcal{B} with probability at least one half. But we already know that rectangles in $\text{Rect}[\rho(\tilde{m})\tilde{m} \times \tilde{m}, U_{\text{out}}]$ are crossed vertically with probability at least $1 - \delta_{\text{aspect}}$ by Proposition 7.5, Statement 2. Since $2\varepsilon \geq \frac{m}{500M}$, Corollary 7.10 therefore yields

$$\text{Perc}[9m, \alpha''_3, U_{\text{mid}}]; \quad \alpha''_3 := (((1 - \delta_{\text{aspect}})/2)^{10000M} c_{\text{meso}}^2/2)^{18}. \quad (28)$$

Thus, if this is false, then the first event must have a likelihood of at least $f_8 \circ f_9(1 - \delta_{\text{aspect}})$. The final step covers this remaining case.

Recall that $f_8 \circ f_8 \circ f_9(1 - \delta_{\text{aspect}}) > \frac{1}{2}$. By reasoning exactly as for the second step, we observe that either (28) must hold true, or that the event

$$\{\mathcal{K}_0 \in \Gamma''\}; \quad \Gamma'' := \Gamma'[|x_{\min}(\gamma^\pm)|, |x_{\max}(\gamma^\pm)| \leq \tilde{w} + 3\varepsilon, |x(\gamma_e^+)|, |x(\gamma_s^-)| \leq \varepsilon]$$

has a probability of at least $1/2$ of occurring.

All that remains is to prove the assertion that

$$\{\mathcal{K}_0 \in \Gamma''\} \subset \{\mathcal{K}_0 \in \text{DoubleArm}[R_{m'}, \tilde{m}]\},$$

which implies the third statement of the lemma with the constant $\alpha_3 := \alpha'_3 \wedge \alpha''_3$. A path in Γ'' has been drawn in Figure 17. By comparing this figure to Figure 13, we observe that (as percolation events) $\Gamma'' \subset \text{DoubleArm}[R_{m'}, \tilde{m}]$ as soon as 2ε does not exceed $\beta\rho(\tilde{m})\tilde{m}$, which is the width of the target in the double arm event, and as soon as $2\tilde{w} + 6\varepsilon$ does not exceed $(1 + \beta)\rho(\tilde{m})\tilde{m}$, which is the width of $\text{Box}_\beta(x, y_t, \tilde{m})$ and $\text{Box}_\beta(x, y_b, \tilde{m})$. Since $\tilde{w} = \rho(\tilde{m})\tilde{m}$, it thus suffices to demonstrate that

$$6\varepsilon \leq \beta\rho(\tilde{m})\tilde{m}.$$

But $\beta = \frac{1}{12}$, $\rho(\tilde{m}) \geq \frac{1}{12}$, and $\tilde{m} \geq m/M$, and therefore it suffices to demonstrate that

$$6\varepsilon \leq \frac{1}{144} \frac{m}{M}$$

This is immediate from the definition of ε (taking into account that $m \geq M \cdot 24 \cdot 1600$). \square

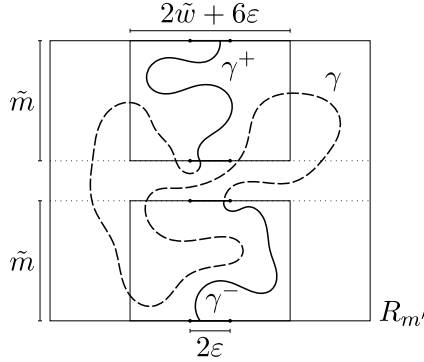

FIGURE 17. A path $\gamma \in \Gamma''$. The sub-paths γ^\pm have been drawn as a continuous line. The definition of Γ'' implies that the paths γ^\pm remain in their respective rectangles and that they enter and exit the rectangles through the marked targets.

8. THE SECOND COARSE-GRAINING INEQUALITY

This section formally introduces the *annulus observable* and proves the second coarse-graining inequality (Lemma 1). The observable is called the annulus observable because it measures the probability of finding a percolation circuit of \mathcal{L}_1 in an annulus with zero boundary conditions. This observable first appeared in the work of Duminil-Copin, Sidoravicius, and Tassion [DST17] in the context of the random-cluster model. Morally our proof of Lemma 1 follows that work, except that we fit k small annuli in the large annulus where in [DST17] one only fits 2 small annuli in the large annulus. This change allows us to extract the exponential decay (rather than stretched-exponential decay) directly from the inequality. The improvement can be made thanks to the ideas in the proof of Lemma 5.2.

Definition 8.1 (Circuit events). Let $n \in \mathbb{Z}_{\geq 1}$ and consider two random percolations $\mathcal{X} \subset \mathbb{E}$ and $\mathcal{Y} \subset \mathbb{E}^*$. Let $\mathcal{C}(\mathcal{X}, n)$ denote the event that $\mathbb{R}^2 \setminus \llbracket n \rrbracket^2$ contains a non-contractible \mathcal{X} -circuit. Let $\mathcal{C}^*(\mathcal{Y}, n)$ denote the event that $\mathbb{R}^2 \setminus \llbracket n \rrbracket^2$ contains a non-contractible \mathcal{Y} -circuit whose face centres all lie in $\mathbb{R}^2 \setminus \llbracket n \rrbracket^2$. Such events are called *circuit events*.

Definition 8.2 (Annulus events). Assume the setting of the previous definition. Let $\mathcal{A}(\mathcal{X}, n)$ denote the event that $\llbracket 2n \rrbracket^2 \setminus \llbracket n \rrbracket^2$ contains a non-contractible \mathcal{X} -circuit. Similarly, we let $\mathcal{A}^*(\mathcal{Y}, n)$ denote the event that the same annulus contains a non-contractible \mathcal{Y} -circuit whose face centres all lie in $\llbracket 2n \rrbracket^2 \setminus \llbracket n \rrbracket^2$. Define $\mathcal{A}^*(\cdot, n) + (m, 0)$ similarly except that the annulus $\llbracket 2n \rrbracket^2 \setminus \llbracket n \rrbracket^2$ is shifted by the vector $(m, 0)$. Finally, use the shorthand notation

$$\mathcal{A}_{k,m}^*(\mathcal{Y}, n) := \cap_{\ell=0}^{k-1} (\mathcal{A}^*(\mathcal{Y}, n) + (20\ell m, 0)).$$

Recall that $\text{Geom}_{n,m} := \{(\Lambda, \tau) \in \text{Geom} : (\Lambda_n, 0) \preceq (\Lambda, \tau) \preceq (\Lambda_m, 0)\}$.

Definition 8.3 (The annulus observable). The observable of interest is defined by

$$p_n := p_n(V) := \sup_{(\Lambda, \tau) \in \text{Geom}_{4n, 8n}} \mu_{\Lambda, \tau, 0}(\mathcal{A}^*(\mathcal{L}_1, n)),$$

where the reference to the underlying potential function V is sometimes explicit.

See Figure 18 for an illustration of the observable. An interesting feature of the observable lies in the fact that the percolation \mathcal{L}_1 is not increasing: it is increasing in neither h nor $|h|$. It is exactly for this reason that the observable is defined as a supremum over boundary conditions. Let us now re-state Lemma 1 before providing the proof.

Lemma (Second coarse-graining inequality). *There is a universal constant $c_{\text{dichot}} > 0$ with the following property. For any potential $V \in \Phi$, the observables $(p_n(V))_n \subset [0, 1]$ which*

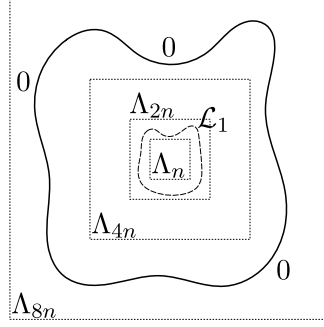

FIGURE 18. The observable p_n measures the probability of seeing an \mathcal{L}_1 -circuit through the smaller annulus, given zero boundary conditions on a circuit through the larger annulus. The observable is defined as the supremum of this probability over all such boundary circuits; this is necessary for technical reasons.

are defined at each scale $n \in \mathbb{Z}_{\geq 1}$ satisfy, for each $n \in \mathbb{Z}_{\geq 1000}$, the equation

$$p_{20kn}(V) \leq (p_n(V)/c_{\text{dichot}})^k \quad \forall k \in \mathbb{Z}_{\geq 1}.$$

In particular, for each potential $V \in \Phi$, either $p_n(V) \geq c_{\text{dichot}}$ for all $n \in \mathbb{Z}_{\geq 1000}$, or $(p_{kn}(V))_{k \geq 1}$ decays exponentially for some fixed $n \in \mathbb{Z}_{\geq 1}$.

Proof. Claim that we may find constants $c_A, c_B > 0$ such that for any $(\Lambda, \tau) \in \text{Geom}_{80kn, 160kn}$,

$$\mu_{\Lambda, \tau, 0}(\mathcal{A}_{k,n}^*(\mathcal{L}_1, n) | \mathcal{A}^*(\mathcal{L}_1, 20kn)) \geq c_A^k, \quad (29)$$

$$\mu_{\Lambda, \tau, 0}(\mathcal{A}_{k,n}^*(\mathcal{L}_0, 4n) | \mathcal{A}_{k,n}^*(\mathcal{L}_1, n)) \geq c_B^k, \quad (30)$$

$$\mu_{\Lambda, \tau, 0}(\mathcal{A}_{k,n}^*(\mathcal{L}_1, n) | \mathcal{A}_{k,n}^*(\mathcal{L}_0, 4n)) \leq p_n^k. \quad (31)$$

The claim implies the lemma with $c_{\text{dichot}} = c_A c_B$ because (29) and (30) imply that

$$\sup_{(\Lambda, \tau) \in \text{Geom}_{80kn, 160kn}} \mu_{\Lambda, \tau, 0}(\mathcal{A}_{k,n}^*(\mathcal{L}_1, n) \cap \mathcal{A}_{k,n}^*(\mathcal{L}_0, 4n)) \geq p_{20kn} c_A^k c_B^k,$$

while (31) says that

$$\sup_{(\Lambda, \tau) \in \text{Geom}_{80kn, 160kn}} \mu_{\Lambda, \tau, 0}(\mathcal{A}_{k,n}^*(\mathcal{L}_1, n) \cap \mathcal{A}_{k,n}^*(\mathcal{L}_0, 4n)) \leq p_n^k.$$

Proof of (31). This proof is straightforward: one may estimate the conditional probability by first exploring the k outermost \mathcal{L}_0 -circuits which are contained in their k respective annuli, then use the Markov property and the definition of the observable to derive the inequality.

Proof of (29). The proof of (29) is also a straightforward combination of simple exploration processes with Lemmas 5.1 and 5.2. First observe that

$$\begin{aligned} \mu_{\Lambda, \tau, 0}(\mathcal{A}_{k,n}^*(\mathcal{L}_1, n) | \mathcal{A}^*(\mathcal{L}_1, 20kn)) &= \mu_{\Lambda, \tau, 1}(\mathcal{A}_{k,n}^*(\mathcal{L}_0, n) | \mathcal{A}^*(\mathcal{L}_0, 20kn)) \\ &\geq \mu_{\llbracket 40kn \rrbracket, 0, 0}(\mathcal{A}_{k,n}^*(\mathcal{L}_0, n)); \end{aligned}$$

the equality is obvious after switching the heights zero and one, while the inequality follows by exploring the outermost \mathcal{L}_0 -circuit (taking into account Lemma 2.9) and applying monotonicity in domains (Lemma 3.6). It suffices to prove

$$\mu_{\llbracket 40kn \rrbracket, 0, 0}(\mathcal{A}_{k,n}^*(\mathcal{L}_0, n)) \geq c_A^k \quad (32)$$

for some $c_A > 0$.

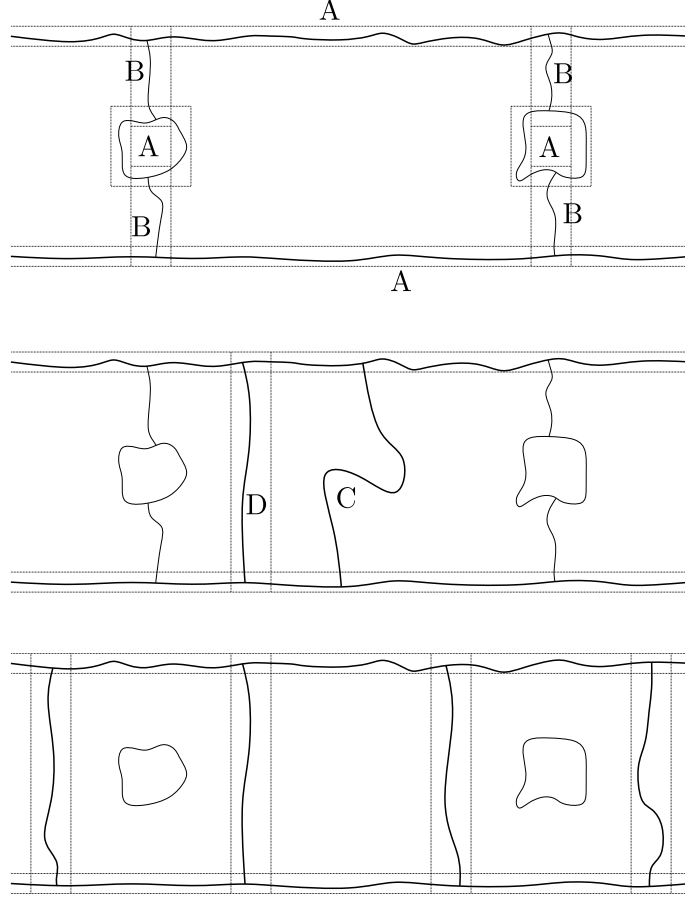

FIGURE 19. The proof of (34). Thin lines indicate $\mathcal{L}_{\leq 1}$; thick lines $\mathcal{L}_{\leq 0}$.

Define the event

$$\mathcal{H}(\mathcal{L}_0) := \{\mathcal{L}_0 \in \text{Hor}^*\{[40kn] \times [-3n, -2n]\} \cap \text{Hor}^*\{[40kn] \times [2n, 3n]\}\}.$$

Lemma 5.2 asserts that

$$\mu_{[40kn],0,0}(\mathcal{H}(\mathcal{L}_0)) \geq c_{\text{via}}^{80k}.$$

Now

$$\mu_{[40kn],0,0}(\mathcal{A}_{k,n}^*(\mathcal{L}_0, n) | \mathcal{H}(\mathcal{L}_0)) \geq \mu_{[40kn] \times [3n-1],0,0}(\mathcal{A}_{k,n}^*(\mathcal{L}_0, n)) \geq c_{\text{net}}^{20k};$$

for the first inequality one simply explores the highest and lowest horizontal \mathcal{L}_0 -crossings of $[40kn] \times [3n]$ conditional on the event $\mathcal{H}(\mathcal{L}_0)$ and uses monotonicity in domains; for the second inequality one applies the net lemma. This proves (32), and therefore also (29), with the constant $c_A := c_{\text{via}}^{80} \cdot c_{\text{net}}^{20}$.

Proof of (30). Define $\mathcal{Y}' := \mathcal{Y} \cup (\mathbb{E}^* \setminus \mathbb{E}^*(\Lambda))$ in analogy with Section 5, and write

$$\mathcal{H}_m(\mathcal{Y}) := \{\mathcal{Y}' \in \text{Hor}^*\{[160kn] \times [-m-n, -m]\} \cap \text{Hor}^*\{[160kn] \times [m, m+n]\}\}.$$

Claim that there exist constants $c', c'', c''' > 0$ such that

$$\mu_{\Lambda, \tau, 0}(\mathcal{H}_{5n}(\mathcal{L}_{\leq 0}) | \mathcal{A}_{k,n}^*(\mathcal{L}_1, n)) \geq (c')^k; \quad (33)$$

$$\mu_{\Lambda, \tau, 0}(\mathcal{A}_{k,n}^*(\mathcal{L}_{\leq 0}, 4n) | \mathcal{H}_{5n}(\mathcal{L}_{\leq 0}) \cap \mathcal{A}_{k,n}^*(\mathcal{L}_1, n)) \geq (c'')^k; \quad (34)$$

$$\mu_{\Lambda, \tau, 0}(\mathcal{A}_{k,n}^*(\mathcal{L}_0, 4n) | \mathcal{A}_{k,n}^*(\mathcal{L}_{\leq 0}, 4n) \cap \mathcal{A}_{k,n}^*(\mathcal{L}_1, n)) \geq (c''')^k; \quad (35)$$

jointly these inequalities imply (30) with $c_B := c' \cdot c'' \cdot c'''$.

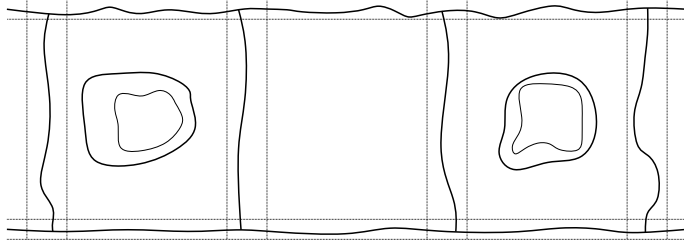

FIGURE 20. The proof of (35). Thin lines indicate \mathcal{L}_1 ; thick lines \mathcal{L}_0 .

Focus on (33). Lemma 5.2 implies

$$\mu_{\Lambda, \tau, 0}(\mathcal{H}_{3n}(\mathcal{L}_{\leq 1}) | \mathcal{A}_{k,n}^*(\mathcal{L}_1, n)) \geq c_{\text{via}}^{320k}$$

by exploring the annulus circuits from the inside, then applying the lemma with the ideas in Remark 5.3 and monotonicity in domains (observing that this time $\Lambda \subset \Lambda_{160kn}$). Now let c denote the constant from Corollary 7.2. That corollary implies that

$$\mu_{\Lambda, \tau, 0}(\mathcal{H}_{5n}(\mathcal{L}_{\leq 0}) | \mathcal{H}_{3n}(\mathcal{L}_{\leq 1}) \cap \mathcal{A}_{k,n}^*(\mathcal{L}_1, n)) \geq c^{320k},$$

by first exploring the innermost horizontal crossings by $\mathcal{L}_{\leq 1}$ contributing to $\mathcal{H}_{3n}(\mathcal{L}_{\leq 1})$ respectively, then apply Corollary 7.2 in the two remaining domains. The previous two displays imply (33) with $c' := c_{\text{via}}^{320} \cdot c^{320}$.

Now focus on (34); see Figure 19. The inequality is deduced from a multi-step exploration process and a corresponding series of inequalities following [DST17]. We want to show that the large $\mathcal{L}_{\leq 0}$ -circuit occurs with a sufficiently high probability around each small \mathcal{L}_1 -circuit. Since we already condition the event $\mathcal{H}_{5n}(\mathcal{L}_{\leq 0})$ to occur, it suffices to show that we can build the vertical $\mathcal{L}_{\leq 0}$ -crossings to connect the horizontal $\mathcal{L}_{\leq 0}$ -crossings at the top and bottom (see Figure 19, BOTTOM). The exploration process is defined as follows.

- A. First, one explores the small \mathcal{L}_1 -circuits from the inside, as well as the horizontal $\mathcal{L}_{\leq 0}$ -crossings from the outside, which occur because of the conditioning event.
- B. Then one explores, from the outside, a vertical $\mathcal{L}_{\leq 1}$ -crossing to connect the \mathcal{L}_1 -circuits to the horizontal $\mathcal{L}_{\leq 0}$ -crossings. Such crossings exist with a conditional probability of at least c_{net}^2 due to Lemma 5.1 and Remark 5.3.
- C. We have now explored a wide quad, so that the vertical $\mathcal{L}_{\leq 0}$ -crossing occurs with a conditional probability of at least $1/2$. Explore it from the right. The pushing lemma says that the rightmost such crossing is entirely on the right of the vertical rectangle (containing the crossing D) with conditional probability at least c^{10} , where c is the constant from Corollary 7.2.
- D. We may now use the pushing lemma and the net lemma to push the vertical $\mathcal{L}_{\leq 0}$ -crossing in the correct position, namely within the vertical rectangle. This vertical crossing occurs with a conditional probability of at least $c^{10} \cdot c_{\text{net}}$.

We have now proved that conditional on Exploration A, the vertical $\mathcal{L}_{\leq 0}$ -crossing of Step D occurs with a probability of at least $\tilde{c} := c^{20} c_{\text{net}}^3 / 2$. But conditional on Exploration A, the FKG inequality holds true, and therefore *all* vertical $\mathcal{L}_{\leq 0}$ -crossings occur with a probability of at least \tilde{c}^{2k} ; see Figure 19, BOTTOM. This proves (34) with the constant $c'' := \tilde{c}^2$.

It suffices to prove (35), which is fairly straightforward (Figure 20). First explore the \mathcal{L}_1 -circuits from the inside, then explore the smallest $\mathcal{L}_{\leq 0}$ -circuits surrounding each \mathcal{L}_1 -circuit. This is done by running a target height exploration with the target height $a = 0$. But since the exploration starts at the height 1, the intermediate value theorem tells us that we are in fact exploring \mathcal{L}_0 -circuits, not just $\mathcal{L}_{\leq 0}$ -circuits. Thus, the boundary height function for the remaining law is identically equal to zero. The proof that the event $\mathcal{A}_{k,n}^*(\mathcal{L}_0, 4n)$ occurs with a high enough probability in this conditional measure follows exactly the proof of (29).

This proves Lemma 1. \square

9. THE LOCALISED REGIME

We first prove an auxiliary lemma which is used both in this section and the next.

Lemma 9.1. *Let α and α' denote probability measures on \mathbb{Z}^2 supported on finitely many vertices, so that $\alpha(h)$ and $\alpha'(h)$ are random variables. Then for any $(\Lambda, \tau) \in \text{Geom}$, we have*

$$\text{Cov}_{\mu_{\Lambda, \tau, 0}}[\alpha(h), \alpha'(h)] = \int_{\Lambda \times \Lambda} \mu_{\Lambda, \tau, 0}(1\{x \xrightarrow{\mathcal{L}_0^\circ} y\} \cdot |h_x| \cdot |h_y|) d(\alpha \times \alpha')(x, y).$$

Similarly we have, for any vertices $x, y \in \mathbb{Z}^2$,

$$\text{Cov}_{\mu_{\Lambda, \tau, 0}}[\text{Sign}(h_x), \text{Sign}(h_y)] = \mu_{\Lambda, \tau, 0}(\{1\{x \xrightarrow{\mathcal{L}_0^\circ} y\} \cdot |h_x| \cdot |h_y| > 0\})$$

Since the law of $(|h|, \mathcal{L}_0^\circ)$ in $\mu_{\Lambda, \tau, 0}$ is increasing in (Λ, τ) , so are those covariances.

Proof. The variables have mean zero by flip symmetry (Theorem 2.4). The identities follow from the Ising model decomposition (Lemma 3.3). \square

The lemma implies well-definedness of the following quantities for any $V \in \Phi$.

Definition 9.2 (Covariance matrices). For any $V \in \Phi$ and $x, y \in \mathbb{Z}^2$, we define

$$\begin{aligned} \text{Cov}_V[x; y] &:= \lim_{n \rightarrow \infty} \mu_{\Lambda_n, 0, 0}(h_x h_y) = \lim_{n \rightarrow \infty} \mu_{\Lambda_n, 0, 0}(1\{x \xrightarrow{\mathcal{L}_0^\circ} y\} \cdot |h_x| \cdot |h_y|); \\ \text{SigCov}_V[x; y] &:= \lim_{n \rightarrow \infty} \mu_{\Lambda_n, 0, 0}(\text{Sign}(h_x h_y)) \\ &= \lim_{n \rightarrow \infty} \mu_{\Lambda_n, 0, 0}(\{1\{x \xrightarrow{\mathcal{L}_0^\circ} y\} \cdot |h_x| \cdot |h_y| > 0\}). \end{aligned}$$

The matrices take values in $[0, \infty]$ and $[0, 1]$ respectively.

To cast Lemma 1 in a more usable form, we first prove the following inequality.

Lemma 9.3. *There exists a universal constant $N \in \mathbb{Z}_{\geq 1}$ such that for any potential $V \in \Phi$ and for any $n \in \mathbb{Z}_{\geq 1000}$, we have*

$$\mu_{\Lambda_{4n}, 0, 0}(\mathcal{A}^*(\mathcal{L}_0, n)) \geq 1 - N \cdot \sqrt[n]{p_{20n}(V)}.$$

Proof. By the net lemma, we have

$$\mu_{\Lambda_{80n}, 0, 0}(\mathcal{A}^*(\mathcal{L}_1, 20n) | \mathcal{C}^*(\mathcal{L}_1, 20n)) \geq c_{\text{net}}.$$

Thus, by the definition of the annulus observable, we have

$$\mu_{\Lambda_{80n}, 0, 0}(\mathcal{C}^*(\mathcal{L}_{\geq 1}, 20n)) = \mu_{\Lambda_{80n}, 0, 0}(\mathcal{C}^*(\mathcal{L}_1, 20n)) \leq p_{20n}/c_{\text{net}};$$

the equality stems from the intermediate value theorem. Let A_n denote the event that

$$\mathbb{F}([-n, n]^2) \xrightarrow{\mathcal{L}_0} \mathbb{F}(\partial[-2n, 2n]^2).$$

If neither $\mathcal{C}^*(\mathcal{L}_{\geq 1}, 20n)$ nor $\mathcal{C}^*(\mathcal{L}_{\leq -1}, 20n)$ occurs, then the event A_{20n} must occur, and

$$\mu_{\Lambda_{80n}, 0, 0}(A_{20n}) \geq 1 - 2p_{20n}/c_{\text{net}}.$$

By applying Section 4 as in the proof of Lemma 5.1 for $\alpha = w = 1$ (see Remark 5.6), we may find a large universally constant integer M such that

$$\mu_{\Lambda_{4n}, 0, 0}(\mathcal{A}^*(\mathcal{L}_0, n)) \geq \psi_M(\mu_{\Lambda_{80n}, 0, 0}(A_{20n})) \geq \psi_M(1 - 2p_{20n}/c_{\text{net}}).$$

By Remark 4.4 it is now easy to find the desired constant $N = N(c_{\text{net}}, M)$. \square

Lemma 9.4. *For any $n \in \mathbb{Z}_{\geq 1000}$ and $k \in \mathbb{Z}_{\geq 0}$, we have*

$$\mu_{\Lambda_{2^k 4n}, 0, 0}(\mathcal{A}^*(\mathcal{L}_0, n)) \geq 1 - 2N \cdot \sqrt[N]{p_n/c_{\text{dichot}}}.$$

Observe in particular that the lower bound does not depend on k .

Proof. If $\sqrt[N]{p_n/c_{\text{dichot}}} \geq 1/2$ then the lemma is trivial; we focus on the remaining case. We first claim that

$$\mu_{\Lambda_{2^k 4n}, 0, 0}(\mathcal{A}^*(\mathcal{L}_0, n)) \geq 1 - N \sum_{\ell=0}^k \sqrt[N]{p_{2^\ell 20n}}.$$

We obtain the lower bound by an iterated exploration process. First explore the outermost circuit contributing to the event $\mathcal{A}^*(\mathcal{L}_0, 2^k n)$. The probability that this event fails (because the event does not occur) is at most $N \cdot \sqrt[N]{p_{2^k 20n}}$ due to the previous lemma. Conditional on the successful exploration of the first circuit, we may explore the outermost circuit contributing to $\mathcal{A}^*(\mathcal{L}_0, 2^{k-1} n)$, noting that this second exploration fails with a probability of at most $N \cdot \sqrt[N]{p_{2^{k-1} 20n}}$, taking into account the previous lemma and monotonicity in domains. Iterating yields the claim. Setting k to ∞ and applying Lemma 1 yields

$$\mu_{\Lambda_{2^k 4n}, 0, 0}(\mathcal{A}^*(\mathcal{L}_0, n)) \geq 1 - N \sum_{\ell=0}^{\infty} (p_n/c_{\text{dichot}})^{2^\ell/N}.$$

This may of course be lower bounded by

$$1 - N \sum_{\ell=1}^{\infty} (p_n/c_{\text{dichot}})^{\ell/N} = 1 - N \cdot \frac{\sqrt[N]{p_n/c_{\text{dichot}}}}{1 - \sqrt[N]{p_n/c_{\text{dichot}}}}.$$

The lemma now follows because $\sqrt[N]{p_n/c_{\text{dichot}}} \leq 1/2$. \square

Lemma 9.5. *Let $V \in \Phi$ and suppose that there exists an $n \in \mathbb{Z}_{\geq 1000}$ such that $p_n(V) < c_{\text{dichot}}$. Then the model is localised, and $\mu_{\Lambda, 0, 0}$ converges to some ergodic extremal Gibbs measure μ in the topology of local convergence as $\Lambda \uparrow \mathbb{Z}^2$. Moreover, in μ , we have, for any $n \in \mathbb{Z}_{\geq 1000}$,*

$$\mu(\mathcal{A}^*(\mathcal{L}_0, n)) \geq 1 - 2N \cdot \sqrt[N]{p_n/c_{\text{dichot}}}.$$

Proof. The law of h_0 in $\mu_{\Lambda, 0, 0}$ is log-concave and symmetric around zero. Thus, either the probability of $\{h_0 = 0\}$ goes to zero, or it remains uniformly positive as $\Lambda \uparrow \infty$. In the former case the model is delocalised; in the latter case it is localised. In the former case, the probability of the event $\mathcal{A}^*(\mathcal{L}_0, n)$ goes to zero in $\mu_{\Lambda, 0, 0}$ as $\Lambda \uparrow \mathbb{Z}^2$. But if $p_n(V) < c_{\text{dichot}}$, then we know that this is false, and we must be in the localised regime. Log-concavity and uniform positivity of $\{h_0 = 0\}$ implies the tightness which is sufficient to conclude convergence to some measure μ . This limit is ergodic and extremal, see also [LO21]. Moreover, since the lower bound in the previous lemma is independent of k , it also applies to the measure μ . \square

Lemma 9.6. *Under the hypotheses in the previous lemma, there exists a unique norm $\|\cdot\|_V$ on \mathbb{R}^2 such that*

$$\text{Cov}_V[x; y] = e^{-(1+o(1))\|y-x\|_V} \quad \text{as } \|y-x\|_2 \rightarrow \infty; \quad (36)$$

$$\text{SigCov}_V[x; y] = e^{-(1+o(1))\|y-x\|_V} \quad \text{as } \|y-x\|_2 \rightarrow \infty. \quad (37)$$

Proof. We first focus on proving (37) for an appropriate norm $\|\cdot\|_V$. Since \mathcal{L}_0° connects vertices whose height has the same sign, we get

$$\text{SigCov}_V[x; y] = \mu(x \xrightarrow{\mathcal{L}_0^\circ} y) \quad \forall x \neq y.$$

The FKG inequality implies the triangular inequality for

$$m : \mathbb{Z}^2 \times \mathbb{Z}^2, (x, y) \mapsto -\log \mu(x \xrightarrow{\mathcal{L}_0^\circ} y).$$

The existence of the norm $\|\cdot\|_V$ for (37) therefore follows from a standard subadditivity argument as soon as $\text{SigCov}_V[x; y]$ decays exponentially fast in $\|y - x\|_2$. This exponential decay follows from Lemma 1 and the inequality in Lemma 9.5, together with the inequality $p_n < c_{\text{dichot}}$ to bootstrap the second coarse-graining inequality.

Clearly $\text{Cov}_V[x; y] \geq \text{SigCov}_V[x; y]$. To prove (36) with the same norm $\|\cdot\|_V$, it suffices to prove that

$$\frac{\text{Cov}_V[x; y]}{\text{SigCov}_V[x; y]} = \mu(|h_x h_y| | x \xrightarrow{\mathcal{L}_0^\circ} y) \leq e^{o(\|y-x\|_2)} \quad (38)$$

as $\|y - x\|_2 \rightarrow \infty$. Observe that:

1. We have already established (37),
2. The law of h_x in μ does not depend on $x \in \mathbb{Z}^2$,
3. The probability $\mu(|h_x| > \lambda)$ decays exponentially fast in λ .

The third observation holds true because the law of h_x is log-concave in each finite-volume measure $\mu_{\Lambda,0,0}$, and therefore also in the limit measure μ . Equation (38) follows from the three observations and a simple calculation for the worst case scenario where the three random variables $|h_x|$, $|h_y|$, and $1\{x \xrightarrow{\mathcal{L}_0^\circ} y\}$ are maximally correlated. \square

Of course, the previous lemma does not imply Theorem 2 by itself, because we have not proved that localisation implies exponential decay for $(p_n)_n$. In the next section, we shall prove that uniform positivity of $(p_n)_n$ implies delocalisation, as well as the conclusions of Theorem 3. This means that the dichotomy implied by Lemma 1 is indeed equivalent to the dichotomy of the localisation-delocalisation transition, which completes the proofs of Theorems 2 and 3.

10. THE DELOCALISED REGIME

In this section, we prove the following lemma. Jointly with Lemma 9.6, this lemma implies Theorems 2 and 3.

Lemma 10.1. *Suppose that $V \in \Phi$ is a potential such that $p_n(V) \geq c_{\text{dichot}}$ for all $n \in \mathbb{Z}_{\geq 1000}$. Let $n \geq 8000$ and $1 \leq m \leq n/8$. Let α denote a probability measure on \mathbb{Z}^2 which is supported on Λ_m so that $\alpha(h)$ is a random variable. Then*

$$\text{Var}_{\mu_{\Lambda_n}}[\alpha(h)] \geq c_{\text{eff}} \times \log \frac{n}{m}$$

for some universal constant $c_{\text{eff}} > 0$.

Proof. Fix V , m , and α . Observe first that the variance in the display is increasing in n by Lemma 9.1. Assume therefore, without loss of generality, that $m \geq 1000$ and that $n = 2^k m$ for $k \in \mathbb{Z}_{\geq 3}$. Define

$$v_k := \text{Var}_{\mu_{\Lambda_{2^k m}}}[\alpha(h)] \quad \forall k \in \mathbb{Z}_{\geq 0};$$

this sequence is nonnegative and nondecreasing, and the idea is to prove certain difference inequalities on $(v_k)_{k \geq 0}$ which imply that $v_k \geq ck$ when $k \geq 3$ for some universal $c > 0$.

We introduce some simple tools which help the constructions. First, let T denote a fixed total order on \mathbf{Geom} , which is used to disambiguate a certain choice we are making later on. Second, let $(F_k)_{k \geq -2}$ denote the Fibonacci sequence started from $F_{-2} = 0$ and $F_{-1} = 1$. Let $\varphi > 0$ denote the golden ratio, and observe that $1 + F_k \geq \varphi^k$ for all k .

Fix $k \geq 0$. Let $(\Lambda, \tau) \in \mathbf{Geom}_{4 \cdot 2^k m, 8 \cdot 2^k m}$ denote the smallest geometric domain (with respect to T) such that

$$\mu_{\Lambda, \tau, 0}(\mathcal{C}^*(\mathcal{L}_1, 2^k m)) \geq c_{\text{dichot}}/2, \quad (39)$$

which exists by the hypothesis on V . The key to proving the difference inequalities lies in the following construction. Let $\varepsilon > 0$ denote an extremely small constant whose precise

value is fixed later, and define

$$s_k := \sup \left\{ 0 \leq \ell \leq k : \mu_{\Lambda, \tau, 0}(\mathcal{C}^*(\mathcal{L}_{F_\ell}, 2^{k-\ell}m)) \geq (c_{\text{dichot}}/2)(1-\varepsilon)^\ell \right\};$$

this value is nonnegative due to (39). The value of the constant $\tilde{c} > 0$ is also fixed later.

Assertion. We distinguish two cases, based on the value of s_k .

1. If $s_k = k$, then we prove that $v_{k+3} \geq (c_{\text{dichot}}/2) \cdot \varphi^k$,
2. If $s_k < k$, then $v_{k+4} \geq v_{k-s_k} + c' \cdot \varphi^{s_k}$, where $c' := \tilde{c}(\varepsilon(c_{\text{dichot}}/2))^N \varphi^{-4}$.

These inequalities clearly prove the lemma, noting in particular that we may lower bound v_3 by setting $k = 0$, in which case it holds trivially true that $s_k = k = 0$.

Proof of Case 1. Consider first the case that $s_k = k$. Then we have

$$v_{k+3} \geq \text{Var}_{\mu_{\Lambda, \tau, 0}}[\alpha(h)] \geq (c_{\text{dichot}}/2)(1-\varepsilon)^k \varphi^{2k}. \quad (40)$$

The inequality on the left is Lemma 9.1. The inequality on the right is obtained as follows: in order to estimate $\mu_{\Lambda, \tau, 0}(\alpha(h)^2)$, one runs a martingale on the value of $\alpha(h)$, which, at the first step, reveals if the event $\mathcal{C}^*(\mathcal{L}_{F_k}, m)$ occurs or not. The event occurs with probability at least $(c_{\text{dichot}}/2)(1-\varepsilon)^k$, and, conditional on this event, the expected value of $\alpha(h)$ is precisely $F_k \geq \varphi^k$. Thus, the expected quadratic variation of this first step exceeds the right hand side in (40). The first case now follows as soon as we set $\varepsilon > 0$ so small that $(1-\varepsilon)\varphi \geq 1$.

Proof of Case 2. Now consider the case that $s_k < k$. Then

$$\mu_{\Lambda, \tau, 0}(\mathcal{C}^*(\mathcal{L}_{F_{s_k}}, 2^{k-s_k}m) \setminus \mathcal{C}^*(\mathcal{L}_{F_{s_k+1}}, 2^{k-s_k-1}m)) \geq \varepsilon(c_{\text{dichot}}/2)(1-\varepsilon)^{s_k},$$

and therefore

$$\mu_{\Lambda, \tau, 0}(\mathcal{C}^*(\mathcal{L}_{F_{s_k}}, 2^{k-s_k}m) \setminus \mathcal{A}^*(\mathcal{L}_{\geq F_{s_k+1}}, 2^{k-s_k-1}m)) \geq \varepsilon(c_{\text{dichot}}/2)(1-\varepsilon)^{s_k}.$$

But the probability of this event may be calculated as follows: first, one explores the largest $\mathcal{L}_{F_{s_k}}$ -circuit surrounding $\llbracket 2^{k-s_k}m \rrbracket^2$, which induces flip-symmetry around the height F_{s_k} in the unexplored remainder. To see if the event $\mathcal{A}^*(\mathcal{L}_{\geq F_{s_k+1}}, 2^{k-s_k-1}m)$ occurs, we need to check if the threads within this unexplored remainder are long enough to reach at least to F_{s_k+1} to create the circuit through the annulus. By flip symmetry, this is equivalent to checking if the threads are long enough to reach back to $F_{s_k} - (F_{s_k+1} - F_{s_k}) = F_{s_k-2}$. This implies

$$\mu_{\Lambda, \tau, 0}(\mathcal{C}^*(\mathcal{L}_{F_{s_k}}, 2^{k-s_k}m) \setminus \mathcal{A}^*(\mathcal{L}_{F_{\leq s_k-2}}, 2^{k-s_k-1}m)) \geq \varepsilon(c_{\text{dichot}}/2)(1-\varepsilon)^{s_k}.$$

But the complement of the annulus event is precisely the event that $\{[\Delta] \geq 1 + F_{s_k-2}\}$ connects the inner boundary of the annulus to the outer boundary. Since $1 + F_{s_k-2} \geq \varphi^{s_k-2}$, we get

$$\mu_{\Lambda, \tau, 0} \left(\llbracket 2^{k-s_k-1}m \rrbracket^2 \xrightarrow{\{[\Delta] \geq \varphi^{s_k-2}\}} \partial \llbracket 2^{k-s_k}m \rrbracket^2 \right) \geq \varepsilon(c_{\text{dichot}}/2)(1-\varepsilon)^{s_k}.$$

Observe that $\{[\Delta] \geq \varphi^{s_k-2}\}$ satisfies the properties of the percolation \mathcal{X} in Theorem 4.6 due to monotonicity in domains. Thus, by that theorem and Remark 4.4, there exist constants $\tilde{c}, N > 0$ such that

$$\mu_{\Lambda_{16 \cdot 2^k m}, 0, 0}(\mathcal{A}(\{[\Delta] \geq \varphi^{s_k-2}\}, 2^{k-s_k}m)) \geq \tilde{c}(\varepsilon(c_{\text{dichot}}/2)(1-\varepsilon)^{s_k})^N. \quad (41)$$

Write A for the event in the display and A^c for its complement; we are now going to estimate $\mu_{\Lambda_{16 \cdot 2^k m}, 0, 0}(\alpha(h)^2)$. By Lemmas 9.1 and 3.12, we have

$$\mu_{\Lambda_{16 \cdot 2^k m}, 0, 0}(\alpha(h)^2 | A^c) \geq \mu_{\Lambda_{2^{k-s_k} m}, 0, 0}(\alpha(h)^2) = v_{k-s_k}. \quad (42)$$

Next, we focus on $\mu_{\Lambda_{16 \cdot 2^k m}, 0, 0}(\alpha(h)^2 | A)$. In order to estimate this expectation, one first explores the outermost circuit contributing to the event A . Write X for the vertices on

this circuit, and Λ' for the set of vertices enclosed by X . Thus, on X , the absolute height is at least $\lceil \varphi^{s_k-2} \rceil$, and the sign of h is constant, say $+$ without loss of generality. Using Lemma 3.2, we may lower bound the conditional expectation of $\alpha(h)^2$ by pretending that $h|_X \equiv \lceil \varphi^{s_k-2} \rceil$. Thus, we get

$$\begin{aligned} \mu_{\Lambda_{16 \cdot 2^{k_m}}, 0, 0}(\alpha(h)^2|A) &\geq \int \mu_{\Lambda', 0, \lceil \varphi^{s_k-2} \rceil}(\alpha(h)^2) d\mu_{\Lambda_{16 \cdot 2^{k_m}}, 0, 0}(\Lambda'|A) \\ &= \lceil \varphi^{s_k-2} \rceil^2 + \int \mu_{\Lambda', 0, 0}(\alpha(h)^2) d\mu_{\Lambda_{16 \cdot 2^{k_m}}, 0, 0}(\Lambda'|A) \geq \lceil \varphi^{s_k-2} \rceil^2 + v_{k-s_k}. \end{aligned} \quad (43)$$

Putting (41), (42), and (43) together, we get

$$v_{k+4} \geq v_{k-s_k} + \tilde{c}(\varepsilon(c_{\text{dichot}}/2)(1-\varepsilon)^{s_k})^N \varphi^{2s_k-4}.$$

Choosing $\varepsilon > 0$ so small that $\varphi(1-\varepsilon)^N \geq 1$, we have

$$v_{k+4} \geq v_{k-s_k} + \tilde{c}(\varepsilon(c_{\text{dichot}}/2))^N \varphi^{-4} \cdot \varphi^{s_k}.$$

This proves the second case.

We have now established Lemma 10.1 and therefore Theorems 2 and 3. \square

The following lemma summarises some information on Cov_V and SigCov_V and may be of independent interest.

Lemma 10.2. *1. For any $V \in \text{Loc}[\Phi]$ there exists a norm $\|\cdot\|_V$ on \mathbb{R}^2 such that*

$$\begin{aligned} \text{Cov}_V[x; y] &= e^{-(1+o(1))\|y-x\|_V} && \text{as } \|y-x\|_2 \rightarrow \infty; \\ \text{SigCov}_V[x; y] &= e^{-(1+o(1))\|y-x\|_V} && \text{as } \|y-x\|_2 \rightarrow \infty. \end{aligned}$$

2. For any $V \in \text{Deloc}[\Phi]$ we have $\text{Cov}_V \equiv \infty$ and $\text{SigCov}_V \equiv 1$.

Proof. The first part follows from Lemma 9.6 and the extra information that decay of the observable coincides with localisation. For the second part, suppose that $V \in \text{Deloc}[\Phi]$. Then $|h_x| \rightarrow \infty$ in probability in the sequence $(\mu_{\Lambda_n, 0, 0})_{n \in \mathbb{Z}_{\geq 1}}$ for any $x \in \mathbb{Z}^2$. Therefore the Ising model coupling constants in (14) tend to ∞ in probability, meaning that any fixed edge is \mathcal{L}_0° -open with high probability. This implies the second part via the identities in Definition 9.2. \square

11. CONTINUITY OF THE FINITE-VOLUME OBSERVABLE

Lemma 11.1 (Continuity of the observable). *For fixed $n \in \mathbb{Z}_{\geq 1000}$, the observable $V \mapsto p_n(V)$ is continuous as a function on the topological space (Φ, \mathcal{T}) .*

Combined with the second coarse-graining inequality, this lemma immediately implies Theorem 4. Theorem 5 follows from this lemma by carefully tracing all the constants in Section 9. The remainder of this section contains the proof of Lemma 11.1.

Let $n \in \mathbb{Z}_{\geq 1000}$ denote a fixed integer. Unlike in the other sections, we use a superscript V to indicate the potential used to define each object. It is easy to see that the map

$$V \mapsto \mu_{\Lambda, \tau, 0}^V(\mathcal{A}^*(\mathcal{L}_1, n))$$

is continuous. The complication lies in the appearance of the supremum over infinitely many geometric domains $(\Lambda, \tau) \in \text{Geom}_{4n, 8n}$ in the definition of the observable, and appears to be entirely technical in nature.

In this section, let π^V denote the probability distribution on \mathbb{Z} whose likelihood is proportional to e^{-V} , and define

$$\Pi(V) := \{\pi^{V[\tau]} : \tau \in \mathbb{Z}_{\geq 0}\}.$$

The random integer in any such measure is denoted k .

Since Λ takes only finitely many values, it suffices to demonstrate that the map

$$V \mapsto \sup_{\tau \in \text{Geom}_{4n,8n}(\Lambda)} \mu_{\Lambda,\tau,0}^V(\mathcal{A}^*(\mathcal{L}_1, n)) \quad (44)$$

is continuous for fixed Λ , where $\text{Geom}_{4n,8n}(\Lambda) := \{\tau : (\Lambda, \tau) \in \text{Geom}_{4n,8n}\}$. Write $\partial_{\text{int}}\Lambda$ for the *interior boundary* of Λ , that is, set of vertices in Λ which have a neighbour that is not in Λ . If we condition on $h|_{\partial_{\text{int}}\Lambda}$, then the Markov property implies that the event $\mathcal{A}^*(\mathcal{L}_1, n)$ no longer interacts with the boundary of the domain, and in particular the values of τ . The following lemma implies that it is sufficient to consider finitely many values for $h|_{\partial_{\text{int}}\Lambda}$.

Lemma 11.2. *Each $V \in \Phi$ admits a neighbourhood \mathcal{N} such that*

$$\lim_{N \rightarrow \infty} \inf_{W \in \mathcal{N}} \inf_{\tau \in \text{Geom}_{4n,8n}(\Lambda)} \mu_{\Lambda,\tau,0}^W(-N \leq h|_{\partial_{\text{int}}\Lambda} \leq N) = 1.$$

Proof. Since $\partial_{\text{int}}\Lambda$ is finite, it suffices to prove the lemma with $\partial_{\text{int}}\Lambda$ replaced by $\{y\}$ for some fixed $y \in \partial_{\text{int}}\Lambda$. By definition of $\partial_{\text{int}}\Lambda$, there is some vertex $x \in \partial_v\Lambda$ such that $xy \in \partial_e\Lambda$. Let μ^* denote the measure $\mu_{\Lambda,\tau,0}^W$, except that the potential corresponding to the edge xy is omitted in the definition of the Hamiltonian in Definition 2.3. Write $\pi := \pi^{W[\tau_{xy}]}$. Write (h^*, ρ^*) and k for the random objects in the measures μ^* and π respectively. Then the following two height functions have the exact same distribution:

1. The height function h in the measure $\mu_{\Lambda,\tau,0}^W$,
2. The height function h^* in the measure $\mu^* \times \pi$ conditioned on the event $\{h_y^* = k\}$.

Note that the distribution of h_y^* is symmetric and log-concave. Therefore we have

$$\mu_{\Lambda,\tau,0}^W(|h_y| > N) \leq \pi(|k| > N).$$

Thus, it suffices to show that

$$\lim_{N \rightarrow \infty} \sup_{\pi \in \cup_{W \in \mathcal{N}} \Pi(W)} \pi(|k| > N) = 0. \quad (45)$$

By definition of Φ , we have $V(1) > V(0)$, and therefore we may choose \mathcal{N} so small that $W(1) - W(0) \geq (V(1) - V(0))/2 =: \eta > 0$ for all $W \in \mathcal{N}$. Now note that each potential $W \in \mathcal{N}$ is convex and symmetric, and therefore $W(a+1) - W(a) \geq \eta$ for all $a \geq 0$, which also implies that $W^{[\tau]}(a+1) - W^{[\tau]}(a) \geq \eta$. This proves (45). \square

Thus, to prove continuity of (44) (and thus Lemma 11.1), it suffices to prove continuity of the map

$$V \mapsto \sup_{\tau \in \text{Geom}_{4n,8n}(\Lambda)} \mu_{\Lambda,\tau,0}^V(\mathcal{A}^*(\mathcal{L}_1, n) | \{-N \leq h|_{\partial_{\text{int}}\Lambda} \leq N\}) \quad (46)$$

for fixed $N > 0$. Fix N throughout the remainder of this proof, and write I for the interval $\{-N, \dots, N\}$. Define

$$\Xi(V) := \{\pi(\cdot | k \in I) : \pi \in \Pi(V)\}.$$

By identifying each probability measure in $\Xi(V)$ with a point in the finite-dimensional hypercube $[0, 1]^I$, we may view $\Xi(V)$ as a subset of $[0, 1]^I$. The set $[0, 1]^I$ is endowed with the standard Euclidean metric which induces a Hausdorff distance on its powerset.

Lemma 11.3. *The map*

$$\Phi \rightarrow \mathcal{P}([0, 1]^I), \quad V \mapsto \Xi(V)$$

is continuous with respect to the Hausdorff distance on $\mathcal{P}([0, 1]^I)$.

Proof. We show that each potential $V \in \Phi$ is a point of continuity. We distinguish two cases, depending on whether the derivative of V is bounded or not.

First suppose that $\lim_{a \rightarrow \infty} V(a+1) - V(a) = \infty$. In that case the closure of $\Xi(V)$ contains the point $\delta_0 \in [0, 1]^I$ (the Dirac measure on $0 \in I$) since

$$\lim_{\tau \rightarrow \infty} \frac{1}{Z} e^{-V[\tau]}|_I = \delta_0.$$

For $k \in \mathbb{Z}_{\geq 1}$, let \mathcal{N}_k denote the neighbourhood of V consisting of potentials W such that

$$|(W(a) - W(0)) - (V(a) - V(0))| \leq \frac{1}{k} \quad \forall -k \leq a \leq k.$$

It is easy to see that $\Xi(W)$ is close to $\Xi(V)$ in the Hausdorff metric when k is large and $W \in \mathcal{N}_k$: for small values of τ we know that $W^{[\tau]}|_I \approx V^{[\tau]}|_I$, while for large values of τ the induced distribution is close to δ_0 .

Now consider the case that $\lim_{a \rightarrow \infty} V(a+1) - V(a) =: \eta \in (0, \infty)$. Let $\mu_\eta \in [0, 1]^I$ denote the probability distribution given by $\mu_\eta(a) \propto e^{-\eta|a|}$. Then μ_η is in the closure of $\Xi(V)$ since

$$\lim_{\tau \rightarrow \infty} \frac{1}{Z} e^{-V^{[\tau]}|_I} = \mu_\eta.$$

For $k > 0$, let \mathcal{N}_k denote the neighbourhood of V consisting of potentials W such that

$$\begin{aligned} |(W(a) - W(0)) - (V(a) - V(0))| &\leq \frac{1}{k} \quad \forall -k \leq a \leq k; \\ \left| \eta - \lim_{a \rightarrow \infty} (W(a+1) - W(a)) \right| &\leq \frac{1}{k}. \end{aligned}$$

Then $\Xi(W)$ is again close to $\Xi(V)$ in the Hausdorff metric when k is large: for small values of τ we know that $W^{[\tau]}|_I \approx V^{[\tau]}|_I$ as before, while for large values of τ the induced distribution is close to μ_η . \square

Proof of Lemma 11.1. Define $\tilde{\Xi}(V) := \prod_{xy \in \partial_e \Lambda} \Xi(V)$, and interpret each element $\tilde{\pi} \in \tilde{\Xi}(V)$ as a product probability measure, writing $k : \partial_e \Lambda \rightarrow I$ for the corresponding random function. Since $\partial_e \Lambda$ is finite, the previous lemma implies continuity for the map

$$\Phi \rightarrow \mathcal{P}([0, 1]^{(I^{\partial_e \Lambda})}), \quad V \mapsto \tilde{\Xi}(V) \quad (47)$$

once the codomain is endowed with the natural Hausdorff metric.

To prove continuity of (46) it now suffices to decompose the probability within the supremum into continuous parts, essentially by treating each edge in $\partial_e \Lambda$ as we treated the edge xy in the proof of Lemma 11.2.

To formalise this, let $\Lambda' := \Lambda \setminus \partial_{\text{int}} \Lambda$, and write $\hat{V} := V - V(0)$, noting that \hat{V} and V induce the same probability measures. For any $f \in I^{\partial_{\text{int}} \Lambda}$, we write

$$\bar{f} : \partial_e \Lambda' \rightarrow \mathbb{Z}, \quad xy \mapsto f_x,$$

and introduce the following notations:

1. The conditioning event $C(f) := \{\forall xy \in \partial_e \Lambda, k_{xy} = f_y\}$,
2. The boundary effect $B^V(f) := \prod_{xy \in \mathbb{E}, xy \subset \partial_{\text{int}} \Lambda} e^{-\hat{V}(f_y - f_x)}$,
3. The partition function $Z^V(f) := Z_{\Lambda', 0, \bar{f}}^{\hat{V}}$,
4. The probability $P^V(f) := \mu_{\Lambda', 0, \bar{f}}^V(\mathcal{A}^*(\mathcal{L}_1, n))$.

The last three take strictly positive values and depend continuously on V . Since (47) is also continuous and because $\tilde{\pi}(C(0))$ is uniformly positive, the map

$$\begin{aligned} V \mapsto & \sup_{\tau \in \text{Geom}_{4n, 8n}(\Lambda)} \mu_{\Lambda, \tau, 0}^V(\mathcal{A}^*(\mathcal{L}_1, n) | \{-N \leq h|_{\partial_{\text{int}} \Lambda} \leq N\}) \\ &= \sup_{\tilde{\pi} \in \tilde{\Xi}(V)} \frac{\sum_{f \in I^{\partial_{\text{int}} \Lambda}} \tilde{\pi}(C(f)) B^V(f) Z^V(f) P^V(f)}{\sum_{f \in I^{\partial_{\text{int}} \Lambda}} \tilde{\pi}(C(f)) B^V(f) Z^V(f)} \end{aligned}$$

is continuous as desired. \square

ACKNOWLEDGEMENTS

The author would like to thank Hugo Duminil-Copin for several directions which turned out to be extremely useful, as well as for many encouragements during this research. The author would also like to thank Laurin Köhler-Schindler for a very enthusiastic discussion on Russo-Seymour-Welsh theory at the conference celebrating 100 years of Ising model, and Paul Dario, Aernout van Enter, Alexander Glazman, Trishen Gunaratnam, Alex Karrila, and Romain Panis for comments and suggestions regarding this work. This project has received funding from the European Research Council (ERC) under the European Union's Horizon 2020 research and innovation programme (grant agreement No. 757296).

During the preparation of this manuscript, the author learned that Alex Karrila is working independently on a project which applies percolation theory to another class of height functions.

REFERENCES

- [AHP20] Michael Aizenman, Matan Harel, and Ron Peled, *Exponential decay of correlations in the 2D random field Ising model*, Journal of Statistical Physics **180** (2020), no. 1, 304–331.
- [AHPS21] Michael Aizenman, Matan Harel, Ron Peled, and Jacob Shapiro, *Depinning in integer-restricted Gaussian fields and BKT phases of two-component spin models*, arXiv preprint arXiv:2110.09498 (2021).
- [Ber71] VL Berezinskii, *Destruction of long-range order in one-dimensional and two-dimensional systems having a continuous symmetry group I. Classical systems*, Soviet physics JETP **32** (1971), no. 3, 493–500.
- [BFL82] Jean Bricmont, Jean Raymond Fontaine, and Joel L. Lebowitz, *Surface tension, percolation, and roughening*, Journal of Statistical Physics **29** (1982), no. 2, 193–203.
- [BHM00] Itai Benjamini, Olle Häggström, and Elchanan Mossel, *On random graph homomorphisms into \mathbb{Z}* , Journal of Combinatorial Theory, Series B **78** (2000), no. 1, 86–114.
- [BPR22a] Roland Bauerschmidt, Jiwoon Park, and Pierre-François Rodriguez, *The discrete Gaussian model, I. Renormalisation group flow at high temperature*, arXiv preprint arXiv:2202.02286 (2022).
- [BPR22b] ———, *The discrete Gaussian model, II. Infinite-volume scaling limit at high temperature*, arXiv preprint arXiv:2202.02287 (2022).
- [BW82] R Brandenberger and CE Wayne, *Decay of correlations in surface models*, Journal of Statistical Physics **27** (1982), no. 3, 425–440.
- [CPST21] Nishant Chandgotia, Ron Peled, Scott Sheffield, and Martin Tassy, *Delocalization of uniform graph homomorphisms from \mathbb{Z}^2 to \mathbb{Z}* , Communications in Mathematical Physics **387** (2021), no. 2, 621–647.
- [DGH⁺18] Hugo Duminil-Copin, Maxime Gagnebin, Matan Harel, Ioan Manolescu, and Vincent Tassion, *The Bethe ansatz for the six-vertex and XXZ models: An exposition*, Probability Surveys **15** (2018), 102–130.
- [DGH⁺21] ———, *Discontinuity of the phase transition for the planar random-cluster and Potts models with $q > 4$* , Annales Scientifiques de l'École Normale Supérieure, vol. 54, 2021, pp. 1363–1413.
- [DGPS20] Hugo Duminil-Copin, Alexander Glazman, Ron Peled, and Yinon Spinka, *Macroscopic loops in the loop $O(n)$ model at Nienhuis' critical point*, Journal of the European Mathematical Society **23** (2020), no. 1, 315–347.
- [DHL⁺22] Hugo Duminil-Copin, Matan Harel, Benoit Laslier, Aran Raoufi, and Gourab Ray, *Logarithmic variance for the height function of square-ice*, Communications in Mathematical Physics (2022), 1–36.
- [DHP23] Paul Dario, Matan Harel, and Ron Peled, *Random-field random surfaces*, Probability Theory and Related Fields (2023), 1–68.
- [DKMO20] Hugo Duminil-Copin, Alex Karrila, Ioan Manolescu, and Mendes Oulamara, *Delocalization of the height function of the six-vertex model*, arXiv preprint arXiv:2012.13750 (2020).
- [DRT19] Hugo Duminil-Copin, Aran Raoufi, and Vincent Tassion, *Sharp phase transition for the random-cluster and Potts models via decision trees*, Annals of Mathematics **189** (2019), no. 1, 75–99.
- [DST17] Hugo Duminil-Copin, Vlaslas Sidoravicius, and Vincent Tassion, *Continuity of the phase transition for planar random-cluster and Potts models with $1 \leq q \leq 4$* , Communications in Mathematical Physics **349** (2017), no. 1, 47–107.
- [DT19] Hugo Duminil-Copin and Vincent Tassion, *Renormalization of crossing probabilities in the planar random-cluster model*, arXiv preprint arXiv:1901.08294 (2019).

- [DX21] Jian Ding and Jiaming Xia, *Exponential decay of correlations in the two-dimensional random field Ising model*, *Inventiones mathematicae* **224** (2021), no. 3, 999–1045.
- [EL22] Diederik van Engelenburg and Marcin Lis, *An elementary proof of phase transition in the planar XY model*, *Communications in Mathematical Physics* **399** (2022), 85–104.
- [FILS78] Jürg Fröhlich, Robert Israel, Elliot H. Lieb, and Barry Simon, *Phase transitions and reflection positivity. I. General theory and long range lattice models*, *Communications in Mathematical Physics* **62** (1978), no. 1, 1–34.
- [FSS81] Jürg Fröhlich and Thomas Spencer, *The Kosterlitz-Thouless transition in two-dimensional abelian spin systems and the Coulomb gas*, *Communications in Mathematical Physics* **81** (1981), no. 4, 527–602.
- [FSS76] J. Fröhlich, B. Simon, and T. Spencer, *Infrared bounds, phase transitions and continuous symmetry breaking*, *Communications in Mathematical Physics* **50** (1976), no. 1, 79–85.
- [GL23] Alexander Glazman and Piet Lammers, *Delocalisation in the loop $O(2)$ and six-vertex models*, In preparation (2023).
- [GM21] Alexander Glazman and Ioan Manolescu, *Uniform Lipschitz functions on the triangular lattice have logarithmic variations*, *Communications in mathematical physics* **381** (2021), no. 3, 1153–1221.
- [GMT17] Alessandro Giuliani, Vieri Mastropietro, and Fabio Lucio Toninelli, *Height fluctuations in interacting dimers*, *Annales de l’Institut Henri Poincaré, Probabilités et Statistiques*, vol. 53, 2017, pp. 98–168.
- [GP19] Alexander Glazman and Ron Peled, *On the transition between the disordered and antiferroelectric phases of the 6-vertex model*, arXiv preprint arXiv:1909.03436 (2019).
- [Gri06] Geoffrey R. Grimmett, *The random-cluster model*, *Grundlehren der mathematischen Wissenschaften*, vol. 333, Springer Berlin, Heidelberg, 2006.
- [GS20a] Christophe Garban and Avelio Sepúlveda, *Quantitative bounds on vortex fluctuations in 2d Coulomb gas and maximum of the integer-valued Gaussian free field*, arXiv preprint arXiv:2012.01400 (2020).
- [GS20b] ———, *Statistical reconstruction of the Gaussian free field and KT transition*, arXiv preprint arXiv:2002.12284 (2020).
- [Hol74] Richard Holley, *Remarks on the FKG inequalities*, *Communications in Mathematical Physics* **36** (1974), no. 3, 227–231.
- [Ken01] Richard Kenyon, *Dominos and the Gaussian free field*, *Annals of probability* (2001), 1128–1137.
- [KP17] Vital Kharash and Ron Peled, *The Fröhlich-Spencer proof of the Berezinskii-Kosterlitz-Thouless transition*, arXiv preprint arXiv:1711.04720 (2017).
- [KT73] John Michael Kosterlitz and David James Thouless, *Ordering, metastability and phase transitions in two-dimensional systems*, *Journal of Physics C: Solid State Physics* **6** (1973), no. 7, 1181.
- [KT23] Laurin Köhler-Schindler and Vincent Tassion, *Crossing probabilities for planar percolation*, *Duke Mathematical Journal* **172** (2023), no. 4, 809–838.
- [Lam22] Piet Lammers, *Height function delocalisation on cubic planar graphs*, *Probability Theory and Related Fields* **182** (2022), no. 1, 531–550.
- [Lew22] Mathieu Lewin, *Coulomb and Riesz gases: The known and the unknown*, *Journal of Mathematical Physics* **63** (2022), no. 6, 061101.
- [Lis21] Marcin Lis, *On delocalization in the six-vertex model*, *Communications in Mathematical Physics* **383** (2021), no. 2, 1181–1205.
- [LO21] Piet Lammers and Sébastien Ott, *Delocalisation and absolute-value-FKG in the solid-on-solid model*, arXiv preprint arXiv:2101.05139 (2021).
- [Pei36] Rudolf Peierls, *On Ising’s model of ferromagnetism*, *Mathematical Proceedings of the Cambridge Philosophical Society*, vol. 32, Cambridge University Press, 1936, pp. 477–481.
- [Pel17] Ron Peled, *High-dimensional Lipschitz functions are typically flat*, *The Annals of Probability* **45** (2017), no. 3, 1351–1447.
- [She05] Scott Sheffield, *Random surfaces*, *Astérisque* **304** (2005).
- [WP20] Wendelin Werner and Ellen Powell, *Lecture notes on the Gaussian free field*, arXiv preprint arXiv:2004.04720 (2020).