



UNIVERSITÄT  
DES  
SAARLANDES



# Cross-Domain Neural Entity Linking

by

**Hassan Soliman**

## Master's Thesis in Computer Science

Universität des Saarlandes  
Bosch Center for Artificial Intelligence

Supervisor

**Prof. Dr. Dietrich Klakow**

Advisors

**Dr. Heike Adel**

**Dr. Mohamed Gad-Elrab**

**MSc. Dragan Milchevski**

Reviewer

**Prof. Dr. Dietrich Klakow**

**Dr. Volha Petukhova**

February 1, 2022



# Declaration of Authorship

## Eidesstattliche Erklärung

Ich erkläre hiermit an Eides Statt, dass ich die vorliegende Arbeit selbstständig verfasst und keine anderen als die angegebenen Quellen und Hilfsmittel verwendet habe.

## Statement in Lieu of an Oath

I hereby confirm that I have written this thesis on my own and that I have not used any other media or materials than the ones referred to in this thesis.

## Einverständniserklärung

Ich bin damit einverstanden, dass meine (bestandene) Arbeit in beiden Versionen in die Bibliothek der Informatik aufgenommen und damit veröffentlicht wird.

## Declaration of Consent

I agree to make both versions of my thesis (with a passing grade) accessible to the public by having them added to the library of the Computer Science Department.

Datum/Date: February 1, 2022

---

Unterschrift/Signature:

---



# *Abstract*

*Entity Linking* is the task of matching a mention to an entity in a given knowledge base (KB). It contributes to annotating a massive amount of documents existing on the Web to harness new facts about their matched entities. However, existing *Entity Linking* systems focus on developing models that are typically domain-dependent and robust only to a particular knowledge base on which they have been trained. The performance is not as adequate when being evaluated on documents and knowledge bases from different domains.

Approaches based on pre-trained language models, such as Wu *et al.* (2020) [1], attempt to solve the problem using a zero-shot setup, illustrating some potential when evaluated on a general-domain KB. Nevertheless, the performance is not equivalent when evaluated on a domain-specific KB. To allow for more accurate *Entity Linking* across different domains, we propose our framework: *Cross-Domain Neural Entity Linking* (CDNEL). Our objective is to have a single system that enables simultaneous linking to both the general-domain KB and the domain-specific KB. CDNEL works by learning a joint representation space for these knowledge bases from different domains. It is evaluated using the external *Entity Linking* dataset (Zeshel) constructed by Logeswaran *et al.* (2019) [2] and the Reddit dataset collected by Botzer *et al.* (2021) [3], to compare our proposed method with the state-of-the-art results. The proposed framework uses different types of datasets for fine-tuning, resulting in different model variants of CDNEL. When evaluated on four domains included in the Zeshel dataset, these variants achieve an average precision gain of 9%.



# *Acknowledgements*

الْحَمْدُ لِلَّهِ حَمْدًا كَثِيرًا طَيِّبًا مُبَارَكًا فِيهِ

This work would not have been possible without the support of many people. Many thanks to my advisors, Dr. Heike Adel, Dr. Mohamed Gad-Elrab, and MSc. Dragan Milchevski, who read my numerous revisions and gave valuable feedback. I am wholeheartedly grateful to them for their great advice and guidance on this Master's thesis. I would like to express my gratitude to Prof. Dr. Dietrich Klakow for giving me the opportunity to work under his supervision. I would like to sincerely thank Dr. Volha Petukhova for offering to review my Master's thesis. I am grateful to the entire Bosch Center for Artificial Intelligence (BCAI) family for their support and encouragement throughout the Master's thesis.

Apart from the Master's thesis, I would like to express my sincere appreciation to Gad for always giving me helpful advice and solutions to the problems I face both on a personal and educational level. He is always willing to share his valuable expertise at all stages of my journey since I moved to Saarbrücken. Working with him, Heike and Dragan helps me learn essential research skills that I believe will significantly help me in my future career. I hope I will have the opportunity to work with them again in the future.

I cannot find words to express how much I am indebted to my mother. She is the backbone of my life. I am grateful to her, my father, my sister Shrouk, my brother Eslam, my uncles and my aunt for their sincere support and prayers throughout my life. Their support is a major factor that has motivated me throughout my long educational journey. I genuinely appreciate that I can always rely on them and that they have so much patience with my constant absence. I would like to sincerely thank my fiancée Zena from the bottom of my heart for always supporting me, especially in difficult times. I am grateful for her patience during the last months.

A heartfelt thanks goes to Nedal who has always motivated me even when we are abroad most of the time. I would like to dedicate special thanks to Abdallah and Magdy for their constant support, both personally and professionally. I would like to thank my second family of friends in Saarbrücken, Adeeb, Afnan, Aleen, Amr, Dalia, Fatima, Mario, Michael, Mostafa, Osama, Taha, Youssef and everyone who is close to me and was always there when I needed their support. I believe I am blessed to be surrounded by all these intelligent, caring and enthusiastic personalities.

Finally, I would like to thank everyone who pledged their support or made dua'a for me.





# Contents

<b>Declaration of Authorship</b>	<b>iii</b>
<b>Abstract</b>	<b>v</b>
<b>Acknowledgements</b>	<b>vii</b>
<b>1 Introduction</b>	<b>1</b>
1.1 Motivation . . . . .	1
1.2 Limitations of the State of the Art . . . . .	2
1.3 Goals of Thesis . . . . .	2
1.4 Research Questions . . . . .	3
1.5 Structure of the Thesis . . . . .	3
<b>2 Background</b>	<b>5</b>
2.1 Entity Linking . . . . .	5
2.2 Neural Entity Linking . . . . .	6
2.3 Generic Example of Neural Entity Linking . . . . .	6
2.4 Sequence Modeling based on Transformers . . . . .	8
2.5 Bi-Encoder and Cross-Encoder Architecture . . . . .	9
<b>3 Related Work</b>	<b>11</b>
3.1 Entity linking with Neural Attention . . . . .	11
3.2 Large-scale Language Models Pre-training for Entity Linking . . . . .	12
3.3 Linking to KBs with Arbitrary Schemas . . . . .	13
3.4 Zero-Shot Entity Linking . . . . .	16
<b>4 Datasets</b>	<b>21</b>
4.1 Dataset Gathering . . . . .	21
4.1.1 Zeshel . . . . .	21
4.1.2 Cybersecurity . . . . .	23
4.2 Dataset Augmentation . . . . .	25
4.2.1 Reddit . . . . .	25

<b>5</b>	<b>Methodology</b>	<b>27</b>
5.1	BLINK . . . . .	27
5.1.1	Candidate Generation Phase . . . . .	28
5.1.2	Candidate Ranking Phase . . . . .	29
5.2	CDNEL . . . . .	30
5.2.1	Proposed Modifications . . . . .	31
5.2.2	Model Variants . . . . .	34
5.2.3	Summary . . . . .	36
<b>6</b>	<b>Experimental Evaluation</b>	<b>37</b>
6.1	Experimental Setup . . . . .	37
6.1.1	Model Configurations . . . . .	37
6.1.2	Evaluation Metrics . . . . .	39
6.2	Experiments and Results . . . . .	40
6.2.1	Fine-tuning on Mentions Annotated on the Domain-specific KB . . . . .	40
6.2.2	Overfitting of the Fine-tuned Models to the Domain-specific KB . . . . .	42
6.2.3	Mentions Qualitative Assessment . . . . .	44
6.2.4	Intrinsic Evaluation of Embeddings . . . . .	46
6.3	Analysis . . . . .	48
6.3.1	Fine-tuning on Mentions Annotated on a Mixed-domain KB . . . . .	48
6.3.2	Fine-tuning on Mentions Annotated on both Domains . . . . .	49
<b>7</b>	<b>Conclusion</b>	<b>51</b>
7.1	Summary . . . . .	51
7.2	Future Work . . . . .	53
	<b>List of Figures</b>	<b>55</b>
	<b>List of Tables</b>	<b>57</b>
	<b>Bibliography</b>	<b>59</b>

*Dedicated to my uncle **Hassan Elshrief**, who is no longer with us.  
He will always be in my heart. I will never forget how much he  
helped me in my life. He is one of the main reasons I could do this  
Master's in Germany. May Allah have mercy on his soul.*



---

# CHAPTER 1

## INTRODUCTION

---

### 1.1 Motivation

*Entity Linking* can be defined as the process of matching a mention, e.g., “Paris” in a textual context, e.g., “Paris is a famous American singer and actress, who is born in New York City” with a record (i.e., entity) in a knowledge base (KB) (e.g., “Paris Hilton”) that fits the surrounding context.

Since 2016, various neural systems have addressed the problem of Entity Linking due to the *Deep Learning* revolution in *Natural Language Processing* (NLP). It has recently gained popularity due to the extensive capabilities of neural models in information extraction and semantic text understanding, as noted by Sevgili *et al.* (2021) [4].

*Neural Entity Linking* models often consist of two main components: 1) *Candidate Generation* module, which acts as a staging step to generate candidate entities similar to a given mention in context. 2) *Candidate Ranking* module, which acts as a ranking system to rank these candidates according to their similarity to the input mention.

*Neural Entity Linking* systems need to be trained on annotated documents with entities from different KBs. In most cases, these systems are trained on a single general-domain KB such as Wikipedia, and it is assumed that they can be generalized to entities from a domain-specific KB, as explained by Wu *et al.* (2020) [1].

The problem is that mentions in domain-specific documents cannot be linked to entities from a general domain KB. More specifically, using the general-domain KB is insufficient to understand and analyze documents with domain-specific entities because domain-specific documents may contain entities that do not yet exist in the general-domain KB. This problem led to the necessity of training models for *Entity Linking* to domain-specific KBs. In the same regard, it is not sufficient to use the domain-specific KB alone.

Therefore, it is essential to develop approaches that can simultaneously link to entities from multiple KBs of different domains.

## 1.2 Limitations of the State of the Art

Recent approaches work well on general-domain documents such as general news, as shown in Logeswaran *et al.* (2019) [2], Wu *et al.* (2020) [1] and Vyas and Ballesteros (2020) [5]. However, their performance in terms of end-to-end accuracy is not as adequate when evaluated on domain-specific documents (unseen entities from a new KB). It is a challenge for them to be enriched with domain-specific knowledge.

Other previous entity linking systems such as AIDA by Hoffart *et al.* (2011) [6] and Wikify by Mihalcea and Csomai (2007) [7] could not handle out-of-KB entities. The lack of domain-specific entities in their KB caused these models to perform poorly, as noted by Hamaguchi *et al.* (2018) [8].

## 1.3 Goals of Thesis

The main goal of this work is to provide a domain-agnostic *Entity Linking* (which can be easily extended to new domains by adding new KB) using neural models. It can also leverage the power of fine-tuning pre-trained language models and context-aware embeddings for all relevant text processing parts. Our goal is to develop an approach trained to link two (multiple) KBs simultaneously. The provided method should overcome the following challenges:

- **Merging of KBs:** We aim at learning a new representation space that can represent entities from two or more KBs, allowing them to be directly compared to a given input.
- **Alignment of Entities:** When combining two or more knowledge bases, entities may be identical (overlapping). Therefore, these overlapping entities have similar representations.
- **Overfitting to domain-specific KB:** Fine-tuned language models are likely to overfit to the domain-specific KB, especially if these new domains have a small dataset of annotated mentions.

## 1.4 Research Questions

Building systems that link to multiple knowledge bases presents many scientific and technical challenges. This thesis aims to address and answer the following research questions:

- **RQ1:** How can we use pre-trained language models to merge entities from multiple KBs?
- **RQ2:** How can we extract and exploit overlapping entities in the alignment of entities?
- **RQ3:** To what extent does fine-tuning on domain-specific datasets affect the results of simultaneous *Entity Linking*?
- **RQ4:** Can we use data augmentation to reduce the overfitting of the fine-tuned models to the domain-specific KB?

## 1.5 Structure of the Thesis

The Master thesis work is organized as follows: The second chapter briefly reviews the history of *Entity Linking* and shows how it has evolved in recent years, with an example of modern techniques. In Chapter 3, we take a closer look at neural approaches that combine multiple KBs. In Chapter 4, we describe the dataset used in the fine-tuning process and the various statistics they exhibit. We also introduce a dataset that we plan to use for data augmentation.

In Chapter 5, we propose different approaches to extend the base model with a domain-specific KB. In Chapter 6, we present a description of the experimental setup as well as the results of the conducted experiments. We also provide a detailed analysis of the outcome. The experiments aim to evaluate the extensibility of the base model with a new domain-specific KB through fine-tuning. In Chapter 7, we summarize the approaches and contributions proposed in this Master thesis and discuss possible areas for future work.





---

## CHAPTER 2

# BACKGROUND

---

This chapter presents the history of *Entity Linking* and its effective approaches. In addition, *Neural Entity Linking* is explained with an example of a state-of-the-art method.

### 2.1 Entity Linking

The *Entity Linking* task has been addressed by numerous approaches before Deep Learning took on the problem. Graph-based techniques were predominant, such as AIDA by Hoffart *et al.* (2011) [6], which depends on a weighted graph of a mention and candidate entities to obtain the best mention-entity mapping, as shown in Figure 2.1. DBpedia Spotlight is another work by Mendes *et al.* (2011) [9] that depends on the prior probabilities between mentions and entities, usually represented by the number of times the mention is used to link the entity. WAT from Piccinno *et al.* (2014) [10] uses voting algorithms in addition to building the mention-entity graph. Babelfy by Moro *et al.* (2014) [11] uses a unified graph-based approach between entity linking and word sense disambiguation. PBOH is another work by Ganea *et al.* (2016) [12], in which input mentions are jointly and collectively linked across an entire document using an effective graphical model.

Various publicly available datasets and annotated corpora are typically used to evaluate entity linking systems such as AIDA by Hoffart *et al.* (2011) [6], TAC KBP 2010 by Ji *et al.* (2010) [13], KORE-50 by Hoffart *et al.* (2011) [14], ACE2004 by Ratnov *et al.* (2011) [15], and MSNBC by Cucerzan (2010) [13].

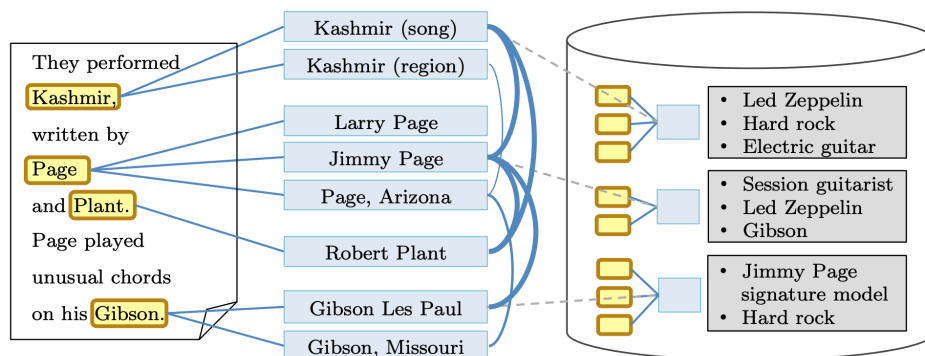

FIGURE 2.1: Mention-entity graph example by Hoffart *et al.* (2011) [6].

## 2.2 Neural Entity Linking

A *Neural Entity Linking* (NEL) system solves the task of *Entity Linking* using neural methods. They depend heavily on neural networks' robust representation learning capabilities through solid encoder architectures. An example work by Eshel *et al.* (2017) [16] that uses GRU plus attention to encode the left and right context of a mention. Kolitsas *et al.* (2018) [17] uses pre-trained Word2Vec vectors by Mikolov *et al.* (2013) [18] as word embeddings and uses a bidirectional LSTM on top of these embeddings to obtain context-aware word embeddings for the input mention with context, as shown in Figure 2.2.

Since 2019, numerous works have used the BERT model by Devlin *et al.* (2019) [19] to obtain contextualized embeddings of mention context and entities, as Broscheit *et al.* (2019) [20], Logeswaran *et al.* (2019) [2], and Wu *et al.* (2020) [1].

## 2.3 Generic Example of Neural Entity Linking

A general example of NEL systems is previously shown in Figure 2.2. It assumes that the input text contains mentions that have already been recognized. The role of this system is to link the recognized mentions to the correct and relevant entities from a given knowledge base, using the power of neural networks.

Figure 2.3 shows the general components of the complete NEL system. The input text example “Paris is a famous American singer and actress, who is born in New York City” is encoded in a vector space, along with each entity in a given knowledge base, e.g., Paris Hilton. This vector space is used in the *Candidate Generation* module. The similarity between the input and each of the entities is computed. Based on this similarity, relevant entities are retrieved and serve as candidate entities further explored by the

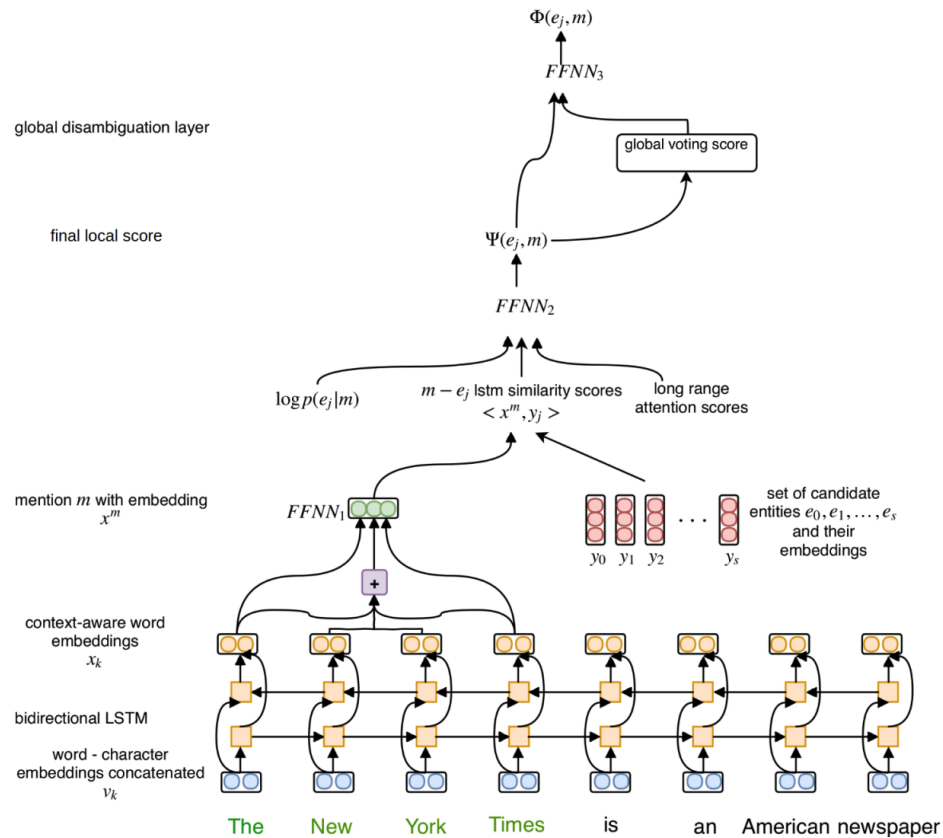
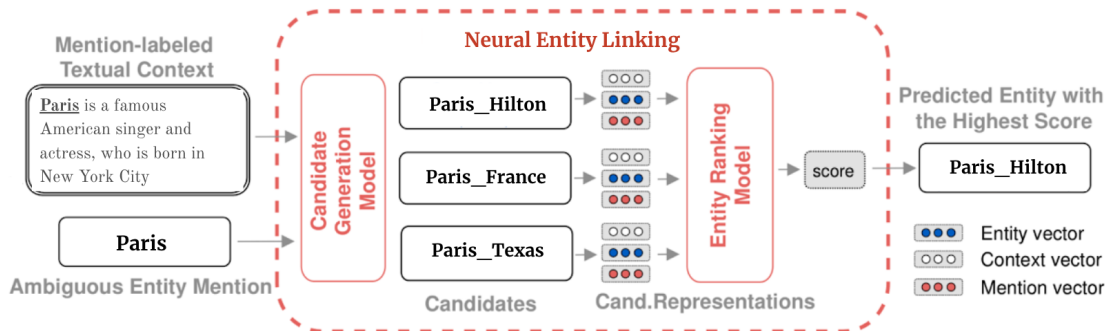
FIGURE 2.2: Model architecture adopted by Kolitsas *et al.* (2018) [17].FIGURE 2.3: General architecture for a *Neural Entity Linking* system as stated by Sevgili *et al.* (2021) [4].

following module. The main objective of the *Candidate Ranking* module is to learn the joint context between the input mention and each of the candidate entities. It assigns a score indicating how similar the input is to each candidate entity. Based on these scores, a ranking of these entities is performed. The highest score is given to the correct (gold) entity “Paris Hilton”.

## 2.4 Sequence Modeling based on Transformers

An essential aspect of NEL is the representation of vectors and modeling sequences. Although this vectorization can be achieved in several ways, we are concerned with transformer-based language models since they can provide rich representations in the form of embeddings.

Practical approaches rely on the *Transformer* architecture by Vaswani *et al.* (2017) [21] due to its power in sequence modeling using the *Multi-head Attention Mechanism*, as shown in Figure 2.4. Accordingly, large-scale language models such as BERT by Devlin *et al.* (2019) [19] used the encoder architecture employed by the *Transformer* model to implement a robust semantic text understanding system that depends on the context provided.

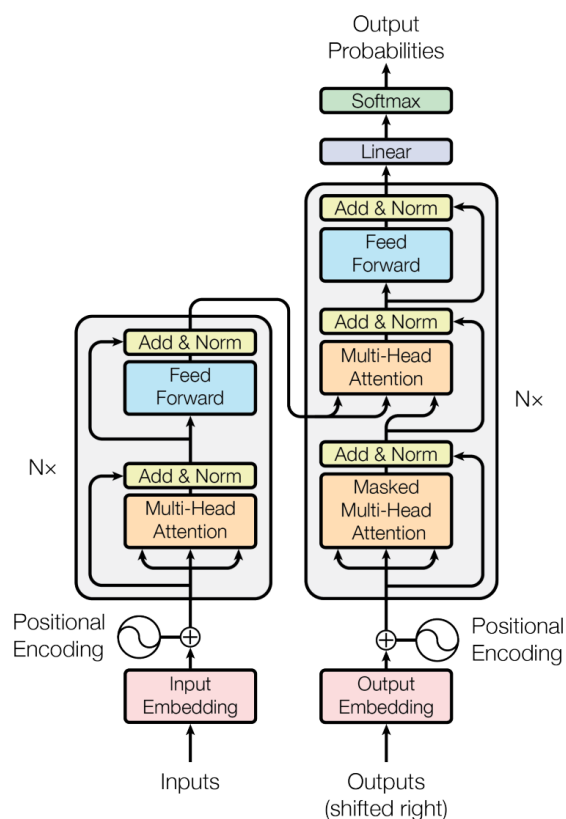

FIGURE 2.4: Encoder and decoder architectures constituting the *Transformer* model by Vaswani *et al.* (2017) [21].

The BERT architecture provides a transfer learning mechanism by pre-training on massive general-domain documents using masked language modeling and next sentence prediction objectives, as shown in Figure 2.5. This system can understand and encode text into a rich representation space. Semantic knowledge about the tokens in the input text is incorporated into these encodings (embeddings). This encoder-based architecture can

be used to obtain the similarity between a given input mention and the various entities in the knowledge base to generate candidate entities, as shown in Figure 2.6.

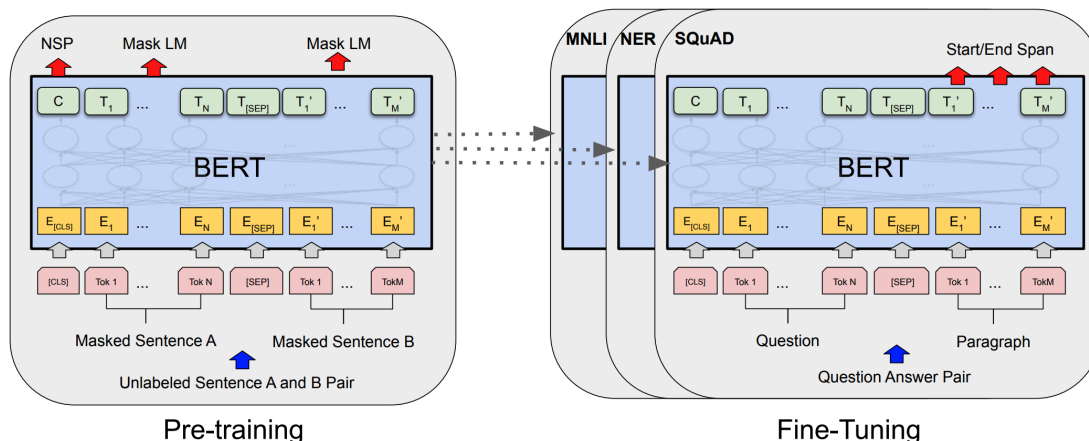

FIGURE 2.5: Pre-training and fine-tuning of BERT model by Devlin *et al.* (2019) [19].

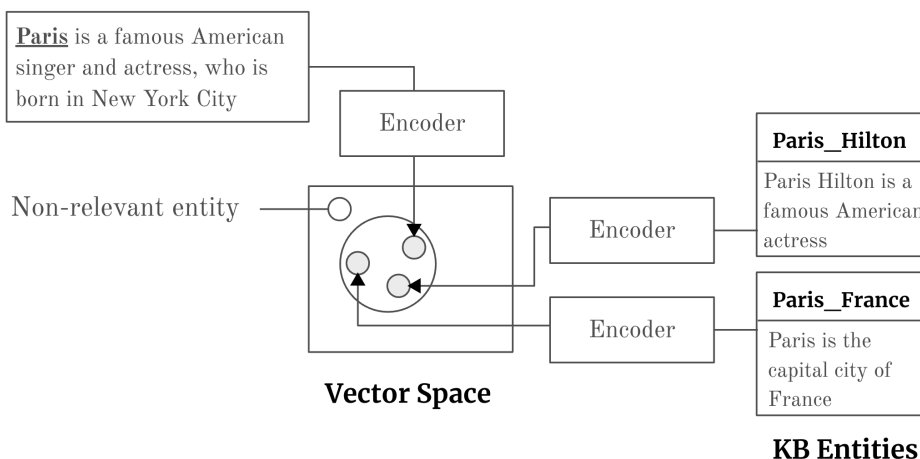

FIGURE 2.6: A simplified example of the representation space of an input mention and various entities in a KB, which can be used in the *Candidate Generation* phase.

## 2.5 Bi-Encoder and Cross-Encoder Architecture

A *Bi-Encoder* is based on two model parts, e.g., two BERT models. Each can encode sentences in a textual format. One model part is for encoding an input mention in a textual context. The other is for encoding entities in a KB with a textual description. Semantic knowledge about a particular sentence (input mention or entity description) is incorporated into these encodings (embeddings). This architecture proves robust in semantic search, as it can recognize synonyms and spelling variations, as stated by Reimers and Gurevych (2019) [22]. As shown in Figure 2.7, the similarity between any two sentences can be measured between their encodings using a similarity metric, such as *Dot Product* or *Cosine Similarity*.

On the other hand, *Cross-Encoder* is based on a single model part, e.g., the BERT model. It takes two sentences simultaneously as input (input mention and entity description) and produces a single score indicating how similar they are. It is more complex than the *Bi-Encoder* because it performs attention across the two concatenated sentences. However, it takes more time to be trained. It can give an output score between 0 and 1, representing the similarity between the input mention with each of the generated candidate entities.

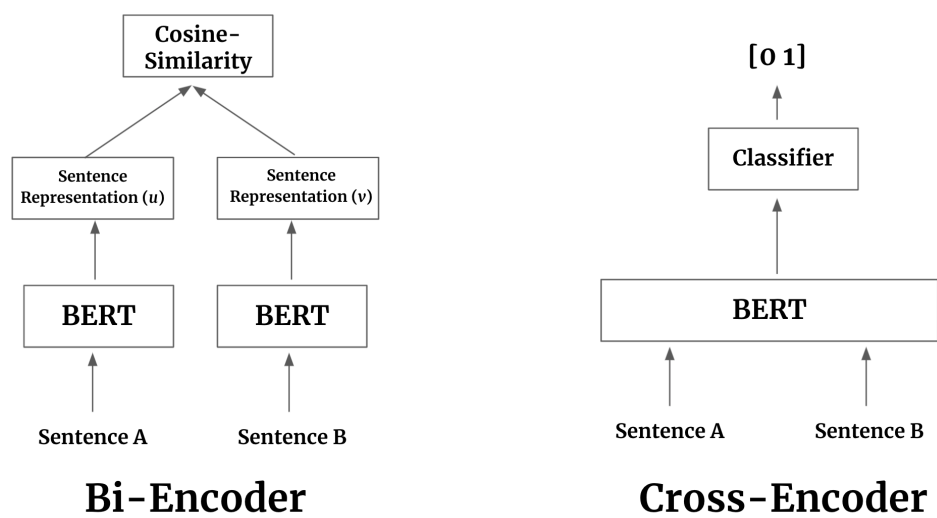

FIGURE 2.7: Difference between *Bi-Encoder* and *Cross-Encoder* architectures.

The *Bi-Encoder* is used in the *Candidate Generation* module. The input mention is encoded by one of the two encoders of the *Bi-Encoder*, while the other encoder encodes the entity descriptions in a given KB. The 100 or  $k$  (hyperparameter) entity embeddings most similar to the input embedding are retrieved and serve as candidate entities.

The *Cross-Encoder* is used in the *Candidate Ranking* module by concatenating the input mention with the description of each candidate entity. It generates an embedding for these concatenated sentences. A classification layer on the top takes this embedding as input and gives an output score for each candidate entity. Based on these scores, a final ranking of the similarity of these entities to the given input mention is performed. The highest score is given to the correct (gold) entity.

---

## CHAPTER 3

# RELATED WORK

---

This chapter looks at the neural entity linking approaches that inspired our work, focusing on neural methods in the literature that address generalization to different domains within the same system.

It is important to point out that for each approach, we state its limitations and constraints that do not restrict our methodology.

### 3.1 Entity linking with Neural Attention

One of the early works that used the attention mechanism is Deep Joint Entity Disambiguation with Local Neural Attention by Ganea and Hofmann (2017) [23], as shown in Figure 3.1, and it inspired the other models in this section.

The approach takes as input the context word embeddings for the mention, in addition to the candidate entity embeddings and the mention-entity priors. The output is a score for each candidate entity and context pair. At this point, they obtained state-of-the-art results with moderate computational cost.

A limitation of this work is that they use information from mention-entity priors in their final computed scores.

Other work comes from Onoe and Durrett (2020) [24], who use information about fine-grained entity types when linking mentions. Their approach models fine-grained entity properties, as shown in Figure 3.2.

The entity typing model computes a binary probability representing the membership of an input mention to each type. The final decision is based on summing these probabilities for each candidate entity. Thanks to this technique, they state that their *Entity Linking*

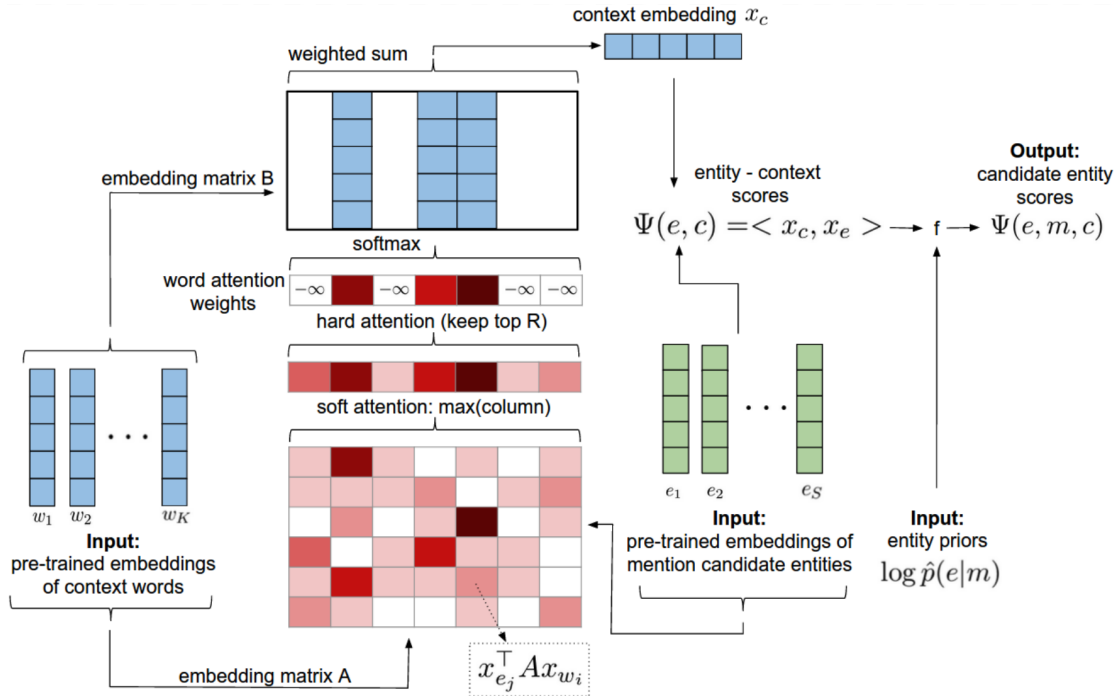

FIGURE 3.1: Local neural attention mechanism deployed by Ganea and Hofmann (2017) [23].

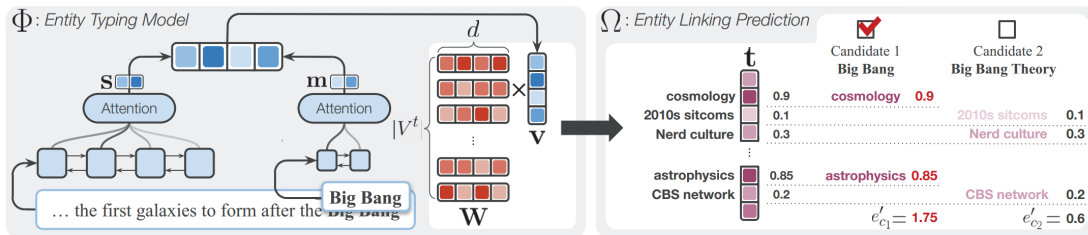

FIGURE 3.2: Entity type prediction model for *Entity Linking* by Onoe and Durett (2020) [24].

model can be effectively generalized to other domains. However, their work is limited because they need to include entity type information in the *Candidate Generation* step.

The work by Peters *et al.* (2019) [25] also falls into this category and is discussed in more detail in the next section.

### 3.2 Large-scale Language Models Pre-training for Entity Linking

This section looks in depth at approaches that attempt to incorporate large-scale language models into the task of *Entity Linking*. One example is the work by Peters *et al.* (2019) [25]. They propose a general method for embedding multiple knowledge bases



into the BERT model to improve its contextual word representation. The result is the knowledge-enhanced BERT (KnowBERT), as shown in Figure 3.3.

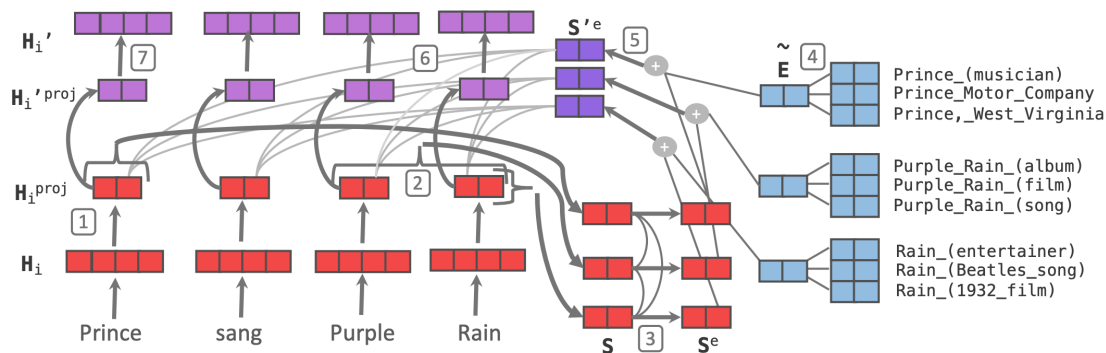

FIGURE 3.3: Enhancing the mention-span representations with knowledge from the KB using word-to-entity-span attention by Peters *et al.* (2019) [25].

For an input mention, its representation is modeled by pooling over word tokens in its span. In addition, a self-attention block is deployed over all mention representations so that it can encode the interactions between several entities in a sentence.

It is constrained by using a pre-built index of entities (alias table) to match the mention span for the *Candidate Generation* step.

Another method based on fine-tuned BERT architecture is presented by Humeau *et al.* (2019) [26]. It generates candidates using a *Poly-Encoder* that learns global self-attention features. As shown in Figure 3.4, they have conducted additional experiments using *Bi-Encoder* and *Cross-Encoder* architectures.

The *Poly-Encoder* not only allows caching of candidate representations like the *Bi-Encoder*, but also adds an attention mechanism for global input features and a given candidate entity to allow richer interactions as in the *Cross-Encoder*.

The base model we use by Wu *et al.* (2020) [1], which is explained in detail in Section 3.4, states that the *Bi-Encoder* can be a solid model for retrieval. Using the *Bi-Encoder* in combination with the *Cross-Encoder* is sufficient for the *Entity Linking* task.

Another work that fits into this category is the work by Logeswaran *et al.* (2019) [2]. It is presented in more detail in Section 3.4.

### 3.3 Linking to KBs with Arbitrary Schemas

Various methods have been studied in the literature based on learning a single representation space for available types of entity information. In this context, Gupta *et al.*

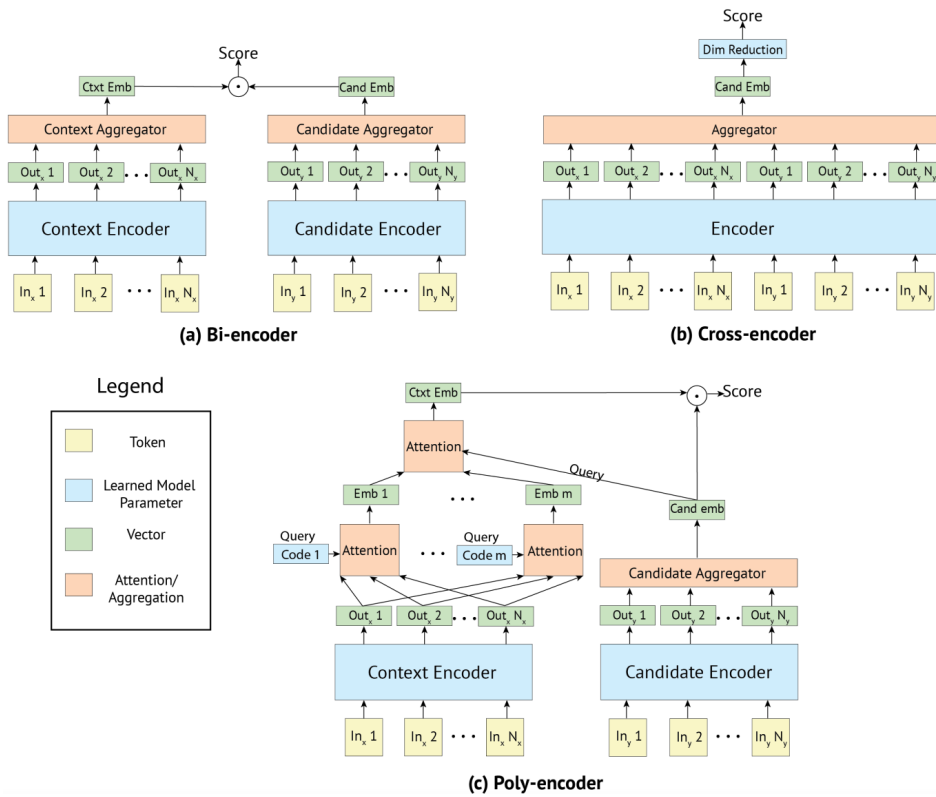

FIGURE 3.4: Three encoder architectures investigated by Humeau *et al.* (2019) [26].

(2017) [27] proposed a neural system for *Entity Linking*. The system learns a dense and unified representation for each entity by using multiple sources of information, such as its description, contexts around its mentions, and its fine-grained types, as shown in Figure 3.5.

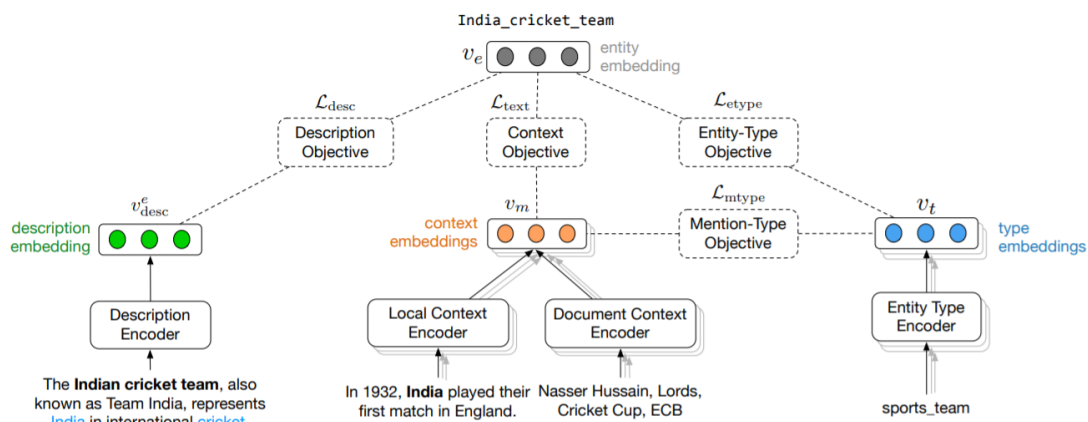

FIGURE 3.5: Encoding different sources of information provided for an entity by Gupta *et al.* (2017) [27].

Encoders for different sources of information about an entity are introduced and optimized so that the final embedding of the entity is similar to all encoded representations.

However, this work is limited by the quality of the LSTM cells. They used bidirectional LSTMs in their encoders, which are less effective at sequence modeling than the BERT model.

Another work is by Gillick *et al.* (2019) [28], which is one of the early methods to use dense embeddings and *Cosine Similarity* to compare entity representations for the *Candidate Generation* step. It included an encoder for fine-grained entity types (Wikipedia category labels), as shown in Figure 3.6.

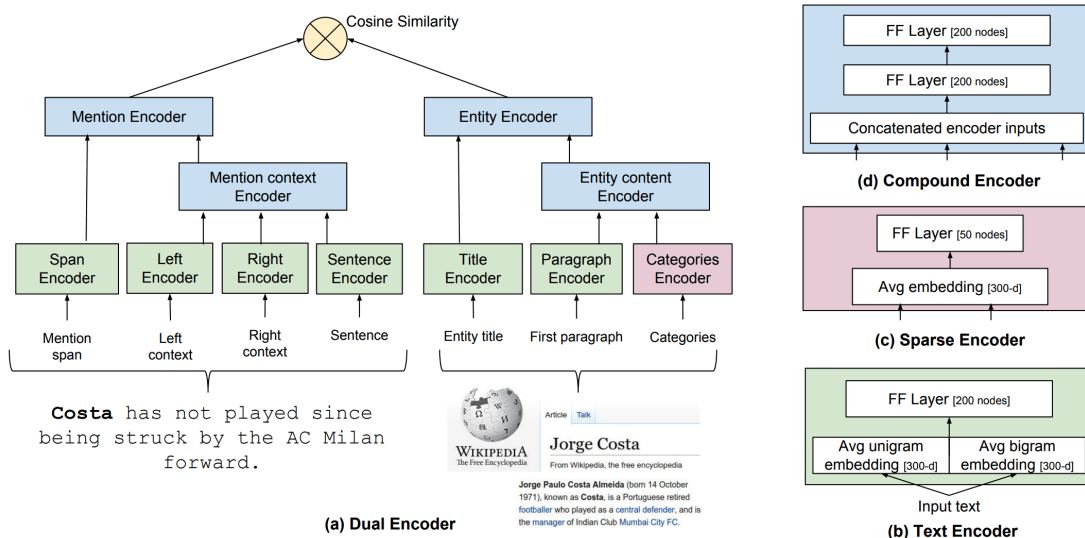

FIGURE 3.6: Dual encoder architecture deployed by Gillick *et al.* (2019) [28].

The method uses average unigram and bigram embeddings followed by dense layers to obtain representations of mentions and descriptions. They state that their model generalizes to a new dataset derived from Wikinews. Their work is limited by including information from category labels, and they do not use an attention mechanism between mentions and entities.

Another work by Vias and Ballesteros (2020) [5] is based on the work by Wu *et al.* (2020) [1] and Logeswaran *et al.* (2019) [2], but they generalize these models and allow them to handle arbitrary KBs containing entities represented by an arbitrary set of attribute-value pairs.

The generalization is based on converting entities from arbitrary KB with several attribute-value pairs (relational information) into a string representation that the previously mentioned models can use. They find that these models, based on large-scale pre-trained language models, e.g., the BERT model, can generalize to linking mentions to unseen entities, including those for which no textual descriptions are available.

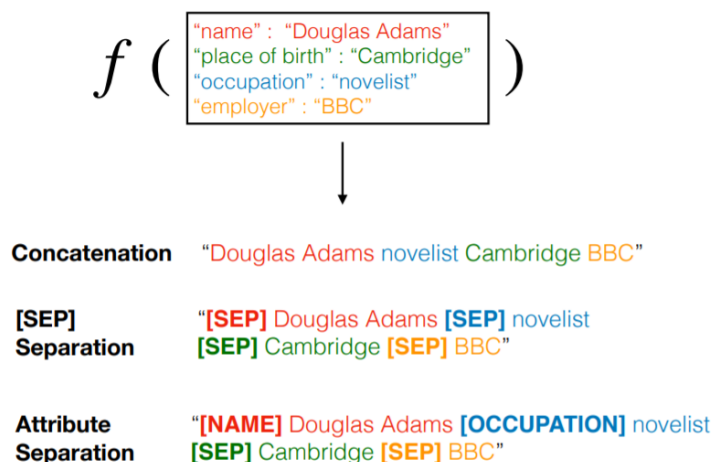

FIGURE 3.7: Three different ways to represent an entity with arbitrary attribute-values by Vias and Ballesteros (2020) [5].

One way to convert attribute-value pairs into a string is to add special tokens called attribute separators to these string representations, as shown in Figure 3.7. These tokens are used to represent frequently occurring attributes in the KB. They also generate more flexible string representations by shuffling entity attributes before converting them to strings. They randomly remove attribute separators to improve the generalization to unseen attributes.

However, the results obtained with unseen entities of a KB with attribute-value pairs are not the same quality as those obtained when the unseen entities have textual descriptions instead. In addition, their work does not learn to encode entities with textual descriptions from multiple domains in the same representation space.

### 3.4 Zero-Shot Entity Linking

Based on the survey by Sevgili *et al.* (2021) [4], there is a surge of models that address the problem of extension of knowledge bases of new domains in a zero-shot fashion. Zero-shot learning in the context of *Entity Linking* means that entities from a new KB do not appear in the training set. The basic idea is to train the system on a domain with rich labeled data (general-domain KB). During the inference time, the entities of the domain-specific KB are encoded without re-training the model.

In this regard, a work by Logeswaran *et al.* (2019) [2] presents an effective domain-adaptive pre-training (DAP) to solve the domain shift problem associated with linking to unseen entities of a new domain. Their experiments show that their model is robust when linking mentions to entities from specialized domains such as legal cases or company project descriptions.

The authors propose a new zero-shot *Entity Linking* task and construct a new dataset, as shown in Figure 3.8. They construct the dataset using multiple subdomains in Fandom<sup>1</sup>, and automatically extract labeled mentions using hyperlinks.

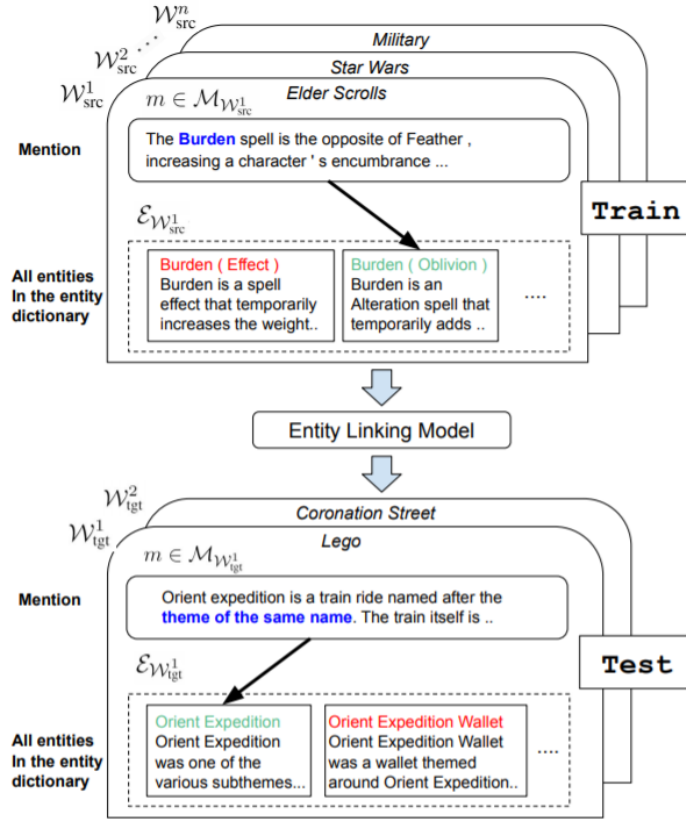

FIGURE 3.8: Multiple training and test domains, and the extraction of labelled mentions using hyper-links by Logeswaran *et al.* (2019) [2].

They use a domain-adaptive pre-training strategy. The model undergoes unsupervised pre-training on the target-domain data only ( $U_{tgt}$ ), followed by a final fine-tuning phase on the labeled source-domain data ( $F_{src}$ ). The intuition behind this is that the representation capacity is limited, so models should prioritize the quality of representation of the target domain.

Any series of pre-training stages can be chained. For example,

$$U_{WB} \longrightarrow U_{src+tgt} \longrightarrow U_{tgt} \longrightarrow F_{src}$$

which means that the model is first pre-trained on the open corpus, which is a combination of Wikipedia and the BookCorpus datasets used in BERT, then pre-trained on the combined source (src) and target (tgt) domains, then pre-trained on the target-domain

<sup>1</sup>Fandom, <https://www.fandom.com>.

<sup>1</sup>Fandom, <https://www.fandom.com>.

data only, and finally fine-tuned on the source-domain labeled data. Their methodology is limited by the use of BM25, a variation of TF-IDF, in their *Candidate Generation* step.

Wu *et al.* (2020) [1] proposes another approach (BLINK) based on the previous work by Logeswaran *et al.* (2019) [2], but they do not use domain-adaptive pre-training. It is a complete domain-independent approach trained only on labeled data from a general domain, e.g., Wikipedia. They show that models based on BERT reach new peaks in large-scale *Entity Linking* when used in a zero-shot setup. They present a two-stage zero-shot algorithm for *Entity Linking* based on fine-tuning BERT architecture, where a short textual description defines each entity. They trained the model on annotated data containing mentions corresponding to entities from the general-domain KB (Wikipedia).

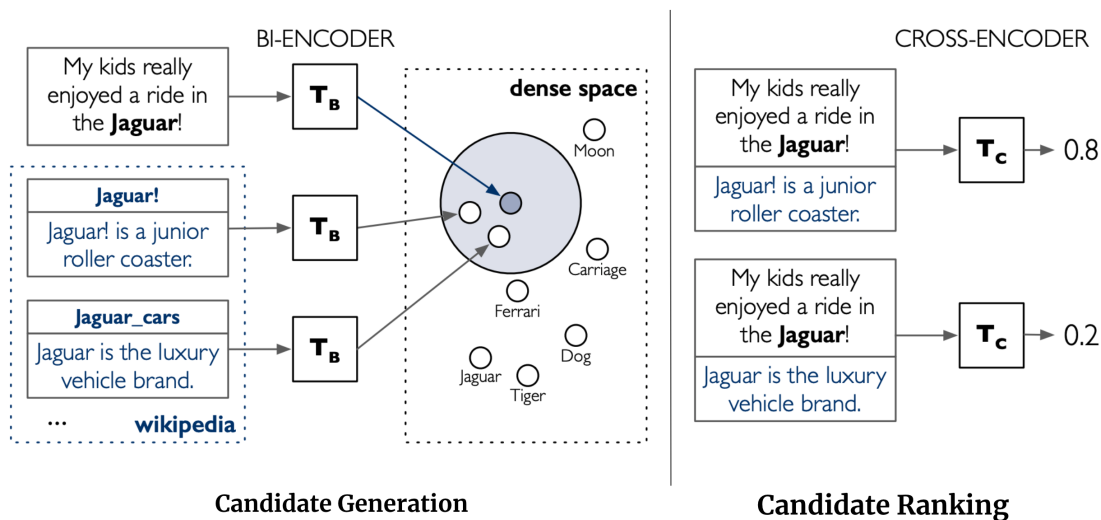

FIGURE 3.9: Full pipeline for the *Bi-Encoder* and *Cross-Encoder* architecture adopted by Wu *et al.* (2020) [1].

They use the *Bi-Encoder* and *Cross-Encoder* architecture, as shown in Figure 3.9. In the first stage, candidates are generated in a dense space defined by a *Bi-Encoder* (two encoders) that embeds the mention context and entity descriptions independently. Each candidate entity is then re-ranked with a *Cross-Encoder* that takes as input a concatenation of the textual context of a mention and the textual description of each of these candidate entities.

To extend their model to include entities from a new domain-specific KB, they do the following:-

- They assume having a single vector space trained on a general-domain KB and is used directly on a domain-specific KB without re-training.

- At the inference time, they encode only the new entities of the domain-specific KB in this single vector space.
- Although the *Bi-Encoder* has not seen or trained on these entities before, it models them in the vector space.
- They rely on the performance of the *Bi-Encoder* to include the domain-specific entities in the single vector space of the general domain without additional training of the model.

However, they do not incorporate the information from the overlapping entities between the general-domain KB (Wikipedia) and domain-specific KB in their alignment in the single vector space.

Our methodology is based on the work by Wu *et al.* (2020) [1]. We build on their model using more variants as described later in Chapter 5.





---

## CHAPTER 4

# DATASETS

---

The proposed approach assumes a general-domain dataset, with mentions extracted from Wikipedia articles and annotated on Wikipedia entities. We aim to search for domain-specific datasets, including mentions extracted from domain-specific articles and annotated on domain-specific entities.

This chapter shows the datasets used in the fine-tuning process and their different statistics. We also introduce a dataset that we propose to use for data augmentation.

### 4.1 Dataset Gathering

This section presents several datasets that serve as domain-specific datasets, which will be used to fine-tune and evaluate the proposed method.

#### 4.1.1 Zeshel

The zero-shot entity linking dataset (Zeshel) is constructed by Logeswaran *et al.* (2019) [2] from Fandom<sup>1</sup>. It contains multiple worlds (domains). For each domain, there are entities with textual descriptions and labeled mentions extracted from articles about that domain. The number of entities and the division of mentions into training, validation, and evaluation sets are shown in Table 4.1.

The fine-tuning and evaluation of the proposed approach are done separately for each domain. Training and validation sets are used for fine-tuning, while the approach is evaluated using the evaluation set.

---

<sup>1</sup>Fandom, <https://www.fandom.com>.

<sup>1</sup>Fandom, <https://www.fandom.com>.

Domain	Entities	Mentions		Evaluation
		Fine-tuning		
		Training	Validation	
<i>American Football</i>	31929	3000	320	578
<i>Doctor Who</i>	40281	6360	640	1334
<i>Fallout</i>	16992	2500	320	466
<i>Final Fantasy</i>	14044	4360	640	1041

TABLE 4.1: Different Fandom domains used in the fine-tuning and evaluation of the proposed approach

These domains are used separately to extend the general-domain KB (Wikipedia). This extension is consistent with our goal of having a single model that can simultaneously link to multiple domains.

### Overlapping Entities

The overlapping entities between each domain and the general-domain KB (Wikipedia) are needed to align them explicitly through a similar representation. Since Zeshel does not contain overlapping entities, we propose to extract pairs of entities with the same title between both domains as a first step. We will refer to them as “fuzzy overlapping entities”.

This fuzzy extraction based on the title is done because it is impossible to compare all available pairs manually. The general-domain KB (Wikipedia) has 5903538 entities, and each of the domain-specific KBs has on average around 20000 entities. The number of possible pairwise comparisons is enormous.

As a second step, to check whether the extracted fuzzy overlapping entities are semantically similar, we propose to use a *Sentence-Transformer* model (Roberta-large) by Reimers *et al.* (2019) [22], which is the best-performing model according to the *Semantic Text Similarity* (STS) benchmark by Cer *et al.* (2017) [29].

For each entity pair in the fuzzy overlapping entities, the textual description of each entity in the pair is given to the *Sentence-Transformer* model, which provides an output vector representation. The two representations of the pair of entities are compared based on *Cosine Similarity*. This comparison is performed for all pairs, and their average similarity scores for each domain can be viewed in Table 4.2.

A threshold is set and tested by sampling pairs whose similarity value is above this threshold. These pairs are manually checked to verify their semantic similarity. The number of these filtered similar overlapping entities can be found in Table 4.3.

Domain	Fuzzy Overlapping Entities	Cosine Similarity		
		Max	Average	Min
<i>American Football</i>	24074	0.9965	0.8313	-0.1306
<i>Doctor Who</i>	10458	0.9284	0.4135	-0.2777
<i>Fallout</i>	2876	0.9855	0.3913	-0.1835
<i>Final Fantasy</i>	1495	0.9934	0.4047	-0.2060

TABLE 4.2: *Average Cosine Similarity* measures for the fuzzy overlapping entities for each domain

Domain	Fuzzy Overlapping Entities (Title Exact Matching)	Similar Overlapping Entities (Descriptions Semantic Matching)
<i>American Football</i>	24074	22928
<i>Doctor Who</i>	10458	3611
<i>Fallout</i>	2876	752
<i>Final Fantasy</i>	1495	413

TABLE 4.3: Filtered similar overlapping entities for each domain in Fandom

These filtered similar overlapping entities between each domain-specific KB and the general-domain KB (Wikipedia) are used in the fine-tuning process to explicitly modify their vector representations to be more similar in the single vector space.

### 4.1.2 Cybersecurity

The dataset for this domain consists of ten *Cybersecurity* documents annotated by a modified version of AIDA by Hoffart *et al.* (2011) [6] extended with the *Cybersecurity* domain. From these documents, 1755 mentions are extracted. They are annotated on both *Cybersecurity* (domain-specific KB) based on Mitre Attack<sup>2</sup> and Wikipedia (general-domain KB). Mitre Attack is a globally accessible knowledge base of adversary tactics and techniques based on real-world observations. To prepare a training dataset for fine-tuning, we divided the documents into nine documents for fine-tuning and one for evaluation.

To obtain silver ground truth annotations for the mentions in the nine documents, we annotated them on *Cybersecurity* (domain-specific KB) and Wikipedia (general-domain KB) using the BLINK model by Wu *et al.* (2020) [1]. We then extracted the mentions where the models BLINK and modified AIDA match in their annotations. There are 710 mentions agreed on by both systems. We consider these mentions as silver ground truth annotations used for fine-tuning. The number of entities in each domain and the

<sup>2</sup>Mitre Attack, <https://attack.mitre.org/>.

<sup>2</sup>Mitre Attack, <https://attack.mitre.org/>.

Domain	Entities	Mentions		
		Fine-tuning		Evaluation
		Training	Validation	
Wikipedia	5903538	331	38	94
Cybersecurity	1183	315	26	51

TABLE 4.4: *Cybersecurity* domain used in the fine-tuning and evaluation of the proposed approach

breakdown of mentions into training, validation, and evaluation sets are shown in Table 4.4.

We created a gold ground-truth standard for the left-out document for evaluation through manual annotation. The resulting evaluation set includes 145 mentions. Manual annotation is performed using the Inception annotation interface from Klie *et al.* (2018) [30] as shown in Figure 4.1.

6	Malware) analysis Copyright©2015 JPCERT / CC All rights reserved.	(NamEnt...)	(NamEnt...)
7	Targeted Attacks handled by JPCERT/CC 5 From April to September 2015 93組織 4組織 130 organizations 93 organizations 4 organizations Operation A Operation B Copyright©2015 JPCERT/CC All rights reserved.	(NamEnt...)	
8	Introducing 2 Types of Attack Operations • Targeting many Japanese organizations since around 2012		Q47464448
9	.		
10	• Emdivi • CloudyOmega ( Symantec ) • BLUE TERMITE (Kaspersky) Operation A • Targeting some Japanese organizations since around 2013	Error: ERROR (Blue Termite)	Error: ERROR (Blue Termite)

FIGURE 4.1: *Cybersecurity* document manual annotation by Inception.

## Overlapping Entities

To extract the overlapping entities between *Cybersecurity* (domain-specific KB) and Wikipedia (general-domain KB), Wikidata Query Service<sup>3</sup> is used, which has a mapping between Wikidata entity ID and Mitre Attack entity ID. Each ID is an identifier for an entity in Wikidata and Mitre Attack KBs, respectively. The entities that have an entry in this mapping are extracted, and their Wikidata ID is converted to the corresponding Wikipedia ID. Only 44 entities have an entry in this mapping, and they act as overlapping entities between the two domains.

<sup>3</sup>Wikidata Query Service, <https://query.wikidata.org/>.

<sup>3</sup>Wikidata Query Service, <https://query.wikidata.org/>.

Domain	Entities	Mentions		
		Fine-tuning		Evaluation
		Training	Validation	
Reddit	5903538	7711	409	1328

TABLE 4.5: Reddit dataset used in the fine-tuning and evaluation of the proposed approach

## 4.2 Dataset Augmentation

In this section, we present the use of data augmentation to provide additional mentions for fine-tuning to reduce overfitting to the domain-specific KBs from the Zeshel dataset.

### 4.2.1 Reddit

The Reddit mentions dataset is constructed by Botzer *et al.* (2021) [3]. These are mentions extracted from Reddit posts and comments by Reddit users and annotated on Wikipedia entities. The breakdown of these mentions into training, validation, and evaluation sets is shown in Table 4.5.

We used Reddit mentions because they are annotated on the general-domain KB (Wikipedia) and do not have very domain-specific terms and mentions. These general-domain mentions are used to provide more data for domain-specific datasets. This augmentation helps if these domain-specific datasets have only a small set of annotated mentions. Thus, it can serve as a method to increase the size of the dataset. The augmented data for each domain-specific dataset is used to fine-tune the proposed approach.

Moreover, these mentions can reduce the overfitting of the fine-tuned models to the domain-specific KB. They are annotated on the general-domain KB (Wikipedia). The Reddit mentions evaluation set is used to test the overfitting of these models and ensure that they can properly link mentions, whether they should be linked to the domain-specific KB or the general-domain KB.



---

## CHAPTER 5

# METHODOLOGY

---

This chapter explains the inner workings of the base model and presents the various proposed approaches to extend it to include entities of domain-specific KBs.

A *Neural Entity Linking* model should serve as the base model. It should be able to handle general-domain documents. We select the model (BLINK) by Wu *et al.* (2020) [1] as the base model to run our experiments. It achieved state-of-the-art results on general-domain datasets such as TAC KBP 2010 by Ji *et al.* (2010) [13].

Wu *et al.* (2020) [1] states that to allow BLINK to add a domain-specific KB, its entities must have descriptions in a textual format. The model encodes these new entities to obtain their embeddings. For a new input mention with textual context, its embedding is compared to all embeddings of entities from the domain-specific and general-domain KBs using *Cosine Similarity*.

Our framework (CDNEL) builds on BLINK to improve its results, specifically when linking to entities from domain-specific KBs. The key idea is to fine-tune BLINK using various proposed modifications in this chapter. The goal of these modifications is to better represent entities from multiple KBs to help in the downstream task of *Entity Linking*.

### 5.1 BLINK

The proposed methodology assumes a base model (BLINK). Initially, it is trained on annotated data from Wikipedia containing mentions corresponding to entities from the general-domain KB (Wikipedia).

### 5.1.1 Candidate Generation Phase

This section explains BLINK’s dense space-based retrieval method for generating candidate entities.

As shown in Figure 5.1, the model architecture consists of two main components. The context encoder, which is on the top left, is used to encode the input mention with context, and the candidate encoder, which is on the bottom right, is used to encode the entities with textual descriptions. As a result, we have an embedding for each entity  $v_r$  and an embedding for each input mention  $v_m$ .

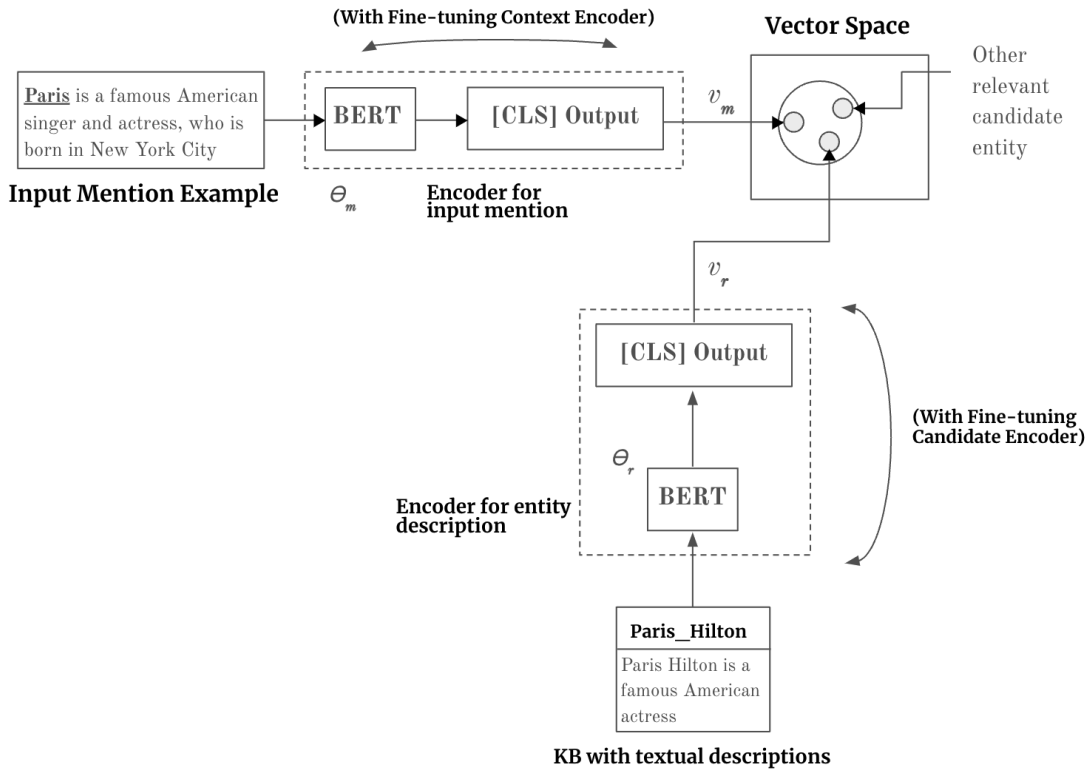

FIGURE 5.1: BLINK: *Candidate Generation*.

Both encoders consist of the same components. The first component, BERT, takes as input the mention with a context in the context encoder and the entity textual description in the candidate encoder. The output of the [CLS] token from BERT in both encoders serve as fixed-size  $v_m$  and  $v_r$  embeddings. This part aims to approximate these two embeddings in the vector space by maximizing their *Cosine Similarity*. BERT weights of the context and candidate encoders are  $\theta_m$  and  $\theta_r$ , respectively. Both encoders are trained to learn the best parameters  $\theta_m$  and  $\theta_r$  to maximize the *Dot Product* between  $v_m$  and  $v_r$  and minimize it for other negative samples. The loss function used to achieve this is shown in Equation 5.1, where  $C_e$  is a randomly sampled batch of negative entities.



$$\mathcal{L}(v_m, v_r)_{\theta_m, \theta_r} = -v_m^T v_r + \log \sum_{e \in C_e} \exp(v_m^T v_e) \quad (5.1)$$

$v_m$ : Input mention representation

$v_r$ : Entity description representation

$v_e$ : Negative entity description representation

The model is trained with mentions from Wikipedia articles annotated on Wikipedia entities extracted in May 2019. This model serves as the base model that can be extended to domain-specific KBs.

After training is completed, embeddings for Wikipedia entities can be computed and stored in an index table for inference. During inference time, the input mention text is encoded using the context encoder of the *Bi-Encoder*, and the similarity in terms of *Cosine Similarity* is calculated with all the embeddings in the stored index table. The most similar  $k$  (hyperparameter) entities are extracted and serve as input to the *Cross-Encoder* in the next phase (*Candidate Ranking* phase).

### 5.1.2 Candidate Ranking Phase

The figure 5.1 is simplified for the *Candidate Generation* components while adding the new components for the *Candidate Ranking* module on the right, as shown in Figure 5.2.

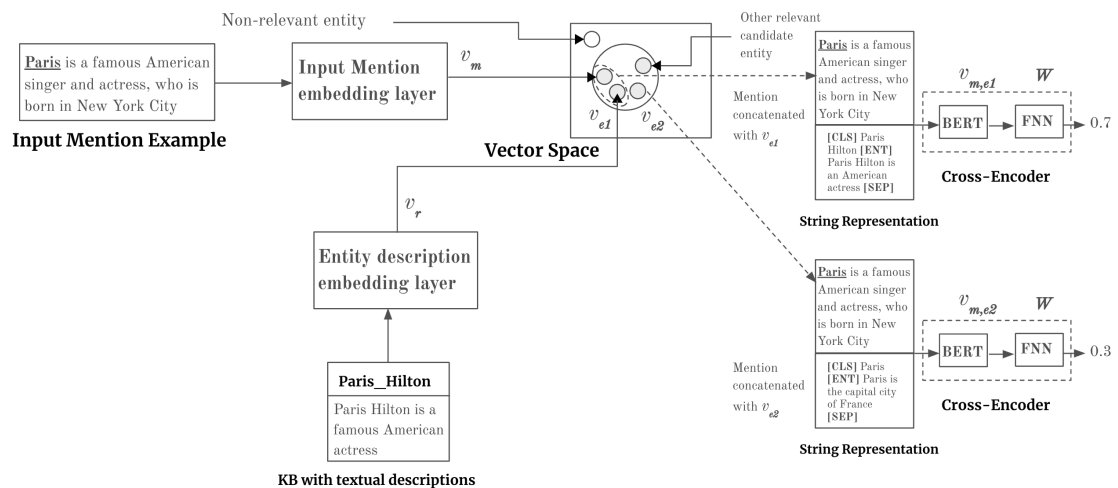

FIGURE 5.2: BLINK: *Candidate Ranking*.

The generated candidate entities are formatted in a string representation that the *Cross-Encoder* can process. These string representations consist of the entity title concatenated with its textual description and separated by a special token [ENT], as shown on the right in Figure 5.2. Each of these string representations is concatenated with the context of the input mention and serves as input to the *Cross-Encoder* so that it can learn the joint context between the textual context of the input mention and the textual description of each of the candidate entities. Depending on the output, it assigns a score indicating how similar they are.

The loss function of the *Cross-Encoder* can be represented in Equation 5.2, where  $v_{m,e}$  is the embedding generated by BERT for the concatenated text of the input mention and the candidate entity description, and  $W$  are the classification layer weights (Fully Connected Neural Network) at the top of the *Cross-Encoder*.  $C_e$  is the set of negative candidate entities.

$$\mathcal{L}(v_{m,e})_W = -v_{m,e}W + \log \sum_{k \in C_e} \exp(v_{m,k}W) \quad (5.2)$$

$v_{m,e}$ : Representation for an input mention concatenated with the gold candidate entity

$v_{m,k}$ : Representation for an input mention concatenated with a negative candidate entity

The model learns to assign the highest score to the correct (gold) candidate entity to which the input mention should be linked and reduce the score for other negative candidate entities.

## 5.2 CDNEL

In this section, we explain our proposed modifications and improvements to BLINK. In addition, we discuss in detail several variants (configurations) of our framework (CDNEL) and how they build on BLINK to include entities from a domain-specific KB with better representations.

These modifications are only applied to the *Candidate Generation* phase. For the *Candidate Ranking* phase, CDNEL uses the same architecture and components as BLINK.

### 5.2.1 Proposed Modifications

#### Fine-tuning the Context and Candidate Encoders on Mentions with Context Annotated on the Domain-specific KB ( $C$ )

We do not modify the *Candidate Generation* architecture from BLINK in this modification. We instead fine-tune both the context and candidate encoders on mentions with context annotated on the domain-specific KB. The aim of fine-tuning is to make the representation for the input mention with context and the representation of the correct entity from the domain-specific KB close together. In addition, the representation of the input mention and other (wrong) entities from set  $C_e$  are further apart. The loss function to achieve this is shown in Equation 5.3, where  $C_e$  is a randomly sampled batch of wrong entities.

$$L_\theta = \sum_{m,r \in T} (-v_m^\top v_r + \log \sum_{e \in C_e} \exp(v_m^\top v_e)) \quad (5.3)$$

$T$ : Training data consisting of mentions  $m$  (in context) and their corresponding entities  $r$  in the domain-specific KB

$v_m$ : Input mention representation

$v_r$ : Entity description representation

$v_e$ : Negative entity description representation

#### Fine-tuning on the Overlapping Entities between the General-domain KB and the Domain-specific KB ( $O$ )

In this modification, the *Candidate Generation* module is further fine-tuned on the overlapping entities between the general-domain KB and the domain-specific KB to make them explicitly closer and similar in the representation space. This learning is done by maximizing the *Dot Product* between  $v_{o1}$  and  $v_{o2}$  representing each entity in an overlapping entity pair. In addition, we make each of  $v_{o1}$  and  $v_{o2}$  far away from non-overlapping entities. The loss function to achieve this is shown in Equation 5.4, where  $C_p$  and  $C_q$  are randomly sampled batches of non-overlapping entities.

$$L_\theta = \sum_{o_1, o_2 \in O} \left( -v_{o_1}^\top v_{o_2} + \log \sum_{p \in C_p} \exp(v_{o_1}^\top v_p) + \log \sum_{q \in C_q} \exp(v_{o_2}^\top v_q) \right) \quad (5.4)$$

$O$ : Set of overlapping entities

$v_{o_1}$ : First entity representation of an overlapping entity pair

$v_{o_2}$ : Second entity representation of an overlapping entity pair

$v_p$ : Representation of an entity that does not overlap with  $o_1$

$v_q$ : Representation of an entity that does not overlap with  $o_2$

In addition, we performed a preliminary experiment in which we added the *Mean Square Error (MSE)* between  $v_{o_1}$  and  $v_{o_2}$  to the loss function, as shown in the last term in Equation 5.5, where  $\lambda$  is a hyperparameter between 0 and 1 that controls how much weight this term adds to the loss function. However, no gains are observed in the downstream task of *Entity Linking*. Instead, we continued our experiments using Equation 5.4.

$$L_\theta = \sum_{o_1, o_2 \in O} \left( -v_{o_1}^\top v_{o_2} + \log \sum_{p \in C_p} \exp(v_{o_1}^\top v_p) + \log \sum_{q \in C_q} \exp(v_{o_2}^\top v_q) + \lambda \cdot |v_{o_1} - v_{o_2}|^2 \right) \quad (5.5)$$

### **Fine-tuning the Context and Candidate Encoders on Mentions with Context from Reddit Annotated on the General-domain KB (Wikipedia) for Data Augmentation (A)**

In this modification, we fine-tune the *Candidate Generation* module on mentions with context annotated on the domain-specific KB as well as mentions with context from Reddit annotated on the general-domain KB (Wikipedia). These general-domain mentions act as augmented data to reduce overfitting to the domain-specific KB. The fine-tuning is performed in the same way as in (C). The loss function used for the fine-tuning is shown in Equation 5.6, where  $C_e$  is a randomly sampled batch of wrong entities.

$$L_\theta = \sum_{m, r \in T} \left( -v_m^\top v_r + \log \sum_{e \in C_e} \exp(v_m^\top v_e) \right) \quad (5.6)$$

$T$ : Training data consisting of mentions  $m$  (in context) and their corresponding entities  $r$  in the general-domain KB or in the domain-specific KB

$v_m$ : Input mention representation

$v_r$ : Entity description representation

$v_e$ : Negative entity description representation

### Fine-tuning only the Candidate Encoder on Mentions with Context Annotated on the Domain-specific KB ( $D$ )

In this modification, we experiment with fine-tuning only the candidate encoder, as shown in Figure 5.3.

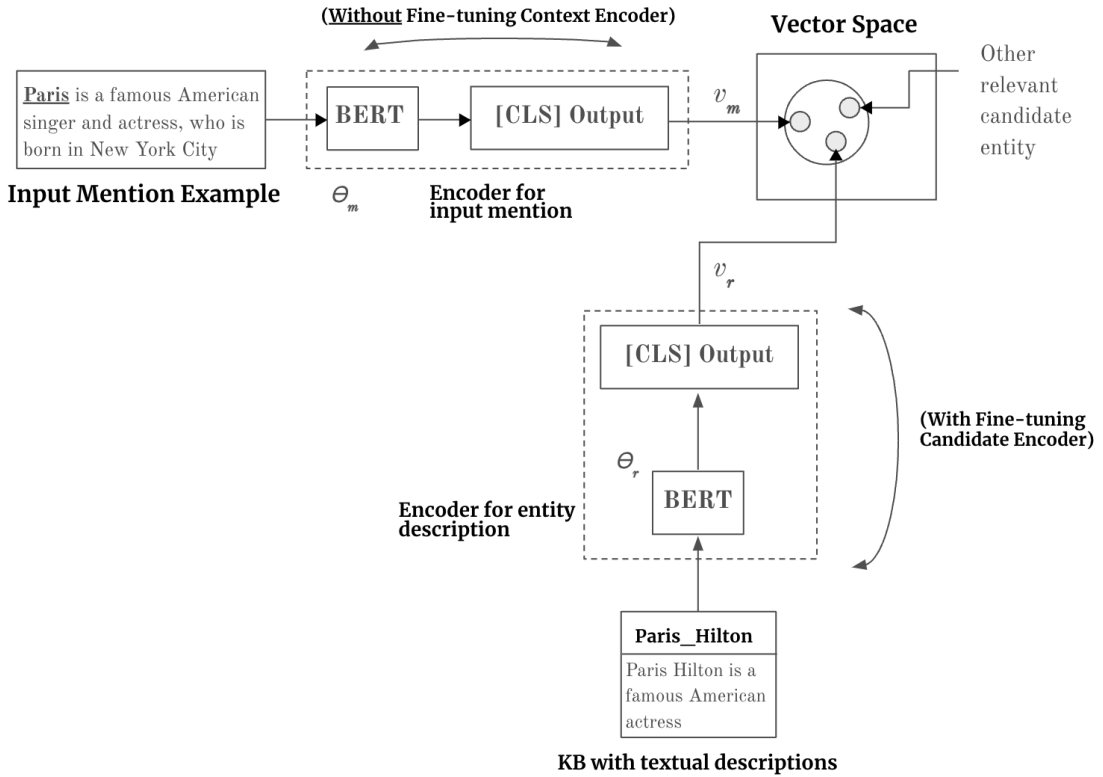

FIGURE 5.3: CDNEL ( $D$ ): Candidate Generation.

The weights of the context encoder  $\theta_m$  are frozen without change. The weights of the candidate encoder  $\theta_r$  are modified and learned such that the *Dot Product* between  $v_m$  and  $v_r$  is maximized and minimized for other negative samples. The loss function used to achieve this is shown in Equation 5.7, where  $C_e$  is a randomly sampled batch of negative entities.

$$\mathcal{L}(v_m, v_r)_{\theta_m} = -v_m^T v_r + \log \sum_{e \in C_e} \exp(v_m^T v_e) \quad (5.7)$$

$v_m$ : Input mention representation

$v_r$ : Entity description representation

$v_e$ : Negative entity description representation

The idea behind modifying only the weights of the candidate encoder  $\theta_r$  and leaving the weights of the context encoder  $\theta_m$  unchanged is to focus the training on the candidate encoder weights to learn how to encode the entities of the domain-specific and the general-domain KBs to fit into the same vector space. This modification can help reduce the overfitting of the model to the domain-specific KB since the parameters of the context encoder learned from the general-domain dataset are not modified. Moreover, it reduces the number of parameters used for fine-tuning, which increases the speed of training. In addition, the memory occupied by these parameters is reduced, allowing the model to use larger batch sizes when fine-tuning is done using the same cluster machine.

### 5.2.2 Model Variants

The modifications:  $C$ ,  $O$  and  $A$  proposed in the previous section are used to form different variants of our framework (CDNEL). The main idea is based on providing different dataset components for fine-tuning the *Candidate Generation* module of the base model (BLINK), as shown in Figure 5.4.

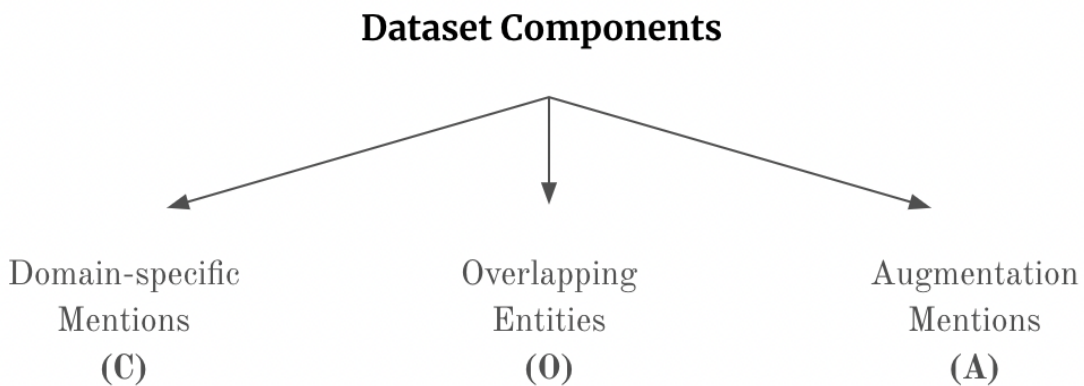

FIGURE 5.4: Dataset components used in the fine-tuning.

Mentions with context annotated on the domain-specific KB must be obtained for fine-tuning ( $C$ ). Extracting the overlapping entities between the general-domain KB and

the domain-specific KB is used to perform further fine-tuning ( $O$ ). In addition, mentions from Reddit annotated on the general-domain KB (Wikipedia) are used for data augmentation to reduce overfitting to the domain-specific KB ( $A$ ).

These different types of data lead to different variants of CDNEL. The variants used to perform the main experiments in Chapter 6 are shown in Figure 5.5.

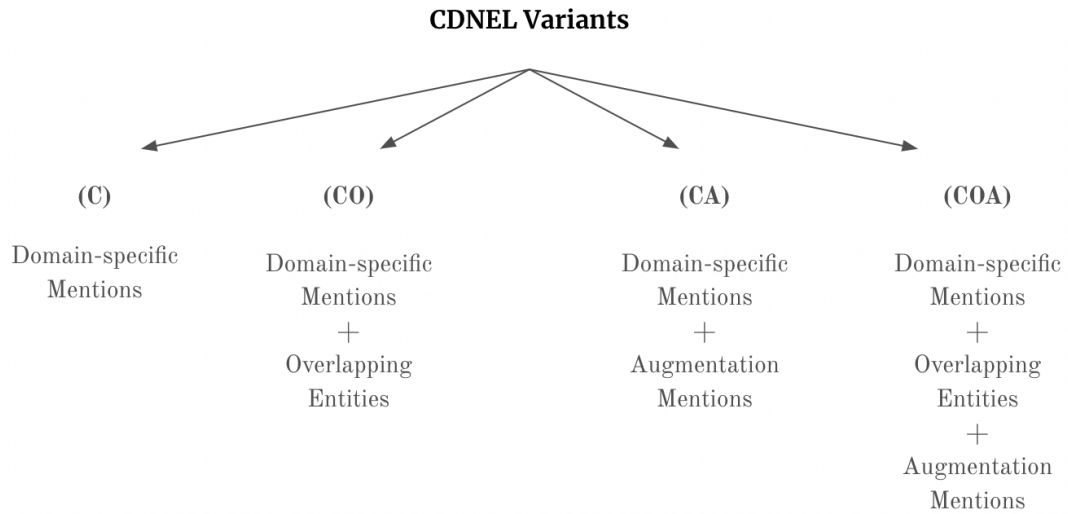

FIGURE 5.5: CDNEL model variants and datasets used in the fine-tuning.

These four variants of CDNEL are as follows:-

- **C**: The context and candidate encoders of the *Candidate Generation* module are fine-tuned on mentions with context annotated on the domain-specific KB.
- **CO**: The context and candidate encoders of the *Candidate Generation* module are fine-tuned on mentions with context annotated on the domain-specific KB. In addition, the module is further fine-tuned on the overlapping entities between the general-domain KB and the domain-specific KB.
- **CA**: The context and candidate encoders of the *Candidate Generation* module are fine-tuned on mentions with context annotated on the domain-specific KB as well as mentions with context from Reddit annotated on the general-domain KB (Wikipedia) for data augmentation.
- **COA**: The context and candidate encoders of the *Candidate Generation* module are fine-tuned on mentions with context annotated on the domain-specific KB as

well as mentions with context from Reddit annotated on the general-domain KB (Wikipedia) for data augmentation. In addition, the module is further fine-tuned on the overlapping entities between the general-domain KB and the domain-specific KB.

In addition to these four variants, there are two more variants involving modification (*D*). These variants are not used to run the main experiments, but are used in the analysis section of Chapter 6. They are as follows:-

- ***D***: The candidate encoder of the *Candidate Generation* module is fine-tuned on mentions with context annotated on the domain-specific KB.
- ***DA***: The candidate encoder of the *Candidate Generation* module is fine-tuned on mentions with context annotated on the domain-specific KB as well as mentions with context from Reddit annotated on the general-domain KB (Wikipedia) for data augmentation.

The main experiments are performed without considering the *D* variants since the *C* variants prove to be more accurate in the downstream task of *Entity Linking*.

### 5.2.3 Summary

In our framework (CDNEL), several proposed modifications are presented with the goal of fine-tuning BLINK to provide a better representation space for entities from multiple KBs, which should help in *Entity Linking*. There are different variants of CDNEL. The main experiments are based on the *C* variants. They have in common the fine-tuning of the context and candidate encoders of the *Candidate Generation* module on mentions with context annotated on the domain-specific KB. For the other model variants, additional knowledge from other types of datasets is used for fine-tuning. For example, we perform further fine-tuning on the overlapping entities between the general-domain KB and the domain-specific KB, represented by (*O*). In addition, we used data augmentation by including additional mentions in the fine-tuning that are extracted from Reddit and annotated on the general-domain KB (Wikipedia). This data augmentation is represented by (*A*).



---

## CHAPTER 6

# EXPERIMENTAL EVALUATION

---

This chapter presents a description of the experimental setup with the results of the conducted experiments. In addition, further analysis of the results is provided.

The experiments aim to evaluate the extensibility of the base model (BLINK) to domain-specific KBs. This extensibility is performed by fine-tuning BLINK on the domain-specific datasets. The performance of the fine-tuned model is tested for the *Entity Linking* task with mentions that should be annotated on the domain-specific KB. In addition, the model’s performance is tested on mentions that should be annotated on the general-domain KB (Wikipedia). This additional test is performed to check the overfitting of the fine-tuned model to the domain-specific KB.

### 6.1 Experimental Setup

This section explains the configurations used for the fine-tuning and evaluation processes. In addition, the evaluation metrics and their relevance for the assessment and evaluation of the proposed approach are demonstrated.

#### 6.1.1 Model Configurations

As mentioned in Chapter 5, there are several variants of CDNEL. They are summarized in Table 6.1.

These variants share the same hyperparameters used in fine-tuning and evaluation. Since BLINK is not fine-tuned on mentions from the domain-specific datasets, the corresponding hyperparameters for fine-tuning do not exist, as shown in Table 6.2.

Modifications	CDNEL Variants					
	<i>C</i>	<i>CO</i>	<i>CA</i>	<i>COA</i>	<i>D</i>	<i>DA</i>
Fine-tuning on mentions with context annotated on the domain-specific KB	✓	✓	✓	✓	✓	✓
Further fine-tuning on overlapping entities between the general-domain KB and the domain-specific KB		✓		✓		
Including in the fine-tuning mentions with context from Reddit annotated on the general-domain KB (Wikipedia)			✓	✓		✓
Fine-tuning only the candidate encoder of BLINK					✓	✓

TABLE 6.1: Modifications used to form different variants of our framework (CDNEL)

Hyperparameters	BLINK (Zero-Shot)	CDNEL Variants ( <i>C</i> , <i>CO</i> , <i>CA</i> , <i>COA</i> , <i>D</i> , <i>DA</i> )
Training Batch Size	-	16
Validation Batch Size	-	16
Learning Rate	-	0.00003
Number of Epochs	-	5
Candidate Generation Top K	10	10
Mention with Context Max Length	128	128
Entity with Description Max Length	128	128

TABLE 6.2: Hyperparameters configurations used in the fine-tuning and evaluation of BLINK and CDNEL variants

The size of the training and validation batches plays a vital role in fine-tuning. The larger, the better, since the rest of the samples in the batch for each input sample act as negative samples. The larger the number of negative samples, the greater the loss. Thus, the model learns to make more negative samples at a greater distance for each input sample. However, this has the disadvantage of requiring a larger memory. We experimented with batch sizes of 64, 32, and 16. According to our cluster specifications, we could only do the fine-tuning using a batch size of 16.

The infrastructure used for fine-tuning and evaluation is a Tesla V100 GPU cluster, available with 16 GB or 32 GB configurations. We used the 32 GB configuration with 2 CPUs and a total main memory of 64 GB.

We did not experiment with fine-tuning with different values for the learning rate and the number of epochs. Instead, we used the proposed values from BLINK for these hyperparameters. In addition, we used early stopping to store the best model checkpoint based on the model performance on the validation set.

The number of candidate entities  $k$  can typically be 10, 64, or 100. However, this comes at the cost of fine-tuning time and the runtime of the evaluation. We limited

the number to 10 since we conducted several experiments on different domains using CDNEL variants.

The maximum number of tokens for the input mention with context and entities with descriptions is 128. The larger, the better, as more context and information is kept for both mentions and entities with more tokens. However, this requires a larger memory and a longer runtime.

### 6.1.2 Evaluation Metrics

There is only one gold ground truth for each input mention in the evaluation process. In the final step of the *Candidate Ranking* phase, the 10 most similar entities to an input mention are ranked from top to bottom. This ranking is evaluated using  $AP@10$ . This metric is the average precision of the gold entity if it is present among the 10 most similar entities. Otherwise, it would be zero, as shown in Equation 6.1.

$$AP@10 = \frac{1}{GTE} \sum_{k=1}^{10} p@k \times rel@k \quad (6.1)$$

$p@k$  is defined as the number of gold entities among the top similar  $k$  entities divided by  $k$ .  $GTE$  represents the number of ground truth entities. In our case, it is always one since there is only one gold entity for each mention.  $rel@k$  is a relevance function. It is an indicator function that equals one if the entity at rank 1 is relevant and equals 0 otherwise.

The metric  $AP@10$  is calculated for all the mentions  $N$  in the evaluation set, and its mean  $MAP@10$  is calculated as shown in Equation 6.2.

$$MAP@10 = \frac{1}{N} \sum_{i=1}^N AP@10_i \quad (6.2)$$

$MAP@10$  is chosen to provide a quantitative assessment of the quality of the ranking. However,  $AP@1$  is used to evaluate the model's overall quality, as shown in Equation 6.3.

$$AP@1 = \frac{1}{N} \sum_{i=1}^N rel@1 \quad (6.3)$$

It represents the end-to-end evaluation of the system and a specific assessment for the highest scoring candidate entity among the 10 most similar entities to a mention. Its average is calculated for  $N$  mentions in the evaluation set.

## 6.2 Experiments and Results

This section presents the different experiments conducted in this Master thesis. The main experiments are performed using the  $C$  variants of our framework (CDNEL) demonstrated in Section 5.2.2 in Chapter 5, leveraging fine-tuning pre-trained language models to merge entities from multiple KBs. In addition, we performed a qualitative assessment of a sample of mentions and investigated how the fine-tuned models can correctly link them. Moreover, we conducted an intrinsic evaluation of the joint representation space of these entities from multiple KBs.

### 6.2.1 Fine-tuning on Mentions Annotated on the Domain-specific KB

In this experiment, we address the research question, “To what extent does fine-tuning on domain-specific datasets affect the results of simultaneous *Entity Linking*?”.

The main experiment is conducted using the Zeshel dataset by Logeswaran *et al.* (2019) [2]. We experimented with four different domains: *American Football*, *Doctor Who*, *Fallout*, and *Final Fantasy*. For each domain, we fine-tuned the  $C$  variants of CDNEL:  $C$ ,  $CO$ ,  $CA$ , and  $COA$ . They are then evaluated against their respective domain evaluation set, consisting of separate mentions annotated on that domain. The results are shown in Table 6.3.

For each domain, the CDNEL variants are compared to the performance of BLINK with respect to  $AP@1$  and  $MAP@10$ . They almost consistently perform better than BLINK, visually seen in Figures 6.1 and 6.2. These figures show the  $AP@1$  and  $MAP@10$  reported in Table 6.3. This visualization is done to have a clearer view of the difference in performance of BLINK compared to the CDNEL variants.

	<i>American Football</i>		<i>Doctor Who</i>		<i>Fallout</i>		<i>Final Fantasy</i>	
	<i>AP@1</i>	<i>MAP@10</i>	<i>AP@1</i>	<i>MAP@10</i>	<i>AP@1</i>	<i>MAP@10</i>	<i>AP@1</i>	<i>MAP@10</i>
BLINK	0.1747	0.4104	0.4108	0.4810	0.3412	0.4444	0.3833	0.5179
<i>C</i>	<b>0.2042</b>	<b>0.4578</b>	<b>0.6184</b>	0.6927	0.4313	0.5506	0.3871	0.5407
<i>CO</i>	0.1834	0.4061	0.5735	0.6574	0.4485	0.5590	0.3429	0.4871
<i>CA</i>	<b>0.2042</b>	0.4577	0.6154	<b>0.7140</b>	<b>0.4657</b>	<b>0.5916</b>	<b>0.4121</b>	<b>0.5710</b>
<i>COA</i>	0.1626	0.3334	0.5382	0.6165	0.4227	0.5404	0.3900	0.5489

TABLE 6.3: Evaluation on mentions annotated on each domain-specific KB.

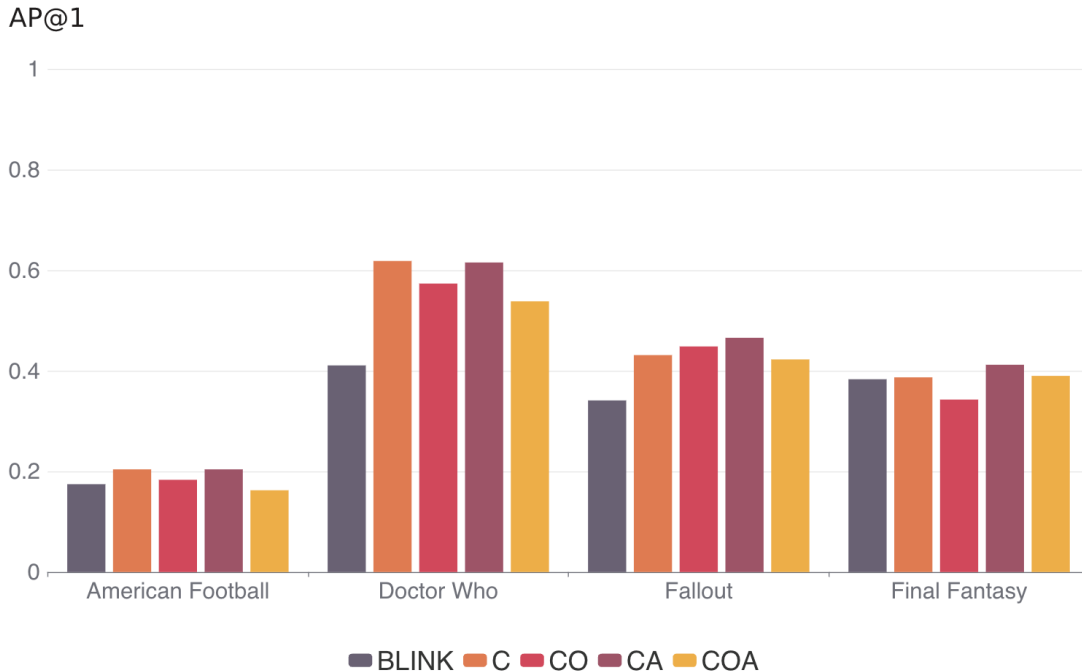
FIGURE 6.1: *AP@1* of BLINK vs. CDNEL variants evaluated on mentions annotated on each domain-specific KB.

The results in Table 6.3 show that *CA* is the best-performing model. This observation suggests that using data augmentation of Reddit mentions annotated on the general-domain KB (Wikipedia) leads to better results when used for fine-tuning. This improvement is due to the general-domain nature of the Reddit mentions, which in turn helps the fine-tuned model learn a better representation of the textual context around the mentions even if they should be annotated on the domain-specific KB. This augmentation is also helpful when the fine-tuning dataset for the domain-specific KB is tiny.

We perform the statistical significance testing described by Dror *et al.* (2019) [31]. This paper provides a code implementation of the statistical significance tests used in NLP. According to Smucker *et al.* (2007) [32], Fisher’s randomization test (permutation test) is recommended to test the statistical significance of the difference in *Mean Average Precision* between two algorithms (systems). We use the randomization test to check for

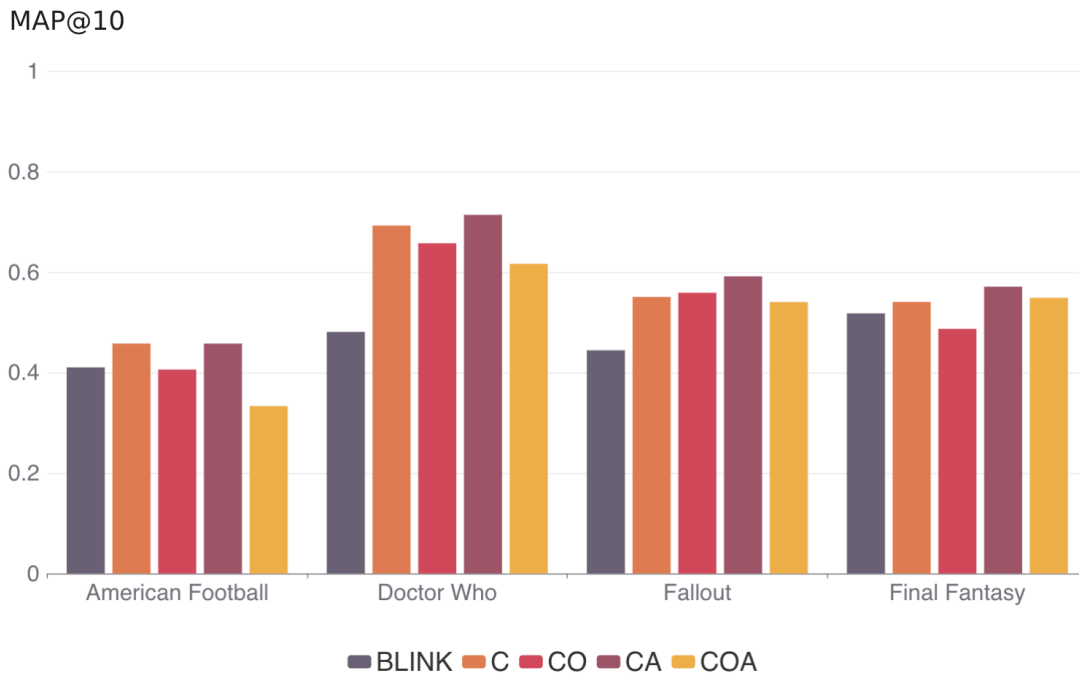

FIGURE 6.2: *MAP@10* of BLINK vs. CDNEL variants evaluated on mentions annotated on each domain-specific KB.

	<i>American Football</i>		<i>Doctor Who</i>		<i>Fallout</i>		<i>Final Fantasy</i>	
	<i>AP@1</i>	<i>MAP@10</i>	<i>AP@1</i>	<i>MAP@10</i>	<i>AP@1</i>	<i>MAP@10</i>	<i>AP@1</i>	<i>MAP@10</i>
BLINK/CA	0.0002	8.6498e-5	3.7480e-5	3.7480e-5	9.9990e-5	9.9990e-5	0.0034	4.8028e-5
Significance	✓	✓	✓	✓	✓	✓	✓	✓

TABLE 6.4: P-values at the significance level (alpha) of 0.05 for the evaluation results of each domain.

statistical significance between BLINK and the best-performing CDNEL variant (*CA*) with a significance level (alpha) of 0.05. The p-value results are shown in Table 6.4.

The observed difference between BLINK and *CA* is statistically significant for all domains. This significance test illustrates the strength of *CA* in *Entity Linking* for mentions that should be annotated on domain-specific KB.

## 6.2.2 Overfitting of the Fine-tuned Models to the Domain-specific KB

In this experiment, we aim to answer the research question, “Can we use data augmentation to reduce the overfitting of fine-tuned models to the domain-specific KB?” This is interesting because fine-tuned models have a high probability of overfitting to the domain-specific KBs.

	<i>American Football</i>		<i>Doctor Who</i>		<i>Fallout</i>		<i>Final Fantasy</i>	
	<i>AP@1</i>	<i>MAP@10</i>	<i>AP@1</i>	<i>MAP@10</i>	<i>AP@1</i>	<i>MAP@10</i>	<i>AP@1</i>	<i>MAP@10</i>
BLINK	0.8479	0.8973	0.8509	0.8985	0.8509	<b>0.8987</b>	0.8494	0.8987
<i>C</i>	0.8517	<b>0.8974</b>	0.8170	0.8529	0.8042	0.8452	0.8577	0.8970
<i>CO</i>	0.8517	0.8940	0.8524	0.8859	0.8321	0.8676	0.8592	0.8930
<i>CA</i>	<b>0.8614</b>	0.8964	0.8622	0.8992	0.8592	0.8959	0.8773	<b>0.9076</b>
<i>COA</i>	0.8163	0.8387	<b>0.8773</b>	<b>0.9063</b>	<b>0.8637</b>	0.8859	<b>0.8810</b>	0.9045

TABLE 6.5: Evaluation on Reddit mentions annotated on the general-domain KB (Wikipedia).

BLINK is pre-trained on mentions from Wikipedia and performs well on mentions that should be annotated on Wikipedia KB. However, our goal is to have a model that performs well on mentions that should be annotated on the general-domain KB (Wikipedia) along with other mentions that should be annotated on a domain-specific KB. In this regard, we aim for CDNEL to achieve better or at least similar results to BLINK when evaluation is only done on mentions that should be annotated on the general-domain KB (Wikipedia). We performed the evaluation on mentions from Reddit and the results are presented in Table 6.5.

The results of the CDNEL variants are almost comparable to those of BLINK in terms of *AP@1* and *MAP@10*, and the difference in performance is only slight compared to the previous experiment where the evaluation was performed using separate mentions annotated on the domain-specific KBs. This slight discrepancy can be seen in Figures 6.3 and 6.4, which visualize the results from Table 6.5. They show the performance of the CDNEL variants compared to the BLINK model in terms of *AP@1* and *MAP@10*.

The results in the Table 6.5 show that *COA* generally has the highest scores compared to BLINK and other CDNEL variants. However, it performs worse on *American Football*. On the other hand, *CA* consistently either resembles or outperforms BLINK for all domains. This observation suggests that the use of data augmentation of general-domain mentions helps reduce the overfitting of the fine-tuned models to the domain-specific KB. This suggestion is supported by the fact that the CDNEL variant *C*, which contains no data augmentation, performs worse than BLINK for two domains, *Doctor Who* and *Fallout*.

We perform the same statistical significance test that we performed on the results obtained when evaluation is performed on mentions annotated on the domain-specific KB. We choose the same test because the evaluation metrics are the same. We use Fisher’s randomization test to check for statistical significance between BLINK and the CDNEL variant (*CA*) with a significance level (alpha) of 0.05. The p-value results are shown in Table 6.6.

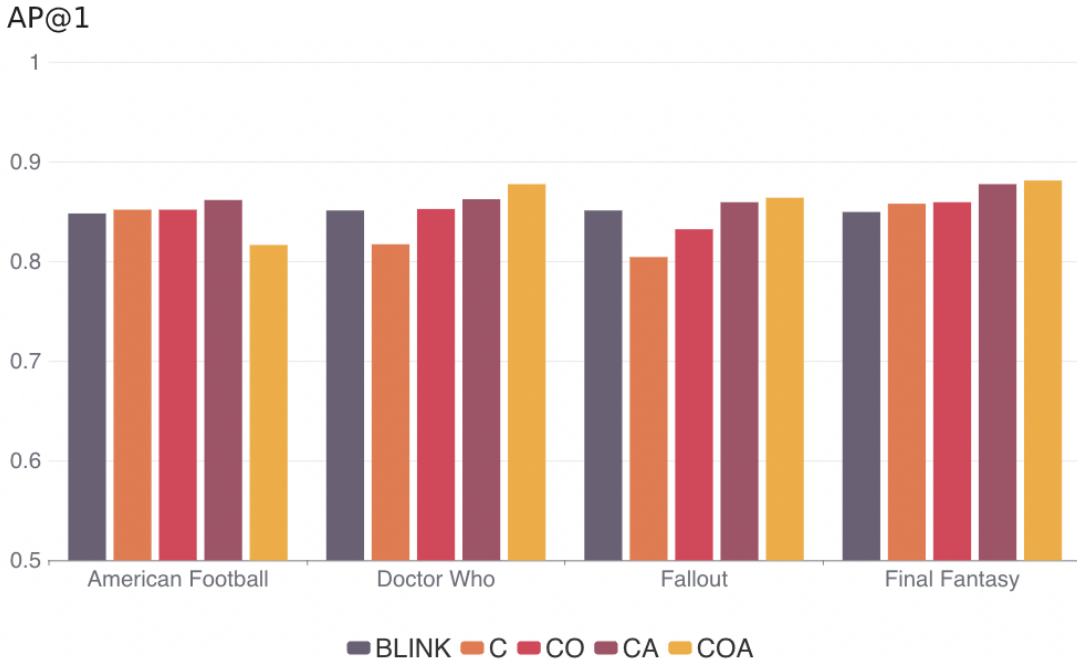

FIGURE 6.3:  $AP@1$  of BLINK vs. CDNEL variants evaluated on Reddit mentions annotated on the general-domain KB (Wikipedia).

	<i>American Football</i>		<i>Doctor Who</i>		<i>Fallout</i>		<i>Final Fantasy</i>	
	$AP@1$	$MAP@10$	$AP@1$	$MAP@10$	$AP@1$	$MAP@10$	$AP@1$	$MAP@10$
BLINK/CA	0.0712	0.6322	0.0847	0.4731	0.1836	0.6951	0.0002	0.0508
Significance							✓	

TABLE 6.6: P-values at the significance level (alpha) of 0.05 for the evaluation results of each domain.

The observed difference between BLINK and *CA* is not statistically significant for almost all domains. This significance test illustrates the comparability of *CA* with BLINK in *Entity Linking* for mentions that should be annotated on the general-domain KB. These results support the claim that *CA* performs well for mentions that should be annotated on the domain-specific KB as well as mentions that should be annotated on the general-domain KB (Wikipedia).

### 6.2.3 Mentions Qualitative Assessment

In this part, we take a closer look at the mentions annotated by BLINK and the fine-tuned models. We aim to assess how the fine-tuned models learned to link mentions to the general-domain and domain-specific KBs and how the results of these annotations differ from those of BLINK. This assessment is shown in Table 6.7.



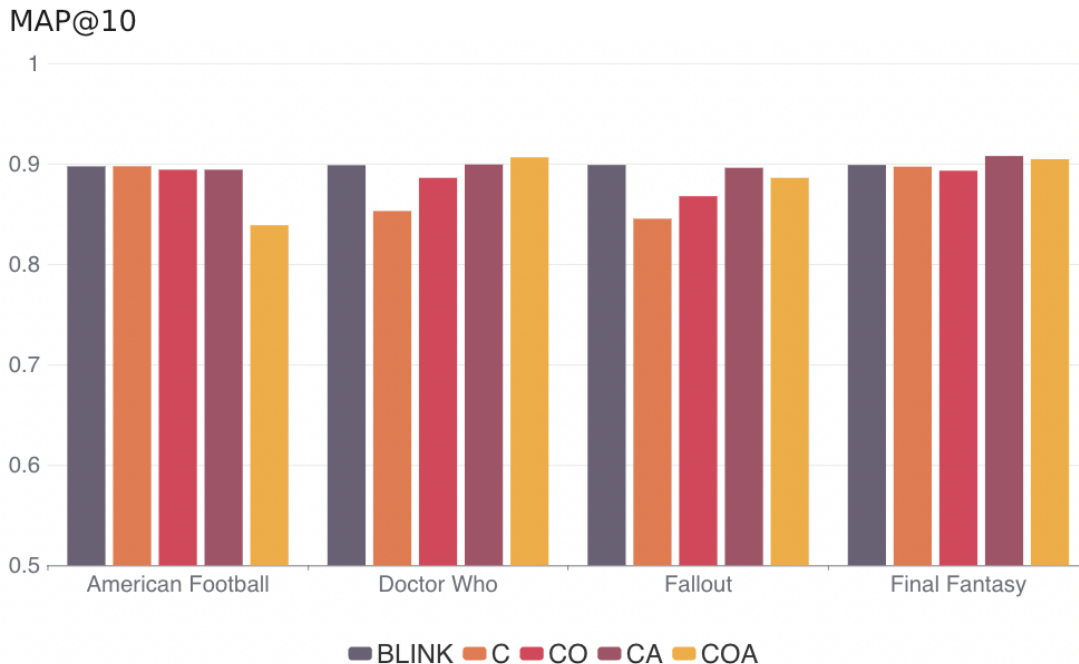

FIGURE 6.4: *MAP@10* of BLINK vs. CDNEL variants evaluated on Reddit mentions annotated on the general-domain KB (Wikipedia).

Mention	Domain	BLINK	CA
<b>Putin</b> can't do much. Russia has no leverage over us and are already feeling huge pressure from American and EU sanctions (one big reason Putin threw his hat in with Trump and the GOP, to try and lift those sanctions).	Reddit	Russia	<b>Vladimir Putin</b>
The only real purpose of the item is to naturally observe the isogin smog ability-used by <b>acrophies</b> , who will only use the ability when the entire player party has the darkness status.	Final Fantasy	Acrophies (Final Fantasy V)	<b>Acrophies (Final Fantasy VII)</b>

TABLE 6.7: Mentions with context correctly linked by CDNEL variant (*CA*) and wrongly linked by BLINK.

This table shows examples of mentions extracted from a couple of domains and the result of the annotations by BLINK compared to the best-performing CDNEL variant (*CA*). The correct annotations are in bold.

The assessment shows that the fine-tuned model variant *CA* performs well on mentions that should be annotated on a domain-specific KB, e.g., *Final Fantasy*, as it was able to indicate to which exact version of *Final Fantasy*, the mention “Acrophies” should belong. In addition, it demonstrates strong capabilities in linking mentions that should be annotated on the general-domain KB (Wikipedia), such as distinguishing between

	<i>American Football</i>		<i>Doctor Who</i>		<i>Fallout</i>		<i>Final Fantasy</i>	
	<i>MRR</i>	<i>ACS</i>	<i>MRR</i>	<i>ACS</i>	<i>MRR</i>	<i>ACS</i>	<i>MRR</i>	<i>ACS</i>
BLINK	0.4991	0.9938	0.4607	0.9650	0.4071	0.9603	0.3623	0.9532
<i>C</i>	0.4982	0.9892	0.3926	0.9095	0.3533	0.9317	0.4136	0.9515
<i>CO</i>	0.4990	0.9919	<b>0.4932</b>	0.9784	<b>0.4558</b>	0.9680	<b>0.4400</b>	0.9628
<i>CA</i>	<b>0.4999</b>	<b>0.9958</b>	0.4323	0.9605	0.4223	0.9676	0.4072	0.9746
<i>COA</i>	0.4995	0.9896	0.4619	<b>0.9830</b>	0.4534	<b>0.9820</b>	0.4209	<b>0.9791</b>

TABLE 6.8: Intrinsic evaluation of overlapping entities between each domain-specific KB and Wikipedia KB.

“Putin” and “Russia” and correctly linking the mention “Putin” to the corresponding entity “Vladimir Putin”.

#### 6.2.4 Intrinsic Evaluation of Embeddings

In this experiment, we evaluate the joint representation space of the entities of each domain-specific KB from the Zeshel dataset and the general-domain KB (Wikipedia). These domain-specific KBs are from *American Football*, *Doctor Who*, *Fallout*, and *Final Fantasy*. The overlapping entities between them and Wikipedia KB are 22928, 3611, 752, and 413, respectively. In this setting, we do not consider the downstream task of *Entity Linking*. We only evaluate the embeddings generated by each variant of CDNEL.

The intrinsic evaluation of *American Football* and *Doctor Who* could not be performed for all overlapping entities between them and the general-domain KB (Wikipedia). The number of overlapping entities is large and leads to an enormous number of pairwise comparisons of their embeddings. This has the disadvantage of requiring more memory and exceeding the memory limit of our cluster. However, we draw a random sample of 1000 overlapping entity pairs and perform the evaluation using this sample.

The evaluation is based on the overlapping entities between each domain-specific KB and the general-domain KB (Wikipedia). We measure the *Mean Reciprocal Rank (MRR)* between the two entities of each overlapping entity pair using the *Cosine Similarity* between their embeddings as a similarity metric. In addition, we measure the *Cosine Similarity* itself between the embeddings of this entity pair and then average it for all pairs of overlapping entities. The results of *MRR* and *Average Cosine Similarity (ACS)* are shown in Table 6.8.

The table shows the results for the *C* variants of our framework (CDNEL) compared to BLINK. The results show that the fine-tuned model variants *CO* and *COA*, which are further fine-tuned on the overlapping entities between the domain-specific KB and

	<i>American Football</i>		<i>Doctor Who</i>		<i>Fallout</i>		<i>Final Fantasy</i>	
	<i>MRR</i>	<i>ACS</i>	<i>MRR</i>	<i>ACS</i>	<i>MRR</i>	<i>ACS</i>	<i>MRR</i>	<i>ACS</i>
BLINK/COA	0.1922	1.0	0.3523	2.4999e-5	3.3244e-5	3.3244e-5	6.0529e-5	6.0529e-5
Significance				✓	✓	✓	✓	✓

TABLE 6.9: P-values at the significance level (alpha) of 0.05 for the intrinsic evaluation results of each domain.

the general-domain KB, perform best in terms of *MRR* and *Average Cosine Similarity*, respectively. However, the performance is comparable to that of BLINK only for the domain *American Football*. This comparability can be attributed to the very large number of overlapping entities of *American Football* compared to the other domains. This may require more epochs when further fine-tuning on the overlapping entities of *American Football*. We use the same number of epochs for all domains regardless of the number of their overlapping entities.

The evaluation indicates a better joint representation space for the entity embeddings generated by our framework (CDNEL). This observation indicates that further fine-tuning of the base model (BLINK) on the overlapping entities between the domain-specific KB and the general-domain KB helps obtain higher quality embeddings of entities where the overlapping entities are as close as possible in the joint representation space.

We perform the statistical significance testing described by Dror et al. (2019) [31]. They recommend using Fisher’s randomization (permutation) to test the statistical significance of the difference in MRR between two systems. We use the randomization test to check for statistical significance between BLINK and the best-performing CDNEL variant (*COA*) with a significance level (alpha) of 0.05. The results of the p-value are shown in Table 6.9.

The observed difference between BLINK and *COA* is statistically significant for all domains except *American Football*, which is expected based on the results in Table 6.8. In addition, the *MRR* of the overlapping entities of *Doctor Who* is not statistically significant, which has the second-largest number of overlapping entities compared to the other domains. This significance test generally supports the advantage of *COA* in learning a better joint representation space of entities of the combined domain-specific KB and the general-domain KB (Wikipedia).

Domain	Entities	Mentions		
		Fine-tuning		Evaluation
		Training	Validation	
Coronation Street	17809			
Muppets	21344			
Ice Hockey	28684			
Elder Scrolls	21712	17000	1000	2000
Forgotten Realms	15603			
Lego	10076			
Star Trek	34430			
YuGiOh	10031			

TABLE 6.10: Different domains are mixed and used in fine-tuning and evaluating the  $D$  variants of CDNEL.

## 6.3 Analysis

This section presents experiments conducted to test the  $D$  variants of our framework (CDNEL). In addition, we experiment with testing two of the  $C$  variants in a different document setting.

### 6.3.1 Fine-tuning on Mentions Annotated on a Mixed-domain KB

This experiment tests fine-tuning only the candidate encoder versus fine-tuning both the context and candidate encoders. This way of fine-tuning can be interesting because preventing the parameters of the context encoder from changing can help reduce the overfitting of the model to the domain-specific KB.

This test is performed on the Zeshel dataset by mixing eight domains into a single mixed-domain KB. Mentions of these domains are mixed and split into training, validation, and test sets. These domains and the number of their relative entities are listed in Table 6.10. Since the mentions of these domains are mixed, we only report the total number of mentions in each of the training, validation, and evaluation sets.

We did this mixing because it is time-consuming to run the experiment separately for each domain. For the same reason, and because of the complexity of pairwise comparisons, we did not experiment with extracting the overlapping entities between the total number of entities in the mixed-domain KB (159689) and Wikipedia KB (5903538). In addition, we aim only to test the  $D$  variants and whether fine-tuning only the candidate encoder can contribute to the *Entity Linking* task compared with the  $C$  variants.

	Mixed-domain Mentions		Reddit Mentions	
	<i>AP@1</i>	<i>MAP@10</i>	<i>AP@1</i>	<i>MAP@10</i>
BLINK	0.2915	0.5265	0.8065	<b>0.9639</b>
<i>D</i>	0.3650	0.6415	0.7922	0.9217
<i>C</i>	0.3960	0.7280	0.7892	0.9096
<i>DA</i>	0.3580	0.6515	0.8050	0.9458
<i>CA</i>	<b>0.4125</b>	<b>0.7460</b>	<b>0.8117</b>	0.9398

TABLE 6.11: Evaluation on mentions annotated on the mixed-domain KB and Reddit mentions annotated on the general-domain KB (Wikipedia).

The evaluation dataset contains mentions from the mixed domains annotated on the mixed-domain KB and other mentions from Reddit annotated on the general-domain KB (Wikipedia). The evaluation is done separately on them, as shown in Table 6.11.

The results show that *CA* has almost the highest scores compared to BLINK and the other variants. This result indicates that the best setting is fine-tuning both the context and the candidate encoders. However, *DA* outperforms *CA* only with respect to *MAP@10* when evaluated on Reddit mentions annotated on the general-domain KB. This observation may indicate that *DA* might contribute to reducing the overfitting of the fine-tuned model to the mixed-domain KB. However, we recommend continuing experiments using the *C* variants of CDNEL.

### 6.3.2 Fine-tuning on Mentions Annotated on both Domains

In this experiment, we test the scenario when mentions annotated on the domain-specific KB and the general-domain KB are in the same document. In our case, these mentions are extracted from *Cybersecurity* documents and used in fine-tuning. Some of these mentions are annotated on the domain-specific KB (*Cybersecurity*), while others are annotated on the general-domain KB (Wikipedia). We did not use data augmentation in this setting. We tested CDNEL variants *C* and *CO*, which do not include data augmentation in their fine-tuning.

The evaluation dataset contains separate mentions from *Cybersecurity* documents annotated on both domains. The evaluation is performed separately for each domain, as shown in Table 6.12.

The results show that the difference in the evaluation performance between BLINK and CDNEL is not consistent. We cannot state whether specifying mentions annotated on both domains for fine-tuning gives any gains. This inconsistency can be due to the small number of input samples used for fine-tuning and evaluation. The training set we use has

	Cybersecurity Mentions		Wikipedia Mentions		Combined Mentions	
	<i>AP@1</i>	<i>MAP@10</i>	<i>AP@1</i>	<i>MAP@10</i>	<i>AP@1</i>	<i>MAP@10</i>
BLINK	<b>0.7647</b>	<b>0.9608</b>	0.7021	<b>0.7766</b>	0.7241	<b>0.8414</b>
<i>C</i>	0.7451	0.8627	<b>0.7234</b>	0.7660	<b>0.7310</b>	0.8000
<i>CO</i>	0.7451	0.8824	<b>0.7234</b>	0.7660	<b>0.7310</b>	0.8069

TABLE 6.12: Evaluation on mentions from the same document annotated on the domain-specific KB (Cybersecurity) and the general-domain KB (Wikipedia).

only 646 annotated mentions on both KBs. We leave this for further experimentation using larger datasets of mentions from the same document and are annotated on both domains.

---

## CHAPTER 7

# CONCLUSION

---

### 7.1 Summary

In this research project, the main goal of our framework (CDNEL) is to have a single system that allows simultaneous linking to more than one KB. In our case, these are the general-domain KB (Wikipedia) and the domain-specific KB, such as *Final Fantasy* and *Cybersecurity*. This system is built by fine-tuning pre-trained language models, e.g., BERT. Knowledge learned from these models is obtained in the form of context-aware embeddings for the textual context of the mention and the textual descriptions of the entities. In addition, we bring in knowledge from the domain-specific datasets by fine-tuning these language models using four domains from the Zeshel dataset.

We introduce different model variants of our framework (CDNEL). The main experiments are performed using the *C* variants, which have in common fine-tuning the *Candidate Generation* module on mentions annotated on the domain-specific KB. The other model variants attempt to use additional knowledge from other types of datasets for fine-tuning. For example, we do further fine-tuning on the overlapping entities between the general-domain KB and the domain-specific KB, represented by (*O*). In addition, we use data augmentation by including additional mentions in the fine-tuning that are extracted from Reddit and annotated on the general-domain KB (Wikipedia), represented by (*A*).

We propose to construct overlapping entities between the general-domain KB and the domain-specific KB using specialized models in semantic text similarity. In addition, we propose to augment the data with mentions from Reddit annotated on the general-domain KB (Wikipedia) to reduce overfitting of the fine-tuned models to the domain-specific dataset.

Briefly, the contributions of this thesis work are summarized in two points as follows:-

- 1) **Extending a New Domain:** Merging general-domain and domain-specific KBs into a single representation space for simultaneous linking by fine-tuning on domain-specific mentions and using data augmentation to reduce overfitting.
- 2) **Handling Overlapping Entities:** Aligning them with similar representations in a single representation space by explicitly learning to maximize their *Dot Product* similarity.

Our framework (CDNEL) improves over the base model BLINK when evaluated against mentions annotated on the domain-specific KB. This evaluation is performed on four domain-specific KBs. In particular, *CA* is the best-performing model variant, which is fine-tuned on mentions with context annotated on the domain-specific KB as well as mentions with context from Reddit annotated on the general-domain KB (Wikipedia) for data augmentation. It improves upon BLINK for all domains and achieves an average gain of 9.5% with respect to *AP@1*. The difference in results between the two systems is statistically significant.

Another evaluation is performed using mentions from Reddit annotated on the general-domain KB. This experiment aims to test the overfitting of the CDNEL variants to the domain-specific KBs. The results show that *CA* is either similar or performs better than BLINK for all domains, proving the comparability of its performance with BLINK, which performs well by default on general-domain mentions. On the other hand, the model variant *COA*, which is further fine-tuned on the overlapping entities between the general-domain KB and the domain-specific KB, has a representation space of the overlapping entities in which they are the most similar with respect to *Cosine Similarity*.

These results support our goal of having a single system, *CA* in our case, that performs well for mentions that should be annotated on the domain-specific KB as well as mentions that should be annotated on the general-domain KB (Wikipedia). Based on the findings of this thesis work, for fine-tuning BLINK on a domain-specific dataset, we recommend including data augmentation in the form of general-domain mentions from Reddit when combining a general-domain KB with a domain-specific KB to perform simultaneous *Entity Linking* to both KBs within the same system. In addition, further fine-tuning on the overlapping entities helps better represent their embeddings, which are as close as possible in the joint representation space.



## 7.2 Future Work

There is a space for adopting the proposed framework for other domain-specific KBs. Possible actions of this work can go in the direction of combining more than two KBs and enabling simultaneous linking to them within the same system. A deeper analysis can be performed on the evaluation of the *Entity Linking* task by measuring the *Cosine Similarity* between the embeddings of the input mention and the gold entity. This analysis will provide a quantitative assessment of the system's quality of *Entity Linking* compared to the base model. In addition, further studies can be conducted to generalize the framework to domain-specific KBs that do not contain information in the form of textual descriptions. Further experiments can be performed using larger datasets in the scenario when mentions annotated on both KBs are from the same document.



# List of Figures

Figure 2.1	Mention-entity graph example by Hoffart <i>et al.</i> (2011) [6]. . . . .	6
Figure 2.2	Model architecture adopted by Kolitsas <i>et al.</i> (2018) [17]. . . . .	7
Figure 2.3	General architecture for a <i>Neural Entity Linking</i> system as stated by Sevgili <i>et al.</i> (2021) [4]. . . . .	7
Figure 2.4	Encoder and decoder architectures constituting the <i>Transformer</i> model by Vaswani <i>et al.</i> (2017) [21]. . . . .	8
Figure 2.5	Pre-training and fine-tuning of BERT model by Devlin <i>et al.</i> (2019) [19]. . . . .	9
Figure 2.6	A simplified example of the representation space of an input mention and various entities in a KB, which can be used in the <i>Candidate Generation</i> phase. . . . .	9
Figure 2.7	Difference between <i>Bi-Encoder</i> and <i>Cross-Encoder</i> architectures. . . . .	10
Figure 3.1	Local neural attention mechanism deployed by Ganea and Hoffmann (2017) [23]. . . . .	12
Figure 3.2	Entity type prediction model for <i>Entity Linking</i> by Onoe and Durrett (2020) [24]. . . . .	12
Figure 3.3	Enhancing the mention-span representations with knowledge from the KB using word-to-entity-span attention by Peters <i>et al.</i> (2019) [25]. . . . .	13
Figure 3.4	Three encoder architectures investigated by Humeau <i>et al.</i> (2019) [26]. . . . .	14
Figure 3.5	Encoding different sources of information provided for an entity by Gupta <i>et al.</i> (2017) [27]. . . . .	14
Figure 3.6	Dual encoder architecture deployed by Gillick <i>et al.</i> (2019) [28]. . . . .	15
Figure 3.7	Three different ways to represent an entity with arbitrary attribute-values by Vias and Ballesteros (2020) [5]. . . . .	16
Figure 3.8	Multiple training and test domains, and the extraction of labelled mentions using hyper-links by Logeswaran <i>et al.</i> (2019) [2]. . . . .	17
Figure 3.9	Full pipeline for the <i>Bi-Encoder</i> and <i>Cross-Encoder</i> architecture adopted by Wu <i>et al.</i> (2020) [1]. . . . .	18
Figure 4.1	<i>Cybersecurity</i> document manual annotation by Inception. . . . .	24
Figure 5.1	BLINK: <i>Candidate Generation</i> . . . . .	28

---

Figure 5.2	BLINK: <i>Candidate Ranking</i> . . . . .	29
Figure 5.3	CDNEL ( <i>D</i> ): <i>Candidate Generation</i> . . . . .	33
Figure 5.4	Dataset components used in the fine-tuning. . . . .	34
Figure 5.5	CDNEL model variants and datasets used in the fine-tuning. . . . .	35
Figure 6.1	$AP@1$ of BLINK vs. CDNEL variants evaluated on mentions annotated on each domain-specific KB. . . . .	41
Figure 6.2	$MAP@10$ of BLINK vs. CDNEL variants evaluated on mentions annotated on each domain-specific KB. . . . .	42
Figure 6.3	$AP@1$ of BLINK vs. CDNEL variants evaluated on Reddit men- tions annotated on the general-domain KB (Wikipedia). . . . .	44
Figure 6.4	$MAP@10$ of BLINK vs. CDNEL variants evaluated on Reddit mentions annotated on the general-domain KB (Wikipedia). . . . .	45

# List of Tables

Table 4.1	Different Fandom domains used in the fine-tuning and evaluation of the proposed approach . . . . .	22
Table 4.2	<i>Average Cosine Similarity</i> measures for the fuzzy overlapping entities for each domain . . . . .	23
Table 4.3	Filtered similar overlapping entities for each domain in Fandom . . . . .	23
Table 4.4	<i>Cybersecurity</i> domain used in the fine-tuning and evaluation of the proposed approach . . . . .	24
Table 4.5	Reddit dataset used in the fine-tuning and evaluation of the proposed approach . . . . .	25
Table 6.1	Modifications used to form different variants of our framework (CDNEL) . . . . .	38
Table 6.2	Hyperparameters configurations used in the fine-tuning and evaluation of BLINK and CDNEL variants . . . . .	38
Table 6.3	Evaluation on mentions annotated on each domain-specific KB. . . . .	41
Table 6.4	P-values at the significance level (alpha) of 0.05 for the evaluation results of each domain. . . . .	42
Table 6.5	Evaluation on Reddit mentions annotated on the general-domain KB (Wikipedia). . . . .	43
Table 6.6	P-values at the significance level (alpha) of 0.05 for the evaluation results of each domain. . . . .	44
Table 6.7	Mentions with context correctly linked by CDNEL variant ( <i>CA</i> ) and wrongly linked by BLINK. . . . .	45
Table 6.8	Intrinsic evaluation of overlapping entities between each domain-specific KB and Wikipedia KB. . . . .	46
Table 6.9	P-values at the significance level (alpha) of 0.05 for the intrinsic evaluation results of each domain. . . . .	47
Table 6.10	Different domains are mixed and used in fine-tuning and evaluating the <i>D</i> variants of CDNEL. . . . .	48
Table 6.11	Evaluation on mentions annotated on the mixed-domain KB and Reddit mentions annotated on the general-domain KB (Wikipedia). . . . .	49

Table 6.12 Evaluation on mentions from the same document annotated on the domain-specific KB (Cybersecurity) and the general-domain KB (Wikipedia). 50

---

# BIBLIOGRAPHY

---

- [1] Ledell Wu, Fabio Petroni, Martin Josifoski, Sebastian Riedel, and Luke Zettlemoyer. Scalable zero-shot entity linking with dense entity retrieval. In Bonnie Webber, Trevor Cohn, Yulan He, and Yang Liu, editors, *Proceedings of the 2020 Conference on Empirical Methods in Natural Language Processing, EMNLP 2020, Online, November 16-20, 2020*, pages 6397–6407. Association for Computational Linguistics, 2020. doi: 10.18653/v1/2020.emnlp-main.519. URL <https://doi.org/10.18653/v1/2020.emnlp-main.519>.
- [2] Lajanugen Logeswaran, Ming-Wei Chang, Kenton Lee, Kristina Toutanova, Jacob Devlin, and Honglak Lee. Zero-shot entity linking by reading entity descriptions. In Anna Korhonen, David R. Traum, and Lluís Màrquez, editors, *Proceedings of the 57th Conference of the Association for Computational Linguistics, ACL 2019, Florence, Italy, July 28- August 2, 2019, Volume 1: Long Papers*, pages 3449–3460. Association for Computational Linguistics, 2019. doi: 10.18653/v1/p19-1335. URL <https://doi.org/10.18653/v1/p19-1335>.
- [3] Nicholas Botzer, Yifan Ding, and Tim Weninger. Reddit entity linking dataset. *Inf. Process. Manag.*, 58(3):102479, 2021. doi: 10.1016/j.ipm.2020.102479. URL <https://doi.org/10.1016/j.ipm.2020.102479>.
- [4] Özge Sevgili, Artem Shelmanov, Mikhail Y. Arkhipov, Alexander Panchenko, and Chris Biemann. Neural entity linking: A survey of models based on deep learning. *CoRR*, abs/2006.00575, 2020. URL <https://arxiv.org/abs/2006.00575>.
- [5] Yogarshi Vyas and Miguel Ballesteros. Linking entities to unseen knowledge bases with arbitrary schemas. In Kristina Toutanova, Anna Rumshisky, Luke Zettlemoyer, Dilek Hakkani-Tür, Iz Beltagy, Steven Bethard, Ryan Cotterell, Tanmoy Chakraborty, and Yichao Zhou, editors, *Proceedings of the 2021 Conference of the North American Chapter of the Association for Computational Linguistics: Human Language Technologies, NAACL-HLT 2021, Online, June 6-11, 2021*, pages 834–844. Association for Computational Linguistics, 2021. doi: 10.18653/v1/2021.naacl-main.65. URL <https://doi.org/10.18653/v1/2021.naacl-main.65>.
- [6] Johannes Hoffart, Mohamed Amir Yosef, Ilaria Bordino, Hagen Fürstenaу, Manfred Pinkal, Marc Spaniol, Bilyana Taneva, Stefan Thater, and Gerhard Weikum.

- Robust disambiguation of named entities in text. In *Proceedings of the 2011 Conference on Empirical Methods in Natural Language Processing, EMNLP 2011, 27-31 July 2011, John McIntyre Conference Centre, Edinburgh, UK, A meeting of SIGDAT, a Special Interest Group of the ACL*, pages 782–792. ACL, 2011. URL <https://aclanthology.org/D11-1072/>.
- [7] Rada Mihalcea and Andras Csomai. Wikify!: linking documents to encyclopedic knowledge. In Mário J. Silva, Alberto H. F. Laender, Ricardo A. Baeza-Yates, Deborah L. McGuinness, Bjørn Olstad, Øystein Haug Olsen, and André O. Falcão, editors, *Proceedings of the Sixteenth ACM Conference on Information and Knowledge Management, CIKM 2007, Lisbon, Portugal, November 6-10, 2007*, pages 233–242. ACM, 2007. doi: 10.1145/1321440.1321475. URL <https://doi.org/10.1145/1321440.1321475>.
- [8] Takuo Hamaguchi, Hidekazu Oiwa, Masashi Shimbo, and Yuji Matsumoto. Knowledge transfer for out-of-knowledge-base entities : A graph neural network approach. In Carles Sierra, editor, *Proceedings of the Twenty-Sixth International Joint Conference on Artificial Intelligence, IJCAI 2017, Melbourne, Australia, August 19-25, 2017*, pages 1802–1808. ijcai.org, 2017. doi: 10.24963/ijcai.2017/250. URL <https://doi.org/10.24963/ijcai.2017/250>.
- [9] Pablo N. Mendes, Max Jakob, Andrés García-Silva, and Christian Bizer. Dbpedia spotlight: shedding light on the web of documents. In Chiara Ghidini, Axel-Cyrille Ngonga Ngomo, Stefanie N. Lindstaedt, and Tassilo Pellegrini, editors, *Proceedings the 7th International Conference on Semantic Systems, I-SEMANTICS 2011, Graz, Austria, September 7-9, 2011*, ACM International Conference Proceeding Series, pages 1–8. ACM, 2011. doi: 10.1145/2063518.2063519. URL <https://doi.org/10.1145/2063518.2063519>.
- [10] Francesco Piccinno and Paolo Ferragina. From tagme to WAT: a new entity annotator. In David Carmel, Ming-Wei Chang, Evgeniy Gabrilovich, Bo-June Paul Hsu, and Kuansan Wang, editors, *ERD’14, Proceedings of the First ACM International Workshop on Entity Recognition & Disambiguation, July 11, 2014, Gold Coast, Queensland, Australia*, pages 55–62. ACM, 2014. doi: 10.1145/2633211.2634350. URL <https://doi.org/10.1145/2633211.2634350>.
- [11] Andrea Moro, Alessandro Raganato, and Roberto Navigli. Entity linking meets word sense disambiguation: a unified approach. *Trans. Assoc. Comput. Linguistics*, 2:231–244, 2014. URL <https://tacl2013.cs.columbia.edu/ojs/index.php/tacl/article/view/291>.



- [12] Octavian-Eugen Ganea, Marina Ganea, Aurélien Lucchi, Carsten Eickhoff, and Thomas Hofmann. Probabilistic bag-of-hyperlinks model for entity linking. In Jacqueline Bourdeau, Jim Hendler, Roger Nkambou, Ian Horrocks, and Ben Y. Zhao, editors, *Proceedings of the 25th International Conference on World Wide Web, WWW 2016, Montreal, Canada, April 11 - 15, 2016*, pages 927–938. ACM, 2016. doi: 10.1145/2872427.2882988. URL <https://doi.org/10.1145/2872427.2882988>.
- [13] Heng Ji, Ralph Grishman, Hoa Trang Dang, Kira Griffitt, and Joe Ellis. Overview of the tac 2010 knowledge base population track. In *Third text analysis conference (TAC 2010)*, volume 3, pages 3–3, 2010.
- [14] Johannes Hoffart, Stephan Seufert, Dat Ba Nguyen, Martin Theobald, and Gerhard Weikum. KORE: keyphrase overlap relatedness for entity disambiguation. In Xuewen Chen, Guy Lebanon, Haixun Wang, and Mohammed J. Zaki, editors, *21st ACM International Conference on Information and Knowledge Management, CIKM'12, Maui, HI, USA, October 29 - November 02, 2012*, pages 545–554. ACM, 2012. doi: 10.1145/2396761.2396832. URL <https://doi.org/10.1145/2396761.2396832>.
- [15] Lev-Arie Ratinov, Dan Roth, Doug Downey, and Mike Anderson. Local and global algorithms for disambiguation to wikipedia. In Dekang Lin, Yuji Matsumoto, and Rada Mihalcea, editors, *The 49th Annual Meeting of the Association for Computational Linguistics: Human Language Technologies, Proceedings of the Conference, 19-24 June, 2011, Portland, Oregon, USA*, pages 1375–1384. The Association for Computer Linguistics, 2011. URL <https://aclanthology.org/P11-1138/>.
- [16] Yotam Eshel, Noam Cohen, Kira Radinsky, Shaul Markovitch, Ikuya Yamada, and Omer Levy. Named entity disambiguation for noisy text. In Roger Levy and Lucia Specia, editors, *Proceedings of the 21st Conference on Computational Natural Language Learning (CoNLL 2017), Vancouver, Canada, August 3-4, 2017*, pages 58–68. Association for Computational Linguistics, 2017. doi: 10.18653/v1/K17-1008. URL <https://doi.org/10.18653/v1/K17-1008>.
- [17] Nikolaos Kolitsas, Octavian-Eugen Ganea, and Thomas Hofmann. End-to-end neural entity linking. In Anna Korhonen and Ivan Titov, editors, *Proceedings of the 22nd Conference on Computational Natural Language Learning, CoNLL 2018, Brussels, Belgium, October 31 - November 1, 2018*, pages 519–529. Association for Computational Linguistics, 2018. doi: 10.18653/v1/k18-1050. URL <https://doi.org/10.18653/v1/k18-1050>.
- [18] Tomáš Mikolov, Ilya Sutskever, Kai Chen, Gregory S. Corrado, and Jeffrey Dean. Distributed representations of words and phrases and their compositionality. In

- Christopher J. C. Burges, Léon Bottou, Zoubin Ghahramani, and Kilian Q. Weinberger, editors, *Advances in Neural Information Processing Systems 26: 27th Annual Conference on Neural Information Processing Systems 2013. Proceedings of a meeting held December 5-8, 2013, Lake Tahoe, Nevada, United States*, pages 3111–3119, 2013. URL <https://proceedings.neurips.cc/paper/2013/hash/9aa42b31882ec039965f3c4923ce901b-Abstract.html>.
- [19] Jacob Devlin, Ming-Wei Chang, Kenton Lee, and Kristina Toutanova. BERT: pre-training of deep bidirectional transformers for language understanding. In Jill Burstein, Christy Doran, and Thamar Solorio, editors, *Proceedings of the 2019 Conference of the North American Chapter of the Association for Computational Linguistics: Human Language Technologies, NAACL-HLT 2019, Minneapolis, MN, USA, June 2-7, 2019, Volume 1 (Long and Short Papers)*, pages 4171–4186. Association for Computational Linguistics, 2019. doi: 10.18653/v1/n19-1423. URL <https://doi.org/10.18653/v1/n19-1423>.
- [20] Samuel Broscheit. Investigating entity knowledge in BERT with simple neural end-to-end entity linking. In Mohit Bansal and Aline Villavicencio, editors, *Proceedings of the 23rd Conference on Computational Natural Language Learning, CoNLL 2019, Hong Kong, China, November 3-4, 2019*, pages 677–685. Association for Computational Linguistics, 2019. doi: 10.18653/v1/K19-1063. URL <https://doi.org/10.18653/v1/K19-1063>.
- [21] Ashish Vaswani, Noam Shazeer, Niki Parmar, Jakob Uszkoreit, Llion Jones, Aidan N. Gomez, Lukasz Kaiser, and Illia Polosukhin. Attention is all you need. In Isabelle Guyon, Ulrike von Luxburg, Samy Bengio, Hanna M. Wallach, Rob Fergus, S. V. N. Vishwanathan, and Roman Garnett, editors, *Advances in Neural Information Processing Systems 30: Annual Conference on Neural Information Processing Systems 2017, December 4-9, 2017, Long Beach, CA, USA*, pages 5998–6008, 2017. URL <https://proceedings.neurips.cc/paper/2017/hash/3f5ee243547dee91fbd053c1c4a845aa-Abstract.html>.
- [22] Nils Reimers and Iryna Gurevych. Sentence-bert: Sentence embeddings using siamese bert-networks. In Kentaro Inui, Jing Jiang, Vincent Ng, and Xiaojun Wan, editors, *Proceedings of the 2019 Conference on Empirical Methods in Natural Language Processing and the 9th International Joint Conference on Natural Language Processing, EMNLP-IJCNLP 2019, Hong Kong, China, November 3-7, 2019*, pages 3980–3990. Association for Computational Linguistics, 2019. doi: 10.18653/v1/D19-1410. URL <https://doi.org/10.18653/v1/D19-1410>.

- [23] Octavian-Eugen Ganea and Thomas Hofmann. Deep joint entity disambiguation with local neural attention. In Martha Palmer, Rebecca Hwa, and Sebastian Riedel, editors, *Proceedings of the 2017 Conference on Empirical Methods in Natural Language Processing, EMNLP 2017, Copenhagen, Denmark, September 9-11, 2017*, pages 2619–2629. Association for Computational Linguistics, 2017. doi: 10.18653/v1/d17-1277. URL <https://doi.org/10.18653/v1/d17-1277>.
- [24] Yasumasa Onoe and Greg Durrett. Fine-grained entity typing for domain independent entity linking. In *The Thirty-Fourth AAAI Conference on Artificial Intelligence, AAAI 2020, The Thirty-Second Innovative Applications of Artificial Intelligence Conference, IAAI 2020, The Tenth AAAI Symposium on Educational Advances in Artificial Intelligence, EAAI 2020, New York, NY, USA, February 7-12, 2020*, pages 8576–8583. AAAI Press, 2020. URL <https://aaai.org/ojs/index.php/AAAI/article/view/6380>.
- [25] Matthew E. Peters, Mark Neumann, Robert L. Logan IV, Roy Schwartz, Vidur Joshi, Sameer Singh, and Noah A. Smith. Knowledge enhanced contextual word representations. In Kentaro Inui, Jing Jiang, Vincent Ng, and Xiaojun Wan, editors, *Proceedings of the 2019 Conference on Empirical Methods in Natural Language Processing and the 9th International Joint Conference on Natural Language Processing, EMNLP-IJCNLP 2019, Hong Kong, China, November 3-7, 2019*, pages 43–54. Association for Computational Linguistics, 2019. doi: 10.18653/v1/D19-1005. URL <https://doi.org/10.18653/v1/D19-1005>.
- [26] Samuel Humeau, Kurt Shuster, Marie-Anne Lachaux, and Jason Weston. Poly-encoders: Architectures and pre-training strategies for fast and accurate multi-sentence scoring. In *8th International Conference on Learning Representations, ICLR 2020, Addis Ababa, Ethiopia, April 26-30, 2020*. OpenReview.net, 2020. URL <https://openreview.net/forum?id=SkxgnnNFvH>.
- [27] Nitish Gupta, Sameer Singh, and Dan Roth. Entity linking via joint encoding of types, descriptions, and context. In Martha Palmer, Rebecca Hwa, and Sebastian Riedel, editors, *Proceedings of the 2017 Conference on Empirical Methods in Natural Language Processing, EMNLP 2017, Copenhagen, Denmark, September 9-11, 2017*, pages 2681–2690. Association for Computational Linguistics, 2017. doi: 10.18653/v1/d17-1284. URL <https://doi.org/10.18653/v1/d17-1284>.
- [28] Daniel Gillick, Sayali Kulkarni, Larry Lansing, Alessandro Presta, Jason Baldrige, Eugene Ie, and Diego García-Olano. Learning dense representations for entity retrieval. In Mohit Bansal and Aline Villavicencio, editors, *Proceedings of the 23rd Conference on Computational Natural Language Learning, CoNLL 2019, Hong*

- Kong, China, November 3-4, 2019*, pages 528–537. Association for Computational Linguistics, 2019. doi: 10.18653/v1/K19-1049. URL <https://doi.org/10.18653/v1/K19-1049>.
- [29] Daniel M. Cer, Mona T. Diab, Eneko Agirre, Iñigo Lopez-Gazpio, and Lucia Specia. Semeval-2017 task 1: Semantic textual similarity - multilingual and cross-lingual focused evaluation. *CoRR*, abs/1708.00055, 2017. URL <http://arxiv.org/abs/1708.00055>.
- [30] Jan-Christoph Klie, Michael Bugert, Beto Boulosa, Richard Eckart de Castilho, and Iryna Gurevych. The inception platform: Machine-assisted and knowledge-oriented interactive annotation. In Dongyan Zhao, editor, *COLING 2018, The 27th International Conference on Computational Linguistics: System Demonstrations, Santa Fe, New Mexico, August 20-26, 2018*, pages 5–9. Association for Computational Linguistics, 2018. URL <https://aclanthology.org/C18-2002/>.
- [31] Rotem Dror, Gili Baumer, Segev Shlomov, and Roi Reichart. The hitchhiker’s guide to testing statistical significance in natural language processing. In Iryna Gurevych and Yusuke Miyao, editors, *Proceedings of the 56th Annual Meeting of the Association for Computational Linguistics, ACL 2018, Melbourne, Australia, July 15-20, 2018, Volume 1: Long Papers*, pages 1383–1392. Association for Computational Linguistics, 2018. doi: 10.18653/v1/P18-1128. URL <https://aclanthology.org/P18-1128/>.
- [32] Mark D. Smucker, James Allan, and Ben Carterette. A comparison of statistical significance tests for information retrieval evaluation. In Mário J. Silva, Alberto H. F. Laender, Ricardo A. Baeza-Yates, Deborah L. McGuinness, Bjørn Olstad, Øystein Haug Olsen, and André O. Falcão, editors, *Proceedings of the Sixteenth ACM Conference on Information and Knowledge Management, CIKM 2007, Lisbon, Portugal, November 6-10, 2007*, pages 623–632. ACM, 2007. doi: 10.1145/1321440.1321528. URL <https://doi.org/10.1145/1321440.1321528>.