

# Connectivity-Aware Contract for Incentivizing IoT Devices in Complex Wireless Blockchain

Weiye Wang, Jin Chen, Yutao Jiao, Jiawen Kang, Wenting Dai, and Yuhua Xu

**Abstract**—Blockchain is considered the critical backbone technology for secure and trusted Internet of Things (IoT) in the future 6G network. However, deploying a blockchain system in a complex wireless IoT network is challenging due to the limited resources, complex wireless environment, and the property of self-interested IoT devices. The existing incentive mechanism of blockchain is not compatible with the wireless IoT network. In this paper, to incentivize IoT devices to join the construction of the wireless blockchain network, we propose a multi-dimensional contract to optimize the blockchain utility while addressing the issues of adverse selection and moral hazard. Specifically, the proposed contract considers the IoT device’s hash power and communication cost and especially explores the connectivity of devices from the perspective of complex network theory. We investigate the energy consumption and the block confirmation probability of the wireless blockchain network via simulations under varied network sizes and average link probability. Numerical results demonstrate that our proposed contract mechanism is feasible, achieves 35% more utility than existing approaches, and increases utility by 4 times compared with the original PoW-based incentive mechanism.

**Index Terms**—Blockchain, IoT, incentive mechanism, contract theory, wireless network, complex network.

## I. INTRODUCTION

**B**LOCKCHAIN, also known as distributed ledger technology (DLT), has attracted substantial interest. Due to the distributed, cryptographic, immutable, token, and decentralized characteristics, blockchain shows excellent potential to be a critical technology for securing future 6G networks. Nowadays, blockchain is not only applied in the field of finance (e.g., cryptocurrency [1]) but also in the Internet of Things (IoT) [2]. The authors in [3] used blockchain to record the node’s trust value, which is utilized to differentiate the malicious node. Similarly, the authors in [4] proposed a consensus management scheme to ensure secure miner selection in the Internet of Vehicles (IoV). Blockchain was used to store reputation and provide trust in the IoV network. Most current works focus on the blockchain-based scenario and assume that the blockchain has been deployed and well-operated. However, the IoT network usually has a complex wireless environment, which influences the blockchain performance and challenges

deploying the wireless blockchain. The authors in [5] analyzed the impact of transmission power on blockchain consensus in the wireless network. In [6], the authors derived that the device’s connectivity determines the forking rate.

Nevertheless, only some works consider wireless communication when using blockchain in IoT networks. On the one hand, the IoT device’s complex wireless network topology significantly affects blockchain performance. On the other hand, the limited energy of IoT devices reduces their willingness to join the blockchain. As the most widely used consensus mechanism, Proof-of-Work (PoW) consensus requires participants to consume energy and resources to solve the hash puzzle. Unfortunately, most IoT devices have limited battery capacity, restricted communication and computing capabilities, and lack the motivation to participate in the blockchain network. Besides, existing PoW-based incentive mechanisms allocate the same rewards for devices while neglecting their heterogeneity. During block propagation, the IoT devices’ transmission power influence the communication efficiency, and the network connectivity affects the propagation delay. Thus, there needs to design an adequate incentive mechanism for deploying blockchain in the IoT network.

To encourage IoT devices to join the wireless blockchain network, we need to consider the above heterogeneous and limited capabilities of IoT devices and design a desirable incentive mechanism in reward allocation. The incentive mechanism also needs to assess the quality of the work. For one thing, the IoT device may work passively, and for another, the block is at risk of confirmation failure due to the forking or communication outage. Therefore, the incentive mechanism should have the following properties: 1) Modeling the impact of both computing and wireless communication factors on blockchain performance and IoT devices’ energy consumption; 2) Reflecting the IoT devices’ actual capabilities and preferences; 3) Distributing rewards based on the quality of task completion.

Contract theory is an effective method to address the issues of information asymmetry and passive behavior. Since wireless blockchain performance is related to multiple factors, we design a multi-dimensional contract to incentivize heterogeneous IoT devices to maximize blockchain utility. In our proposed contract, the blockchain utility is designed based on the duration of participating in the blockchain network, and the IoT device’s task is to generate blocks. The more IoT devices join the blockchain, and the more blocks are proposed, the more utility the blockchain obtains. We respectively analyze the impact of hash power  $c$ , transmission power  $p$ , and connectivity  $c$  on block propagation and energy consumption.

Weiye Wang, Jin Chen, Yutao Jiao, and Yuhua Xu are with the College of Communications Engineering, Army Engineering University of PLA, Nanjing 210007, China.

Jiawen Kang is with the School of Automation, Guangdong University of Technology, Guangzhou 510006, China, and also with the Key Laboratory of Intelligent Information Processing and System Integration of IoT, Ministry of Education, Guangzhou 510006, China.

Wenting Dai is with the School of Communications and Information Engineering, Nanjing University of Posts and Telecommunications, Nanjing 210003, China.

The main contributions of this paper can be summarized as follows:

- We design a novel multi-dimensional contract model addressing both *adverse selection* and *moral hazard* for maximizing the blockchain utility in the wireless IoT network. The *adverse selection* is used to reveal the actual capabilities of wireless IoT devices and their preference. The *moral hazard* measures the quality of the task completion.
- To incentivize IoT devices to join the wireless blockchain, our contract jointly considers IoT devices' hash power, transmission power, and connectivity. We analyze how these factors determine energy consumption and block confirmation probability.
- Particularly, we characterize and verify the logarithmic relationship between the connectivity and confirmation probability by the experimental results. We also find that the device's connectivity significantly impacts the block confirmation probability under varied network sizes and average link probability.
- The numerical results demonstrate that the proposed contract efficiently incentivizes the IoT devices, improves blockchain utility by 35% compared with the contract with adverse selection and increases utility by 4 times compared with the original PoW-based incentive mechanism.

The rest of this paper is organized as follows. Section II reviews the related work. Section III presents the system model and the performance metrics of the wireless blockchain network and IoT devices. The optimal multi-dimensional contract is proposed in Section IV. Section V presents the numerical results to validate the contract's feasibility and effectiveness. Finally, Section VI concludes the paper. Table 1 lists the main notations of this paper.

TABLE I  
MAIN NOTATIONS

Notation	Definition
$Z$	Number of IoT devices
$L$	Number of IoT devices' types
$P_l$	Average link probability of the network
$Q$	Probability distribution function for the type
$G_i$	Confirmation probability of the type $i$ device
$F_i$	Energy cost of the type $i$ device
$P_h$	Block confirmation probability determined by hash power
$P_c$	Block confirmation probability determined by connectivity
$P_{out}$	Communication outage probability
$a$	Block size
$h_i$	Hash power of the type $i$ device
$c_i$	Connectivity of the type $i$ device
$p_i$	Transmission power of the type $i$ device
$\lambda$	Converted type of IoT device
$e_i$	Number of blocks proposed by the type $i$ device
$s_i$	Salary for the type $i$ device
$B_i$	Bonus for the type $i$ device
$b_i$	Unit bonus for the type $i$ device
$\omega_i$	Contract item for the type $i$ device
$\theta$	Time cost coefficient
$\varepsilon$	Yield coefficient
$\gamma$	Energy cost coefficient
$r$	Transmission rate
$\tau$	Average block interval

## II. RELATED WORK

### A. Blockchain for IoT

Since Satoshi Nakamoto proposed bitcoin in 2008 [1], blockchain has attracted lots of attention. Incipiently, blockchain is used in the cryptocurrency field, and the birth of Ethereum extended the application of blockchain. Ethereum introduces the smart contract [7], where the code will run automatically while satisfying the input criteria. Currently, there are many works combining the IoT and blockchain. The authors in [8] analyzed the opportunities and challenges of applying blockchain in IoT. In [9], the authors proposed a distributed consensus protocol for the Internet of Vehicles (IoV) and enhanced the system's stability. However, adding a negative vote to the consensus mechanism may reduce security. The authors in [3] proposed the blockchain-based trust management system in mobile ad-hoc networks, where the computing complexity of the consensus algorithm is decreased. But the algorithm can't deal with the situation when the neighbors of the node are all malicious. A reputation-based routing method using blockchain is provided in a mobile ad-hoc network [10]. In this protocol, nodes select the routing path to forward, considering the length and reputation. In [4], the authors investigated the blockchain-enabled IoV to enhance network security. They calculate reputations for every participant and vote miners based on reputations. The authors in [11] designed a blockchain-based wireless IoT model and provided throughput analyses. They derived the optimal full node deployment and analyzed the model's security under attacks. In [12], the authors studied the existing Direct Acyclic Graph (DAG) consensus protocols designed for IoT. The research shows that the Tangle [13] and Hashgraph [14] are more suitable for IoT than Proof of Work (PoW) and Proof of Stake (PoS). However, the security of DAG-based consensus needs to be verified.

Recently, some research has been focusing on the protocol analysis and resource allocation of the blockchain network. The authors investigated the information propagation in bitcoin and presented three schemes to improve the propagation delay [15]. Though the third scheme decreases the propagation delay, it has a high demand on the communication bandwidth. In [16], the authors studied the impact of mobility on block propagation in the vehicular network. They gave the closed-form expression of the single-block propagation time and found that high mobility and connectivity speed up the block propagation. The authors in [17] proposed a theoretical model for analyzing block propagation in the bitcoin network. They modeled the performance using a random graph model and derived the explicit equations of block propagation delay. The energy consumption of blockchain was discussed and explored in [18] and [19]. But they mainly focus on the energy consumption of computing, neglecting communication. The authors in [20] proposed a resource allocation scheme to minimize the cost of access and storage in a blockchain-based edge computing network. The proposed method applies to the scenario where the network topology changes slowly. There are also some works aware of the impact of communication on blockchain performance. The authors in [21] investigated

how communication reliability affects the PoW consensus mechanism. They analyzed blockchain security from a new perspective but just gave a simple qualitative analysis. While guaranteeing the safety of the Practical Byzantine Fault Tolerance (PBFT) protocol, the authors in [22] showed the minimum transmission power of nodes in the wireless network. But the paper just considers the transmission power and lacks analyses of other wireless factors. In [6], the authors proposed a probability analytic model that evaluated blockchain security considering the node's connectivity and computing power. The authors in [23] investigated the communication resource consumption in the wireless blockchain network and analyzed the communication resources required by different consensus protocols. This paper makes a qualitative analysis of various consensus agreements but lacks in-depth exploration. The authors combined the blockchain and the access protocol to investigate the blockchain throughput in [24]. They assumed that there were only block messages in channels, which is unreasonable. The authors discussed blockchain-enabled wireless applications and proposed a wireless blockchain middleware architecture [25]. They provided several research directions for wireless blockchain. In [26], authors analyzed the function of blockchain for next-generation computing. Their work showed that blockchain has great potential in cloud/fog/edge computing. The authors in [27] investigated the Sybil attacks in sharding-based blockchain protocols and gave a tractable probabilistic approach to evaluate blockchain security. However, fewer works consider the impact of communication factors on blockchain performance, especially in a complex wireless environment.

### B. Incentive Mechanism for Blockchain Network

Contract theory is a typical mechanism design method in real-world economics and has been widely used to model the relationship between employers and employees [28]. Applying the mechanism design approach to the wireless IoT network has been investigated widely [29], [30], and [31]. Moreover, integrating blockchain and incentive mechanisms is also a hot topic. In Bitcoin and Ethereum, miners consume their computing power to solve the hash puzzle and obtain the corresponding tokens [1] and [7]. Besides, miners could select transactions to place on the block to earn transaction fees, which is considered a first-price auction. In [32], the author analyzed the EIP-1559 of Ethereum. This mechanism divides the transaction fee into base fee and tips, where the base fee is paid to miners, and the tips are burned. In Storj [33], participants contribute their storage and bandwidth to obtain tokens. Not all incentive mechanisms provide rewards. In Casper [34], devices will be punished if they sign on conflicting blocks. In [35], the authors utilized the auction to allocate computing resources in blockchain networks. They proposed two schemes to satisfy miners' demands flexibly. The authors in [36] summarized blockchain-based auction applications and expounded the auction-based solutions for blockchain enhancement. The authors in [37] studied how to determine the deposit threshold using contract theory in the sharded blockchain. They designed a one-dimensional contract

to decide different deposit thresholds for heterogeneous users, which provides more opportunities for participants with low stake values.

However, the above works do not tackle the problem of incentive mechanism design for blockchain deployment in the complex wireless network. In the IoT network, the communication and computing capabilities of devices both decide the block confirmation. Nevertheless, the traditional incentive mechanism just allocates token rewards according to the computing capacity, which is inappropriate for the wireless blockchain network. In addition, the classical PoW-based incentive mechanism provides the same rewards for devices. Under this scheme of allocation policy, powerful devices may dissatisfy with the received rewards since they consume more resources and low-energy devices have no motivation to join the blockchain due to uncertain incentives. Therefore, we design a multi-dimensional contract containing IoT devices' cost and confirmation probability to incentivize them in the complex wireless blockchain network. Our contract provides a guaranteed reward for participants.

### III. SYSTEM MODEL: INCENTIVE MECHANISM FOR WIRELESS BLOCKCHAIN NETWORK IN IoT

In this section, we describe the integrated system of blockchain and IoT in the complex wireless network. As is shown in Fig. 1, there are many kinds of IoT devices in the wireless network, such as mobile phones, laptops, UAVs, intelligent robots, etc. The blockchain developer aims to attract more IoT devices to participate in the wireless blockchain network. Nevertheless, IoT devices lack the motivation to maintain blockchain due to time and energy consumption. Thus, the developer uses contract theory to incentivize IoT devices to join the blockchain network while maximizing the blockchain utility. First, the blockchain developer collects the distribution of IoT devices' capabilities in advance to deploy the blockchain better and design contracts based on the information. The contracts are stored in the blockchain in the form of smart contracts. After selecting a contract, the IoT devices form the miner networks and operate the wireless blockchain protocol according to the signed contract for securing the blockchain. Finally, the blockchain developer inspects the quality of tasks and sends rewards to IoT devices.

#### A. Complex Wireless Blockchain Network

IoT devices are heterogeneous in computing and communication capabilities in the complex wireless blockchain system. Additionally, IoT devices communicate with others via unreliable wireless links, where communication outages are common. Another important metric in the complex wireless network is connectivity. The device's connectivity reflects its communication advantage and has a significant impact on the block propagation delay. Deploying the blockchain in the complex wireless network not only takes into account the heterogeneity of the IoT devices but also the impact of communication factors on blockchain performance.

Unlike traditional PoW-based blockchains, the hash power  $h$  is the dominant factor affecting consensus. By contrast,

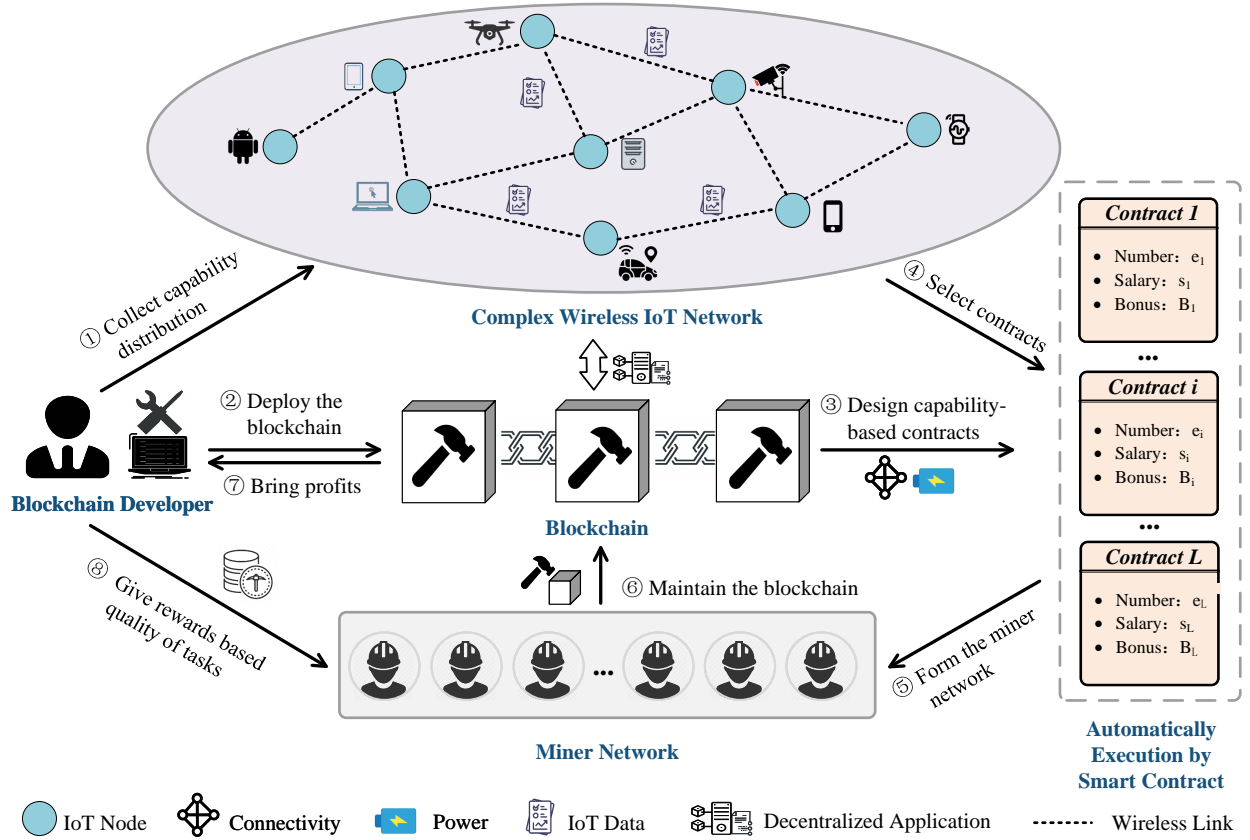

Fig. 1. The integrated system of blockchain and IoT in the complex wireless network.

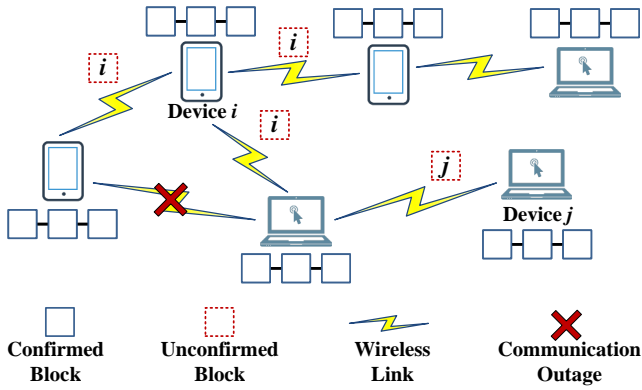

Fig. 2. The forking event in the wireless blockchain network.

communication factors have trivial effects on consensus. Nevertheless, both transmission power  $p$  and connectivity  $c$  significantly influence the block confirmation probability in the wireless blockchain and further influence consensus. As shown in Fig. 2, both device  $i$  and device  $j$  propose the block at height 16. According to the longest legal chain principle, only one block will be confirmed, and the other will be abandoned. Device  $i$  has a higher transmission power  $p$  and connectivity  $c$  so that its block is accepted faster by other devices. Thus, the block proposed by device  $i$  is more likely to be confirmed and wins the competition of the forking. This paper considers the

two-prong forking, the most pervasive and possible situation.

Due to the influence of the complex network, the classical PoW-based incentive mechanism is not compatible well. For one thing, the reward is the same for all IoT devices, regardless of cost. For another, the complex wireless network increases the risk of forking, which also reduces IoT devices' motivation to join the blockchain. Thus, we design a multi-dimensional contract  $(e, R)$  to address the issues. The variable  $e$  represents the number of blocks in the longest legal chain, and  $R$  is the reward distributed to the IoT device. The reward  $R$  is defined as follows:

$$R = s + B, \quad (1)$$

$$B = be, \quad (2)$$

where  $s$  is the fixed salary,  $B$  is the bonus, and  $b$  is the unit bonus. The salary represents the basic income, and the bonus is related to the proposed blocks. The more blocks proposed, the more bonuses the IoT device obtains.

With the basic requirement of an effective contract, our proposed contract should also satisfy the following properties:

- *Individual Rationality* (IR). IR condition means that the IoT devices can obtain positive utility while signing the contract, which is the foundation for incentivizing the device to join the wireless blockchain.

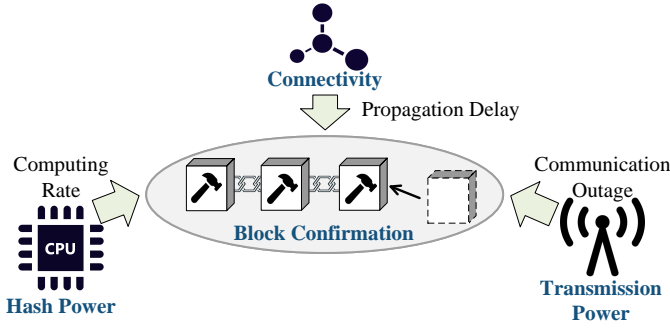

Fig. 3. The impact of IoT device's capabilities on the block confirmation in the wireless blockchain network.

- *Incentive Compatibility (IC)*. IC condition means that every IoT device can only achieve the maximum utility by choosing the contract according to its actual computing and communication capability. It helps the contract designer be aware of the true preference of IoT devices.

### B. IoT Device Model in Wireless Blockchain Network

In the energy-constrained wireless network, energy is precious for IoT devices. Unlike traditional blockchain networks, the device costs a similar amount of energy to communicate compared to computing in the wireless blockchain. First, we analyze the energy consumption of maintaining the blockchain considering the hash power  $h$ , transmission power  $p$ , and connectivity  $c$ . Centrality is a metric to measure the influence of information propagation. In this paper, we use degree centrality to evaluate the connectivity, which reflects the number of the device's neighbors. The hash power determines the energy consumption of computing, and the energy consumption of communication is related to the connectivity  $c$  and transmission power  $p$ . The total energy consumption of proposing a block is given as follows:

$$E_b = h\tau + \frac{a}{r}pc, \quad (3)$$

where  $\tau$  is the average block interval,  $a$  is the block size, and  $r$  is the transmission rate. The first term denotes the energy consumption for solving the hash puzzle, while the second denotes the energy consumption for propagating the block.

Next, we discuss the confirmation probability  $G$  of IoT devices. As shown in Fig. 3, the hash power  $h$ , transmission power  $p$ , and connectivity  $c$  affect the block confirmation in different aspects. Higher hash power brings a faster mining rate and increases the probability that its prong becomes the longest legal chain. The transmission power determines the Single to Noise Ratio (SNR), which is negatively correlated with the communication outage probability. The connectivity reflects the number of other IoT devices connected to the device and influences the block propagation delay.

When a forking occurs in the wireless blockchain network, we assume that half of IoT devices in the network accept block  $i$  (i.e., the block proposed by device  $i$ ), and the rest accept block  $j$ . We define  $H_{-i,j}$  is the gross hash power of the network except for devices  $i$  and  $j$ . Thus, the hash power

of the prong  $i$  is  $H_{-i,j}/2 + h_i$  and the hash power of prong  $j$  is  $H_{-i,j}/2 + h_j$ . The confirmation probability  $P_h$  of block  $i$  determined by hash power is:

$$P_h = \frac{H_{-i,j}/2 + h_i}{H} = \frac{0.5(Z-2)\bar{h} + h_i}{Z\bar{h}}, \quad (4)$$

where  $Z$  is the network size, and  $\bar{h}$  is the hash power expectation of the IoT device. Since the IoT device cannot know the hash power of others, we use the hash power expectation to estimate. In the IoT network, the hash power has little difference among devices and slightly affects the block confirmation, especially when the network size  $Z$  is large.

Communication outage is universal in the wireless network due to the randomness and uncertainty of wireless channels. Here, we just consider the outage event caused by signal fading. We assume that the signal fading is exponentially distributed  $|\alpha|^2$  with parameter  $\sigma^2$ . Inspired by [38], we derive the outage probability as follows:

$$P_{out} = \Pr\{|\alpha|^2 < \frac{2^\delta - 1}{\rho}\} = 1 - \exp(-\frac{2^\delta - 1}{\rho\sigma^2}), \quad (5)$$

$$\delta = \frac{r}{B}, \quad (6)$$

$$\rho = \frac{p}{N_0}, \quad (7)$$

where  $B$  is the bandwidth,  $\rho$  is the SNR,  $\delta$  is the spectral efficiency and  $N_0$  is noise power. From equations (5), (6), and (7), we find that the transmission power  $p$  determines the communication outage probability during the block propagation process.

The impact of connectivity on confirmation probability is through influencing the block propagation delay. As we mentioned before, we use degree centrality to evaluate the connectivity  $c$ , which reflects the number of neighbors of the IoT device. However, the degree centrality is related to the network size  $Z$  and the average link probability  $P_l$ . For example, the same degree centrality has different effects on the confirmation probability under different network sizes or average link probability. Therefore, it is difficult and unrealistic to model the relationship between the connectivity and confirmation probability without considering the network size and the averaged link probability. Given the network size  $Z$  and the average link probability  $P_l$ , the confirmation probability  $P_c$  determined by connectivity  $c$  can be represented as follows:

$$P_c = \beta_1 - \beta_2 \ln(c + \beta_3), \quad (8)$$

where  $\beta_1$ ,  $\beta_2$ , and  $\beta_3$  are curve-fitting parameters. The curve-fitting approach is typical in the literature and has been widely adopted. Note that the function is universal to model the connectivity  $c$  and confirmation probability  $P_c$ , and we just modify the parameters in different network sizes and average link probability. We further discuss the combined impact of  $c$ ,  $Z$ , and  $P_l$  on confirmation probability in Section VI.

Based on equations (5) and (8), we can derive the total confirmation probability  $G$  as follows:

$$G(h, c, p) = [P_F P_h + (1 - P_F)] P_c (1 - P_{out}), \quad (9)$$

where  $P_F$  is the probability of occurring the forking. In our paper, the forking probability is set to 0.5.

Then, according to equations (3) and (9), we can give the utility function  $U_D$  of the IoT device as:

$$U_D = s + G(h, c, p) b e - \frac{1}{2} F(h, c, p) e^2 - \varphi, \quad (10)$$

$$F(h, c, p) = \gamma E_b, \quad (11)$$

$$\varphi = \theta s, \quad (12)$$

where  $F$  and  $\varphi$  denote the cost function of energy and time, respectively,  $\gamma$  is the energy cost coefficient, and  $\theta$  is the time cost coefficient. Similar to [37], we set the energy cost function as a quadratic function concerning the number of blocks, which is widely applied in the literature. Equation (12) represents the time of the IoT device contributing to the blockchain network, and we consider that time is positively correlated with the reward. Consequently, we set the time cost as a linear function of salary, and the time cost increases with the salary.

### C. Wireless Blockchain Model

From the wireless blockchain perspective, on the one hand, the developer expects more IoT devices to join the blockchain, where he can benefit from it. On the other hand, the developer must pay rewards to the devices to incentivize them, which brings the costs. Therefore, we can define the utility function of the wireless blockchain as follows:

$$U_B = \sum_{k=1}^K \sum_{m=1}^M \sum_{n=1}^N ZQ(h_k, c_m, p_n) \left( \varepsilon G(h_k, c_m, p_n) e_{k,m,n} - s_{k,m,n} - G(h_k, c_m, p_n) b_{k,m,n} e_{k,m,n} \right), \quad (13)$$

where  $\varepsilon$  is the yield coefficient and is used to evaluate the utility brought to the blockchain by devices. While pursuing maximizing the wireless blockchain utility, the contract should meet the IR and IC conditions to successfully attract and reveal actual information about IoT devices. The conditions are given in the following:

$$U_D^{k,m,n}(\omega_{k,m,n}) \geq 0, \quad (14)$$

$$U_D^{k,m,n}(\omega_{k,m,n}) \geq U_D^{k,m,n}(\omega'), \forall \omega_{k,m,n} \neq \omega', \quad (15)$$

where  $\omega$  is the contract item. Equations (14) and (15) denote IR and IC conditions respectively.

### D. Problem of Adverse Selection

Usually, the blockchain developer does not know the IoT devices' actual capabilities. Thus, the developer cannot obtain IoT devices' energy consumption and block confirmation probability. We define the IoT devices' capabilities are different over the hash power  $h$ , transmission power  $p$ , and connectivity  $c$ . The tuple  $(h, c, p)$  denotes the IoT device's capability, and the blockchain developer just knows the probability distribution  $Q(h, c, p)$  of the capability from the past statistical data. We use the device's capability as its type  $(h_k, c_m, p_n)$ ,  $1 \leq k \leq K, 1 \leq m \leq M, 1 \leq n \leq N$ . The device's capability belongs to  $L$  different types, where  $L = K * M * N$ . The IoT devices consume energy and time to maintain the blockchain, and the developer offers a contract  $(e, R)$  to compensate the IoT devices.

This is a typical *adverse selection* problem. The contract  $(e, R)$  must meet the IR and IC conditions to reveal the actual capabilities of IoT devices to overcome the problem.

### E. Problem of Moral Hazard

As mentioned in Section III A, the block may not be confirmed on the chain due to the forking. Even if the device signs a contract  $(e, R)$ , the corresponding quality of the task completion may not be ensured because of the failure of the block confirmation, which causes the problem of *moral hazard*. Consequently, the developer must consider the quality of the tasks while distributing rewards. Based on the longest legal chain principle, it is easy to verify whether the block is on the chain and then give rewards to the IoT devices.

### F. Problem Formulation on Maximizing Wireless Blockchain Utility

According to the above analyses, the wireless blockchain utility maximization problem can be formulated as follows:

$$\max U_B = \sum_{k=1}^K \sum_{m=1}^M \sum_{n=1}^N ZQ(\omega_{k,m,n}) \left( \varepsilon G(\omega_{k,m,n}) e_{k,m,n} - s_{k,m,n} - G(\omega_{k,m,n}) b_{k,m,n} e_{k,m,n} \right), \quad (16a)$$

$$s.t. \quad U_D^{k,m,n}(\omega_{k,m,n}) \geq 0, \quad (16b)$$

$$U_D^{k,m,n}(\omega_{k,m,n}) \geq U_D^{k,m,n}(\omega'), \forall \omega_{k,m,n} \neq \omega'. \quad (16c)$$

The problem (16a) with constraints (16b) and (16c) is difficult to solve directly. We first resolve the optimal number of blocks  $e^*$  for the IoT device. Based on equations (3), (10), (11), and (12), it is easy to derive that equation (10) is a concave function of  $e$ . We take the first derivative of the IoT device's utility for the number of blocks  $e$  and set it to zero:

$$\frac{\partial U_D(\omega_{k,m,n})}{\partial e} = 0. \quad (17)$$

Then, the optimal number of blocks  $e^*$  can be obtained according to equation (17) as follows:

$$e_{k,m,n}^* = \frac{G(\omega_{k,m,n})b_{k,m,n}}{F(\omega_{k,m,n})}. \quad (18)$$

From equation (18), we find that the bonus can represent the number of blocks. By substituting  $e_{k,m,n}^*$  into equation (10), we can rewrite the IoT device's utility function as:

$$U_D^{k,m,n}(\omega_{k,m,n}) = \frac{G^2(\omega_{k,m,n})b_{k,m,n}^2}{2F(\omega_{k,m,n})} - (\theta - 1)s_{k,m,n}. \quad (19)$$

Similarly, we substitute the optimal number of blocks  $e^*$  into equation (16a), and the problem is rewritten as follows:

$$\begin{aligned} \max_{(s,b)} U_B = & \sum_{k=1}^K \sum_{m=1}^M \sum_{n=1}^N ZQ(\omega_{k,m,n}) \left( \frac{\varepsilon G^2(\omega_{k,m,n})b_{k,m,n}}{F(\omega_{k,m,n})} \right. \\ & \left. - s_{k,m,n} - \frac{G^2(\omega_{k,m,n})b_{k,m,n}^2}{F(\omega_{k,m,n})} \right), \end{aligned} \quad (20a)$$

$$s.t. \quad U_D^{k,m,n}(\omega_{k,m,n}) \geq 0, \quad (20b)$$

$$U_D^{k,m,n}(\omega_{k,m,n}) \geq U_D^{k,m,n}(\omega'), \forall \omega_{k,m,n} \neq \omega'. \quad (20c)$$

To solve the problem of maximizing the wireless blockchain utility, we should design the salary  $s$  and bonus  $b$  elaborately. In the following, we give the process of designing the optimal contract and analyzing the feasibility of the contract.

#### IV. OPTIMAL CONTRACT DESIGN

We resort to an effective method to convert the multi-dimensional contract problem into a one-dimensional problem in this selection. Then, we relax the IR and IC conditions and obtain the optimal contract  $(e, R)$ .

##### A. Conversion of IoT Device Type

According to equation (19), the IoT device's type  $(h_k, c_m, p_n)$  contains three-dimensional attributes: hash power  $h$ , connectivity  $c$ , and transmission power  $p$ , which determine the device's energy cost and block confirmation probability. Directly resolving the problem considering three attributes is complicated. Here, we introduce the preference order  $\lambda$  to represent the IoT device's new type. From the analyses in Section IV, the device's capability not only affects the energy consumption but also the confirmation probability. Therefore, we define the new IoT device's type  $\lambda$  as follows:

$$\lambda = \frac{G^2(h, c, p)}{2F(h, c, p)}. \quad (21)$$

The device's preference order is illustrated in Fig. 4. The color represents the value of the preference order  $\lambda$ . The closer the color is to red, the higher the value, and vice versa. According to the preference order, we can quickly redefine the types of devices. The more excellent value of  $\lambda$  means the IoT device has a higher confirmation probability and lower energy consumption, which is the preferred type of wireless blockchain developer. We reclassify the IoT device's

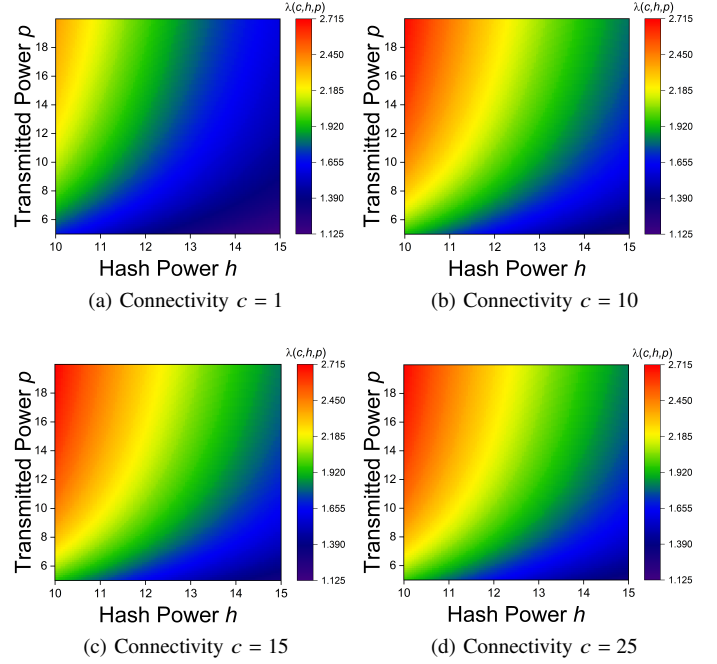

Fig. 4. The IoT device's preference order.

type based on equation (21). The  $L$  types are sorted in non-descending order in the following:

$$\lambda_1 \leq \dots \leq \lambda_i \leq \dots \leq \lambda_L. \quad (22)$$

Therefore, the IoT device's utility is represented as:

$$U_D^i(\omega_i) = \lambda_i b_i^2 - (\theta - 1)s_i. \quad (23)$$

Intuitively, the higher type  $\lambda_i$  can afford a great number of blocks and obtain more rewards  $R$ . To this end, the contract  $(e_i, R_i)$  should be in accordance with the type  $\lambda_i$ . The salary  $s$  and bonus  $b$  satisfy the following monotonicity constraints:

$$\begin{aligned} s_1 &\leq \dots \leq s_i \leq \dots \leq s_L, \\ b_1 &\leq \dots \leq b_i \leq \dots \leq b_L. \end{aligned} \quad (24)$$

Monotonicity constraints guarantee the correspondence between contract and reward, which is an essential principle in contract theory.

By introducing the preference order  $\lambda$ , we successfully convert the multi-dimensional contract into a one-dimensional contract. The post-converted problem is rewritten as follows:

$$\max_{(s_i, b_i)} U_B = \sum_{i=1}^L ZQ(\lambda_i) \left( 2\varepsilon \lambda_i b_i - s_i - 2\lambda_i b_i^2 \right), \quad (25a)$$

$$s.t. \quad U_D^i(\omega_i) \geq 0, 1 \leq i \leq L, \quad (25b)$$

$$U_D^i(\omega_i) \geq U_D^i(\omega_j), \forall i \neq j, \quad (25c)$$

Constraints in (24).

## B. Constraints Reduction

Although the problem has been converted into a one-dimensional contract, it is still difficult to resolve due to excessive constraints. From equations (25a), (25b), and (25c), the problem has  $L$  IR constraints and  $L(L-1)$  IC constraints. All of these constraints are non-convex and not straightforward to handle. Thus, we need to reduce the IR and IC constraints.

First, we relax the IR constraints by introducing Lemma 1.

**Lemma 1.** *If the  $\lambda_1$  type of device satisfies the IR constraint, all types of devices will satisfy the IR constraints.*

*Proof:* According to IC constraints, we have

$$U_D^i(\omega_i) \geq U_D^i(\omega_1). \quad (26)$$

Then based on equations (24) and (26), we can derive

$$U_D^i(\omega_1) \geq U_D^1(\omega_1), \quad (27)$$

$$U_D^i(\omega_i) \geq U_D^1(\omega_1). \quad (28)$$

Therefore, we conclude that  $\forall 1 \leq i \leq L$ , if  $U_D^1(\omega_1) \geq 0$ ,  $U_D^i(\omega_i) \geq 0$ . The IR constraints are met, and Lemma 1 is proved. ■

Lemma 1 guarantees reducing the  $L$  IR constraints to one constraint. Before taking up reducing the IC constraints, we introduce the following concepts [39].

- 1) *Downward Incentive Constraints (DICs).* The IC constraints between type  $\lambda_i$  and  $\lambda_j$ ,  $1 \leq j \leq i-1$  are called DICs.
- 2) *Local Downward Incentive Constraints (LDIC).* The IC constraint between type  $\lambda_i$  and  $\lambda_j$ ,  $j = i-1$  is called LDIC.
- 3) *Upward Incentive Constraints (UICs).* The IC constraints between type  $\lambda_i$  and  $\lambda_j$ ,  $i+1 \leq j \leq L$  are called UICs.
- 4) *Local Upward Incentive Constraint (LUIC).* The IC constraint between type  $\lambda_i$  and  $\lambda_j$ ,  $j = i+1$  is called LUIC.

Obviously, the IC constraints are composed of DICs and UICs. By virtue of the above concepts, we reduce the IC constraints by introducing Lemma 2.

**Lemma 2.** *For any IoT device's type  $\lambda_i$ , if the LDIC holds, then all DICs hold, and the same with LUIC and UICs.*

*Proof:* Based on LDIC, we have

$$U_D^i(\omega_i) \geq U_D^i(\omega_{i-1}), \quad (29)$$

$$U_D^{i-1}(\omega_{i-1}) \geq U_D^{i-1}(\omega_{i-2}). \quad (30)$$

Then we define the following variates  $\delta_1$  and  $\delta_2$  to reduce the IC constraints:

$$\delta_1 = (\lambda_i - \lambda_{i-1})b_{i-1}^2, \quad (31)$$

$$\delta_2 = (\lambda_i - \lambda_{i-1})b_{i-2}^2. \quad (32)$$

According to the monotonicity constraints (24), it is easy to derive that  $\delta_1 \geq \delta_2$ . We add equations (31) and (32) to the left and right sides of the inequality (30), respectively. Then, we can have:

$$U_D^i(\omega_{i-1}) \geq U_D^i(\omega_{i-2}). \quad (33)$$

With equations (29) and (33), we obtain

$$U_D^i(\omega_i) \geq U_D^i(\omega_{i-2}). \quad (34)$$

Iterate steps (29), (30), (33), and (34), we derive the following simultaneous inequalities:

$$U_D^i(\omega_i) \geq U_D^i(\omega_{i-2}) \geq U_D^i(\omega_{i-3}) \geq \dots \geq U_D^i(\omega_1). \quad (35)$$

As a consequence, for the type  $\lambda_i$  of the IoT device, if the contract satisfies the LDIC, it satisfies the DICs. Similarly, we can prove the LUIC and UICs by the above steps. Lemma 2 is proven. ■

Using Lemma 2, we reduce  $L(L-1)$  IC constraints to  $L$  constraints. We redefine the problem with the LDIC and LUIC as follows:

$$\max_{(s_i, b_i)} U_B = \sum_{i=1}^L ZQ(\lambda_i) \left( 2\varepsilon \lambda_i b_i - s_i - 2\lambda_i b_i^2 \right), \quad (36a)$$

$$s.t. \quad U_D^1(\omega_1) = 0, \quad (36b)$$

$$U_D^i(\omega_i) = U_D^i(\omega_{i-1}), 1 \leq i \leq L, \quad (36c)$$

Constraints in (24).

## C. Salary and Bonus Design

To resolve the problem (42a), we need to derive the salary  $s$  and bonus  $b$ . We first give the salary  $s_i$  with respect to type  $\lambda_i$ . Then we replace the  $s_i$  and calculate the optimal bonus  $b_i^*$ . The salary is obtained by Theorem 1 as follows:

**Theorem 1.** *For any device's type  $\lambda_i$ , if the contract is feasible, the salary satisfies*

$$s_i^* = \sum_{t=1}^i \frac{\lambda_t}{\theta-1} (b_t^2 - b_{t-1}^2), 1 \leq i \leq L. \quad (37)$$

*Proof:* According to equation (36b), we can calculate the salary of type  $\lambda_1$

$$s_1 = \frac{\lambda_1}{\theta-1} b_1^2. \quad (38)$$

Then based on equations (36c) and (38), we further derive

$$\begin{aligned} s_2 &= \frac{\lambda_2}{\theta-1} (b_2^2 - b_1^2) + s_1 \\ &= \frac{\lambda_2}{\theta-1} (b_2^2 - b_1^2) + \frac{\lambda_1}{\theta-1} b_1^2. \end{aligned} \quad (39)$$

Repeat steps (38) and (39), we can obtain



---

**Algorithm 1** Ironing Algorithm
 

---

**Input :** The bonus sequence  $\tilde{\mathbf{b}} = \{b_1, \dots, b_i, \dots, b_L\}$ .

**Output:** The monotonous bonus sequence  $\mathbf{b}^*$ .

```

1: begin
2:   while  $\tilde{\mathbf{b}}$  violates the monotonicity constraints do
3:     Find an infeasible sub-sequence  $\hat{\mathbf{b}} = \{b_i, \dots, b_{i+n}\}$ 
4:      $\tilde{\mathbf{b}} \leftarrow \tilde{\mathbf{b}} \setminus \hat{\mathbf{b}}$ 
5:      $b_j = \arg \max_b \sum_{j=i}^{i+n} U_B, i \leq j \leq i+n$ 
6:      $\mathbf{b}^* \leftarrow \tilde{\mathbf{b}} \cup \hat{\mathbf{b}}$ 
7:     Sort bonus  $\mathbf{b}^*$  in ascending order by subscript  $i$ 
8:   end while
9: end

```

---

$$\begin{aligned}
 s_i &= \frac{\lambda_i}{\theta - 1} (b_i^2 - b_{i-1}^2) + s_{i-1} \\
 &= \frac{\lambda_i}{\theta - 1} (b_i^2 - b_{i-1}^2) + \dots + \frac{\lambda_1}{\theta - 1} b_1^2 \\
 &= \sum_{t=1}^i \frac{\lambda_t}{\theta - 1} (b_t^2 - b_{t-1}^2). \tag{40}
 \end{aligned}$$

Therefore, Theorem 1 is proved.  $\blacksquare$

From equation (37), we find that the salary  $s$  can be expressed by bonus  $b$ . By replacing  $s$  with  $b$ , we derive the final form of the problem in the following:

$$\begin{aligned}
 \max_{b_i} U_B &= \sum_{i=1}^L Z \left( Q(\lambda_i) (2\varepsilon \lambda_i b_i - 2\lambda_i b_i^2) \right. \\
 &\quad \left. - \frac{\lambda_i}{\theta - 1} (b_i^2 - b_{i-1}^2) \sum_{t=i}^L Q(\lambda_t) \right), \tag{41} \\
 \text{s.t.} &\quad \text{Constraints in (24)}.
 \end{aligned}$$

Obviously, equation (41) is a concave function with respect to  $b_i$ . We can derive the optimal  $b_i^*$  by calculating  $\frac{\partial U_B}{\partial b_i} = 0$  without considering the constraints (24). However, the results may not satisfy monotonicity. Inspired by [29] and [40], we adopt an Ironing Algorithm to adjust the results. The algorithm is presented in Algorithm 1. After obtaining the optimal  $b_i^*$ , we can calculate the corresponding  $s_i$  and  $e_i$  according to equations (37) and (18).

## V. PERFORMANCE EVALUATION

In this section, we present the performance of our proposed contract and the impact of various parameters on the utility of the IoT device and blockchain network. We consider that there are  $Z$  IoT devices in the network, which belong to  $L$  different types. We set the IoT device's type subject to a uniform distribution. To be concrete,  $h \sim U(10, 15)$ ,  $c \sim U(1, 20)$ ,  $p \sim U(5, 20)$ . Based on the clustering method and equation (21), we partition the capability into 48 types. The blockchain parameters are in reference to bitcoin [1]. Table 2 lists the default parameters. Not otherwise specified, the parameter is set as the default value.

TABLE II  
DEFAULT PARAMETER VALUES

Parameters	Values	Parameters	Values
$N$	100	$A$	1000
$B$	$2 \times 10^6$	$N_0$	$3.98 \times 10^{-3}$
$\tau$	600	$r$	2000
$P_l$	0.2	$\varepsilon$	400
$\theta$	1.5	$\gamma$	$1 \times 10^{-4}$

### A. Evaluation of the Probability $P_c$

As we mentioned in Section III, the function of  $P_c$  is given according to equation (8). We set  $\beta_1 = 0.97575$ ,  $\beta_2 = 0.03006$ , and  $\beta_3 = 0.00411$ , and Fig. 5 compares the fitting values and original values. To better utilize the function in reality, we regard the normalized degree centrality as connectivity. In Fig. 5, we derive that the Adjusted R-Square of the fitting curve is 0.97421 and the RMSE is 0.00517, which demonstrates the effectiveness of the fitting. With the increase of connectivity, the probability  $P_c$  is on the rise and asymptotic to 1. It is intuitive because the extensive connectivity reduces the propagation delay, which brings the advantage of winning the block competition. Fig. 5 demonstrates that communication advantage helps devices to win the competition of block property. Higher connectivity makes more devices receive the block simultaneously, which is more prominent in wireless IoT networks.

Then we discuss the impact of the network size  $z$  and average link probability  $P_l$ . Fig. 6 (a) illustrates how the link probability affects the probability  $P_c$  while the network size is fixed at 100. In the mass, the probability  $P_c$  is higher under a larger average link probability  $P_l$ . The difference in probability  $P_c$  is slight among different connectivity under a higher average link probability  $P_l$  network. It is because the higher link probability  $P_l$  increases the number of average links and reduces the propagation delay of the entire network. Moreover, there is an interesting phenomenon. For example, while the connectivity  $c$  exceeds 0.3, the same connectivity  $c$  has a higher probability  $P_c$  at  $P_l = 0.3$  than  $P_l = 0.4$ . This phenomenon seems counterintuitive because the same connectivity has a different influence in networks with different average link probabilities. Though devices are with the same connectivity, they have different influences in networks with different average link probabilities. The device with 0.35 connectivity may have the most communication links at  $P_l = 0.3$  but is the common connectivity at  $P_l = 0.4$ . Thus, improving the connectivity can significantly increase the confirmation probability in the network with sparse connections. From Fig. 6 (a), the higher link probability and more extensive connectivity both raise the probability  $P_c$  by reducing the delay of the whole network. Nevertheless, the improvement is asymptotic to a stable value, especially when  $P_l$  or  $c$  is large.

The impact of network size  $Z$  is complicated. On the one hand, the larger network size brings a larger number of average links under the same average link probability  $P_l$ . On the other hand, the larger network size also increases communication delay. In Fig. 6 (b), while fixing  $P_l = 0.2$ , the probability  $P_c$  is lower in the larger network size generally. The expansion in

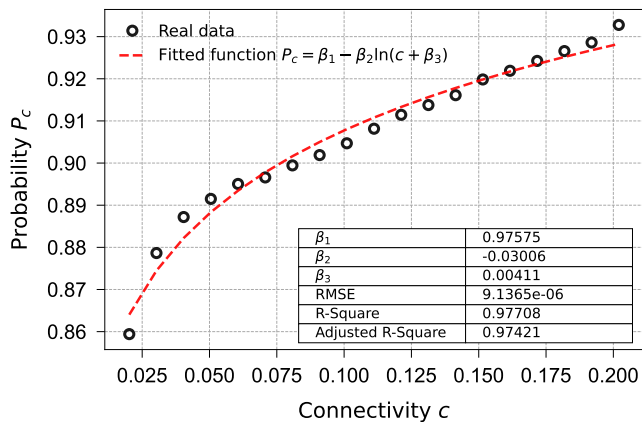

Fig. 5. Verification of the confirmation probability function (6).

network size increases the propagation delay for IoT devices, which causes more forking events. When the network size ranges from 100 to 200, the confirmation probability  $P_c$  becomes higher among small connectivity values. Benefiting from the expansion of the network size, devices own larger connections at the same connectivity to improve the propagation of blocks. This is the positive influence of network size increase. However, when the network size ranges from 200 to 300, a larger network size decreases the confirmation probability due to blocks needing more time to spread across the network. Expansion of network size also brings negative effects on the confirmation of blocks. In addition, the IoT device obtains a higher probability  $P_c$  in a small-scale network as the connectivity is large enough. For example, the device with normalized connectivity of 0.2 is a core node with a network size  $Z = 100$ . Obviously, the network size has a two-sided impact on confirmation probability compared to the average link probability.

### B. Impact of Hash Power $h$ , Connectivity $c$ , and Transmission Power $p$

First, we discuss the impact of the hash power  $h$ , connectivity  $c$ , and transmission power  $p$  on the IoT device's energy consumption. As Fig. 7 shows, the types of IoT devices are divided into 48 categories,  $h = \{11, 12, 13\}$ ,  $c = \{3, 10, 15, 20\}$ ,  $p = \{5, 10, 15, 20\}$ . From Fig. 7, we observe that the hash power  $h$  has a bigger impact on energy consumption. In contrast, the connectivity  $c$  and the transmission power  $p$  slightly affect the energy consumption. It illustrates that the IoT device consumes more energy for computing than for communicating. In reality, while participating in the PoW-based blockchain network, the device mainly consumes energy for computing. Moreover, the more capable the device is, the more significant the difference in energy consumption between them. For example, the difference in energy consumption when  $p = 20$  is more prominent than  $p = 5$  while the connectivity  $c$  varies from 3 to 20. That is why the more powerful IoT devices obtain more rewards.

Then, we discuss the impact of the hash power  $h$ , connectivity  $c$ , and transmission power  $p$  on the IoT device's

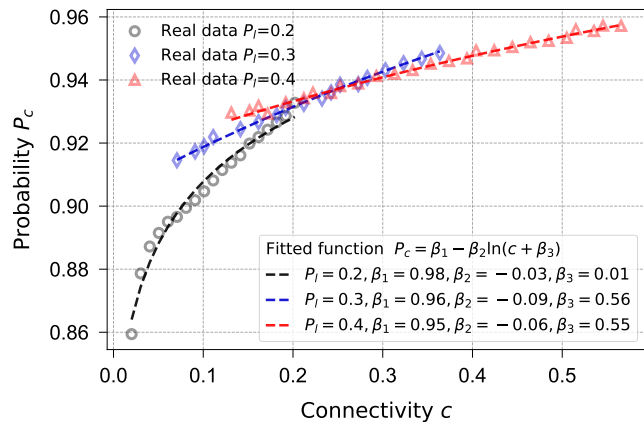

(a) Impact of connectivity  $c$  on probability  $P_c$  under different average link probabilities  $P_l$  when the network size  $Z = 100$ .

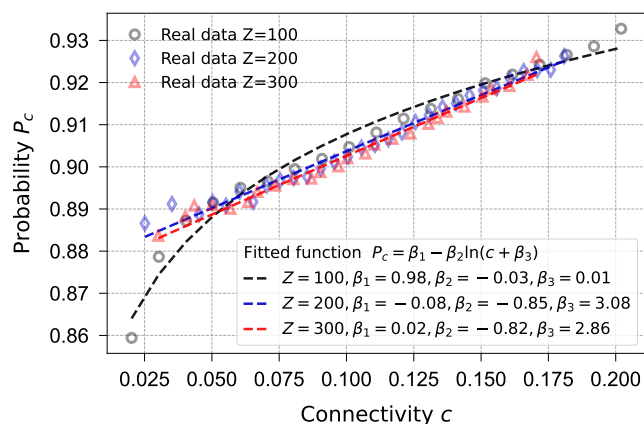

(b) Impact of connectivity  $c$  on probability  $P_c$  under different network sizes  $Z$  when the average link probability  $P_l = 0.2$ .

Fig. 6. The impact of the connectivity  $c$  on probability  $P_c$  under different network sizes  $Z$  and average link probabilities  $P_l$ , where the dot represents the simulation results and the dashed line represents the fitted function.

block confirmation probability. From Fig. 8, we observe the connectivity  $c$  and transmission power  $p$  have the dominant effect on the block confirmation probability  $G$  compared with the hash power  $h$ , which is consistent with Section III B. Besides, the increase in transmission power  $p$  has a more prominent effect than connectivity  $c$  when both are large. When the connectivity  $c$  is beyond 10, it has a slight effect on the block confirmation probability as the value increases. Similarly, the impact on confirmation probability is also finite as the transmission power  $p$  increases. On the one hand, increasing the computing and communication capability improves the block confirmation probability. On the other hand, more powerful computing and communication capability bring greater energy consumption and limited improvement of confirmation probability. Therefore, it is significant for IoT devices to trade off computing and communication capability improvement.

### C. Feasibility of the Proposed Contract

In Fig. 9, we present the rewards of IoT devices. The olive green bar represents the fixed salary  $s$ , and the light blue

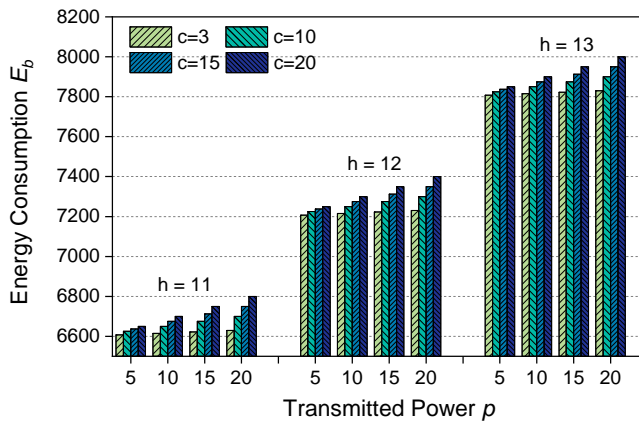

Fig. 7. The impact of hash power  $h$ , connectivity  $c$ , and transmission power  $p$  on the IoT device's energy consumption  $E_b$ .

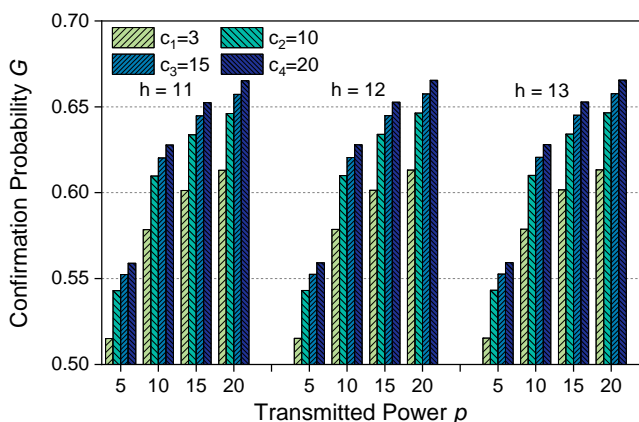

Fig. 8. The impact of hash power  $h$ , connectivity  $c$ , and transmission power  $p$  on the IoT device's confirmation probability  $G$ .

bar represents the bonus  $B$ . Both the  $s$  and  $B$  increase with the type  $\lambda$ , which means the more capable devices contribute more effort and gain more profits. It is consistent with the monotonicity constraint and conforms to the law of economic life. From Fig. 9, we find that the blockchain developer prefers devices with more powerful capabilities and provides exponentially increasing rewards.

Fig. 10 illustrates the feasibility of our proposed contract. From Fig. 10, we observe that the IoT device gains the non-negative utility, which satisfies the IR constraints. The utility of type  $\lambda_1$  device is set to be zero and consistent with the equation (36b). Furthermore, the IoT device gains maximum utility while selecting the contract of the corresponding type, which satisfies the IC constraints.

We compare the proposed contract with the contract that does not consider the block confirmation probability, which is the *contract only with adverse selection* [40]. To demonstrate the advantage of contract theory, we add a comparison to the existing PoW-based incentive mechanism, where every device obtains the same rewards after building a block. We set the median utility of heterogeneous devices as a fixed incentive. Additionally, we compare our contract with the perfect information contract, where the developer knows the

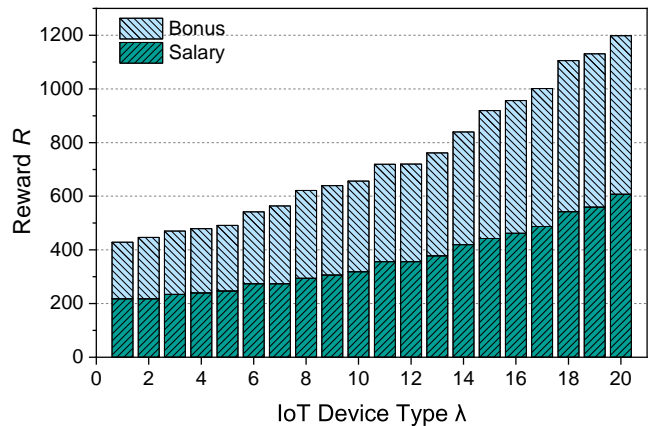

Fig. 9. The reward  $R$  for each IoT device's type.

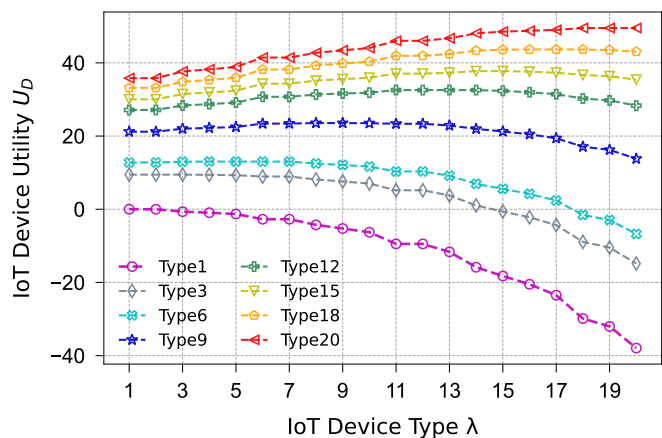

Fig. 10. The feasibility of the proposed contract.

actual capability of each IoT device. In the perfect information scenario, the developer elaborates the contract for every IoT device and ensures that they obtain zero utility. The wireless blockchain utility with perfect information contract is:

$$\max_{(s_i, b_i)} U_B = \sum_{i=1}^L ZQ(\lambda_i) (2\varepsilon\lambda_i b_i - s_i - 2\lambda_i b_i^2), \quad (42a)$$

$$s.t. \quad U_D^i(\omega_i) = 0. \quad (42b)$$

Thus, the developer can maximize the wireless blockchain utility with a perfect information contract. In Fig. 11, we compare the proposed contract and the approach in [40] over the wireless blockchain utility. While the yield coefficient  $\varepsilon$  varies from 100 to 550, the wireless blockchain utility of the proposed contract is about 35% higher than the approach in [40] and increases utility by 4 times compared with the original PoW-based incentive mechanism. We also can see that our contract is very close to the perfect information contract, which demonstrates the effectiveness of our contract.

## VI. CONCLUSIONS AND FUTURE WORK

In this paper, we have investigated the problem of incentive mechanism design in the wireless blockchain IoT network to

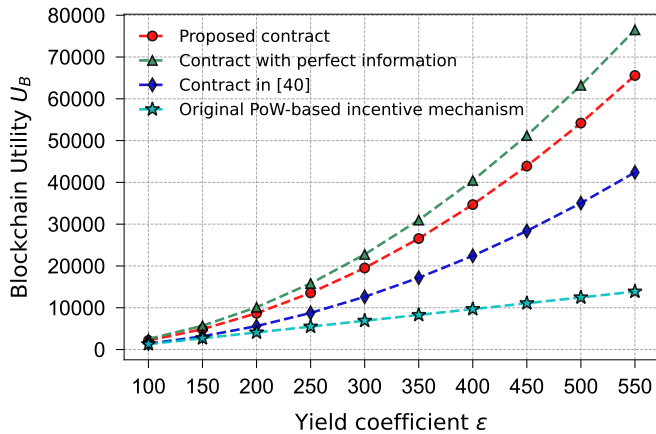

Fig. 11. The blockchain utility under different incentive mechanisms.

maximize the wireless blockchain utility. Taking into account the IoT device's hash power, connectivity, and transmission power, we analyze IoT devices' energy consumption and block confirmation probability while maintaining the wireless blockchain network. We propose a multi-dimensional contract to address the *adverse selection* and *moral hazard* issues, and attract more IoT devices to join the wireless blockchain network. In particular, we explore the network connectivity's effect on the block confirmation probability from the complex wireless network perspective. Furthermore, we find that connectivity affects the confirmation probability dissimilarly over different network sizes and average link probability. From the simulation results, our proposed contract is effective and closer to the theoretical optimal utility than the contract with adverse selection. In addition, the communication factors have a more prominent effect on block confirmation than hash power in the wireless blockchain network, which is different from the traditional blockchain networks.

In future work, we will explore the Integration of blockchain and artificial intelligence (AI) to construct a trusted environment for next-generation computing. Blockchain has much potential to be combined with fog/edge/serverless and quantum computing scenarios [26]. In cloud/fog/edge computing, blockchain provides a platform for both server and user to allocate resources efficiently. From the perspective of serverless computing, blockchain can replace traditional servers to converge AI models in federated learning (FL). A completely decentralized, secure, efficient, and privacy-protecting machine learning framework could be achieved by introducing the blockchain. Besides, with the development of quantum computing, quantum-resistant encryption algorithms need to be further investigated to ensure the security of blockchain systems. The ability to form Decentralized Autonomous Organizations (DAOs) is a concept fundamental to the Cloud-to-Things computing continuum, which is consistent with the decentralized nature of blockchain.

## REFERENCES

[1] S. Nakamoto, "Bitcoin: A Peer-to-Peer Electronic Cash System," *Artificial Life*, vol. 23, no. 4, pp. 552–557, 2017.

- [2] M. A. Ferrag, M. Derdour, M. Mukherjee, A. Derhab, L. Maglaras, and H. Janicke, "Blockchain technologies for the internet of things: Research issues and challenges," *IEEE Internet of Things Journal*, vol. 6, no. 2, pp. 2188–2204, 2019.
- [3] M. T. Lwin, J. Yim, and Y. B. Ko, "Blockchain-based lightweight trust management in mobile ad-hoc networks," *Sensors (Switzerland)*, vol. 20, no. 3, pp. 1–19, 2020.
- [4] J. Kang, Z. Xiong, D. Niyato, D. Ye, D. I. Kim, and J. Zhao, "Toward secure blockchain-enabled internet of vehicles: Optimizing consensus management using reputation and contract theory," *IEEE Transactions on Vehicular Technology*, vol. 68, no. 3, pp. 2906–2920, 2019.
- [5] O. Onireti, L. Zhang, and M. A. Imran, "On the viable area of wireless practical byzantine fault tolerance (pbft) blockchain networks," in *2019 IEEE Global Communications Conference (GLOBECOM)*. IEEE, 2019, pp. 1–6.
- [6] Y. Xiao, N. Zhang, W. Lou, and Y. T. Hou, "Modeling the impact of network connectivity on consensus security of proof-of-work blockchain," in *IEEE INFOCOM 2020 - IEEE Conference on Computer Communications*, 2020, pp. 1648–1657.
- [7] G. Wood, "Ethereum: a secure decentralised generalised transaction ledger," *Ethereum Project Yellow Paper*, pp. 1–32, 2014.
- [8] K. Christidis and M. Devetsikiotis, "Blockchains and smart contracts for the internet of things," *IEEE Access*, vol. 4, pp. 2292–2303, 2016.
- [9] C. Feng, Z. Xu, X. Zhu, P. V. Klaine, and L. Zhang, "Wireless Distributed Consensus in Vehicle to Vehicle Networks for Autonomous Driving," pp. 1–11.
- [10] M. A. A. Careem and A. Dutta, "Reputation based routing in manet using blockchain," in *2020 International Conference on COMMunication Systems NETWORKS (COMSNETS)*, 2020, pp. 1–6.
- [11] Y. Sun, L. Zhang, S. Member, G. Feng, S. Member, B. Yang, B. Cao, A. Member, M. A. Imran, and S. Member, "Blockchain-Enabled Wireless Internet of Things : Performance Analysis and Optimal Communication Node Deployment," *IEEE Internet of Things Journal*, vol. 6, no. 3, pp. 5791–5802, 2019.
- [12] B. Cao, Y. Li, L. Zhang, L. Zhang, S. Mumtaz, Z. Zhou, and M. Peng, "When internet of things meets blockchain: Challenges in distributed consensus," *IEEE Network*, vol. 33, no. 6, pp. 133–139, 2019.
- [13] S. Popov, "The tangle," *White paper*, vol. 1, no. 3, 2018.
- [14] L. Baird, "The swirlds hashgraph consensus algorithm: fair, fast, byzantine fault tolerance," pp. 1–28, 2018.
- [15] C. Decker and R. Wattenhofer, "Information propagation in the Bitcoin network," *13th IEEE International Conference on Peer-to-Peer Computing, IEEE P2P 2013 - Proceedings*, pp. 1–10, 2013.
- [16] X. Zhang, W. Xia, X. Wang, J. Liu, Q. Cui, X. Tao, S. Member, R. P. Liu, and S. Member, "The Block Propagation in Blockchain-based Vehicular Networks," pp. 1–12, 2021.
- [17] Y. Shahsavari, K. Zhang, and C. Talhi, "A Theoretical Model for Block Propagation Analysis in Bitcoin Network," pp. 1–18, 2020.
- [18] E. Ghosh and B. Das, "A Study on the Issue of Blockchain's Energy Consumption," *Advances in Intelligent Systems and Computing*, vol. 1065, pp. 63–75, 2020.
- [19] J. Sedlmeir, H. U. Buhl, G. Fridgen, and R. Keller, "The energy consumption of blockchain technology: beyond myth," *Business & Information Systems Engineering*, vol. 62, no. 6, pp. 599–608, 2020.
- [20] Y. Huang, J. Zhang, J. Duan, B. Xiao, F. Ye, and Y. Yang, "Resource allocation and consensus of blockchains in pervasive edge computing environments," *IEEE Transactions on Mobile Computing*, 2021.
- [21] H. Wei, W. Feng, Y. Chen, C.-X. Wang, and N. Ge, "Rethinking blockchains in the internet of things era from a wireless communication perspective," *IEEE Network*, vol. 34, no. 6, pp. 24–30, 2020.
- [22] O. Onireti, L. Zhang, and M. A. Imran, "On the viable area of wireless practical byzantine fault tolerance (PBFT) blockchain networks," *2019 IEEE Global Communications Conference, GLOBECOM 2019 - Proceedings*, pp. 0–5, 2019.
- [23] L. Zhang, H. Xu, O. Onireti, M. A. Imran, and B. Cao, "How much communication resource is needed to run a wireless blockchain network?" *IEEE Network*, pp. 1–8, 2021.
- [24] Y. Li, B. Cao, L. Liang, D. Mao, and L. Zhang, "Block access control in wireless blockchain network: Design, modeling and analysis," *IEEE Transactions on Vehicular Technology*, vol. 70, no. 9, pp. 9258–9272, 2021.
- [25] X. Li, P. Russell, C. Mladin, and C. Wang, "Blockchain-enabled applications in next-generation wireless systems: Challenges and opportunities," *IEEE Wireless Communications*, vol. 28, no. 2, pp. 86–95, 2021.
- [26] S. S. Gill, M. Xu, C. Ottaviani, P. Patros, R. Bahsoon, A. Shaghghi, M. Golec, V. Stankovski, H. Wu, A. Abraham *et al.*, "Ai for next

- generation computing: Emerging trends and future directions,” *Internet of Things*, vol. 19, p. 100514, 2022.
- [27] A. Hafid, A. S. Hafid, and M. Samih, “A tractable probabilistic approach to analyze sybil attacks in sharding-based blockchain protocols,” *IEEE Transactions on Emerging Topics in Computing*, 2022.
- [28] P. Bolton and M. Dewatripont, *Contract theory*. MIT press, 2004.
- [29] L. Gao, X. Wang, Y. Xu, Q. Zhang, and S. Member, “Spectrum Trading in Cognitive Radio Networks : A Contract-Theoretic Modeling Approach,” vol. 29, no. 4, pp. 843–855, 2011.
- [30] Y. Jiao, P. Wang, D. Niyato, B. Lin, and D. I. Kim, “Toward an automated auction framework for wireless federated learning services market,” *IEEE Transactions on Mobile Computing*, vol. 20, no. 10, pp. 3034–3048, 2021.
- [31] W. Y. B. Lim, S. Garg, Z. Xiong, D. Niyato, C. Leung, C. Miao, and M. Guizani, “Dynamic Contract Design for Federated Learning in Smart Healthcare Applications,” *IEEE Internet of Things Journal*, vol. 8, no. 23, pp. 16 853–16 862, 2020.
- [32] T. Roughgarden, “Transaction fee mechanism design for the ethereum blockchain: An economic analysis of eip-1559,” *arXiv preprint arXiv:2012.00854*, 2020.
- [33] S. Wilkinson, T. Boshevski, J. Brandoff, and V. Buterin, “Storj a peer-to-peer cloud storage network,” 2014.
- [34] V. Buterin, D. Reijnders, S. Leonardos, and G. Piliouras, “Incentives in ethereum’s hybrid casper protocol,” *International Journal of Network Management*, vol. 30, no. 5, p. e2098, 2020.
- [35] Y. Jiao, P. Wang, D. Niyato, and K. Suankaewmanee, “Auction Mechanisms in Cloud/Fog Computing Resource Allocation for Public Blockchain Networks,” *IEEE Transactions on Parallel and Distributed Systems*, vol. 30, no. 9, pp. 1975–1989, 2019.
- [36] Z. Shi, C. de Laat, P. Grosso, and Z. Zhao, “When blockchain meets auction models: A survey, some applications, and challenges,” *arXiv preprint arXiv:2110.12534*, 2021.
- [37] J. Li, T. Liu, D. Niyato, P. Wang, J. Li, and Z. Han, “Contract-theoretic pricing for security deposits in sharded blockchain with internet of things (IoT),” *IEEE Internet of Things Journal*, vol. 8, no. 12, pp. 10 052–10 070, 2021.
- [38] J. N. Laneman, D. N. Tse, and G. W. Wornell, “Cooperative diversity in wireless networks: Efficient protocols and outage behavior,” *IEEE Transactions on Information Theory*, vol. 50, no. 12, pp. 3062–3080, 2004.
- [39] Z. Han, D. Niyato, W. Saad, and T. Başar, *Game theory for next generation wireless and communication networks: Modeling, analysis, and design*. Cambridge University Press, 2019.
- [40] Z. Xiong, S. Member, J. Kang, D. Niyato, P. Wang, S. Member, H. V. Poor, L. Fellow, and S. Xie, “A Multi-Dimensional Contract Approach for Data Rewarding in Mobile Networks,” vol. 19, no. 9, pp. 5779–5793, 2020.