

Artificial Life using a Book and Bookmarker

Keishu Utimula

(Dated: November 29, 2022)

Reproduction, development, and individual interactions are essential topics in artificial life. The cellular automata, which can handle these in a composite way, is highly restricted in its form and behavior because it represents life as a pattern of cells. In contrast, the virtual creatures proposed by Karl Sims have a very high degree of freedom in terms of morphology and behavior. However, they have limited expressive capacity in terms of those viewpoints. This study carefully extracts the characteristics of the cellular automata and Sims models to propose a new artificial life model that can simulate reproduction, development, and individual interactions while exhibiting high expressive power for morphology and behavior. The simulation was performed by sequentially reading a book with genetic information and repeatedly executing four actions: expansion, connection, disconnection, and transition. The virtual creatures in the proposed model exhibit unique survival strategies and lifestyles and acquire interesting properties in reproduction, development, and individual interactions while having freedom in morphology and behavior.

I. INTRODUCTION

In 1994, Karl Sims proposed a system of virtual creatures that could be simulated on a computer [1]. These virtual creatures had bodies and neurons defined by directed graphs, and they evolved into creatures with various functions through genetic algorithms. Subsequently, there have been many related studies on this virtual creature, which has a very high degree of freedom in its morphology and behavior [2–6].

However, this virtual creature has limited expressive capacity with regard to reproduction, development, and individual interactions. Therefore, many prior studies have delved into these elements separately.

The process of reproduction is often simulated through genetic algorithms. Here, there are variations in how the parents are selected and how the genes of the selected parents are mixed, which are hyperparameters that can be set from the outside [2, 7].

The mechanism of biological development was applied to a network structure for development by Stanley *et al.* in 2007 [8]. In several studies, the bodies of virtual creatures were constructed using particles and springs connecting the particles to simulate the process of development [9–12].

Individual interactions have occasionally been modeled as parameters for genetic algorithms. Sims created interesting and diverse virtual creatures using the results of competitions between individuals as criteria for the selection of the parents [7]. Additionally, some studies have examined changes in morphology and behavior in environments where predators and prey coevolve [13].

These earlier studies independently studied reproduction, development, and individual interactions. An example of a model that can handle these components in a composite way is the self-reproduction pattern of cellular automata proposed by Neumann [14]. However, while cellular automata have high expressive power for repro-

duction, development, and individual interactions, they are highly restricted in their morphology and behavior because they represent life as a pattern of cells.

In this study, a new artificial life model is proposed that can simulate reproduction, development, and individual interactions while exhibiting high expressive power for morphology and behavior. This approach represents an attempt to combine the virtual creatures proposed by Sims with the elements possessed by cellular automata.

The virtual creatures in this proposed model have their own survival strategies and lifestyles and have acquired interesting properties in reproduction, development, and individual interactions.

II. MODEL AND METHODOLOGY

A cellular automaton is a discrete computational model consisting of a regular grid of cells [14]. Each cell changes its internal state according to a set of rules. In 1966, Neumann discovered the existence of a self-reproduction pattern in a cellular automaton with 29 internal states [14]. Many other researchers followed, including Codd [15], Banks [16], and Devore [17]. This self-reproduction was not instantaneous, but involved a process of development. In addition, the self-reproduction pattern Loop that was proposed by Langton was robust and could achieve self-reproduction even when mutations occurred that were triggered by collisions with other loops [18, 19]. This is, therefore, an excellent method of expressing reproduction that incorporates interactions between individuals.

This study focused on the mechanism that causes reproduction and development by sequentially reading information about the creatures in genes and changing the surrounding environment based on that content. This system simulates the expression of various reproductive and developmental processes, and even the individual in-

teractions caused by the intervention of others.

The proposed model is based on the concept of incorporating cellular automata mechanism into a cell that moves freely in a three-dimensional space.

A. Overview

The form of the virtual creatures proposed here consists of spheres, called cells, and springs that connect them. Cells acquire their morphology through repeated cell divisions, binding with surrounding cells using springs, or unbinding. The procedure is written in the genes that each cell possesses, which are read sequentially to represent the developmental process. The cell can copy some or all of its own genes during division and pass them on to a new cell. In addition, each cell has a neural network with only one hidden layer, which allows for a response and action from external input. This action is separated from the gene-derived behavior described above.

These virtual creatures will live in mutation on an undulating field. There is a sun above the field that moves back and forth in one direction, and light emitting from it is the only source of energy in this world.

B. Gene

Genes in these virtual creatures are represented as strings of 64 different characters. Here, a total of 52 upper and lower case letters of the alphabet, ten Arabic numerals [0-9], and the symbols + and - were selected as the characters. Each cell had a string as a gene and a string that determined its readout position. Considering the difference in their roles, the gene string is referred to as the Book and the string for the readout position is referred to as the Bookmarker. For example, the first character to be read is the character "G" if there is a cell with a Book and Bookmarker, as shown in Table I.

TABLE I. Example for the Book and Bookmarker.

Book	ABCDEFGHIJKLMN...
Bookmarker	EF

The cell can perform four different actions depending on the character that is read out first, as follows.

- EXPANSION (\mathcal{E})
- CONNECTION (\mathcal{C})
- DISCONNECTION (\mathcal{D})
- TRANSITION (\mathcal{T})

EXPANSION is the generation of new cells around a source cell, corresponding to cell division. Here, the generated cell is connected to the source cell by a spring. CONNECTION is the action of connecting with surrounding non-connected cells. DISCONNECTION is an operation to disconnect a cell that has already been connected. TRANSITION is the action of changing the Bookmarker string.

In this simulation, 64 different characters were evenly assigned to these four actions, as listed in Table II.

TABLE II. Characters assigned to the four actions.

\mathcal{E}	: ABCDEFGHIJKLMNOP
\mathcal{C}	: QRSTUVWXYZabcdef
\mathcal{D}	: ghijklmnopqrstuv
\mathcal{T}	: wxyz0123456789+-

Thus, EXPANSION is the action that would have been performed in the previous example, as shown in Table III.

TABLE III. Examples for EXPANSION.

Book	ABCDEFGHIJKLMN...
Bookmarker	EF
Action	[G] EXPANSION

In terms of interpretation of actions, there is no difference between characters classified as the same action. Thus, in the example here, the behavior would be the same even if G were A or P. The action determines how the string that follows is interpreted.

1. EXPANSION

The following string is interpreted as information about the newly created cell if the action is EXPANSION. Specifically, the information is as follows.

- Light absorption rate (color)
- Luminous intensity
- Mass
- Radius
- Neural network weight
- From where to where in the Book to be copied and passed to the new cell
- Bookmarker for new cells

The cell generates new cells based on this information. The location to be generated is around the original cell, but it is random. Additionally, the generated cell is connected with the cell from which it was generated. Any further strings following this are interpreted as the next Bookmarker in this cell. Specifically, the following string

was read by every other character and used as the new Bookmarker. For example, the new Bookmarker would be "df" if the length of the Bookmarker was 2 and the string following the specifics of the action "def...", as shown in Table IV. This is a simple encryption to prevent the instruction about the new Bookmarker itself from becoming the next read position.

TABLE IV. Examples for EXPANSION.

Book	CDEF AHIJK ...abcdefg...
Bookmarker	EF
Action	[A] EXPANSION
New Cell Info.	HIJKLMN ...abc
New Bookmarker	df

2. CONNECTION

The cell will be in a waiting state for the connection if the action is CONNECTION. This is the state in which a connection will be performed if there is a cell near another cell that is also waiting to be connected. The following string is interpreted as the next Bookmarker, as shown in Table V.

TABLE V. Examples for CONNECTION.

Book	ABCDEF Q defg...
Bookmarker	EF
Action	[Q] CONNECTION
State	Waiting for connection
New Bookmarker	df

3. DISCONNECTION

The cell will be in a state waiting for disconnection if the action is DISCONNECTION. This is the state in which a cell will be disconnected if a connected cell is also waiting to be disconnected. The following string is interpreted as the next Bookmarker, as shown in Table VI.

TABLE VI. Examples for DISCONNECTION.

Book	ABCDEF g defg...
Bookmarker	EF
Action	[g] DISCONNECTION
State	Waiting for disconnection
New Bookmarker	df

4. TRANSITION

The same process as described so far is followed if the action is TRANSITION, where the following string is interpreted as the next Bookmarker. This is shown in Table VII.

TABLE VII. Examples for TRANSITION.

Book	ABCDEF w defg...
Bookmarker	EF
Action	[w] TRANSITION
New Bookmarker	df

5. Shift for Bookmarker

It is easy to realize a procedure that repeats the same action indefinitely using the implementation described above. An example of the Book and Bookmarker that repeatedly expand the same cell is shown in Table VIII.

TABLE VIII. Example of Book and Bookmarker with the repeated EXPANSION of the same cell.

Book	CDEF AHIJK ...abc EeFghi ...
Bookmarker	EF
Action	[A] EXPANSION
New Cell Info.	HIJKLMN ...abc
New Bookmarker	EF

However, if the same operation is to be repeated a finite number of times, the same content must be described in the Book for that number of times, which is inefficient. Therefore, a string called Advance was introduced to eliminate this problem. This Advance string shifts the readout position of the new Bookmarker. For example, the new Bookmarker would be "Fh" if the Advance was 2 in Table VIII. The Advance was also updated at this time. Subsequently, the string that followed the string interpreted as the new Bookmarker became the new Advance. In this example, the new Advance is "i" if the length of the Advance is one. This Advance string is interpreted as a 64-decimal integer at runtime.

As an example, the Book that repeats self-reproduction while forming a tetrahedral body can be written based on the above, as shown in Fig. 1.

C. Neural Networks

Each cell has a neural network with only one hidden layer. The weights of this neural network were determined by the genes and were not variable. Additionally, the activation function was tanh.

The output of this neural network is as follows:

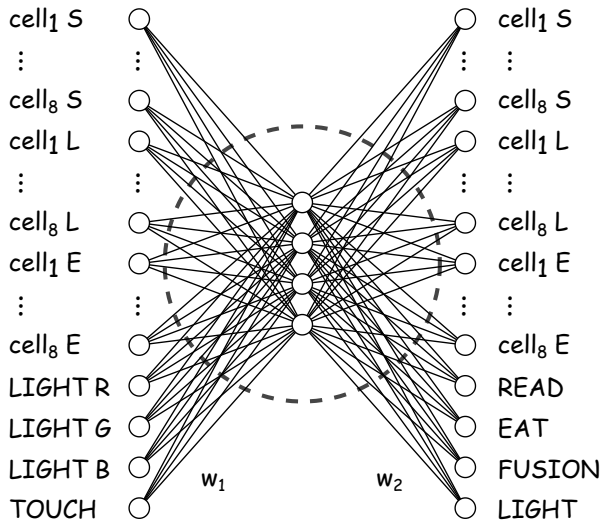

FIG. 2. Schematic diagram of a neural network in one cell. The left and right sides are the input and output, respectively. $cell_x$ denotes the X th connected cell, and E and L denote the energy and natural length of the spring, respectively. LIGHT and TOUCH on the input side are the light and cell information in contact with the cell, respectively. On the output side, READ determines whether to read the Book, EAT determines whether to eat the contacted cells, FUSION determines whether to take in the Book of the contacted cells, and LIGHT determines whether to emit light.

There are three situations in which the energy of a cell increases.

- When absorbing light
- When eating other cells
- When receiving energy from a connected cell

Conversely, there are five situations where cell energy is reduced.

- When time has passed
- When eaten by other cells
- When sending energy to the connected cell
- When generating a new cell
- When emitting light

1. Energy consumption over time

As mentioned earlier, the cell's energy decreases with each simulation step. The cell energy E after Δt (one step) is updated, which is expressed as:

$$\begin{aligned} E(t + \Delta t) &= E(t) - \left(C \frac{A^{N_c}}{A^{N_{\max}}} \right) E(t) \Delta t \\ &= E(t) - UE(t) \Delta t \end{aligned} \quad (2)$$

where N_{\max} is the maximum number of cells that can be connected to the cell and N_c is the number of cells that are currently connected to the cell. In addition, C and A are parameters for adjusting energy consumption, where C is a real number greater than 0 and A is a real number greater than 1. In this simulation, 1.0 was used for C , and A was adjusted in real-time so that the number of cells in the field was 4000. This formula shows that more energy is consumed when more cells are connected.

In this simulation, there is no energy expenditure due to exercise. Here, exercise means changing the natural length between connected cells. Also, energy consumption is not considered for exchanging information between cells using neural networks. In practice, however, it is more realistic to consider this type of energy consumption. The energy consumption, according to the number of connected cells mentioned above, is introduced to easily take this energy consumption process into account.

2. Energy change when eating cells

Cells can eat the cells they are in contact with, but two rules apply. The first rule is that if the number of connections of the cell to be eaten is equal to or greater than its number of connections, the cell cannot be eaten. The second rule is that if the number of connections of the cell that is about to be eaten is smaller than its own, the more energy it can obtain at one time.

The equation for the energy ΔE obtained by eating a cell is expressed as:

$$\Delta E = \begin{cases} d \frac{N_c - N'_c}{N_{\max}} & (N_c > N'_c) \\ 0 & (N_c \leq N'_c) \end{cases} \quad (3)$$

where d is the output of the aforementioned neural network. Moreover, it is simply 0 when it is less than 0. In addition, N_c is the number of connections of cells attempting predation and N'_c is the number of connections of cells about to be predated.

3. Energy change when a new cell is generated

Energy is required for one cell to generate a new cell. There are two perspectives on this "required energy". One perspective is that the energy is consumed by the generation of the cell, and the other is that the energy is

passed on to the newly generated cell. It is reasonable to assume that the required energy is the sum of these two perspectives. However, the energy consumed by the generation will not be considered in this simulation. Thus, the only energy that the cell loses in generating a new cell is the energy it passes to the new cell at the time of generation. Here, the magnitude of energy passed to a new cell is based on the energy that the generated cell could acquire after a sufficient amount of time.

When a cell obtains energy from only one light source, the obtained energy converges to E_∞ in a certain amount of time; E_∞ can be estimated as follows:

$$E_\infty = \frac{\Delta E_L}{1 - \exp\left[-\frac{U}{P\Delta S}\right]} \quad (4)$$

where ΔE_L is the energy obtained from one photon, P is the amount of light received per unit time and unit area, and ΔS is the area over which the cell receives light. It is also assumed that the distance between a light source and cell does not change. Details of this derivation are provided in the Appendix.

Using Eq. (4), the energy E_∞^{sun} that can be reached could be predicted if the new cell to be generated was only supplied with energy from the sun. This energy that was multiplied by a factor was defined as the amount of energy that should be passed to the cell during generation. This implies that cells that obtain more energy in the future will have higher generation costs. This factor was set to 0.5 in the simulations performed here.

E. Environment

1. Field

Simulations were performed on a field of 32×32 blocks containing undulations. The maximum radius of the cell was set to approximately 0.16 when the length of one side of this block was 1. One example of a field is shown in Fig. 3. The sun, which moves back and forth in one direction, is located at the top of the field, and the light emitted from it is the only source of energy in this field.

2. Mutation

There are two types of mutations: one mutation can occur for all cells at every simulation step, and the second mutation occurs only for the Book of new cells during cell division. These mutation probabilities are represented by α and β , respectively. The mutation occurring for all cells at every simulation step may mutate against the Book or Bookmaker.

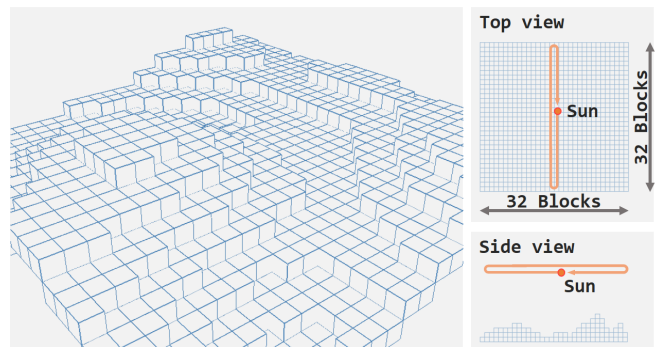

FIG. 3. Example of a field (left), top view (right-top), and side view (right-bottom). The sun is placed at the top of the field, moving back and forth in one direction.

Four fields were independently calculated with different mutation probabilities in this simulation and the virtual creatures were mixed on each field after a specific time, as shown in the conceptual diagram in Fig. 4. The length of the specific time (Time development) was set to 10^6 steps.

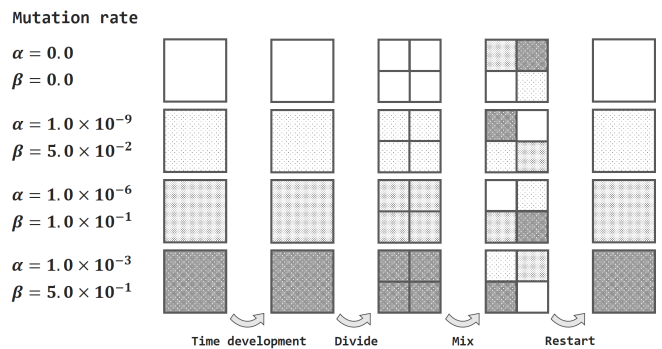

FIG. 4. Conceptual diagram of mutation. The probability of a mutation occurring for all cells at each step of the simulation is α , and the probability of a mutation occurring only for the new cell Book at cell division is β . Four fields were prepared and assigned different mutation probabilities to each field. After simulating a specific amount of time in each field, the virtual creatures grown in each field are distributed to the four fields and the simulation is rerun.

3. Efficiency for light energy conversion

The amount of light absorbed by a cell is expressed as the product of the light intensity and light absorption coefficient of the cell, which consists of three components: red, green, and blue. In other words, if the light intensity is I_r , I_g , and I_b for each component and the respective absorptivities of the cell are a_r , a_g , and a_b , then the amount of light ΔL absorbed by the cell can be expressed

as:

$$\Delta L = I_r a_r + I_g a_g + I_b a_b \quad . \quad (5)$$

Here, the parameters of how much of each color is converted to energy must be determined. The conversion efficiencies of the three components into energy are expressed as c_r , c_g , and c_b . Subsequently, the amount of energy ΔE_L obtained from the light absorbed by the cell is calculated using:

$$\Delta E_L = c_r I_r a_r + c_g I_g a_g + c_b I_b a_b \quad . \quad (6)$$

The parameters in this simulation were set to $c_r = 0.8$, $c_g = 0.2$, and $c_b = 0.8$. This approach is also used when determining the cost of generating cells, as described in Section IID 3. For example, white and black cells have smaller and higher generation costs, respectively, as indicated from the above equation. Therefore, this parameter is expected to affect the color of future cells.

4. Parameters for connections

Cells can connect to surrounding cells, but it is unnatural to connect to cells that are too far apart. Therefore, only cells within 1.95 times their radius r were allowed to be connected. In addition, the natural length of the connections between cells were varied according to the output of the neural network, but this is also unnatural if it is stretched too long. Therefore, this limit was set to 1.10 times a cell's own radius r . Lastly, the connections will be broken if the distance between connected cells is stretched for some reason and exceeds 2.00 times the natural length.

III. RESULTS AND DISCUSSION

A virtual creature was simulated for self-reproduction that formed a tetrahedron as its first virtual creature, as shown in Fig. 1. Additionally, the kind of virtual creatures that emerged was observed.

The results of the investigation of the ecology of the two observed virtual creatures are presented here, as well as a discussion of the results.

A. Dumbbell-shaped virtual creatures

In the simulations performed, single cells were generated in many cases that were proliferated by simple division in the early stages. One example of this is shown in Fig. 5.

Dumbbell-shaped virtual creatures could be seen after continuing the simulation for some time from this

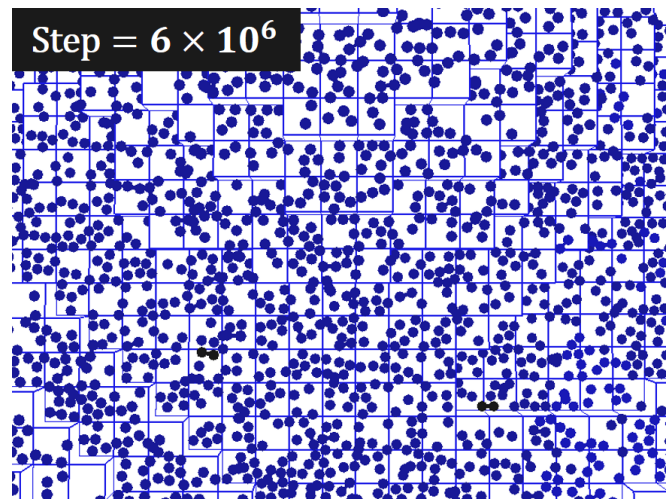

FIG. 5. Example of a single cell proliferating by simple division.

point, as shown in Fig. 6. The actual appearance of the virtual creatures is shown on the left, and a schematic of the self-reproduction is shown on the right. This dumbbell-shaped morphology was first seen at approximately 15×10^6 steps after the start of the simulation (top row in Fig. 6). At the 193×10^6 step, which was more than 10 times longer, the morphology had not changed significantly, merely in color and size (bottom row in Fig. 6). As mentioned in Section IIE 3, the energy conversion efficiency was set high for red and blue light, so this color change was considered to be an adaptation that reduced the absorption rate of green, which had a low energy conversion efficiency.

Focusing on the morphogenesis process of this dumbbell-shaped virtual creature, the white cells were born between the second and third steps and disappeared between the fourth and fifth steps. This disappearance was caused by the green cells that were connected to white cells eating the white cells. It was considered that this seemingly inexplicable process, in which the green cells ate the cells they generated, prevented the green cells from being eaten by other virtual creatures. As discussed in Section IID 2, cells with a high number of connections can eat cells with a low number of connections. Thus, without this white cell, the green cell at the edge would be vulnerable to predation by other virtual creatures because it only has one connection. This white cell increases the number of connections of the green cell and works as a protector to physically prevent other virtual creatures from approaching. In fact, the protector is changing to white and large, as shown in Fig. 6. This is a reasonable change when trying to expand the protector to keep predators away, at the lowest possible generation cost.

To confirm this role, a virtual creature was prepared by partially editing the Book of this dumbbell-shaped

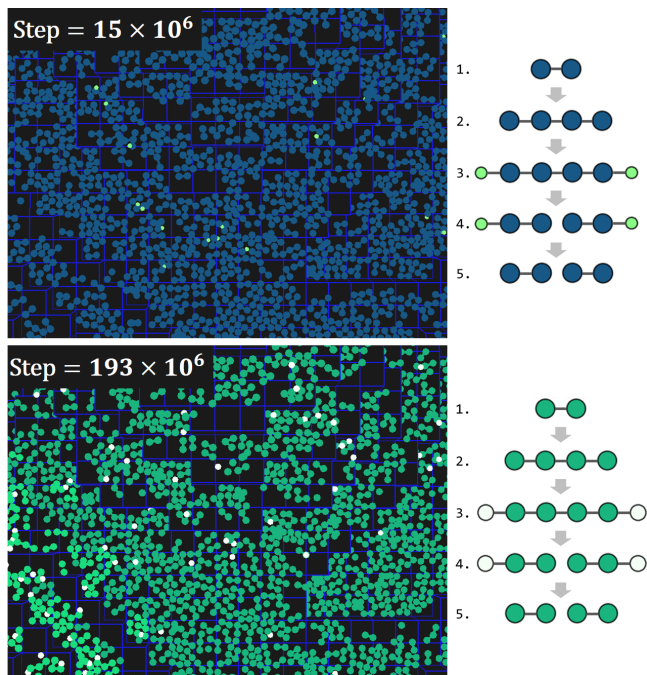

FIG. 6. Dumbbell-shaped virtual creatures evolved from a single cell. The actual appearance of the virtual creature is shown on the left, and a schematic of the self-reproduction is shown on the right.

virtual creature to remove the process that generated the white cells. Specifically, "SgSEmEefaAe3" in the Book was edited to "SgSEmEdfdAe3". The differences in this morphogenetic process are shown in Fig. 7. This virtual creature with omitted protector generation had a superior proliferation rate compared to the original dumbbell-type virtual creature because of its short self-reproduction cycle.

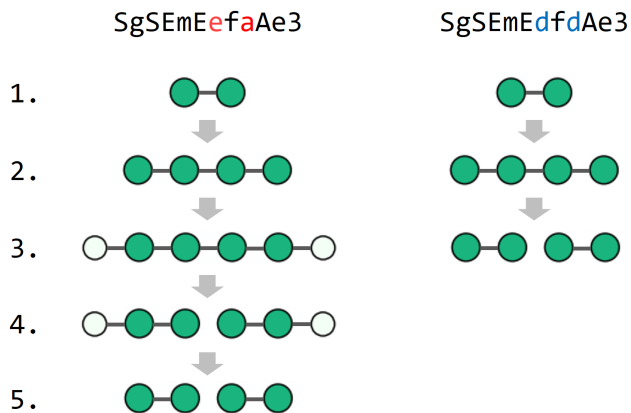

FIG. 7. Comparison of the morphogenesis process of a dumbbell-type virtual creature (left) and a virtual creature whose Book was edited to remove the process of protector generation (right).

These two types of virtual creatures were placed in the same field and changes to their respective populations were observed, as shown in Fig. 8. Note that the simulation was run with a fixed A , referring to the simulation results of the dumbbell-shaped virtual organism before editing. The role of parameter A was discussed in Section IID 1. As time passes, the populations for virtual creatures without protectors will decline and eventually become extinct.

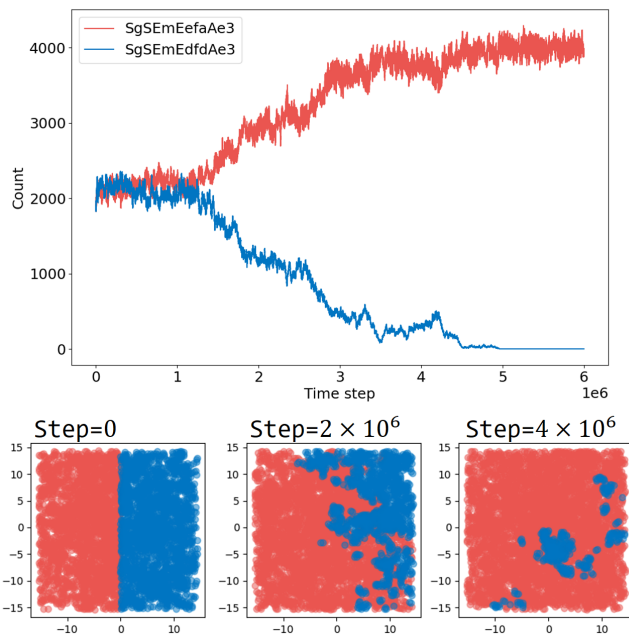

FIG. 8. Population changes of a dumbbell-shaped virtual creature with a protector (red) and virtual creature omitting the process of protector development (blue). The top panel shows the change in the respective populations with time evolution, while the bottom panel visualizes the distribution in the field for the three time periods.

This result strongly suggests that the white cells function as protectors. It was considered that the morphology was acquired from the single-celled state shown in Fig. 5, reflecting individual interactions.

B. Reticulated virtual creatures

The dumbbell-shaped virtual creatures discussed in Section III A contained two and three cells per individual. In this section, reticulated virtual creatures with a larger number of cells that make up one individual will be discussed. Note that this reticulated virtual creature was observed in simulations performed independently of the simulation presented in Section III A. The only difference between the two simulations is the seed value of the random number, which affected the formation of the

terrain, mutations, and locations where cells and photons were generated.

1. Number of connections and energy transport

As noted in Section IID 1, virtual creatures with a higher number of connections consume more energy. In order to increase the number of cells that make up one individual, the virtual creature must acquire a mechanism for efficiently distributing energy throughout its body. The reticulated virtual creature shown here has acquired such a mechanism. The change in the number of connections and energy transports over the entire field versus simulation time is shown in Fig. 9.

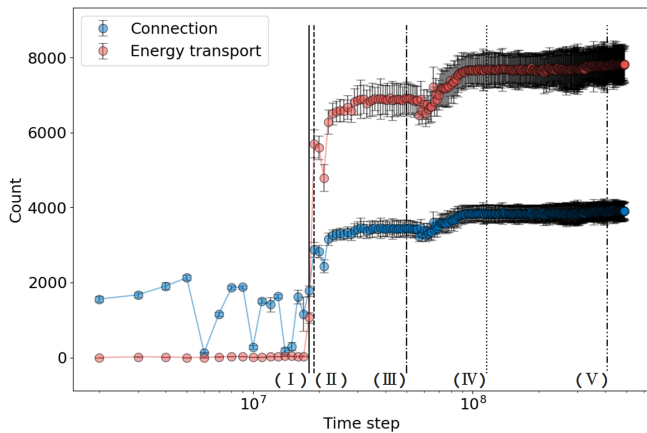

FIG. 9. Variation of the number of connections and energy transport times across the field versus simulation time. The error bars indicate invariant standard deviations. (I), (II), (III), (IV), and (V) are labels given to times with characteristic energy transport and number of bonds.

The energy transport between connected cells was approximately 0 until near the simulation time (II), and the number of connections fluctuated widely between 0 and 2000.

This fluctuation may be because virtual creatures with many connections were born but could not stably survive because the energy was not distributed properly. An example of a virtual creature from Fig. 9 (I) is shown in Fig. 10. Only the bonding is visualized on the right side of the figure and it has a more complex morphology than the dumbbell type. It appears as if pink legs are growing against a yellow body, and these legs are being violently moved.

The number of energy transports increased in proportion to the number of connections at Fig. 9 (II). This is the result of the virtual creatures obtaining the ability to distribute energy more efficiently. In fact, the number of connections was also stable from this point on. The virtual creatures seen on the field at times (II), (III), (IV), and (V) from Fig. 9 are shown in Figs. 11 (a), (b),

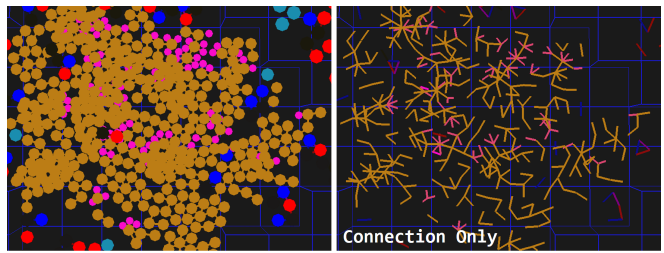

FIG. 10. Example of a virtual creature from Fig. 9 (I). The left image shows a cell and its bonding, while the right image shows only the bonding.

(c), and (d), respectively. The network grew larger as simulation time progressed. In addition, the color of the cells was accordingly closer to white, which had a small generation cost, as noted earlier. This was considered as a survival strategy in which the energy that a single cell could acquire from light was reduced, thus creating a wide network and sharing of the energy across the entire network.

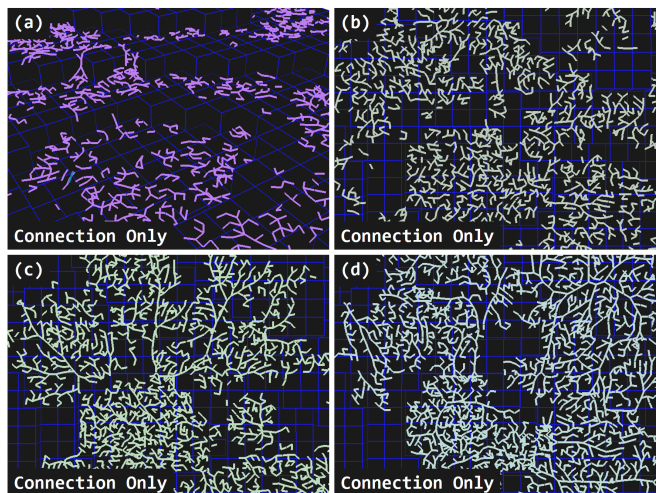

FIG. 11. Virtual creatures seen on the field: (a), (b), (c), and (d) represent times (II), (III), (IV), and (V) from Fig. 9, respectively. The network grows larger and whiter in color as the simulation time progresses.

2. How to spread offspring over a wide area

This reticulated virtual creature had a maximum of three connections extending from a single cell. Furthermore, it was expanding the fourth cell and disconnecting it simultaneously. A schematic diagram of this situation is shown in Fig. 12.

The cells expanded in Step 2 are pulled back to the cell from which they were generated. The natural length reduction of this spring is derived from the output sig-

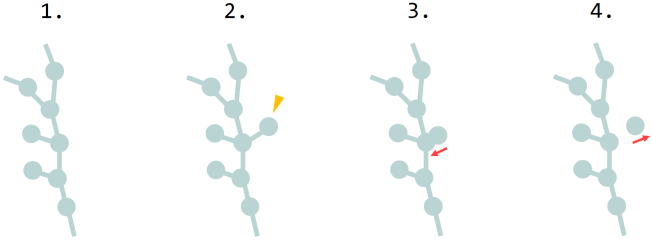

FIG. 12. Schematic diagram of the cell disconnection: Step 1 - original cell, Step 2 - a fourth cell is expanded, Step 3 - the connection distance between the expanded and source cell is reduced, and Step 4 - the bond is broken when the reduction reaches the distance limit between the cells, and the fourth cell is separated.

nal of the neural network, which is described in Section II C. Here, the natural length can be shortened to zero, but they cannot completely overlap each other because of the size of the cells. Therefore, contact between cells caused the spring to be stretched as the natural length of the spring was shortened. This connection will eventually break because the bond is designed to break when the distance between cells is twice the natural length, as mentioned in Section II E 4. Moreover, disconnected cells are separated by repulsion. This mechanism is an essential function of this virtual creature to push offspring farther away.

It is worth noting that this disconnection is not a behavior derived from the Book, it is caused by a neural network. This is because this neural network-triggered disconnection can be achieved flexibly depending on the surrounding circumstances. In this case, the disconnection was performed under the condition that the number of connections was four. The reticulate virtual creature could have acquired the survival strategy whereby reaching three bonds was enough for growth and thus it was better to move to the procreation phase.

3. Energy transport and parameters Δs

As mentioned earlier, the energy distribution was significant in a virtual creature composed of a large number of cells. The amount of energy to distribute was determined by the neural network presented in Section II C. How virtual creatures are affected when one parameter Δs that determines the behavior of the neural network is changed will now be discussed. The simulations here were run with $A = 2.0$, as discussed in Section II D 1.

This reticulated virtual creature evolved and grew in an environment where $\Delta s = 0.1$. First, the amount of available energy transport capacity in this setting was checked.

This experiment was performed using the following

procedure.

First, one cell was sampled from Fig. 11 (d) and fixed in the center of the flat field. Second, energy was continually provided only to that cell so that the cell continued to hold a certain amount of energy. This energy was set to be twice the energy required to produce the same cell. Third, cutting off light from the sun was simulated, and only energy from this fixed cell was supplied to the other cells. Even if this fixed cell generates other cells, the generated cell will die if the fixed cell cannot successfully transport energy. The number of cells in the field equilibrated after the simulation was run for some time. The reticulated virtual creatures at this time are shown in Fig. 13.

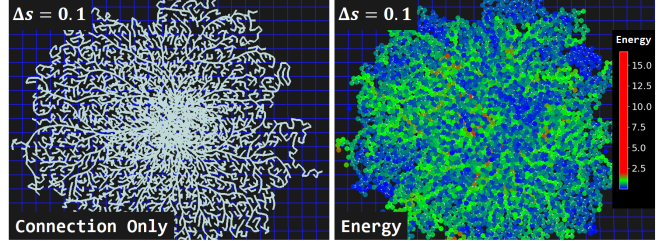

FIG. 13. One cell from Fig. 11 (d) was sampled and fixed in the center of the flat field, and the simulation was run with constant energy applied only to that fixed cell. The magnitude of this energy was set to twice the energy required to produce the same cell. The left panel shows only the cell bonding, while the right panel visualizes the energy of each cell. Δs was set to 0.1.

The reticulated virtual creature could form a large body composed of many cells, even though only a fixed central cell was supplied with energy. This result indicates that energy transport was conducted efficiently.

Next, the simulation results when the parameter was changed to $\Delta s = 0.0$ are shown in Fig. 14.

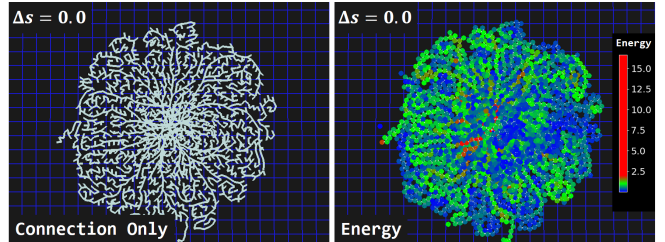

FIG. 14. One cell from 11 (d) was sampled and fixed in the center of the field, and the simulation was run with constant energy applied only to that fixed cell. The magnitude of this energy was set to twice the energy required to produce the same cell. The left figure shows only the cell bonding, while the right figure visualizes the energy of each cell. Δs was set to 0.0.

Compared to Fig. 13, the network spread was smaller

and $\Delta s = 0.0$ caused problems in the information transfer between cells, indicating that the energy transport did not work well.

Lastly, Δs was set to -0.1 for the reticulated virtual creature from Fig. 13, and the results are shown in Fig. 15.

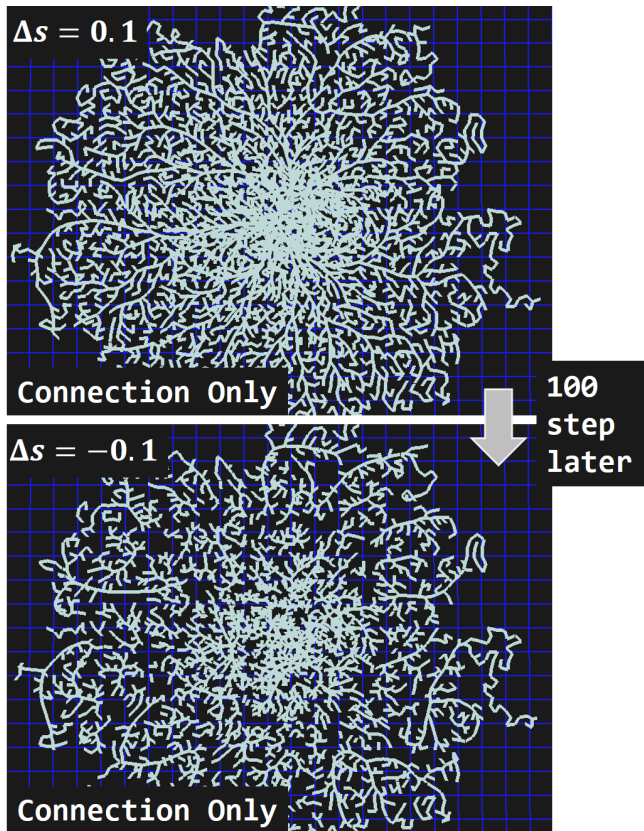

FIG. 15. $\Delta s = -0.1$ for the reticulated virtual creature from Fig. 13.

In this case, the reticulated virtual creatures were scattered because the change of $\Delta s = -0.1$ malfunctioned the diffusion process that was discussed in Section III B 2.

These results indicate that Hebb's rule, which was incorporated in a simplified manner, had a significant impact on energy transport and the diffusion of offspring. Specifically, energy transport exhibited a problem and the size of the reticulated virtual creature was reduced if Δs was set to 0.0 and grown without updating the coupling strength. In addition, providing inverse feedback on the coupling strength by setting Δs to -0.1 caused a collapse that may be due to a malfunction of the offspring diffusion process. This result demonstrates the importance of cell-to-cell communication in reproduction and development.

IV. CONCLUSION

This study proposed a new model of artificial life that could handle reproduction, development, and individual interactions in a composite way. Furthermore, two virtual creatures were introduced in this model.

The reticulated virtual creature had an interesting way of reproduction in which it detached parts of its own body and separated far from them. The virtual creature also grew a body composed of many cells by efficiently sharing energy, which is a more advanced developmental process than that in earlier tetrahedral virtual creatures. Regarding individual interactions, the dumbbell-shaped virtual creature acquired a form of protection by expanding a protective organ during division, making itself less susceptible to predation by other virtual creatures.

However, several properties were not seen in this simulation. For example, all the virtual creatures seen in this study were self-reproductions through asexual reproduction. Additionally, there was no evolution of vertical growth or active movement. It was assumed that one of the causes for this was simply the short simulation time, but the possibility that the model was not designed to easily produce such virtual creatures cannot be ruled out. Another problem was that the field used in this simulation was not large enough compared to the size of the cell. Therefore, there were almost exclusively the same virtual creatures in the same field as the simulation proceeded. In addition, the effects of field undulation geometry on evolution and changes in Book length over the course of evolution were not researched. Further studies are needed on these points.

V. ACKNOWLEDGMENTS

I would like to thank Hirokazu Nitta for his feedback, as it greatly helped improve the paper as a whole, especially the conclusion section. The advice and comments provided by Soichi Ezoe have also been a great help in improving the methodology section. I am also deeply grateful to Kazumasa Itahashi. Kentaro Yonemura also read the paper carefully and made some helpful comments, especially about the wording on the paper.

APPENDIX

The energy E of the cell after Δt seconds (one step) is updated as follows:

$$\begin{aligned} E(t + \Delta t) &= E(t) - \left(C \frac{A^{N_c}}{A^{N_{\max}}} \right) E(t) \Delta t \\ &= E(t) - UE(t) \Delta t \quad , \end{aligned} \quad (7)$$

where N_{\max} is the maximum number of cells that can be connected to the cell and N_c is the number of cells that are currently connected to the cell.

This can also be expressed as:

$$\frac{E(t + \Delta t) - E(t)}{\Delta t} = -UE(t). \quad (8)$$

If $\Delta t \rightarrow 0$, the above equation can be written as:

$$\frac{d}{dt}E(t) = -UE(t). \quad (9)$$

This equation can be easily solved, which results in:

$$E(t) = E_0 e^{-Ut}, \quad (10)$$

where E_0 denotes $E(0)$.

The energy obtained from a photon is calculated from the intensity I of the light, light absorption rate a of the cell receiving the light, and energy conversion efficiency c of the light, which is expressed as:

$$\Delta E_L = c_r I_r a_r + c_g I_g a_g + c_b I_b a_b, \quad (11)$$

where the subscripts r , g , and b refer to the red, green, and blue components, respectively. Therefore, when a single cell receives a photon at intervals of T seconds on average, the change in the energy of that cell is expressed as:

$$E((n+1)T) = E(nT) e^{-UT} + \Delta E_L. \quad (12)$$

Here, the numerical sequence is considered, which is expressed as:

$$f_{n+1} = r f_n + b. \quad (13)$$

The following equation is obtained as a general term:

$$f_n = \left(f_0 - \frac{b}{1-r} \right) r^n + \frac{b}{1-r}, \quad (14)$$

where $|r| < 1$.

If $E(t)$ is regarded as a sequence of numbers defined by the graded Eq. (12), and $f_n = E(nT)$, $r = e^{-UT}$, $b = \Delta E_L$ in Eq. (14), then:

$$E(nT) = \left(E_0 - \frac{\Delta E_L}{1 - e^{-UT}} \right) e^{-nUT} + \frac{\Delta E_L}{1 - e^{-UT}}, \quad (15)$$

where $0 < UT$. Therefore, $e^{-UT} < 1$.

E_∞ can be estimated as energy when enough time has passed and by using $n \rightarrow \infty$, which is expressed as:

$$E_\infty = \frac{\Delta E_L}{1 - e^{-UT}}. \quad (16)$$

Next, T is calculated.

The emitting cell releases an amount of light proportional to the square of its radius R during a unit time. Thus, the amount of light P received per unit area during a unit time at a distance h is expressed as:

$$P = \frac{DR^2}{4\pi h^2}. \quad (17)$$

If the area over which a cell receives light is ΔS , then the amount of light that a cell receives per unit time can be expressed as $P\Delta S$. This value is smaller than 1 in the simulations performed here. Therefore, it can be regarded as the probability p of a cell receiving one light per unit time, which is expressed as:

$$p = P\Delta S. \quad (18)$$

Subsequently, the average time T that a photon hits can be expressed as:

$$T = \sum_{n=1}^{\infty} n (1-p)^{n-1} p = \frac{1}{p}. \quad (19)$$

Finally, the following is obtained:

$$E_\infty = \frac{\Delta E_L}{1 - \exp\left[-\frac{U}{P\Delta S}\right]}. \quad (20)$$

[1] K. Sims, in *Proceedings of the 21st Annual Conference on Computer Graphics and Interactive Techniques*, SIGGRAPH '94 (Association for Computing Machinery, New York, NY, USA, 1994) p. 15–22.

[2] J. Lehman and K. O. Stanley, in *Proceedings of the 13th Annual Conference on Genetic and Evolutionary Computation*, GECCO '11 (Association for Computing Machinery, New York, NY, USA, 2011) p. 211–218.

- [3] J. E. Auerbach and J. C. Bongard, in *Proceedings of the 14th Annual Conference on Genetic and Evolutionary Computation*, GECCO '12 (Association for Computing Machinery, New York, NY, USA, 2012) p. 521–528.
- [4] N. Cheney, R. MacCurdy, J. Clune, and H. Lipson, *SIGEVolution* **7**, 11–23 (2014).
- [5] H. Lipson and J. B. Pollack, *Nature* **406**, 974 (2000).
- [6] G. Hornby, H. Lipson, and J. Pollack, *IEEE Transactions on Robotics and Automation* **19**, 703 (2003).
- [7] K. Sims, *Artificial Life* **1**, 353 (1994).
- [8] K. O. Stanley, *Genetic Programming and Evolvable Machines* **8**, 131–162 (2007).
- [9] L. Schramm, Y. Jin, and B. Sendhoff, in *Advances in Artificial Life. Darwin Meets von Neumann*, edited by G. Kampis, I. Karsai, and E. Szathmáry (Springer Berlin Heidelberg, Berlin, Heidelberg, 2011) pp. 27–34.
- [10] M. Joachimczak and B. Wróbel, in *Proceedings of the 14th Annual Conference on Genetic and Evolutionary Computation*, GECCO '12 (Association for Computing Machinery, New York, NY, USA, 2012) p. 561–568.
- [11] *Fine Grained Artificial Development for Body-Controller Coevolution of Soft-Bodied Animats*, ALIFE 2022: The 2022 Conference on Artificial Life, Vol. ALIFE 14: The Fourteenth International Conference on the Synthesis and Simulation of Living Systems (2014) <https://direct.mit.edu/isal/proceedings-pdf/alife2014/26/239/1901279/978-0-262-32621-6-ch040.pdf>.
- [12] M. Joachimczak, R. Kaur, R. Suzuki, and T. Arita (2015).
- [13] T. Ito, M. L. Pilat, R. Suzuki, and T. Arita, *Artificial Life and Robotics* **18**, 36 (2013).
- [14] J. V. Neumann and A. W. Burks, *Theory of Self-Reproducing Automata* (University of Illinois Press, USA, 1966).
- [15] T. J. Hutton, *Artificial Life* **16**, 99 (2010), <https://direct.mit.edu/artl/article-pdf/16/2/99/1662659/artl.2010.16.2.16200.pdf>.
- [16] E. R. Banks (1971).
- [17] J. R. Koza, in *Artificial Life III* (Addison-Wesley, 1994) pp. 225–262.
- [18] C. G. Langton, *Physica D: Nonlinear Phenomena* **10**, 135 (1984).
- [19] H. Sayama, (1999).
- [20] D. O. Hebb, *The organization of behavior: A neuropsychological theory* (Wiley, New York, 1949).