

VLSNR: Vision-Linguistics Coordination Time Sequence-aware News Recommendation

Songhao Han*
Beihang University
hshjerry@buaa.edu.cn

Wei Huang*
Beihang University
aaron.weihuang@gmail.com

Xiaotian Luan*
Peking University
1900013098@pku.edu.cn

Abstract

News representation and user-oriented modeling are both essential for news recommendation. Most existing methods are based on textual information but ignore the visual information and users' dynamic interests. However, compared to textual only content, multimodal semantics is beneficial for enhancing the comprehension of users' temporal and long-lasting interests. In our work, we propose a vision-linguistics coordinate time sequence news recommendation. Firstly, a pre-trained multimodal encoder is applied to embed images and texts into the same feature space. Then the self-attention network is used to learn the chronological sequence. Additionally, an attentional GRU network is proposed to model user preference in terms of time adequately. Finally, the click history and user representation are embedded to calculate the ranking scores for candidate news. Furthermore, we also construct a large scale multimodal news recommendation dataset V-MIND. Experimental results show that our model outperforms baselines and achieves SOTA on our independently constructed dataset.¹

1 Introduction

The enormous amount of news available everyday makes it impossible for readers to find what they are interested in immediately (Okura et al., 2017). Currently, news platforms like Google News² and Microsoft News³ has constructed recommendation system to improve user experience. Hence, the central target of news recommendation is to eliminate information overload and provide users with content of interest based on their habits (Lavie et al., 2010). Initially, recommendation researches concentrated on literature (An et al., 2019; Lian

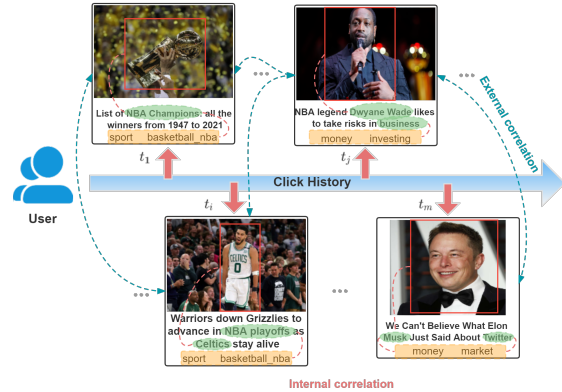

Figure 1: An illustrative example of users' dynamic interests in news with multimodal information. The blue bidirectional arrows represent external correlation. The red dotted lines represent internal correlation.

et al., 2018; Wang et al., 2018; Wu et al., 2019b,a,c, 2021b). For instance, Okura et al. (2017) proposed gate recurrent unit network to capture users' interests over time. However, it is difficult for GRU to capture contextual content information. Wang et al. (2018) leveraged knowledge graph with convolutional neural network to learn the interaction between history news and candidate news. The above methods are all based on text information. However, the lack of visual information may lead to inaccurate representation of users' interests.

Recently, there are few approaches of multimodal recommendation taking texts and images into consideration (Wu et al., 2021a; Xun et al., 2021), which is closer to people's reading routine in the real world. For example, Wu et al. (2021a) propose a multimodal encoder to learn news representation from title and image, and learn users' representation using a cross-modal candidate-aware network. However, this approach ignores the significance of time sequence for user modelling.

Our method is motivated by the fact that user interests are not only dynamic (sometimes the changes may be subtle) but also reflected in the

⁰*Three authors contributed equally to this research.

¹<https://github.com/Aaronhuang-778/V-MIND>

²<https://news.google.com>

³<https://www.msn.com/news/>

multimodal information of the news. User’s clicks are influenced by his long-lasting interests (Li et al., 2014) and current hot spots. For example, if a user is an NBA fan, as illustrated in Figure 1, this individual tends to browse much news about NBA games and players, like "NBA champions", "Celtics" and "NBA playoff" etc. elements. This kind of click tendency mainly depends on the user’s long-term interest (Wu et al., 2019a). Also, the user may click some news triggered by recent hot spots, part of which are related to previous concerns. For example, in Figure 1, the browsing of the news on "Wade likes to take risks in business" and title causes the user to read "Musk" and "Twitter", even if the one had never clicked on Twitter-related news before. It is noteworthy that information from different modalities is complementary or reinforcing to each other. Specifically, within a news article, the trophy in the image of the t_1 corresponds to the "champion" in the title, and both the topic and subtopic enhance this critical information. Among different news, the image of t_j (an example of current hot-spots) also correlates with the reader’s long-term interest, whereas the content is highly relevant to that of t_m , which can be proved by their same topic.

In this paper, we propose a Vision-Linguistics coordination time Sequence-aware News Recommendation named VLSNR, which takes advantage of fusion modules to process cross-modal information in time series. To be more precise, we establish user models via above-mentioned time-awareness network evaluated by the correlation between history clicks and candidates, which help to comprehend users’ variable interest. In our approach, we transmit the image and title into CLIP encoder (Radford et al., 2021) to learn the representation of news. This enables the semantics of texts and images to be well mapped in the same feature space. Then, we construct a series of attention layers, which helps to detect deeper interaction between images and texts. Additionally, we propose an attentional GRU network (Okura et al., 2017) to learn users’ chronological interests.

Noteworthy, we construct a complete dataset named V-MIND based on MIND, a benchmark data for text-domain news recommendation. Our experiments on this completely new dataset have demonstrated our approach can effectively improve the performance and our modelling can be proved to be more consistent with the behaviour of real

users. Our contributions of this work are displayed as follows:

- We propose the VLSNR framework, which integrates visual and textual information about news in time series to learn click-preferences trends. VLSNR is able to fully characterize the overall news features and simulate users’ behavior better.
- We contribute visual information to the MIND dataset named V-MIND, which is the largest scale. It helps facilitate the future research of news recommendations in multimodal domain and improve the learning results of VLSNR.
- We have conducted extended experiments on the V-MIND dataset. The result shows that our method can effectively detect the interaction of visiolinguistic information and our model outperforms other news recommendation approaches.

2 Related Work

The rapid growth of information has made news more diverse, and people are willing to spend more time browsing news. Personalized news recommendation (Zheng et al., 2018) has become an important task in the field of natural language processing and data mining and has benefited from great success in semantic analysis (Wang et al., 2018; Bahdanau et al., 2014; Li et al., 2020; Ren et al., 2015) and user preference estimation (Okura et al., 2017).

The processing of textual information extraction such as news headlines and topics has evolved through CNN (Wang et al., 2020), RNN (Okura et al., 2017), GNN (Hu et al., 2020) and Attention mechanisms (Wu et al., 2019a; Zhu et al., 2019). Wu et al. (Wu et al., 2019c) used the multi-head attention mechanism to expand the textual semantic information of news to uncover the relationship between the records of users’ historical clicks. An et al. (An et al., 2019) proposed two models that can characterize long-term short-term interest by combining news text features and the temporal cycle of user behavior. This is more in line with the user’s behavioral habits and makes the overall effectiveness of the recommendation model improved. However, these approaches target recommendations entirely on the processing of textual features, ignoring other behavioral drivers when

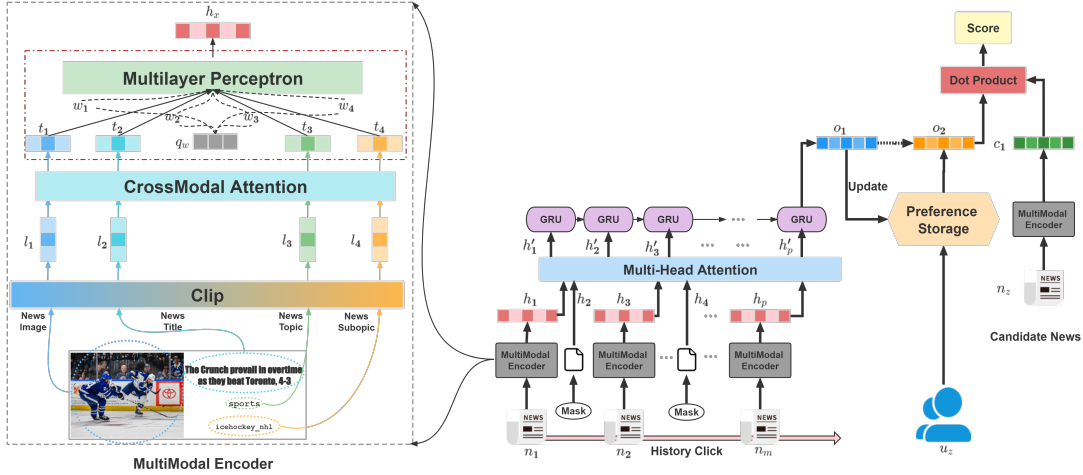

Figure 2: The model architecture of VLSNR

users click on news. News cover images have a greater visual share in news information, and the vision information of the images has an impact on user behavior.

As an efficient method, multimodal technology (Anderson et al., 2018; Zhang et al., 2020) can fuse different kinds of information such as text, images and speech to extract higher-level semantic features of news. Multimodal fusion using mainly cover information and text information in news recommendation. Wu et al. (Wu et al., 2021a) used a ViLBERT (Lu et al., 2019) pre-training model to semantically match images and news headlines, then embedding them separately and feeding both information into the attention layer of the crossover model for prediction. Xun et al. (Xun et al., 2021) which extracted the semantics of news images and news headlines with local features and used an additive attention (Wu et al., 2021b) mechanism for multimodal fusion. Since there is no news dataset supporting multimodality, Xun’s team retrieved its original news URLs based on MIND News (Wu et al., 2020) and added visual information to 54,421 news items out of 130,379 news items. These multimodal models do not combine the characteristics of users’ long-period and short-period preferences for image and text information, and use a strong asymmetry in the dataset, with only 41.7% of the image data despite the supplementation, which has an impact on the overall performance and robustness of the multimodal integrated model. In this paper we propose a recommendation architecture for long and short period interest preferences based on the fusion of news text information and image

information features, and extract multimodal features using the more powerful Clip (Radford et al., 2021) model. We also crawl relevant news image covers based on news text information in Google so that the image coverage of the MIND dataset reaches 100%.

3 Our Method

In this section, we introduce our Vision-Linguistics coordination time Sequence-aware News Recommendation approach, whose overall framework is shown as Figure 2. Our structure is made up of three components, i.e., a multimodal news encoder to learn and integrate visiolinguistic representations of news, a time-series network to capture temporal characteristics and a module for users’ representations. Then, we detailed present each unit.

3.1 Multimodal News Encoder

It is a common perception that people focus on the headline of a news item before clicking on it. However both news cover and text information affect the possibility of users to click on the news (Pounds, 2012). Therefore, we designed a cross-modal encoder in our VLSNR structure to extract user’s comprehensive information understanding of the news. Based on the information presentation of news items, we use news covers, headlines, topics and subtopics.

Visual and language-based multimodal models can effectively map low-dimensional text and images to high-dimensional features. Then it capture the semantics of text and images in a high-

dimensional metric feature space. Therefore, we use Clip (Radford et al., 2021) pretrained model to capture the potential interaction features of news text and images. For the input images, we chose ViT-B/32 (Dosovitskiy et al., 2020) for processing, which encodes the images using a multi-headed attention structure similar to Bert (Devlin et al., 2018), and Clip takes the input text and uses several Transformers (Vaswani et al., 2017) to understand the sequential semantic information of the words. Then the above image and text features are linearly projected into the multi-modal embedding space. The output is defined as $\mathbf{L} = [\mathbf{l}_1, \mathbf{l}_2, \mathbf{l}_3, \mathbf{l}_4]$. These four long vectors are fed into a layer of crossmodal attention to regulate the focus of different information. The focus of the t_i vector learned by \mathbf{n} attention heads is computed as:

$$\alpha_i^k = \text{softmax}(\mathbf{l}_i^T \mathbf{Q}_k \mathbf{L}) \quad (1)$$

$$\mathbf{t}_i = \text{concat}(L(\alpha_i^1)^T; L(\alpha_i^2)^T \dots; L(\alpha_i^n)^T) \mathbf{V} \quad (2)$$

where \mathbf{Q}_k and \mathbf{V} are the net parameters in each self-attention head, and $\alpha_i^k[j]$ is the k^{th} head attention weight of \mathbf{l}_i on \mathbf{l}_j . The output of \mathbf{t}_i is the result of \mathbf{l}_i 's crossmodal attention allocation. $\mathbf{T} = [\mathbf{t}_1, \mathbf{t}_2, \mathbf{t}_3, \mathbf{t}_4]$ has the same feature space properties, but is composed with image and text information. To perform multimodal fusion of these four vectors, we use an additive attention layer to compute their normalized weight:

$$\alpha' = \mathbf{q}_a^T \tanh(W_a \times \mathbf{T} + \mathbf{b}_a) \quad (3)$$

$$\alpha' = \text{softmax}(\alpha') \quad (4)$$

where \mathbf{q}_a is the query vector of additive attention, and W_a and \mathbf{b}_a are the net parameters. The final four information will be fused by the weights output of softmax, computed as:

$$\mathbf{x} = \alpha' \mathbf{T} \quad (5)$$

where \mathbf{x} is the input of the next layer. To compress the vector space to a suitable size, we use a multilayer perceptron as the last process for feature learning, formulated as:

$$\mathbf{h}_x = \mathbf{g}(\mathbf{W}_i \times \mathbf{x}_i + \mathbf{b}_i) \quad (6)$$

where \mathbf{W}_i and \mathbf{b}_i are the weights parameters, \mathbf{x}_i is the input of each layer in multilayer perceptron and \mathbf{g} is the activation function. The final fusion vector is expressed as \mathbf{h}_x .

3.2 Time Sequence-aware Network

The sequential network is totally used to precisely model users' interest in chronological order according to their previous clicked histories. Take a user for instance, with the Batman movie becoming a worldwide hit, even if he is not a big fan of superhero-themed films, he may probably be attracted by relevant article, which can be attributed to his friends' experience. It is professional for GRUs(Cho et al., 2014) to capture **temporal** correlation among his browsing(Okura et al., 2017). To better simulate the actual situation, We have randomly added masked news to represent the noise during the browsing process. In the real world, a hockey fan might tend to follow hockey games or news about his favourite players for a **long period of time**. It is worth mentioning that we have applied attention modular to enhance global information to eliminate the negative influence of forgetfulness of earlier behaviours in a long sequence. Up to this point, both global and short-time information are taken into account. We use a history sequence $\mathbf{H} = [\mathbf{h}_1, \mathbf{h}_2, \dots, \mathbf{h}_p]$ to donate the representations of news. In order to detect the interactions among history news, we leverage self-attention network layer(Vaswani et al., 2017). The outputs matrix $\mathbf{H}' = [\mathbf{h}'_1, \mathbf{h}'_2, \dots, \mathbf{h}'_p]$ are computed as follows:

$$\beta_i^k = \text{softmax}(\mathbf{h}_i^T \mathbf{Q}'_k \mathbf{H}) \quad (7)$$

$$\mathbf{h}'_i = \text{concat}(H(\beta_i^1)^T; H(\beta_i^2)^T \dots; H(\beta_i^n)^T) \mathbf{V} \quad (8)$$

where \mathbf{Q}'_k is an attention query matrix, \mathbf{V} is a parameter matrix. After that, the outputs matrix is sliced into vectors sequence $[\mathbf{h}'_1, \mathbf{h}'_2, \dots, \mathbf{h}'_p]$, which are transported into GRUs network. And the chronological information is extracted and reinforced via this module. The calculation process is formulated as followed:

$$\begin{aligned} \mathbf{z}_t^u &= \sigma(\mathbf{W}_u[\mathbf{hid}_{t-1}, \mathbf{h}'_t] + \mathbf{b}_u) \\ \mathbf{z}_t^r &= \sigma(\mathbf{W}_r[\mathbf{hid}_{t-1}, \mathbf{h}'_t] + \mathbf{b}_r) \\ \tilde{\mathbf{hid}}_t &= \tanh(\mathbf{W}_{\tilde{\mathbf{hid}}_t}[\mathbf{z}_t^u \otimes \mathbf{hid}_{t-1}, \mathbf{h}'_t] + \mathbf{b}) \\ \mathbf{hid}_t &= \mathbf{z}_t^u \otimes \mathbf{hid}_{t-1} + (1 - \mathbf{z}_t^u) \otimes \tilde{\mathbf{hid}}_t \end{aligned} \quad (9)$$

where \mathbf{z}_t^u is the update gate unit, \mathbf{z}_t^r is the reset gate unit, σ is the sigmoid function, \otimes is the element-wise product, \mathbf{W}_u , \mathbf{W}_r and $\mathbf{W}_{\tilde{\mathbf{hid}}_t}$ are parameters matrices of GRU network. The representation \mathbf{o}_1 of the series of user histories is the final hidden state of this network, i.e., $\mathbf{o}_1 = \mathbf{hid}_k$.

3.3 User Preference Learning

In terms of the extraction of user representation, we use an existing neural network approach, i.e., the multi-head self-attention mechanism, to capture correlations among user's history browsing. The representation of the i_{th} history learned by the l_{th} attention head. Denote the representation of user \mathbf{o}_1 as \mathbf{u} . This is formulated as follows:

$$\begin{aligned}\alpha_{i,j}^l &= \text{softmax}(\mathbf{u}_i^T \mathbf{Q} \mathbf{u}_j) \\ \mathbf{h}_{i,k}^n &= \mathbf{V} \left(\sum_{j=1}^m \alpha_{i,j}^l \mathbf{u}_j \right)\end{aligned}\quad (10)$$

where \mathbf{Q} and \mathbf{V} are parameters matrices of self-attention network, and $\alpha_{i,j}^l$ is the representation of the interaction between i_{th} and j_{th} user's history. The multi-head is the concatenation of the output by h self-attention heads, i.e., $\mathbf{h}_i^n = [\mathbf{h}_{i,1}^n; \mathbf{h}_{i,2}^n; \dots; \mathbf{h}_{i,h}^n]$. Likewise, additive attention weights is computed as follows:

$$\begin{aligned}w_i^n &= \mathbf{q}_n^T \tanh(\mathbf{V}' \times \mathbf{h}_i^n + \mathbf{b}_n) \\ \beta_i^n &= \text{softmax}(w_i^n)\end{aligned}\quad (11)$$

where \mathbf{q} , \mathbf{V}' , \mathbf{b}_n are parameters matrices of self-attention network, and the final representation of user is the weighted summation of the overall histories, which is formulated as follows:

$$\mathbf{o}_2 = \sum_{i=1}^n \beta_i^n \mathbf{h}_i^n \quad (12)$$

3.4 Model Training

For online news recommendation platforms where user and news representations can be calculated beforehand, the evaluation should be as simple and efficient as possible to minimise latency (Wu et al., 2019c). Inspired by the work of Okura et al. (Okura et al., 2017), we use a weighted sum to calculate the possibility of a news click. Denote the representation of current behaviours as \mathbf{o}_1 and previous user behaviours as \mathbf{o}_2 and the representation of a candidate news n_z as \mathbf{e}_z , the probability score as $score_z = (\alpha \mathbf{o}_1)^T \mathbf{e}_z + [(1 - \alpha) \mathbf{o}_2]^T \mathbf{e}_z$. Motivated by Wu et al. (Wu et al., 2019a), we use the random negative sampling method and cross entropy loss during training, which can be formulated as:

$$- \sum_{i=1}^P \log \frac{\exp(score_{z,i}^+)}{\exp(score_{z,i}^+) + \sum_{i=1}^K \exp(score_{z,i}^-)} \quad (13)$$

where P is the number of positive samples, and K is the number of negative samples.

4 Dataset



(a) N1.jpg

(b) N2.jpg

Figure 3: Illustration of two examples and their titles. (a): N1: "Texans defensive tackle D.J. Reader is taking advantage of his opportunities." (b) N2: "Mormons to the Rescue?"

4.1 Dataset Establishment

To the best of our knowledge, the previous work did not have suitable dataset to support multimodal news recommendation tasks with images and text. Xun et al. (Xun et al., 2021) made a great contribution to MIND (Wu et al., 2020) and constructed the IM-MIND (Xun et al., 2021) dataset with 41.74% image coverage. However, for multimodal news recommendation a large number of blank images will affect the robustness of the training process. Since that, we built a benchmark dataset⁴ on the basis of the MIND dataset (Wu et al., 2020). Specifically, we used the text information and added the corresponding image information. Examples are illustrated in appendix.

Owing to part of invalid news URLs, we need a different approach to crawl the image of news. It occurred to us that we could search the news with invalid URLs for cover pictures using headlines of the required news in bulk with the HTML code in Google Images⁵. Crawling news images are prioritized from the original site. For the news that is no longer available, we searched for the same news story on other sites in order of similarity of headlines and get its cover image. After that, we named each figure with the corresponding news id, as shown in figure 3. To better support future research, all of the images were resized into 224*224px respectively. We have constructed the large dataset, according to MIND-large version.

4.2 Detailed Statistics

Table 1 lists the comparison details of MIND, IM-MIND and our V-MIND. The entire dataset con-

⁴The dataset will be released.

⁵<https://images.google.com/>

Dataset	News	Users	Image	$Image_{rate}$	$origin_{rate}$
MIND-large	130,379	876956	0	0%	0%
IM-MIND	130,379	876956	54421	41.74%	41.74%
V-MIND	130,379	876956	130379	100%	98.92%

Table 1: Detailed statistics of MIND, IM-MIND and V-MIND

Model	AUC	NDCG@5	NDCG@10	MRR
DeepFM	0.659	0.345	0.407	0.314
DKN	0.672	0.353	0.417	0.321
NPA	0.675	0.358	0.422	0.326
LSTUR	0.680	0.363	0.427	0.323
NRMS	0.676	0.356	0.422	0.323
FIM	0.685	0.368	0.431	0.331
NRMS-IM	0.687	0.369	0.432	0.331
FIM-IM	0.691	0.373	0.436	0.336
VLSNR(Ours)	0.695	0.376	0.440	0.340

Table 2: Performance Comparison with state-of-the-art news recommendations under V-MIND and MIND-large.

tains 130,379 news items and 876,956 users. **Image** is used to denote the number of news that contains the image. V-MIND contains 130,379 images, which ensures that every news item has a set of text-image information. 1401 news could not get the cover of the original news, so we use the same one in other reports to replace it. The vision coverage of our V-MIND reached 100%, and the original cover restoration rate reaches 98.92%.

5 Experiments

5.1 Experimental Settings

In our experiment, we used the pretrain CLIP encoder, (Radford et al., 2021) as the initialisation of word embedding, i.e., BERT model (Devlin et al., 2018) and image embedding, i.e., Vision Transformers. Both word and image embedding dimension are 512. The head of crossmodal attention network is 8. We applied dropout (Srivastava et al., 2014) to mitigate overfitting. The dropout rate is 0.5. We used Adam (Kingma and Ba, 2014) to optimize our model, and the learning rate is 1e-4. The batch size is 256. The number of negative samples for each positive one is 3. We repeated each experiment 5 times, and used universal ranking metrics to evaluate the performance, including AUC, MRR, NDCG@5 and NDCG@10 scores.

5.2 Performance Comparison

In this section, we compare the proposed VLSNR model with several baseline methods. We document

the performance of different methods on the V-MIND dataset, including: (1) DeepFM (Guo et al., 2017), a popular neural recommendation method which synthesizes deep neural networks and factorization machines; (2) DKN (Wang et al., 2018), using CNN to embedding news with both word and entity; (3) NPA (Wu et al., 2019b), learning news representation with personalized attention mechanism; (4) LSTUR (An et al., 2019), learning click trends with long-term and short-term user interests; (5) NRMS (Wu et al., 2019c), using multi-head attention to learn users behavior in news option; (6) FIM (Wang et al., 2020), learning news features with a fine-grained method; (7) NRMS-IM and FIM-IM (Xun et al., 2021), using resnet101 to obtain the feature map of images. In method (1-6), news tests information are the only feature be learned. Method (7-8) add a block for news cover extraction after text. Table 2 shows the results of the comparison experiment. It shows that methods that combine visual and textual information outperform other methods that consider only text content. This is because users not only focus their interest on the text before clicking on the news, but also depends on how much they like the images. Therefore, we believe that multimodal modeling of text and images in news recommendation systems is more consistent with the simulation of user behavior, which obviously improves the performance of the recommendation system. Our VLSNR achieves better performance in multimodal news recommendations.

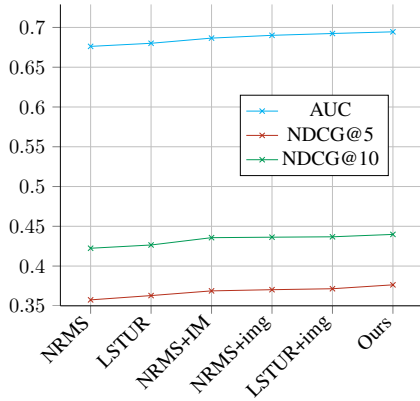

Figure 4: Effectiveness of different methods

Then we note that the temporal information of the user’s interest can play a significant role in the prediction of next clicks. We compared A with other methods to show the performance of time-aware. The results are shown in Figure 4. LSTUR (An et al., 2019) uses GRU to learn time-aware in a text-only news recommendation model, which shows better performance compared to NRMS. Based on Xun’s (Xun et al., 2021) contribution of adding image information to NRMS, we replaced the image data with our V-MIND and concatted the visual information on the output vector of LSTUR. We find that the temporal features can learn the fusion information of image and text very well, and VLSNR can show better performance in the fusion of multimodal and temporal features.

5.3 User Modelling

User modelling is core of the design of personalised news recommendation systems. Therefore, it is essential to investigate the performance differences among various modelling approaches. We present several ablation studies on different methods, including none user embedding, weighted average of the representation of clicked histories, GRU network (Okura et al., 2017), self-attention mechanism (Wu et al., 2019c). The performances are shown in Figure 5. Apparently, user encoders can improve performance, compared to none user encoder. Then, GRU and self-attention both outperform average method. This may be attributed to the fact that the averaging method does not make use of information on timing or user attention, which can be informative when we model users based on their historical browsing. When it comes to self-attention approach, the best performance among the four, its global focus on long sequences makes

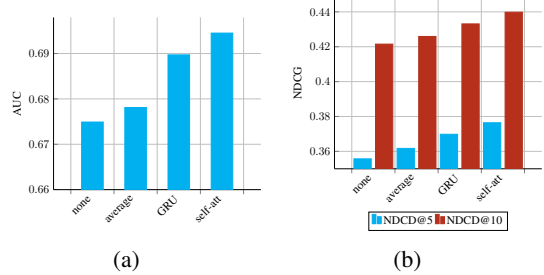

Figure 5: Ablation studies on different user modelling.

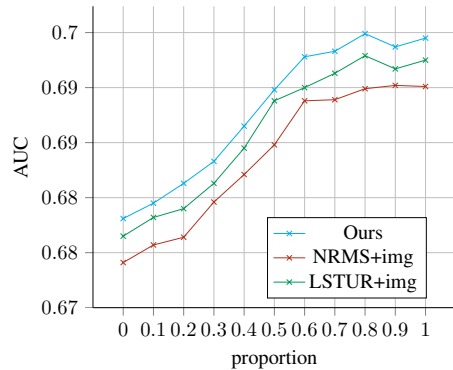

Figure 6: Ablation studies on different image proportion

it superior to GRU in user modelling.

5.4 Vision-Linguistics Ablation Study

Then, we study the effectiveness of multimodal information on news recommendation through ablation experiments. We adjust the ratio of the image information in the dataset during the training process. Another part of the images is replaced with 224*224px white images, and the text information is the same. The results are shown in Figure 6. We find that the performance of the recommendation system grows as the proportion of news with visual features increases. AUC rises slowly after the image ratio reaches 70% and eventually reaches its peak, which shows that visual information can improve the performance of news recommendation.

In order to better study the influence of news

AUC	NRMS+img	LSTUR+img	Ours
top	0.621	0.617	0.619
sub	0.637	0.633	0.635
tit	0.667	0.663	0.664
tit+top+sub	0.672	0.667	0.670
tit+img	0.681	0.677	0.680
overall	0.694	0.690	0.692

Table 3: Ablation studies on different news information

composition on recommendation results, we split the text information of news and images for a comprehensive comparison. Table 3 shows that semantic contribution of title in text information is greater than that topic and subtopic. News recommendations perform better when image information is combined with title. The best performance is achieved when the visual information of the news and all text information are multimodally fused in VLSNR.

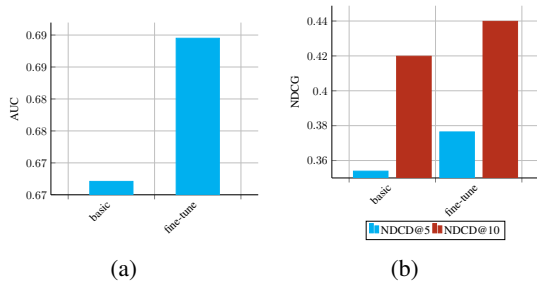

Figure 7: Ablation studies on different user modelling.

We find that there are some performance limitations in clip’s pre-trained model, such as poor results on finer-grained recognition and low accuracy in understanding abstract news headlines. We therefore further trained clip’s model and installed it into our model to participate in the training together, which eventually achieved better results, as illustration in Figure 7. Fine-tuning of the CLIP model has resulted in good performance improvements.

5.5 Ranking Contrast

Motivated by MM-Rec(Wu et al., 2021a), we are curious about the different methods (MM-Rec, LSTUR(Wu et al., 2019a) and VLSNR) that generated predictions of user click behaviour. We therefore study a set of historical reading behaviours of a user. Results are displayed in Figure 8. We find that this user viewed news on sports (including rugby and basketball), movies and politics. One interesting phenomenon is that the predictions for the first piece of candidate news are strikingly similar. This is probably because historical information such as "Raiders", "Sixers" and the corresponding multimodal information indicates that the user is a sports fan. However, for another candidate, the results are quite diverse. LSTUR is completely incapable to comprehend the relevance of this news to previous news, which is to be expected, as it cannot make use of visual information. Both multimodal approaches

capture the association between the two women in politics. It is worth noting that our method sorts this news further up the list due to time sensitivity. These results show the effectiveness of crossmodal

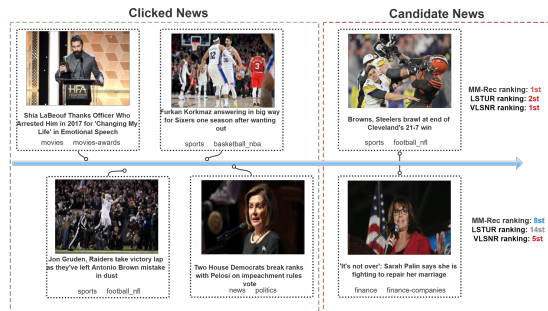

Figure 8: An example of a user’s browsing history and candidate news. The predicted ranking of MM-Rec, LSTUR and VLSNR(Ours) is also shown on the graph.

information and the significance of time-sequence in news recommendation.

6 Conclusion and Future Work

In this paper we propose VLSNR, which can use fused information from images and text for news recommendation. We encode text and images through tune’s clip training model and capture important features between images and text through a layer of crossmodal attention and a layer of additive attention. We have improved the time series model so that it learns better about user features, which is an important addition to previous work. We contribute the MIND dataset with visual information to promote more researches on news recommendation in a multimodal fields. Extensive experiments have shown that VLSNR can effectively improve the performance of news recommendation because of its extraction of multimodal information and perception of time series.

In subsequent work we will explore and use better multimodal models, such as those with greater text analysis capability and finer granularity, and seek to pre-train a large number of stories to achieve better results.

Limitations

Firstly, the multimodal model we use is an existing model that works well, however, the problems with the model (including those related to granularity) limit our work to some extent. Then, we work only in the English semantic context. As multimodal

datasets for news recommendations are relatively scarce, we can only test from our dataset as well.

References

- Mingxiao An, Fangzhao Wu, Chuhan Wu, Kun Zhang, Zheng Liu, and Xing Xie. 2019. Neural news recommendation with long-and short-term user representations. In *Proceedings of the 57th Annual Meeting of the Association for Computational Linguistics*, pages 336–345.
- Peter Anderson, Xiaodong He, Chris Buehler, Damien Teney, Mark Johnson, Stephen Gould, and Lei Zhang. 2018. Bottom-up and top-down attention for image captioning and visual question answering. In *Proceedings of the IEEE conference on computer vision and pattern recognition*, pages 6077–6086.
- Dzmitry Bahdanau, Kyunghyun Cho, and Yoshua Bengio. 2014. Neural machine translation by jointly learning to align and translate. *arXiv preprint arXiv:1409.0473*.
- Kyunghyun Cho, Bart Van Merriënboer, Caglar Gulcehre, Dzmitry Bahdanau, Fethi Bougares, Holger Schwenk, and Yoshua Bengio. 2014. Learning phrase representations using rnn encoder-decoder for statistical machine translation. *arXiv preprint arXiv:1406.1078*.
- Jacob Devlin, Ming-Wei Chang, Kenton Lee, and Kristina Toutanova. 2018. Bert: Pre-training of deep bidirectional transformers for language understanding. *arXiv preprint arXiv:1810.04805*.
- Alexey Dosovitskiy, Lucas Beyer, Alexander Kolesnikov, Dirk Weissenborn, Xiaohua Zhai, Thomas Unterthiner, Mostafa Dehghani, Matthias Minderer, Georg Heigold, Sylvain Gelly, et al. 2020. An image is worth 16x16 words: Transformers for image recognition at scale. *arXiv preprint arXiv:2010.11929*.
- Huifeng Guo, Ruiming Tang, Yunming Ye, Zhenguo Li, and Xiuqiang He. 2017. Deepfm: a factorization-machine based neural network for ctr prediction. *arXiv preprint arXiv:1703.04247*.
- Linmei Hu, Siyong Xu, Chen Li, Cheng Yang, Chuan Shi, Nan Duan, Xing Xie, and Ming Zhou. 2020. Graph neural news recommendation with unsupervised preference disentanglement. In *Proceedings of the 58th annual meeting of the association for computational linguistics*, pages 4255–4264.
- Diederik P Kingma and Jimmy Ba. 2014. Adam: A method for stochastic optimization. *arXiv preprint arXiv:1412.6980*.
- Talia Lavie, Michal Sela, Ilit Oppenheim, Ohad Inbar, and Joachim Meyer. 2010. User attitudes towards news content personalization. *International journal of human-computer studies*, 68(8):483–495.
- Juncheng Li, Xin Wang, Siliang Tang, Haizhou Shi, Fei Wu, Yueting Zhuang, and William Yang Wang. 2020. Unsupervised reinforcement learning of transferable meta-skills for embodied navigation. In *Proceedings of the IEEE/CVF Conference on Computer Vision and Pattern Recognition*, pages 12123–12132.
- Lei Li, Li Zheng, Fan Yang, and Tao Li. 2014. Modeling and broadening temporal user interest in personalized news recommendation. *Expert Systems with Applications*, 41(7):3168–3177.
- Jianxun Lian, Fuzheng Zhang, Xing Xie, and Guangzhong Sun. 2018. Towards better representation learning for personalized news recommendation: a multi-channel deep fusion approach. In *IJCAI*, pages 3805–3811.
- Jiasen Lu, Dhruv Batra, Devi Parikh, and Stefan Lee. 2019. Vilbert: Pretraining task-agnostic visiolinguistic representations for vision-and-language tasks. *Advances in neural information processing systems*, 32.
- Shumpei Okura, Yukihiro Tagami, Shingo Ono, and Akira Tajima. 2017. Embedding-based news recommendation for millions of users. In *Proceedings of the 23rd ACM SIGKDD international conference on knowledge discovery and data mining*, pages 1933–1942.
- Gabrina Pounds. 2012. Multimodal expression of authorial affect in a british television news programme. *Discourse, Context & Media*, 1(2-3):68–81.
- Alec Radford, Jong Wook Kim, Chris Hallacy, Aditya Ramesh, Gabriel Goh, Sandhini Agarwal, Girish Sastry, Amanda Askell, Pamela Mishkin, Jack Clark, et al. 2021. Learning transferable visual models from natural language supervision. In *International Conference on Machine Learning*, pages 8748–8763. PMLR.
- Shaoqing Ren, Kaiming He, Ross Girshick, and Jian Sun. 2015. Faster r-cnn: Towards real-time object detection with region proposal networks. *Advances in neural information processing systems*, 28.
- Nitish Srivastava, Geoffrey Hinton, Alex Krizhevsky, Ilya Sutskever, and Ruslan Salakhutdinov. 2014. Dropout: a simple way to prevent neural networks from overfitting. *The journal of machine learning research*, 15(1):1929–1958.
- Ashish Vaswani, Noam Shazeer, Niki Parmar, Jakob Uszkoreit, Llion Jones, Aidan N Gomez, Łukasz Kaiser, and Illia Polosukhin. 2017. Attention is all you need. *Advances in neural information processing systems*, 30.
- Heyuan Wang, Fangzhao Wu, Zheng Liu, and Xing Xie. 2020. Fine-grained interest matching for neural news recommendation. In *Proceedings of the 58th Annual Meeting of the Association for Computational Linguistics*, pages 836–845.

- Hongwei Wang, Fuzheng Zhang, Xing Xie, and Minyi Guo. 2018. Dkn: Deep knowledge-aware network for news recommendation. In *Proceedings of the 2018 world wide web conference*, pages 1835–1844.
- Chuhan Wu, Fangzhao Wu, Mingxiao An, Jianqiang Huang, Yongfeng Huang, and Xing Xie. 2019a. Neural news recommendation with attentive multi-view learning. *arXiv preprint arXiv:1907.05576*.
- Chuhan Wu, Fangzhao Wu, Mingxiao An, Jianqiang Huang, Yongfeng Huang, and Xing Xie. 2019b. Npa: neural news recommendation with personalized attention. In *Proceedings of the 25th ACM SIGKDD international conference on knowledge discovery & data mining*, pages 2576–2584.
- Chuhan Wu, Fangzhao Wu, Suyu Ge, Tao Qi, Yongfeng Huang, and Xing Xie. 2019c. Neural news recommendation with multi-head self-attention. In *Proceedings of the 2019 Conference on Empirical Methods in Natural Language Processing and the 9th International Joint Conference on Natural Language Processing (EMNLP-IJCNLP)*, pages 6389–6394.
- Chuhan Wu, Fangzhao Wu, Tao Qi, and Yongfeng Huang. 2021a. Mm-rec: Multimodal news recommendation. *arXiv preprint arXiv:2104.07407*.
- Chuhan Wu, Fangzhao Wu, Tao Qi, Yongfeng Huang, and Xing Xie. 2021b. Fastformer: Additive attention can be all you need. *arXiv preprint arXiv:2108.09084*.
- Fangzhao Wu, Ying Qiao, Jiun-Hung Chen, Chuhan Wu, Tao Qi, Jianxun Lian, Danyang Liu, Xing Xie, Jianfeng Gao, Winnie Wu, et al. 2020. Mind: A large-scale dataset for news recommendation. In *Proceedings of the 58th Annual Meeting of the Association for Computational Linguistics*, pages 3597–3606.
- Jiahao Xun, Shengyu Zhang, Zhou Zhao, Jieming Zhu, Qi Zhang, Jingjie Li, Xiuqiang He, Xiaofei He, Tat-Seng Chua, and Fei Wu. 2021. Why do we click: Visual impression-aware news recommendation. In *Proceedings of the 29th ACM International Conference on Multimedia*, pages 3881–3890.
- Shengyu Zhang, Tan Jiang, Tan Wang, Kun Kuang, Zhou Zhao, Jianke Zhu, Jin Yu, Hongxia Yang, and Fei Wu. 2020. Devlbert: Learning deconfounded visio-linguistic representations. In *Proceedings of the 28th ACM International Conference on Multimedia*, pages 4373–4382.
- Guanjie Zheng, Fuzheng Zhang, Zihan Zheng, Yang Xiang, Nicholas Jing Yuan, Xing Xie, and Zhenhui Li. 2018. Drn: A deep reinforcement learning framework for news recommendation. In *Proceedings of the 2018 World Wide Web Conference*, pages 167–176.
- Qiannan Zhu, Xiaofei Zhou, Zeliang Song, Jianlong Tan, and Li Guo. 2019. Dan: Deep attention neural network for news recommendation. In *Proceedings of the AAAI Conference on Artificial Intelligence*, volume 33, pages 5973–5980.