

Exploring Semantic Attributes from A Foundation Model for Federated Learning of Disjoint Label Spaces

Shitong Sun

Chenyang Si

Guile Wu

Shaogang Gong

shitong.sun@qmul.ac.uk

chenyang.si.mail@gmail.com

guile.wu@outlook.com

s.gong@qmul.ac.uk

ABSTRACT

Conventional centralised deep learning paradigms are not feasible when data from different sources cannot be shared due to data privacy or transmission limitation. To resolve this problem, federated learning has been introduced to transfer knowledge across multiple sources (clients) with non-shared data while optimising a globally generalised central model (server). Existing federated learning paradigms mostly focus on transferring holistic high-level knowledge (such as class) across models, which is closely related to specific objects of interest so may suffer from inverse attack. In contrast, in this work, we consider transferring mid-level semantic knowledge (such as attribute) which is not sensitive to specific objects of interest and therefore is more privacy-preserving and general. To this end, we formulate a new Federated Zero-Shot Learning (FZSL) paradigm to learn mid-level semantic knowledge at multiple local clients with non-shared local data and cumulatively aggregate a globally generalised central model for deployment. To improve model discriminative ability, we explore semantic knowledge available from either a language or a vision-language foundation model in order to enrich the mid-level semantic space in FZSL. Extensive experiments on five zero-shot learning benchmark datasets validate the effectiveness of our approach for optimising a generalisable federated learning model with mid-level semantic knowledge transfer.

CCS CONCEPTS

• **Computing methodologies** → **Distributed algorithms.**

KEYWORDS

federated learning, semantic knowledge transfer, zero-shot learning

1 INTRODUCTION

Deep learning has gained great success in computer vision and natural language processing, but conventional deep learning paradigms mostly follow a centralised learning manner where data from different sources are collected to create a central database for model learning. With an increasing awareness of data privacy, decentralised deep learning [24, 36] is more desirable. To this end, federated learning [19, 24] has been recently introduced to optimise local models (clients) with non-shared local data while learning a global generalised central model (server) by transferring knowledge across the clients and the server. This enables to protect data

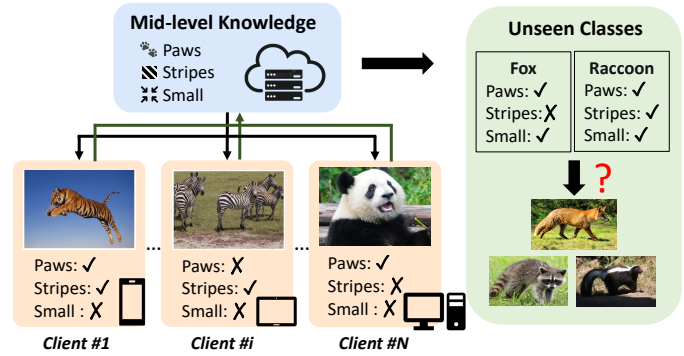

Figure 1: An overview of federated zero-shot learning with mid-level semantic knowledge transfer. Each local client optimises a local model with non-shared local data whilst a central server aggregates a global model by aggregating local model parameters. The server model will further be tested on unseen novel classes.

privacy and reduce transmission cost as local data are only used for training local models and only model parameters are transmitted across the clients and server. There have been a variety of federated learning methods for computer vision applications, such as image classification [2], person reidentification [32] and object detection [22].

However, existing federated learning methods [2, 19, 24, 36] mostly focus on learning holistic high-level knowledge transfer across the clients and the server. Since high-level knowledge is closely related to objects of interest, this may be threatened by privacy inference attacks aiming to reconstruct the raw data [20]. In contrast, mid-level semantic knowledge (such as attribute) is generic containing semantically meaningful properties for visual recognition [16] and not sensitive to objects of interest, so the attacks to reconstruct the sample label space through gradient leakage [10, 44, 45] can be avoided. Besides, since the number of attributes is finite in compositional learning [42] but the number of classes can be infinite, we can represent many classes by the same dictionary of attributes [41], similar to human cognitive abilities [16, 42] and generalisation requirements for the server model in federated learning. Therefore, learning mid-level semantic knowledge transfer for federated learning is not only critical but

also desirable for protecting privacy as well as improving model generalisation.

On the other hand, zero-shot learning (ZSL) is a well-established paradigm for learning mid-level knowledge. It aims to learn mid-level semantic mapping between image features and text labels (typically attributes) using seen object categories and then transfer knowledge for recognising unseen object categories with the help of the composition of shared attributes between seen and unseen categories. However, existing ZSL methods [3, 4, 27] mostly consider centralised learning scenarios which require to share training data from different label spaces to a central data collection. Thus, learning mid-level knowledge in ZSL under a decentralised learning paradigm remains an open question.

In this work, we formulate a new Federated Zero-Shot Learning (FZSL) paradigm, which aims to learn mid-level semantic knowledge in federated learning for zero-shot learning in a decentralised learning manner. An overview of FZSL is depicted in Fig. 1. Specifically, we consider there are multiple local clients where each client has an independent non-overlapping class label space whilst all clients share a common mid-level attribute space. This is an extremely non-IID data partition with a high degree of label distribution skewness and mean Kolmogorov-Smirnov value of one [28]. Then, we optimise local models (clients) with non-shared local data and learn a central generalised model (server) by transferring knowledges (model parameters) between the clients and the server. Further, the server model is tested on unseen novel classes utilising the learned mid-level knowledge. With this paradigm, we innovatively learn mid-level semantic knowledge in a decentralised learning manner with data privacy protection by bridging federated learning and zero-shot learning. It cumulatively optimises a generic mid-level attribute space from non-sharable distributed local data of different object categories. Instead of aggregating holistic models like traditional federated learning [24] or separating domain-specific classifiers like recent decentralized learning [35, 36], we only aggregate generators across the clients and the server while discriminators are retained locally. This facilitates to learn more generalised knowledge and reduce the number of model parameters for communicating. Furthermore, to improve model discriminative ability, we utilise external knowledge by employing off-the-shelf foundation model (language model (e.g., RoBERTa [23]) or text encoder of vision-language model (e.g., CLIP [29])) to explore semantic knowledge augmentation to enrich the mid-level semantic space in FZSL. The text encoder is frozen in local clients and decoupled from the client-server aggregation process. With the help of the pre-trained text encoder supplying richer knowledge space, this semantic knowledge augmentation allows to learn a more generic knowledge to encode sample diversity as well as model scalability.

Our **contributions** are: (1) We propose to exploit mid-level semantic knowledge transfer for federated learning from independent non-overlapping class label spaces and introduce a new Federated Zero-Shot Learning paradigm. (2) We formulate a baseline model, from which we further explore semantic knowledge augmentation by using either a language or a vision-language foundation model as external knowledge to learn a richer mid-level semantic space in FZSL; (3) We conduct extensive experiments on five zero-shot learning benchmark datasets to demonstrate the capacity of our

approach in learning a generalised federated learning model with mid-level semantic knowledge transfer.

2 RELATED WORK

2.1 Federated Learning

Federated learning [18, 19, 24] is a recently introduced model learning paradigm aiming to learn a central model (server) with the collaboration of multiple local models (clients) under data privacy protection. It has been explored in many computer vision tasks, such as medical image segmentation [21], person reidentification [36], object detection [22], etc. Conventional federated learning approaches, e.g., FedAvg [24], learn a sharable central model by aggregating holistic model parameters among different local models. To disentangle generic and specific knowledge, recent approaches [32, 35, 37, 43] propose to optimise generic feature extractors or generators by decoupling discriminators or domain-specific classifiers, but are still learning holistic class-level knowledge. Different from existing works, we propose to learn mid-level semantic knowledge (i.e., attributes) for federated zero-shot learning.

Although there have been several seemingly related federated zero-shot learning studies [5, 11, 14, 43], they mostly use a different definition and setting of *zero-shot* and none of these methods are aimed at bridging the gap between seen and unseen classes by learning mid-level semantic knowledge. ZSDG [14] implements zero-shot augmentation to generate existing categories and study a sharing class space. FedZKT [43] and Gudur et al. [11] are based on zero-shot knowledge distillation [25] with the purpose of transferring knowledge between clients and server without additional datasets. While our work is based on traditional zero shot learning task aimed to learn transferrable *mid-level* semantic attributes. Further, our FZSL is generalisable on *unseen* classes, while FedZKT and ZSDG are only tested on seen classes; our FZSL is learning from multiple independent *non-overlapping* class label spaces, while ZSDG [14] and Gudur et al. [11] are studying a sharing class space. Among all, FedZSL [5] is the most similar to us, but it is based on class-level knowledge like other methods [11, 14, 43] while our FZSL learns to transfer mid-level semantic knowledge.

2.2 Zero Shot Learning

Zero shot learning (ZSL) aims to recognise unseen object categories leveraging seen categories for learning consistent semantic information to bridge seen and unseen categories. Current ZSL methods can broadly be divided into embedding based methods [9] and generative based methods [39]. Embedding based methods transfer from a visual space to a semantic space and classify unseen categories based on semantic similarity without any training data. In contrast, generative based methods learn a projection from a semantic space to a visual space, which enables to turn the zero shot learning task to a pseudo feature supervised learning task, alleviating overfitting [39]. Existing ZSL methods are following a centralised learning manner, while our work proposes a new federated zero-shot learning paradigm to transfer mid-level knowledge across different non-overlapping class label spaces with data privacy protection.

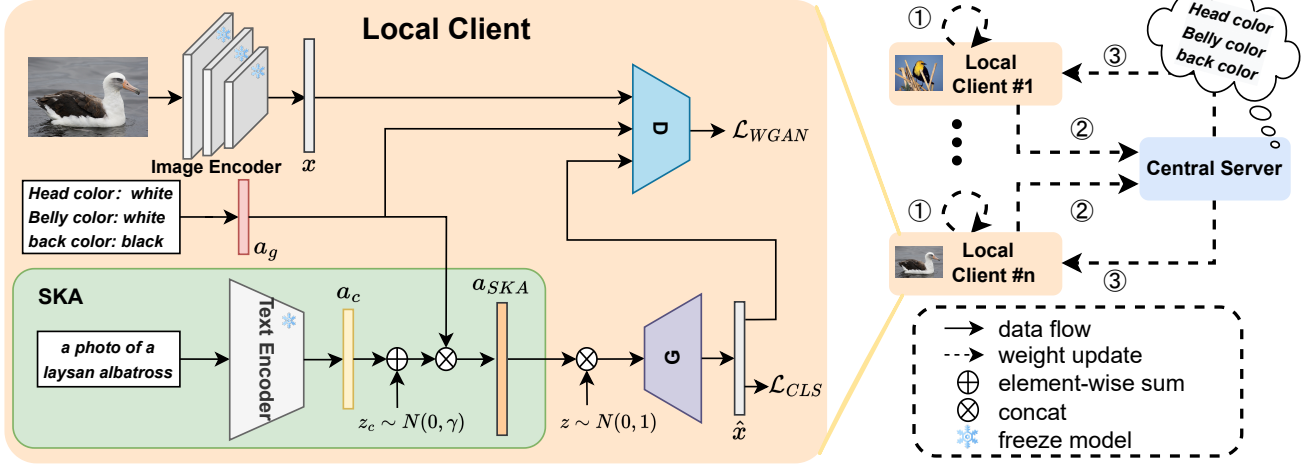

Figure 2: An overview of federated zero-shot learning with mid-level semantic knowledge transfer. (1) Local model training process. (2) Local clients upload model parameters to the server and the server constructs a global model by aggregating local model parameters. (3) Local models are reinitialized with the central server model. The Semantic Knowledge Augmentation (SKA) employs external knowledge to further improve the model’s discriminative ability.

2.3 Foundation Models

Foundation models refer to models trained with a vast quantity of data and can be further used for various downstream tasks, such as BERT [7], RoBERTa [23], CLIP [29], etc. These models are usually learned by self-learning using unlabelled data and can predict underlying properties such as attributes, so they are scalable and potentially more useful than models trained on a limited label space [1]. A concurrent work, PromptFL [13], has recently adapted a foundation model in federated learning to explore the potential representational power of the pretrained richer knowledge. However, it adapts the whole vision-language model (both image and text encoder) for model learning and focuses on general image classification. Critically, the image encoder of the foundation models cannot be used directly in zero shot learning image classification [16]. This is because that the ZSL hypothesis of disjoint training and test class labels [16, 38] is not guaranteed in vision-language foundation models. To overcome this problem, we employ either a language model or a text encoder of a vision-language foundation model to augment *only* the mid-level semantic space in FZSL. And we use the ImageNet as pretrain dataset and ensure non-overlapping of training and test classes by [38].

3 METHODOLOGY

3.1 Problem Definition

In this work, we study Federated Zero-Shot Learning (FZSL), where each client contains an independent non-overlapping class label space with non-shared local data while a central model is aggregated for deployment. Suppose there are N local clients, where the i -th client contains a training set $\mathcal{S}_i = \{x, y\}$, here $y \in \mathcal{Y}_i$ includes N_i classes. Since each client contains non-overlapping class space, i.e., $\mathcal{Y}_i \cap \mathcal{Y}_j = \emptyset, \forall i, j$, $\mathcal{Y}_1 \cup \mathcal{Y}_2 \cup \dots \cup \mathcal{Y}_N = \mathcal{Y}_s$. Meanwhile, each class can be described by an attribute vector $\mathbf{a} = \{a_1, a_2, \dots, a_m\}$ and these

m attributes are consistent among classes in all clients, i.e. the mid-level attribute space is shared across clients. The goal of federated zero shot learning task is to construct a classifier $F: \mathcal{X} \rightarrow \mathcal{Y}$ for $\mathcal{Y}_u \subset \mathcal{Y}$, where \mathcal{Y}_u is the unseen set and $\{\mathcal{Y}_i \cap \mathcal{Y}_u = \emptyset, \forall i, j\}$.

3.2 Mid-Level Semantic Knowledge Transfer

To learn mid-level semantic knowledge transfer for federated learning, we formulate a baseline model which unifies federated learning and zero-shot learning in a decentralised learning paradigm. Since generative based zero-shot learning is capable of generating pseudo image features according to a consistent and generic mid-level attribute space, in this work, we employ a representative ZSL method, i.e., f-CLSWGAN [39], as the backbone. As shown in Fig. 2, the learning process consists of three iterative steps, namely local model learning, central model aggregation and local model reinitialisation with the central model.

In each local client, with the non-shared local data $\mathcal{S}_i = \{x, y\}$, the model learning process follows f-CLSWGAN [39]. A generator $G(z, \mathbf{a}_g)$ learns to generate a CNN feature \hat{x} in the input feature space \mathcal{X} from random noise z and a ground truth condition \mathbf{a}_g , where each value in \mathbf{a}_g corresponds with one specific attribute, e.g. stripes. While a discriminator $D(x, \mathbf{a}_g)$ takes a pair of input features x and a ground truth condition \mathbf{a}_g as input and a real value as output. Thus, the training objective of each local client model is defined as:

$$\min_G \max_D \mathcal{L}_{WGAN} + \beta \mathcal{L}_{CLS}, \quad (1)$$

where β is a hyper-parameter weight on the classifier, \mathcal{L}_{WGAN} is wasserstein GAN loss [12, 39] and \mathcal{L}_{CLS} is cross-entropy loss to classify generated CNN feature \hat{x} to corresponding class label y .

After optimising each local client model for E local epochs, the local model parameters w_i are transmitted to a central server to aggregate a global model. Following FedAvg [24], the aggregating

process is formulated as:

$$\mathbf{w}_t = \frac{1}{N \cdot S} \sum_{i \in N_S} \mathbf{w}_{i,t}, \quad (2)$$

where N denotes the number of local clients and t denotes the t -th global model iterative update round. S denotes the randomly selected clients fraction for each round ($S \in [0.0, 1.0]$) and N_S is the set of selected clients. Note that the central server only aggregates local model parameters without accessing local data so as to protect local data privacy. Then, each local model is reinitialised with the central model as:

$$\mathbf{w}_{i,t+1} = \mathbf{w}_t. \quad (3)$$

This is an iterative learning process (Eqs.(1)-(3)) until T global model update round. Since the attribute space is consistent among local clients, the learned global generator encodes mid-level semantic knowledge, i.e., given attribute vector \mathbf{a} of a class, the generator can generate pseudo CNN features for this class regardless of whether it has been seen or not. Finally in the testing stage, based on the attributes from unseen classes, the learned generator from the global server is used to generate M pseudo image features for each unseen classes \mathcal{Y}_{un} . A softmax classifier is then trained under the supervision from pseudo features and tested for image classification on unseen classes.

Selective Module Aggregation. Although aggregating holistic model parameters following FedAvg [24] is simple, it is inefficient for FZSL because the generic mid-level semantic knowledge is mainly encoded in the generator while the discriminator may contain knowledge specific to classes in each client. Inspired by recent approaches [35, 43] in federated learning, we improve the baseline by decoupling the discriminator from the central model aggregation process, i.e., only aggregating the generator in the central server. This not only reduces the cost for transmitting model parameters but also facilitates to learn more generalisable mid-level knowledge. Thus, the central aggregation in Eq. (2) and the local client reinitialisation in Eq. (3) are reformulated as:

$$\mathbf{w}_{G,t} = \frac{1}{N \cdot S} \sum_{i \in N_S} \mathbf{w}_{G_i,t}, \quad (4)$$

$$\mathbf{w}_{G_i,t+1} = \mathbf{w}_{G,t}, \quad \mathbf{w}_{D_i,t+1} = \mathbf{w}_{D_i,t}, \quad (5)$$

where $\mathbf{w}_{G,t}$ and $\mathbf{w}_{D,t}$ denote model parameters for a generator and a discriminator, respectively.

Discussion. Note, we only aggregate the generator and decouple the discriminator in the selective module aggregation, which slightly differs from the process in [24, 35, 43]. Although selective module aggregation is not a significant contribution of this work, our experimental results show that the improved strategy outperforms the baseline. Thus, we use this useful strategy to improve a baseline model to facilitate the proposed mid-level semantic knowledge transfer for FZSL.

3.3 Semantic Knowledge Augmentation

Although the formulated baseline with selective module aggregation is able to transfer mid-level generic knowledge in a decentralized learning manner, it still suffers from sparse attribute and ambiguous attribute separability for limited data diversity in each

client. To resolve this problem, we propose to explore a foundation model (language model (LM) RoBERTa [23] or text encoder of vision-language model (VLM) CLIP [29] in this work) to explore semantic knowledge augmentation (SKA) to enrich the mid-level semantic space in FZSL. Note we utilise off-the-shelf frozen text encoders directly which is disentangled from client-server aggregation process for efficient communication. Since a foundation model contains word embedding knowledge that can supply information regarding hierarchical relationships among classes, it can help FZSL to learn richer external knowledge with the sharable common attribute space. In this work, we introduce class-level semantic knowledge augmentation, which greatly facilitates the generated feature diversification in both training and testing stages. Empirically, we observe that directly concatenating a noise-enhanced text embedding and an attribute vector is an effective way, which do not require extra learnable parameters and can alleviate overfitting on seen classes.

In our semantic knowledge augmentation, as shown in Fig. 2, we simply combine a default prompt ‘a photo of a’ with class names and use this sentence as the input to the text encoder. We then further add the gaussian noise $z_c \sim N(0, \gamma)$ to the output text embedding \mathbf{a}_c so as to enrich the semantic space and to better align with the instance-wise diversified visual space, where each class-level semantic can always correspond to different samples with various poses and appearances in visual space. The semantic augmented attribute is the concatenation between noise-enhanced text embedding and ground truth manual annotation attribute labels \mathbf{a}_g . This semantic augmentation process is formulated as:

$$\mathbf{a}_{SKA} = [\mathbf{a}_c \oplus z_c, \mathbf{a}_g], \quad (6)$$

where \oplus is the element-wise summation.

During FZSL model training, the text embedding of seen class name is utilised as external knowledge to construct semantic knowledge augmented attribute \mathbf{a}_{SKA} and further generate image features in each local client. The discriminator condition keeps \mathbf{a}_g to distinguish between the real distribution and the pseudo distribution. In the testing stage, instead of generating pseudo image features based on the same attribute \mathbf{a}_g for each class as in conventional ZSL [4, 39, 40], the SKA module supplies diversified attribute \mathbf{a}_{SKA} for each class. The gaussian noise z_c in \mathbf{a}_{SKA} can help explore the rich information in foundation model text encoder so to enrich the attribute space. Overall, our semantic knowledge augmentation can increase inter-class separability and supply diversified attribute space by only using text information of the class name.

Discussion. In this work, we consider a text encoder of a foundation model as a generic off-the-shelf model trained with a vast quantity of data. When using a text encoder of a vision-language foundation model (e.g., CLIP [29]), the text encoder has been trained with both texts and images so the model is exposed to plausibly similar images in training with the potential for zero-shot learning. However, since we only use the text encoder (not the whole vision-language model as PromptFL [13]) and the foundation model is defined as a generic off-the-shelf model, the text encoder can be used in our approach to explore semantic knowledge augmentation to enrich mid-level semantic space in FZSL. Besides, our approach can also be configured with a language model (e.g., RoBERTa [23]), which has not been trained with any images, to explore semantic

	Method	AWA2	AWA1	aPY	CUB	SUN
<i>Centralised</i>	VAEGAN [40]	61.4	55.9	18.6	44.8	56.9
	CLSWGAN [39]	67.4	66.6	37.7	56.8	60.3
	FREE [4]	67.7	68.9	42.2	60.9	61.3
<i>Decentralised</i>	CLSWGAN+FedAvg [24]	61.6	58.5	33.8	53.8	59.5
	CLSWGAN+FedProx [18]	61.3	58.4	34.0	53.1	59.3
	CLSWGAN+MOON [17]	61.0	58.6	33.2	<u>55.1</u>	59.5
	FL-VAEGAN [40]	60.2	51.6	18.7	43.2	55.5
	FL-FREE [4]	60.9	59.8	25.9	54.5	56.4
	Ours (LM)	<u>65.4</u>	<u>64.6</u>	<u>41.6</u>	54.8	<u>61.1</u>
	Ours (VLM)	69.0	70.6	47.1	59.4	66.5

Table 1: Comparison with the related methods on AWA2, AWA1, aPY, CUB and SUN (Top-1 accuracy). SKA(LM) and SKA(VLM) denote semantic knowledge augmentation with text encoder from language model and vision-language model respectively. Bold and underline are the best and the second best results. Note that centralised methods are used for reference only because they are not direct counterparts.

knowledge augmentation for FZSL. Overall, with the improved baseline and semantic knowledge augmentation, our approach is capable of learning mid-level knowledge to facilitate FZSL. Since training data are non-shared and mid-level knowledge only contains semantic properties insensitive to objects of interests, our approach inherently protects privacy.

4 EXPERIMENTS

Datasets. To evaluate the effectiveness of our approach, we conduct extensive experiments on five zero-shot benchmark datasets, including three coarse-grained datasets: (Animals with Attributes (AWA1) [16], Animals with Attributes 2 (AWA2) [38] and Attribute Pascal and Yahoo (aPY) [8]); and two fine-grained datasets (Caltech-UCSD-Birds 200-2011 (CUB) [34] and SUN Attribute (SUN) [26]). AWA1 is a coarse-grained dataset with 30475 images, 50 classes and 85 attributes, while AWA2 shares the same number of classes and attributes as AWA1 but with 37322 images in total. The aPY dataset is a relatively small coarse-grained dataset with 15339 images, 32 classes and 64 attributes. CUB contains 11788 images from 200 different types of birds annotated with 312 attributes, while SUN contains 14340 images from 717 scenes annotated with 102 attributes. We use the zero-shot splits proposed by [38] for AWA1, AWA2, aPY, CUB and SUN ensuring that none of training classes are present in ImageNet [30]. All these five datasets are composed of seen classes set and unseen classes set. In decentralised learning experiments, we evenly split the seen classes set randomly to four clients. Note, both seen classes and unseen classes share the same attribute space in each dataset.

Evaluation Metrics. In FZSL, the goal is to learn a generalisable server model which can assign unseen class label \mathcal{Y}_u to test images. Following commonly used zero-shot learning evaluation protocol [38], the accuracy of each unseen class is calculated independently before divided by the total unseen class number, i.e., calculating the average per-class top-1 accuracy of the unseen classes. **Implementation Details.** Following [4, 39, 40], in our approach, we employed a frozen ResNet-101 [15] pretrained on ImageNet [30] as the CNN feature extractor and constructed our baseline model with a generator and a discriminator for each client respectively following the representative zero-shot learning work [39]. Both

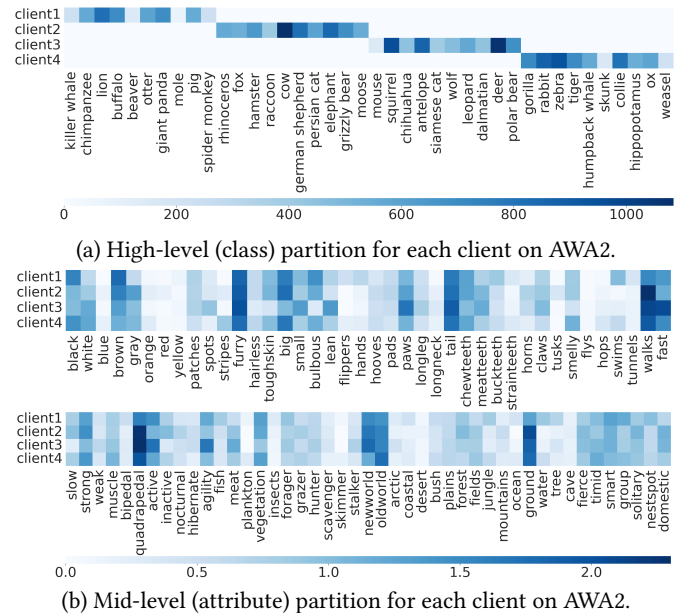

Figure 3: High-level vs mid-level partition for each client on AWA2. The depth of color represents the number of samples for each class in (a) and the sum of each continuous attributes [38] for all classes in each client in (b).

generator and discriminator have a simple architecture consisting of only two MLP layers. Further, we employed a frozen pretrained text encoder (base RoBERTa [23] in SKA (LM) and text encoder of ViT-Base/16 CLIP [29] in SKA (VLM)) to supply class-name-based text embedding for each client. All clients share the same model structure while the server aggregates local model parameters to construct a global model. As for further improvement with semantic knowledge augmentation (SKA), the frozen text encoder is kept locally and not aggregated to the server. By default, we set the number of local clients $N=4$, random client selection fraction $S=1$ and noise augmentation γ to 0.1. Generated feature number M and

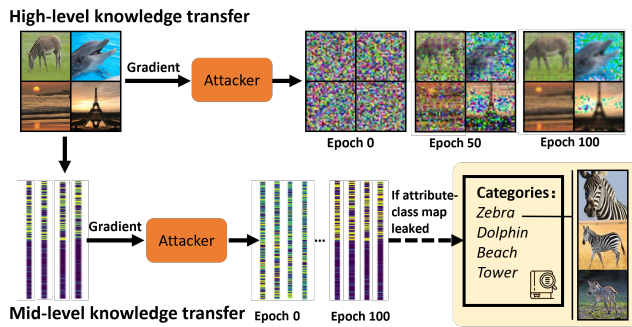

Figure 4: The gradient leakage attack on high-level and mid-level knowledge transfer.

classifier weight β follows [39]. We empirically set batch size to 64, maximum global iterations rounds $T=100$, maximum local epochs $E=1$. For each local client, we used Adam optimizer with a learning rate of $1e-3$ for CUB, $2e-4$ for SUN and $1e-5$ for the others. Our models were implemented with Python(3.6) and PyTorch(1.7) and trained on NVIDIA A100 GPUs.

4.1 Federated Zero-Shot Learning Analysis

There are no existing works discussing mid-level semantic knowledge transfer in federated learning, so besides our baseline model (CLSWGAN [39] with FedAvg [24]), we implement (1) a traditional ZSL method VAEGAN [40] and a recent ZSL method FREE [4] with FedAvg denoted as FL-VAEGAN and FL-FREE respectively, and (2) CLSWGAN with two other federated learning paradigms, namely FedProx [18] and MOON [17]. All compared methods are inductive where only attribute information of unseen classes are used for training the classifier and unseen images are not used during training.

From Table 1, we can see that: (1) Compared with the centralised method (CLSWGAN), the decentralised baseline (CLSWGAN+FedAvg) yields compelling performance, showing the effectiveness of the proposed paradigm for learning globally generalised model whilst protecting local data privacy. This can be attributed to the learnt generator which can effectively extract mid-level semantic knowledge in either decentralised settings with disjoint class label spaces or centralised settings. This observation brings inspiration to federated learning with non-IID data and proves that semantic mid-level information (attributes in particular) can be the consistent and generalisable knowledge extracted from heterogeneous clients so to boost all the participants. (2) Our approach significantly improves the baseline by 9% with SKA(VLM) and by 4% with SKA(LM) on average, which validates the effectiveness of our approach for FZSL. This can be attributed to the text encoder of foundation models which can supply rich semantic space and increase the diversity of generated pseudo samples to a large degree, which can further promote the generalisability of the model. (3) Comparing with other FL approaches (FedProx and MOON) and ZSL approaches (FL-VAEGAN and FL-FREE), our approach achieves significantly better performance on average, showing the adaptation of our method in learning mid-level semantic knowledge in federated learning.

4.2 High-Level vs. Mid-Level Knowledge Transfer

Privacy Protection. To verify the effectiveness of privacy protection from transferring mid-level knowledge by attributes, we performed the gradient leakage attack [45] on federated learning with high-level knowledge transfer and our mid-level knowledge transfer. As shown in Fig. 4, the source images used in high-level knowledge transfer are recovered by the attack, which cause privacy leakage. In contrast, in our mid-level knowledge transfer, only attribute vector can be recovered, which is a continuous embedding [38] in our case and only leak less sensitive information. In extreme cases, even if the attribute-label mapping is further leaked to the attacker, the attacker can only know the corresponding categories (class-level) with millions of possibilities but not the exact object raw images (instance-level). This demonstrates high privacy security and robustness against attacks in our paradigm.

Model Generalisation. To supply a qualitatively analysis of model generalisation from transferring mid-level knowledge by attributes, we visualise data partitions for FZSL on both high-level (class) and mid-level (attribute). In the perspective of high-level (class) partition as shown in Fig. 3 (a), each client contains non-overlapping class label space which results to high degree of class label distribution skewness. Qu et al. [28] reported a notable performance decrease(76.25% on ResNet50) when comparing this extremely heterogeneous partition with IID data partition. However, in the perspective of mid-level (attribute) partition as shown in Fig. 3 (b), it shows an overlapping attribute space and results to a lower degree of attribute label distribution skewness. Experiment results on Table. 1 and Table. 4 prove the generalisability of transferring mid-level knowledge to unseen classes.

4.3 Local Training vs. Decentralised Learning

To verify the effectiveness of the formulated federated zero-shot learning paradigm, we separately train four individual local models with local client data and compare with decentralised learning models. For a clearer comparison, we further test the model in centralised learning with and without our proposed SKA. The performance are tested on the same unseen classes for all compared methods. As shown in Table 4, the decentralised baseline significantly outperforms all individual client models. This shows that the federated collaboration between the localised clients and the central server model facilitates to optimise a generalisable model in FZSL. Moreover, the shared mid-level knowledge among clients can be extracted from non-overlapping isolated local data with privacy protection and help boost the discriminative ability for unseen classes. Additionally, we evaluate SKA (VLM) with centralised method, which also shows a significant improvement and proves the effectiveness of proposed SKA in both centralised and decentralised scenario.

4.4 Ablation Study

Component Effectiveness Evaluation. To evaluate the component of our approaches, We further analyse the results both quantitatively and qualitatively. Quantitatively, we report experimental results in Table 2 for the baseline with and without SMA, SKA (LM) and SKA (VLM) respectively. It can be observed from Table 2 that

SMA	SKA	AWA2	AWA1	aPY	CUB	SUN
X	X	61.6	58.5	33.8	53.8	59.5
✓	X	62.8	61.7	38.4	55.5	59.4
X	✓(LM)	65.0	64.2	39.1	54.1	60.6
✓	✓(LM)	65.4	64.6	41.6	54.8	61.1
✓	✓(VLM)	69.0	70.6	47.1	59.4	66.5

Table 2: Baseline with proposed module variations. SMA: selective module aggregation. SKA: semantic augmentation with RoBERTa as language model (LM) and CLIP text encoder as vision-language model (VLM) respectively.

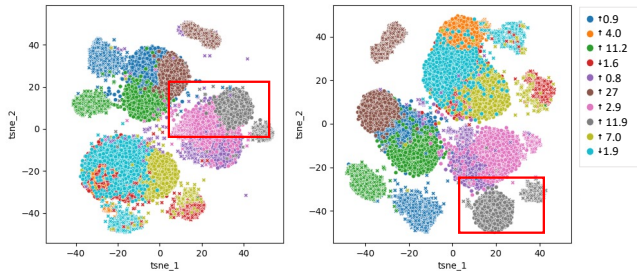

Figure 5: tSNE of unseen classes on AWA2 for baseline+SMA (left) and baseline+SMA+SKA (VLM) (right). The same colour implies the same class. Circle and cross means the generated distribution and real unseen distribution, respectively. The number in the caption means increase or decrease percentage for each class after implementing SKA (VLM). The classifier trained on generated pseudo distribution is tested on the unseen real distribution.

SMA can bring benefits (except baseline on SUN) with and without SKA, which can demonstrate the generality and effectiveness of the SMA module to build an improved baseline for FZSL. Besides, SKA can bring significant improvement in all of the five datasets (except SKA(LM) in CUB), proving that the diversity supplied by SKA can help the global model generalisability. Qualitatively, the tSNE visualisations of AWA2 unseen classes for baseline+SMA before and after implementing the semantic knowledge augmentation with vision-language model are shown in Fig. 5. It can be seen that with SKA (VLM), the generated distribution has a larger inter-class distance as shown in the red box. This larger inter-class distance improves coarse-grained classification accuracy.

Variation of Semantic Knowledge Augmentation. In Table 3, we study more variants of text encoder in semantic knowledge augmentation. Here, BERT [7] is a bidirectional encoder similar to RoBERTa, while DeFILIP [6] is a variation of CLIP. As shown in Table 3, we can see that: (1) Both LM and VLM text encoder can bring benefits comparing with baseline, which shows the effectiveness and generality of the proposed SKA structure. (2) Our approach with VLM achieves better results compared to ours with LM. The reason is mainly that the text encoders in VLM are pretrained with both texts and images so it is easier for these text encoders to achieve the alignment between visual and semantic distribution in FZSL. (3) DeFILIP, a fine-grained variation of CLIP, achieves the

Text Encoder		AWA2	AWA1	aPY	CUB	SUN
X		62.8	61.7	38.4	55.5	59.4
LM	BERT	63.4	63.8	41.1	54.6	60.9
	RoBERTa	65.4	64.6	41.6	54.8	61.1
VLM	DeFILIP	74.1	75.5	49.4	58.2	64.2
	CLIP	69.0	70.6	47.1	59.4	66.5

Table 3: In comparison with Baseline+SMA, evaluation with the text embedding of two pretrained Language Models (LM) and two pretrained Vision-Language Models (VLM) are reported.

Setting	Methods	AWA2	AWA1	aPY	CUB	SUN
Local	Client 1	49.0	47.8	23.2	42.4	50.6
	Client 2	37.1	38.7	22.8	40.5	52.1
	Client 3	40.2	41.1	34.3	40.2	49.8
	Client 4	53.0	51.9	26.3	40.2	50.4
	Average	44.8	44.9	26.7	35.5	50.7
Decentral	Baseline	61.6	58.5	33.8	53.8	59.5
	Ours	69.0	70.6	47.1	59.4	66.5
Centralised		67.4	66.6	37.7	56.8	60.3
Centralised+SKA(VLM)		72.8	70.1	46.5	58.0	64.9

Table 4: Comparing local training and decentralised learning. Baseline denotes CLSWGAN with FedAvg, while ours denotes Baseline+SMA+SKA(VLM).

Features	Methods	AWA2	CUB	SUN
GoogLeNet	Baseline	55.4	45.4	51.1
	Ours(LM)	<u>60.6</u>	<u>46.3</u>	<u>52.4</u>
	Ours(VLM)	65.2	50.9	55.8
MobileNetV2	Baseline	63.0	56.5	57.9
	Ours(LM)	<u>66.3</u>	<u>57.1</u>	<u>58.1</u>
	Ours(VLM)	70.9	61.5	63.8
ResNet101	Baseline	61.6	53.8	59.5
	Ours(LM)	<u>65.4</u>	<u>54.8</u>	<u>61.1</u>
	Ours(VLM)	69.0	59.4	66.5

Table 5: Evaluation with different CNN feature encoders.

best result among different text encoders. Interestingly, we find that DeFILIP with attribute-level SKA (text input: ‘a photo of a {attribute} {class name}.’) can achieve 59.8% and 65.6% on CUB and SUN respectively (cf. 58.2% and 64.2% on CUB and SUN with class-level SKA), which implies that the fine-grained information from DeFILIP can be further explored by feature mining.

Variation of Encoder Architectures. In this work, following [4, 39, 40], we mainly use ResNet101 as the CNN feature encoders. In Table 5, we further report the results of our approach with smaller CNN feature encoders, including GoogLeNet [33] and MobileNetV2 [31]. From Table 5, we can observe that with CNN features extracted from different backbones, our approach can consistently improve the performance of the baseline. This shows that

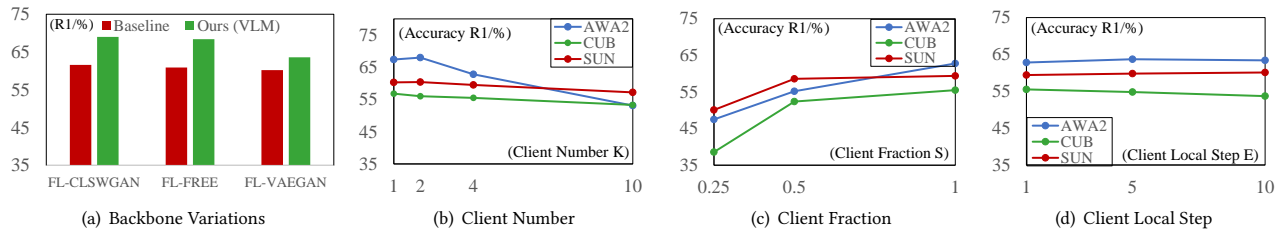

Figure 6: Ablation study on (a) client number, (b) client fraction, (c) local steps, (d) backbone variations.

	Methods	AWA2	AWA1	aPY	CUB	SUN
<i>Evenly</i>	FL-CLSWGAN	61.6	58.5	33.8	53.8	59.5
	Ours (VLM)	69.0	70.6	47.1	59.4	66.5
<i>Unevenly</i>	FL-CLSWGAN	63.0	58.7	35.3	55.8	59.7
	Ours (VLM)	69.3	70.3	46.2	59.4	66.1

Table 6: Comparing baseline and ours (VLM) with both evenly and random unevenly split. FL-CLSWGAN donates CLSWGAN+FedAvg in Table 1.

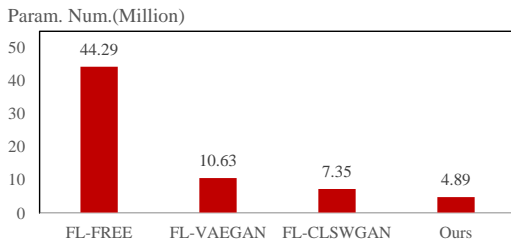

Figure 7: Comparing communication parameters between our method and different backbones.

our method is not limited to ResNet-101 features. It is also applicable to other more compact and smaller network features.

Clients with Uneven Split. We further discuss the influence of data distribution with even or uneven class label split. In this work, we mainly conduct experiments with the evenly split client data distribution, where each client has equally number of non-overlapping class labels. Although even split of class labels for each client is already the extremely non-IID data partition with high degree of label skewness [28], we further test on uneven split non-overlapping class labels. Specifically, the seen class labels are randomly split to 4 clients and ensure that each client has at least one-eighth of the total number of seen classes. For equal comparison, the baseline of FL-CLSWGAN and ours (VLM) are following exactly the same data split partition in both even and uneven setting. From Table. 6, we can observe that: (1) The baseline can achieve comparable performance in both even and uneven split. This demonstrates that the extraction of mid-level knowledge is robust to the change in data distribution; (2) Our model performance is superior to FL-CLSWGAN in both even and uneven splits, further validating the effectiveness and robustness of our method.

Parameters for communication. From Fig. 7, we can see that: (1) Our approach has the least number of parameters used for the iterative federated communication process comparing with FL-FREE, FL-VAEGAN and FL-CLSWGAN (CLSWGAM+FedAvg in Table. 1). (2) This can be attributed to the backbone of our approach CLSWGAN, which is the most lightweight backbone, as well as the SMA that further reduces the communication parameters (3) The frozen text encoder doesn't join the iterative communication process, we can also implement the text encoder by inference API as in promptFL [13], which can further lighten our model. As a result, our approach is suitable for federated learning for its efficient communication.

Backbone Variations. Fig. 6(a) compares FZSL with different backbone variations. We implemented backbones CLSWGAN [39], FREE [4], VAEGAN [40] with FedAvg [24] donated as FL-CLSWGAN, FL-FREE, FL-VAEGAN respectively, and further utilised our method with SKA(VLM) for comparison. We can see that our methods have a clear improvement on all of the three backbones. This validates the effectiveness and generality of our method in FZSL.

4.5 Further Analysis and Discussion

In this section, we conduct the experiments on the improved baseline, namely CLSWGAN+FedAvg+SMA, to evaluate the effect of client number K , client fraction S and client local step E .

Client Number K . Fig. 6(b) compares central server aggregation with different numbers of local clients, where $K=1,2,4$ and 10 clients on average respectively. We can see that the FZSL performance decreases when increasing the number of clients, which implies greater difficulty with larger number of clients with less data variety are used. But the performance degradation tendencies are stable on CUB and SUN, while that on AWA2 is more significant.

Client Fraction S . Fig. 6(c) compares FZSL with different client fractions. We can see that a smaller number of fraction is inferior to collaboration with a larger fraction of clients, which demonstrates that collaboration among multi-clients can further contribute to the generalisation ability of the server model.

Client Local Step E . Fig. 6(d) compares FZSL with different client local steps E which influences the communication efficiency. Overall, the performance on different datasets shows relatively stable trends whilst on SUN, the performance decreases when E increases due to the accumulation of biases in local client.

5 CONCLUSION

In this work, we proposed to exploit mid-level semantic knowledge transfer by attributes for federated learning, from which we introduced a new Federated Zero-Shot Learning paradigm. We formulated a baseline model based on conventional zero-shot learning and federated learning. We further introduced selective module aggregation and foundation model based semantic knowledge augmentation to improve the generalisation capacity of the baseline model. Extensive experiments on five zero-shot learning datasets demonstrated our model's generalisation ability as well as its effectiveness on privacy preserving.

REFERENCES

- [1] Rishi Bommasani, Drew A Hudson, Ehsan Adeli, Russ Altman, Simran Arora, Sydney von Arx, Michael S Bernstein, Jeannette Bohg, Antoine Bosselut, Emma Brunskill, et al. 2021. On the opportunities and risks of foundation models. *arXiv preprint arXiv:2108.07258* (2021).
- [2] Hong-You Chen and Wei-Lun Chao. 2021. On bridging generic and personalized federated learning for image classification. In *International Conference on Learning Representations*.
- [3] Jiaoyan Chen, Yuxia Geng, Zhuo Chen, Ian Horrocks, Jeff Z Pan, and Huajun Chen. 2021. Knowledge-aware zero-shot learning: Survey and perspective. *arXiv preprint arXiv:2103.00070* (2021).
- [4] Shiming Chen, Wenjie Wang, Beihao Xia, Qinmu Peng, Xinge You, Feng Zheng, and Ling Shao. 2021. Free: Feature refinement for generalized zero-shot learning. In *Proceedings of the IEEE/CVF international conference on computer vision*. 122–131.
- [5] Zhi Chen, Yadan Luo, Sen Wang, Jingjing Li, and Zi Huang. 2022. Federated Zero-Shot Learning for Visual Recognition. *arXiv preprint arXiv:2209.01994* (2022).
- [6] Yufeng Cui, Lichen Zhao, Feng Liang, Yangguang Li, and Jing Shao. 2022. Democratizing Contrastive Language-Image Pre-training: A CLIP Benchmark of Data, Model, and Supervision. *arXiv:2203.05796* [cs.CV]
- [7] Jacob Devlin, Ming-Wei Chang, Kenton Lee, and Kristina Toutanova. 2018. Bert: Pre-training of deep bidirectional transformers for language understanding. *arXiv preprint arXiv:1810.04805* (2018).
- [8] Ali Farhadi, Ian Endres, Derek Hoiem, and David Forsyth. 2009. Describing objects by their attributes. In *2009 IEEE conference on computer vision and pattern recognition*. IEEE, 1778–1785.
- [9] Yanwei Fu, Timothy M Hospedales, Tao Xiang, and Shaogang Gong. 2015. Transductive multi-view zero-shot learning. *IEEE transactions on pattern analysis and machine intelligence* 37, 11 (2015), 2332–2345.
- [10] Jonas Geiping, Hartmut Bauermeister, Hannah Dröge, and Michael Moeller. 2020. Inverting gradients-how easy is it to break privacy in federated learning? *Advances in Neural Information Processing Systems* 33 (2020), 16937–16947.
- [11] Gautham Krishna Gudur and Satheesh K Perepu. 2021. Zero-Shot Federated Learning with New Classes for Audio Classification. *arXiv preprint arXiv:2106.10019* (2021).
- [12] Ishaan Gulrajani, Faruk Ahmed, Martin Arjovsky, Vincent Dumoulin, and Aaron C Courville. 2017. Improved training of wasserstein gans. *Advances in neural information processing systems* 30 (2017).
- [13] Tao Guo, Song Guo, Junxiao Wang, and Wenchao Xu. 2022. PromptFL: Let Federated Participants Cooperatively Learn Prompts Instead of Models—Federated Learning in Age of Foundation Model. *arXiv preprint arXiv:2208.11625* (2022).
- [14] Weituo Hao, Mostafa El-Khomy, Jungwon Lee, Jianyi Zhang, Kevin J Liang, Changyou Chen, and Lawrence Carin Duke. 2021. Towards fair federated learning with zero-shot data augmentation. In *Proceedings of the IEEE/CVF Conference on Computer Vision and Pattern Recognition*. 3310–3319.
- [15] Kaiming He, Xiangyu Zhang, Shaoqing Ren, and Jian Sun. 2016. Deep residual learning for image recognition. In *Proceedings of the IEEE Conference on Computer Vision and Pattern Recognition*. 770–778.
- [16] Christoph H Lampert, Hannes Nickisch, and Stefan Harmeling. 2013. Attribute-based classification for zero-shot visual object categorization. *IEEE transactions on pattern analysis and machine intelligence* 36, 3 (2013), 453–465.
- [17] Qinbin Li, Bingsheng He, and Dawn Song. 2021. Model-contrastive federated learning. In *Proceedings of the IEEE/CVF Conference on Computer Vision and Pattern Recognition*. 10713–10722.
- [18] Tian Li, Anit Kumar Sahu, Manzil Zaheer, Maziar Sanjabi, Ameet Talwalkar, and Virginia Smith. 2020. Federated optimization in heterogeneous networks. *Proceedings of Machine Learning and Systems* 2 (2020), 429–450.
- [19] Xiaoxiao Li, Meirui JIANG, Xiaofei Zhang, Michael Kamp, and Qi Dou. 2020. FedBN: Federated Learning on Non-IID Features via Local Batch Normalization. In *International Conference on Learning Representations*.
- [20] Pengrui Liu, Xiangrui Xu, and Wei Wang. 2022. Threats, attacks and defenses to federated learning: issues, taxonomy and perspectives. *Cybersecurity* 5, 1 (2022), 1–19.
- [21] Quande Liu, Cheng Chen, Jing Qin, Qi Dou, and Pheng-Ann Heng. 2021. Feddgc: Federated domain generalization on medical image segmentation via episodic learning in continuous frequency space. In *Proceedings of the IEEE/CVF Conference on Computer Vision and Pattern Recognition*. 1013–1023.
- [22] Yang Liu, Anbu Huang, Yun Luo, He Huang, Youzhi Liu, Yuanyuan Chen, Lican Feng, Tianjian Chen, Han Yu, and Qiang Yang. 2020. Fedvision: An online visual object detection platform powered by federated learning. In *Proceedings of the AAAI Conference on Artificial Intelligence*, Vol. 34. 13172–13179.
- [23] Yinhan Liu, Myle Ott, Naman Goyal, Jingfei Du, Mandar Joshi, Danqi Chen, Omer Levy, Mike Lewis, Luke Zettlemoyer, and Veselin Stoyanov. 2019. Roberta: A robustly optimized bert pretraining approach. *arXiv preprint arXiv:1907.11692* (2019).
- [24] Brendan McMahan, Eider Moore, Daniel Ramage, Seth Hampson, and Blaise Agueria y Arcas. 2017. Communication-efficient learning of deep networks from decentralized data. In *Artificial intelligence and statistics*. PMLR, 1273–1282.
- [25] Gaurav Kumar Nayak, Konda Reddy Mopuri, Vaisakh Shaj, Venkatesh Babu Radhakrishnan, and Anirban Chakraborty. 2019. Zero-shot knowledge distillation in deep networks. In *International Conference on Machine Learning*. PMLR, 4743–4751.
- [26] Genevieve Patterson and James Hays. 2012. Sun attribute database: Discovering, annotating, and recognizing scene attributes. In *2012 IEEE Conference on Computer Vision and Pattern Recognition*. IEEE, 2751–2758.
- [27] Farhad Pourpanah, Moloud Abdar, Yuxuan Luo, Xinlei Zhou, Ran Wang, Chee Peng Lim, and Xi-Zhao Wang. 2020. A review of generalized zero-shot learning methods. *arXiv preprint arXiv:2011.08641* (2020).
- [28] Liangqiong Qu, Yuyin Zhou, Paul Pu Liang, Yingda Xia, Feifei Wang, Ehsan Adeli, Li Fei-Fei, and Daniel Rubin. 2022. Rethinking architecture design for tackling data heterogeneity in federated learning. In *Proceedings of the IEEE/CVF Conference on Computer Vision and Pattern Recognition*. 10061–10071.
- [29] Alec Radford, Jong Wook Kim, Chris Hallacy, Aditya Ramesh, Gabriel Goh, Sandhini Agarwal, Girish Sastry, Amanda Askell, Pamela Mishkin, Jack Clark, et al. 2021. Learning transferable visual models from natural language supervision. In *International Conference on Machine Learning*. PMLR, 8748–8763.
- [30] Olga Russakovsky, Jia Deng, Hao Su, Jonathan Krause, Sanjeev Satheesh, Sean Ma, Zhiheng Huang, Andrej Karpathy, Aditya Khosla, Michael Bernstein, et al. 2015. Imagenet large scale visual recognition challenge. *International journal of computer vision* 115, 3 (2015), 211–252.
- [31] Mark Sandler, Andrew Howard, Menglong Zhu, Andrey Zhmoginov, and Liang-Chieh Chen. 2018. Mobilenetv2: Inverted residuals and linear bottlenecks. In *Proceedings of the IEEE conference on computer vision and pattern recognition*. 4510–4520.
- [32] Shitong Sun, Guile Wu, and Shaogang Gong. 2021. Decentralised Person Re-identification with Selective Knowledge Aggregation. In *British Machine Vision Conference*.
- [33] Christian Szegedy, Wei Liu, Yangqing Jia, Pierre Sermanet, Scott Reed, Dragomir Anguelov, Dumitru Erhan, Vincent Vanhoucke, and Andrew Rabinovich. 2015. Going deeper with convolutions. In *Proceedings of the IEEE conference on computer vision and pattern recognition*. 1–9.
- [34] Catherine Wah, Steve Branson, Peter Welinder, Pietro Perona, and Serge Belongie. 2011. The caltech-ucsd birds-200-2011 dataset. (2011).
- [35] Guile Wu and Shaogang Gong. 2021. Collaborative optimization and aggregation for decentralized domain generalization and adaptation. In *Proceedings of the IEEE/CVF International Conference on Computer Vision*. 6484–6493.
- [36] Guile Wu and Shaogang Gong. 2021. Decentralised learning from independent multi-domain labels for person re-identification. In *Proceedings of the AAAI Conference on Artificial Intelligence*. 2898–2906.
- [37] Yuezhou Wu, Yan Kang, Jiahuan Luo, Yuanqin He, and Qiang Yang. 2021. Fedcg: Leverage conditional gan for protecting privacy and maintaining competitive performance in federated learning. *arXiv preprint arXiv:2111.08211* (2021).
- [38] Yongqin Xian, Christoph H Lampert, Bernt Schiele, and Zeynep Akata. 2018. Zero-shot learning—a comprehensive evaluation of the good, the bad and the ugly. *IEEE transactions on pattern analysis and machine intelligence* 41, 9 (2018), 2251–2265.
- [39] Yongqin Xian, Tobias Lorenz, Bernt Schiele, and Zeynep Akata. 2018. Feature generating networks for zero-shot learning. In *Proceedings of the IEEE conference on computer vision and pattern recognition*. 5542–5551.
- [40] Yongqin Xian, Saurabh Sharma, Bernt Schiele, and Zeynep Akata. 2019. F-vaegand2: A feature generating framework for any-shot learning. In *Proceedings of the IEEE/CVF Conference on Computer Vision and Pattern Recognition*. 10275–10284.
- [41] Alan L Yuille. 2011. Towards a theory of compositional learning and encoding of objects. In *2011 IEEE International Conference on Computer Vision Workshops (ICCV Workshops)*. IEEE, 1448–1455.

- [42] Alan L Yuille and Chenxi Liu. 2021. Deep nets: What have they ever done for vision? *International Journal of Computer Vision* 129, 3 (2021), 781–802.
- [43] Lan Zhang, Dapeng Wu, and Xiaoyong Yuan. 2021. FedZKT: Zero-Shot Knowledge Transfer towards Resource-Constrained Federated Learning with Heterogeneous On-Device Models. *arXiv preprint arXiv:2109.03775* (2021).
- [44] Bo Zhao, Konda Reddy Mopuri, and Hakan Bilen. 2020. idlg: Improved deep leakage from gradients. *arXiv preprint arXiv:2001.02610* (2020).
- [45] Ligeng Zhu, Zhijian Liu, and Song Han. 2019. Deep leakage from gradients. *Advances in neural information processing systems* 32 (2019).