FEDERATED LEARNING OF NEURAL ODE MODELS WITH DIFFERENT ITERATION COUNTS

A PREPRINT

Yuto Hoshino

Keio University

3-14-1 Hiyoshi, Kohoku-ku, Yokohama, Japan

hoshino@arc.ics.keio.ac.jp

Hiroki Kawakami

Keio University

3-14-1 Hiyoshi, Kohoku-ku, Yokohama, Japan

kawakami@arc.ics.keio.ac.jp

Hiroki Matsutani

Keio University

3-14-1 Hiyoshi, Kohoku-ku, Yokohama, Japan

matutani@arc.ics.keio.ac.jp

September 7, 2023

ABSTRACT

Federated learning is a distributed machine learning approach in which clients train models locally with their own data and upload them to a server so that their trained results are shared between them without uploading raw data to the server. There are some challenges in federated learning, such as communication size reduction and client heterogeneity. The former can mitigate the communication overheads, and the latter can allow the clients to choose proper models depending on their available compute resources. To address these challenges, in this paper, we utilize Neural ODE based models for federated learning. The proposed flexible federated learning approach can reduce the communication size while aggregating models with different iteration counts or depths. Our contribution is that we experimentally demonstrate that the proposed federated learning can aggregate models with different iteration counts or depths. It is compared with a different federated learning approach in terms of the accuracy. Furthermore, we show that our approach can reduce communication size by up to 92.4% compared with a baseline ResNet model using CIFAR-10 dataset.

Keywords Federated Learning · Neural networks · Neural ODE

1 Introduction

In traditional cloud-based machine learning systems, sending personal data to cloud servers has become problematic from a privacy perspective. Federated learning [1] is a distributed machine learning approach that can keep privacy-sensitive raw data decentralized. In the federated learning, clients receive a model from the server. Then they train the model with their own data and upload trained parameters to the server. The server aggregates the trained parameters received from the clients and sends back the aggregated parameters to the clients. These steps are repeated until the training process is converged. This eliminates the need to upload privacy-sensitive raw data to the server.

However, there are some challenges in the federated learning, such as communication size reduction and client heterogeneity. Communication size affects communication delay and power consumption of clients. It is affected by the machine learning model size. Regarding the client heterogeneity, not all clients always have the same hardware, compute resources, or training data. A client may use a deeper model for high accuracy, while another client may use a shallower model to reduce the computation cost. In this paper, we exploit Neural ODE [2] as a federated learning model to address these challenges.

For image recognition tasks, one of methods to improve accuracy is increasing the number of convolutional layers to build a deeper neural network. ResNet [3] is one of well-known CNN models that stack many residual blocks that contain convolutional layers and shortcut connections. Neural ODE utilizes a similarity to ODE (Ordinary Differential Equation) to implement deep neural networks consisting of residual blocks. Since it can be approximated to a ResNet model by repeatedly using the same weight parameters, it can reduce the weight parameters. In addition, it can be approximated to ResNet models with different depths by changing the iteration counts without increasing the number of parameters. dsODENet [4] is a lightweight model that combines the ideas of Neural ODE and depthwise separable convolution [5] to further reduce the parameter size and computation cost. These Neural ODE models are smaller than ResNet.

In this paper, we introduce a flexible federated learning that allows clients to use models with different iteration counts and reduces the communication size by using Neural ODE based models. Our contributions are listed below ¹.

- We propose to use the Neural ODE models for federated learning so that a server can aggregate models with different iteration counts. This can enhance the client heterogeneity since clients can use models with different iteration counts. In addition, using the Neural ODE models can significantly reduce the communication size.
- We experimentally demonstrate that the proposed flexible federated learning can aggregate these models with different iteration counts. It is compared with a federated learning approach that uses knowledge distillation. We discuss the pros and cons of the proposed approach.

The rest of this paper is organized as follows. Section 2 introduces baseline technologies behind our proposal. Section 3 proposes the flexible federated learning approach and shows the feasibility of the proposed approach. Section 4 evaluates the proposed approach in terms of the accuracy and communication size. Section 5 concludes this paper.

2 Related Work

2.1 Federated Learning

Federated Averaging (FedAvg) is a basic federated learning algorithm proposed in [1]. Algorithm 1 shows the server- and client-side flows, where K is the total number of clients, k is their index, and \mathcal{P}_k is data at client k . Also, B is the size of a local mini-batch, E is the number of epochs to be trained by each client, and η is a given learning rate. In this algorithm, the first step is to initialize global weight parameters of the model. Then, m clients are randomly selected from K clients, and the server sends the global parameters to the selected clients. The size of m is determined by a client fraction parameter C . The weight parameters are updated at each epoch (E epochs in total) by each client based on the formula in line 13. After E updates, the clients send their trained local parameters to the server. The server aggregates the received local parameters by taking the average based on the formula in line 8, where n is the total number of data and n_k is the total number of data at client k . The aggregated parameters are then sent back to the clients as global parameters. The above steps are repeated t rounds.

Many federated learning technologies have been studied since FedAvg was proposed in 2016. These technologies are surveyed in [7]. Data heterogeneity is one of important research challenges in these studies since it is a major cause of accuracy degradation. For instance, since a local model is optimized toward the local optima by the client, it may be distant from other clients. Thus, their averaged global model may be far from a part of clients. To deal with this problem, FedProx [8] uses an additional proximal term to limit the number of local updates, and SCAFFOLD [9] uses a variance reduction to correct local updates. These algorithms aim to improve the local training step of FedAvg. In contrast, Personalized Federated Averaging [10] and Adaptive Personalized Federated Learning [11] aim to make personalized models that can achieve good accuracy in local clients.

Another challenge is the clients' model heterogeneity. Since not all clients always have the same compute resources, selecting a proper model for each client can help the client heterogeneity. FedFeNN [12] and FedDF [13] address the model heterogeneity. In FedHeNN, each client trains its own model but pulls the representations learned by different clients closer by adding a proximal term to the client's loss function [12]. FedDF is a federated learning algorithm that utilizes a knowledge distillation at the model aggregation step of the federated learning server. In the knowledge distillation step at the server, instead of averaging local parameters received from clients, a batch of sample data is predicted by the local parameters and their output logits are averaged. The averaged logits are then used for updating the client models at the server. Although FedDF allows a federated leaning of different model architectures, model

¹An early stage of this work appeared in our workshop paper [6]. In this paper, we experimentally demonstrate that the proposed approach can aggregate models with different iteration counts. It is compared to a federated learning approach that uses knowledge distillation.

Algorithm 1 Federated Averaging [1]

```

1: function ExecuteServer()
2:   Initialize  $w_0$ 
3:   for each round  $t = 1, 2, \dots$  do
4:      $m \leftarrow \max(r \cdot K, 1)$ 
5:      $S_t \leftarrow$  (random set of  $m$  clients)
6:     for each client  $k \in S_t$  in parallel do
7:        $w_{t+1}^k \leftarrow$  ClientUpdate( $k, w_t$ )
8:      $w_{t+1} \leftarrow \sum_{k=1}^K \frac{n_k}{n} w_{t+1}^k$ 
9:   function ClientUpdate( $k, w$ )  $\triangleright$  Run on client  $k$ 
10:   $\mathcal{B} \leftarrow$  (split  $\mathcal{P}_k$  into batches of size  $B$ )
11:  for each local epoch  $i$  from 1 to  $E$  do
12:    for each batch  $b \in \mathcal{B}$  do
13:       $w \leftarrow w - \eta \nabla \ell(w; b)$ 

```

training is needed at the aggregation step of the server in addition to local training at the clients. This means that all the client models joining the federated learning are also needed at the server.

2.2 ResNet and Neural ODE

ResNet [3] is a well-known neural network architecture that can increase the number of stacked layers or building blocks by introducing shortcut connections. Using a shortcut connection, an input feature map to a building block is temporarily saved, and then it is added to the original output of the building block to generate the final output of the block. In this paper, one building block in ResNet is called ResBlock.

ODE is composed of an unknown function and its ordinary derivatives. To obtain an approximate numerical solution, an ODE solver such as the first-order Euler method and higher-order Runge-Kutta method can be used. Based on a similarity between the network structure with shortcut connections and the ODE solver, one building block can be interpreted as one step in the ODE solver as suggested in [2]. Assuming that the Euler method is used as an ODE solver, it can be interpreted that the first-order approximation is applied to solve an output of the building block. In this paper, one building block is called ODEBlock, and the whole network architecture consisting of ODEBlocks is called ODENet.

2.3 Depthwise Separable Convolution

CNN is composed of multiple layers, such as convolutional layers, pooling layers, and fully-connected layers. Although CNN achieves a good accuracy in image recognition tasks, each convolutional layer has many parameters. Let N , M , and N_K be the number of input channels, the number of output channels, and the kernel size of one side, respectively. The number of parameters in one convolutional layer is NMN_K^2 .

Depthwise separable convolution [5] divides this convolutional layer into two convolutional steps: depthwise convolutional step and pointwise convolutional step. In the depthwise convolutional step, a convolutional operation involving only spatial direction (the size is N_K^2) is applied for each input feature map. Different weight parameters are used for each of N input channels; thus its weight parameter size is NN_K^2 . Then, an output feature map of the depthwise convolutional step is fed to the pointwise convolutional step as an input. A 1×1 convolutional operation is applied for each input feature map and for each output channel; thus its weight parameter size is NM . The weight parameter size of the depthwise separable convolution is $NN_K^2 + NM$ in total, which is approximately N_K^2 times reduction, assuming that $N, M \gg N_K$.

As a low-cost CNN model, dsODENet [4] applies the depthwise separable convolution to convolutional layers of ODEBlocks in order to further reduce the parameter size. It was originally proposed to be implemented on resource-limited FPGA (Field-Programmable Gate Array) devices [4]. In this paper, we use dsODENet as a federated learning model architecture in addition to ODENet. Their detailed structures are illustrated in the next section.

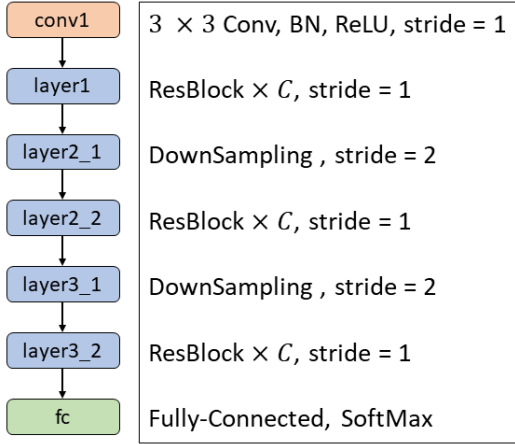

Figure 1: Structure of 7-block ResNet

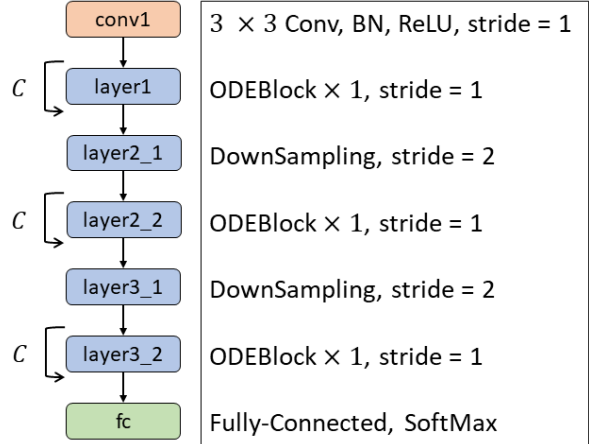

Figure 2: Structure of 7-block ODENet

3 Proposed Federated Learning

In the traditional federated learning such as FedAvg, the server and all clients have to use the same model. For example, models with different layer depths cannot be averaged when ResNet is used as a model architecture. However, in a real environment, client devices are not the same and are likely to have different compute resources, such as memory capacity and computation power. Since the traditional federated learning cannot aggregate models with different depths, a common model used by all the clients should be carefully selected. In addition, it is necessary to reduce the communication size involved in exchanging weight parameters between the server and clients. In this paper, we use ODENet and dsODENet to enable a flexible federated learning between models with different layer iteration counts and significantly reduce the communication size. These target models are illustrated in Section 3.1. We discuss the feasibility of the proposed federated learning in Sections 3.2 and 3.3.

3.1 Target Models

In this section, we first illustrate the structures and sizes of ResNet and ODENet. Then, we illustrate dsODENet.

Figures 1 and 2 show basic structures of ResNet and the corresponding ODENet. They consist of seven blocks including conv1 and fc. In the ResNet model, conv1 performs convolutional operations as a pre-processing layer, and fc is a post-processing fully-connected layer. After the conv1, C physically-stacked ResBlocks are executed in block1. block2_1 is a downsampling ResBlock to reduce the feature map size, and C physically-stacked ResBlocks on the output of block2_1 are executed in block2_2. The same operation is performed for block3_1 and block3_2 too.

ODENet replaces ResBlocks in Figure 1 with ODEBlocks as shown in Figure 2. In ResNet, C ResBlocks are physically-stacked in block1, block2_2, and block3_2, while ODENet replaces these C ResBlocks with a single ODEBlock. Instead, ODEBlock is executed C times in block1, block2_2, and block3_2. A downsampling ODEBlock is executed only once in block2_1 and block3_1, respectively.

Here, we analyze the numbers of parameters of ResNet and ODENet. Let $O(L)$ be the number of parameters in one ResBlock and ODEBlock. In ResNet, C ResBlocks are stacked in one block, so the number of parameters is $O(CL)$. In contrast, ODENet repeats ODEBlock C times in one block, so the number of parameters is $O(L)$. The parameter size reduction by ODENet becomes large as C is increased. As shown, the communication size can be reduced by using ODENet as a federated learning model instead of ResNet.

In addition, the number of parameters can be further reduced by using dsODENet [4] as mentioned in Section 2.3. Figure 3 left shows a structure of an ODEBlock in ODENet. Figure 3 right shows that of dsODEBlock in dsODENet, in which each convolutional layer of the ODEBlock is replaced with two convolutional steps: the depthwise convolutional step and the pointwise convolutional step. Conv1 and Conv2 are convolutional layers, and ReLU (Rectified Linear Unit) is an activation function. This modification can reduce the model and communication sizes compared with ODENet.

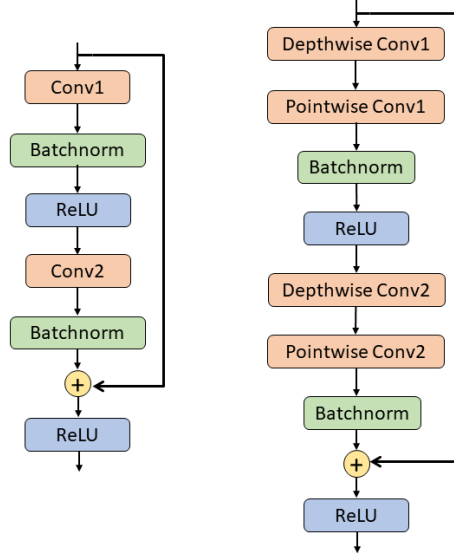

Figure 3: Structures of ODEBlock and dsODEBlock in ODENet and dsODENet

Table 1: Accuracy of ODENet models trained and tested with same or different depths

Trained as	Tested as	Accuracy [%]
ODENet-34	ODENet-34	75.46 ± 0.41
	ODENet-50	75.36 ± 0.43
	ODENet-101	75.26 ± 0.46
ODENet-50	ODENet-34	76.13 ± 0.42
	ODENet-50	76.02 ± 0.42
	ODENet-101	75.91 ± 0.52
ODENet-101	ODENet-34	76.25 ± 0.45
	ODENet-50	76.14 ± 0.47
	ODENet-101	76.13 ± 0.45

Table 2: Accuracy of dsODENet models trained and tested with same or different depths

Trained as	Tested as	Accuracy [%]
dsODENet-34	dsODENet-34	71.67 ± 0.53
	dsODENet-50	71.74 ± 0.68
	dsODENet-101	71.45 ± 0.68
dsODENet-50	dsODENet-34	72.24 ± 0.61
	dsODENet-50	72.10 ± 0.62
	dsODENet-101	72.00 ± 0.69
dsODENet-101	dsODENet-34	72.28 ± 0.64
	dsODENet-50	72.11 ± 0.62
	dsODENet-101	72.13 ± 0.64

3.2 Weight Compatibility with Different Depths

In the case of ResNet, models with different depths have different numbers of stacked ResBlocks (i.e., different C) in their block1, block2_2, and block3_2. If we use FedAvg for federated learning, basically these different ResNet models cannot be averaged at the server due to the model incompatibility. In the case of ODENet, one ODEBlock is repeated C times in block1, block2_2, and block3_2 of ODENet. In other words, ODENet models with different depths differ only in the numbers of iterations of ODEBlocks, not in the number of ODEBlocks. Therefore, the structure of the ODENet models with different C is the same, so their parameters can be averaged at the server. Using ODENet as a federated learning model enables a flexible federated learning between models with different iteration counts and fully utilizes the performance of each client device. dsODENet [4] also enables such a flexible federated learning between models with different iteration counts for the same reason as ODENet.

Here, we examine if the above observation can work. This section focuses on the weight parameter compatibility of models which have different C to demonstrate the feasibility of the proposed federated learning. Specifically, inference accuracies of ODENet and dsODENet models which were trained for the same or different C are evaluated. Please note that, in the following, we use the total number of executed convolutional layers (denoted as N) to represent the depths of the ResNet, ODENet, and dsODENet models. We assume $N = 6C + 6$ in this experiment² and use $N = 34, 50, \text{ and } 101$. For example, the inference accuracy of ODENet-34 is evaluated using weight parameters trained as ODENet-50. We selected two models from $N = 34, 50, \text{ and } 101$: one for training and another for inference. The

²In Figure 1, ResBlocks are executed $3C + 2$ times, each contains two convolutional layers. The pre- and post-processing (conv1 and fc) layers are also included in N ; thus $N = 2(3C + 2) + 2$.

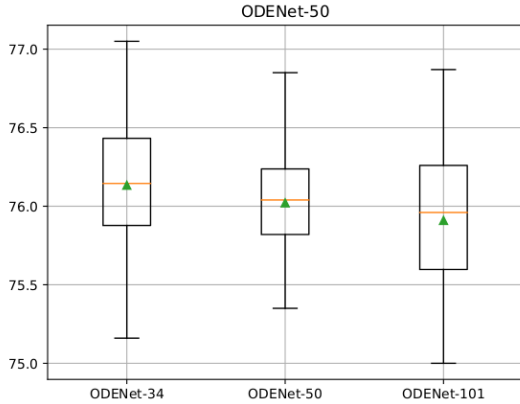

Figure 4: Accuracy of ODENet-34, 50, and 101 using parameters trained as ODENet-50 [%]

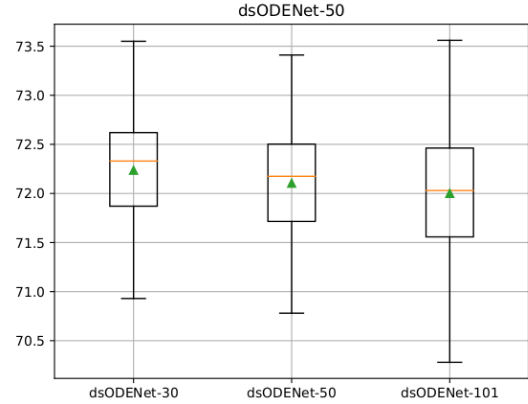

Figure 5: Accuracy of dsODENet-34, 50, and 101 using parameters trained as dsODENet-50 [%]

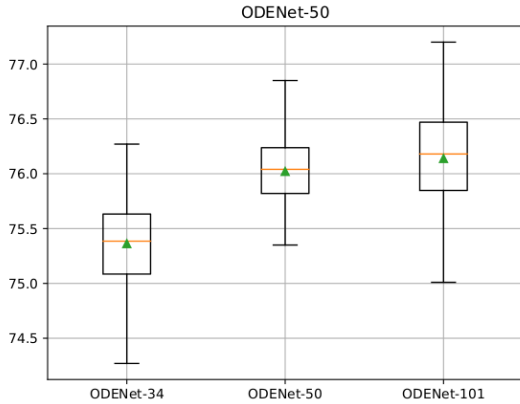

Figure 6: Accuracy of ODENet-50 using parameters trained as ODENet-34, 50, and 101 [%]

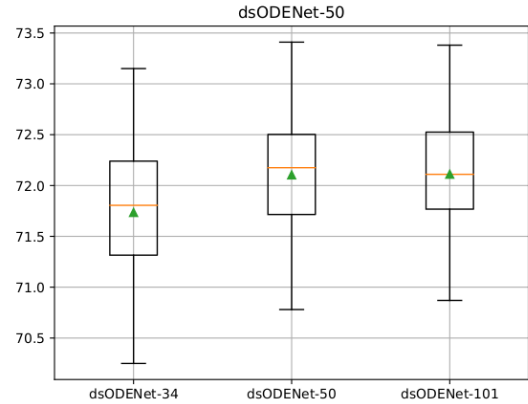

Figure 7: Accuracy of dsODENet-50 using parameters trained as dsODENet-34, 50, and 101 [%]

experiment is performed 100 times for each combination. CIFAR-10 dataset [14] is used for the training and inference. The same experiment is also performed for dsODENet.

Tables 1 and 2 show the inference accuracy of every combination. Figure 4 shows box-plots of accuracies of ODENet-34, 50, and 101 using weight parameters trained as ODENet-50. Figure 5 shows those of dsODENet. The results from Figure 4 and Table 1 show that the accuracies are almost the same regardless of the tested models if the trained model is the same. The results from Figure 5 and Table 2 also show the same tendency in dsODENet. Figure 6 shows box-plots of accuracies of ODENet-50 using weight parameters trained as ODENet-34, 50, and 101, respectively. Figure 7 shows those of dsODENet-50. The results from Figure 6 and Table 1 show that the accuracies depend on N of the trained model. The results from Figure 7 and Table 2 show the same tendency in dsODENet.

As mentioned above, the inference accuracies of the ODENet and dsODENet models are reasonable even if the trained N and tested N are different. This means that ODENet and dsODENet models have a weight parameter compatibility with different depths. Furthermore, Table 1 shows that the accuracies of models that were trained as ODENet-101 are higher than those that were trained as ODENet-34 and ODENet-50. Table 2 also shows a similar tendency in dsODENet. These results indicate that using a deeper model for training can help to enhance the accuracy in ODENet and dsODENet models.

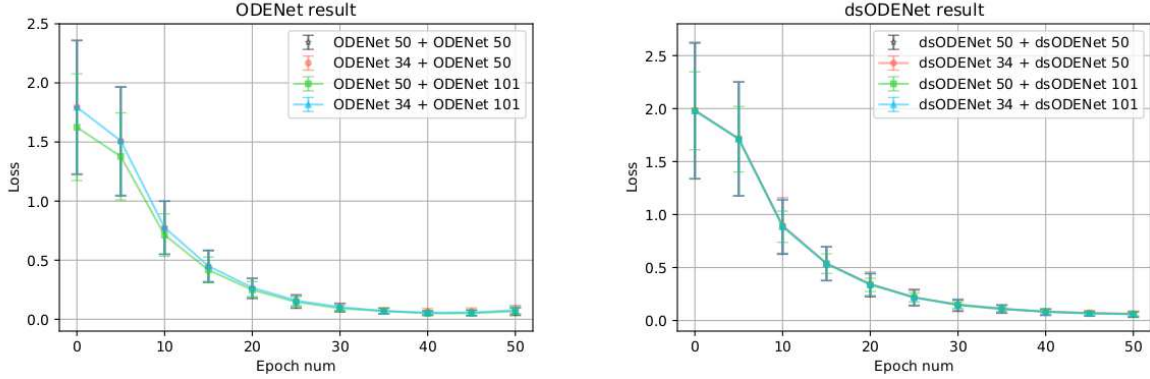

Figure 8: Training curve (epoch number vs. loss value) of ODENet

Figure 9: Training curve (epoch number vs. loss value) of dsODENet

3.3 Federated Learning with Different Depths

In Section 3.2, we showed the weight parameter compatibility in ODENet and dsODENet models with different depths. In this section, we examine the feasibility of federated learning between ODENet models with different depths. Specifically, we perform federated learning of two ODENet models from among $N = 34, 50$, and 101 to see if it works correctly. In this experiment, FedAvg is used as a federated learning algorithm. The number of clients is only 2, the number of local epochs is 5, and the number of communication rounds is 20. ODENet-50 is used as a global model. The same experiment is performed for dsODENet too.

Figures 8 and 9 show training curves (epoch number vs. loss value) of the ODENet and dsODENet models, respectively. In Figure 8, the black, red, green, and blue lines show the loss values when federated learning is performed between ODENet-50 and ODENet-50, between ODENet-34 and ODENet-50, between ODENet-50 and ODENet-101, and between ODENet-34 and ODENet-101, respectively. Similarly, in Figure 9, the black, red, green, and blue lines show the loss values when federated learning is performed between dsODENet-50 and dsODENet-50, between dsODENet-34 and dsODENet-50, between dsODENet-50 and dsODENet-101, and between dsODENet-34 and dsODENet-101, respectively. The horizontal axis of these figures represents the number of epochs, and the vertical axis represents the loss value. As shown, the loss values decrease as the number of epochs is increased, and then they are converged around 50 epochs in all the combinations. This indicates that these model combinations of different depths can be trained successfully. This and previous sections demonstrated that ODENet and dsODENet are capable of federated learning between models with different depths.

4 Evaluations

In this section, we evaluate the proposed flexible federated learning approach that uses FedAvg as a federated learning algorithm and ODENet, dsODENet, and ResNet as client models. They are compared with FedDF which is a model agnostic federated learning approach using a knowledge distillation. Finally, the proposed approach is evaluated in terms of the model size and communication cost.

Python 3.8.5, PyTorch 1.8.1 [15], and torchvision 0.9.1 are used for the model implementation. A machine with Ubuntu 18.04.5 LTS (64-bit), Intel Core i7-10700K CPU @ 3.8GHz, 32GB DDR4 SDRAM, and NVIDIA GeForce RTX 3090 GPU is used for the evaluation in this paper.

4.1 Accuracy

Although Section 3.3 showed the feasibility of the proposed federated learning, only two clients were used in the experiments. However, it is expected that more clients participate in a practical federated learning scenario. In this section, we increase the number of clients and conduct additional experiments.

In addition, it is expected that there is a bias in the data distribution for each client in the case of real environments. This means that the data distribution for each client is non-iid. In this experiment, Dirichlet distribution is thus used to make non-iid data environments. Dirichlet distribution is a kind of continuous multivariate probability distributions,

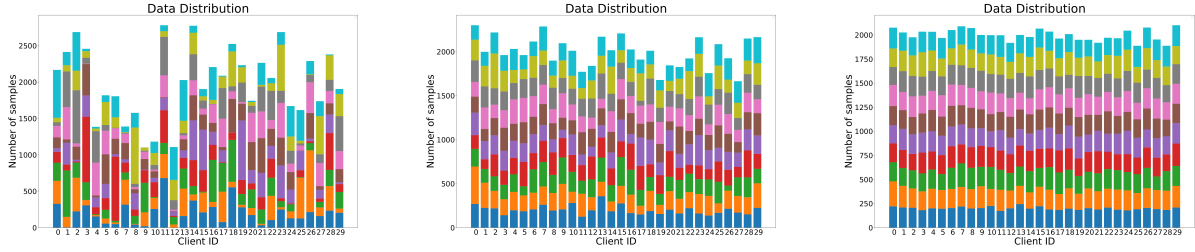

Figure 10: Data distribution using Dirichlet distribution ($\alpha = 1$) Figure 11: Data distribution using Dirichlet distribution ($\alpha = 10$) Figure 12: Data distribution using Dirichlet distribution ($\alpha = 100$)

Table 3: Accuracy of ODENet and dsODENet when using FedAvg and FedDF ($\alpha = 1$)

Model	Algorithm	Top5 [%]	Top1 [%]
ODENet	FedAvg	96.33	66.83
	FedDF	98.23	73.73
dsODENet	FedAvg	96.68	66.91
	FedDF	98.40	75.67

Table 4: Accuracy of ODENet and dsODENet when using FedAvg and FedDF ($\alpha = 10$)

Model	Algorithm	Top5 [%]	Top1 [%]
ODENet	FedAvg	97.25	69.74
	FedDF	98.87	78.55
dsODENet	FedAvg	97.27	69.82
	FedDF	98.81	78.63

Table 5: Accuracy of ODENet and dsODENet when using FedAvg and FedDF ($\alpha = 100$)

Model	Algorithm	Top5 [%]	Top1 [%]
ODENet	FedAvg	97.33	70.48
	FedDF	98.78	78.67
dsODENet	FedAvg	97.38	70.06
	FedDF	98.89	78.72

and its data distribution is controlled by a vector α . We use $\alpha = 1, 10$, and 100 . CIFAR-10 is used as a dataset. Figures 10-12 show examples of data distributions with $\alpha = 1, 10$, and 100 as Dirichlet distribution parameters, respectively.

In this experiment, the number of clients is 30, the number of local epochs is 40, and the number of communication rounds is 100. Among the 30 clients, the numbers of clients that use ODENet-34, ODENet-50, and ODENet-101 are 10, 10, and 10, respectively. ODENet-50 is used as a global model. In Algorithm 1, r is the percentage of clients participating in the aggregation at each communication round. In this experiment, r is set to 0.2, which means that six models are randomly selected from the 30 clients. FedAvg is used in the proposed federated learning approach, and the results are compared with those of FedDF.

Tables 3-5 show the accuracies of ODENet-50 and dsODENet-50 with FedAvg and FedDF when $\alpha = 1, 10$, and 100 , respectively. Top5 accuracies are mostly high regardless of α in both the models. Top1 accuracies are decreased when α is small (e.g., $\alpha = 1$). In this case, the data distribution is highly biased, and the biased data distribution negatively affects the accuracy. Although addressing the data heterogeneity is a crucial challenge in federated learning, many studies have been conducted to overcome this issue as mentioned in [7] and thus addressing this is beyond the scope of this paper.

When we compare the proposed approach using FedAvg with FedDF, the accuracies of the proposed approach are lower than those of FedDF. This result is reasonable since FedDF introduces additional training overheads for the knowledge distillation (e.g., prediction and training of client models) at the server in addition to local training at the clients while the proposed approach does not impose such overheads as well as the conventional FedAvg based

Table 6: Accuracy of FedDF when varying the number of samples used for knowledge distillation ($\alpha = 10$)

Model	# of server samples	Top5 [%]	Top1 [%]
ODENet	5	97.22	69.53
	10	97.09	70.49
	100	97.95	74.37
	500	98.57	76.48
	1000	98.71	78.32
	∞	98.87	78.55
dsODENet	5	97.18	69.52
	10	97.16	69.82
	100	97.93	73.88
	500	98.41	76.89
	1000	98.73	78.32
	∞	98.81	78.63

Table 7: Communication size of ResNet, ODENet, and dsODENet

Model	# of parameters transferred	Size [MB]
ResNet-34	21,780,648	83.09
ResNet-50	25,505,232	97.29
ResNet-101	44,447,912	169.55
ODENet-34	1,937,034	7.39
ODENet-50	1,937,034	7.39
ODENet-101	1,937,034	7.39
dsODENet-34	1,249,381	4.76
dsODENet-50	1,249,381	4.76
dsODENet-101	1,249,381	4.76

approach. To bring the evaluation condition of FedDF closer to that of the proposed approach, here we limit the number of samples to be used in the knowledge distillation at the server.

Table 6 shows the results of FedDF when the number of samples available for the knowledge distillation is varied. α is set to 10 as the data distribution parameter. The other conditions are same as those in Table 4. As shown in Table 6, the accuracy of FedDF increases as the number of server-side samples used in the knowledge distillation is increased. When the number of the available server-side samples is small, the accuracy of FedDF becomes close to (or lower than) the proposed approach, as shown in Tables 4 and 6. Please note that server-side overheads of FedDF are larger than those of the proposed approach since FedDF requires the knowledge distillation at the server. In addition, FedDF requires training samples at the server; however, uploading such samples to the server may not be easy depending on the application due to data privacy perspective (e.g., medical image data). On the other hand, the proposed approach can simply aggregate ODENet based models with different iteration counts without the server-side training nor uploading training samples to the server.

4.2 Communication Size

Table 7 shows communication sizes of the ResNet, ODENet, and dsODENet models with different depths. Here, the communication size means the sum of the weight parameters of convolutional layers and fully-connected layers in these models. The communication is required between the server and clients in each communication round. The size is measured by using torchsummary of PyTorch which is a tool that reports the parameter size information.

Table 7 shows that both the ODENet and dsODENet models reduce the communication sizes compared with the corresponding ResNet model. Compared with ResNet, the communication size of ODENet-50 is 7.6% of the original ResNet model. In the case of ResNet and dsODENet, the communication size of dsODENet-50 is 4.9% of the ResNet model. These results show that the use of ODENet and dsODENet can significantly reduce the communication size between the server and clients.

The communication size increases as N is increased in ResNet. On the other hand, communication sizes are constant regardless of N in the cases of ODENet and dsODENet. This is because the number of physically-stacked blocks is the same in ODENet and dsODENet even if N is different, and only the number of iterations of each block is different.

Please note that, since the model size is small in ODENet and dsODENet, the required memory capacity can also be reduced by these models compared with the original ResNet model.

5 Conclusions

In this paper, we proposed a flexible federated learning approach that can aggregate models with different iteration counts by utilizing ODENet and dsODENet as federated learning models. We demonstrated that these models with different iteration counts can be aggregated correctly (i.e., having the weight compatibility) in the cases of ODENet and dsODENet. Then, the proposed approach simply using FedAvg was compared with FedDF in terms of the accuracy. The experiment results showed that the higher accuracy of FedDF come from additional knowledge distillation overheads at the server. On the other hand, the proposed approach can simply aggregate models with different iteration counts without the server-side training nor uploading training samples to the server. In addition, ODENet and dsODENet were evaluated in terms of the model and communication sizes. Compared with ResNet-50, ODENet-50 and dsODENet-50 successfully reduced the communication sizes by 92.4% and by 95.1%, respectively. These results showed that our approach can significantly reduce the communication overhead while enabling the aggregation of models with different iteration counts.

As a future work, we will evaluate the feasibility of federated learning with ANODE [16] which is a Neural ODE based approach that utilizes a checkpointing method. We are also planning to improve accuracy when α is small. We will combine our approach with state-of-the-art federated learning algorithms.

References

- [1] Brendan McMahan, Eider Moore, Daniel Ramage, Seth Hampson, and Blaise Aguera y Arcas. Communication-Efficient Learning of Deep Networks from Decentralized Data. In *Proceedings of the International Conference on Artificial Intelligence and Statistics (AISTATS)*, pages 1273–1282, April 2017.
- [2] Ricky T. Q. Chen, Yulia Rubanova, Jesse Bettencourt, and David Duvenaud. Neural Ordinary Differential Equations. In *Proceedings of the Annual Conference on Neural Information Processing Systems (NeurIPS)*, pages 6572–6583, December 2018.
- [3] Kaiming He, Xiangyu Zhang, Shaoqing Ren, and Jian Sun. Deep Residual Learning for Image Recognition. In *Proceedings of the IEEE Conference on Computer Vision and Pattern Recognition (CVPR)*, pages 770–778, June 2016.
- [4] Hiroki Kawakami, Hirohisa Watanabe, Keisuke Sugiura, and Hiroki Matsutani. A Low-Cost Neural ODE with Depthwise Separable Convolution for Edge Domain Adaptation on FPGAs. *IEICE Transactions on Information and Systems*, E106-D(7):1186–1197, July 2023.
- [5] Andrew G. Howard, Menglong Zhu, Bo Chen, Dmitry Kalenichenko, Weijun Wang, Tobias Weyand, Marco Andreetto, and Hartwig Adam. MobileNets: Efficient Convolutional Neural Networks for Mobile Vision Applications. arXiv Preprint arXiv:1704.04861, April 2017.
- [6] Yuto Hoshino, Hiroki Kawakami, and Hiroki Matsutani. Communication Size Reduction of Federated Learning based on Neural ODE Model. In *Proceedings of the International Symposium on Computing and Networking (CANDAR) Workshops*, pages 55–61, November 2022.
- [7] Qinbin Li, Zeyi Wen, Zhaomin Wu, Sixu Hu, Naibo Wang, Yuan Li, Xu Liu, and Bingsheng He. A Survey on Federated Learning Systems: Vision, Hype and Reality for Data Privacy and Protection. *IEEE Transactions on Knowledge and Data Engineering*, 35(4):3347–3366, April 2021.
- [8] Tian Li, Anit Kumar Sahu, Manzil Zaheer, Maziar Sanjabi, Ameet Talwalkar, and Virginia Smith. Federated Optimization in Heterogeneous Networks. arXiv Preprint arXiv:1812.06127, April 2020.
- [9] Sai Praneeth Karimireddy, Satyen Kale, Mehryar Mohri, Sashank Reddi, Sebastian Stich, and Ananda Theertha Suresh. SCAFFOLD: Stochastic Controlled Averaging for Federated Learning. In *Proceedings of the International Conference on Machine Learning (ICML)*, pages 5132–5143, July 2020.
- [10] Alireza Fallah, Aryan Mokhtari, and Asuman Ozdaglar. Personalized Federated Learning with Theoretical Guarantees: A Model-Agnostic Meta-Learning Approach. In *Proceedings of the Annual Conference on Neural Information Processing Systems (NeurIPS)*, pages 3557–3568, December 2020.
- [11] Yuyang Deng, Mohammad Mahdi Kamani, and Mehrdad Mahdavi. Adaptive Personalized Federated Learning. arXiv Preprint arXiv:2003.13461, March 2020.

-
- [12] Disha Makhija, Xing Han, Nhat Ho, and Joydeep Ghosh. Architecture Agnostic Federated Learning for Neural Networks. In *Proceedings of the International Conference on Machine Learning (ICML)*, pages 14860–14870, July 2022.
 - [13] Tao Lin, Lingjing Kong, Sebastian U. Stich, and Martin Jaggi. Ensemble Distillation for Robust Model Fusion in Federated Learning. arXiv Preprint arXiv:2006.07242, March 2021.
 - [14] Alex Krizhevsky. Learning Multiple Layers of Features from Tiny Images, April 2009.
 - [15] Adam Paszke, Sam Gross, Francisco Massa, Adam Lerer, James Bradbury, Gregory Chanan, Trevor Killeen, Zeming Lin, Natalia Gimelshein, Luca Antiga, Alban Desmaison, Andreas Kopf, Edward Yang, Zachary DeVito, Martin Raison, Alykhan Tejani, Sasank Chilamkurthy, Benoit Steiner, Lu Fang, Junjie Bai, and Soumith Chintala. PyTorch: An Imperative Style, High-Performance Deep Learning Library. In *Proceedings of the Annual Conference on Neural Information Processing Systems (NeurIPS)*, pages 8024–8035, December 2019.
 - [16] Amir Gholaminejad, Kurt Keutzer, and George Biros. ANODE: Unconditionally Accurate Memory-Efficient Gradients for Neural ODEs. In *Proceedings of the International Joint Conference on Artificial Intelligence (IJCAI)*, pages 730–736, August 2019.