

Incorporating Heterogeneous User Behaviors and Social Influences for Predictive Analysis

Haobing Liu, Yanmin Zhu, *Senior Member, IEEE*, Chunyang Wang, Jianyu Ding, Jiadi Yu, *Member, IEEE*, and Feilong Tang, *Senior Member, IEEE*

Abstract—Behavior prediction based on historical behavioral data have practical real-world significance. It has been applied in recommendation, predicting academic performance, etc. With the refinement of user data description, the development of new functions, and the fusion of multiple data sources, heterogeneous behavioral data which contain multiple types of behaviors become more and more common. In this paper, we aim to incorporate heterogeneous user behaviors and social influences for behavior predictions. To this end, this paper proposes a variant of Long-Short Term Memory (LSTM) which can consider context information while modeling a behavior sequence, a projection mechanism which can model multi-faceted relationships among different types of behaviors, and a multi-faceted attention mechanism which can dynamically find out informative periods from different facets. Many kinds of behavioral data belong to spatio-temporal data. An unsupervised way to construct a social behavior graph based on spatio-temporal data and to model social influences is proposed. Moreover, a residual learning-based decoder is designed to automatically construct multiple high-order cross features based on social behavior representation and other types of behavior representations. Qualitative and quantitative experiments on real-world datasets have demonstrated the effectiveness of this model.

Index Terms—Heterogeneous User Behaviors, Social Influences, Projection Mechanism, Multi-faceted Attention Mechanism.

1 INTRODUCTION

Behavior prediction [1], [2], [3], [4] aims to predict future behaviors based on historical behavioral data. Behavior predictions are in demand in practical applications. For example, predicting students' academic performances [5] is needed in a university. With the prediction task, the institution can perceive students' future academic performances. Thus, the institution can identify which students might be at risk so as to intervene in time and can teach students with their corresponding aptitude. Another well-known example is recommending products to consumers [3]. Recommendation systems benefit consumers, providers, and platforms.

With the rapid development of the Internet and the Internet of Things, information systems of various industries are collecting a myriad of user behavioral data. According to whether behavioral data are of the same type, behavioral data can be classified into homogeneous behavioral data and heterogeneous behavioral data [6]. Due to the refinement of user data description, the development of new functions, and the fusion of multiple data sources, heterogeneous behavioral data which contain multiple types of behaviors become more common. For example, in most universities, smart cards are used as students' IDs (for accessing facilities such as libraries) and digital wallets (for payment and recharge). Consequently, entering the library,

entering the dormitory, and transaction records can be got by the institution. In most E-commerce portals, systems will record clicking, adding to cart, and purchasing behaviors of consumers. User habits can be learned from multiple types of behaviors. User habits are reflected in many facets (e.g., study habits, reading habits, and rest habits). That is to say, the relationships among multiple types of behaviors are multi-faceted. User habits are deciding factors affecting prediction results. Besides, people participate in social activities to make friends with others. Studies have shown that people may change their attitudes and behaviors in response to what they think their friends might do or think, which is known as the social influence [7], [8]. Social influences are key factors, too. Different parts of friends influence a user in different ways. For example, a student's dining behaviors may be influenced by her classmates, and the student's studying behaviors may be influenced by her friends whose academic performances are similar to the student.

In literature, there have been a number of studies on modeling heterogeneous behavioral data for predictive analysis. According to whether models capture sequential dependencies, studies can be classified into two categories. The first category mainly extracts various static features from heterogeneous behaviors or extends the Matrix Factorization (MF) algorithm to handle different types of behaviors. For instance, Wang et al. [9] found correlations between students' cumulative GPAs and various features extracted from automatic sensing behavioral data. They used a generalized linear regression model as the predictive model. Fan et al. [10] used graph neural networks (GNNs) to model the user-item interaction graph and the user-user social behavior graph, respectively. Then operations such as concatenations were leveraged to merge representations. However, mining sequence-related patterns of behaviors

Haobing Liu is with the Department of Computer Science and Technology, Ocean University of China, China, and the Department of Computer Science and Engineering, Shanghai Jiao Tong University, China (e-mail: haobingliu@ouc.edu.cn). Yanmin Zhu, Chunyang Wang, Jianyu Ding, Jiadi Yu, and Feilong Tang are with the Department of Computer Science and Engineering, Shanghai Jiao Tong University, China (e-mail: yzhu@sjtu.edu.cn; wangchy@sjtu.edu.cn; dingjianyu@sjtu.edu.cn; jiadiyu@sjtu.edu.cn; tang-fl@cs.sjtu.edu.cn).

Yanmin Zhu is the corresponding author.

Manuscript received June 30, 2021; revised September 26, 2021.

cannot be achieved via these methods. The second category takes into account both the heterogeneity of behaviors and the sequential nature of behaviors. For instance, Kim et al. [11] utilized a bidirectional LSTM to model daily activities collected in online learning environments. Zhou et al. [12] trained a model with a Recurrent Neural Network (RNN) to model sequential dependencies and an attention layer to capture different effects of behaviors. Tanjim et al. [13] leveraged a Transformer layer to learn item similarities from the interacted item sequence and leveraged a convolution layer to obtain the user's intent from her actions on a particular category. Most existing studies ignore that relationships among multiple types of behaviors are diverse and model the relationships in a coarse-grained way. These methods may learn inaccurate relationships among different types of behaviors.

In this paper, we take Predicting Academic Performance (PAP) [5], Predicting the Number of Borrowed Books (PNBB) [14], [15], and Predicting the Level of Financial Difficulty (PLFD) [16], [17] as three motivating examples of behavior prediction tasks. That is to say, there are three types of target behaviors: obtaining grades, borrowing books, and applying for financial aids. Support behaviors include studying in the library, resting in the dormitory, dining in the canteen, shopping in the store, showering in the bathroom, recharging, and social behaviors. We mainly confront the following challenges. First, behaviors are affected by context information (e.g., weather conditions). A common scenario is that students prefer to rest in the dormitory under storming weather. A simple way to consider context information is to concatenate it with behavior information. However, we believe that context information and behavior information are different and should be treated differently. So the challenge lies in *how to consider context information while modeling behaviors*. Second, there are multiple kinds of relationships among multiple types of behaviors, which can be found from different facets/perspectives. Most existing studies model the relationships in one latent semantic space so they cannot model the diverse relationships well. So another challenge is *how to model diverse relationships among different types of behaviors*. Third, behaviors of different periods will have different degrees of impact on one prediction task and the change varies from user to user. For instance, study plans of students vary so different days mean differently to them. So a new challenge is *how to differentiate importance degrees of different periods dynamically*. Fourth, only by knowing social behaviors can we capture social influences. But in some cases, there is no direct access to social behaviors. For example, it is difficult to collect social behaviors on campus, while it is very easy on social media. In such cases, constructing a social behavior graph is needed. Thus, a challenge is *how to construct a social behavior graph to capture social influences*. Fifth, the relationships between social behaviors and other types of behaviors are diverse. Different parts of friends will influence one user in different ways. Most existing studies are difficult to model the diverse relationships by methods such as concatenating user representations or combining user-user graph and user-item graph into one graph. Thus, *how to model diverse relationships between social behaviors and other types of behaviors* is challenging.

To address the above challenges, we first propose a general neural network called JMBS in our preliminary work [18]. More specifically, each kind of daily behavior sequence is modeled by a variant of LSTM. By adding context information in the gates of LSTM, LSTM can consider context information while modeling a daily behavior sequence. Then the latent representations of all types of behaviors are concatenated. To dynamically learn different importance degrees of different days, an attention mechanism is designed. Then a final user habit representation is got. Many kinds of behavioral data belong to spatio-temporal data, and a social behavior graph can be constructed according to the co-occurrences between any pair of users. Next, a GNN is leveraged to get a social influence representation. We design a residual learning-based decoder. The decoder automatically constructs multiple high-order cross features based on the social influence representation and the habit representation, and models feature-level interactions in a fine-grained way. In our preliminary work, we simply concatenate the latent representations of all types of behaviors assuming that these latent representations are in the same latent semantic space. In this paper, we extend our preliminary work to solve the second challenge and propose a general neural network which incorporates Heterogeneous User Behaviors and Social influences. We call the model HUBS. Concretely, we project each type of behavior representation to multiple latent semantic spaces. In each space, vectors that are projected to the space are added together. With multiple latent semantic spaces, the model can model multi-faceted relationships in a fine-grained way. Besides, the proposed attention mechanisms are leveraged parallelly in multiple latent semantic spaces.

In summary, the main contributions of this paper are as follows:

- We propose a general deep neural network called HUBS which incorporates heterogeneous user behaviors and social influences for predictive analysis.
- We propose a projection mechanism to model the multi-faceted relationships among multiple types of behaviors in a fine-grained way. Concretely, we leverage multiple projection functions to generate multiple latent semantic spaces, i.e., latent facets. We design a multi-faceted attention mechanism to dynamically find out informative periods from different facets. Specifically, we perform multiple attention mechanisms parallelly in multiple latent semantic spaces.
- We provide a taxonomy to divide existing user behavior prediction methods into four categories. Specifically, we propose two two-value dimensions to classify methods. The dimensions are homogeneous behaviors versus heterogeneous behaviors and non-sequential behavior prediction versus sequential behavior prediction.
- We conduct plenty of experiments to show the effectiveness, the extensibility, and the efficiency of our model.

The rest of this paper is organized as follows. We introduce the proposed taxonomy in Section 2. Next, we introduce related definitions followed by the problem statement

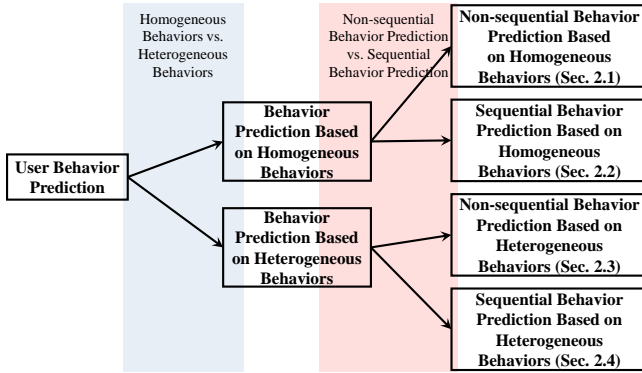

Fig. 1. Classification of current studies on behavior prediction.

in Section 3. Following that, we propose our model, i.e., HUBS in Section 4. Section 5 presents the experimental results and analysis. Then, we discuss the extensibility and the efficiency of our model in Section 6. We discuss the ethical considerations in Section 7. Finally, we conclude the paper in Section 8.

2 RELATED WORK

We provide a taxonomy to classify existing user behavior prediction methods into four categories. Specifically, we propose two two-value dimensions: *homogeneous behaviors versus heterogeneous behaviors* and *non-sequential behavior prediction versus sequential behavior prediction*. Figure 1 shows the classification.

2.1 Non-sequential Behavior Prediction Based on Homogeneous Behaviors

This category mainly mines the static relevancy between users and objects. According to whether leveraging deep learning, methods can be classified into traditional methods and deep learning-based methods.

2.1.1 Traditional Methods

Traditional Methods mainly include the MF algorithm [19], the Factorization Machine (FM) [20] algorithm. For example, Sweeney et al. [21] explored the Factorization Machine (FM) [20] algorithm based on (student, course) tuple.

Traditional methods cannot model complex nonlinear relations among features.

2.1.2 Deep Learning-based Methods

Some methods combine traditional methods with Multi-Layer Perceptrons (MLPs). For example, He et al. [22] captured non-linear user-item relationships with an MLP and linear relationships with an inner product. They called the proposed architecture NCF. He and Chua [23] added an MLP over a FM to model high-order feature interactions and named the model NFM. Some methods are based on pooling layers. These methods regard interacted items as a set and leverage various pooling layers. For example, Zhou et al. [24] utilized an attention-based pooling layer to integrate items. Following the pooling layer, an MLP is adopted. Besides, some methods explore GNNs. For example, Wang

et al. [25] exploited GNNs based on user-item graphs and called the proposed model NGCF. Xu et al. [26] constructed heterogeneous graphs whose nodes contain users, objects, and diverse attributes about objects. Some nodes might have text information. They proposed a GNN-based model to mine topic-aware semantics for learning multi-faceted node representations.

We argue that these methods model behaviors from static views and neglect the heterogeneity of behaviors.

2.2 Sequential Behavior Prediction Based on Homogeneous Behaviors

This category strives to model temporal dependencies existing in behaviors. Methods can be further classified into traditional methods, Recurrent Neural Network (RNN)-based methods, Convolution Neural Network (CNN)-based methods, Transformer-based methods, GNN-based methods, and other methods.

2.2.1 Traditional Methods

Traditional methods mainly leverage Markov Chains (MCs). For example, Rendle et al. [27] integrated the MF with first-order MCs for next-item recommendation. Inspired by studies on knowledge graph completion, He et al. [28] regarded users as “translation vectors” and the previous item representation plus a user representation (i.e., a translation vector of the user) approximately determine the next item representation.

In general, these methods can only consider short-term dependencies.

2.2.2 RNN-based Methods

RNNs have been widely adopted to model sequence data and have achieved good performance in various domains (e.g., neural language processing). There are many well-known variants of RNN models, such as LSTM [29], Gated Recurrent Unit (GRU) [30]. Hidasi et al. [31] introduced GRU to recommendation systems. They leveraged a GRU to model click behaviors of users. Su et al. [32] leveraged a bidirectional LSTM to model student exercise sequences generated in online education systems and leveraged an attention mechanism to integrate all contents. Zhu et al. [33] proposed a variant of LSTM called Time-LSTM. Specifically, they changed the gate structure of the standard LSTM cell and the time interval is used to control the contribution of long-term memory versus short-term memory. Chen et al. [2] proposed another way to consider temporal information. They did not modify the internal structure of standard LSTMs. They chose to augment input representations with temporal information.

These methods cannot model the heterogeneity of behaviors. In addition, when sequences are very long, training costs of these methods will be huge.

2.2.3 CNN-based Methods

CNNs have been commonly applied to process image data. Some methods leverage CNNs to handle behavioral data. For example, Tang and Wang [34] regarded representations of L interacted items as a $L \times d$ “image”, where d is the embedding size. Then they used a horizontal convolutional

layer and a vertical convolutional layer to capture union-level patterns and point-level sequential patterns, respectively.

CNNs are good at capturing local features. So these methods cannot capture the dependencies between two distant interactions well.

2.2.4 Transformer-based Methods

Transformer [35] has shown promising results in various domains. Some methods introduce Transformer to model user behaviors. For example, SASRec [36] is a self-attention network-based method and can capture pairwise item dependencies. Wang et al. [37] first discovered an itemset for each interacted item with a knowledge graph. Then they merged each item representation with corresponding itemset representation. Finally, they leveraged a self-attention network to model the representation sequence.

These methods capture sequential dependencies through positional encoding technique. There exist many positional encoding schemes [38]. An inappropriate choice of the positional encoding scheme will lead to wrong time modeling.

2.2.5 GNN-based Methods

Some researchers transform sequences into directed graphs and leverage GNNs. For example, Wu et al. [39] transformed sequences into directed graphs and utilized a gated graph neural network to obtain session representations. Some researchers transform sequences into undirected graphs and utilize other methods to capture sequential dependencies. For example, Fan et al. [40] mapped timestamps into vectors.

These methods rely on constructed directed graphs or other methods to capture sequential-related patterns. The transformations may be lossy since they are not one-to-one mappings.

2.2.6 Other Methods

There also exist some other deep learning structures that have been explored. For example, some methods combine the sliding window technique with MLPs. Wang et al. [15] leveraged an MLP to predict library circulation of next five days based on data of previous twenty days.

2.3 Non-sequential Behavior Prediction Based on Heterogeneous Behaviors

This category mainly extracts various static features from heterogeneous behaviors or extends the MF algorithm to handle different types of behaviors. Methods can be classified into traditional methods and deep learning-based methods according to whether leveraging deep learning.

2.3.1 Traditional Methods

Some methods first extract various static features from heterogeneous behaviors. Then they leverage traditional models. For example, Wang et al. [9] found correlations between students' cumulative GPAs and various features extracted from automatic sensing behavioral data. They used a generalized linear regression model as the predictive model. Guan et al. [16] identified students qualified for financial aids based on students' digital footprints. Specifically, the paper proposed a multi-label classification framework which

consists of two steps: heterogeneous features extraction and funds portfolio predicting via linear model. Some methods extend classical methods to consider the heterogeneity of behaviors. For example, Zhao et al. [41] built matrices of different behavior types (e.g., creating post, commenting behaviors) and then they mapped every user of each behavior type and every item into one latent embedding space. Qiu et al. [42] addressed multi-behavior recommendation with bayesian learning. They proposed an adaptive sampling method for the Bayesian Personalized Ranking (BPR) [43] framework by considering the co-occurrence of multiple behavior types.

These methods cannot model nonlinear interactions among features.

2.3.2 Deep Learning-based Methods

Some methods introduce MLPs or GNNs. For example, Sukhbaatar et al. [44] employed an MLP on the set of prediction factors extracted from the online learning activities of students to identify students at risk of failing a course. Gao et al. [45] assumed that there existed a cascading relationship among different types of behaviors and combined NCF [22] with multi-task learning. Some researchers [46], [47], [48] construct user-item multi-behavior graphs based on heterogeneous behaviors and exploit GNNs. Some researchers [49], [10] consider social behaviors. They design models to handle user-user graphs and user-item graphs simultaneously.

Mining sequence-related patterns of behaviors cannot be achieved via these methods.

2.4 Sequential Behavior Prediction Based on Heterogeneous Behaviors

This category takes into account both the heterogeneity of behaviors and the sequential nature of behaviors. Studies in this category are relatively rare. Fei and Yeung [50] leveraged an LSTM to model student weekly activities recorded by online learning platforms. Kim et al. [11] utilized a bidirectional LSTM to model daily activities collected in online learning environments. Zhou et al. [12] trained a model with an RNN layer to model sequential information and an attention layer to capture different effects of behaviors. Zhou et al. [51] proposed a self-attention based model to learn from several behavior groups. Tanjim et al. [13] used a Transformer layer to learn item similarities from the interacted item sequence and used a convolution layer to obtain the user's intent from her actions on a particular category. Liu et al. [52] modeled each kind of behavior sequence with an attention-based LSTM and modeled the implicit interactions among multiple behavior prediction tasks. Liu et al. [53] further proposed a model to model interactions among multiple behavior prediction tasks explicitly. Wu et al. [54] considered a local sequence view and a global graph view. In the local view, each kind of behavior sequence was modeled by a sequence-based encoder. In the global view, a user-item multi-behavior graph was modeled by graph-based encoders. They designed three contrastive learning (CL) tasks, including the multi-behavior CL, the multi-view CL, and the behavior distinction CL. Luo et al. [55] constructed heterogeneous graph snapshots for each

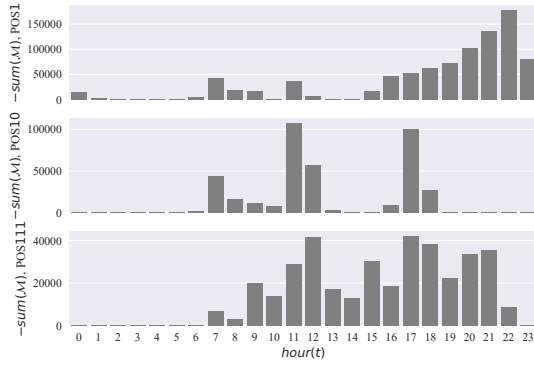

Fig. 2. Distributions of students' cumulative payments at three different POS terminals with respect to the time slots.

User	Object	Behavior Type	Time	Context Info.
				DayOfWeek
u7682977832	grades	obtain	fall semester 2016	
u7682977832	lib_gate10	study	2017-03-19 14:30:24	Sunday
u7682977832	dorm_gate3	rest	2017-05-08 22:10:14	Monday
u1239705379	pos10	dine	2017-06-04 12:36:03	Sunday
u7682977832	grades	obtain	spring semester 2017	

User	Object	Behavior type	Time
u257597	i355908	view	1433221332117
u599528	i356475	view	1433221896102
u1016014	i448124	view	1433221898558
u599528	i356475	add to cart	1433221941632
u599528	i356475	purchase	143322276276

Fig. 3. Heterogeneous behavioral data instances.

ongoing event to encode the attributes of the event and its surroundings. In addition, they combined GNNs with GRU to generate the event representation. Events are multi-typed.

Most existing methods ignore that relationships among different types of behaviors are diverse. So they model the mixed relationships directly without distinguishing the various relationships and then model them. That is to say, they model the relationships in a coarse-grained way. These methods may learn inaccurate relationships among different types of behaviors and damage the prediction performance.

3 PRELIMINARIES

In this section, we fix some definitions and introduce the problem statement.

Definition 1: Behavior. While users interact with information systems, interactions will be recorded. The interactions can be semantically different. Given a target user u , her interactions can be defined as $X^u = \{x_1, x_2, \dots, x_N\}$. The i -th element $x_i = (o_i, t_i, b_i, c_i)$ indicates that u performs a behavior of type b_i on the object o_i at the time t_i . c_i is the context information which shows the environment when users perform behaviors, such as day of week.

It is worth noting that behavior types can be predefined depending on the actual scenario. For example, one transaction record on smart campus can be represented as $(o_i, t_i, \mathcal{M}_i)$, where o_i denotes the Point of Sale (POS), t_i denotes the timestamp of the record, and $\mathcal{M}_i \in \mathbb{R}^- \cup \mathbb{R}^+$ denotes the amount of money involved in the transaction

record. If $\mathcal{M}_i < 0$, the type of the transaction is payment; otherwise the type is recharge (i.e., *recharging behavior*). We define another three types of behaviors according to the semantic functionality of o_i . They are *dining in the canteen*, *shopping in the store*, and *showering in the bathroom*. To find out the semantic functionality of o_i , we calculate cumulative payments of students hourly for every POS terminal. Distributions at different POS terminals can be roughly classified into three categories. As Figure 2 shows, POS1 is set in the bathroom. Students would like to shower at night. POS10 is set in the canteen. Students more likely have breakfast in $[07:00, 08:00)$, lunch in $[11:00, 12:00)$, and dinner in $[17:00, 18:00)$. POS111 is set in the store. Students mainly shop in $[07:00, 22:00)$, extremely in $[12:00, 13:00) \cup [17:00, 18:00)$.

For better understanding, we give examples of heterogeneous behavioral data in Figure 3. There are four types of student behaviors in the upper part of the figure. In the bottom part of the figure, there are three types of consumer behaviors.

Definition 2: Social Behavior Graph. According to social behaviors, users are connected to form a social behavior graph, namely a social network. A social network can be defined as $G = (V, E, \mathbf{A})$, where V is a node (i.e., student) set, E is an undirected edge set which indicates the connectivity between nodes, and $\mathbf{A} \in \mathbb{R}^{|V| \times |V|}$ is the adjacency matrix of graph G .

Definition 3: Demographic Information. Demographic information belongs to the content information associated with users. Demographic information of user u can be formalized as D^u , where D^u is an attribute set about demographic information. Attributes may include province, nationality, gender, grade, and school. For simplicity, we may omit the subscripts in the following contents.

Problem Statement. Given heterogeneous behavioral data X (Social behaviors are not included.), social behavior graph G , demographic information D , and a particular behavior type (i.e., *target behavior type*), the goal is to predict next target behavior. For each behavior prediction task, there exist $M + 1$ support behavior types (The $(M + 1)$ -th support behavior type is social behavior type.). In this paper, M types of support behaviors are generated every day. Target behaviors are generated every semester. Assuming that a user (i.e., a student) has T observations of the target behavior type, we leverage support behaviors generated during the first N days of the $T + 1$ semester and target behaviors generated during the first T semesters to predict the $T + 1$ target behavior ($N < \# \text{ days in one semester}$).

Definition 4: Academic performance. PAP task aims to predict academic performance. We choose Weighted Average Grade (WAG) which is on a 100-point scale to quantitatively describe the academic performance of a student in one semester. WAG can be seen as term GPA.

Definition 5: Number of borrowed books. PNBB task aims to predict the number of borrowed books. We count the number of borrowed books each semester.

Definition 6: Level of financial difficulty. PLFD task aims to predict the level of financial difficulty. The assessment on financially disadvantaged students will be done every semester. It is the prerequisite of implementing the policy of helping students with financial difficulties. In general, there

TABLE 1
Main notations.

Notation	Description
D	Demographic information of the target user.
\bar{D}	User profile representation.
$B_{m,n}$	Feature vector of the m -th support behavior type at the n -th day.
c_n	Context information at the n -th day.
$h_{m,n,\ l}$	Latent representation of the m -th support behavior type at the n -th day in the l -th latent semantic space.
$\alpha_{\ l}$	Attention weights in the l -th latent semantic space.
$\bar{B}_{\ l}$	User habit representation got from the l -th latent facet.
$y_{\mathcal{T}}$	Observation of the target behavior type at the \mathcal{T} -th semester.
h'	Future trend representation.
G	Constructed social network.
S	Node representation/social influence representation.
\bar{S}	Re-trained social influence representation.

are two levels of financial difficulties: high difficulty level (i.e., level 1) and medium difficulty level (i.e., level 2). These 2 levels of financial difficulties act as 2 different labels. We also introduce 1 dummy label (i.e., level 3) for indicating no financial difficulty. In fact, nearly 80% of students do not have financial difficulty each semester.

4 PROPOSED HUBS MODEL

The main architecture of our proposed deep neural network (HUBS) is illustrated in Figure 4. The model consists of two parts: the user representation learning part and the interaction modeling part. Table 1 summarizes main notations and their meanings used throughout this paper.

4.1 User Representation Learning

This part will learn four kinds of user representations: the user profile representation from demographic information, the user habit representation from support behaviors, the future trend representation from historical observations of the target behavior type, and the social influence representation from social behavior graph. In what follows, we introduce how to learn each kind of representation.

4.1.1 User Profile Representation Learning

Demographic information D is represented in the form of one high-dimensional vector: $D = \{a_1, a_2, \dots, a_K\}$, where K is the number of attributes and each attribute is represented as a one-hot vector. To reduce the dimension of D , we use a dense embedding layer. The transformation is formalized as:

$$\bar{D} = [W_1 a_1, W_2 a_2, \dots, W_K a_K], \quad (1)$$

where W terms are the mapping matrices and $[,]$ represents the concatenation of vectors. In this way, we get the user profile representation \bar{D} .

4.1.2 User Habit Representation Learning

We divide support behaviors (Social behaviors are not included.) into several behavior groups according to behavior types. We regard one day as one time unit and aggregate behaviors within one day for each student. Let $B_{m,n}$ denote the feature vector of the m -th support behavior at the n -th day ($1 \leq m \leq M, 1 \leq n \leq N$). The way to generate $B_{m,n}$ from X is introduced as follows. We divide one day into 24 time slots by hour (i.e.,

$[00:00, 01:00), \dots, [23:00, 24:00)$). We find that around 100.0% of studying in the library (i.e., entering the library) behaviors are generated in $[07:00, 23:00)$; around 68.5% of resting in the dormitory (i.e., entering the dormitory) behaviors are generated in $[17:00, 24:00) \cup [12:00, 13:00)$. We utilize 16 elements to record entering in the library frequency in $[07:00, 23:00)$ per hour at the n -th day; we utilize 8 elements to record entering the dormitory frequency in $[17:00, 24:00) \cup [12:00, 13:00)$ per hour at the n -th day. Thus, $B_{Lib,n} \in \mathbb{R}^{16 \times 1}$ and $B_{Dorm,n} \in \mathbb{R}^{8 \times 1}$. Besides, we record the cost of each meal at the n -th day. Thus, $B_{Canteen,n} \in \mathbb{R}^{3 \times 1}$. To get $B_{Store,n}$, $B_{Bthrm,n}$ or $B_{RP,n}$, we record the frequency and the total cost at the n -th day. Thus, $B_{Store,n} \in \mathbb{R}^{2 \times 1}$, $B_{Bthrm,n} \in \mathbb{R}^{2 \times 1}$, and $B_{RP,n} \in \mathbb{R}^{2 \times 1}$.

According to different tasks, proper support behaviors are chosen. Specifically, studying in the library and resting in the dormitory behaviors are chosen for PAP and PNBB tasks; dining in the canteen, shopping in the store, showering in the bathroom, and recharging behaviors are chosen for the PLFD task. Each kind of daily behavior sequence is modeled by a variant of LSTM called context-aware LSTM. Context-aware LSTM considers context information while modeling a behavior sequence and treats behavior features and context features differently at the same time. Context information c_n is treated as a strong signal in the gates of context-aware LSTM (as Equation (2), (3) and (5) show). That is to say, context information affects what to extract, what to remember, and what to forward.

Context-aware LSTM is formulated as follows and the detailed structure is shown in Figure 5:

$$i_{m,n} = \sigma(W_{m,iB} B_{m,n} + W_{m,ih} h_{m,n-1} + W_{m,ic} c_n + b_{m,i}), \quad (2)$$

$$f_{m,n} = \sigma(W_{m,fB} B_{m,n} + W_{m,fh} h_{m,n-1} + W_{m,fc} c_n + b_{m,f}), \quad (3)$$

$$\hat{c}_{m,n} = f_{m,n} \odot \hat{c}_{m,n-1} + i_{m,n} \odot \tanh(W_{m,\hat{c}B} B_{m,n} + W_{m,\hat{c}h} h_{m,n-1} + b_{m,\hat{c}}), \quad (4)$$

$$o_{m,n} = \sigma(W_{m,oB} B_{m,n} + W_{m,oh} h_{m,n-1} + W_{m,oc} c_n + b_{m,o}), \quad (5)$$

$$h_{m,n} = o_{m,n} \odot \tanh(\hat{c}_{m,n}), \quad (6)$$

where $i_{m,n}$, $f_{m,n}$ and $o_{m,n}$ are the input, forget and output gates at the n -th step respectively. $\hat{c}_{m,n}$ is the cell memory. $B_{m,n}$ and $h_{m,n}$ are one input and the corresponding output (i.e., hidden state) at the n -th step respectively. c_n is the context vector at the n -th step. W terms denote weight matrices and b terms are bias vectors. $\sigma(\cdot)$ is the element-wise sigmoid function and \odot is the element-wise product.

Relationships among multiple types of behaviors (i.e., user habits) are multi-faceted. To model the multi-faceted relationships in a fine-grained way, we propose a projection mechanism. Specifically, we project each type of behavior representation to L latent semantic spaces via projection functions. In each space, connections or comparisons can be made. Then one type of dependency can be automatically modeled in each space. The way of modeling relationships in multiple spaces is fine-grained. For simplicity, we leverage linear projections and the projection of the m -th support behavior type for the l -th latent semantic space can be formalized as:

$$h_{m,n,\|l} = W_{m,l} h_{m,n}, \quad 1 \leq n \leq N, \quad (7)$$

where $W_{m,l} \in \mathbb{R}^{d \times d_m}$ is the projection matrix, $h_{m,n} \in \mathbb{R}^{d_m \times 1}$, and $h_{m,n,\|l} \in \mathbb{R}^{d \times 1}$. After the projection process, in

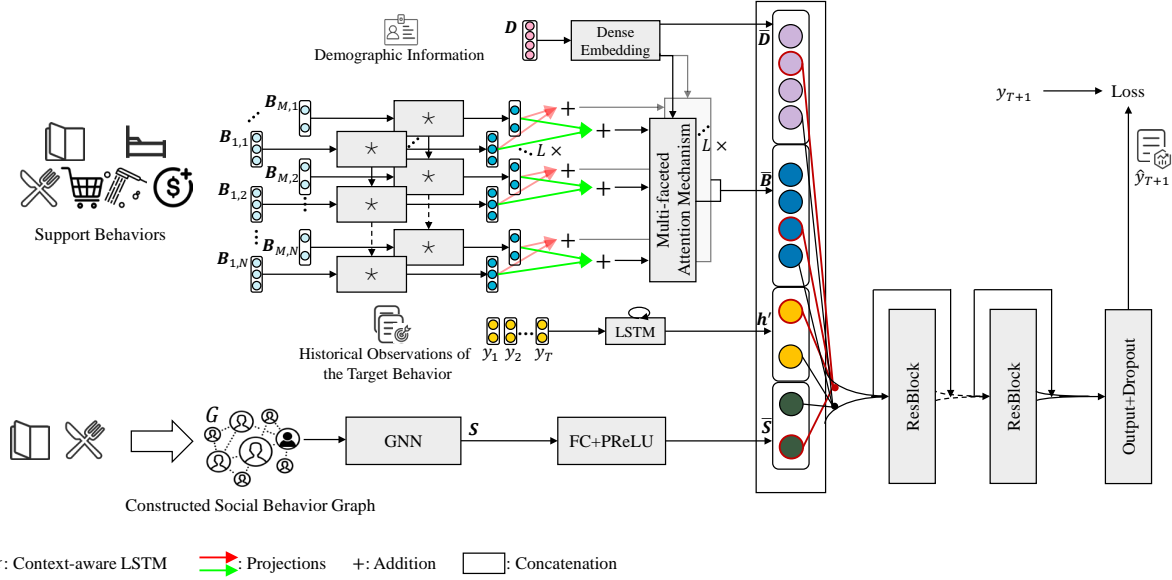

Fig. 4. The architecture of HUBS. Figure best viewed in color.

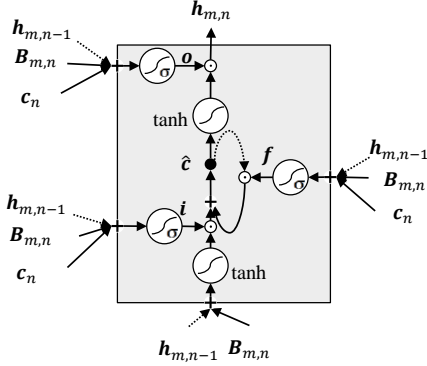

Fig. 5. Detailed structure of context-aware LSTM.

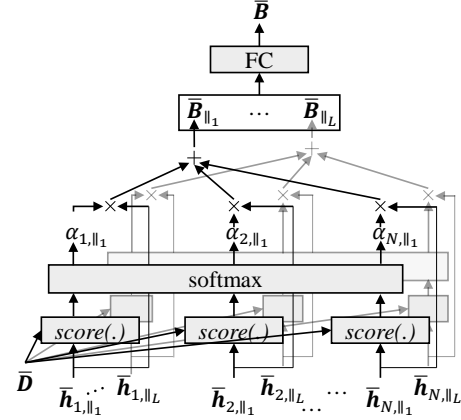

Fig. 6. Detailed structure of multi-faceted attention mechanism.

the l -th latent semantic space, we add the projected vectors together:

$$\bar{h}_{n,||l} = \sum_{m=1}^M h_{m,n,||l}, \quad 1 \leq n \leq N, \quad (8)$$

where $\bar{h}_{n,||l} \in \mathbb{R}^{d \times 1}$.

Behaviors of different periods will have different degrees of impact in each latent semantic space. Inspired by the multi-head attention mechanism [56], [35], we design a multi-faceted attention mechanism. Specifically, in each space, we perform an attention mechanism to draw information from the sequence by different weights. Namely, we will learn L different user habit representations from L different latent facets. Then, these L different representations are integrated to learn a final user habit representation. The structure of multi-faceted attention mechanism is illustrated in Figure 6.

Concretely, the l -th representation learned from the l -th

facet is computed with the following equations:

$$\text{score}(\bar{D}, \bar{h}_{n,||l}) = \mathbf{W}_{||l,a0} \bar{D} + \mathbf{W}_{||l,a1} \bar{h}_{n,||l} + \mathbf{b}_a, \quad (9)$$

$$\alpha_{n,||l} = \frac{\exp(\text{score}(\bar{D}, \bar{h}_{n,||l}))}{\sum_{n'} \exp(\text{score}(\bar{D}, \bar{h}_{n',||l}))}, \quad (10)$$

$$\bar{B}_{||l} = \sum_{n=1}^N \alpha_{n,||l} \bar{h}_{n,||l}, \quad (11)$$

where \bar{D} is calculated with Equation (1), $\bar{h}_{n,||l}$ is calculated with Equation (8), \mathbf{W} terms denote weight matrices, \mathbf{b}_a is the bias vector, and $\bar{B}_{||l} \in \mathbb{R}^{d \times 1}$. Next, a linear projection is leveraged to integrate learned multiple representations and calculate a final user habit representation using the following equation:

$$\bar{B} = \mathbf{W}_{a3} [\bar{B}_{||1}, \bar{B}_{||2}, \dots, \bar{B}_{||L}], \quad (12)$$

where $\mathbf{W}_{a3} \in \mathbb{R}^{dL \times dL}$ is the projection matrix and $\bar{B} \in \mathbb{R}^{dL \times 1}$.

4.1.3 Future Trend Representation Learning

Note that the length of the historical observation sequence may vary from user to user, so we adopt a dynamic LSTM to capture the temporal dependencies existing in the observation sequence and formulate it as:

$$\mathbf{h}'_{\mathcal{T}} = \text{LSTM}(y_{\mathcal{T}}, \mathbf{h}'_{\mathcal{T}-1}), \quad 1 \leq \mathcal{T} \leq T, \quad (13)$$

where $y_{\mathcal{T}}$ and $\mathbf{h}'_{\mathcal{T}}$ are one input and the corresponding output (i.e., hidden state) at the \mathcal{T} -th step. The final hidden state $\mathbf{h}'_{\mathcal{T}}$ is the future trend representation and we represent it as \mathbf{h}' for consistency.

4.1.4 Social Influence Representation Learning

Inspired by work [57], [58], many kinds of behavioral data belong to spatio-temporal data and we infer the friendship between two users by the co-occurrences. With the increase of the co-occurrences frequency of two users, it becomes more evident that they are friends. Here, one *co-occurrence* is defined as that two students enter the library (i.e., study in the library) at the same library gate within a short time interval (e.g., 10 minutes) or two students pay for meals (i.e., dine in the canteen) at the same POS terminal within a short time interval (e.g., 10 minutes). We do not utilize resting in the dormitory behaviors to compute co-occurrences because a pair of friends may not live in the same dormitory. Besides, our investigation demonstrates that almost 100% of students prefer to dine rather than shop or shower with their friends. Thus, the friendship inferred based on co-occurrences in the library/canteen will be more accurate.

To prove our idea and find thresholds for removing the effect of random cases, we plot co-occurrence distributions in the real world/random cases in one semester as Figure 7 illustrates. In particular, we simulate the random cases of co-occurrences in the library by randomly shuffling the object (i.e., library gate) or randomly shuffling the timestamp. For example, if the fragment of library entrance records is $\{(stu1,7,2016-10-16 \ 19:17:02), (stu2,2,2016-10-16 \ 19:17:10), (stu3,2,2016-10-16 \ 19:17:29)\}$, we shuffle these three timestamps and may get $\{(stu1,7,2016-10-16 \ 19:17:29), (stu2,2,2016-10-16 \ 19:17:10), (stu3,2,2016-10-16 \ 19:17:02)\}$. The comparison of co-occurrence distributions between the real world and random cases is shown in Figure 7(a). From the figure, we can see that when the co-occurrence frequency of two students is more than 30, these two students are likely to be friends. Thus, the threshold is set as $\frac{30 \times N}{\# \text{ days in one semester}}$. Similarly, we shuffle the object (i.e., POS terminal) and shuffle the timestamp. The comparison is shown in Figure 7(b). From the figure, we can see that when the co-occurrence frequency of two students is more than 20, these two students are likely to be friends. Thus, the threshold is set as $\frac{20 \times N}{\# \text{ days in one semester}}$. Then, we can define the friendship between student u and student v as:

$$\text{friendship}(u, v) = \begin{cases} 1, & \mathcal{O}_{Lib,uv} \geq \tau_{Lib} \text{ or } \mathcal{O}_{Canteen,uv} \geq \tau_{Canteen}, \\ 0, & \text{otherwise,} \end{cases} \quad (14)$$

$$\tau_{Lib} = \frac{30 \times N}{\# \text{ days in one semester}}, \quad \tau_{Canteen} = \frac{20 \times N}{\# \text{ days in one semester}},$$

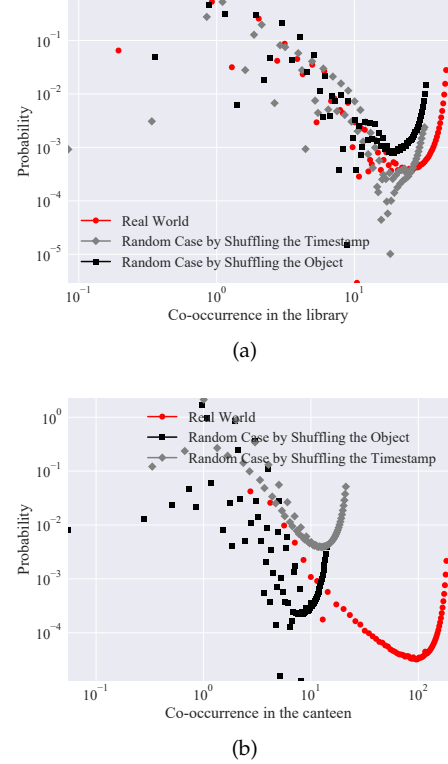

Fig. 7. co-occurrence distributions in the real world/random cases.

where $\mathcal{O}_{Lib,uv}$, $\mathcal{O}_{Canteen,uv}$ are the co-occurrence frequencies of student u and v in the library, the canteen, respectively.

Each element in the adjacency matrix \mathbf{A} of the social behavior graph G can be calculated with Equation (14): $\mathbf{A}_{uv} = \text{friendship}(u, v)$.

Once getting the social behavior graph, we can apply GNNs (such as SDNE [59], GraphSAGE [60], DeepInf [61]) on it to embed each node into a low-dimensional vector and maintain the structural information. For simplicity, we choose to use SDNE [59] which could capture the highly nonlinear network structure and preserve the local and global structure. For node u (i.e., student u), SDNE outputs the embedded feature vector:

$$\mathbf{S}^u = \text{Lookup}(\text{SDNE}(G), u), \quad (15)$$

where $\text{Lookup}(\cdot)$ means looking up the embedded feature vector for the given identification from node embeddings.

In addition, a Fully Connected (FC) layer followed by a nonlinear activation function is employed to re-train the embedded feature vector \mathbf{S} according to the given task:

$$\bar{\mathbf{S}} = \text{PReLU}(\mathbf{W}_e \mathbf{S} + \mathbf{b}_e), \quad (16)$$

where \mathbf{W}_e and \mathbf{b}_e are learnable parameters, and $\text{PReLU}(\cdot)$ [62] is the nonlinear activation function. It is a modification of ReLU which replaces the zero part with a negative part controlled by learnable parameters.

4.2 Interaction Modeling

Relationships between social behaviors and other types of behaviors are diverse. In fact, different parts of friends influ-

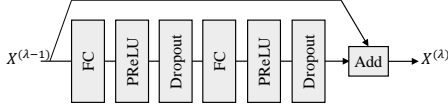

Fig. 8. Detailed structure of ResBlock.

ence one user in different ways. Inspire by FM-based models [20], [23] and the residual learning [63], [64], to model diverse relationships in a fine-grained way, we propose a ResBlock. According to representation learning, each dimension in a latent vector represents a feature. After getting four kinds of user representations via encoders, we feed these latent vectors into a ResBlock-based decoder. By stacking multiple ResBlocks, the decoder gradually automatically constructs multiple high-order cross features based on latent vectors. Specifically, the decoder has three types of layers: the concatenate, the ResBlock, and the output Layer.

Firstly, four kinds of user representations are concatenated into one high-dimensional feature vector as the input to the ResBlock layer:

$$\mathbf{X}^{(0)} = [\bar{\mathbf{D}}, \bar{\mathbf{B}}, \mathbf{h}', \bar{\mathbf{S}}]. \quad (17)$$

Residual learning allows CNNs to have a super deep structure. Different from visual computing, our input is a high-dimensional vector and has no spatial proximity relation, thus convolution filter is not feasible. In this paper, we design a variant of residual blocks depicted in Figure 8. Formally, one ResBlock is defined as:

$$\mathbf{X}^{(\lambda)} = \mathbf{X}^{(\lambda-1)} + \mathcal{F}(\mathbf{X}^{(\lambda-1)}), \quad 1 \leq \lambda \leq \Lambda, \quad (18)$$

where $\mathcal{F}(\cdot)$ is the residual function (i.e., two combinations of “FC+PReLU+Dropout”) and λ is the block index.

The dimensions of $\mathbf{X}^{(\lambda-1)}$ and $\mathcal{F}(\mathbf{X}^{(\lambda-1)})$ must be equal in Equation (18). If the dimensions are not equal, we can perform a linear transformation by the skip connection:

$$\mathbf{X}^{(\lambda)} = \mathbf{W}_p \mathbf{X}^{(\lambda-1)} + \mathcal{F}(\mathbf{X}^{(\lambda-1)}), \quad (19)$$

where \mathbf{W}_p is the transformation matrix.

We stack Λ ResBlocks. Thus the decoder can automatically construct multiple high-order cross features based on social behavior representation and other types of behavior representations, and models feature-level interactions in a fine-grained way.

Finally, we feed the output of the last ResBlock to the output layer to get the final predicted value:

$$\hat{y}_{T+1} = \phi(\mathbf{W}_o \mathbf{X}^{(\Lambda)} + b_o), \quad (20)$$

where \mathbf{W}_o and b_o are parameters; $\phi(\cdot)$ represents the activation function. We regard PAP task and PNBB task as regression tasks and we choose $\tanh(\cdot)$ as the activation function. Meanwhile, we regard PLFD task as a classification task and we choose $\text{softmax}(\cdot)$ as the activation function.

4.3 Optimization

For regression tasks, we adopt Mean Squared Error (MSE) as the loss function:

$$\mathcal{L}(\Theta) = \frac{1}{|I|} \sum_{i \in I} (y^i - \hat{y}^i)^2, \quad (21)$$

TABLE 2
Datasets statistics.

Item	Value	
	Dataset1	Dataset2
# Students	10,000	8,005
Time Span	09/12/2016 - 01/15/2017 02/20/2017 - 06/25/2017	03/22/2016 - 06/26/2016 09/12/2016 - 01/15/2017
# Library Entrance Records	867,571	\
# Dormitory Entrance Records	1,783,595	\
# Smart Card Transaction Records	\	6,655,352
# Support behavior types besides the social behavior type	2	4
# Demographic Records	10,000	8,005
Average # Involved Semesters per Student	~4.6	~4.5

where i denotes one training instance, I is the training set, y^i is the actual value, \hat{y}^i is the predicted value, and Θ are all trainable parameters in the model.

For the classification task, we adopt Focal Loss [65] as the loss function to address the class imbalance problem:

$$\mathcal{L}(\Theta) = - \sum_{i \in I} \sum_{c \in C} (1 - \hat{y}_{o,c}^i)^\gamma y_{o,c}^i \log(\hat{y}_{o,c}^i), \quad \gamma \geq 0, \quad (22)$$

where C denotes the class set, $y_{o,c}$ is the binary indicator of whether class c is the correct classification for observation o , $\hat{y}_{o,c}$ is predicted probability observation o is of class c , γ is the tunable focusing parameter, i denotes one training instance, I is the training set, and Θ are all trainable parameters in the model. The focusing parameter γ can smoothly adjust the rate at which easy examples are down-weighted.

In order to improve the generalization capability of our model, we adopt Dropout [66] on the output layer and the FC layers existing in ResBlock. The idea of Dropout is to prevent co-adaptation by temporarily randomly making some neurons unreliable during training. Co-adaptation phenomenon may occur in learning large neural networks. Concretely, if all the parameters are learned together in a large neural network, some of the connections will have more predictive capability and these connections are learned more (other connections are ignored).

We adopt the adaptive moment estimation (Adam) [67] as the optimizer. Adam is an optimization method that can compute adaptive learning rates for each parameter and converges faster. The training process is outlined in Algorithm 1.

5 EXPERIMENTS

5.1 Dataset

We collected two datasets in a university. One dataset covers 10,000 undergraduate students and contains library entrance records and dormitory entrance records in two continuous semesters (i.e., 09/12/2016 - 01/15/2017 and 02/20/2017 - 06/25/2017). We use this dataset to do PAP task and PNBB task. The other dataset covers 8,005 undergraduate students and contains smart card transaction records in two continuous semesters (i.e., 03/22/2016 - 06/26/2016 and 09/12/2016 - 01/15/2017). We use this dataset to do PLFD task. Dataset statistics are shown in

Algorithm 1 Learning Algorithm for HUBS

```

Input:
    Given heterogeneous behavioral data  $X$  (Social behaviors
    are not included.), social behavior graph  $G$ , demographic
    information  $D$ , and the target behavior type
Output:
    HUBS with learned parameters  $\Theta$ 
1: Generate behavior feature vectors  $\mathbf{B}_{m,n}$  from  $X$  ( $1 \leq m \leq$ 
 $M, 1 \leq n \leq N$ )
2: if The adjacency matrix of the social behavior graph  $G$  is
    not available then
3:   Infer the adjacency matrix according to Eq. (14)
4: end if
5: Initialize all trainable parameters  $\Theta$ 
6: while stopping criteria is not met do
7:   Draw a mini-batch from the training set
8:   for each sample  $i$  do
9:     //User Profile Representation Learning
10:     $\bar{\mathbf{D}} = \text{Dense\_Embedding}(\mathbf{D})$  (see Eq. (1))
11:    //User Habit Representation Learning
12:    for each  $m \in [1, M]$  do
13:       $\mathbf{h}_{m,n} = \text{Context-aware\_LSTM}(\mathbf{B}_{m,n}, \mathbf{c}_n), 1 \leq n \leq N$ 
        (see Eq. (6))
14:    end for
15:    for each  $m \in [1, M]$  do
16:      for each  $l \in [1, L]$  do
17:         $\mathbf{h}_{m,n,\|l} = \mathbf{W}_{m,l} \mathbf{h}_{m,n}, 1 \leq n \leq N$  (see Eq. (7))
18:      end for
19:    end for
20:    for each  $l \in [1, L]$  do
21:       $\bar{\mathbf{h}}_{n,\|l} = \sum_{m=1}^M \mathbf{h}_{m,n,\|l}, 1 \leq n \leq N$  (see Eq. (8))
22:    end for
23:    for each  $l \in [1, L]$  do
24:       $\alpha_{n,\|l} = \text{Attention\_Mechanism}(\bar{\mathbf{D}}, \bar{\mathbf{h}}_{n,\|l}), 1 \leq n \leq$ 
 $N$  (see Eq. (10))
25:       $\bar{\mathbf{B}}_{\|l} = \sum_{n=1}^N \alpha_{n,\|l} \bar{\mathbf{h}}_{n,\|l}$  (see Eq. (11))
26:    end for
27:     $\bar{\mathbf{B}} = \mathbf{W}_{a3}[\bar{\mathbf{B}}_{\|1}, \bar{\mathbf{B}}_{\|2}, \dots, \bar{\mathbf{B}}_{\|L}]$  (see Eq. (12))
28:    //Future Trend Representation Learning
29:     $\mathbf{h}'_{\mathcal{T}} = \text{LSTM}(y_{\mathcal{T}}, \mathbf{h}'_{\mathcal{T}-1}), 1 \leq \mathcal{T} \leq T$  (see Eq. (13))
30:     $\mathbf{h}' \leftarrow \mathbf{h}'_{\mathcal{T}}$ 
31:    //Social Influence Representation Learning
32:     $\mathbf{S} \leftarrow \mathbf{S}^i = \text{Lookup}(\text{SDNE}(G), i)$  (see Eq. (15))
33:     $\bar{\mathbf{S}} = \text{PReLU}(\mathbf{W}_e \mathbf{S} + \mathbf{b}_e)$  (see Eq. (16))
34:    //Interaction Modeling
35:     $\mathbf{X}^{(0)} = [\bar{\mathbf{D}}, \bar{\mathbf{B}}, \mathbf{h}', \bar{\mathbf{S}}]$  (see Eq. (17))
36:    for each  $\lambda \in [1, \Lambda]$  do
37:       $\mathbf{X}^{(\lambda)} = \mathbf{X}^{(\lambda-1)} + \mathcal{F}(\mathbf{X}^{(\lambda-1)})$  (see Eq. (18))
38:    end for
39:     $\hat{y} \leftarrow \hat{y}_{T+1} = \phi(\mathbf{W}_o \mathbf{X}^{(\Lambda)} + \mathbf{b}_o)$  (see Eq. (20))
40:  end for
41:  if Regression task then
42:    Compute loss according to  $\mathcal{L}(\Theta) = \frac{1}{|I|} \sum_{i \in I} (y^i - \hat{y}^i)^2$ 
43:  end if
44:  if Classification task then
45:    Compute loss according to  $\mathcal{L}(\Theta) = - \sum_{i \in I} \sum_{c \in C} (1 -$ 
 $\hat{y}_{o,c}^i)^{\gamma} y_{o,c}^i \log(\hat{y}_{o,c}^i), \gamma \geq 0$ 
46:  end if
47:  Update  $\Theta$  according to  $\mathcal{L}$  and optimizer
48: end while
49: return  $\Theta$ 

```

Table 2. We consider weather conditions and metadata (day of week) as context data.

5.2 Baselines

We compare our proposed method with the following models:

- **HO**: We give the prediction result by the average value of historical observations for regression tasks and by the last observation value for the classification task.
- **LM** [9]: We choose bayesian ridge regression (i.e., with L_2 regularization) as the linear regression model and logistic regression as the linear classifier.
- **SVM/SVR** [14]: Support Vector Machine (SVM) is a maximum-margin classifier. Support Vector Regression (SVR) is a minimum-margin regression model.
- **RF**: Random Forest (RF) is an ensemble method with decision trees as base learners. It is based on the “bagging” idea.
- **GBDT**: Gradient Boosting Decision Tree (GBDT) is another kind of ensemble method using decision trees as base learners. It is based on the “boosting” idea.
- **MLP** [44]: An MLP consists of multiple fully connected layers.
- **EERNNA** [32]: EERNNA utilizes a bidirectional LSTM to model student exercise sequences generated in online education systems and leverages an attention mechanism to integrate all contents. We con-

catenate behavior feature vectors generated in one day with the related context feature vector into one feature vector and regard it as an “exercise content”.

- **ATRank** [51]: ATRank models partitions behaviors into different behavior groups according to the behavior type and models the influence among different behavior types via a self-attention mechanism.
- **APAMT** [52]: APAMT models each kind of behavior sequence with an attention-based LSTM and models the implicit interactions among multiple tasks. We adopt it to handle PAP and PNBB tasks simultaneously.
- **DAPAMT** [53]: DAPAMT models each kind of behavior sequence with an attention-based LSTM and models the interactions among multiple tasks explicitly based on the co-attention mechanism. We adopt it to handle PAP and PNBB tasks simultaneously.
- **JMBS** [18]: JMBS is proposed in our preliminary work. It leverages multiple context-aware LSTMs and an attention mechanism to model daily behavior sequences. Besides, it adopts SDNE to handle the constructed social behavior graph and get social influence representations.

5.3 Evaluation Metrics

For regression tasks, we use Mean Square Error (MSE) to evaluate our model. MSE penalizes large errors more heavily than the non-quadratic metrics. For the classification task, we use Macro-F1 to evaluate our model. Macro-F1 is

insensitive to the imbalance of the classes. It treats classes as equal and one model cannot get a high Macro-F1 value by assigning the majority class label. The metrics are defined as:

$$MSE = \frac{1}{|I|} \sum_{i \in I} (y^i - \hat{y}^i)^2, \quad (23)$$

$$MacroF1 = \frac{1}{|C|} \sum_{c \in C} F1_c = \frac{1}{|C|} \sum_{c \in C} \frac{2P_c R_c}{P_c + R_c}, \quad (24)$$

where i denotes one testing instance, I is the testing set, y^i is the actual value, and \hat{y}^i is the predicted value. C denotes the class set. $F1_c$, P_c and R_c are F1-score, precision, and recall with respect to class c .

5.4 Implementation Details

The length of the historical observation sequence of the target behavior type is uncertain. So except for APAMT, DAPAMT and JMBS, we extract some descriptive statistics (minimum, maximum and mean) as features for regression tasks and leverage the last observation value as a factor for the classification task. Except for EERNNA, ATRank, APAMT, DAPAMT and JMBS, we extract features from support behaviors as Fei and Yang [50] suggested. The attention mechanism we used in EERNNA is designed as in work [68]. In addition, we extend EERNNA so that it can take demographic information into consideration.

We represent categorical features with one-hot encoding or multi-hot encoding (used for weather conditions). We process numerical inputs with the min-max normalization to ensure they are within a suitable range. For WAG and the number of borrowed books, because we use tanh as the activation function in the output layer, we scale them into $[-1, 1]$. In the evaluation, we re-scale the predicted values back to the normal values, compared with the groundtruth. For the other numerical inputs, we scale them into $[0, 1]$. On each dataset, around half of the data (i.e., the former semester) are used as the training set (accounting for 90%) and the validation set (accounting for 10%); the other half (i.e., the latter semester) are used for testing.

The hyper-parameters of all methods are tuned on the validation set. We only present the optimal settings of our method are as follows. The dense embedding layer has 30 neurons in total. The dimensions of the hidden states in the context-aware LSTMs which handle $\{B_{Lib,n}\}$, $\{B_{Dorm,n}\}$, $\{B_{Canteen,n}\}$, $\{B_{Store,n}\}$, $\{B_{Bthrm,n}\}$ and $\{B_{RP,n}\}$ are set to 12, 6, 4, 4, 4, and 4, respectively. We set the number of latent semantic spaces to be 4 (i.e., $L = 4$). For the PAP and PNBB tasks, the dimension size of each space is set to 16. For the PLFD task, the dimension size of each space is set to 8. The dimension of the hidden state in the dynamic LSTM which handles the historical observation sequence is set to 5. The dimensions of S , \bar{S} are set to 16, 8, respectively. The decoder contains 2 ResBlocks (i.e., $\Lambda = 2$) and each FC layer which exists in the ResBlock contains 100 neurons. The dropout rate is set to 0.4. The focusing parameter γ is set to 2. We make predictions after the first half of the semester (i.e., $N = \frac{\# \text{ days in one semester}}{2} = \frac{126}{2} = 63$).

TABLE 3

Comparison of different methods. The results with the best performance are marked in bold, and the results with the second best performance are marked in italics. * represents significance level p -value < 0.05 of comparing HUBS with the best baseline.

Compared Methods	PAP MSE	PNBB MSE	PLFD MacroF1
HO	31.85	63.50	0.6813
LM	27.45	49.64	0.8052
SVM/SVR	26.71	49.18	0.7524
RF	17.76	30.02	0.7765
GBDT	17.98	29.73	0.7658
MLP	17.57	28.36	0.8297
EERNNA	15.67	28.12	0.8635
ATRank	15.06	26.55	0.8970
APAMT	14.99	25.72	-
DAPAMT	13.79	25.13	-
JMBS	13.63	23.97	0.9286
HUBS w/ Vanilla LSTM	13.54	24.00	0.9314
HUBS w/o Social Information	13.46	24.40	0.9204
HUBS	12.80*	22.71*	0.9652*

5.5 Experimental Results

We conduct four experiments. First, we compare our proposed model with advanced methods to show the effectiveness of our model. Second, we divide all students in the testing set into several groups to see the effectiveness results breaking down various student groups. Third, we do ablation studies to prove the effectiveness of the key components in HUBS. Fourth, we study how hyper-parameters impact the performance.

5.5.1 Comparison with Baselines

The execution of all the models is carried out five times by changing the random seeds, and we report the average results in Table 3. The two-tailed unpaired t -test is performed to detect significant differences between HUBS and the best baseline. From the table, we can see that HUBS achieves the best performance with the lowest MSE 12.80 on the PAP task, the lowest MSE 22.71 on the PNBB task, and the largest MacroF1 0.9652 on the PLFD task.

We can see that HO performs poorly, as it only utilizes historical observations. Other baselines further consider more information and therefore achieve better performance. Ensemble models (i.e., RF and GBDT) perform well except on the PLFD task. We think this is due to the class imbalance problem of the PLFD task. Usually, ensemble methods will be superior to individual learners by combining them together to reduce bias and/or variance of learners. MLP performs well because MLP could model complex relations among features with deep learning. EERNNA performs better than MLP. Since it can extract features automatically from daily behavior sequences with an attention-based bidirectional LSTM compared with MLP. ATRank performs better than EERNNA because it could consider both the diversity and sequential nature of behaviors. APAMT performs better than ATRank on PAP and PNBB tasks. We think that is because APAMT can implicitly model the interactions among multiple prediction tasks with multi-task learning. DAPAMT performs better than APAMT since it can explicitly model the interactions among multiple tasks based on the co-attention mechanism. JMBS performs better than DAPAMT. We think the reason is that JMBS can model

the social influence and complex high-order nonlinear interactions between features.

It is worth mentioning that HUBS achieves 6.1%, 5.3%, 3.9% relative improvements on PAP, PNBB, PLFD tasks, compared with JMBS. HUBS can model multi-faceted relationships among multiple types of behaviors with a projection mechanism. In addition, a multi-faceted attention mechanism is designed to dynamically find out informative periods from different facets.

5.5.2 Case Studies

We divide all students in the testing set into several groups. Specifically, we rank all students by the academic performance, i.e., WAG. Then we divide all students into four groups: $\mathcal{G}_{AP,1}$ ($87.43 \leq WAG \leq 96.29$), $\mathcal{G}_{AP,2}$ ($84.28 \leq WAG \leq 87.42$), $\mathcal{G}_{AP,3}$ ($80.16 \leq WAG \leq 84.25$), and $\mathcal{G}_{AP,4}$ ($52.24 \leq WAG \leq 80.14$). Each group has the same number of students. From the left of Figure 9, we can see that HUBS performs the worst on $\mathcal{G}_{AP,4}$. It is because the WAG range of $\mathcal{G}_{AP,4}$ is the biggest and the number of students who get poor academic performances is too small to train the model well. We also rank all students by the number of borrowed books. We divide students into two groups: $\mathcal{G}_{NBB,1}$ ($2 \leq \# \text{ borrowed books} \leq 137$) and $\mathcal{G}_{NBB,2}$ ($0 \leq \# \text{ borrowed books} \leq 1$). 48% (around half) of students belong to $\mathcal{G}_{NBB,1}$. We can see that HUBS performs worse on $\mathcal{G}_{NBB,1}$ as the middle of Figure 9 illustrates. It is because the number of borrowed books range of $\mathcal{G}_{NBB,1}$ is much bigger. Finally, we divide all students into three groups according to the level of financial difficulty: $\mathcal{G}_{LFD,1}$ (level 1), $\mathcal{G}_{LFD,2}$ (level 2), and $\mathcal{G}_{LFD,3}$ (level 3). 15% of students belong to $\mathcal{G}_{LFD,1}$ and 13% of students belong to $\mathcal{G}_{LFD,2}$. From the right of Figure 9, we can see that HUBS performs worse on $\mathcal{G}_{LFD,2}$. It is because the number of students who belong to $\mathcal{G}_{LFD,2}$ is the smallest and it is hard to train the model well.

5.5.3 Ablation Studies

Table 3 also provides the comparison results of variants of our proposed method. Firstly, we prove the benefit of the context-aware LSTM. We replace the context-aware LSTM with a vanilla LSTM and concatenate behavior feature vectors with related context feature vectors as inputs. The performance on the three tasks becomes poorer (reductions of 5.8%, 5.7%, 3.5% on PAP, PNBB, PLFD tasks respectively). Secondly, we remove the social influence representation learning part from HUBS. The performance on the three tasks becomes poorer (reductions of 5.2%, 7.4%, 4.6% on PAP, PNBB, PLFD tasks respectively). The effectiveness of our proposed residual learning-based decoder, proposed projection mechanism, and proposed multi-faceted attention mechanism is shown in Section 5.5.4.

5.5.4 Effect of Hyper-parameters

Effect of the Number of ResBlocks. As we utilize a residual learning-based decoder, problems worth studying are whether residual learning is effective and how many ResBlocks are appropriate. Experimental results are shown in Figure 10.

As the number of ResBlocks grows, the performance grows. When the number of ResBlocks is 3, the performance on PNBB and PLFD tasks drops slightly and the

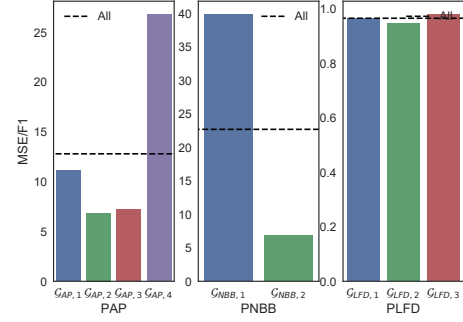

Fig. 9. The effectiveness results breaking down various student groups.

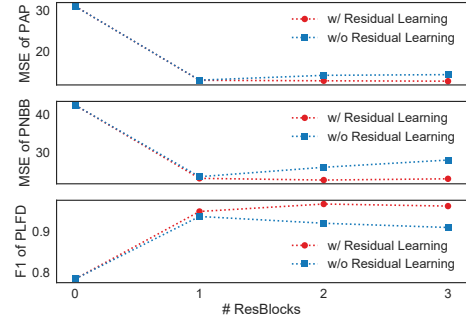

Fig. 10. Performance of HUBS with respect to # ResBlocks, whether utilizing residual learning.

performance on the PAP task barely changes. We think the overfitting problem occurs.

We remove skip connections from ResBlocks to verify the effectiveness of residual learning. Performance without residual learning is poorer than performance with residual learning and when the number of Resblocks grows, the gap becomes bigger.

Effect of the Number of Latent Semantic Spaces (i.e., Facets) and the Dimension Size of Each Space. As we project each type of behavior representation to multiple latent semantic spaces, how many spaces are appropriate and the appropriate dimension size of each space are important questions.

First, we investigate how many latent semantic spaces are appropriate in Figure 11. We fix the dimension size of each space (16 for the PAP and PNBB tasks, 8 for the PLFD task) and adjust the number of spaces. As the number of spaces increases, the performance is improved. When the number of spaces is 5, the performance drops. We think the overfitting problem occurs. It is worth noting that the results also prove the effectiveness of the proposed multi-faceted attention mechanism. Thus, we set the number of latent semantic spaces to 4 in our experiments.

Next, in Figure 12, we study the appropriate dimension size of each latent semantic space. We fix the number of spaces as 4, and then vary the dimension size of each space. As the dimension size increases, the performance grows. When the dimension size is 32, the performance on the PNBB task drops. We think the overfitting problem occurs. At the same time, a large dimension size leads to heavy computational costs. Thus, we set the dimension size to 16

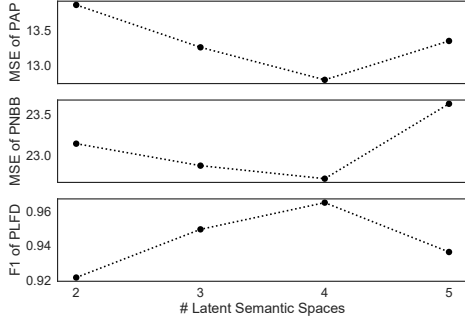

Fig. 11. Performance of HUBS with respect to # latent semantic spaces.

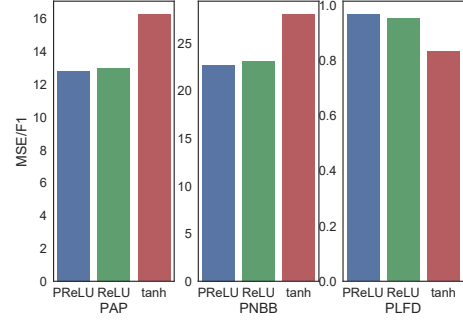

Fig. 13. Performance of HUBS with respect to different activation functions.

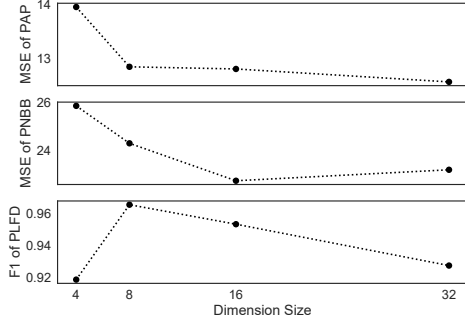

Fig. 12. Performance of HUBS with respect to the dimension size of each space.

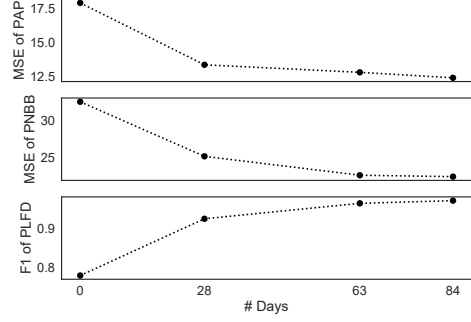

Fig. 14. Performance of HUBS with respect to # days.

for the PAP and PNBB tasks. When the dimension size is 16, the performance on the PLFD task drops heavily. Thus, we set the dimension size to 8 for the PLFD task.

Effect of Activation Functions. We investigate the influence of the activation functions on the proposed model. We replace PReLU with ReLU or tanh in Equation (16), (18), and (19). Figure 13 shows the results. We can see that PReLU is most suitable while tanh performs the worst.

Effect of the Number of Days. We also study the relationship between the number of days and MSE to choose the proper time for making predictions. The result is shown in Figure 14. When the number changes from 0 to 84 (i.e., 12 weeks), the performance of the model becomes better. Such a phenomenon is quite normal since a long sequence contributes to more complete information. However, the improvement is limited when the number changes from 63 (i.e., 9 weeks) to 84. Large N may lead to heavy computational costs at the same time. Thus, we set $N = 63$ in our experiments, thinking that making predictions after the first half of the semester is appropriate.

6 DISCUSSION

We discuss the extensibility and the efficiency of our model in this section. In addition, we discuss the complexity for users to get started with HUBS and the effect of the training sample size.

6.1 Model Extensibility

We would like to note that our proposed model is a general model in the sense that it is able to model heterogeneous

behaviors. $B_{m,n}$ denotes the discrete state of the m -th behavior type at the n -th period, and the model can be generalized to model user behaviors that can be represented by discrete states. c_n denotes multi-dimension context information. Context information that is with the discrete state $B_{m,n}$ can be included in c_n . As a result, our proposed model can be extended to many other areas.

To show the extensibility of our model, we utilize another larger dataset and we have another prediction task. The dataset, PaymentDataset, contains user payment records of 10,952 users in a community of a big company from 10/01/2016 to 06/30/2017 (i.e., three quarters) collected by a finance organization. Each record contains user identification, store identification, store category, payment time, and payment amount (USD). This dataset is utilized to predict the payment amount in a quarter ahead of time [1]. There are two categories of stores: restaurant and supermarket. Thus, the number of support behavior types besides the social behavior type is 2 (i.e., $M = 2$). A quarter consists of around 90 days. Thus, $N = \frac{90}{2} = 45$ in our experiments. There are 4,315,650 payment records for dining in the restaurant, and there are 1,155,395 payment records for shopping in the supermarket. The users' demographic information and historical quarterly payment amount are also available. We consider weather conditions and meta-data (day of week) as context data. Similar to the way to generate behavior feature vectors for PLFD task, we can get $B_{m,n}$ ($1 \leq m \leq M, 1 \leq n \leq N$) based on payment records. Based on payment records for dining in the restaurant, we can infer whether two users are friends. The records of the first two quarters are used for training and the records of

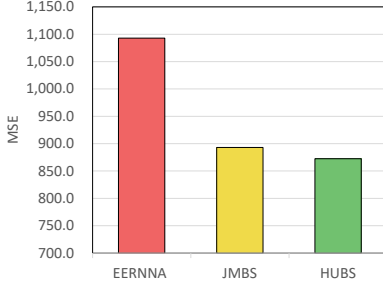

Fig. 15. Comparison of competitive baselines on PaymentDataset for predicting the payment amount.

the last quarter are used for testing.

We present the optimal settings of our model as follows. The total number of neurons in the dense embedding layer is 30. The dimensions of the hidden states in the context-aware LSTMs which handle dining behaviors and shopping behaviors are 4 and 4, respectively. The number of latent semantic spaces is 4 (i.e., $L = 4$). The dimension size of each latent semantic space is 8. The dimension of the hidden state in the dynamic LSTM which handles the historical observation sequence is 5. The dimensions of S , \bar{S} are 16 and 8, respectively. The residual network contains 2 ResBlocks (i.e., $\Lambda = 2$) and each FC layer which exists in the ResBlock contains 100 neurons. The dropout rate is 0.4.

We select some competitive baselines to compare. The results are shown in Figure 15. We can see that our model still works and performs best.

6.2 Model Efficiency

We then analyze the computation complexity of our model. The computational complexity of context-aware LSTMs is $O(MNd^2)$, where d is the representation dimension. The computational complexity of the projection mechanism is $O(MNLd^2)$. The computational complexity of the multifaceted attention mechanism is $O(NLd^2)$. The computational complexity of the decoder is $O(\Lambda d^2)$. Therefore, the total computation complexity of our model is $O(MNd^2 + MNLd^2 + NLd^2 + \Lambda d^2)$. The computation complexity of JMBS is $O(MNd^2 + Nd^2 + \Lambda d^2)$. The computation complexity of DAPAMT is $O(MNd^2 + Nd^2 + \Upsilon(Zd^2 + Z^2d))$, where Z is the number of tasks and Υ is the number of Multi-task Interaction Units. In our experiments, $N > d$, $N \gg M$, $N \gg L$, $N \gg \Lambda$, $N \gg Z$, and $N \gg \Upsilon$. Thus, the total computation complexity of our model, JMBS, and DAPAMT can be written as $O(MNLd^2)$, $O(MNd^2)$, and $O(MNd^2)$, respectively. L is not large (less than 5 in our cases), hence the time complexity for learning HUBS is acceptable compared with other state-of-the-art models. Besides, M is either not large (less than 5 in our cases). Compared with simple machine learning algorithms (e.g., MLP, GBDT), HUBS can extract features automatically from daily behavior sequences, thus the time of manual feature extraction is reduced. In fact, the manual feature extraction not only is time-consuming but also requires significant domain knowledge.

We further record the running time per epoch. Experiments are run on a CPU server with 4 cores (Intel Xeon

TABLE 4
Running time comparison.

Methods	PAP	PNBB
	Time (s)	Time (s)
APAMT	12.52	
DAPAMT	12.54	
JMBS	12.51	12.51
HUBS	13.17	12.89

Gold 6278c @ 2.60GHz). The batch size is fixed at 32 for all methods. The results are shown in Table 4. Although the efficiency of HUBS is slightly worse than competitive baselines, the performance of HUBS is obviously better. Moreover, our model is more suitable for behavioral prediction with lower response time requirements.

6.3 Complexity for Users to Get Started with HUBS

It is easy for users to get started with HUBS. Because there are not too many hyper-parameters and some hyper-parameters do not need to be tuned (These hyper-parameters keep the same setting on multiple tasks.).

Based on four behavior prediction tasks (i.e., predicting academic performance, predicting the number of borrowed books, predicting the level of financial difficulty, and predicting the payment amount), we find the number of ResBlocks should be set to 2 and each FC layer which exists in the ResBlock should contain 100 neurons. PReLU is the most suitable activation function in Equation (16), (18), and (19). Making predictions after the first half of the semester/quarter is appropriate. The dimension of the social influence representation should be set to 16. Four latent semantic spaces (i.e., facets) may work well. Besides, it is worth noting that the threshold for removing the effect of random cases is not a hyper-parameter. We can know its value from data. We think users who want to tune hyper-parameters can pay attention to the dimension size of each latent semantic space. If they are not satisfied with the performance of HUBS, they may change the number of latent semantic spaces.

6.4 Effect of the Training Sample Size

As described in Section 5.4, there are $10000 \times 90\% = 9000$ training samples and 9000 testing samples on Dataset1; there are $8005 \times 90\% \approx 7205$ training samples and 8005 testing samples on Dataset2. We select some state-of-the-art models to analyze how the training sample size affects the performance of models. We randomly select $\frac{1}{4}$ training samples, $\frac{1}{2}$ training samples, and $\frac{3}{4}$ training samples to train models.

Figure 16(a) and (b) show the results on PAP and PNBB tasks, respectively. We can see that more training samples lead to better performance of models. Such a phenomenon is normal. Models are data-driven. More training samples will train models better. Besides, it is very hard to predict unseen users' behaviors (i.e., the user cold-start problem). We can also see that the performance of HUBS is a little poorer than JMBS and the performance of DAPAMT is a little poorer than APAMT when training samples are not sufficient. We think that is because HUBS and DAPAMT

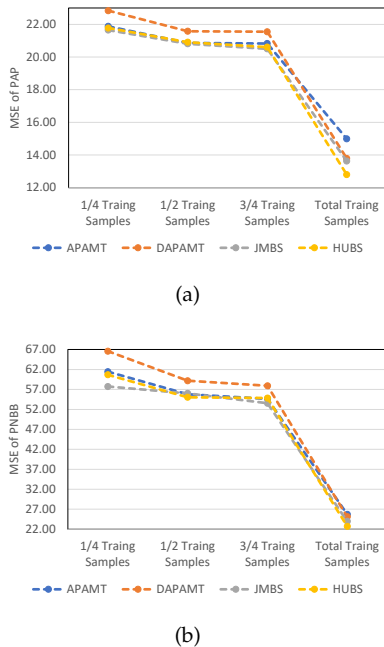

Fig. 16. Performance of models with respect to the the training sample size.

have more parameters to learn compared with JMBS and APAMT, respectively.

7 ETHICAL CONSIDERATIONS

It is crucial to consider ethical implications. Three aspects [69] are involved in this ethical analysis: the types of data; who will be accessing the data; and for what purpose. We explore these questions.

For the types of data, the datasets used in our work have been processed and fully anonymous. User names are removed. For those who have access to the data, the data used in our work are not released for public access. Only after privacy concerns are cleared, will the data be used for other research purposes. In applications of our prediction model, we stress that prediction results should be constrained in a small group of official staff. For the purpose of this work, we would like to stress that the use of data and predicted results should be constrained for the purpose of user management only, not for general public access. This work has been approved by the Institutional Review Board (IRB).

8 CONCLUSION

In this paper, we propose a general deep neural network called HUBS. HUBS can jointly model heterogeneous behaviors and social influences for predictive analysis. We design a projection mechanism for modeling multi-faceted relationships among multiple types of behaviors in a fine-grained way. We design a multi-faceted attention mechanism for dynamically discovering informative periods from different facets. Experiments and analyses have demonstrated the effectiveness, extensibility, and efficiency of our model.

ACKNOWLEDGEMENTS

We thank the anonymous reviewers for carefully reviewing and useful suggestions. This research is supported in part by the 2030 National Key AI Program of China 2018AAA0100503, National Science Foundation of China (No. 62072304, No. 61772341, No. 61832013, No. 62172277, No. 62172275), Shanghai Municipal Science and Technology Commission (No. 19510760500, No. 21511104700, No. 19511120300), the Oceanic Interdisciplinary Program of Shanghai Jiao Tong University (No. SL2020MS032), Scientific Research Fund of Second Institute of Oceanography, the open fund of State Key Laboratory of Satellite Ocean Environment Dynamics, Second Institute of Oceanography, MNR, GE China, and Zhejiang Aoxin Co. Ltd.

REFERENCES

- [1] Yu Ting Wen, Pei-Wen Yeh, Tzu-Hao Tsai, Wen-Chih Peng, and Hong-Han Shuai. Customer purchase behavior prediction from payment datasets. In *ACM International Conference on Web Search and Data Mining*, pages 628–636, 2018.
- [2] Charles Chen, Sungchul Kim, Hung Bui, Ryan Rossi, Eunye Koh, Branislav Kveton, and Razvan Bunescu. Predictive analysis by leveraging temporal user behavior and user embeddings. In *ACM International Conference on Information and Knowledge Management*, pages 2175–2182, 2018.
- [3] Wen Wang, Wei Zhang, Shukai Liu, Qi Liu, Bo Zhang, Leyu Lin, and Hongyuan Zha. Beyond clicks: Modeling multi-relational item graph for session-based target behavior prediction. In *Proceedings of the International Conference on World Wide Web*, pages 3056–3062, 2020.
- [4] Haomin Wen, Youfang Lin, Fan Wu, Huaiyu Wan, Shengnan Guo, Lixia Wu, Chao Song, and Yinghui Xu. Package pick-up route prediction via modeling couriers’ spatial-temporal behaviors. In *Proceedings of the International Conference on Data Engineering*, pages 2141–2146, 2021.
- [5] Jie Xu, Yuli Han, Daniel Marcu, and Mihaela Van Der Schaar. Progressive prediction of student performance in college programs. In *Proceedings of the AAAI Conference on Artificial Intelligence*, pages 1604–1610, 2017.
- [6] Tong Chen, Hongzhi Yin, Hongxu Chen, Rui Yan, Quoc Viet Hung Nguyen, and Xue Li. Air: Attentional intention-aware recommender systems. In *Proceedings of the International Conference on Data Engineering*, pages 304–315, 2019.
- [7] Robert B Cialdini and Noah J Goldstein. Social influence: Compliance and conformity. *Annual Review of Psychology*, 55:591–621, 2004.
- [8] Jie Tang, Jimeng Sun, Chi Wang, and Zi Yang. Social influence analysis in large-scale networks. In *ACM SIGKDD International Conference on Knowledge Discovery and Data Mining*, pages 807–816, 2009.
- [9] Rui Wang, Gabriella Harari, Peilin Hao, Xia Zhou, and Andrew T Campbell. Smartgpa: How smartphones can assess and predict academic performance of college students. In *ACM International Joint Conference on Pervasive and Ubiquitous Computing*, pages 295–306, 2015.
- [10] Wenqi Fan, Yao Ma, Qing Li, Jianping Wang, Guoyong Cai, Jiliang Tang, and Dawei Yin. A graph neural network framework for social recommendations. *IEEE Transactions on Knowledge and Data Engineering*, 34(5):2033–2047, 2022.
- [11] Byung-Hak Kim, Ethan Vizitei, and Varun Ganapathi. Gritnet: Student performance prediction with deep learning. In *International Conference on Educational Data Mining*, 2018.
- [12] Meizi Zhou, Zhuoye Ding, Jiliang Tang, and Dawei Yin. Micro behaviors: A new perspective in e-commerce recommender systems. In *ACM International Conference on Web Search and Data Mining*, pages 727–735, 2018.
- [13] Md Mehrab Tanjim, Congzhe Su, Ethan Benjamin, Diane Hu, Liangjie Hong, and Julian McAuley. Attentive sequential models of latent intent for next item recommendation. In *Proceedings of the International Conference on World Wide Web*, pages 2528–2534, 2020.

- [14] Mei Tian. Application of chaotic time series prediction in forecasting of library borrowing flow. In *International Conference on Internet Computing and Information Services*, pages 557–559, 2011.
- [15] Runhua Wang, Yi Tang, and Lei Li. Application of bp neural network to prediction of library circulation. In *International Conference on Cognitive Informatics and Cognitive Computing*, pages 420–423, 2012.
- [16] Chu Guan, Xinjiang Lu, Xiaolin Li, Enhong Chen, Wenjun Zhou, and Hui Xiong. Discovery of college students in financial hardship. In *IEEE International Conference on Data Mining*, pages 141–150, 2015.
- [17] Han-Jia Ye, De-Chuan Zhan, Xiaolin Li, Zhen-Chuan Huang, and Yuan Jiang. College student scholarships and subsidies granting: A multi-modal multi-label approach. In *IEEE International Conference on Data Mining*, pages 559–568, 2016.
- [18] Haobing Liu, Yanmin Zhu, Tianzi Zang, Jiadi Yu, and Haibin Cai. Jointly modeling individual student behaviors and social influence for prediction tasks. In *ACM International Conference on Information and Knowledge Management*, pages 865–874, 2020.
- [19] Yehuda Koren, Robert Bell, and Chris Volinsky. Matrix factorization techniques for recommender systems. *Computer*, 42(8):30–37, 2009.
- [20] Steffen Rendle. Factorization machines. In *IEEE International Conference on Data Mining*, pages 995–1000. IEEE, 2010.
- [21] Mack Sweeney, Jaime Lester, and Huzefa Rangwala. Next-term student grade prediction. In *IEEE International Conference on Big Data*, pages 970–975, 2015.
- [22] Xiangnan He, Lizi Liao, Hanwang Zhang, Liqiang Nie, Xia Hu, and Tat-Seng Chua. Neural collaborative filtering. In *Proceedings of the International Conference on World Wide Web*, pages 173–182, 2017.
- [23] Xiangnan He and Tat-Seng Chua. Neural factorization machines for sparse predictive analytics. In *Proceedings of the International ACM SIGIR conference on Research and Development in Information Retrieval*, pages 355–364, 2017.
- [24] Guorui Zhou, Xiaoqiang Zhu, Chenru Song, Ying Fan, Han Zhu, Xiao Ma, Yanghui Yan, Junqi Jin, Han Li, and Kun Gai. Deep interest network for click-through rate prediction. In *ACM SIGKDD International Conference on Knowledge Discovery and Data Mining*, pages 1059–1068, 2018.
- [25] Xiang Wang, Xiangnan He, Meng Wang, Fuli Feng, and Tat-Seng Chua. Neural graph collaborative filtering. In *Proceedings of the International ACM SIGIR conference on Research and Development in Information Retrieval*, pages 165–174, 2019.
- [26] Siyong Xu, Cheng Yang, Chuan Shi, Yuan Fang, Yuxin Guo, Tianchi Yang, Luhao Zhang, and Maodi Hu. Topic-aware heterogeneous graph neural network for link prediction. In *ACM International Conference on Information and Knowledge Management*, pages 2261–2270, 2021.
- [27] Steffen Rendle, Christoph Freudenthaler, and Lars Schmidt-Thieme. Factorizing personalized markov chains for next-basket recommendation. In *Proceedings of the International Conference on World Wide Web*, pages 811–820, 2010.
- [28] Ruining He, Wang-Cheng Kang, and Julian McAuley. Translation-based recommendation. In *ACM Conference on Recommender Systems*, pages 161–169, 2017.
- [29] Sepp Hochreiter and Jürgen Schmidhuber. Long short-term memory. *Neural Computation*, 9(8):1735–1780, 1997.
- [30] Junyoung Chung, Caglar Gulcehre, KyungHyun Cho, and Yoshua Bengio. Empirical evaluation of gated recurrent neural networks on sequence modeling. *arXiv preprint arXiv:1412.3555*, 2014.
- [31] Balázs Hidasi, Alexandros Karatzoglou, Linas Baltrunas, and Domonkos Tikk. Session-based recommendations with recurrent neural networks. In *International Conference on Learning Representations*, 2016.
- [32] Yu Su, Qingwen Liu, Qi Liu, Zhenya Huang, Yu Yin, Enhong Chen, Chris Ding, Si Wei, and Guoping Hu. Exercise-enhanced sequential modeling for student performance prediction. In *Proceedings of the AAAI Conference on Artificial Intelligence*, pages 2435–2443, 2018.
- [33] Yu Zhu, Hao Li, Yikang Liao, Beidou Wang, Ziyu Guan, Haifeng Liu, and Deng Cai. What to do next: Modeling user behaviors by time-1stm. In *Proceedings of the International Joint Conference on Artificial Intelligence*, pages 3602–3608, 2017.
- [34] Jiayi Tang and Ke Wang. Personalized top-n sequential recommendation via convolutional sequence embedding. In *ACM International Conference on Web Search and Data Mining*, pages 565–573, 2018.
- [35] Ashish Vaswani, Noam Shazeer, Niki Parmar, Jakob Uszkoreit, Llion Jones, Aidan N Gomez, Lukasz Kaiser, and Illia Polosukhin. Attention is all you need. In *Advances in Neural Information Processing Systems*, pages 5998–6008, 2017.
- [36] Wang-Cheng Kang and Julian McAuley. Self-attentive sequential recommendation. In *IEEE International Conference on Data Mining*, pages 197–206, 2018.
- [37] Chunyang Wang, Yanmin Zhu, Haobing Liu, Wenze Ma, Tianzi Zang, and Jiadi Yu. Enhancing user interest modeling with knowledge-enriched itemsets for sequential recommendation. In *ACM International Conference on Information and Knowledge Management*, pages 1889–1898, 2021.
- [38] Ruihong Qiu, Zi Huang, Tong Chen, and Hongzhi Yin. Exploiting positional information for session-based recommendation. *ACM Transactions on Information Systems*, 40(2):35:1–35:24, 2022.
- [39] Shu Wu, Yuyuan Tang, Yanqiao Zhu, Liang Wang, Xing Xie, and Tieniu Tan. Session-based recommendation with graph neural networks. In *Proceedings of the AAAI Conference on Artificial Intelligence*, pages 346–353, 2019.
- [40] Ziwei Fan, Zhiwei Liu, Jiawei Zhang, Yun Xiong, Lei Zheng, and Philip S. Yu. Continuous-time sequential recommendation with temporal graph collaborative transformer. In *ACM International Conference on Information and Knowledge Management*, pages 433–442, 2021.
- [41] Zhe Zhao, Zhiyuan Cheng, Lichan Hong, and Ed H Chi. Improving user topic interest profiles by behavior factorization. In *Proceedings of the International Conference on World Wide Web*, pages 1406–1416, 2015.
- [42] Huihuai Qiu, Yun Liu, Guibing Guo, Zhu Sun, Jie Zhang, and Hai Thanh Nguyen. Bprh: Bayesian personalized ranking for heterogeneous implicit feedback. *Information Sciences*, 453:80–98, 2018.
- [43] Steffen Rendle, Christoph Freudenthaler, Zeno Gantner, and Lars Schmidt-Thieme. Bpr: Bayesian personalized ranking from implicit feedback. In *Proceedings of the Conference on Uncertainty in Artificial Intelligence*, pages 452–461, 2009.
- [44] Ogtongsetseg Sukhbaatar, Tsuyoshi Usagawa, and Lodoiravsal Choimaa. An artificial neural network based early prediction of failure-prone students in blended learning course. *International Journal of Emerging Technologies in Learning*, 14(19):77–92, 2019.
- [45] Chen Gao, Xiangnan He, Danhua Gan, Xiangning Chen, Fuli Feng, Yong Li, Tat-Seng Chua, Lina Yao, Yang Song, and Depeng Jin. Learning to recommend with multiple cascading behaviors. *IEEE Transactions on Knowledge and Data Engineering*, 33(6):2588–2601, 2021.
- [46] Bowen Jin, Chen Gao, Xiangnan He, Depeng Jin, and Yong Li. Multi-behavior recommendation with graph convolutional networks. In *Proceedings of the International ACM SIGIR conference on Research and Development in Information Retrieval*, pages 659–668, 2020.
- [47] Chong Chen, Weizhi Ma, Min Zhang, Zhaowei Wang, Xiuqiang He, Chenyang Wang, Yiqun Liu, and Shaoping Ma. Graph heterogeneous multi-relational recommendation. In *Proceedings of the AAAI Conference on Artificial Intelligence*, pages 3958–3966, 2021.
- [48] Weifeng Zhang, Jingwen Mao, Yi Cao, and Congfu Xu. Multiplex graph neural networks for multi-behavior recommendation. In *ACM International Conference on Information and Knowledge Management*, pages 2313–2316, 2020.
- [49] Junwei Li, Le Wu, Richang Hong, and Jinkui Hou. Random walk based distributed representation learning and prediction on social networking services. *Information Sciences*, 549:328–346, 2021.
- [50] Mi Fei and Dit-Yan Yeung. Temporal models for predicting student dropout in massive open online courses. In *IEEE International Conference on Data Mining Workshop*, pages 256–263, 2015.
- [51] Chang Zhou, Jinze Bai, Junshuai Song, Xiaofei Liu, Zhengchao Zhao, Xiusi Chen, and Jun Gao. Atrank: An attention-based user behavior modeling framework for recommendation. In *Proceedings of the AAAI Conference on Artificial Intelligence*, pages 4564–4571, 2018.
- [52] Haobing Liu, Yanmin Zhu, and Yanan Xu. Learning from heterogeneous student behaviors for multiple prediction tasks. In *International Conference on Database Systems for Advanced Applications, Part II*, pages 297–313. Springer, 2020.
- [53] Haobing Liu, Yanmin Zhu, Tianzi Zang, Yanan Xu, Jiadi Yu, and Feilong Tang. Jointly modeling heterogeneous student behaviors and interactions among multiple prediction tasks. *ACM Transactions on Knowledge Discovery from Data*, 16(1):16:1–16:24, 2022.

- [54] Yiqing Wu, Ruobing Xie, Yongchun Zhu, Xiang Ao, Xin Chen, Xu Zhang, Fuzhen Zhuang, Leyu Lin, and Qing He. Multi-view multi-behavior contrastive learning in recommendation. In *Database Systems for Advanced Applications, Part II*, 2022.
- [55] Wenjuan Luo, Han Zhang, Xiaodi Yang, Lin Bo, Xiaoqing Yang, Zang Li, Xiaohu Qie, and Jieping Ye. Dynamic heterogeneous graph neural network for real-time event prediction. In *ACM SIGKDD International Conference on Knowledge Discovery and Data Mining*, pages 3213–3223, 2020.
- [56] Zhouhan Lin, Minwei Feng, Cicero Nogueira dos Santos, Mo Yu, Bing Xiang, Bowen Zhou, and Yoshua Bengio. A structured self-attentive sentence embedding. In *International Conference on Learning Representations*, 2017.
- [57] David J Crandall, Lars Backstrom, Dan Cosley, Siddharth Suri, Daniel Huttenlocher, and Jon Kleinberg. Inferring social ties from geographic coincidences. *Proceedings of the National Academy of Sciences*, 107(52):22436–22441, 2010.
- [58] Huaxiu Yao, Min Nie, Han Su, Hu Xia, and Defu Lian. Predicting academic performance via semi-supervised learning with constructed campus social network. In *International Conference on Database Systems for Advanced Applications*, pages 597–609, 2017.
- [59] Daixin Wang, Peng Cui, and Wenwu Zhu. Structural deep network embedding. In *ACM SIGKDD International Conference on Knowledge Discovery and Data Mining*, pages 1225–1234, 2016.
- [60] William L Hamilton, Rex Ying, and Jure Leskovec. Inductive representation learning on large graphs. *Advances in Neural Information Processing Systems*, pages 1024–1034, 2017.
- [61] Jiezhong Qiu, Jian Tang, Hao Ma, Yuxiao Dong, Kuansan Wang, and Jie Tang. Deepinf: Social influence prediction with deep learning. In *ACM SIGKDD International Conference on Knowledge Discovery and Data Mining*, pages 2110–2119, 2018.
- [62] Kaiming He, Xiangyu Zhang, Shaoqing Ren, and Jian Sun. Delving deep into rectifiers: Surpassing human-level performance on imagenet classification. In *Proceedings of the IEEE International Conference on Computer Vision*, pages 1026–1034, 2015.
- [63] Kaiming He, Xiangyu Zhang, Shaoqing Ren, and Jian Sun. Deep residual learning for image recognition. In *Proceedings of the IEEE Conference on Computer Vision and Pattern Recognition*, pages 770–778, 2016.
- [64] Kaiming He, Xiangyu Zhang, Shaoqing Ren, and Jian Sun. Identity mappings in deep residual networks. In *European Conference on Computer Vision*, pages 630–645, 2016.
- [65] Tsung-Yi Lin, Priya Goyal, Ross Girshick, Kaiming He, and Piotr Dollár. Focal loss for dense object detection. In *Proceedings of the IEEE International Conference on Computer Vision*, pages 2980–2988, 2017.
- [66] Nitish Srivastava, Geoffrey Hinton, Alex Krizhevsky, Ilya Sutskever, and Ruslan Salakhutdinov. Dropout: A simple way to prevent neural networks from overfitting. *Journal of Machine Learning Research*, 15(1):1929–1958, 2014.
- [67] Diederik P Kingma and Jimmy Ba. Adam: A method for stochastic optimization. In *International Conference on Learning Representations*, 2015.
- [68] Zichao Yang, Diyi Yang, Chris Dyer, Xiaodong He, Alex Smola, and Eduard Hovy. Hierarchical attention networks for document classification. In *The Annual Conference of the North American Chapter of the Association for Computational Linguistics*, pages 1480–1489, 2016.
- [69] W Nicholson Price and I Glenn Cohen. Privacy in the age of medical big data. *Nature Medicine*, 25(1):37–43, 2019.