

# TrafficFlowGAN: Physics-informed Flow based Generative Adversarial Network for Uncertainty Quantification

Zhaobin Mo, Yongjie Fu, Daran Xu, Xuan Di

**Abstract.** This paper proposes the TrafficFlowGAN, a physics-informed flow based generative adversarial network (GAN), for uncertainty quantification (UQ) of dynamical systems. TrafficFlowGAN adopts a normalizing flow model as the generator to explicitly estimate the data likelihood. This flow model is trained to maximize the data likelihood and to generate synthetic data that can fool a convolutional discriminator. We further regularize this training process using prior physics information, so-called physics informed deep learning (PIDL). To the best of our knowledge, we are the first to propose an integration of flow, GAN and PIDL for the UQ problems. We take the traffic state estimation (TSE), which aims to estimate the traffic variables (e.g. traffic density and velocity) using partially observed data, as an example to demonstrate the performance of our proposed model. We conduct numerical experiments where the proposed model is applied to learn the solutions of stochastic differential equations. The results demonstrate the robustness and accuracy of the proposed model, together with the ability to learn a machine learning surrogate model. We also test it on a real-world dataset, the Next Generation SIMulation (NGSIM), to show that the proposed TrafficFlowGAN can outperform the baselines, including the pure flow model, the physics-informed flow model, and the flow based GAN model.

**Keywords:** Uncertainty Quantification (UQ) · Normalizing Flow · Generative Adversarial Networks (GAN) · Physics-informed Deep Learning (PIDL).

## 1 Introduction

Uncertainty quantification (UQ) of dynamical systems has gained growing popularity in recent years. There are various sources of uncertainty in dynamical systems, including model errors, measurement noise, inherent stochasticity in human behavior, and random initial or boundary conditions. Due to the existence of these uncertain factors, the primal task for UQ is to not only make a prediction but also quantify the confidence in such prediction.

The methods of UQ can be categorized into **physics-based** and **data-driven** methods. The physics-based method assumes that the observations are

---

Accepted by the 2022 European Conference on Machine Learning and Principles and Practice of Knowledge Discovery in Databases (ECML-PKDD'22)

generated by underlying physics represented by mathematics models, upon which filtering methods or Bayesian inference can be applied to propagate uncertainty. However, the physics-based methods suffer from limitations such as non-Gaussian likelihoods and high-dimensional posterior distributions [19].

The data-driven methods learn the distribution of data directly without making a prior assumption of underlying physics. Depending on whether the data likelihood is tractable, data-driven methods can be further categorized into **implicit** and **explicit** models. Implicit models, such as the generative adversarial networks (GAN) [7], make predictions without knowing the data likelihood or prediction distribution. Instead, these models aim to generate indistinguishable samples that can fool an adversarially trained discriminator (so-called adversarial training). Although this training scheme has stability and convergence issues, it is widely used as it generates high-quality samples [9]. In contrast, explicit models, such as normalizing flow [5], calculate the exact data likelihood and prediction distribution. Exact data likelihood is beneficial. First, likelihood-based training like maximum likelihood estimation (MLE) can be used to train the explicit model, which is more straightforward with less computation burden [6]. Second, adversarial training is prone to mode collapse [17], thus using explicit methods can mitigate this issue.

Leveraging the pros of both the implicit and explicit models, Flow-GAN, a combination of normalizing flow and GAN, is first introduced in [9]. Combining MLE and adversarial training, Flow-GAN can achieve both high data likelihood and good sample qualities. Flow-GAN has been applied to manifold learning [3] and image-to-image translation [8]. Little research has been documented that applies Flow-GAN to UQ problems.

In terms of computational cost, data-driven methods require a huge amount of data to learn the posterior distributions from high-dimensional random inputs. This computational issue becomes worse for Flow-GAN as it adopts two training schemes [16]. To improve training efficiency, there is a growing trend integrating the model-based model and the data-driven model together, namely, physics-informed deep learning (PIDL) [12]. Physics-informed GAN is the most widely-used physics-informed generative model, which has been applied to solving stochastic differential equations [18,19,4] and quantifying uncertainty in various domains [15,14]. In contrast, we only find one paper that applies PIDL to normalizing flow [10].

In this paper, we propose TrafficFlowGAN that leverages likelihood training, adversarial training, and PIDL for the UQ problems. To the best of our knowledge, we are the first to integrate these three methods for the UQ problems. Main contributions of this paper include:

- We propose a hybrid generative model, TrafficFlowGAN, combining normalizing flow and GAN to achieve both high likelihoods and good sample qualities and to avoid mode collapse.
- We incorporate physics information into the TrafficFlowGAN model for estimation accuracy and data efficiency, and use neural network surrogate

models to learn the inter-relations between the physics variables at the same time.

- We apply the TrafficFlowGAN model to learn solutions of second-order stochastic partial differential equations (PDEs), and demonstrate the performance of TrafficFlowGAN by applying it to a traffic state estimation (TSE) problem with real-world data.

The rest of this paper is organized as follows: Section 2 introduces the background and related work. Section 3 introduces the structure of TrafficFlowGAN for the UQ problems. Section 4 demonstrates how TrafficFlowGAN learns solutions of a PDE and the relations between physics variables using a neural network surrogate model. Section 5 demonstrates how TrafficFlowGAN characterizes uncertainty from the real-world data in the TSE problem, where two traffic models, i.e. the Aw–Rascle–Zhang (ARZ) [2] and the Lighthill-Whitham-Richards (LWR) [11] models, are used as the physics components. Section 6 concludes our work and projects future directions in this promising arena.

## 2 Background and Related Work

### 2.1 Normalizing flow

The flow model aims to learn an invertible function  $\mathbf{z} = f_\theta(\mathbf{u}) : \mathbb{R}^D \mapsto \mathbb{R}^D$ , where data  $\mathbf{u}$  is sampled from a distribution  $p_{\text{data}}(\mathbf{u})$  and  $\mathbf{z} \sim p_{\mathbf{z}}(\mathbf{z})$  is a random noise of the same dimension as the data. The data likelihood  $p_\theta(\mathbf{u})$  can be explicitly expressed by using the *change of variable formula*:

$$p_\theta(\mathbf{u}) = p_{\mathbf{z}}(\mathbf{z}) \left| \det \left( \frac{\partial f_\theta^{-1}(\mathbf{z})}{\partial \mathbf{z}} \right) \right|^{-1}. \quad (1)$$

To compute  $p_\theta(\mathbf{u})$ , it is nontrivial to choose a latent variable  $\mathbf{z}$  that has an easy form and to design the invertible function  $f_\theta$  so that the Jacobian determinant can be easily computed. A common selection of the latent variable  $\mathbf{z}$  is the standard Gaussian, i.e.  $p_{\mathbf{z}}(\mathbf{z}) \sim \mathcal{N}(0, \mathbf{I}_D)$ . To compute the Jacobian determinant, RealNVP [5] designs the invertible function  $f_\theta$  as an *affine coupling transformation* following the equations below:

$$f_\theta := \begin{cases} \mathbf{z}_{1:d} = \mathbf{u}_{1:d} \\ \mathbf{z}_{d+1:D} = \mathbf{u}_{d+1:D} \odot e^{k_\theta(\mathbf{u}_{1:d})} + b_\theta(\mathbf{u}_{1:d}) \end{cases}, \quad (2)$$

where  $\mathbf{u}$  and  $\mathbf{z}$  are split into two partitions at the  $d$ th elements. The *scale function*  $k_\theta$  and the *translation function*  $b_\theta$  are neural networks to be learned, which constitute the affine transformation of the partition  $\mathbf{u}_{d+1:D}$ .  $\odot$  is the Hadamard product or element-wise product. By this design of invertible function, the Jacobian determinant in Eq. 1 can be computed by

$$\left| \det \left( \frac{\partial f_\theta^{-1}(\mathbf{z})}{\partial \mathbf{z}} \right) \right|^{-1} = e^{\sum_j [k_\theta(\mathbf{z}_{1:d})]_j}, \quad (3)$$

where  $j$  is the index of the element of  $k_\theta(\mathbf{z}_{1:d})$ . The inverse function  $f_\theta^{-1}$  can also be obtained by

$$f_\theta^{-1} := \begin{cases} \mathbf{u}_{1:d} = \mathbf{z}_{1:d} \\ \mathbf{u}_{d+1:D} = (\mathbf{z}_{d+1:D} - b_\theta(\mathbf{z}_{1:d})) / e^{k_\theta(\mathbf{z}_{1:d})} \end{cases} \quad (4)$$

To better accommodate the complex data distribution,  $f_\theta$  is further modeled as a sequence of affine coupling transformations:  $f_\theta = f_L \circ \dots \circ f_1$ , where  $L$  is the total number of transformations. Let  $f_l$  be the  $l$ th invertible mapping and  $\mathbf{h}^{(l)}$  be the  $l$ th latent variable that satisfies  $\mathbf{h}^{(l)} = f_l(\mathbf{h}^{(l-1)})$ , where  $\mathbf{h}^{(0)} = \mathbf{u}$  and  $\mathbf{h}^{(L)} = \mathbf{z}$ . Then the log-likelihood of  $\mathbf{u}$  can be computed by:

$$\log p_\theta(\mathbf{u}) = \log p_{\mathbf{z}}(\mathbf{z}) + \sum_{l=0}^{L-1} \log \left| \det \left( \frac{\partial f_l^{-1}(\mathbf{h}^{(l)})}{\partial \mathbf{h}^{(l)}} \right) \right|^{-1} \quad (5)$$

The computation of the log-likelihood of  $\mathbf{z}$  is straightforward as  $\mathbf{z}$  is assumed to follow a standard Gaussian distribution, and each Jacobian determinant can be calculated following Eq. 3. Thus, the exact data likelihood is tractable and the flow model can be trained by the MLE.

## 2.2 Generative adversarial network (GAN)

GAN aims to train a generator  $G_\theta$  to learn the mapping from a random noise  $\mathbf{z}$  to the corresponding state variables  $\mathbf{u}$ , i.e.  $G_\theta : \mathbf{z} \rightarrow \mathbf{u}$ . The objective of the generator  $G_\theta$  is to fool an adversarially trained discriminator  $D_\phi$ . Different GAN variants use different metrics to evaluate the divergence between the prediction distribution and the data distribution, such as the Kullback-Leibler (KL) divergence, the Jensen-Shannon divergence, and the Wasserstein distance [1]. Among these metrics, the Wasserstein distance has received growing popularity for its stability, which optimizes the following objective:

$$\min_{\theta} \max_{\phi \in \mathcal{F}} \mathbb{E}_{p_{\text{data}}(\mathbf{u})} [D_\phi(\mathbf{u})] + \mathbb{E}_{p_{\mathbf{z}}(\mathbf{z})} [D_\phi(G_\theta(\mathbf{z}))], \quad (6)$$

where  $\theta$  and  $\phi$  are the parameters of the generator and the discriminator, respectively.  $\mathcal{F}$  is defined such that  $D_\phi$  is 1-Lipschitz.

## 3 Framework of TrafficFlowGAN

### 3.1 Problem statement

Define the spatial and temporal domains as  $\mathcal{X}$  and  $\mathcal{T}$ , respectively.  $(x, t) \in \mathcal{X} \times \mathcal{T}$  is the spatio-temporal coordinate (“coordinate” for short). It is assumed that the state variable  $\mathbf{u}$  can only be observed by limited number of sensors placed at fixed locations and at a specific frequency. Thus, we further define the *observed (labeled) region*  $O \subseteq \mathcal{X} \times \mathcal{T}$  as the spatio-temporal region where

the state variable  $\mathbf{u}$  is observed, and thereby the *unobserved (unlabeled) region*  $C = \mathcal{X} \times \mathcal{T} \setminus O$ . We represent the continuous domain in a discrete manner using grid points. Thus, the observed region  $O$  and the unobserved region  $C$  can be represented as collections of discrete coordinates:  $O = \{(x_o^{(i)}, t_o^{(i)}) | i = 1, \dots, N_o\}$  and  $C = \{(x_c^{(j)}, t_c^{(j)}) | j = 1, \dots, N_c\}$ , where  $i$  and  $j$  are the indices of observed and unobserved coordinates, respectively;  $N_o, N_c$  are the numbers of observed data and collocation states, respectively.

The state variable  $\mathbf{u}$  is a random variable for each coordinate, i.e.  $\mathbf{u} \sim p_{data}(\mathbf{u}|x, t)$ . Our goal is to train a generator such that its prediction distribution  $p_\theta(\hat{\mathbf{u}}|x, t)$  matches the data distribution  $\mathbf{u} \sim p_{data}(\mathbf{u}|x, t)$ . Below we will introduce how to achieve this goal with our proposed TrafficFlowGAN.

### 3.2 Overview of TrafficFlowGAN structure

An overview of TrafficFlowGAN is illustrated in Fig. 1, which consists of three main components, namely, a conditional flow  $f_\theta$ , a physics-based computational graph, and a convolutional discriminator  $D_\phi$ . The data is illustrated as a heatmap in the spatio-temporal domain. We assume the data is measured by sensors at fixed locations. Due to limited range each sensor can cover, the observation region consists of separate horizontal “strips.” The observed and unobserved coordinates are fed into the conditional flow model to generate predictions  $\hat{\mathbf{u}}_o$  and  $\hat{\mathbf{u}}_c$ , respectively. Those predictions bifurcate into two branches. In the upper branch,  $\hat{\mathbf{u}}_c$  are fed into a physics-based computational graph, which encodes physics laws, to calculate the physics loss function. This process of calculating physics loss from the unobserved coordinates is illustrated by grey arrows. In the lower branch, the prediction states  $\hat{\mathbf{u}}_o$  and the observed states  $\mathbf{u}_o$  are then reshaped to constitute the prediction matrix  $\hat{M}$  and the observation matrix  $M$ , respectively. These two matrices are then fed into the convolutional discriminator. The process of calculating the adversarial loss from observed coordinates and states is illustrated by blue arrows.

We will detail each component sequentially and explain how we integrate those components in the following subsections.

### 3.3 Convolutional Neural Network as the Discriminator

Existing physics-informed GAN models construct the discriminator as a *fully connected network*. By explicitly adding the spatio-temporal coordinates into the input space, the discriminator is expected to make decisions based on the *spatio-temporal pattern*, which will be represented better by the convolutional neural network (CNN). In this work, we propose to use CNN as the discriminator.

The discriminator  $D_\phi$  consists of a sequence of convolutional layers (Conv) followed by a fully connected layer (FC). This FC layer outputs a  $1 \times 1$  scalar indicating if the input matrix is from observations or predictions. The pooling layer is not used in this structure, as there is no requirement for compression in our task.

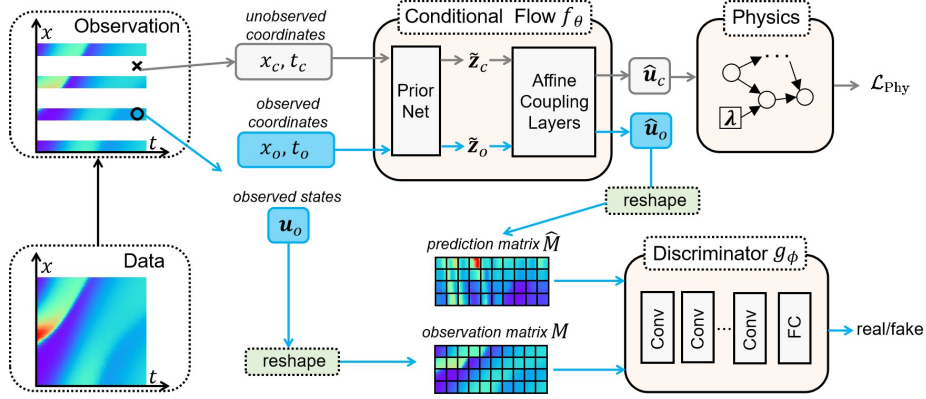

Fig. 1: Structure of the TrafficFlowGAN.

The reshape of the observation  $\mathbf{u}$  is straightforward. As we represent the spatio-temporal domain in a discrete manner,  $\mathbf{u}(x, t)$  for each coordinate can be viewed as a “pixel”, and the dimension of  $\mathbf{u}$  is its number of channels. This is the same for reshaping the prediction  $\hat{\mathbf{u}}$  to get the prediction matrix  $\hat{M}$ . Note that due to randomness in data and predictions, we can sample multiple observation matrices  $\{M^{(i)}\}_{i=1}^{N_\omega}$  and prediction matrices  $\{\hat{M}^{(i)}\}_{i=1}^{N_\omega}$ , where  $N_\omega$  is the total number of sampling.

The discriminator  $D_\phi$  can be updated by minimize the Wasserstein loss:

$$\mathcal{L}_D(\phi) = \frac{1}{N_\omega} \sum_{i=1}^{N_\omega} D_\phi(M^{(i)}) - D_\phi(\hat{M}^{(i)}). \quad (7)$$

### 3.4 Conditional Flow as the Generator

We construct a conditional flow as our generator, as illustrated in Fig. 2. Assume  $\mathbf{u}$  has two elements, i.e.  $u_1$  and  $u_2$ . Different from the tradition normalizing flow, we add a *prior network* (p-net) to transform the standard Gaussian prior  $\mathbf{z} = (z_1, z_2)$  to  $\tilde{\mathbf{z}} = (\tilde{z}_1, \tilde{z}_2)$  with shifting and scaling, considering that the magnitude of uncertainty for different  $(x, t)$  coordinates can be different. The prior network takes as input the coordinate  $(x, t)$  and outputs the prior mean  $\boldsymbol{\mu} = (\mu_1, \mu_2)$  and prior standard deviation  $\boldsymbol{\sigma} = (\sigma_1, \sigma_2)$ , and thus  $\tilde{\mathbf{z}} \sim \mathcal{N}(\boldsymbol{\mu}, \boldsymbol{\sigma})$ . The prior network is followed by affine coupling layers. Each affine coupling layer consists of a scale function (k-net) and a translation function (b-net), as introduced in Section 2.1.

Based on [20] and our experiment, the exponential operation in Eq. 2 is numerically unstable, which may result in gradient explosion. Instead of using the RealNVP, we replace the exponential operation in Eq. 2 with a Sigmoid operation:

$$f_\theta := \begin{cases} \tilde{\mathbf{z}}_{1:d} = \mathbf{u}_{1:d} \\ \tilde{\mathbf{z}}_{d+1:D} = \mathbf{u}_{d+1:D} \odot \text{Sigmoid}(k_\theta(\mathbf{u}_{1:d}; x, t)) + b_\theta(\mathbf{u}_{1:d}; x, t) \end{cases}, \quad (8)$$

and the calculation of Jacobian determinant in Eq. 5 is thus changed to

$$\left| \det \left( \frac{\partial f_\theta^{-1}(\tilde{\mathbf{z}})}{\partial \tilde{\mathbf{z}}} \right) \right|^{-1} = \sum_j [k_\theta(\tilde{\mathbf{z}}_{1:d}; x, t)]_j, \quad (9)$$

where  $j$  is the element index of  $k_\theta(\tilde{\mathbf{z}}_{1:d}; x, t)$ . We define a likelihood loss function for the generator as:

$$\begin{aligned} \mathcal{L}_{\text{NLL}}(\theta) &= \sum_{i=1}^{N_\omega} \sum_{(x_o, t_o) \in O} \log p_\theta(\mathbf{u} | x_o, t_o, \omega^{(i)}) \\ &= \sum_{i=1}^{N_\omega} \sum_{(x_o, t_o) \in O} \log p_{\tilde{\mathbf{z}}}(\tilde{\mathbf{z}} | x_o, t_o) + \sum_{l=0}^{L-1} \log \left| \det \left( \frac{\partial f_l^{-1}(\mathbf{h}^{(l)})}{\partial \mathbf{h}^{(l)}} \right) \right|^{-1}, \end{aligned} \quad (10)$$

which is the summation of negative log-likelihood (NLL) over all observed coordinates and random events.

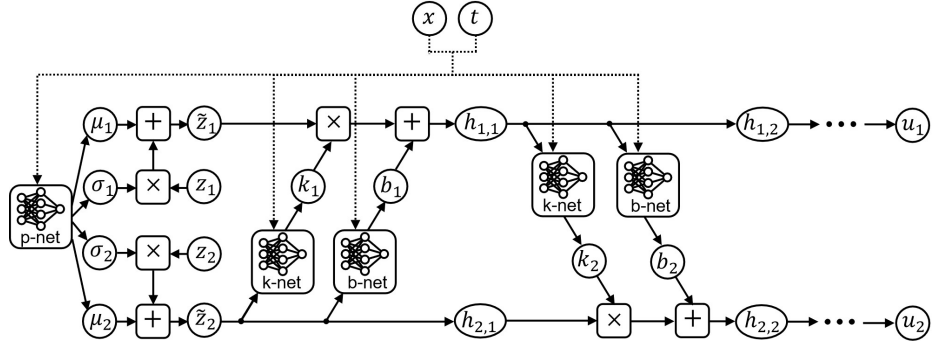

Fig. 2: Structure of the conditional flow with a prior network.

Apart from the likelihood loss  $\mathcal{L}_{\text{NLL}}$ , the flow generator  $f_\theta$  can also be trained with the discriminator  $D_\phi$  through adversarial training. The adversarial loss for the generator is depicted as:

$$\mathcal{L}_{\text{Adv}}(\theta) = \frac{1}{N_\omega} \sum_{i=1}^{N_\omega} D_\phi(\hat{M}^{(i)}), \quad (11)$$

which uses the Wasserstein objective defined in Eq. 6;  $\hat{M}$  is the prediction matrix and  $N_\omega$  is the total number of sampling.

Using the adversarial loss  $\mathcal{L}_{\text{Adv}}$  alone is prone to mode collapse. We demonstrate below how the likelihood loss  $\mathcal{L}_{\text{NLL}}$  can mitigate the mode collapse by one example. Suppose the data is generated from a mixture model of two Gaussian

distributions  $\mathcal{N}(-1, 1)$  and  $\mathcal{N}(1, 1)$ . By adversarial training, the generator may end up only generating one mode, say  $\mathcal{N}(-1, 1)$ . In this case, the discriminator cannot distinguish between the samples and the ground-truth. If the MLE is used, the likelihood of the missing mode is very low, resulting in a high overall NLL. Thus, the likelihood loss  $\mathcal{L}_{\text{NLL}}$  can guide the generator to leave the current local optimum.

### 3.5 Physics Regularization

The conditional flow model is further regularized by the physics-informed computational graph, which encodes physics prior knowledge like partial differential equations (PDE).

Suppose data follows laws that can be depicted as stochastic PDEs below:

$$\begin{aligned} \mathbf{u}_t(x, t; \omega) + \mathcal{N}_x[\mathbf{u}(x, t; \omega); \lambda(\omega)] &= \mathbf{0}, & (x, t) \in \mathcal{X} \times \mathcal{T}, \omega \in \Omega, \\ \mathcal{B}[\mathbf{u}(x, t; \omega)] &= \mathbf{0}, & (x, t) \in \partial\mathcal{X} \times \mathcal{T}, \\ \mathcal{I}[\mathbf{u}(x, 0; \omega)] &= \mathbf{0}, & x \in \mathcal{X}, \end{aligned} \quad (12)$$

where,  $\mathbf{u}_t$  is its partial derivative of  $\mathbf{u}$  with regard to  $t$ ;  $\partial\mathcal{X}$  is the boundary of the space domain  $\mathcal{X}$ ;  $\mathcal{N}_x$  is a non-linear differential operator;  $\mathcal{B}$  is a boundary condition operator;  $\mathcal{I}$  is an initial condition operator;  $\lambda$  is the parameters of the PDEs.  $\omega$  is a random event sampled from the probability space  $\Omega$ , which represents uncertainties residing in the PDE parameters or the boundary and initial conditions;

By encoding physics information, the physics-informed flow generator has an additional learning objective on the unobserved region  $C$ , which encourages the prediction of the generator to follow the physics defined by the PDE. The physics loss function is defined as:

$$\mathcal{L}_{\text{Phy}}(\theta, \lambda) = \mathbb{E}_{q(x_c, t_c)} \left| \mathbb{E}_{p_{\mathbf{z}}(\mathbf{z})} [\partial_t \hat{\mathbf{u}}_c + \mathcal{N}_x[\hat{\mathbf{u}}_c; \lambda]] \right|^2, \quad (13)$$

where  $\hat{\mathbf{u}}_c = f_{\theta}(x_c, t_c, \mathbf{z})$  is the prediction of the generator on the unobserved region. This physics loss function serves as a regularization term for the generator. If the flow generator  $f_{\theta}$  is well trained, the physics loss needs to be as close to zero as possible.

### 3.6 Training of TrafficFlowGAN

The loss function of the flow model is a weighted sum of the likelihood loss, adversarial loss, and physics loss:

$$\mathcal{L}_f(\theta) = \alpha \mathcal{L}_{\text{NLL}}(\theta) + \beta \mathcal{L}_{\text{Adv}}(\theta) + \gamma \mathcal{L}_{\text{Phy}}(\theta, \lambda), \quad (14)$$

where  $\alpha, \beta, \gamma \in (0, 1]$  are hyperparameters that determine the contribution of each loss component. With the generator loss  $\mathcal{L}_f(\theta)$ , the discriminator loss  $\mathcal{L}_D(\phi)$  defined in Eq. 7, and physics loss  $\mathcal{L}_{\text{Phy}}(\theta, \lambda)$  defined in Eq. 13, we are ready to introduce the training algorithm as shown in Algorithm 1.

**Algorithm 1** TrafficFlowGAN Training Algorithm.**Initialization:**

Initialized physics parameters  $\lambda^0$ ; Initialized networks parameters  $\theta^0, \phi^0$ ; Training iterations  $Iter$ ; Batch size  $m$ ; Learning rate  $lr$ ; Weights of loss functions  $\alpha, \beta$ , and  $\gamma$ .

**Input:** The observation data  $\{(x_o^{(i)}, t_o^{(i)}, \mathbf{u}_o^{(i)})\}_{i=1}^{N_o}$  and unobserved coordinates  $\{x_c^{(j)}, t_c^{(j)}\}_{j=1}^{N_c}$ .

- 1: **for**  $k \in \{0, \dots, Iter\}$  **do**
- 2: Sample batches  $\{(x_o^{(i)}, t_o^{(i)}, \mathbf{u}_o^{(i)})\}_{i=1}^m$  and  $\{x_c^{(j)}, t_c^{(j)}\}_{j=1}^m$  from the observation and unobserved coordinates, respectively  
// update the discriminator
- 3: Calculate  $\mathcal{L}_D$  by Eq. 7
- 4:  $\phi^{k+1} \leftarrow \phi^k - lr \cdot \text{Adam}(\phi^k, \nabla_{\phi} \mathcal{L}_D)$   
// update the generator
- 5: Calculate  $\mathcal{L}_{\text{NLL}}$  by Eq. 7,  $\mathcal{L}_{\text{Adv}}$  by Eq. 11, and  $\mathcal{L}_{\text{Phy}}$  by Eq. 18
- 6: Calculate  $\mathcal{L}_f$  by Eq. 14
- 7:  $\theta^{k+1} \leftarrow \theta^k - lr \cdot \text{Adam}(\theta^k, \nabla_{\theta} \mathcal{L}_f)$   
// update the physics
- 8:  $\lambda^{k+1} \leftarrow \lambda^k - lr \cdot \text{Adam}(\lambda^k, \nabla_{\lambda} \mathcal{L}_{\text{Phy}})$
- 9: **end for**

## 4 Numerical Experiment: Learning Solutions of A Known Second-order PDE

In this experiment, we apply TrafficFlowGAN to learn solutions of a known PDE and also to learn the relations of the PDE’s parameters.

### 4.1 Numerical data

The numerical data is generated from the ARZ model [2], which is a second-order PDE that is used to describe the traffic dynamics. It is depicted as

$$\begin{cases} \rho_t + (\rho u)_x = 0, \\ (u + h(\rho))_t + u(u + h(\rho))_x = (U_{eq}(\rho) - u)/\tau, \end{cases} \quad (15)$$

where,

$$h(\rho) = U_{eq}(0) - U_{eq}(\rho) \quad (16)$$

is the hesitation function and

$$U_{eq}(\rho) = u_{max}(1 - \rho/\rho_{max}) \quad (17)$$

is the equilibrium traffic velocity; traffic density  $\rho$  and traffic velocity  $u$  are the state variables, i.e.  $\mathbf{u} = (\rho, u)$ ;  $\tau$  is the relaxation parameter;  $\rho_{max}$  and  $u_{max}$  are the maximum traffic density and the maximum traffic velocity, respectively. In this experiment, we study a “ring road” in  $t \in [0, 3]$  and  $x \in [0, 1]$  with a boundary condition  $\mathbf{u}(0, t) = \mathbf{u}(1, t)$ . We set the parameters as  $\rho_{max} = 1.13$ ,

$u_{max} = 1.02$ , and  $\tau = 0.02$ . We set the initial conditions of  $\rho$  and  $u$  as bell-shaped functions shown in Fig. 3(a). The x-axis is the space domain, and the y-axis is the initial value of  $\rho$  (blue line) and  $u$  (red line). We solve Eq. 15 using the Lax-Friedrichs scheme on a spatio-temporal grid of sizes  $960 \times 240$ , and the solutions  $\rho(x, t)$  and  $u(x, t)$  are shown in Fig. 3(b) and Fig. 3(c), respectively. The dashed black lines indicate 4 locations where data is observed (the top and bottom dashed black lines indicate the same position as it is a ring road). We then add a white noise  $\epsilon \sim \mathcal{N}(0, 0.02)$  to the solution to represent the uncertainty.

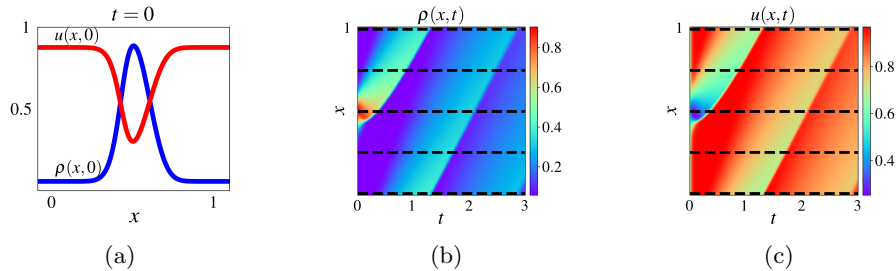

Fig. 3: Numerical data generator from the ARZ model. (a) is the bell-shaped initial  $\rho$  and  $u$  over  $x \in [0, 1]$ ; (b) and (c) are numerical solutions for  $\rho$  and  $u$ , respectively.

## 4.2 Physics-based computational graph

Fig. 4(b) illustrates the physics-based computational graph associated with the ARZ. We assume that the exact form of  $U_{eq}$  is unknown, and we use a *surrogate network* (s-net) to learn an approximate  $\hat{U}_{eq}$ . The corresponding physics loss for each line of Eq. 15 is as below:

$$\begin{cases} \mathcal{L}_{\text{ARZ}}^{(1)} = \left| \mathbb{E}_z [\hat{\rho}_t + (\hat{\rho}\hat{u})_x] \right|^2 \\ \mathcal{L}_{\text{ARZ}}^{(2)} = \left| \mathbb{E}_z \left[ (\hat{u} + h(\hat{\rho}))_t + \hat{u}(\hat{u} + h(\hat{\rho}))_x - (\hat{U}_{eq}(\hat{\rho}) - \hat{u})/\tau \right] \right|^2 \end{cases} \quad (18)$$

In implementation, derivatives with regard to  $x$  and  $t$  can be easily calculated by the Pytorch module `torch.autograd`.

Additionally, we add a *shape constraint* to regularize the s-net to be monotonically decreasing for the ARZ physics loss, given the domain knowledge that the equilibrium speed  $U_{eq}$  decreases as the density  $\rho$  increases. This shape constraint is depicted as follows:

$$\mathcal{L}_{\text{reg}} = \int_a^b \max \left( 0, \frac{\partial \hat{U}_{eq}(\rho)}{\partial \rho} \right) d\rho, \quad (19)$$

where hyperparameters  $a$  and  $b$  determine the interval where the shape constraint takes effect, e.g.  $a = 0$  and  $b = 1$  in this ring road experiment. Summarizing the loss terms defined in Eq. 18 and Eq. 19, the final physics loss can thus be written as:

$$\mathcal{L}_{\text{Phy}} = \beta \mathcal{L}_{\text{ARZ}}^{(1)} + (1 - \beta) \mathcal{L}_{\text{ARZ}}^{(2)} + \gamma \mathcal{L}_{\text{reg}}. \quad (20)$$

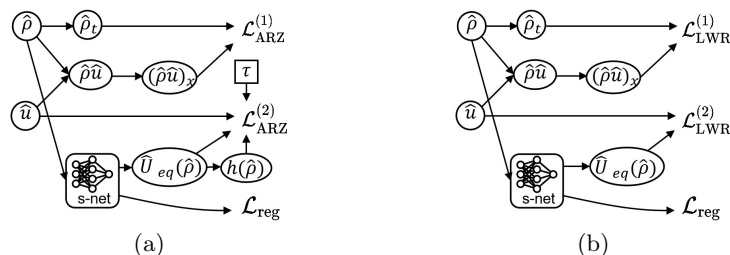

Fig. 4: Physics with surrogate models. (a) is the physics for ARZ and (b) is the physics for LWR, which will be introduced in Section 5.2.

### 4.3 Experiment setting

Experiments are conducted on a Google cloud workstation with 8 Intel Xeon E5-2686 v4 processors and an NVIDIA V100 Tensor Core GPU with 16 GB memory in Ubuntu 18.04.3. The learning rate for the Adam optimizer is 0.0005, and other configurations are kept as default. The configuration of the discriminator is different for different loop detectors, which are detailed in the supplementary materials.

### 4.4 Results

The results of the TrafficFlowGAN are shown in Fig. 5. Fig. 5(a) is the prediction of the traffic density. It demonstrate that the TrafficFlowGAN can reconstruct the traffic density with observations from 4 sensors. Two prediction snapshots at  $t = 0.078$  and  $t = 1.0$  shown in Fig. 5(b) and Fig. 5(c), respectively. The blue line stands for the mean of the ground-truth; the dashed red line represents the mean of the prediction, and the yellow band is the prediction interval. Fig. 5(d) illustrates the relation between traffic density and traffic velocity learned by the s-net, i.e.  $\hat{U}_{eq}(\hat{\rho})$ . The solid blue line is the ground-truth relation  $U_{eq}(\rho)$  that is defined in Eq. 15. The dashed black line and the dashed red line are the  $\hat{U}_{eq}(\hat{\rho})$  at the 1st and the 15000th epochs, respectively. We can see that s-net manages to recover the underlying traffic density-velocity relation. The reason for the relatively poor performance for  $\rho > 0.9$  is that the numerical data does not contain  $\rho$  that is bigger than 0.9, as indicated by the colorbar of Fig. 5(a).

## 5 Case Study: Traffic State Estimation

Traffic state estimation (TSE) is an important traffic engineering problem that aims to infer traffic state variables represented by traffic density and velocity along a road segment from partial observations. In a nutshell, the goal of TSE is to learn a mapping from a spatio-temporal domain to traffic states, i.e.  $f : (x, t) \rightarrow (\rho, u)$ , using partial observations from fixed sensors (e.g. loop detectors).

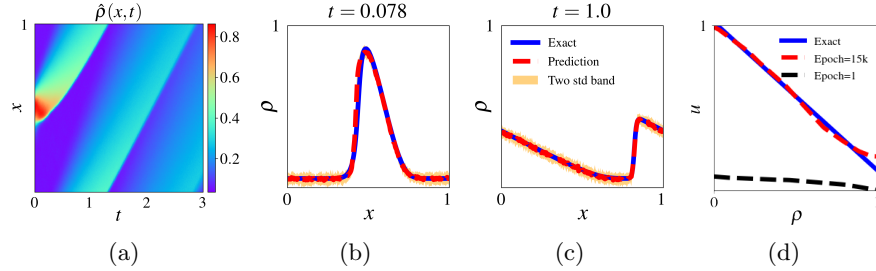

Fig. 5: Results of the TrafficFlowGAN on the numerical data generated by ARZ.

### 5.1 Dataset

The Next Generation SIMulation (NGSIM)<sup>1</sup> is a real-world dataset that collects vehicle trajectory every 0.1 seconds. We focus on a 15-minutes data fragments collected on highway US 101. The traffic density and velocity are shown in Fig. 6.

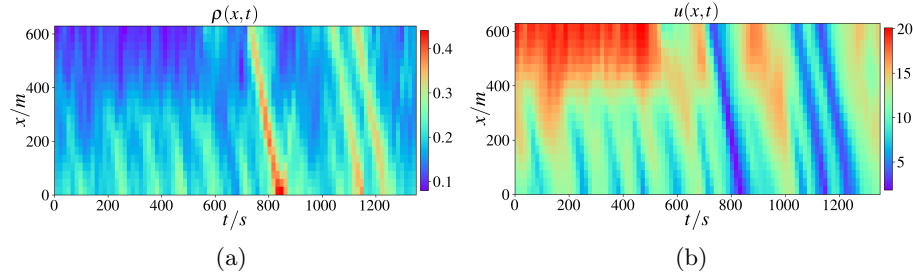

Fig. 6: NGSIM dataset, where (a) is the traffic density and (b) is the traffic velocity.

### 5.2 Physics-based computational graph

As the underlying physics for the real-world scenario is unknown, in addition to the ARZ, we also adopt the LWR model as our physics. LWR is depicted as below:

$$\begin{cases} \rho_t + (\rho u)_x = 0, \\ u = U_{eq}(\rho) \triangleq u_{max}(1 - \rho/\rho_{max}), \end{cases} \quad (21)$$

which shares the same physics parameters, i.e.  $\rho_{max}$  and  $u_{max}$ , as the ARZ. The physics computational graph associated with LWR is illustrated in Fig. 4(b). The corresponding physics losses are as below:

$$\begin{cases} \mathcal{L}_{LWR}^{(1)} = \left| \mathbb{E}_z [\hat{\rho}_t + (\hat{\rho}\hat{u})_x] \right|^2 \\ L_{LWR}^{(2)} = \left| \mathbb{E}_z [\hat{U}_{eq}(\hat{\rho}) - \hat{u}] \right|^2 \end{cases} \quad (22)$$

<sup>1</sup> [www.fhwa.dot.gov/publications/research/operations/07030/index.cfm](http://www.fhwa.dot.gov/publications/research/operations/07030/index.cfm)

### 5.3 Baselines and metrics

We adopt the following baselines for comparison: the pure flow model, the physics-informed flow with ARZ as the physics (PhysFlow-ARZ), the physics-informed flow with LWR as the physics (PhysFlow-LWR), FLOWGAN, and the ARZ based extended Kalman filter (EKF) [13]. EKF applies a non-linear version of the Kalman filter and is widely used in nonlinear systems like the TSE.

We use the  $L^2$  relative percentage error (RE) to measure the difference between the mean of the prediction and that of the ground-truth. The reason for choosing this metric is to mitigate the influence of the scale of the ground-truth. In addition, the reverse Kullback-Leibler (KL) divergence is used to measure the difference between the prediction distribution and the sample distribution.

### 5.4 Results

Fig. 7 shows the REs (left two) and KL divergences (right two) of traffic density  $\rho$  and velocity  $u$  of TrafficFlowGAN and the baselines. The x-axis is the number of loop detectors. Different scatter types and colors are used to distinguish with different models. From this figure, we can see that TrafficFlowGAN-LWR outperforms others across nearly all numbers of loop detectors for REs, and TrafficFlowGAN-ARZ achieves the best performance for KL divergences.

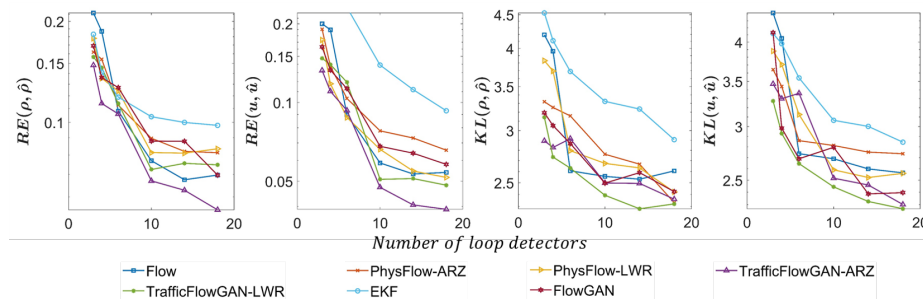

Fig. 7: The REs and KL of our proposed TrafficFlowGAN and the baselines.

Fig. 8 show the predictions of traffic density (top row) and traffic velocity (bottom row). Fig. 8(a) and Fig. 8(d) present the heatmaps of traffic density and traffic velocity in spatio-temporal space. Those two predictions are close to the ground-truth shown in Fig. 6. The other 4 subfigures show the snapshots of the prediction intervals of the traffic density and velocity.

Fig. 9 presents the comparison between the ground-truth traffic density distribution and that predicted by the TrafficFlowGAN model, each subfigure for a randomly sampled spatio-temporal coordinates. Most parts of the predicted and ground-truth distributions overlap with each other, which demonstrates that our proposed model can estimate the real-world traffic states uncertainties well.

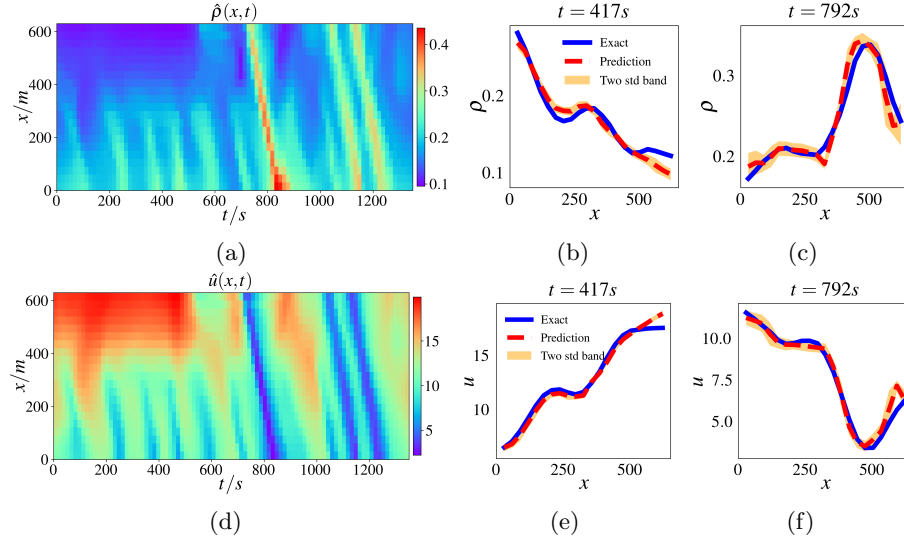

Fig. 8: Predictions of the traffic density (top row) and the traffic velocity (bottom row) of the TrafficFlowGAN.

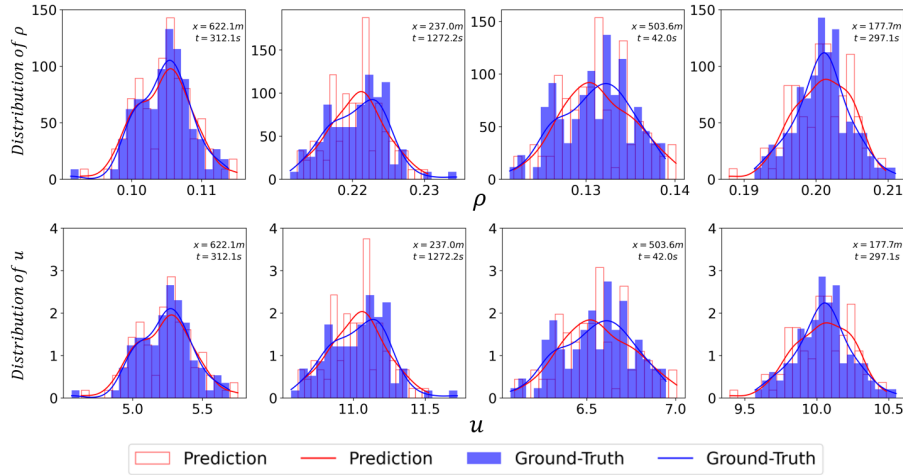

Fig. 9: Prediction distributions of TrafficFlowGAN for the NGSIM dataset.

Fig. 10 shows the learned traffic density-velocity relation by TrafficFlowGAN. When number of loop detectors is 4, TrafficFlowGAN can already capture this relation well. Increasing the number of loop detector helps TrafficFlowGAN learn a subtler pattern.

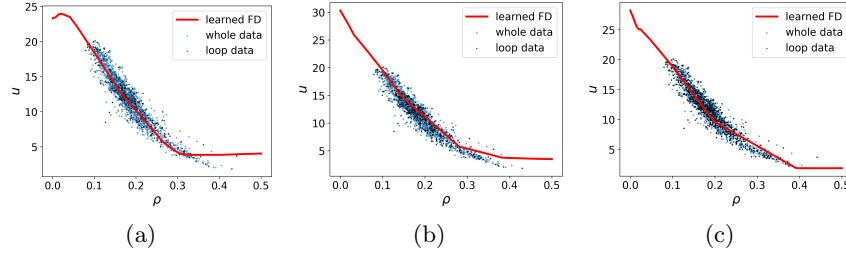

Fig. 10: Traffic density-velocity relations learned by the surrogate model (s-net) for different loop detector numbers. (a) loop detector number is 4. (b) loop detector number is 6. (c) loop detector number is 10.

## 6 Conclusions

This paper proposes TrafficFlowGAN to quantify the uncertainty in dynamical systems. TrafficFlowGAN leverages MLE, adversarial training, and PIDL to generate high-quality samples with exact data likelihood and efficient data usage. To verify that TrafficFlowGAN can learn the solutions of a second-order PDE, we conduct a numerical experiment where data is generated from a known ARZ equation. Numerical results show that TrafficFlowGAN manages to reconstruct the PDE solutions and recover the underlying relation between state variables. We further apply TrafficFlowGAN to a TSE problem using real-world data to demonstrate its performance. Results show that TrafficFlowGAN can better capture the real-world uncertainty than baselines, including the pure flow, the physics-informed flow, and the flow based GAN. We also show that TrafficFlowGAN can learn the real-world traffic density-velocity relation simultaneously.

This work can be further improved in two directions. First, apart from the weighted sum, other approaches of integrating the likelihood loss, adversarial loss, and physics loss can be proposed. Second, TrafficFlowGAN needs to be re-trained if applied to other roads or to the same road but within a new time slot. We will work on the generalizability of TrafficFlowGAN in the future.

## References

1. Arjovsky, M., Chintala, S., Bottou, L.: Wasserstein generative adversarial networks. In: International conference on machine learning. pp. 214–223. PMLR (2017)
2. Aw, A., Rascle, M.: Resurrection of “second order” models of traffic flow. *SIAM Journal on Applied Mathematics* **60**(3), 916–938 (2000)
3. Brehmer, J., Cranmer, K.: Flows for simultaneous manifold learning and density estimation. *Advances in Neural Information Processing Systems* **33**, 442–453 (2020)
4. Daw, A., Maruf, M., Karpatne, A.: Pid-gan: A gan framework based on a physics-informed discriminator for uncertainty quantification with physics. In: Proceedings of the 27th ACM SIGKDD Conference on Knowledge Discovery & Data Mining. pp. 237–247 (2021)

5. Dinh, L., Sohl-Dickstein, J., Bengio, S.: Density estimation using real nvp. arXiv preprint arXiv:1605.08803 (2016)
6. Fadel, S.G., Mair, S., S Torres, R.d., Brefeld, U.: Principled interpolation in normalizing flows. In: Joint European Conference on Machine Learning and Knowledge Discovery in Databases. Springer (2021)
7. Goodfellow, I., Pouget-Abadie, J., Mirza, M., Xu, B., Warde-Farley, D., Ozair, S., Courville, A., Bengio, Y.: Generative adversarial nets. *Advances in neural information processing systems* **27** (2014)
8. Grover, A., Chute, C., Shu, R., Cao, Z., Ermon, S.: Alignflow: Cycle consistent learning from multiple domains via normalizing flows. In: Proceedings of the AAAI Conference on Artificial Intelligence. vol. 34, pp. 4028–4035 (2020)
9. Grover, A., Dhar, M., Ermon, S.: Flow-gan: Combining maximum likelihood and adversarial learning in generative models. In: Proceedings of the AAAI Conference on Artificial Intelligence. vol. 32 (2018)
10. Guo, L., Wu, H., Zhou, T.: Normalizing field flows: Solving forward and inverse stochastic differential equations using physics-informed flow models. arXiv preprint arXiv:2108.12956 (2021)
11. Lighthill, M.J., Whitham, G.B.: On kinematic waves II. A theory of traffic flow on long crowded roads. *Proceedings of the Royal Society of London. Series A. Mathematical and Physical Sciences* **229**(1178), 317–345 (1955)
12. Raissi, M.: Deep hidden physics models: Deep learning of nonlinear partial differential equations. *Journal of Machine Learning Research* **19**(1), 932–955 (Jan 2018)
13. Seo, T., Bayen, A.M.: Traffic state estimation method with efficient data fusion based on the aw-rascl-zhang model. In: 2017 IEEE 20th International Conference on Intelligent Transportation Systems (ITSC). pp. 1–6. IEEE (2017)
14. Shi, R., Mo, Z., Huang, K., Di, X., Du, Q.: A physics-informed deep learning paradigm for traffic state and fundamental diagram estimation. *IEEE Transactions on Intelligent Transportation Systems* (2021)
15. Siddani, B., Balachandar, S., Moore, W.C., Yang, Y., Fang, R.: Machine learning for physics-informed generation of dispersed multiphase flow using generative adversarial networks. *Theoretical and Computational Fluid Dynamics* **35**(6), 807–830 (2021)
16. Tao, C., Dai, S., Chen, L., Bai, K., Chen, J., Liu, C., Zhang, R., Bobashev, G., Duke, L.C.: Variational annealing of gans: A langevin perspective. In: International conference on machine learning. pp. 6176–6185. PMLR (2019)
17. Theis, L., Oord, A.v.d., Bethge, M.: A note on the evaluation of generative models. arXiv preprint arXiv:1511.01844 (2015)
18. Yang, L., Zhang, D., Karniadakis, G.E.: Physics-informed generative adversarial networks for stochastic differential equations. *SIAM Journal on Scientific Computing* **42**(1), A292–A317 (2020)
19. Yang, Y., Perdikaris, P.: Adversarial uncertainty quantification in physics-informed neural networks. *Journal of Computational Physics* **394**, 136–152 (2019)
20. Zang, C., Wang, F.: Moflow: an invertible flow model for generating molecular graphs. In: Proceedings of the 26th ACM SIGKDD International Conference on Knowledge Discovery & Data Mining (2020)