

A Survey : Neural Networks for AMR-to-Text

Hongyu Hao*
Beihang University/JoeyHao@buaa.edu.cn

Guangtong Li*
Beihang
University/liguangtong@buaa.edu.cn

Zhiming Hu*
North China University of
Technology/paleunahu@gmail.com

Huafeng Wang**
North China University of
Technology/wanghuafengbuaa@gmail.com

AMR-to-text is one of the key techniques in the NLP community that aims at generating sentences from the Abstract Meaning Representation (AMR) graphs. Since AMR was proposed in 2013, the study on AMR-to-Text has become increasingly prevalent as an essential branch of structured data to text because of the unique advantages of AMR as a high-level semantic description of natural language. In this paper, we provide a brief survey of AMR-to-Text. Firstly, we introduce the current scenario of this technique and point out its difficulties. Secondly, based on the methods used in previous studies, we roughly divided them into five categories according to their respective mechanisms, i.e., Rules-based, Seq-to-Seq-based, Graph-to-Seq-based, Transformer-based, and Pre-trained Language Model (PLM)-based. In particular, we detail the neural network-based method and present the latest progress of AMR-to-Text, which refers to AMR reconstruction, Decoder optimization, etc. Furthermore, we present the benchmarks and evaluation methods of AMR-to-Text. Eventually, we provide a summary of current techniques and the outlook for future research.

1. Introduction

Natural language processing using graph neural networks (GNNs) can be divided into two subgroups: natural language understanding and natural language generation (NLG). Natural language generation aims at generating high-quality, coherent, and understandable natural language, which include many downstream applications, such as machine translation (MT), text summary, question generation, and structured data to text. In order to better represent structured data, researchers have put forward various representation methods, such as SQL queries, knowledge graphs, and AMR.

AMR (Banarescu et al. 2013) is a novel semantic representation method that encodes the meaning of a sentence as a rooted, directed, and acyclic graph. The nodes of the graph are called concepts, which are mapped by the content words in the natural language and the edges between the nodes represent the semantic relation between two concepts.

Over the past literature (Liu et al. 2015; Pan et al. 2015; Takase et al. 2016; Sachan and Xing 2016; Garg et al. 2016), researchers demonstrated that the use of AMR in some applications such as text summary, entity linking, biometric information extraction, and headline generation can effectively and significantly improve the performance. Thus, it has inspired increasing researchers

* Equal contribution.

** Corresponding author.

to investigate the application of AMR in MT, question answering systems, and other downstream of natural language processing.

AMR-to-Text, as an indispensable part of AMR application on NLG, is highly emphasized by researchers in this field. As a task of converting a graph into a sequence, it facilitates the whole process of recovering semantically consistent text from a given AMR graph automatically. To date, a large number of approaches on AMR-to-Text have been presented in the literature. The dominant position of AMR-to-Text in the NLP community can be shown in Figure 1.

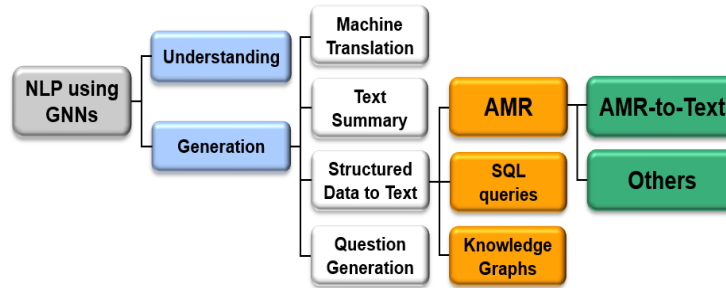

Figure 1
Position of AMR-to-Text in NLP

In addition, as AMR-to-Text evolves, it also faces difficulties from multiple sources. To begin with, graph representation is the critical difficulty for AMR-to-Text. In the field of graph representation learning, representing graphs has been a challenge due to the intrinsic characteristics, like heterogeneity, complexity, and large scale inherent in graphs. Moreover, since the AMR graph is a kind of graph-structured data, most of the efforts for AMR-to-Text are attempting to utmostly extract the information embedded in the AMR graph while maintaining the same meaning. Therefore, in the literature, many of the researchers have continuously explored applying different mechanisms to Encoders to better extract and represent AMR graph information (Flanigan et al. 2016; Konstas et al. 2017; Song et al. 2018; Zhu et al. 2019; Mager et al. 2020).

Secondly, another difficulty of AMR-to-Text is the design of the evaluation methods for different models. The two common types of evaluation methods are automatic metrics and human evaluation. Although automatic metrics have been relatively effective in past research, recently, researchers found that there exists a noticeable disparity between automatic metrics and human evaluation. As many AMR-to-Text models are evaluated using automatic metrics, the disparity will make the results less reliable and highly uncertain (May and Priyadarshi 2017; Manning et al. 2020). Further, apart from Encoder and evaluation methods, a small group of researchers achieved new progress through exploring new perspectives to improve the performance of AMR-to-Text, for example, AMR image reconstruction (Wang et al. 2020b; Song et al. 2020) and Decoder optimization (Bai et al. 2020).

In particular, the main contributions of this paper are as follows:

- We provide a brief review of past research on AMR-to-Text and, based on the techniques used, we classify the methods into five categories, which are traditional Rules-based, Seq-to-Seq-based, Graph-to-Seq-based, Transformer-based, PLM-based, respectively.

- We make a particular classification and analysis of Graph-to-Seq methods based on different Graph Encoders used, which are recurrent GNN (RecGNN), graph convolutional network (GCN), and graph attention network (GAT).

2. Overview

2.1 Notations & Definition

In this section, we list commonly used notations in this paper, which is presented in Table 1.

Table 1
Notations & Definition

Symbol	Definition
G	Graph
$L(G)$	Linear Graph
V	Node Set
E	Edge Set
A	Attention Matrix
R^K	K^{th} order neighborhood information of Graph
s_i	i^{th} token
e_i	embedding of i^{th} token
X_i	embedding of i^{th} node
h_i	i^{th} hidden state
a_i	i^{th} attention vector
μ_i	context of i^{th} token
γ_i	cover vector of i^{th} token
w_i	i^{th} output word

2.2 Encoder

As illustrated in Figure 2, the main methods of AMR-to-Text are revolved around the Encoder area and other derivatives, such as Decoder and training process. In particular, most of the literature in AMR-to-Text focused on the Encoder area in an attempt to better represent AMR graphs. The focus area and used techniques between each paper with AMR-to-Text are shown in Table 2. In this section, we present the different techniques used in the Encoder area and their corresponding analysis.

Rules. The early researchers adopted the technique of Rules to encode the AMR graph. Flanigan et al. (2016) firstly transformed the AMR graph into a tree, then turn the tree into a string by using a number of tree-to-string transduction Rules (Graehl et al. 2004). Song et al. (2016) directly used graph-to-string Rules to generate sentences from the AMR graph regarding the AMR-to-Text as an asymmetric generalized traveling salesman problem (AGTSP). However, this method did not consider hierarchical structural correspondences between AMR graphs and strings. Therefore, Song et al. (2017) used synchronous Node Replacement Grammar (NRG) when training, and applies a graph transducer to collapse AMR graphs and generate output strings according to the learned grammar at test time. Afterwards, Pourdamghani et al. (2016) linearized AMR graphs to

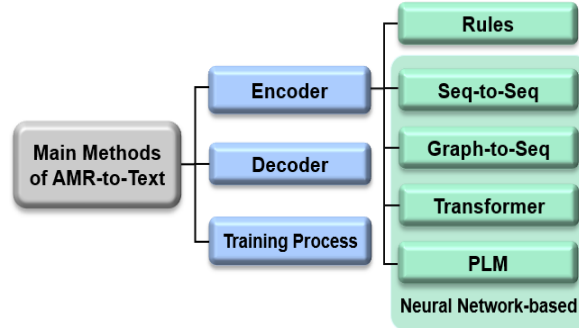

Figure 2
Overview of main methods of AMR-to-Text

Table 2
Main methods of AMR-to-Text

Area	Technique	Paper
Encoder	Rules	Flanigan et al. (2016); Song et al. (2016); Song et al. (2017); Pourdamghani et al. (2016); Manning (2019)
	Seq-to-Seq	Konstas et al. (2017); Cao and Clark (2019); Zhu and Li (2020)
	Graph-to-Seq	Song et al. (2018); Beck et al. (2018); Guo et al. (2019); Zhao et al. (2020); Damonte and Cohen (2019); Ribeiro et al. (2019); Zhang et al. (2020b)
	Transformers	Zhu et al. (2019); Cai and Lam (2020); Wang et al. (2020a); Yao et al. (2020); Jin and Gildea (2020)
	PLM	Mager et al. (2020); Ribeiro et al. (2021a,b); Xu et al. (2021); Bevilacqua et al. (2021); Fan and Gardent (2020)
Other Derivatives	Training Process Decoder	Song et al. (2020); Wang et al. (2020b) Bai et al. (2020)

AMR strings and used a phrase-based MT (PBMT) system to map the AMR strings into English sentences. Further, since the relatively small amount of available data has limited the performance of neural methods, (Manning 2019) proposed a partially Rule-based method, complemented by a language model and simple statistical models, allowing for more control over the output.

In addition, Ferreira et al. (2017) framed AMR-to-Text as a translation task and systematically studied PBMT and Neural MT (NMT). Apart from proving PBMT generally outperforms NMT, they suggested that combining the suitable preprocessing strategy with large volumes of training data should lead to further improvements, which provide important inspirations for subsequent researchers.

Seq-to-Seq. With the growing application of AMR on generation tasks based on neural networks, as a breakthrough, Konstas et al. (2017), presented the first successful Seq-to-Seq-based methods for both text-to-AMR and AMR-to-text. Konstas et al. (2017) used a novel paired training procedure

attempting to obtain a high-quality AMR graph representation and a preprocessing procedure including named entity anonymization to overcome data sparsity. Similar to the pipeline used in [Konstas et al. \(2017\)](#), [Cao and Clark \(2019\)](#) first generate a syntactic structure by sampling from a syntax model, and then the surface form of the AMR realization. However, [Zhu and Li \(2020\)](#) testified that the method proposed by [Cao and Clark \(2019\)](#) tended to ignore the syntactic information hidden in the sentence. Therefore, [Zhu and Li \(2020\)](#) proposed a direct and effective method to incorporate the syntactic information of the target side syntax.

Graph-to-Seq. To prevent the information loss in linearizing the AMR graph into a sequence, [Song et al. \(2018\)](#) introduced a novel Graph-to-Seq-based method, which used graph-state long short-term memory (LSTM, [Hochreiter and Schmidhuber \(1997\)](#)) to encode the AMR structure directly. To capture the non-local information, they performed graph state transition in the Encoder through information exchange between connected nodes. Meanwhile, to combine complete graph structures without losing information, [Beck et al. \(2018\)](#) took advantage of the Gated GNN (GGNN, [Li et al. \(2016\)](#)) to encode AMR graph structures to form graph representations.

Focusing on the reentrancies of AMR graph, [Damonte and Cohen \(2019\)](#) proposed a stacking graph Encoder consisting of a GCN ([Duvenaud et al. 2015](#); [Kipf and Welling 2017](#)) wired to a bidirectional LSTM (BiLSTM, [Graves et al. \(2013\)](#)) to encode the AMR graph. As relatively shallow GCNs are not able to capture rich non-local information, inspired by DenseNets ([Huang et al. 2017](#)), [Guo et al. \(2019\)](#) proposed the densely connected GCNs (DCGCNs), which allows the information of different layers to be exchanged to receive a stronger AMR graph representation. In view of [Cao and Clark \(2019\)](#), [Ribeiro et al. \(2019\)](#) proposed a method to encode two parallel and adjuvant views of the AMR graph (top-down and bottom-up) to obtain the representation.

Apart from the limitation that vanilla GCNs are unable to capture non-local information, GCNs update the node representation based highly on the first-order neighbors, thus relying on stacked layers to model the relation between indirectly connected nodes. Therefore, [Zhang et al. \(2020b\)](#) introduced a dynamic fusion mechanism, proposing the lightweight dynamic GCN (LDGCN), which integrates the higher-order neighborhood information of the input graph to capture richer non-local interactions. Further, [Zhao et al. \(2020\)](#) adopt GAT ([Velickovic et al. 2018](#)) with higher-order neighborhood information to encode the rich structure in AMR graphs.

Transformers. Since [Vaswani et al. \(2017\)](#) proposed a new architecture Transformer, its competence to learn the dependencies between long-distance tokens has become an inspiration to solve the above-mentioned limitation of GNNs. By applying Transformer, [Zhu et al. \(2019\)](#); [Cai and Lam \(2020\)](#) both used the structure-aware self-attention mechanism to better model the relations between indirectly connected concepts. Meanwhile, [Wang et al. \(2020a\)](#) proposed a new graph network (Graph Transformer). Unlike the Graph Transformer proposed by [Cai and Lam \(2020\)](#), [Wang et al. \(2020a\)](#) used multiple stacked graph attention layers to enable the nodes to utilize the information of indirectly adjacent nodes, allowing the global information to propagate.

Further, [Yao et al. \(2020\)](#) discovered that [Zhu et al. \(2019\)](#); [Cai and Lam \(2020\)](#) seemed to ignore the information of nodes in the relation path and encoded the direct relations and indirect relations indiscriminately. Therefore, [Yao et al. \(2020\)](#) utilized the Heterogeneous Graph Transformer(HetGT) to encode the graph and independently model the different relations in each subgraph. Based on the relation Encoder of [Cai and Lam \(2020\)](#) as a foundation, [Jin and Gildea \(2020\)](#) presented two relation Encoders based on generalized shortest-paths algorithms (Floyd-Warshall and adjacency matrix multiplication) for graph Encoders.

PLM. As attempting to fine-tune the PLM directly on the sequential representation of the AMR graph, [Mager et al. \(2020\)](#) proposed the first PLM-based method for AMR-to-Text. Inspired by them, [Ribeiro et al. \(2021a\)](#) avoided graphic coding altogether, but applied the PLM on the

linearized AMR. Afterwards, [Ribeiro et al. \(2021b\)](#) proposed a novel graph structural adaptor to effectively encode the input graph structure, instead of the sequential structure, into PLM. In order to reduce the dependence on the artificially labeled corpus, [Xu et al. \(2021\)](#) introduced the Seq-to-Seq-based pre-training into the AMR-to-Text, and proposed the multi-task learning fine-tuning methods to fine-tune the pre-training model. Further, [Bevilacqua et al. \(2021\)](#) extended a pre-trained Seq-to-Seq model, i.e., BART ([Lewis et al. 2020](#)), to handle both AMR-to-Text and Text-to-AMR achieving a relatively stronger performance in AMR-to-Text side. In addition, in terms of multilingual generation, [Fan and Gardent \(2020\)](#) used cross-lingual embeddings, pretraining, and multilingual models achieving the generation of 21 different languages for AMR-to-Text.

2.3 Other Derivatives

Currently, only a small group of researchers have focused on improving the performance of AMR-to-Text from other perspectives apart from the Encoder area. In this section, we briefly introduce the research conducted on the training process and the Decoder.

Training Process. In terms of the training process, [Song et al. \(2020\)](#); [Wang et al. \(2020b\)](#) reconstructed the input AMR graph by setting a new loss target during training, and executing AMR-to-Text during the reconstruction process.

Decoder. [Bai et al. \(2020\)](#) made some improvements to the Decoder by adding online inverse analysis to it, which is expected to better preserve the structure of the source AMR graph in the Decoder network.

3. AMR-to-Text Based on Neural Network

The methods of AMR-to-Text based on the neural network can be divided into Seq-to-Seq-based methods, Graph-to-Seq-based methods, Transformer-based methods, and PLM-based methods. As shown in Figure 3, the major difference among them is Encoders.

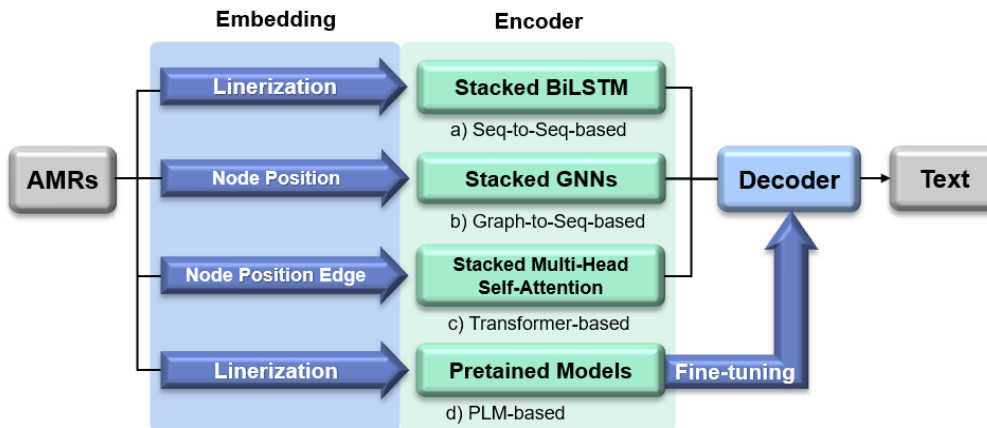

Figure 3
The general framework of neural network-based methods

Generally, the Seq-to-Seq-based method traverses the AMR graph into a linearized sequence, then uses Stacked BiLSTM as the Encoder to encode the embedding of the linearized sequence; the Graph-to-Seq-based method retains the structure information of the AMR graph and combines node information and relative position embedding, which are then transmitted to a GNNs Encoder; the Transformer-based method forms the self-attention network (SAN)-based architecture to encode using the node information, the edge information and position embedding as input; the PLM-based method directly fine-tunes the PLM on a sequential representation of the input AMR graphs to generate text.

Although each category of methods has a general framework, the methods within it have a relatively different structure. In this section, we select representative methods among the four categories of methods for a detailed demonstration.

3.1 Seq-to-Seq-based Methods

Among the Seq-to-Seq-based methods, the work of [Konstas et al. \(2017\)](#) is the most representative. Inspired by the stacked LSTM Seq-to-Seq neural architecture used in NMT ([Bahdanau et al. 2015](#); [Wu et al. 2016](#)), [Konstas et al. \(2017\)](#) realized the first Seq-to-Seq-based method for AMR-to-Text. In this method, at first, the AMR graph is linearized as a linear sequence. Afterwards, the BiLSTM Encoder is used to encode the input sequence, while an attention-based LSTM Decoder ([Bahdanau et al. 2015](#)) is applied to decode from the hidden states generated by the Encoder. The detailed demonstration below is based on the investigation of [Song et al. \(2018\)](#) on the method of [Konstas et al. \(2017\)](#)

Input Representation. Given an AMR graph $G = (V, E)$, where V and E represent the set of nodes and edges respectively. Then, the depth-first traversal method is used to get a token sequence s_1, s_2, \dots, s_N , where N is the number of tokens. The input to the AMR graph is represented by the formula:

$$x_j = W_1([e_j; h_j^c]) + b_1 \quad (1)$$

where W_1 and b_1 are model parameters, e_j is the word embedding representation of v_j . In order to alleviate the sparsity of data and obtain a better word representation as input, a forward LSTM is used on the characters of the token, and the final hidden state h_j^c is concatenated with the word embedding e_j .

Encoder. A stacked bi-LSTM is used in the Encoder. The forward and backward hidden states are concatenated between the stacked layers, which are applied to the linearized graph obtained by the depth-first traversal method. The state vector \overleftarrow{h}_j and \overrightarrow{h}_j at time step j are expressed as:

$$\begin{aligned} \overleftarrow{h}_j &= LSTM(\overleftarrow{h}_{j+1}, x_j) \\ \overrightarrow{h}_j &= LSTM(\overrightarrow{h}_{j-1}, x_j) \end{aligned} \quad (2)$$

where x_j is the current input, \overleftarrow{h}_{j+1} and \overrightarrow{h}_{j-1} are the backward state vector and the forward state vector respectively.

Decoder. An attention-based LSTM is used in the Decoder. The attention memory matrix $A = [a_1, a_2, \dots, a_N]$ is the concatenation of the attention vector $a_j = [\overleftarrow{h}_j; \overrightarrow{h}_j; x_j]$ between all input

words, where N is the number of input tokens, and each attention vector a_j is the concatenation of the state vector of the input token in two directions \overleftarrow{h}_j and \overrightarrow{h}_j and its input vector x_j .

The Decoder generates the output sequence w_1, w_2, \dots, w_M by calculating the hidden state of the token sequence s_1, s_2, \dots, s_N . When generating the t -th word, the Decoder has five influencing factors: 1) Attention memory matrix A ; 2) The hidden state s_{t-1} before the LSTM model; 3) The embedding of the current input word e_t ; 4) The previous context vector μ_{t-1} , which is calculated from the attention vector in A ; 5) The previous coverage vector γ_{t-1} , the accumulation of all attention distributions.

For each time step t , the Decoder concatenates the embedding of the current input e_t and the previous context vector μ_{t-1} to the LSTM model to update its hidden state. Then, the attention probability $\alpha_{t,i}$ and attention vector $\alpha_i \in A$ of the time step are calculated as follows:

$$\begin{aligned} \varepsilon_{t,i} &= v_2^T \tanh(W_a \alpha_i + W_s s_t + W_\gamma \gamma_{t-1} + b_2) \\ \alpha_{t,i} &= \frac{\exp(\varepsilon_{t,i})}{\sum_{j=1}^N \exp(\varepsilon_{t,j})} \end{aligned} \quad (3)$$

where W_a, W_s, W_γ, v_2 and b_2 are the model parameters. The coverage vector γ_t is obtained by updating $\gamma_t = \gamma_{t-1} + \alpha_t$, and the new context vector μ_t is calculated as follows $\mu_t = \sum_{i=1}^N \alpha_{t,i} \alpha_i$.

The output probability distribution of a vocabulary in the current state is expressed as:

$$P_{vocab} = \text{softmax}(V_3[s_t, \mu_t] + b_3) \quad (4)$$

where V_3 and b_3 are learnable parameters, the number of rows in V_3 represents the number of words in the vocabulary.

Limitation. In Seq-to-Seq-based methods, since the AMR graph is linearized, the node information is expected to be preserved. However, the structure information in the AMR graph is not well kept, which causes the generated text to be ambiguous or inconsistent with the original text.

3.2 Graph-to-Seq-based Method

In order to lessen the loss of structure information in the AMR graph, the researchers proposed the Graph-to-Seq-based method to directly encode the AMR graph. According to the Graph Encoders used, we divide the Graph-to-Seq-based methods into three categories, which are RecGNNs Encoder-based, GCN Encoder-based and GAT Encoder-based, separately.

3.2.1 RecGNN Encoder. Beck et al. (2018) coupled GGNN (Li et al. 2016) (a typical type of RecGNN) with an input transformation that allows nodes and edges to have their own hidden representations, which is expected to address the information loss from linearization and parameter explosion.

Input Representation. As in the Seq-to-Seq-based method, the input is a sequence of tokens, where each token is represented by an embedding vector. In particular, inspired by Vaswani et al. (2017); Gehring et al. (2017), Beck et al. (2018) added a position embedding to each node, and the position embedding is represented by the integer-valued index of the minimum distance to the root node.

Encoder. GGNN is used as the Encoder, which receives the node embedding as input, and generates the hidden state of the node as output using graph structure as context. Assume a directed graph $G = (V, E, L_v, L_e)$, where V is a collection of nodes (L, L_v) , E is a collection of edges (v_i, v_j, L_e) , which L_v and L_e represent the vocabulary of nodes and edges, and $l_v \in v, l_e \in e$ are labels of nodes and edges, respectively. Given the embedding X of a node as the input, the hidden state of its output is calculated as follows:

$$\begin{aligned}
h_v^0 &= X_v \\
r_v^t &= \sigma(c_v^r \sum_{u \in N_v} W_{le}^r h_u^{t-1} + b_{le}^r) \\
z_v^t &= \sigma(c_v^z \sum_{u \in N_v} W_{le}^z h_u^{t-1} + b_{le}^z) \\
\tilde{h}_v^t &= \rho(c_v \sum_{u \in N_v} W_{le} (r_u^t \odot h_u^{t-1}) + b_{le}) \\
h_v^t &= (1 - z_v^t) \odot h_v^{t-1} + z_v^t \odot \tilde{h}_v^t
\end{aligned} \tag{5}$$

where $e = (u, v, le), e \in E$ is the edge between nodes u and v , N_v is the set of neighbor nodes of node v , ρ is a non-linear function, σ is a sigmoid function, and $c_v = c_v^r = c_v^z = |N_v|^{-1}$ is a standardized constant.

Decoder. The Decoder components follow a similar standard as the Seq-to-Seq-based method, which uses bilinear attention mechanism (Luong et al. 2015) and two-layer LSTM (Hochreiter and Schmidhuber 1997) as the Decoder.

3.2.2 GCN Encoder. Compared with recurrent neural networks (RNNs), convolutional architectures have a high level of parallelism. However, the relatively shallow GCNs cannot capture the rich non-local interactions of larger graphs. Therefore, in order to obtain deeper GCNs, inspired by DenseNet (Huang et al. 2017), Guo et al. (2019) introduced dense connectivity into GCNs, and proposed the novel densely connected GCNs (DCGCNs) to extract information from residual connections. The Encoder relies on the DCGCNs for richer local and non-local information to receive better graph representations.

Input Representation. The input is represented by connecting the node embedding and position embedding.

Encoder. As shown in the Figure 4, the Encoder is composed of multiple DCGCN blocks. The convolution of DCGCN is defined as:

$$h_v^l = \rho\left(\sum_{u \in N_v} \alpha_{uv}^l W^l g_u^l + b^l\right) \tag{6}$$

where α_{uv}^l is the normalized attention coefficient calculated by the l layer attention mechanism, W^l is the weight matrix, b^l is the bias vector, N_v is the single-hop neighbor set of node v , ρ is the activation function (e.g., RELU, Nair and Hinton (2010)), h_v^0 is the initial input X_v , and g_u^l is the connection of the inputs of all previous layers, which are defined as follows:

$$g_u^l = [X_u; h_u^1; h_u^2; \dots; h_u^{l-1}] \tag{7}$$

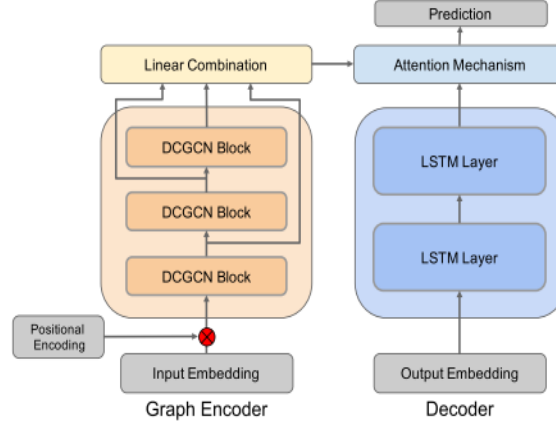

Figure 4
DCGCN structure.

Therefore, the column dimension of the weight matrix increases by d_{hidden} for each layer, that is $W_l \in R^{d_{hidden} \times d_l}$, and $d^l = d + d_{hidden} \times (l - 1)$.

In addition to densely connected layers as shown in Figure 4, Guo et al. (2019) also added a linear combination layer between multiple layers of DCGCNs to filter the representations from different DCGCNs layers to achieve a relatively stronger representation. The output of the linear combination layer is defined as:

$$h_{comb} = W_{comb}(h_{out} + X_v) + b_{comb} \quad (8)$$

where $h_{out} = [h^1; \dots; h^L]$ and $h_{out} \in R^d$. X_v is the input of the DCGCN layer. $W_{comb} \in R^{d \times d}$ is the weight matrix, and b_{comb} is the offset vector of the linear transformation.

Since directionality and edge marking play an important role in linguistic structure, in order to consider different types of edges, the convolution is modified as follows:

$$h_v^l = \rho \left(\sum_{\substack{u \in N_v \\ dir(u,v)=t}} \alpha_{uv}^l W_t^l g_u^l + b_t^l \right) \quad (9)$$

where $dir(u, v)$ is related to edge type t . Each edge type corresponds to a separate weight matrix and a separate deviation term.

However, Hamilton et al. (2017) proved that aggregating feature information from different nodes using a mean-based function may be unsatisfactory, because the information from different sources should not be treated equally. Therefore, Guo et al. (2019) assigned different weights to the information from different types of edges to integrate this information, that is, connect the representations of all edge types and perform a linear transformation. The formula is as follows:

$$f([v_1^l; \dots; v_T^l]) = W_f[v_1^l; \dots; v_T^l] + b_f \quad (10)$$

where W_f is the weight matrix, and b_f is the bias vector.

Finally, the convolution is calculated as follows:

$$h_v^l = \rho(f([v_1^l; \dots; v_T^l])) \quad (11)$$

Decoder. The attention-based LSTM Decoder (Bahdanau et al. 2015) is used to generate natural language sequences by sequentially calculating the hidden state sequences, in addition with an overlay mechanism (Tu et al. 2016). Therefore, when generating the t time token, the five factors should be considered in the Decoder, which are the attention memory, the word embedding of the $t - 1$ time token, the previous hidden state of the LSTM, the previous context vector and the previous coverage vector.

3.2.3 GAT Encoder. As the relations between higher-order neighbors cannot be well represented in GNNs, the relations between edges with labels are not fully considered during the information propagation in AMR graphs. Therefore, in order to explore the relation between indirectly connected nodes, employing GAT (Velickovic et al. 2018), Zhao et al. (2020) proposed a novel graph encoding framework using line graph to model the edge relations and integrates high-order neighborhood information to model the relation between indirectly connected nodes.

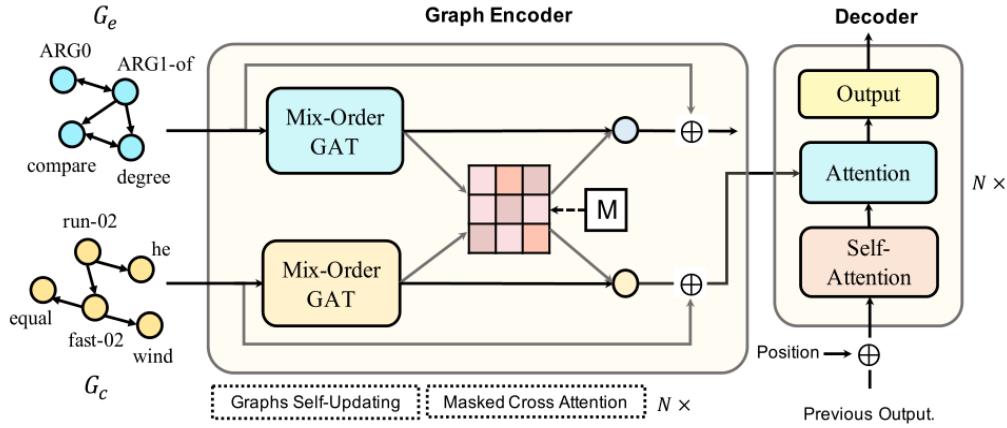

Figure 5
The structure of the GATs-based method.

Input Representation. For a graph G , its line graph $L(G)$ is defined as: Each node of $L(G)$ represents an edge of G , and two nodes of $L(G)$ are adjacent if and only if their corresponding edges share a common node in G .

Zhao et al. (2020) used line graphs to organize labeled edges and convert the original AMR graph into two subgraphs. Given an AMR graph $G_a = (V_a, E_a)$ and they decomposed it into a concept picture $G_c = (V_c, E_c)$ and a relation picture $G_e = (V_e, E_e)$, of which $G_e = L(G_c)$. Then, they used R_c^K and R_e^K to represent the $1 - K$ neighborhood information of G_c and G_e ; used initial embedding $c_i^0 \in R^d$ to represent each concept node $x_i \in V_c$, and $e_i^0 \in R^d$ to represent each relation node $y_i \in V_e$. The set of node embeddings is denoted as $C^0 = \{c_i^0\}_{i=1}^m$, $E^0 = \{e_i^0\}_{i=1}^n$, where $m = |V_c|$, $n = |V_e|$ represents the number of concept nodes and relation nodes respectively. Therefore, the input can be formalized as $I = \{C^0, E^0, R_c^K, R_e^K\}$.

Encoder. The Encoder consists of N stacked graph coding layers. As shown in Figure 5, each graph coding layer has two parts: the graph self-updating and the masked cross attention.

In the first part, $C^{l-1} = \{c_i^{l-1}\}_{i=1}^m$ and $E^{l-1} = \{e_i^{l-1}\}_{i=1}^n$ are used to represent the input node embedding of the l -th coding layer for G_c and G_e . The representations of the two graphs are independently updated by the Mixed Order Graph Attention Network (MixGAT). At step l (layer), it has:

$$\begin{aligned}\vec{C}_{self}^l &= \text{MixGAT}_{c1}^l(C^{l-1}, R_c^K) \\ \vec{E}_{self}^l &= \text{MixGAT}_{e1}^l(E^{l-1}, R_e^K) \\ \overleftarrow{C}_{self}^l &= \text{MixGAT}_{c2}^l(C^{l-1}, \tilde{C}_c^K) \\ \overleftarrow{E}_{self}^l &= \text{MixGAT}_{e2}^l(E^{l-1}, \tilde{R}_e^K)\end{aligned}\tag{12}$$

where $\vec{C}_{self}^l, \vec{E}_{self}^l, \overleftarrow{C}_{self}^l, \overleftarrow{E}_{self}^l$ is based on the neighborhood information of the mixed order $R_c^K, R_e^K, \tilde{C}_c^K, \tilde{R}_e^K$ to update the representation, and $\tilde{C}_c^K, \tilde{R}_e^K$ is the reverse of R_c^K, R_e^K . The final representation is a combination of two-way embedding:

$$\begin{aligned}C_{self}^l &= [\vec{C}_{self}^l; \overleftarrow{C}_{self}^l]W_c^l \\ E_{self}^l &= [\vec{E}_{self}^l; \overleftarrow{E}_{self}^l]W_e^l\end{aligned}\tag{13}$$

where W_c^l and W_e^l are trainable matrix for projections. C_{self}^l and E_{self}^l are results of the final results.

In the second part, Zhao et al. (2020) applied the attention mechanism to complete the interaction between the two graphs, and used $M \in \mathbb{R}^{n \times m}$ to mask the attention weights of unaligned pairs between G_c and G_e . If $y_i \in V_e$ is aligned to $x_j \in V_e$, then $m_{ij} = 0$; otherwise $m_{ij} = -\infty$, where $m_{ij} \in M$. The masked cross attention is used between the representation set C_{self}^l, E_{self}^l . Attention weight matrix A_l can be calculated as:

$$A_l = (E_{self}^l W_{a1}^l)(C_{self}^l W_{a2}^l)^T + M\tag{14}$$

where W_{a1}^l and W_{a2}^l are learnable projection matrices, and the weight scores of unaligned pairs are set to $-\infty$. For the nodes in C_{self}^l, E_{self}^l , the correlation is expressed as:

$$\begin{aligned}E_{cross}^l &= \text{softmax}(A_l)C_{self}^l \\ C_{cross}^l &= \text{softmax}(A_l^T)E_{self}^l\end{aligned}\tag{15}$$

The final output of the coding layer is a combination of the original embedding and the context representation from another graph. Similarly, the output of the previous layer is used as the remaining input, which is calculated as follows:

$$\begin{aligned}C^l &= \text{FFN}([C_{self}^l; C_{cross}^l]W_c^l + C^{l-1}) \\ E^l &= \text{FFN}([E_{self}^l; E_{cross}^l]W_e^l + E^{l-1})\end{aligned}\tag{16}$$

where FFN is a feed-forward network consisting of two linear transformations. After processing through N -stacked graph encoding layers, the two graphs G_c and G_e are finally encoded as C^N and E^N .

Decoder. Similar to the Decoder in Transformer, in each generation step, the representation of the output token is updated by multiple rounds of attention to the previously generated token and the encoded output. The output of the Encoder has two parts: concept representation C^N and relation representation E^N . For a generation, concept information is more important, as the concept map directly contains natural words. With multi-step cross-focusing, C^N also carries a wealth of relation information. For simplicity, only the output C^N of the Encoder is used on the Decoder part.

3.2.4 Limitation. The graph-to-Seq-based method preserves both the node information and the structure information of the AMR graph. However, the update of node representation is limited to the first-order neighbors, which cannot fully explore the dependency between distant AMR concepts and cannot perform node representation updates between higher-order neighbors. Meanwhile, it relies on stacked layers for modeling, therefore the relation between nodes can only be indirectly connected.

3.3 Transformer-based Method

In order to address above mentioned limitation of GNNs, inspired by Transformer (Vaswani et al. 2017), Cai and Lam (2020) proposed a new variant Graph Transformer, which uses a structure-aware self-attention method to encode the structural label sequence of arbitrary pair of concepts, regardless of whether they are directly connected. Afterwards, the sequence Decoder is used to generate natural language sequences by sequentially calculating the hidden state sequences. The network structure is shown in the following Figure 6.

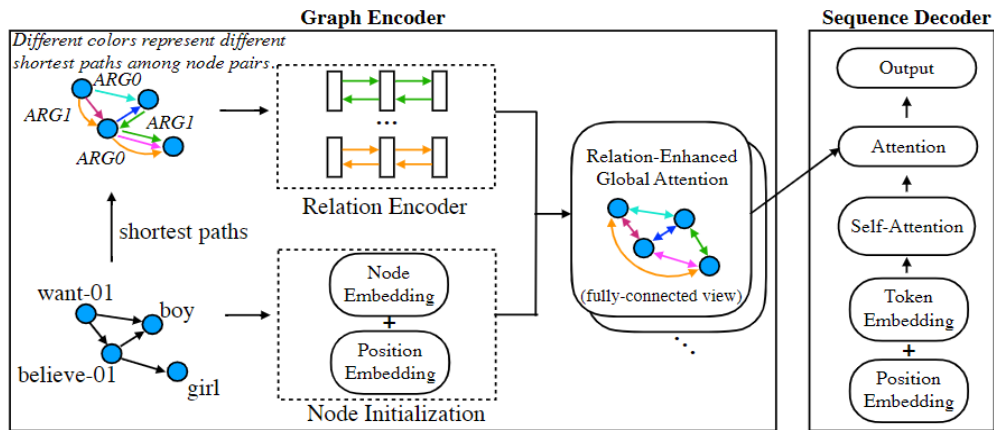

Figure 6
Based on Transformer model structure.

Input Representation. As shown in Figure 6, the input is divided into two parts, one is to add the node embedding and position embedding of the original picture as the input, while the other is to

use the shortest path between concept pairs to replace the original edge to get the path graph as input, and use the path graph for relation coding.

Encoder. The Encoder is used to convert the input graph into a set of corresponding node embeddings. In order to apply global attention to the graph, [Cai and Lam \(2020\)](#) proposed the relation-enhanced global attention mechanism. The mechanism allows fully connected communication while maintaining the topological structure of the graph, and incorporates the explicit relation representation between two nodes into its representation learning.

According to the sequential nature of the relation sequence, it is transformed into a distributed representation using RNN with a gated recursive unit (GRU). Denoted that the shortest relation path as $sp_{i \rightarrow j} = [e(i, k_1), e(k_1, k_2), \dots, e(k_n, j)]$, where $e(\cdot, \cdot)$ is the edge label and $k_{1:n}$ is the relay node. Bidirectional GRUs are used for sequence encoding:

$$\begin{aligned} \overleftarrow{h}_t &= GRU_b(\overleftarrow{h}_{t+1}, sp_t) \\ \overrightarrow{h}_t &= GRU_f(\overrightarrow{h}_{t-1}, sp_t) \end{aligned} \quad (17)$$

The last hidden states of the forward and the backward GRU network are concatenated to form the final relation encoding $r_{ij} = [\overrightarrow{h}_n; \overleftarrow{h}_0]$.

Following the idea of relative position embedding ([Shaw et al. 2018](#); ?), the attention score is calculated as follows:

$$[r_{i \rightarrow j}; r_{j \rightarrow i}] = W_r r_{ij} \quad (18)$$

Firstly, the relation code r_{ij} is decomposed into forward relation code $r_{i \rightarrow j}$ and reverse relation code $r_{j \rightarrow i}$, and then the attention score is calculated according to the node representation and their relation representation:

$$\begin{aligned} a_{ij} &= g(x_i, x_j, r_{ij}) \\ &= (x_i + r_{i \rightarrow j}) W_q^T W_K (x_j + r_{j \rightarrow i}) \\ &= \underbrace{x_i W_q^T W_K x_j}_{(a)} + \underbrace{x_i W_q^T W_K r_{j \rightarrow i}}_{(b)} \\ &\quad + \underbrace{r_{i \rightarrow j} W_q^T W_K x_j}_{(c)} + \underbrace{r_{i \rightarrow j} W_q^T W_K r_{j \rightarrow i}}_{(d)} \end{aligned} \quad (19)$$

where (a) captures the pure content-based addressing, which is the original term in the ordinary attention mechanism; (b) represents source dependency deviation; (c) governs a target dependency deviation; (d) encodes general relation deviation.

Decoder. Basically, the sequence Decoder has the same strategy as the sequence Transformer Decoder, which generates natural language sequences by sequentially calculating the sequences of hidden states. The Decoder uses a global graph representation x_{global} to initialize the hidden state of each time step. Afterwards, it updates the hidden state h_t and time step t by interleaving multiple rounds of attention at the output of the Encoder (node embedding) and attention to the previously generated token (token embedding). Both are implemented through the multi-head attention mechanism, and x_{global} is removed when the sequence reaches the graph attention.

Limitation. In the Transformer-based method, the connection between nodes is not fully considered, while the structural label sequence of arbitrary concept pairs is used to represent the relation between nodes in the AMR graph. However, it may violate the structure of the graph, since [Cai and Lam \(2020\)](#) default that each node is able to form node pairs with any other nodes.

3.4 PLM-based method

Previously, [Radford and Narasimhan \(2018\)](#); [Radford et al. \(2019\)](#); [Devlin et al. \(2019\)](#) used transfer learning to produce robust language models which have a competitive performance among existing methods. Meanwhile, as fine-tuning has shown acceptable competence when applied to specific text generation ([See et al. 2019](#); [Zhang et al. 2020c](#); [Keskar et al. 2019](#)), [Mager et al. \(2020\)](#) explored the possibility of fine-tuning the pre-trained transformer language model directly on the sequential representation of AMR graphs, which achieved the first PLM-based method for AMR-to-text. The results proved that a powerful pre-trained Transformer language model (GPT-2) can be fine-tuned to generate text directly from the Penman representation of the AMR graph.

Input Representation. [Mager et al. \(2020\)](#) tested three variants of AMR representation. First, they performed a depth-first search (DFS) in the graph of [Konstas et al. \(2017\)](#), where the input sequence is the path followed in the graph. Second, they eliminated all the edges from the DFS, while keeping only the concept nodes as the input. Third, the Penman representation is used directly to indicate the concept nodes. The three input representations are illustrated below:

DFS	propose :ARG1 develop-01 :ARG1 he :manner energetical
Nodes	propose develop-01 he energetical
Penman	(r / develop-01 :ARG1 (a / develop- 01 :ARG1 (h / he) :manner (e / energetical)))

Fine-tuning. Given a tokenized sentence s_1, s_2, \dots, s_N and sequential AMR representation a_1, a_2, \dots, a_M , its joint probability is maximized by :

$$P_{GPT-2}(s, a) = \prod_{j=1}^N P_{GPT-2}(s_j | s_{1:j-1}, a_{1:M}) \cdot \prod_{i=1}^M P_{GPT-2}(a_i | a_{1:i-1}) \quad (20)$$

During the test, they provide AMR as the context for traditional conditional text generation:

$$\hat{s}_j = \arg \min_{\theta} \{P_{GPT-2}(w_j | w_{1:j-1}, w_{1:M})\} \quad (21)$$

Decoder. Greedy decoding, cluster search and nuclear sampling ([Holtzman et al. 2020](#)) are used in the Decoder.

Limitation. Compared with the benchmark, the performance of the PLM-based method was apparently improved, and it can have satisfied robustness when having a large number of AMR nodes. However, one challenge it faces is that when too many reentrant nodes are introduced, the AMR graph structure becomes complex, making it more difficult for the model to capture the graph structure, which may in turn cause performance degradation.

4. Recent Progress of AMR-to-Text

Previous researchers employed various GNNs to strengthen the performance of AMR-to-Text through exploring the effective representation of the input AMR graph, i.e., the Encoder. In addition, there are many recent developments achieved from a new perspective. Two main areas are selected for further demonstration, which are AMR graph reconstruction, and Decoder optimization.

4.1 AMR Graph Reconstruction

In order to better model the graph structure, Wang et al. (2020b) proposed a novel method for AMR-to-Text utilizing graph structure reconstruction. Meanwhile, two simple but effective auxiliary reconstruction objectives, i.e., link prediction objective and distance prediction objective, are optimized to capture richer structure information and semantic relation in the node representations.

Further, Song et al. (2020) treated the input graph reconstruction as an autoencoding process to preserve the semantic information. Each type of autoencoding loss is focused on different aspects of the input graph (a.k.a. views). In particular, they introduced an auxiliary loss for recovering two complementary views of the input graph (triple relations and linearization graph), allowing the model to be trained to retain the input structure for better generation.

4.2 Decoder Optimization.

Generally, current commonly used Decoder functions like a language model where each word is generated given only the previous word. Therefore, one limitation of such a Decoder is that it tends to produce fluent sentences and may not be able to retain the meaning of the input AMR. Therefore, Bai et al. (2020) proposed a decoder that back predicts projected AMR graphs on the target sentence during text generation. By adding online back-parsing to the Decoder network, the structure information of the source graph is expected to be well preserved. In each decoding step, the model predicts the current word, its corresponding AMR node, and the output edge of the previously generated word. Then, the predicted words, AMR nodes, and edges are integrated as input for the next decoding step. Therefore, the Decoder can benefit from both richer loss and more structural features.

5. Benchmark and Evaluation of AMR-to-Text

In AMR-to-Text, commonly used benchmarks include LDC2015E85, LDC2015E86, LDC2017T10 and LDC2020T02. Meanwhile, NLG is generally used as evaluation metrics, such as BLEU (Papineni et al. 2002), Meteor (Banerjee and Lavie 2005), TER (Snover et al. 2006), Recent CHR++ (Popovic 2017), BERTScore (Zhang et al. 2020) and human evaluation including similarity of meaning and readability. Therefore, we classify the methods of evaluation into automatic metrics and human evaluation.

Table 3
BLEU of some models based on the benchmark LDC2015E86 and LDC2017T10.

Models	LDC2015E86		LDC2017T10	
	BELU	Meteor	BELU	Meteor
Sequence-Based Model				
Seq2Seq (Konstas et al. 2017)	22.0	-	-	-
Seq2Seq + Syntax (Cao and Clark 2019)	23.5	-	26.8	-
Seq2Seq + SA-based (Zhu and Li 2020)	29.66	35.4	31.54	36.02
Seq2Seq + CNN-based (Zhu and Li 2020)	29.1	35.0	31.82	36.38
Graph-Based Model				
Graph2Seq+CharLSTM+Copy (Song et al. 2018)	22.8	-	-	-
Graph2Seq (Beck et al. 2018)	27.5	-	-	-
GCNSEQ (Damonte and Cohen 2019)	24.4	23.6	24.5	24.0
Dual Graph (Ribeiro et al. 2019)	24.3	30.5	27.8	33.2
LDGCN-GC (Zhang et al. 2020b)	30.8	36.4	33.6	37.5
Line Graph + MixGAT (Zhao et al. 2020)	30.6	35.8	32.5	36.8
Transformer-Based Model				
Transformer (Zhu et al. 2019)	25.5	33.2	27.4	34.6
Graph Transformer (Wang et al. 2020a)	25.9	-	29.3	-
GTransformer (Cai and Lam 2020)	27.4	32.9	29.8	35.1
ADJMATMUL (Jin and Gildea 2020)	-	-	31.2	-
HetGT (Yao et al. 2020)	31.8	36.9	34.1	38.1
PLM-Based Model				
GPT-2L Rec.(Mager et al. 2020)	-	-	32.47	36.8
T5-Large (Ribeiro et al. 2021a)	-	-	45.8	43.85
T5-Large STRUCTADAPT (Ribeiro et al. 2021b)	-	-	46.62	-
SPRING (Bevilacqua et al. 2021)	-	-	45.9	41.8

5.1 Automatic Metrics.

In general, evaluation methods such as BLEU(Papineni et al. 2002), Meteor(Banerjee and Lavie 2005) and CHRF++(Popovic 2017) have been frequently used in the NLG field for many years and are gradually becoming the majority researcher’s choice for evaluating models. However, in recent years, a number of researchers found there are many flaws in these evaluation methods. For example, these methods penalize paraphrasing, are highly sensitive to outliers (Mathur et al. 2020), and lack interpretability (Sai et al. 2020). When evaluating AMR-to-Text, some of these issues may become even more complex, because the approach of generating a sentence from its meaning representations is diverse. Therefore, Opitz and Frank (2021) proposed a new metric named $MF\beta$ score attempting to obtain better diagnosis and interpretability for the text generation system, and scalability to other related tasks. In particular, we summarize the BLEU of some models on the benchmark datasets LDC2015E86 and LDC2017T10 in Table 3. It can be seen that with the continuous development of methodology, the BLEU is increasing correspondingly.

Analogously to the above common methods, Zhang et al. (2020a) proposed the BERTScore, which does not directly depend on the same morphology between the generated text and the correct text. Instead, the semantic representation vector of the automatically generated text and

the correct text is obtained through BERT. Afterwards, the BERTScore between two texts is obtained by calculating the similarity between the vectors, without directly relying on the same words and word strings in the text. This method is expected to be well suited for performing the AMR-to-Text, because the same AMR graph can be represented as multiple sentences with the same meaning.

In addition, as the reference-based automatic metrics are unable to fully capture the range of possible outputs, Manning and Schneider (2021) examined a referenceless alternative, which evaluates the adequacy of English sentences generated from AMR graphs by parsing into AMR and comparing the parse directly to the input. Since they found parser quality is highly correlated to the performance of this method, it has the competence to outperform most popular automatic reference-based metrics, including BLEU and BERTScore (but not BLEURT) when automatic AMR parses are manually edited to better reflect the meaning in generated sentences.

5.2 Human Evaluation

In terms of automatic metrics, Gkatzia and Mahamood (2015) found that 38.2% of papers in the NLG field and 68% of papers published in ACL used it for evaluation. However, May and Priyadarshi (2017) found that automatic metrics cannot reliably represent human evaluation. Meanwhile, May and Priyadarshi (2017) summarized the results of the 2017 AMR SemEval shared task, where they incorporated human judgments into the ranking-based evaluation of five systems in the generation subtask. The results indicate that all of these systems are far from performing well in terms of fluency, even though the results previously evaluated by automatic metrics show that these systems are competent. Therefore, a robust automatic evaluation method is urgently needed to provide a more reliable metric for future research.

Meanwhile, Mager et al. (2020) conducted a human evaluation comparing their GPT-2-based system with the other three systems (Guo et al. 2019; Ribeiro et al. 2019; Zhang et al. 2020b; Zhu et al. 2019). Furthermore, Manning et al. (2020) proposed a new human evaluation, which collects the fluency and adequacy scores, as well as the classification of error types. They compared their evaluation results with automatic metrics and found that although the automatic metrics are successful in ranking systems roughly, conducting human evaluation allows for a more nuanced comparison.

As the latest proposed automatic metrics, such as BERTScore (Zhang et al. 2020a), and the referenceless parsing-based evaluation (Manning and Schneider 2021), are not further evaluated compared to human evaluation, there is still a long way for the improvements based on traditional metrics and the analysis of recent advances to go.

6. Future Outlook

Although the recent success of AMR-to-Text, there are still some areas that deserve further exploration. As shown in figure 7, we present some inspirations for the following area, which are AMR graph representation (the intrinsic information of AMR graph and PLM), transfer learning, evaluation methods, and dataset.

The Intrinsic Information. In recently proposed methods, the intrinsic information contained in the AMR graph has been extracted to a relatively large extent, such as the structure information, the node information, the edge information, the dynamic changes, etc. However, due to the complexity, heterogeneity, reentrancy and dynamics of graph data, it is practical to further explore the deeper information hidden in the graph data and the connections and dependencies between the existing found information. Therefore, it is worthwhile for future researchers to design more effective

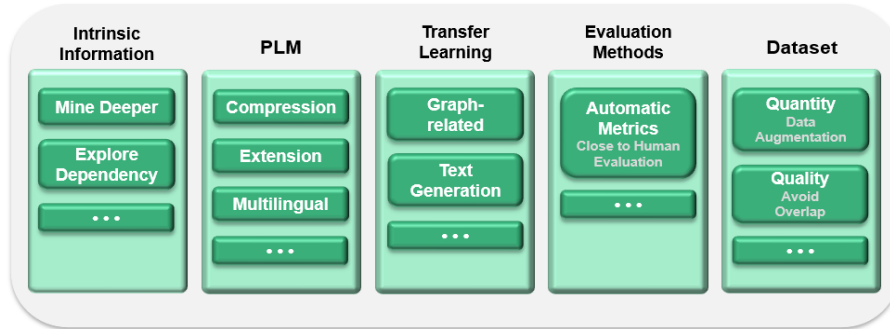

Figure 7
Future Outlook of AMR-to-Text

methods (preprocessing and encoding) to exploit and utilize the information contained in the AMR graph.

PLM. Currently, PLM has revealed the power to obtain stronger performance in AMR-to-Text. Therefore, apart from exploring the intrinsic information contained in the graph data, many of the researchers are concentrating on enhancing the PLM-based model for future research. To begin with, one of the main ideas is to compress the PLM. While PLMs with larger-scale parameters have made progress in AMR-to-Text and other generation tasks, it is necessary to design competitive and generic PLM with fewer parameters for more practical application. Meanwhile, as fine-tuning the PLM achieves the competent performance of AMR-to-Text, it is valuable to consider adding suitable external mechanisms to extend the PLM for further improvement. Moreover, since the current research on PLMs for text generation has focused on English, barriers to dealing with other languages may arise. Therefore, an interesting prospect for future research is to realize multilingual PLMs.

Transfer Learning. In recent years, many powerful AMR-to-Text methods have been proposed to make continuous progress. Since these methods are strongly related to graph representation and text generation, it is promising to apply the model structure in the proposed methods to handle graph-related tasks and other NLG tasks.

Evaluation Methods. As above mentioned, human evaluation can provide a more effective and comprehensive assessment of the performance of the proposed AMR-to-Text method than the commonly used automatic metrics. However, human evaluation is more time-consuming and cannot be used in the assessment as widely and easily as automatic metrics. Meanwhile, since the current automatic metrics are relatively poor, the evaluation through them may misdirect the focus of AMR-to-Text development. Therefore, designing generic, professional, and widely accepted automatic metrics that are close to human evaluation can be expected to facilitate the research on AMR-to-Text to a right direction, and further, the NLG.

Datasets. Leveraging the quality and quantity of the dataset is also important in boosting the performance of AMR-to-Text. In terms of quantity, researchers have previously investigated that data augmentation, such as using large-scale unlabeled data, can further enhance the performance of the models (Zhu et al. 2019). Meanwhile, other researchers are focusing on improving the

quality of the dataset. Du and Flanigan (2021) attempted to remove the overlap in the prevalent dataset for AMR-to-Text to avoid overly-inflated scores in the proposed methods. Currently, the AMR-to-Text field still lacks an effective standard dataset for research. Therefore, it is significant and meaningful to put effort into dataset construction for the AMR-to-Text.

7. Conclusion

In the past few years, AMR-to-Text has attracted the attention of many researchers. However, one of the challenges they faced is AMR graph representation. Thus, they focused more on the field of encoding AMR graphs. We classify their methods into five categories based on the techniques used, which are Rules-based methods, Seq-to-Seq-based methods, Graph-to-Seq-based methods, Transformer-based methods, and PLM-based methods.

Since the neural network-based methods are currently the mainstream of AMR-to-Text, representative methods among the various methods are selected for specific demonstration. Apart from the recent progress in encoding the AMR graph, we present other advances in AMR-to-text, such as AMR reconstruction and Decoder optimization. In addition, we introduced the benchmarks and evaluation methods for AMR-to-Text, as well as the latest improvements in this area. As the above developments converged from various aspects, our ideas for future outlook not only focus on better AMR graph representation, but also extend to transfer learning, evaluation methods and dataset.

In conclusion, much progress has been made in the recent literature on AMR-to-Text, there are still potential areas where more surprising breakthroughs may occur.

Acknowledgments

Acknowledgments

References

- Dzmitry Bahdanau, Kyunghyun Cho, and Yoshua Bengio. 2015. Neural machine translation by jointly learning to align and translate. *CoRR*, abs/1409.0473.
- Xuefeng Bai, Linfeng Song, and Yue Zhang. 2020. [Online back-parsing for AMR-to-text generation](#). In *Proceedings of the 2020 Conference on Empirical Methods in Natural Language Processing (EMNLP)*, pages 1206–1219, Online. ACL.
- Laura Banarescu, Claire Bonial, Shu Cai, Madalina Georgescu, Kira Griffitt, Ulf Hermjakob, Kevin Knight, Philipp Koehn, Martha Palmer, and Nathan Schneider. 2013. Abstract meaning representation for sembanking. In *LAW@ACL*.
- Satanjeev Banerjee and Alon Lavie. 2005. Meteor: An automatic metric for mt evaluation with improved correlation with human judgments. In *IEEvaluation@ACL*.
- Daniel Beck, Gholamreza Haffari, and Trevor Cohn. 2018. Graph-to-sequence learning using gated graph neural networks. In *ACL*.
- Michele Bevilacqua, Rexhina Billoshmi, and Roberto Navigli. 2021. One spring to rule them both: Symmetric amr semantic parsing and generation without a complex pipeline. In *Proceedings of the Thirty-Fifth AAAI Conference on Artificial Intelligence*.
- Deng Cai and Wai Lam. 2020. Graph transformer for graph-to-sequence learning. In *AAAI*.
- Kris Cao and Stephen Clark. 2019. Factorising amr generation through syntax. In *NAACL*.
- Marco Damonte and Shay B. Cohen. 2019. Structural neural encoders for amr-to-text generation. In *NAACL*.
- Jacob Devlin, Ming-Wei Chang, Kenton Lee, and Kristina Toutanova. 2019. Bert: Pre-training of deep bidirectional transformers for language understanding. In *NAACL*.
- Wenchao Du and Jeffrey Flanigan. 2021. Avoiding overlap in data augmentation for amr-to-text generation. In *Proceedings of the 59th Annual Meeting of the Association for Computational Linguistics and the 11th International Joint Conference on Natural Language Processing (Volume 2: Short Papers)*, pages 1043–1048.
- David Duvenaud, Dougal Maclaurin, Jorge Aguilera-Iparraguirre, Rafael Gómez-Bombarelli, Timothy Hirzel, Alán Aspuru-Guzik, and Ryan P. Adams. 2015. Convolutional networks on graphs for learning molecular fingerprints. In *NIPS'15 Proceedings*

- of the 28th International Conference on Neural Information Processing Systems - Volume 2, volume 28, pages 2224–2232.
- Angela Fan and Claire Gardent. 2020. [Multilingual AMR-to-text generation](#). In *Proceedings of the 2020 Conference on Empirical Methods in Natural Language Processing (EMNLP)*, pages 2889–2901, Online. ACL.
- Thiago Castro Ferreira, Iacer Calixto, Sander Wubben, and Emiel J. Kraemer. 2017. Linguistic realisation as machine translation: Comparing different mt models for amr-to-text generation. In *INLG*.
- Jeffrey Flanigan, Chris Dyer, Noah A. Smith, and Jaime G. Carbonell. 2016. Generation from abstract meaning representation using tree transducers. In *NAACL*.
- Sahil Garg, Aram Galstyan, Ulf Hermjakob, and Daniel Marcu. 2016. [Extracting biomolecular interactions using semantic parsing of biomedical text](#). In *Proceedings of the Thirtieth AAAI Conference on Artificial Intelligence, February 12-17, 2016, Phoenix, Arizona, USA*, pages 2718–2726. AAAI Press.
- Jonas Gehring, Michael Auli, David Grangier, Denis Yarats, and Yann Dauphin. 2017. Convolutional sequence to sequence learning. In *ICML*.
- Dimitra Gkatzia and Saad Mahamood. 2015. A snapshot of nlg evaluation practices 2005 - 2014. In *ENLG*.
- Jonathan Graehl, Kevin Knight, and Jonathan May. 2004. Training tree transducers. *Computational Linguistics*, 34:391–427.
- Alex Graves, Abdel-rahman Mohamed, and Geoffrey Hinton. 2013. Speech recognition with deep recurrent neural networks. In *2013 IEEE international conference on acoustics, speech and signal processing*, pages 6645–6649.
- Zhijiang Guo, Yan Zhang, Zhiyang Teng, and Wei Lu. 2019. Densely connected graph convolutional networks for graph-to-sequence learning. *TACL*, 7:297–312.
- William L. Hamilton, Zitao Ying, and Jure Leskovec. 2017. Inductive representation learning on large graphs. In *NIPS*.
- Sepp Hochreiter and Jürgen Schmidhuber. 1997. [Long Short-Term Memory](#). *Neural Computation*, 9(8):1735–1780.
- Ari Holtzman, Jan Buys, Li Du, Maxwell Forbes, and Yejin Choi. 2020. [The curious case of neural text degeneration](#). In *ICLR*.
- Gao Huang, Zhuang Liu, and Kilian Q. Weinberger. 2017. Densely connected convolutional networks. *2017 IEEE Conference on Computer Vision and Pattern Recognition (CVPR)*, pages 2261–2269.
- Lisa Jin and Daniel Gildea. 2020. Generalized shortest-paths encoders for amr-to-text generation. In *COLING*.
- Nitish Shirish Keskar, Bryan McCann, Lav R. Varshney, Caiming Xiong, and Richard Socher. 2019. Ctrl: A conditional transformer language model for controllable generation. *ArXiv*, abs/1909.05858.
- Thomas N. Kipf and Max Welling. 2017. [Semi-supervised classification with graph convolutional networks](#). In *5th International Conference on Learning Representations, ICLR 2017, Toulon, France, April 24-26, 2017, Conference Track Proceedings*. OpenReview.net.
- Ioannis Konstas, Srinivasan Iyer, Mark Yatskar, Yejin Choi, and Luke Zettlemoyer. 2017. [Neural AMR: Sequence-to-sequence models for parsing and generation](#). In *Proceedings of the 55th Annual Meeting of the ACL (Volume 1: Long Papers)*, pages 146–157, Vancouver, Canada. ACL.
- Mike Lewis, Yinhan Liu, Naman Goyal, Marjan Ghazvininejad, Abdelrahman Mohamed, Omer Levy, Veselin Stoyanov, and Luke Zettlemoyer. 2020. [BART: Denoising sequence-to-sequence pre-training for natural language generation, translation, and comprehension](#). In *Proceedings of the 58th Annual Meeting of the Association for Computational Linguistics*, pages 7871–7880, Online. ACL.
- Yujia Li, Daniel Tarlow, Marc Brockschmidt, and Richard S. Zemel. 2016. Gated graph sequence neural networks. *CoRR*, abs/1511.05493.
- Fei Liu, Jeffrey Flanigan, Sam Thomson, Norman M. Sadeh, and Noah A. Smith. 2015. Toward abstractive summarization using semantic representations. In *NAACL*.
- Thang Luong, Hieu Pham, and Christopher D. Manning. 2015. Effective approaches to attention-based neural machine translation. In *EMNLP*.
- Manuel Mager, Ramón Fernández Astudillo, Tahira Naseem, Md Arafat Sultan, Young suk Lee, Radu Florian, and Salim Roukos. 2020. Gpt-too: A language-model-first approach for amr-to-text generation. In *ACL*.
- Emma Manning. 2019. A partially rule-based approach to amr generation. In *Proceedings of the 2019 Conference of the North American Chapter of the Association for Computational Linguistics: Student Research Workshop*, pages 61–70.
- Emma Manning and Nathan Schneider. 2021. Referenceless parsing-based evaluation of amr-to-english generation. In *Proceedings of the 2nd Workshop on Evaluation and Comparison of NLP Systems*, pages 114–122.

- Emma Manning, Shira Wein, and Nathan Schneider. 2020. A human evaluation of amr-to-english generation systems. In *COLING*.
- Nitika Mathur, Timothy Baldwin, and Trevor Cohn. 2020. Tangled up in BLEU: reevaluating the evaluation of automatic machine translation evaluation metrics. In *Proceedings of the 58th Annual Meeting of the Association for Computational Linguistics, ACL 2020, Online, July 5-10, 2020*, pages 4984–4997. ACL.
- Jonathan May and Jay Priyadarshi. 2017. Semeval-2017 task 9: Abstract meaning representation parsing and generation. In *SemEval@ACL*.
- Vinod Nair and Geoffrey E. Hinton. 2010. Rectified linear units improve restricted boltzmann machines. In *ICML*.
- Juri Opitz and Anette Frank. 2021. Towards a decomposable metric for explainable evaluation of text generation from AMR. In *Proceedings of the 16th Conference of the European Chapter of the Association for Computational Linguistics: Main Volume, EACL 2021, Online, April 19 - 23, 2021*, pages 1504–1518. ACL.
- Xiaoman Pan, Taylor Cassidy, Ulf Hermjakob, Heng Ji, and Kevin Knight. 2015. Unsupervised entity linking with abstract meaning representation. In *NAACL*.
- Kishore Papineni, Salim Roukos, Todd Ward, and Wei-Jing Zhu. 2002. Bleu: a method for automatic evaluation of machine translation. In *ACL*.
- Maja Popovic. 2017. chrF++: words helping character n-grams. In *WMT*.
- Nima Pourdamghani, Kevin Knight, and Ulf Hermjakob. 2016. Generating english from abstract meaning representations. In *INLG*.
- Alec Radford and Karthik Narasimhan. 2018. Improving language understanding by generative pre-training.
- Alec Radford, Jeffrey Wu, Rewon Child, David Luan, Dario Amodei, Ilya Sutskever, et al. 2019. Language models are unsupervised multitask learners. *OpenAI blog*, 1(8):9.
- Leonardo F. R. Ribeiro, Claire Gardent, and Iryna Gurevych. 2019. Enhancing amr-to-text generation with dual graph representations. In *EMNLP*.
- Leonardo F. R. Ribeiro, Martin Schmitt, Hinrich Schütze, and Iryna Gurevych. 2021a. Investigating pretrained language models for graph-to-text generation. In *Proceedings of the 3rd Workshop on Natural Language Processing for Conversational AI*, pages 211–227, Online. ACL.
- Leonardo F. R. Ribeiro, Yue Zhang, and Iryna Gurevych. 2021b. Structural adapters in pretrained language models for amr-to-text generation. In *EMNLP*.
- Mrinmaya Sachan and Eric P. Xing. 2016. Machine comprehension using rich semantic representations. In *ACL*.
- Ananya B. Sai, Akash Kumar Mohankumar, and Mitesh M. Khapra. 2020. A survey of evaluation metrics used for NLG systems. *CoRR*, abs/2008.12009.
- Abigail See, Aneesh Pappu, Rohun Saxena, Akhila Yerukola, and Christopher D. Manning. 2019. Do massively pretrained language models make better storytellers? In *Proceedings of the 23rd Conference on Computational Natural Language Learning, CoNLL 2019, Hong Kong, China, November 3-4, 2019*, pages 843–861. ACL.
- Peter Shaw, Jakob Uszkoreit, and Ashish Vaswani. 2018. Self-attention with relative position representations. In *NAACL*.
- Matthew G. Snover, B. Dorr, R. Schwartz, Linnea Micciulla, and John Makhoul. 2006. A study of translation edit rate with targeted human annotation. In *AMTA*.
- Linfeng Song, Xiaochang Peng, Yue Zhang, Zhiguo Wang, and Daniel Gildea. 2017. Amr-to-text generation with synchronous node replacement grammar. In *ACL*.
- Linfeng Song, Ante Wang, Jinsong Su, Yue Zhang, Kun Xu, Yubin Ge, and Dong Yu. 2020. Structural information preserving for graph-to-text generation. In *ACL*.
- Linfeng Song, Yue Zhang, Xiaochang Peng, Zhiguo Wang, and Daniel Gildea. 2016. Amr-to-text generation as a traveling salesman problem. In *Proceedings of the 2016 Conference on Empirical Methods in Natural Language Processing*, pages 2084–2089.
- Linfeng Song, Yue Zhang, Zhiguo Wang, and Daniel Gildea. 2018. A graph-to-sequence model for amr-to-text generation. In *ACL*.
- Sho Takase, Jun Suzuki, Naoaki Okazaki, Tsutomu Hirao, and Masaaki Nagata. 2016. Neural headline generation on abstract meaning representation. In *EMNLP*.
- Zhaopeng Tu, Zhengdong Lu, Yang Liu, Xiaohua Liu, and Hang Li. 2016. Modeling coverage for neural machine translation. In *Proceedings of the 54th Annual Meeting of the Association for Computational Linguistics, ACL 2016, August 7-12, 2016, Berlin, Germany, Volume 1: Long Papers*. The Association for Computer Linguistics.
- Ashish Vaswani, Noam Shazeer, Niki Parmar, Jakob Uszkoreit, Llion Jones, Aidan N. Gomez, Lukasz Kaiser, and Illia Polosukhin. 2017. Attention is all you need. In *Advances in Neural Information Processing Systems 30: Annual Conference on Neural Information Processing Systems 2017, December 4-9, 2017*,

- Long Beach, CA, USA*, pages 5998–6008.
- Petar Velickovic, Guillem Cucurull, Arantxa Casanova, Adriana Romero, Pietro Liò, and Yoshua Bengio. 2018. [Graph attention networks](#). In *6th International Conference on Learning Representations, ICLR 2018, Vancouver, BC, Canada, April 30 - May 3, 2018, Conference Track Proceedings*. OpenReview.net.
- Tianming Wang, Xiaojun Wan, and Hanqi Jin. 2020a. Amr-to-text generation with graph transformer. *TACL*, 8:19–33.
- Tianming Wang, Xiaojun Wan, and Shaowei Yao. 2020b. Better amr-to-text generation with graph structure reconstruction. In *IJCAI*.
- Yonghui Wu, Mike Schuster, Zhifeng Chen, Quoc V. Le, Mohammad Norouzi, Wolfgang Macherey, Maxim Krikun, Yuan Cao, Qin Gao, Klaus Macherey, Jeff Klingner, Apurva Shah, Melvin Johnson, Xiaobing Liu, Lukasz Kaiser, Stephan Gouws, Yoshikiyo Kato, Taku Kudo, Hideto Kazawa, Keith Stevens, George Kurian, Nishant Patil, Wei Wang, Cliff Young, Jason Smith, Jason Riesa, Alex Rudnick, Oriol Vinyals, Greg Corrado, Macduff Hughes, and Jeffrey Dean. 2016. [Google’s neural machine translation system: Bridging the gap between human and machine translation](#). *CoRR*, abs/1609.08144.
- D Xu, J LI, M ZHU, and G ZHOU. 2021. Improving amr2text generation with multi-task pre-training. *Ruan Jian Xue Bao*, 10.13328/j.cnki.jos.006207.
- Shaowei Yao, Tianming Wang, and Xiaojun Wan. 2020. Heterogeneous graph transformer for graph-to-sequence learning. In *ACL*.
- Tianyi Zhang, Varsha Kishore, Felix Wu, Kilian Q. Weinberger, and Yoav Artzi. 2020. Bertscore: Evaluating text generation with bert. In *ICLR 2020 : Eighth International Conference on Learning Representations*.
- Tianyi Zhang, Varsha Kishore, Felix Wu, Kilian Q. Weinberger, and Yoav Artzi. 2020a. [Bertscore: Evaluating text generation with BERT](#). In *8th International Conference on Learning Representations, ICLR 2020, Addis Ababa, Ethiopia, April 26-30, 2020*. OpenReview.net.
- Yan Zhang, Zhijiang Guo, Zhiyang Teng, Wei Lu, Shay B. Cohen, Zuoqiu Liu, and Lidong Bing. 2020b. Lightweight, dynamic graph convolutional networks for amr-to-text generation. In *EMNLP*.
- Yizhe Zhang, Siqi Sun, Michel Galley, Yen-Chun Chen, Chris Brockett, Xiang Gao, Jianfeng Gao, Jingjing Liu, and William B. Dolan. 2020c. [Dialogpt : Large-scale generative pre-training for conversational response generation](#). In *ACL*.
- Yanbin Zhao, Lu Chen, Zhi Chen, Ruisheng Cao, Su Zhu, and Kai Yu. 2020. Line graph enhanced amr-to-text generation with mix-order graph attention networks. In *ACL*.
- Jie Zhu and Junhui Li. 2020. Amr-to-text generation with target syntax. In *CCL*.
- Jiehan Zhu, Junhui Li, Muhua Zhu, Longhua Qian, Min Zhang, and Guodong Zhou. 2019. Modeling graph structure in transformer for better amr-to-text generation. In *EMNLP*.

|

|

—

—

—

—