

Please cite this chapter as:

Andreasson, H., Grisetti, G., Stoyanov, T., Pretto, A. (2023). Sensors for Mobile Robots. In: Ang, M.H., Khatib, O., Siciliano, B. (eds) Encyclopedia of Robotics. Springer, Berlin, Heidelberg.
https://doi.org/10.1007/978-3-642-41610-1_159-1

Sensors for Mobile Robots

Henrik Andreasson, Giorgio Grisetti, Todor Stoyanov, and Alberto Pretto

Definition

A sensor is a device that converts a physical parameter or an environmental characteristic (e.g., temperature, distance, speed, etc.) into a signal that can be digitally measured and processed to perform specific tasks. Mobile robots need sensors to measure properties of their environment, thus allowing for safe navigation, complex perception and corresponding actions, and effective interactions with other agents that populate it.

1 Overview

Sensors used by mobile robots range from simple tactile sensors, such as bumpers, to complex vision-based sensors such as structured light RGB-D cameras. All of them provide a digital output (e.g., a string, a set of values, a matrix, etc.) that can be processed by the robot's computer. Such output is typically obtained by discretizing one or more analog electrical signals by using an Analog to Digital Converter (ADC) included in the sensor.

In this chapter we present the most common sensors used in mobile robotics, providing an introduction to their taxonomy, basic features, and specifications. The description of the functionalities and the types of applications follows a bottom-up approach: the basic principles and components on which the sensors are based are presented before describing real-world sensors (starting from Sec. 5), which

Andreasson and Stoyanov

School of Science and Technology, Örebro University, S-701 82 Örebro, Sweden, e-mail: `{henrik.andreasson, todor.stoyanov}@oru.se`

Grisetti

Department of Computer, Control, and Management Engineering "Antonio Ruberti", Sapienza University of Rome, Italy e-mail: `grisetti@diag.uniroma1.it`

Pretto

Department of Information Engineering, University of Padova, Italy e-mail: `alberto.pretto@dei.unipd.it`

This chapter appears in: Ang, M.H., Khatib, O., Siciliano, B. (eds) Encyclopedia of Robotics. Springer, Berlin, Heidelberg

are generally based on multiple technologies and basic devices. A sensor can be categorized as an input type *transducer*. A transducer is a device that converts a signal from one form of energy (e.g., mechanical, thermal, etc.) into another. Transducers can be used to either inject energy in the environment (*emitters*, or *actuators*) or to capture the amount of energy from the environment (*receivers*). A receiver that converts a measurable quantity, such as light or sound, to an electrical signal is called a *sensor*. In mobile robotics, it is common to define as a sensor also an ensemble of transducers and other devices, packaged together, that cooperate for a specific sensing function. For example, ranging sensors based on sound (sonar or ultrasonic sensors) are composed of both a receiver and an actuator synchronized together to measure distances. Following this definition, transducers are building blocks of sensors: a sensor is composed of one or more receivers, zero or more cooperating actuators, and/or other devices (mechanical, optical, etc.) needed to observe the measured phenomena.

2 Sensors Classifications

Sensors can be classified in several ways; here the most common classifications used in robotics are reported, based on the source of the excitation signal, the measurement domain, and measurement type.

Excitation Signal Source (Passive and Active Sensors): A sensor is generally classified as *passive* if it does not require, except for the signal amplification and digital conversion, a power supply to operate. A passive sensor changes its output in response to an excitation signal generated by an external phenomenon, e.g., a microphone that senses a human voice. On the other side, an *active* sensor requires an external power supply to self-generate the excitation signal, and it measures the environmental reaction to such a signal, e.g. a sonar that emits a sound pulse and then senses the reflected wave of the pulse. An alternative definition used in mobile robotics indicates passive sensors as sensors that include only receiver transducers, and active sensors as sensors that also include one or more emitter transducers.

Measurement Domain (Proprioceptive and Exteroceptive Sensors): A sensor is classified as *proprioceptive* if it measures a quantity that depends only on the internal robot system and its current internal state (e.g. wheels position, rotational speed, etc.). On the other side, an *exteroceptive* sensor measures a quantity that depends on both the robot state (e.g., its position) and the environment surrounding the robot, for example, the distance to the closest obstacle.

Measurement Type: A sensor can be classified on the basis of the type of measurement performed (e.g., robot speed, global position), as reported in Tab. 1, which also includes some sample sensors from which these measurements can be obtained. It is noteworthy to highlight that from some sensors it is possible to get or derive

more than one type of measurement, e.g. from the robot motors encoders, it is possible to derive both the robot position and the robot speed. Likewise, several complex sensors used in mobile robotics are actually composed of different basic sensors embedded in the same case, to obtain measurements of several types at the same time, e.g. an RGB-D camera captures both the three-dimensional (3D) structure and an image of the perceived scene, so it is a sensor able to measure both the range and the light intensity.

Table 1 Measurement type classification of the sensors used in mobile robots

Measurement Type	Example Sensors	Example Applications
Physical contact	Bumpers, Contact switches	Object manipulation
Proximity	Reflective photocells	Emergency stop functions
Acceleration and velocity	Accelerometers, Gyroscopes, Wheels encoders	Dead Reckoning (i.e., short term position estimation)
Relative position and orientation	Wheels encoders, Gyroscopes	Indoor robot localization and mapping
Global position and orientation	Global Navigation Satellite System (GNSS), Magnetometers	Outdoor robot localization and mapping
Range	LiDAR, Sonar, Radars, Stereo cameras, time-of-flight cameras	Object localization, Obstacle avoidance, localization and mapping
Light intensity and color	RGB cameras	Place recognition (e.g., for loop closure detection)

3 Sensors Characterization and Specifications

Manufacturers provide the specifications of their sensors as a set of metrics designed to characterize and describe the operating mode and to measure the sensor performances; the most common are listed below.

Linearity and Non-linearity: A sensor is defined linear if its response y to the measured stimulus x is represented by a linear or affine function, e.g., in the one-dimensional case $y(x) = \alpha x + \beta$, $\alpha, \beta \in \mathbb{R}$. Linearity plays a major role in interpreting the signal. Highly non-linear sensors are usually more complex to model, and the quantization noise tends to vary with the magnitude of the measurement.

Measurement Range and Dynamic Range: The measurement range $[x_{min}, x_{max}]$ is represented by the smallest and largest values of the sensed signal that can be measured by the sensor. Stimulus outside such interval can not be sensed, or they are measured with unacceptable errors, or they can damage the sensor. The ratio between

x_{max} and x_{min} is called *dynamic range*, often represented by its base-10 logarithm multiplied by 20 and measured in decibels.

Sensitivity: The sensitivity of a sensor is defined as the slope dy/dx of the sensor response y . It is a measurement of how much the output of a sensor changes as a result of a change in the measured quantity. An effective sensor should have high sensitivity and, for linear sensors, it is a constant value. A sensor that, for some input signal changes, does not respond with any output changes is in a *saturation* state. This often happens to a sensor that is working outside its *measurement range*.

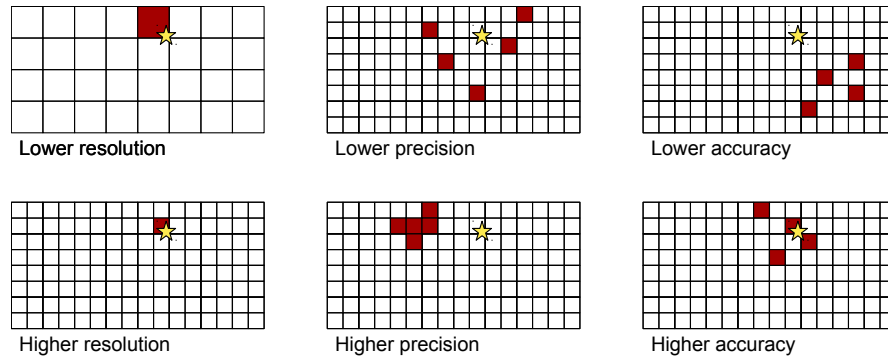

Fig. 1 A visual representation of the resolution, precision, and accuracy parameters for a sensor that provides a two-dimensional (2D) output position, e.g., the position of the robot inside a planar environment. The yellow star is the ideal, perfect measurement (i.e., the ground truth robot position) while the red squares represent a set of output measurements for the steady position represented by the yellow star.

Resolution: The resolution is the minimum variation of the measured signal that can produce a detectable change in the sensor output. For a linear, one-dimensional digital sensor, the resolution can be typically evaluated as the ratio $(x_{max} - x_{min})/\#_y$, where $\#_y$ is the number of possible discrete output values provided by the sensor. In Fig. 1 (left) is reported a representation of two possible resolutions for a sensor that provides a two-dimensional output.

Precision: Precision is a statistical parameter that describes the *reproducibility* of the sensor measurements given a steady sensed signal. For such a signal, an ideal sensor with infinite precision should provide the same measured output over time. Real sensors instead provide a range of values over time, statistically distributed with respect to some probability density function (Fig. 1, center). Typically, the precision is evaluated by assuming this density to be Gaussian, so it can be evaluated by computing the variance of a set of sensor readings for a steady sensed signal.

Accuracy: The accuracy quantifies the *correctness* of output provided by a sensor compared with the real value of the measured signal (Fig. 1, right). The accuracy can be assessed by taking the difference between the average of the measurements of a steady sensed signal and its true value; an estimate of the true value can be measured for instance by using a sensor with a superior accuracy, or through precise experimental design.

Bandwidth: The sensor bandwidth (typically, represented by a maximum frequency) quantifies how it behaves for inputs that evolve with different frequencies. A sensor with low bandwidth can't properly measure high-frequency changes in the measured input (e.g, vibrations, motions, etc.); on the other hand, the bandwidth is often limited by a low-pass filter to avoid to measure high-frequency noise components.

Response Time: The response time is the duration of the period of time that elapses between a change in the input measured signal and when the sensor output changes accordingly.

4 Basic Sensor Components

Sensors that are typically installed on mobile robots are composed of a set of basic devices (receivers and actuators) that directly measure or generate a physical quantity. These components are often integrated and packaged in a single chip to form the so-called Microelectromechanical Systems (MEMS). In this section, the most common forms of basic receivers and actuators used to build more complex sensors are briefly addressed, classified according to the basic physical quantity that they measure or generate.

4.1 Force and Deformation

Force transducers operate by measuring or imposing a deformation to a body subject to that force. This section focuses only on elementary devices capable to exert/sense elementary linear deformations (Fig. 2); electrical motors or dynamos that are complex mechanical compounds are not discussed.

Piezoelectric and Piezoresistive devices measure the force by exploiting, respectively, the voltage or the change in resistance to which a body of a specific material is subject when deformed. Piezoelectric transducers can be used to build both emitters and receivers, while the use of piezoresistive materials is restricted to receivers.

Capacitive devices exploit a condenser whose capacity changes based on the exerted force. Such a capacity can be turned into a voltage by charging the capacitor

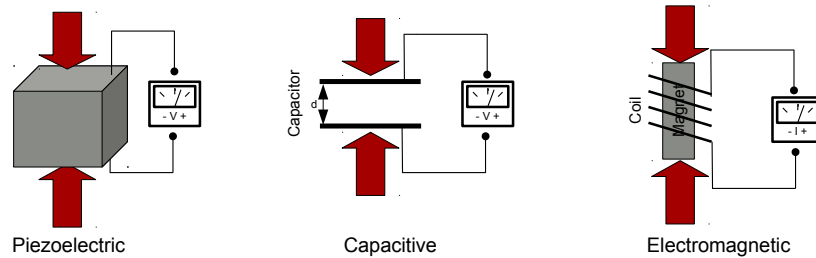

Fig. 2 Overview of basic force transducers.

with a known charge.

Electromagnetic devices use a coil of conductive material wrapped around a moving cylindrical magnet that is left free to slide along the coil's axis. Applying a current to the coil induces a magnetic field that in turn moves the magnet. Electromagnetic force transducers can be used both as emitters and as receivers.

4.2 Light

Light receivers or emitters are used to construct sensors that measure the amount of light radiation in a certain region of the environment or to directly determine the geometry of the environment by means of distance measures to closest objects. The first task is usually accomplished by assembling arrays of light receivers in a one- or two-dimensional matrix to constitute the sensitive element of a camera. The second task is typically done by either measuring the round-trip time of a beam of light or by processing the return of a known light pattern radiated in the environment by an emitter and sensed by a receiver.

Photoresistors are light receivers whose electrical resistance changes depending on the amount of light radiation to which they are exposed. They can be designed so that they are sensible only to a certain spectrum of the optical wavelengths. An electrical signal is obtained by measuring this resistance of the device. This is typically done by measuring the voltage drop at the end of the photoresistor when mounted in a voltage divider configuration. Typical photoresistors exhibit a latency of around 10 ms.

Photodiodes and CMOS imaging sensors are receivers consisting of semiconductor devices that can generate a current dependent on the amount of light radiation hitting them. When used in sensors they are typically driven in reverse configuration (i.e., the cathode is driven positive with respect to the anode), where they exhibit a linear relationship between the current and the illuminance within a certain wavelength spectrum. Integrated arrays of photodiodes and amplifiers couples (photosites, or

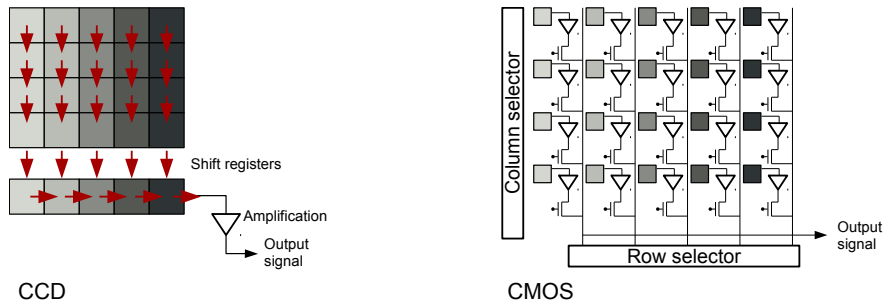

Fig. 3 Overview of the popular CCD and CMOS imaging sensors, framing the same image (a gray level linear gradient). In a CCD, the acquired signals are shifted between photosites within the device, amplification is performed one pixel at a time. In CMOS sensors, each photosite includes its own amplifier. In both cases, the output signal is usually converted to digital by an ADC.

pixels) constitute the typical Complementary Metal-Oxide Semiconductor (CMOS) imaging sensors in consumer cameras.

Charge Coupled Devices (CCD) imaging sensors are semiconductor light receivers typically used in imaging sensors. A CCD appears electrically as an array of light-sensitive capacitors (as in CMOS sensors, *pixels*) that accumulate a charge proportional to the amount of light hitting them in a time interval (integration period). The amplification and reading process is performed sequentially, one pixel at a time, thanks to shift registers. Diagrams of the basis structures of both the CCD and CMOS imaging sensors are reported in Fig. 3.

Light Emitting Diodes (LED) are semiconductor light emitters that produce light radiation when traversed by a current. An individual LED can emit light only in a specific light spectrum, that depends on the doping of its silicon layer.

Lyotropic Liquid Crystals are materials whose molecular configuration changes depending on the current traversing them. A change in the configuration results in a change in the transparency to specific light wavelengths. Usually liquid crystals are assembled in arrays to form light filters used in conjunction with a light emitter to construct projectors or LCD displays.

4.3 Electromagnetic Field

Electromagnetic transducers are more commonly known as antennas. They are composed of an array of conductors. When this array is exposed to an electromagnetic field, it produces a current dependent on the electromagnetic field to which it is exposed. Antennas can be built to have different directionality, and they can be used both as emitters and as receivers. A common use of antennas is in GNSS (Global

Navigation Satellite Systems) sensors, where they are used as receivers to sense the signal emitted by the satellites. Radar (see Sec. 10.3) represents another use of antennas where they are used in a highly directional emitter/receiver configuration to determine the range of an object by measuring the round-trip-time of an electromagnetic pulse.

4.4 Magnetic Field

Magnetic field in mobile robotics is exploited mostly to sense the direction of the magnetic North. Magnetic field receivers are called magnetometers and can rely on one of the following technologies.

Hall Effect magnetometers consist in a conductor that is traversed by a current. When subject to a magnetic field, the conductor exhibits a voltage in the direction orthogonal to the current traversing it. The intensity of the magnetic field along the direction orthogonal to the flow of current can be measured through this voltage.

Magnetoresistive magnetometers are made of stripes of NiFe magnetic film, whose resistance changes when exposed to a magnetic field. They have a well-defined axis of sensitivity.

4.5 Converting Signals

All the receivers mentioned above generate an electric signal. Depending on the type of sensor, one is interested in measuring different characteristics of the signal. The most prominent are the magnitude, the time at which an impulse arrives, or the phase of a periodic signal.

The **Magnitude** is converted into a digital number through an analog-to-digital converter (ADC). This process is subject to an unavoidable quantization error that occurs when a continuous quantity is discretized. The time required for conversion and the noise of the resulting measure greatly depends on the type of ADC used.

The **Time** at which an impulse is received is usually captured by a comparator coupled with a free-running, high-frequency counter. When the impulse is received, the counter is stopped and its value is read. The resolution of these devices depends on the counter's frequency. The input signal is typically preprocessed by a filtering stage that avoids spurious readings due to noise in the input.

The **Phase difference** between two periodic signals is the fraction of a cycle that separates the two in phase from the complete overlap. The phase is indirectly used to determine the time difference between the two signals.

5 Proximity and Contact Sensors

A proximity sensor is able to sense objects placed in front of it or nearby, at a fixed or parameterizable distance. If the distance is zero, it is called a contact sensor. These sensors are often used in mobile robots for safety functions, for example, to implement emergency stop behaviors in case of unexpected obstacles; they are also used as navigation sensors in simple mobile robots as robot vacuum cleaners.



Fig. 4 Examples of an Omron E3FA-D diffuse-reflective proximity sensor (left) and a VEX Robotics bumper (right).

Photoelectric proximity sensors (e.g., Fig. 4, left), also called diffuse-reflective sensors, are typically composed of an emitter/receiver couple embedded in the same case. An emitter (e.g., a *LED*, Sec. 4.2) transmits a light radiation with a defined wavelength, direction, and beam angle; a receiver placed in the line-of-sight of the emitter (e.g., a *photoresistor* sensitive to the specific wavelength, Sec. 4.2) senses the light eventually reflected back from a nearby object. These devices usually output a voltage corresponding to the detected distance, or a digital output that changes if the distance drops below a fixed distance threshold.

Bumpers (Fig. 4, right) are simple contact sensors that detect a physical collision by means of the pressure or release of a microswitch attached to a protective case designed to receive shocks.

6 Encoders

An encoder is a proprioceptive device that converts a linear position (*linear encoders*) or an angular position (*rotary encoders*) into a digital code. The latter type is widely used in mobile robotics, to measure the angular position of the robot wheels. From this information, knowing the wheels' diameter and track, it is possible to derive information such as the linear and rotational velocities of the robot, and consequently an estimate of its relative motions in a planar environment. The most important type of rotary encoders are:

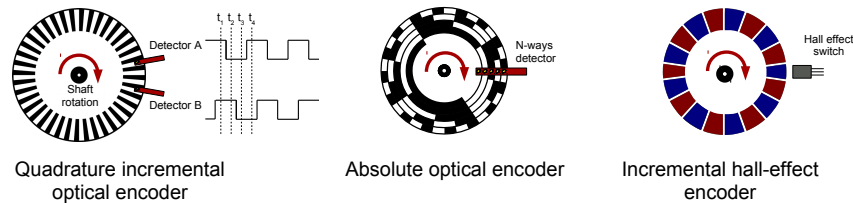

Fig. 5 Overview of three types of encoders.

Optical encoders: in their simpler implementation, they are composed of two opposite transducers: a light emitter (e.g., a LED) and a photoreceptor (see Sec. 4.2). Between the transducers pair, it is placed a disk (e.g., Fig. 5, left), fixed to the shaft, with a sequence of transparent (white in Fig. 5) and opaque areas. Depending on the angular rotation of the shaft, the photoreceptor can detect or not the light diffused by the LED, providing in output a square wave. Incremental encoders just provide information about the motion of the shaft, by counting the periods (*tics*) of such wave. The quadrature incremental encoder improves this design by employing a second emitter-detector pair, shifted in phase of 90 degrees with respect to the first square wave. Combining the two output waves, it is possible to increase the resolution by 4 times while detecting the direction of rotation. Absolute encoders (e.g., Fig. 5, center) also provide the absolute position of the shaft by employing multiple concentric discs and detectors: for each tic, the disc provides a unique binary code.

Hall-effect encoders: they are composed of a sequence of north-south magnetic poles, equally spaced and arranged in a circle (e.g., Fig. 5, right). A Hall effect magnetometer (see Sec. 4.4) placed near the disc is used to measure the magnetic field. Often, the magnetometer is combined with a threshold detector, to provide in output a square wave: in this case, the operating principle is very similar to the one presented for the optical encoders.

7 Global Positioning Systems

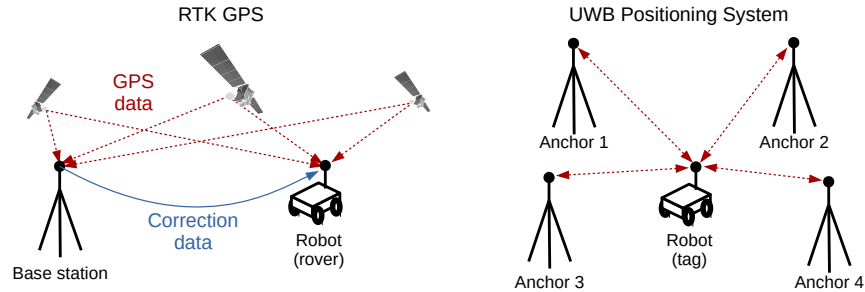

Fig. 6 Operating principle of RTK GPS system (left); a simple ultra-wideband positioning system (right).

A simple way to localize a mobile robot is to use a set of localized and distinguishable landmarks or beacons, spread in the environment where the robot moves. By measuring the distance and/or the bearing from one or more beacons, the robot can infer its global position. Global Navigation Satellite Systems (GNSSs) and Ultra-wideband (UWB) positioning systems build upon this principle to provide the robot with positioning in outdoor and indoor environments.

7.1 Outdoor Positioning: Global Navigation Satellite System Receivers

In GNSSs, the set of beacons is represented by a satellite constellation orbiting in different orbits, to ensure global coverage. Each satellite constantly and synchronously transmits its identity, transmission time, and position. A GNSS receiver can sense signals (see also Sec. 4.3) from a subset of satellites and, by multiplying the speed of light by the time elapsed from the transmission time, it can estimate the distance to each sensed satellite (often called "pseudorange") hence, by using trilateration techniques, its position, represented by its longitude, latitude, and elevation. GNSS receivers can't work indoor or in the presence of occlusions that do not allow to receive enough satellite signals. Among the GNSSs, the American Global Positioning System (GPS) is by far the most used. Improvements of this system include:

Differential Global Positioning Systems (DGPS), where the GPS receiver communicates with one or more geo-located reference (base) stations to correct the common errors in the measured pseudoranges (e.g., due to clock drifts, transmission delays in the ionosphere, etc.).

Real-time kinematic (RTK) positioning technique (see Fig. 6, left), which uses as input both the information sent by the satellites and the carrier waves of the received signals. The distance with respect to a satellite is basically calculated by multiplying the wavelength of the carrier by the number of full cycles between the satellite and the receiver and adding the phase difference. As in DGPS, RTK systems exploit a base station that transmits the phase of the carrier it observes to all rovers (e.g., mobile robots) to provide real-time corrections. Correction data is typically transmitted by using a radio modem, for example in the UHF band. RTK receivers, coupled with a geo-located reference station, enable to improve the localization accuracy from a nominal GPS accuracy which, depending on the environment, ranges from 5 to 15 meters, to centimeter-level accuracy.

7.2 Indoor Positioning: Ultra-wideband Positioning Systems

Ultra-wideband refers to a technology for transmitting radio signals through the use of extremely short energy pulses (duration nanoseconds to microseconds) and therefore with very wide spectral occupation (frequencies between 3.1 and 10.6 GHz). UWB can provide a high data transfer rate with low power consumption. This technology is used in real-time positioning systems, relying on concepts similar to GNSS. Typically a set of UWB beacons called *anchors* is distributed in the environment at fixed, known locations (see Fig. 6, right), while a UWB *tag* is installed on the agent to be localized (e.g., a mobile robot). Unlike GNSS, communications are bidirectional. Basically, UWB positioning systems rely on two alternative algorithms:

Time Difference of Arrival (TDOA): The UWB tag should constantly broadcast a message stating its identity; nearby anchors will receive it at different times as their positions (and distances) are different. If the clocks of the anchors are synchronized, it is possible to use these time differences to retrieve the position of the tag through triangulation.

Time of Flight (TOF): To estimate the ranges between UWB devices in the absence of a global clock, a two-way protocol is used to measure the round trip time of messages. A message is sent by the UWB tag to the anchors and immediately bounced back from them: from the flight time of the signal, the distance between the anchor and the tag can then be measured, hence the tag position can be estimated through triangulation.

The orientation of the tag can be achieved by using a three-dimensional arrangement of its antennas. When the wavefront of the signal passes through the antennas system, it will hit each antenna at a different time, depending on its direction. This direction can be obtained from the arrival time differences, by resolving a linear system of equations. Since the time interval is typically extracted from the phase difference between a pair of antennas and this interval can be larger than the wave-

length, wraparounds require to be taken into account.

UWB positioning systems can typically achieve sub-meter accuracy and, for some special use cases, a few centimeters accuracy. They can be used both in outdoor and indoor environments but, since they require adequate anchors coverage, the latter are the typical context of application. Although attractive, the use of UWB presents some issues since signals at this frequency are absorbed by bodies with high water content and deflected by metal structures; hence to be reliable, several anchors need to be used.

8 Inertial and Heading Sensors

Inertial sensors are based on the principle of inertia, i.e. the resistance of a body to change its current state of stillness or motion with constant linear or rotational velocity. The most common inertial sensors are the accelerometers and gyroscopes. They are often combined together inside sensor compounds called Inertial Measurement Units (IMUs), often along with a heading sensor such as a compass.

8.1 Accelerometers

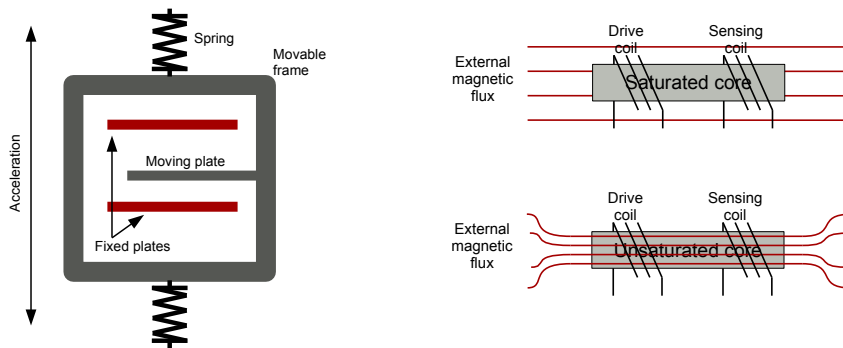

Fig. 7 A basic MEMS accelerometer sensing unit (left); unsaturated and saturated magnetically permeable core in fluxgate compasses (right).

Accelerometers are devices that measure the linear acceleration they undergo along a defined axis. The acceleration is typically converted into either a force or a deformation (see Sec. 4.1) through some mechanical construction. When operating on the Earth, the gravitational acceleration is usually the dominant component in the

acceleration vector of a body, and its direction, as well as magnitude, plays a crucial role in having reliable measurements.

Piezoelectric accelerometers, in their basic implementation, build upon a mass-spring-piezoelectric material stack: the mass-spring system converts the acceleration in a force (i.e., a displacement), such force is then measured by the piezoelectric element by means of change in voltage or in resistance.

Capacitive accelerometers use a system like the one shown in Fig. 7 (left), composed of a moving element with not negligible mass tethered by tiny springs to the accelerometer frame. Both the moving and fixed elements are equipped with plates to form a variable capacitor circuit. When experiencing an acceleration, the moving frame changes its position with respect to the fixed accelerometer frame, so resulting in a change of capacity that can be turned into an electrical signal that is proportional to the sensed acceleration. MEMS accelerometers typically use such configuration as basic sensing unit.

8.2 Gyroscopes

Devices used to measure the orientation are commonly known as gyroscopes. The most common principle is to exploit the inertia of a rotating or vibrating body, which tends to preserve the initial body's orientation. More expensive fiber-optic gyroscopes rely on the Sagnac effect on light and are in fact ensembles of different emitters, receivers, and processing devices.

Rotating Structure Gyroscopes use a spinning disk mounted on a structure that allows the disk to preserve its orientation when the support is rotated. Thanks to the rotational inertia, the disk preserves its absolute orientation. Measuring the orientation of the disk with respect to the structure provides the relative rotation from when the gyroscope was first started. Frictions in the structure might result in a loss of accuracy over time. These types of transducers are not used in common mobile robots, but presented here for completeness.

Vibrating Structure Gyroscopes (VSG) exploit the fact that a vibrating object tends to vibrate along the same plane, even if the orientation of its support changes. When the support is rotated, the vibrating structure exerts a force on the support. Measuring this force the *rate* of rotation can be measured. Alternatively, if the plane is left free to move one can measure its inclination. Multiple sensors mounted with non-co-planar orientations allow to estimate the full three-dimensional rotational velocity vector. Piezoelectric and MEMS gyroscopes fall into the VSG category. These types of gyroscopes do not directly provide absolute orientation, but the rotational rate. Absolute orientation can be obtained by integrating the rotational rate over time.

Fiber-Optic Gyroscopes (FOG) exploit the Sagnac effect that results in the interference between two beams of light that depends on the rotational rate. The interference figure generated by the light beams is then related to the rotational rate. Usually, FOGs convey a laser beam in a winding made of optical fiber to increase the length traveled by the light and thus magnifying the interference. Fiber-optic gyroscopes are highly accurate and they can provide accurate estimates of orientation even after an integration procedure. This comes at the cost of being substantially more expensive and bulky than their MEMS counterpart.

8.3 Compasses

Compasses are sensors for measuring the direction of the Earth's magnetic field.

Hall Effect compasses used in mobile robots are typically implemented using two or three perpendicular Hall Effect magnetometers (see Sec. 4.4).

Fluxgate compasses are more expensive devices that however can provide superior accuracy. The basic element of a fluxgate compass is a magnetically permeable core wound by two coils of wire (Fig. 7, right): one is used to induce a magnetic field (drive coil), the other to measure the magnetic field (sensing coil). If the induced magnetic field saturates the permeable core, the flux of any external magnetic field (e.g., the Earth's magnetic field) will be unaffected by the presence of the saturated core, and the sensing coil will measure only the auto-induced field. Conversely, the external flux tends to pass toward the permeable core, inducing an electromotive force that can be measured by the sensing coil. By integrating two perpendicular elements of this type, and alternating their saturation and unsaturation states, it is possible to compute the direction of the external magnetic field by taking into account the phase differences with respect to the induced magnetic field.

8.4 Inertial Measurement Units (IMUs)

IMUs are composed of a tri-axial cluster of accelerometers and a tri-axial cluster of gyroscopes, usually based on MEMS technology. The two triads define a single, shared, orthogonal 3D frame, and they are often associated with a magnetometer (Fig. 8, left). An AHRS (Attitude and Heading Reference System, e.g., Fig. 8, right) IMU provides 3D orientation by internally integrating the gyroscopes and fusing this data with the accelerometer and the magnetometer data. IMUs are often used in mobile robotics to integrate and to improve the consistency and the reactivity of the robot navigations systems, e.g., in GNSS-based navigation systems.

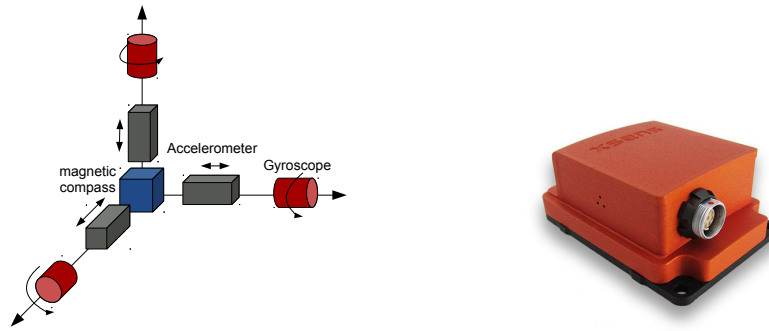

Fig. 8 Conceptual arrangement of sensors within an IMU (left); the XSens MTi-300 AHRS IMU (right).

9 Digital Cameras



Fig. 9 Two examples of digital, area scan cameras. A Basler Dart without lens, with visible CMOS imaging sensor (left); an IDS uEye with mounted lens.

Digital cameras (also called *area scan cameras*) are devices able to produce two-dimensional (2D) arrays (called *images*) of measurements of a specific electromagnetic radiation (e.g., the visible light) coming from non-occluded surfaces of a framed three-dimensional (3D) scene. In this 3D-2D projection, one dimension (i.e., the points' depth) is anyhow lost.

The basic components of a digital camera are (a) an imaging sensor, e.g., a CCD or a CMOS (see Sec. 4.2, e.g., Fig. 9, left); (b) an optical system, called *lens*, used to route the sensed information (e.g., the visible light) from each 3D point toward a 2D point of the imaging sensor (e.g., Fig. 9, right); (c) an internal ADC used to convert each pixel measurement into a digital value.

In nature, each 3D point constantly emits radiations that are spread in all directions in the space, possibly reaching the whole area of an imaging sensor exposed to such

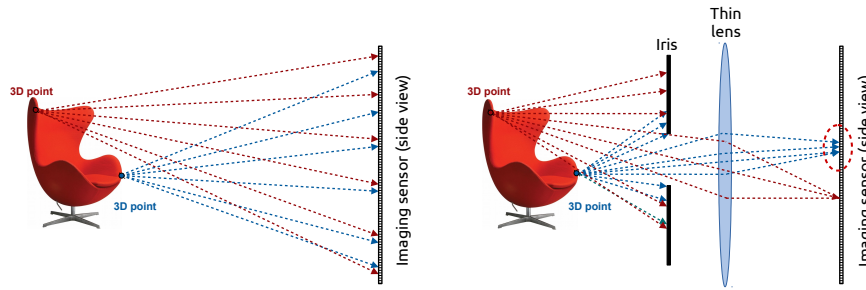

Fig. 10 Without a lens, each 3D point of the scene will project its radiation into each point of the 2D imaging sensor, producing a useless image (left); A lens in front of the sensor (right), here represented by its simplest model, the *Thin lens model*, is used to mitigate as possible this phenomenon.

radiations without a lens (see Fig. 10, left). In the ideal case, for each 3D point emitting such omnidirectional radiations, there should be exactly one 2D point of the imaging sensor that receives a single ray of this and only this radiation. This ideal model is called *Pinhole model*. The aim of the lens is to approximate the ideal case by routing as possible multiple radiation rays coming from the same 3D point toward a single 2D point of the imaging sensor (see Fig. 10, right). This is also obtained by introducing a barrier with a central opening (called *Iris*) to block most of the rays. Although this model (called *Thin lens model*) only approximates the ideal one (e.g., the lower 3D point of the right side of Fig. 10 is projected in a neighborhood of points into the 2D imaging sensor), this model and especially the Pinhole model are commonly used to describe and model real cameras. Cameras that fall into such model are also called *perspective cameras*.

Digital cameras can be used in a very wide range of applications in mobile robotics, among others: place recognition, visual servoing, ego-motion estimation, SLAM (Simultaneous Localization and Mapping), object detection and classification, etc.

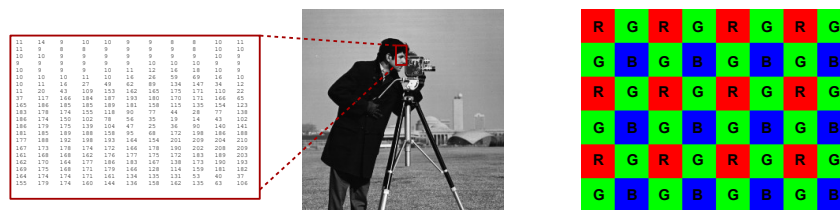

Fig. 11 A portion of a single channel, gray level *image* and the corresponding sub-picture (left); Bayer arrangement of an RGB imaging sensor (right).

Gray Level (GL) cameras are used to simulate the human visual system by measuring the *intensity* of the electromagnetic radiations that lie within the *visible light spectrum*, that corresponds to a range of wavelengths from about 380 to about 740 nanometers. CMOS or CCD imaging sensors used in such cameras are designed to be sensible only to this spectrum. The provided output is a *brightness* image: low radiance 3D points will be mapped into small pixel values, saturating toward the zero value; conversely, high radiance points will be mapped into high pixel values, saturating toward the largest integer representation of the digital sensor. To be easily interpreted by the human eye, an image can be represented by a *picture*, that maps each pixel value into a visible "color", in this case a gray level (e.g., Fig. 11, left).

Color cameras extend the functionality of GL cameras by providing *color vision* capabilities, i.e. by measuring also the *wavelength* of the electromagnetic radiations spread by 3D points. Color cameras are often called *RGB cameras* since they usually employ the *RGB additive color model*, that represents the color information by means of three-channel images. Color cameras imaging sensors include three types of photoreceptors; each type is sensible to a specific wavelength spectrum centered around one of the three primary colors of the RGB model: red, green, and blue. For each pixel, such cameras provide a triad of values corresponding to the intensity of these three colors, so reproducing a wide range of colors. An RGB camera can be assembled by employing three separate imaging sensors, each one sensitive to a specific wavelength spectrum, and by a prism that splits each light beam coming into the lens into three beams that are projected in exactly the same 2D locations of each of the three sensors. A simpler and more popular implementation employs a single imaging sensor in which each pixel is sensitive to a specific wavelength spectrum. The distribution of the pixels follows a fixed pattern, e.g. the Bayer arrangement depicted in Fig. 11 (right). In this case, each pixel provides a single value, corresponding to a specific spectrum. A special interpolation algorithm is then used to recover the R, G, and B values for each pixel.

Digital cameras can be used also to detect radiations that are not visible to humans, such as near-infrared (NIR) radiations. They are basically GL cameras sensitive to wavelengths that spread from 750 to 1400 nanometers.

9.1 Omnidirectional Cameras

Perspective cameras usually are able to frame in one image only a portion (*field of view*) of the surrounding scene. This limitation is overcome by omnidirectional cameras, able to provide a field of view of at least 180 degrees in one or both horizontal and vertical directions. An omnidirectional camera (sometimes called *panoramic camera*) can be implemented starting from one or more digital cameras, e.g.: (a) by using a *fisheye lens*, that is a lens that provides a very wide angle of view (e.g., Fig. 12, left); (b) by placing in front of the lens a special mirror, e.g. parabolic



Fig. 12 A Fujinon fisheye lens (left); a hyperbolic mirror for catadioptric cameras (center); the Flir Ladybug 5 polydioptric spherical camera (right).

or hyperbolic (Fig. 12, center) to form a *catadioptric camera*; (c) by assembling an array of cameras that frame different points of the scene but have some overlaps between them (e.g., Fig. 12, right) to form a *polydioptric camera*.

Due to the large field of view, an omnidirectional camera can't be modeled by using the standard Pinhole model: a *spherical projection model*, for instance, is a more suitable model to represent such type of cameras.

9.2 Event Cameras

Standard cameras sample the scene light synchronously, at a fixed frame rate, e.g., 60 fps (frames per second). In contrast, event cameras are *asynchronous* sensors that measure per-pixel brightness changes and generate a stream of events representing brightness changes. As soon as a pixel detects a brightness change greater than a predefined threshold, an event is sent. Each event is represented by a timestamp, the pixel position, and the sign of change. The output of an event camera depends on the dynamics of the scene: for a static scene, it does not produce any output; for a scene with several moving structures, it produces a number of events depending on the apparent motion. Similarly to CMOS of standard cameras (Fig. 3), the imaging sensor of event cameras is organized as an array of photoreceptors, but in this case each pixel is coupled with a comparator to detect events and is connected with a shared digital output bus.

Even if their use in mobile robots is less immediate compared to traditional cameras, event cameras offer attractive properties such as low latency, high speed, high dynamic range, and reduced motion blur. Event cameras can be used, for example, for obstacle avoidance, object tracking, and SLAM in highly dynamic environments and/or in case of high-speed robot motions.

10 Ranging Sensors

Ranging sensors provide the distance to objects on a defined portion of the surrounding scene. They can be considered an extension of the proximity sensors (Sec. 5) since, compared to the latter, ranging sensors directly output metric distances to objects, and provide extended field of view or extended measurement range (Sec. 3). Ranging sensors applied to mobile robots can be used in several applications, among others robot localization, SLAM, 3D environment reconstruction, object localization, and obstacle avoidance.

Such sensors output arrays of distances (called *ranges*), each one associated with a defined direction of measurement, or equivalently the projection of such distances (called *depths*) along a fixed direction defined by one of the axes of the sensor coordinate system. A 2D array of ranges is often called *range image*, while a 2D array of depths is called *depth map*. Cameras that provide a depth map are generally called *depth cameras*. From both ranges and depth information, it is possible to generate a *point cloud* (e.g., Fig. 17, right) that is a vector of 3D points that represents samples of the 3D structure of the surrounding scene. In the following, we briefly present the most common ranging sensors.

10.1 Sonar and Ultrasonic Sensors

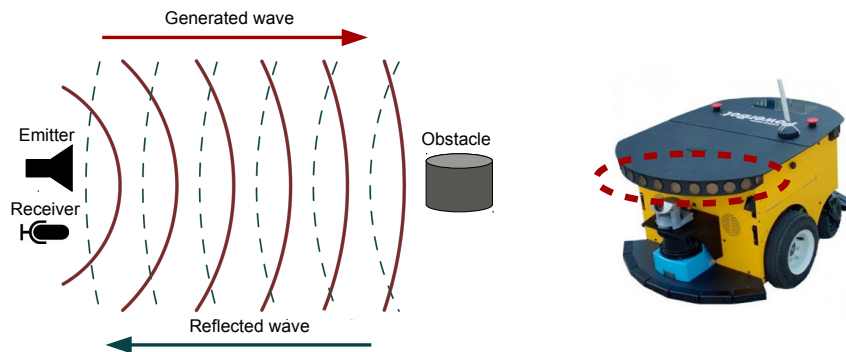

Fig. 13 Operating principle of sonars (left); The red dashed ellipse highlight the array of sonars that equip the MobileRobots PowerBot platform (right)

Sonar (acronym for Sound Navigation and Ranging) are devices that use sound waves to detect objects and measure distances. Passive sonar devices only perceive sounds, while active sonars also emit pulses of sound: the latter are commonly used in mobile robots for obstacle avoidance and self-localization. Active sonars consist of an emitter/receiver pair measuring the distance to an obstacle from the round-trip

time of an emitted pulse (Fig. 13, left). The pressure wave (sound) that is emitted can have different frequencies ranging from very low to high (ultrasound). The latter are the ones commonly used in sensors for robotics, which are usually called *ultrasonic sensors*. The cone of the emitted signal can be varied: the narrower the cone, the higher the angular resolution of the sensor. In order to have multiple readings at different directions, multiple sonar devices need to be configured in an array (e.g., Fig. 13, right). Transducers used to build sonars lie in the family of the force and deformation transducers (Sec. 4.1).

Piezoelectric Sound Transducers rely on materials that generate a voltage when their shape is changed. This change in shape occurs as a consequence of sound waves. They are used both for detecting sound in the audible and in the ultrasound frequency bands. Piezoelectric transducers can also be used to generate a sound, since piezoelectric materials change shape when subject to a voltage.

Capacitive Microphones are condensers that change their capacity when exposed to a sound wave. The charge in the capacitor results in a voltage that depends on the varying capacity and is thus related to the pressure exerted by the sound waves on the transducer's membrane.

10.2 LiDAR

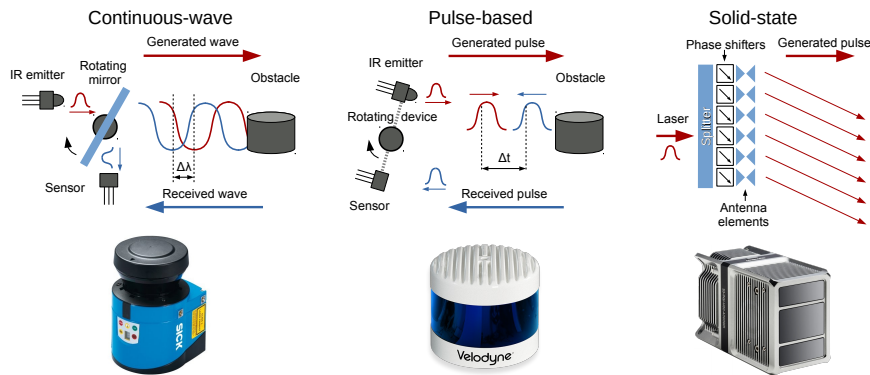

Fig. 14 Operating principles (top row) of three types of LiDAR (bottom row): continuous-wave LiDAR with rotating mirror for the SICK LMS 100 (left column); pulse-based LiDAR with spinning laser/detector pairs for the Velodyne Alpha Puck LiDAR that exploits an array of 128 pairs (central column); solid-state LiDAR that uses an optical phased array to deflect laser beams for the Quanergy S3-2 (right column).

LiDAR (acronym for Light Detection And Ranging) devices exploited in mobile robots use coherent light sources (i.e., *lasers*, typically at infrared wavelengths) to measure the distance and reflective properties of the environment.

There are two main LiDAR technologies, with different working principles:

Continuous-wave (CW) LiDARs (also known as phase-shift-based LiDARs) detect the range by measuring the *phase difference* $\Delta\lambda$ between a generated continuous wave and the reflected wave backscattered by an object encountered along the sensor line of sight (see Fig. 14, left);

Pulse-based (PB) LiDARs measure directly the time-of-flight, i.e. the round-trip-time of a pulsed light (see Fig. 14, center). This type needs very short laser pulses and high temporal accuracy, considering that the speed of light is 0.3 meters/nanosecond.

Standard point-based LiDARs can only measure one point at a time per emitting diode. However, since the time for a single range measurement is rather short, a sequence of measurements can be rapidly acquired by deflecting the beam. This is done either by employing a deflecting mirror (e.g., as in Fig. 14, left) or by mounting the transmitting/receiving element on a movable support that rotates around one or two axes in order to acquire 2D planar scans or 3D range images (e.g., as in Fig. 14, center). To acquire more data in parallel, *multi-channel LiDARs* use several diodes pointing in different directions, usually arranged to acquire a planar profile in one shot. By rotating or translating the diodes array, it is possible to generate a range image. Current state-of-the-art systems offer up to 128 pulse-based diodes that can generate 360-degree range images.

Solid-state LiDARs Recently, solid-state LiDARs are entering the market of sensors for mobile robots. These sensors allow to obtain a dense 3D scan of the surrounding environment without using mechanical tools for deflecting the laser beams. Solid-state LiDARs typically use a pulsed laser that feeds an *Optical Phased Array* (OPA) that is a 2D array of closely spaced (around 1 μm) optical antennas. Variable phase control is applied at each antenna to generate a radiation pattern that points in the desired direction (see Fig. 14, right).

Along with sonar arrays, LiDARs are the most commonly used sensors in mobile robot navigation and obstacle avoidance. Compared to sonars, LiDARs have several advantages: (i) increased range; (ii) higher frequency; (iii) increased accuracy. The disadvantages of a LiDAR compared to a sonar are higher cost and greater sensitivity to fog and dust, although sensors that report multiple return echoes are nowadays more common, resulting in greater robustness to adverse events.

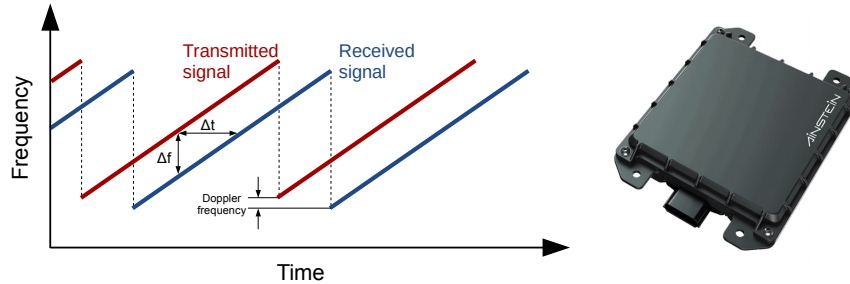

Fig. 15 Operating principle of Frequency-Modulated Continuous-Wave (FMCW) radars (left); The Ainstein O-79 Imaging Radar (right).

10.3 Radar

Similar to LiDARs, radar devices (acronym for Radio Detection And Ranging) emit an electromagnetic wave, but uses radio waves (wavelengths typically between 3 mm and 30 cm) instead of laser light. The signal is transmitted and received by two distinct antennas or antenna arrays when required to estimate the angular positions of objects. Compared to LiDARs, radars have lower angular and range resolution/accuracy but this disadvantage is compensated by the possibility of using the Doppler effect to compute the relative velocity between the sensor and the detected objects. Another key benefit of radars is their robustness to harsh environmental conditions such as snow, fog, rain, dust etc. Radars typically used in automotive and robotics are based on FMCW (Frequency-Modulated Continuous-Wave) transceivers, have a frequency range spanning from 20 to 80 GHz, and can detect the position, relative speed, and direction of motion of objects up to 200 meters. FMCW radars emit a signal called *chirp* where the frequency varies linearly over time. The difference between the frequency of the signal sent and that received is linearly related to the distance from the radar of the object that generated the reflected signal (see Fig. 15, left). Nowadays, Cascade/Imaging Radar (CIR) systems are becoming very popular (e.g., Fig. 15, right): in CIRs, multiple FMCW transceivers are cascaded together, to increase operational safety and achieve high angular resolution, thus enabling to generate a dense 3D point cloud mapping of the surrounding environment.

10.4 Time of Flight Cameras

Time of Flight (ToF) Cameras can be considered as the meeting point between LiDARs and digital cameras. As LiDARs, they use projected laser light to measure the distance from the surrounding objects, following one of the two main LiDAR's operating principles i.e., continuous-wave (e.g., Fig. 16, center) or pulse-based (e.g., Fig. 16, right), see Sec. 10.2. As cameras, they employ a 2D imaging sensor (e.g., a



Fig. 16 Operating principle of ToF cameras (left); MESA Imaging SR4500 continuous-wave ToF camera (center); Advanced Scientific Concepts GSFL-4K pulse-based ToF camera (right).

CCD or a CMOS) sensitive to the projected light.

ToF cameras typically use an array of infrared (IR) light emitters that illuminate the whole scene; the emitters are usually arranged around the IR imaging sensor, providing in output a depth map of the framed scene (Fig. 16, left). Differently from LiDARs, ToF cameras are able to measure distances of a large portion of the scene in one single shot. On the other hand, the fact that they illuminate the whole scene and not individual points like LiDARs introduces some important limitations, such as the *multipath interference* problem, caused by multiple projections of light rays coming from different objects into one single photoreceptor. Since each light ray has a different phase shift, the sum of such components will result in a wrong, random phase shift.

10.5 Stereo Cameras

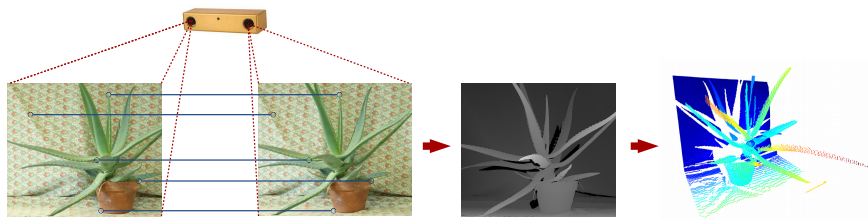

Fig. 17 A Flir Bumblebee2 stereo camera framing a scene, with related *left* and *right* images and some point correspondences (left, images from the Middlebury Stereo Datasets); the depth map estimated with dense stereo matching algorithms (center); a point cloud generated from the depth map (right). The point colors encode here the depth information (red: closest points; blue: furthest points).

Passive Stereo Cameras are devices composed of two (or more) usually identical digital cameras, rigidly mounted on a common chassis and framing the same

scene from different points of view. In most cases the cameras are mounted with a horizontal displacement. The distance between the cameras is called *baseline*: due to this non-zero baseline, a 3D point is projected into the cameras' imaging sensors in different 2D points. Knowing the rigid body transformation that relates the cameras, from the coordinates of such 2D points, it is possible to estimate the depth of the 3D point by using *triangulation* techniques. Exploiting this fact, the depth estimation problem can be implemented as an image-based point correspondence problem: given an image point $p \in \mathbb{R}^2$ in a view (e.g., the left view), it is possible to estimate its depth by finding the point $p' \in \mathbb{R}^2$ in the other view that best matches p : p and p' should in fact represent projections of the same 3D point $P \in \mathbb{R}^3$ (e.g., Fig. 17, left). This problem is called *stereo matching* and, if performed for each image point, *dense stereo matching* (e.g., Fig. 17, center). The correspondence search is often speeded up by rectifying the images, which allows to search for matches along image rows (*scanlines*): in this case, p and p' belong to the same row and differ by a displacement along this row called *disparity*. The accuracy of stereo cameras decreases with the depth to be measured. Moreover, it is very hard to match points belonging to untextured, homogeneous areas: in this case, the depth is usually not estimated.

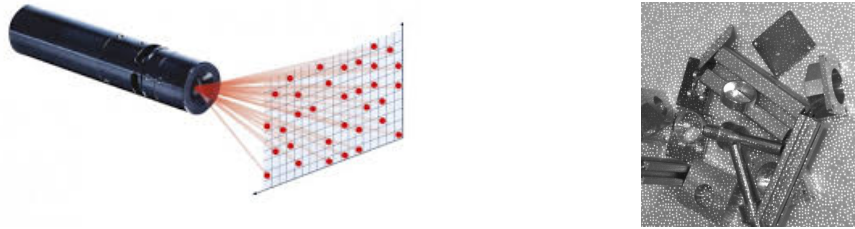

Fig. 18 The Osela Random Pattern Projector with an example of projected divergent dot matrix pattern (left); an example of dot matrix pattern projected onto a scene (right).

Active Stereo Cameras (e.g., Fig. 20, left) solve this problem by coupling to the digital cameras a dense pattern projector (e.g., Fig. 18) that projects into the scene a visible textured pattern, so creating *visual saliency* also in homogeneous surfaces.

10.6 Structured Light Cameras

Structured Light (SL) cameras employ the same operating principle of stereo cameras with a clear difference: one of the two cameras is replaced with a light projector that illuminates the scene with a textured visual pattern. The pattern projector can be seen as a virtual camera that always "sees" the same, fixed image: its projected pattern. The pattern is seen also by the camera but in this case, due to the baseline

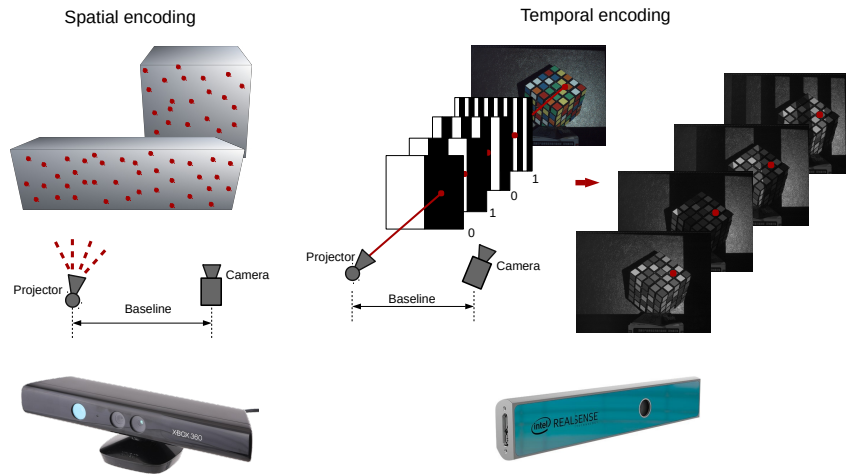

Fig. 19 Operating principles (top row) of two types of SL cameras (bottom row): spatial encoding (red dots represent the projected pattern) used in the first version of the Microsoft Kinect (left column); temporal encoding used in the Intel RealSense SR305 (right column). Both the Kinect and SR305 also include an RGB camera to provide information on the color of the 3D points.

between the projector and the camera, it is projected in different 2D points of the imaging sensor, depending on the 3D structure of the framed scene. The projector can project a single pattern (spatial encoding) or a sequence of patterns (temporal encoding).

Spatial encoding SL cameras typically use visible or near-infrared dense pattern projectors that illuminate the scene with a divergent dense pattern, commonly a $n \times m$ pseudo random dot matrix pattern (e.g., see Fig. 18). The pattern is *known* and each pattern patch (a $p \times p$ submatrix, $p \ll n, m$) represents a unique binary matrix. By detecting the pattern patches from the camera and knowing the baseline between the camera and the pattern projector, it is possible to estimate the depths by means of triangulation (see Fig. 19, left);

Temporal encoding SL cameras (also known as time-multiplexing SL cameras) project a fixed sequence of different patterns, capturing an image for each. It is common to use binary patterns, each containing a sequence of vertical lines of equal width called *fringes*, which either illuminate surface points with white light or not. The lines' width is halved for each consecutive pattern (e.g., see Fig. 19, right). If the system is rectified (see Sec. 10.5) and n binary patterns are projected, for each scanline it is possible to generate 2^n different binary codes. The camera-projector matching is directly recovered for each point from the binary code decoded by the time sequence of image intensities.

Generally, temporal encoding allows to obtain a better depth accuracy, and it is easier to implement. Spatial coding, on the other hand, allows to obtain depth maps with a single image, so it is more suitable for dynamic motions and/or dynamic environments.

10.7 RGB-D Cameras



Fig. 20 Three example of RGB-D cameras: the Intel RealSense D435 (left); the Microsoft Kinect II (center); the Microsoft Azure Kinect (right). Both the Microsoft Kinect II and Azure Kinect use a CW ToF camera as ranging sensor, while the D435 uses active stereo vision.

RGB-D (RGB-Depth) cameras provide both color images and depth estimates. Passive stereo cameras are natively RGB-D sensors, while other RGB-D sensors are ensembles composed of a ToF, a SL, or an active stereo camera rigidly coupled in the same chassis with a color camera (e.g., Fig. 19 and Fig. 20). The transformation that relates the two sensors is known, so it is possible to acquire depth maps that are *registered* with the related RGB images acquired by the color camera. In other words, each pixel of the RGB image is associated with a corresponding pixel in the depth map: both pixels represent projections of the same 3D point into both sensors. From this association is hence possible to generate a "colored" point cloud that encodes both the structure and the visual appearance (i.e., the color) of the framed scene. This multimodal information enables one to tackle in a more effective way complex perception tasks such as recognizing and locating objects, 3D reconstruction of environments, and detection and tracking of people. Recent RGB-D sensors as the Microsoft Azure Kinect (Fig. 20, right) also integrates microphone arrays for speech and sound capture and IMUs for sensor orientation tracking.

11 Example Applications

To perform complex tasks and for safety reasons, mobile robots are often equipped with a multitude of sensors. The choice of sensors depends on both the application, the working environment, and the type of mobile robot.

A common feature of almost all mobile robots is the presence of encoders (Sec. 6) installed on the wheels. Wheel encoders are used to estimate the robot *odometry*, i.e. the position and velocity relative to a starting location. Such estimate is used in localization and SLAM problems as a motion prediction.

As introduced in Sec. 5, contact and proximity sensors can be used in any type of mobile robot as safety sensors to implement emergency stop functions, or as simple reactive navigation sensors in limited indoor environments (e.g., in robot vacuum cleaners). For more advanced safety functions, for redundancy or for low-level obstacle avoidance functions both in indoor and outdoor environments, rotating mirror LiDARs (Sec. 10.2) or ultrasonic sensor arrays (Sec. 10.1) can also be used. The former, for example, can be also certified for safety functions, while the latter can be used as redundant sensors to allow detection of transparent surfaces.

LiDARs providing 2D scans are commonly used for indoor navigation (e.g., for localization and SLAM) often coupled with digital cameras (Sec. 9) for higher-level tasks such as object detection and semantic segmentation of scenes, with ToF cameras (Sec. 10.4) or SL cameras (Sec. 10.6) for 3D mapping and object pose estimation, or with RGB-D cameras (Sec. 10.7) for people detection and tracking and human–robot interaction. In GPS-denied environments such as large indoor industrial plants, AHRS IMUs (Sec. 8.4) can be used to provide a heading reference for navigation purposes, while the environment can be structured with a UWB (Sec. 7.2) network to provide the robot with an absolute position reference.

In outdoor navigation, the use of a GPS (Sec. 7.1) receiver as an absolute position reference is a common practice, while pulse-based spinning 3D LiDARs are often preferred as range sensors, thanks to their wide field of view (typically 360-degree) and extended range (up to 200 meters). In the case of harsh or critical outdoor environments (for example, urban or agricultural environments) the LiDAR is often coupled or replaced by one or more radars, that are more robust against dust, rain or fog and, in case of quick motions, can provide velocity information about other agents. RGB cameras or passive stereo cameras are often used for outdoor 3D mapping, place recognition, and loop closure detection and higher-level tasks such as semantic segmentation, pedestrian detection, etc. RGB cameras, stereo cameras and/or 3D LiDARS are also used, often coupled with IMUs, for robot ego-motion estimation (*visual odometry*), for instance, for redundancy or when the odometry from wheel encoders is missing or unreliable due to slippery ground (e.g., when the robot moves off-road).

12 Future Directions for Research

In outlining the potential future of sensors for mobile robots, we first provide a short summary on comprehensive works on the state of the art. Based on these works and

on our experience in the field, we then provide our view on the near future of these devices. Yet, we believe that doing forecasts in this domain is not an easy task, due to rapid technological development in fields such as semiconductors, material science, electronics, and manufacturing processes on which the construction of sensors relies. A breakthrough in one of these fields might lead to new classes of devices which we are unable to predict at the moment of writing.

A comprehensive and up-to-date review of the physical principles, design, and practical implementations of various transducers and sensors, with insights about the use of sensors in mobile devices, can be found in (Fraden, 2016), while (Everett, 1995) provides in-depth analysis and details about many of the sensors specifically used in mobile robots. A gentle yet exhaustive introduction to sensor's characterization and error modeling, along with a detailed description of a large range of sensors for mobile robots, can be found in the "Perception" chapter of (Siegwart et al., 2011). For most sensors, there are excellent specialized reference books and articles covering the theory of operation and advanced concepts, among others, for GPS/GNSS (Misra and Enge, 2011), MEMS IMUS (Kempe, 2011), digital cameras (Holst and Lomheim, 2011), omnidirectional cameras (Benosman et al., 2011), event cameras (Gallego et al., 2022), LiDARs (Shan and Toth, 2018), radars (Richards et al., 2010), ToF cameras (Horaud et al., 2016), and SL cameras (Zanuttigh et al., 2016).

Very recently, a large number of new sensor technologies have appeared on the market, pushing the limits from a performance point of view and opening the door to new applications, often at affordable costs. These include OPA-based solid-state LiDARS (Li and Ibanez-Guzman, 2020) (see also Sec. 10.2), Multiple-Input, Multiple-Output (MIMO) radars (Sun et al., 2020), affordable event cameras (Gallego et al., 2022), low-cost multi-frequency multi-GNSS receivers (Nguyen et al., 2021), smart AI (Artificial Intelligent) devices embedding microcontrollers able to locally execute deep neural network learning workloads (Ajani et al., 2021), and others. In the next few years, 360-degree solid-state scanning LiDAR (Nishiwaki, 2021) and low-cost megapixel-resolution depth cameras based on piezoelectric effect (Atalar et al., 2022) could likely enter the market, making the spatial perception of mobile robots even more effective.

On the other hand, there is still a lot of room for research in the sensors field, especially in the case of mobile robots, which often include heterogeneous sensor ensembles and require high-level information to autonomously and effectively interact with the environment. For example, sensors' ability to self-calibrate and self-configure regardless of their arrangement in the robot could be a crucial enabling technology. Smart sensors that, thanks to embedded AI models, directly output high-level information (e.g., object classes with poses and dynamics) could speed up the implementation of new, cutting-edge applications.

References

- Ajani TS, Imoize AL, Atayero AA (2021) An overview of machine learning within embedded and mobile devices—optimizations and applications. *Sensors* 21(13), DOI 10.3390/s21134412
- Atalar O, Van Laer R, Safavi-Naeini AH, Arbabian A (2022) Longitudinal piezoelectric resonant photoelastic modulator for efficient intensity modulation at megahertz frequencies. *Nat Commun* 13(1):1526
- Benosman R, Faugeras O, Kang S (2011) *Panoramic Vision: Sensors, Theory, and Applications*. Monographs in Computer Science, Springer New York
- Everett HR (1995) *Sensors for Mobile Robots: Theory and Application*. A. K. Peters, Ltd.
- Fraden J (2016) *Handbook of Modern Sensors: Physics, Designs, and Applications*. Springer
- Gallego G, Delbruck T, Orchard G, Bartolozzi C, Taba B, Censi A, Leutenegger S, Davison AJ, Conrath J, Daniilidis K, Scaramuzza D (2022) Event-based vision: A survey. *IEEE Transactions on Pattern Analysis & Machine Intelligence* 44(01):154–180
- Holst G, Lomheim T (2011) *CMOS/CCD Sensors and Camera Systems*. SPIE Press monograph, JCD Publishing
- Horaud R, Hansard M, Evangelidis G, M  nier C (2016) An overview of depth cameras and range scanners based on time-of-flight technologies. *Machine Vision and Applications* 27(7):1005–1020
- Kempe V (2011) *Inertial MEMS: Principles and Practice*. Cambridge University Press, DOI 10.1017/CBO9780511933899
- Li Y, Ibanez-Guzman J (2020) Lidar for autonomous driving: The principles, challenges, and trends for automotive lidar and perception systems. *IEEE Signal Process Mag* 37(4):50–61
- Misra P, Enge P (2011) *Global Positioning System: Signals, Measurements, and Performance*. Ganga-Jamuna Press
- Nguyen NV, Cho W, Hayashi K (2021) Performance evaluation of a typical low-cost multi-frequency multi-gnss device for positioning and navigation in agriculture – part 1: Static testing. *Smart Agricultural Technology* 1:100004, DOI 10.1016/j.atech.2021.100004
- Nishiwaki S (2021) Biaxial 360-degree scanning LIDAR using a liquid crystal control. *Sci Rep* 11(1):14767
- Richards M, Scheer J, Scheer J, Holm W (2010) *Principles of Modern Radar: Basic Principles, Volume 1. Electromagnetics and Radar*, Institution of Engineering and Technology
- Shan J, Toth C (2018) *Topographic Laser Ranging and Scanning: Principles and Processing*, Second Edition. CRC Press
- Siegwart R, Nourbakhsh IR, Scaramuzza D (2011) *Introduction to Autonomous Mobile Robots*, Second Edition. Intelligent robotics and autonomous agents, MIT Press

- Sun S, Petropulu AP, Poor HV (2020) Mimo radar for advanced driver-assistance systems and autonomous driving: Advantages and challenges. *IEEE Signal Processing Magazine* 37(4):98–117
- Zanuttigh P, Marin G, Mutto CD, Dominio F, Minto L, Cortelazzo GM (2016) *Time-of-Flight and Structured Light Depth Cameras: Technology and Applications*. Springer