

Confidential Machine Learning within Graphcore IPUs

Kapil Vaswani,¹ Stavros Volos,¹ Cédric Fournet,¹ Antonio Nino Diaz,¹ Ken Gordon,¹ Balaji Vembu,⁰ Sam Webster,¹ David Chisnall,¹ Saurabh Kulkarni,² Graham Cunningham,² Richard Osborne,² Dan Wilkinson²
¹Microsoft Research ²Graphcore

ABSTRACT

We present IPU Trusted Extensions (ITX), a set of experimental hardware extensions that enable trusted execution environments in Graphcore’s AI accelerators.

ITX enables the execution of AI workloads with strong confidentiality and integrity guarantees at low performance overheads. ITX isolates workloads from untrusted hosts, and ensures their data and models remain encrypted at all times except within the IPU. ITX includes a hardware root-of-trust that provides attestation capabilities and orchestrates trusted execution, and on-chip programmable cryptographic engines for authenticated encryption of code and data at PCIe bandwidth. We also present software for ITX in the form of compiler and runtime extensions that support multi-party training without requiring a CPU-based TEE.

Experimental support for ITX is included in Graphcore’s GC200 IPU taped out at TSMC’s 7nm technology node. Its evaluation on a development board using standard DNN training workloads suggests that ITX adds less than 5% performance overhead, and delivers up to 17x better performance compared to CPU-based confidential computing systems relying on AMD SEV-SNP.

1 INTRODUCTION

Machine learning (ML) is transforming many tasks such as medical diagnostics, video analytics, and financial forecasting. Their progress is largely driven by the computational capabilities and large memory bandwidth of AI accelerators such as NVIDIA GPUs, Alibaba’s NPU [2], Google’s TPU [19], and Amazon’s Inferentia [3]. Their security and privacy is a serious concern: due to the nature and volume of data required to train sophisticated models, the sharing of accelerators in public clouds to reduce cost, and the increasing frequency and severity of data breaches, there is a realization that machine learning systems needs stronger end-to-end security mechanisms that protect their sensitive models and data.

Confidential computing [1, 4, 10, 32] relies on custom hardware support for trusted execution environments (TEE), also known as enclaves, that can provide such security guarantees. Abstractly, a TEE is capable of hosting code and data while protecting them from privileged attackers. The hardware can also measure this code and data to issue an *attestation report*, which can be verified by any remote party to establish trust in the TEE. In principle, confidential computing enables multiple organizations to collaborate and train models using sensitive data, and to serve these models with assurance that their data and models remain protected. However, existing TEEs such as Intel SGX [24], AMD SEV-SNP [5], and ARM Trustzone [6] are restricted to CPUs and cannot be used for applications that offload computation to accelerators.

Adding native support for confidential computing into AI accelerators can greatly increase their security, but also involves

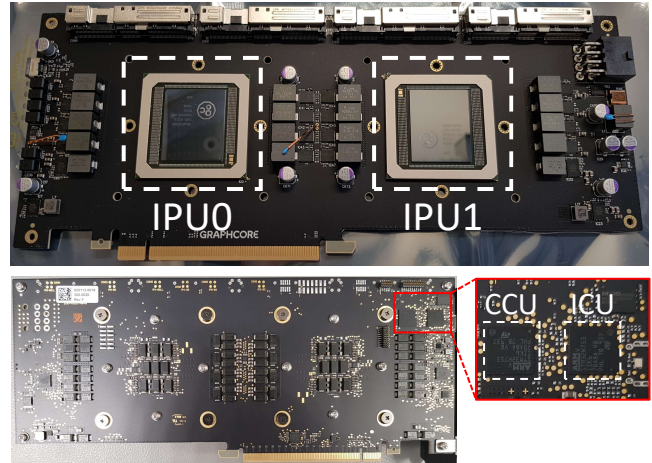

Figure 1: GC200 IPU development board with the ITX extensions for confidential ML showing the two IPUs on the front side connected to the CCU via the ICU (on the back).

many challenges. Security features such as isolation, attestation, and side-channel resilience must be fitted in their highly optimized architecture, with minimal design changes, and without degrading their functionality, performance, or usability. An additional requirement is the flexibility to operate with different hosts, including CPUs with no TEE support, CPUs with process-based TEEs such as Intel SGX, and CPUs with VM-based TEEs such as AMD SEV-SNP. Finally, the manufacturing and assembly process and protocols must be hardened against supply chain attacks.

This paper describes our effort to support TEEs in a state-of-the-art AI accelerator, Graphcore’s Intelligence Processing Unit (IPU). We introduce *IPU Trusted Extensions* (ITX), a set of experimental hardware capabilities in the IPU. We show that, using ITX in conjunction with appropriate compiler and runtime support, we can delegate ML tasks to the IPU with strong confidentiality and integrity guarantees while delivering accelerator-grade performance. In particular, ITX can guarantee isolation of an ML application from an untrusted host: application code and data appears in cleartext only within the IPU, and remains encrypted otherwise, including when transferred over the PCIe link between the host and the IPU. Once an application is deployed within an ITX TEE, the host can no longer tamper with the application state or the IPU configuration. ITX can also issue remotely verifiable attestations, rooted in a Graphcore PKI, enabling a relying party to establish trust in a given ML task before releasing secrets such as data decryption keys.

The main components of ITX are a new execution mode in the IPU for isolating all security sensitive state from the host and securely handling security exceptions, programmable cryptographic engines capable of encrypting and decrypting PCIe traffic between

⁰Work done while Balaji Vembu was affiliated with Microsoft.

the host CPU and the IPU at line rate (32 GB/s bidirectional throughput for supporting PCIe Gen4), and a novel authenticated encryption protocol for ensuring confidentiality and integrity of code and data transfers without requiring trust in the host.

Trust in ITX is rooted in the *Confidential Compute Unit (CCU)*, a new hardware Root-of-Trust on the Graphcore board. The CCU provides each device with a unique identity based on a hardware secret sampled within the CCU at the end of manufacturing. The CCU firmware is responsible for managing the entire lifecycle of TEEs on the IPU, including creation, issuing attestation reports that capture IPU and task specific attributes, key exchange, launch, and termination of TEEs. Our design also features protocols for securely provisioning firmware to the IPU in a potentially hostile manufacturing environment, for issuing certificates that capture the identity of all updatable firmware, and for supporting firmware updates without requiring device re-certification.

Several distinguishing aspects of ITX and the IPU programming model result in stronger security than one may expect from CPU-based TEEs, notably as regards side channels:

- An ITX TEE spans the entire IPU, and has exclusive access to all IPU resources until it terminates. Therefore, it is not possible for an adversary to run concurrently on the same resources and exploit the resulting side channels. This execution model is feasible since most AI workloads require at least one accelerator, with larger workloads requiring thousands of accelerators for many hours.
- The IPU’s memory system consists of large amounts of on-chip SRAM attached to its cores, which is loaded with data from untrusted external memory during explicit synchronization phases. Thus, during computational phases, code and data accesses to IPU memory have a fixed latency. This has two security implications: (1) traffic between the IPU cores and memory need not be encrypted, since it stays within the chip; (2) this avoids the need for optimizations such as caching or speculation to hide memory access latency, and the resulting side channels.
- The IPU supports a programming model where allocation and scheduling of all resources on the IPU (cores, memory, and communication channels) are statically managed by the compiler. Hence, the IPU application binary defines its entire data and control flow, including data transfers within the IPU, and between IPU and host memory. This is unlike GPUs where the host software stack (runtime and driver) remain in full control of the execution, and therefore must be trusted to some extent to guarantee integrity.

There are many ways for software to utilize ITX to provide end-to-end guarantees for ML workloads, depending on the threat model and capabilities of the host. This paper focuses on configurations where a multi-party ML training workload is deployed to the IPU *without trusting the host CPU*. This mode has the strongest security properties and can be used with any CPU. We describe a prototype software stack and protocols for it, and present its end-to-end evaluation using standard DNN training workloads. Software to support other configurations, e.g., where the IPU is coupled with a hardware-protected CPU TEE, are left for future work.

We have fully implemented ITX in the GC200 IPU, manufactured in TSMC’s 7nm technology. Our extensions use less than 1% of this large ASIC, and do not require any change to its compute core or memory subsystem. Its evaluation on a development board using confidential ML training workloads suggests a performance overhead of less than 5% compared to non-confidential IPU workloads. While our prototype demonstrates promising results, significant work remains to turn our work into production.

Due to implementation constraints, our prototype uses a discrete hardware root-of-trust (instead of an on-die core) and it does not encrypt traffic over IPU-IPU links. It is therefore vulnerable to physical attacks, e.g., on the link between the CCU and IPU, or between multiple IPUs. These vulnerabilities are not limitations of our design and can be addressed in future IPU generations by integrating the root-of-trust on the IPU chip, and introducing additional encryption engines on IPU-IPU links.

In summary, this paper makes the following contributions:

- (1) A set of experimental hardware extensions to the IPU, Graphcore’s AI accelerator, that enable high-performance confidential multi-party machine learning.
- (2) Support for remote attestation and secure key exchange based on a discrete hardware root-of-trust.
- (3) A pipelined application-level protocol for authenticated encryption & decryption of code and data over PCIe.
- (4) Protocols for securely provisioning secrets, firmware and certificates to a device during manufacturing.
- (5) Prototype software support for enabling confidential multi-party training of ML models expressed in TensorFlow on the IPUs without requiring trust in the CPU.
- (6) Implementation of ITX in the IPU ASIC manufactured by TSMC in 7nm technology, and its initial evaluation on a development board, which suggests low overheads and orders of magnitude improvements over CPU TEEs. This makes our prototype the first AI accelerator to support confidential computing.

While some aspects of our design are specific to Graphcore IPUs, we hope it can serve as a blueprint for adding TEE support in other specialized devices and accelerators.

2 BACKGROUND

This section outlines the Graphcore IPU architecture and its programming model, with an emphasis on aspects relevant to security. A more detailed description of IPUs and a comparison with GPUs are out of scope—see, e.g., [11, 12]. The section also reviews hardware-based confidential computing.

2.1 IPU Hardware Architecture

Tiles. Each IPU consists of a set of *tiles*, each with a multi-threaded core and a small amount of private on-chip SRAM. The GC200 IPU features 1472 tiles, totalling roughly 900 MB of on-chip SRAM. The cores support an instruction set tuned for AI, including specialized vector instructions and low-precision arithmetic. Each core can execute up to six statically scheduled threads. Since on-chip memory can be accessed at fixed latency, most instructions can be exactly scheduled by the compiler. (Other IPU configurations may provide connectivity between tiles and additional on-board DRAM,

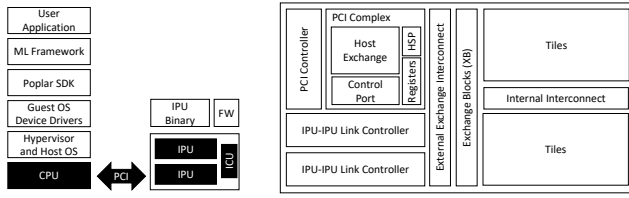

Figure 2: System stack (left) and IPU floorplan (right).

which would be accessed in a similar way as host DRAM; these configurations are out of scope in this paper.)

Interconnects. The tiles are connected over a high-bandwidth *internal exchange*, an all-to-all, stateless, synchronous and non-blocking interconnect whose operation is similarly orchestrated by software. The internal exchange is connected to an *external exchange* interconnect via a set of *exchange blocks*. Each exchange block manages a subset of the tiles and mediates traffic between the two interconnects. Each IPU has a pair of PCIe links that connect to a host server, and additional IPU-Links that connect to other IPUs.

The external interconnect is a packet-switched Network-on-Chip. Tiles use the external interconnect to dispatch packets to the host via PCIe links and unicast/multi-cast packets to tiles on other IPUs via IPU-links. Tiles read data from the host by issuing a *read request* packet and waiting for all associated *read completion* packets. Tiles write data to the host by issuing one or more *write request* packets. Packets are routed based on tile identifiers. For requests, packets from exchange blocks are placed onto lanes based on the source tile identifier of the exchange packet. For read completions, the exchange lane is chosen based on the destination tile identifier, which is recorded in a lookup table in the PCI complex for each outstanding read request.

IPU Address Spaces. The IPU exposes three address spaces, collectively known as the *IPU exchange address space*, to facilitate communication between the host and the IPU and between IPUs. The *Tile address space* is used by tiles to address one another. The *Host PCI space* is used by the host to address tile memory and on-chip page tables in the Host Exchange block. The *Tile PCI space* is used by tiles to address read requests to host memory over PCI. The IPU can be configured to re-map read requests from tiles to the PCI domain using on-chip page tables.

Host-IPU Interface. The IPU exposes a set of configuration registers to the host via a PCI BAR space. These registers are hosted in a component known as the *PCI Complex*. The PCI complex consists of a *Host Sync Proxy (HSP)* that is responsible for external synchronization between the host and the IPU, a *host exchange* that translates packets between PCI format and a proprietary external-exchange packet format, on-chip page tables for address translation of read/write requests from tiles to the PCI domain, on-chip lookup tables for keeping metadata for outstanding PCI read requests, and a *control port* that provides access to configuration registers of all other internal components.

The host exchange subsystem also includes a component known as the *autoloader*, which enables efficient scrubbing and initialization of tile memory. To initialize a binary in tile memory, the host can load small programs (e.g., a bootloader) into the autoloader, which can then broadcast it to all tiles.

Host-IPU Synchronization. The IPU execution model is based on the Bulk Synchronous Parallel (BSP) paradigm, with barriers and supersteps. A superstep involves a global synchronization barrier between all tiles on one or more IPUs, followed by an exchange phase that transfers data between tiles, followed by a compute phase which ends at another barrier. This process repeats until some application specific criteria is met—e.g., loss is under a threshold.

Using the Host Sync Proxy registers, the host can configure the frequency of synchronization barriers and indicate barriers at which it expects to be notified—e.g., when one or more batch of data has been processed, at epoch boundaries. Once configured, the IPUs can execute multiple supersteps independently without requiring involvement from the host.

IPU Control Unit (ICU). The ICU is a microcontroller integrated on the board and connected with the IPUs via JTAG, and with PCB peripherals for power supply and environmental monitoring. It is responsible for initialization and power management of the IPUs.

Resets. The main means of resetting the IPU from the host is a *secondary bus reset (SBR)* that resets the entire device including the IPUs, the ICU, and the host link; the ICU must re-enable the host link once it comes out of reset. Alternatively, a *Newmanry Reset* can be triggered by writing the IPU control register; it resets the device logic including the host and IPU links, but does not reset the physical links. In both of these resets, tile memory is not scrubbed.

2.2 IPU Software Stack

Graphcore provides a software stack, known as Poplar, for compiling and executing applications written in ML frameworks such as TensorFlow and PyTorch. Poplar consists of a compiler, a host runtime, and a set of libraries supported by the IPU device driver.

Compilation. The Poplar compiler is responsible for compiling a computation graph representing a task (e.g., a TensorFlow XLA graph) into IPU binaries. Compilation involves statically partitioning each layer in the computation graph between tiles, with each tile holding a part of the model state (weights and activations for some layers) and a part of the input data. The compiler assigns resources (threads, memory) to each node of the graph, schedules its computation, and emits specialized code for each tile.

The resulting IPU binary captures the different phases of execution, including I/O for reading batches of data, code for running the training loop, and I/O for writing the weights of the trained model. I/O phases also include synchronization and internal exchange code for exchanging data among tiles.

The Poplar compiler maps all data transfers between the host and IPUs to an abstraction called *streams* supported by the runtime. Data transfers from the host to an IPU (and IPU to the host) are mapped to input (output) streams and compiled to sequences of read (write) instructions to the Tile PCI address space. The compiler also uses streams to implement checkpoints; checkpoint creation maps all model weights to a single output stream, and checkpoint restoration reads them back from a single input stream.

The compiler supports an offline mode, which decouples compilation from execution. In this mode, the compiler generates self-contained IPU binaries, which can be persisted and loaded into one or more IPUs at a later point in time.

Host Runtime. The runtime provides abstractions for loading IPU binaries, and for streaming data in and out of the IPU.

For loading IPU binaries, the runtime deploys a small bootloader into a reserved section of each tile memory. The bootloader in turn reads tile-specific application binary from the host into tile memory.

The runtime implements input streams by repeatedly copying data into a ring buffer in host memory and mapping the pages of the ring buffer into Tile PCI space in the on-chip page table. Once the ring buffer is ready and the mapping is defined, code on tiles can issue read requests. Similarly, output streams are implemented by copying data from the ring buffer to application memory.

2.3 Confidential Computing

Confidential computing is a paradigm where code and data remains protected from privileged attackers throughout their lifecycle, including when it is at rest, in transit and *during use*. Central to confidential computing is the notion of a *trusted execution environment* (TEE). TEEs offer two key capabilities: the capability to host an application in a hardware-isolated secure environment, which protects the application from all external access including access from privileged attackers; and the capability to issue remotely verifiable attestations, which capture various security claims about the application hosted in the TEE and the platform supporting the TEE. These attestations can be used by any relying party to establish trust in an application and opening secure channels for communication.

TEEs are supported by recent processors from Intel and AMD. ARM has recently defined a specification for supporting TEEs. There are broadly two classes of CPU TEEs: process-based and VM-based. Process-based TEEs (e.g., Intel SGX) are designed to isolate a user-space application from an untrusted operating system (both guest and host) and the hypervisor. VM-based TEEs (e.g., AMD SEV-SNP, Intel TDX) are designed to protect an entire guest VM from the host operating system and the hypervisor. TEEs offer varying degrees of protection from attackers with physical access to the CPU. Most TEE implementations assume that attackers can snoop on interconnects between the CPU package and external components (e.g., off-chip DRAM) and protect data by encrypting and integrity-protecting memory traffic. Information leakage through side-channels is still often considered out of scope, although CPU vendors are offering defense-in-depth protection against specific side-channels, such as those based on speculation.

Support for remote attestation is typically rooted in an on-die hardware root of trust (HRoT), which has exclusive access to a unique device secret provisioned into one-time programmable fuses during manufacturing. During boot, the HRoT uses the secret to derive a device-specific identity key. The corresponding public key is endorsed by the hardware manufacturer. This key typically endorses keys used for signing attestation reports for a TEE.

3 THREAT MODEL

TEE hardware is subject to a variety of attacks throughout its lifecycle, from chip design and manufacturing up until the hardware is decommissioned.

Trust in TEEs is rooted in hardware, and consequently in the chip designers and their OEMs involved in designing and manufacturing the chips. Additional trust is also required in the infrastructure

for issuing certificates to each chip, and for publishing the last known good version of firmware TCB. While this is also the case with the IPU, we wish to minimize trust in the rest of the supply chain. Hence, we conservatively assume that attackers control the manufacturing and assembly process after tapeout, including the process of provisioning firmware and/or secrets to each device and harvesting their Certificate Signing Requests (CSR).

After deployment, we assume a strong adversary that controls the entire system software stack, including the hypervisor and the host operating system, and also has physical access to the host. The adversary can access or tamper with any code and data transferred between the host CPU and the IPU, either in operating system buffers or over PCIe. The adversary can also tamper with device memory directly via the PCI BAR, or map the victim application’s tile PCI address space to host-side memory controlled by the attacker. Information leakage through side channels such as traffic analysis, power consumption, timing, and physical probes on the IPU are generally out of scope. However, we do wish to offer protection from side channels based on memory access patterns, and from low level integrity attacks such as glitching.

We trust the IPU and the HRoT packages, and we assume that the adversary cannot extract secrets or corrupt state within the packages. In particular, the IPU package includes trusted SRAM within the IPU tiles accessed only via on-chip private channels.

The ML source script and high-level configuration are trusted. The ML framework and the Poplar compiler are trusted for integrity of the computation—i.e., to compile the model defined in the ML script correctly into a manifest and binaries that run on the IPU.

In multi-party configurations (involving parties that do not trust one another), these assumptions can be addressed by having all parties review the script and configuration for the workload, then confirm that they all locally compile to the same manifest and binaries. Each party is trusted with the integrity and confidentiality of the data streams they provide for the computation; in particular, honest parties are trusted to correctly encrypt their data streams with a fresh data encryption key, and to release this key to IPU only after verifying their attestation report.

In configurations that couple the IPU with a host CPU TEE (e.g., Intel SGX and TDX, AMD SEV-SNP), the CPU package is also trusted, along with any software hosted in the TEE; we omit the details of their platform-specific threat models. With process-based TEEs, such as Intel SGX, the CPU-based software TCB may include the ML training or inferencing script, ML framework (e.g., TensorFlow, PyTorch), the Poplar compiler and runtime. With VM-based TEEs, such as AMD SEV-SNP, the TCB may additionally include the Poplar kernel-mode driver and a guest operating system. The Poplar runtime is then trusted for confidentiality—i.e., to setup a secure, attested channel between the CPU TEE and IPU, and to transfer code/data over this secure channel.

With the current generation of IPU, we make additional trust assumptions in the ICU, which provides connectivity between the hardware RoT and the IPU, and in links between IPU. We trust the ICU firmware and the physical links that connect the HRoT, the ICU and the IPU. These trust assumptions can be removed in subsequent generations of the IPU by placing the HRoT on the IPU die, and encrypting communication over IPU-IPU links.

Under this threat model, we wish to provide confidentiality and integrity guarantees for model code and data, including initial weights, input data, checkpoints and outputs. For training, integrity implies that the final outcome (i.e., the trained model) is bitwise equivalent to the model obtained in the absence of the attacker. For inferencing, integrity implies that requests yield the same results as those obtained in the absence of the attacker. Conversely, liveness properties (e.g., progress or availability) are out of scope.

We wish to also provide remote attestation, which refers to the ability of the platform to make remotely verifiable claims that a relying party can use to reason about the TEE’s security properties and thereby establish trust in the application hosted within the TEE even in the presence of an attacker. Specifically, we wish to ensure that the attestation can deliver temporally fresh evidence that contains all security-sensitive parts of the platform and application state, and that the underlying attestation mechanism is trustworthy and robust to advanced attacks such as chosen-firmware attacks.

4 OVERVIEW

Trusted execution in IPU enables model developers to securely offload an ML job (training or inferencing) while protecting both model and data from the hosting platform. In turn, model developers can prove to data providers that their data remains protected from both the hosting platform and the model developers themselves.

The workflow for securely offloading an ML job involves multiple steps, starting with the creation of a TEE, generation of an attestation report, its verification by remote parties (e.g., the model developer or data providers), encryption of code and data, secure exchange of encryption keys with the IPU, job execution, and decryption of the outcome: a trained model or inference results.

4.1 Hardware extensions (ITX)

The IPU hardware contains several components (shown in Figure 4) to support this workflow.

First, a new hardware root-of-trust integrated on the IPU board, called the *Confidential Computing Unit (CCU)*. The CCU gives each board a unique identity based on a hardware secret generated by the CCU during manufacturing. The CCU firmware supports an API which an untrusted host can use to manage the entire TEE lifecycle on the IPU, including creation, attestation, key exchange, application launching, and termination. Section 5.1 describes the architecture of the HRoT and its role in trusted execution.

Second, a new mode, called the *trusted mode*, in which all security sensitive state is isolated from a potentially malicious host. This mode is entered by writing to a configuration register. (For remote verifiability, this register is measured by the CCU and included in the attestation report.) Once the IPU enters this mode, its configuration registers and tile memory can be accessed only by the CCU and ICU. The only way to exit this mode is via a chip reset, which is extended to scrub all key registers and tile memory.

Third, programmable AES-GCM engines for authenticated encryption and decryption of code and data transferred between the host and the IPU at PCIe line rate. These engines are hosted in new components, called *Secure Exchange Pipes (SXP)*, located on the interconnect between the PCIe block and the exchange blocks. The SXP and its use are described in Section 6.1.

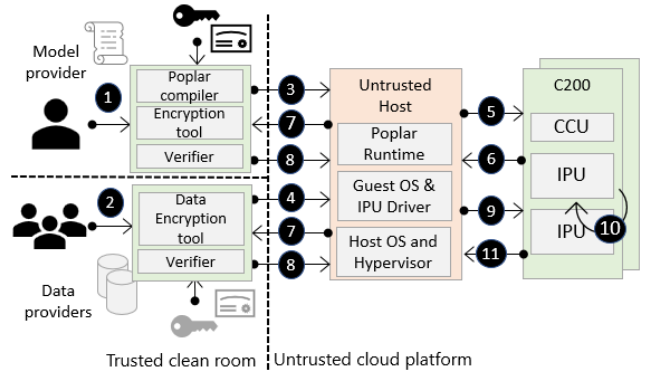

Figure 3: Multi-party training in trusted offline mode. Before training, the remote parties upload their encrypted code, data and certificates (1–4) Once training starts (5–6), they verify the attestation report (7) then release their encryption keys to the CCU (8–9); they can be offline for the rest of the computation. The IPU’s train the model in a TEE (10) and releases an encrypted trained model (11), whose key can be shared with model receiver(s).

4.2 Software Support

There are many ways for software to utilize ITX. For this paper, we illustrate a particular mode, which we refer to as the *offline mode* (Figure 3). In this mode, a multiparty ML training workload can be deployed in an IPU-based TEE *without requiring a CPU-based TEE*. This mode has strong security properties (e.g., small TCB) and minimal dependencies on the host server hardware. We discuss limitations of this mode, and extensions for scenarios such as aggregation and pre-processing, and inferencing in Section 7.4.

Job Preparation. In offline mode, a model developer uses an extended Poplar compiler to statically compile a model training job expressed in an ML framework such as TensorFlow or PyTorch to standalone IPU binaries in a trusted, offline *clean room environment* (1). In addition to the binary, the compiler generates a *job manifest*, which contains auxiliary information required at runtime to execute the job. Next, the model developer encrypts binaries and parameters such as initial weights and learning rate using encryption keys that remain in the clean room environment. The model developer also generates a fresh public key share for key exchange, and a signature over the key share using their certificate. These artifacts, along with the model developer’s certificate are packaged together to create an *application package*. Separately, data providers pre-process and encrypt their input data and labels in their own clean room environments, and create *data packages* which include their key shares and certificates (2). The resulting packages are uploaded to a server with IPU’s attached (3, 4).

Job Initialization. Any entity (including the model developer) can initiate execution of the training job using the Poplar runtime, which we extend to load encrypted code and data into the IPU’s. For confidential computing jobs, the Poplar runtime provides user-mode APIs for operations such as creating TEEs (5) for a job, requesting for attestation reports and additional collateral such as device-specific certificates (6), and relaying key-exchange messages from relying parties to the CCU (8). This runtime is not trusted.

Remote Attestation. In trusted mode, the CCU can issue remotely verifiable attestations, which are relayed to relying parties (7) as proof of TEE configuration for their workload. The attestation is a certificate chain from the Graphcore root CA to an end-certificate signed by the CCU with custom extensions that embed initialization attributes (e.g., measurement of all security-sensitive IPU registers) and job-specific attributes, such as the measurement of the job manifest, and the hash digest of other runtime attributes, including certificate fingerprints of all parties and the CCU’s fresh public keyshare. The model developer and data providers verify this report, the model, and identities of other participants. If they decide to make their data available for this job, they derive shared encryption keys using the CCU’s public key share and securely exchange their secrets with the CCU (see Appendix A.6).

Job Execution. After the model developer and data providers have relayed their keys to the CCU, the CCU deploys the keys into the SXP and starts the job (9) by installing a bootloader into the IPU tiles using the autoloader. The bootloader is designed to fetch the application binary from host memory to each tile in 1KB blocks. In trusted mode, the blocks are decrypted and integrity checked by the SXP before being written to tile memory (see Section 7.3). Once the application binary has been transferred, the Poplar runtime initiates execution of the job. During execution, tiles generate read requests for data, also in blocks of 1KB. In trusted mode, the blocks are fetched from host memory over PCIe, and decrypted and integrity checked by the SXP before being written to tile memory. Similarly, all write requests (e.g., checkpoints and trained model) are encrypted and extended with authentication tags before being written to host memory. The encryption/decryption protocol is mostly transparent to the compiler, which can compile *any training algorithm* into binary relying on the data being in tile memory in cleartext and utilizing all compute resources available on the IPU. Finally, the IPU encrypts the trained model with a key made available only to the model receivers listed, such as one or more of the parties involved, or another CPU/IPU TEE, e.g., for inference.

5 TRUSTED EXECUTION ON IPUS

5.1 Confidential Compute Unit (CCU)

The CCU is responsible for associating each Graphcore device with a unique cryptographic identity and managing trusted execution in its IPUs. The CCU is a discrete chip based on STMicro’s STM32H753 microcontroller [26]. This chip was selected as the root of trust based on several security features required to implement measured boot and offer protection from a variety of attacks throughout the IPU lifecycle, such as the abilities to provision a custom bootloader during manufacturing in a region of one-time programmable flash memory, and to switch the microcontroller into a mode that prevents external access via interfaces such as JTAG.

As shown in Figure 4, the CCU is connected to the IPU via the ICU. A dedicated pin receives all exceptions generated by the IPU in trusted mode, giving the CCU firmware full control over exception handling. The CCU reset pin is coupled in hardware with the ICU reset pin and IPU reset, so they cannot be independently reset.

Firmware Architecture and Attestation. The CCU implements a measured boot protocol based on the Device Identity Composition Engine (DICE) architecture [14, 36]. The protocol is designed to

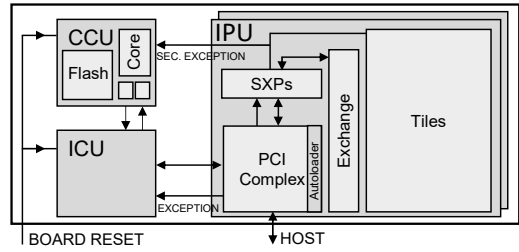

Figure 4: IPU hardware extensions to support trusted execution.

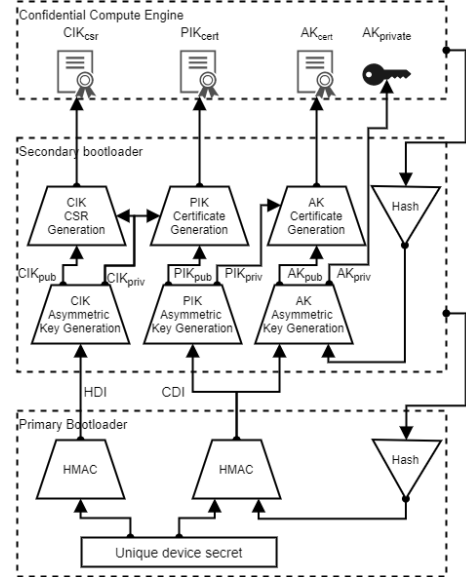

Figure 5: CCU firmware architecture and key hierarchy

ensure that each device is assigned a unique identity while minimizing exposure of hardware secrets. The protocol also ensures that, except for the stable device identity, all derived secrets and keys automatically change when firmware (and its measurement) changes, which ensures that low level firmware attacks such as boot-kits do not compromise secrets used with other firmware.

The CCU firmware (Figure 5) consists of three layers: an immutable primary bootloader provisioned in one-time programmable flash memory at manufacturing; a mutable secondary bootloader responsible for device identity and attestation certificates; and a confidential compute engine (CCE) that manages the TEE lifecycle.

During manufacturing, the CCU would be provisioned with the primary bootloader firmware. When the device is brought out of reset for the first time, this primary bootloader receives control from ROM firmware, samples a *unique device secret* (UDS) using a hardware-based TRNG, stores it in a region of flash memory, that is permanently and permanently blocks access from any other firmware layers. The UDS is the root of the IPU’s key hierarchy, and this protocol ensures that it is never exposed outside the CCU, not even to the manufacturer.

On every subsequent boot, the CCU follows a variant of the DICE measured boot protocol [13][37]: the primary bootloader receives control out of reset, loads and authenticates the secondary bootloader from flash using Graphcore firmware signing key deployed

within the primary bootloader. Next, it derives two intermediate secrets: a *Hardware Device Identifier* (HDI) from UDS, and a *Composite Device Identifier* (CDI) from UDS and the measurement of the secondary bootloader. The HDI is unique to each card, whereas the CDI is unique to each card and secondary bootloader. It then scrubs any copies of UDS from memory, and transfers control to the secondary bootloader, handing over both HDI and CDI.

The secondary bootloader further derives two public-private key pairs: a *Card Identity Key* (CIK) from HDI, and a *Platform Identity Key* (PIK) from CDI. The CIK gives each card a stable identity whereas the PIK is unique to each card and secondary bootloader. The bootloader also generates a self-signed CSR for the CIK, a PIK CSR, and a PIK certificate signed by CIK. The PIK CSR and certificate contain a custom extension that records measurements of the secondary bootloader and the ICU firmware along with additional device-specific information. The CSRs would be securely harvested during manufacturing and processed by a Graphcore CA, which would issue CIK and PIK certificates.

The secondary bootloader derives another key pair: the *Attestation Key* (AK) from CDI and the CEE measurement. Hence, AK is unique to each device, secondary bootloader and CCE. The bootloader issues an AK certificate signed by PIK; this certificate logs the CCE measurement in a custom extension. Finally, the bootloader scrubs all secrets and transfers control to CCE, handing over AK.

The CCE uses AK to sign attestation reports that contains IPU-specific information and job-specific information (Section 5.2). A relying party can validate attestation reports using the AK certificate issued by the device, and CIK and PIK certificates that would be issued by Graphcore. Graphcore would also issue certificates containing the measurements of the latest known good CCU firmware and IPU configuration, which a relying party can use to verify contents of the PIK and AK certificates.

Firmware Update. As intended with DICE, a secondary bootloader update invalidates PIK certificates issued by the manufacturer and, as UDS is provisioned within each device, it is not possible for Graphcore to independently derive and certify the updated PIK. Instead, we rely on CIK, acting as a local CA, to sign the updated PIK certificate. Additionally, Graphcore would issue TCB update certificates containing measurements of old and new versions of firmware. A relying party can validate attestation reports using PIK certificates obtained from the device, the original PIK and CIK certificates, and TCB update certificates (see Appendix A.3.)

Note that the protocol above is still susceptible to advanced chosen-firmware attacks: a malicious secondary bootloader could impersonate another version of the firmware by using CIK to endorse a PIK certificate for the corresponding firmware measurement. Firmware authorization provides a strong defense against such attacks—the malicious firmware would need to be correctly signed by Graphcore to run as secondary bootloader. We can harden the protocol further by moving CIK and PIK generation into the primary bootloader, at the cost of increased complexity in one-time programmable firmware. Appendix A.4 discusses this variant.

5.2 TEE Management

The CCU exposes an API for creating and managing TEEs on the IPU, outlined below.

TEE Initialization. The first step in securely offloading a job to an IPU is to create a fresh TEE for this job. TEE initialization requires a job manifest, public key shares, signatures over the key shares and certificates for each relying party and a checkpoint counter indicating whether job is starting or resuming from a checkpoint. During TEE initialization, the CCU first *quiesces* the IPU, ensuring that there are no in-flight read and write requests between the host and IPU. It then switches the IPU into trusted mode, scrubs all tile memory using the autoloader, and measures the state of the configuration registers. It then checks the signatures over the key shares using the certificates, and generates its own fresh EC share, which is used to establish a ECDH shared secret between each relying party and the CCU (device).

The CCU generates an attestation report signed by the attestation key containing various IPU-specific attributes, such as configuration register measurements, and job-specific attributes, such as the job manifest, certificate fingerprints for all parties, and the epoch counter and checkpoint identifier (see Appendix A.6 for the details.)

Each relying party (model or data provider) can review the attestation report, along with the supporting certificate chains, to validate the device and the initial state of the CCU and IPU, then it can compute the ECDH shared secret to wrap a key package that contains the party’s encryption keys for data it contributes to the job and nonces (see Table 3 and Secure Key Exchange in Appendix A.6 for the details.)

TEE Launch. After gathering wrapped encryption keys from all relying parties, the host launches the execution of a job, which proceeds in several steps.

First, the CCU computes the ECDH shared secret for each party and uses them to unwrap the key package(s) received from each party. It then combines the nonces to derive a checkpoint key and a final-model encryption key for this run of the job (and, if resuming from another run, the checkpoint key from that previous run to restore its state). This key derivation ensures both that the checkpoint key for this run is fresh (as long as one relying party’s nonce is fresh) and that the checkpoint key of a prior run can be recomputed once all relying parties agree to resume from a checkpoint. Table 3 and Appendix A.6 provide details about the key derivations.

Next, the CCU deploys a pre-defined bootloader on the IPU tiles using the autoloader, and it deploys a first set of encryption keys to the SXP (including the code encryption key) as specified in the job manifest. It then activates the bootloader (whose measurement is included in the attestation report) on every tile, which issues requests to read their encrypted application binary from host memory. Responses to these read requests are authenticated and decrypted by the SXPs before being copied into private tile memory.

Finally, The CCU deploys the next set of encryption keys (including data keys, and possibly the checkpoint key for resumption), as specified in the job manifest, and trigger the main execution loop on the IPU tiles. The CCU may be similarly involved at some synchronization points later in the job, to deploy different sets of encryption keys.

TEE Termination. At any point after initialization of a TEE, the host runtime can also request that the TEE be terminated. The CCU may also trigger TEE termination in the event of a security exception raised from the IPU e.g., failure to authenticate a response

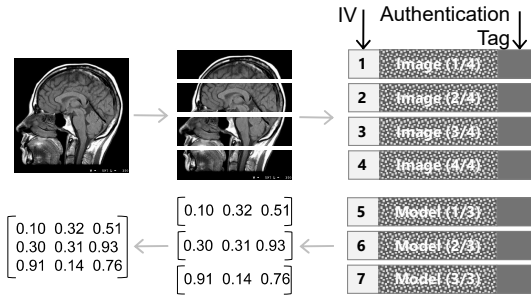

Figure 6: Authenticated encryption with explicit IVs. Data is statically partitioned into frames with unique IVs. Hardware decryption ensures their integrity based on their authentication tag; the receiver must verify that received IVs match the expected IVs before accepting the decrypted payloads.

of a read request. During TEE termination, the CCU quiesces the IPU and scrubs tile memory using the autoloader and disables all keys in the SXP. Finally, the CCU issues a *Newmanry* reset, which switches the IPU back into normal mode.

A TEE may be abnormally terminated due to a hard reset of the device. In such a scenario, the IPU reverts to normal mode and all CCU state is cleared. When the IPU comes out of reset, prior to re-enabling the host links, the ICU is programmed to scrub tile memory to ensure that any secrets left over from a previous execution are erased before the host re-gains access to the device.

6 ENCRYPTED DIRECT MEMORY ACCESS

Next, we describe the ITX protocol for encrypted code and data transfers to and from IPU tiles. The protocol is designed to ensure confidentiality and integrity even in the presence of privileged attackers that control the host software stack and can observe/tamper with PCIe traffic. The protocol is application-level as opposed to transport-level (discussed in Section 9). While it is transparent to ML frameworks, it relies on application software (e.g., the Poplar compiler) to assign IVs for authenticated encryption and for programming the tiles to securely load code, initial weights, training data, and save/reload checkpoints and results. The protocol is supported in IPU hardware by fully pipelined AES256-GCM engines for authenticated encryption at PCIe line rate. This design choice results in simpler hardware (at the cost of some software complexity), allows the IPU to be coupled with untrusted CPUs or CPUs with varying TEE support, and retains the compiler’s ability to maximize PCIe utilization by parallelizing data transfers across multiple tiles.

6.1 Data Format

In the encryption protocol (illustrated in Figure 6), application software partitions each code and data stream into equally-sized encrypted *frames*. Each frame consists of a 128-bit IV, followed by a series of cipher blocks that carry the encrypted contents of the frame, and by a 128-bit authentication tag. Application software is free to use different frame sizes for different streams, as long as the total frame size (including IV and authentication tag) is a multiple of 128 bytes with a maximum of the 1kB, which is the largest supported PCIe read. Application software can use different keys to encrypt different streams. This is critical for multi-party

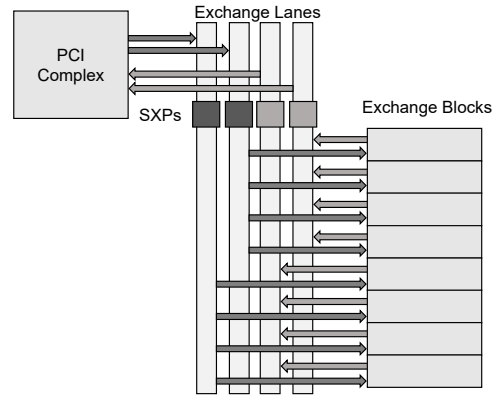

Figure 7: IPU External Exchange Interconnect, with an SXP on each exchange lane. Traffic is forwarded from and to exchange blocks to exchange lanes based on the exchange block identifier.

scenarios where streams are provided and accessed by different parties. Crucially, application software must ensure that IVs are never reused across frames encrypted with the same key (which would be catastrophic with AES-GCM). In our implementation, this invariant is ensured by the compiler, which constructs the IV by combining stream-specific identifiers and frame indexes, and the fact that in Poplar, both code and data streams are write-once abstractions. Together, this guarantees that unless the associated key has been compromised, authenticated decryption with the correct IV yields the correct payload.

6.2 Hardware Support

Multiple components in the IPU support ITX encryption. The IPU includes blocks, called *Secure Exchange Pipes*, extensions to packet formats for carrying encryption-related information, and extensions to exchange blocks and the PCIe complex for supporting the task of mapping frames to keys.

Secure Exchange Pipe (SXP). The SXP is a programmable hardware block that supports AES256-GCM authenticated encryption and decryption of frames. Each SXP achieves 16 GBps unidirectional throughput with negligible impact on latency. As shown in Figure 7, there are four SXPs placed on the exchange interconnect (two per direction) to support encryption/decryption at PCIe Gen4 line rate (32GBps bidirectional). In trusted mode, each SXP is configured to intercept read/write requests from four exchange blocks.

AES-GCM Engine. The SXP’s core is a fully pipelined AES-GCM engine that supports 16 *physical key contexts* to enable concurrent requests. Each context can be programmed by loading a 256-bit key into control registers exposed to the CCU via an internal control bus. While frames may be interleaved, for functional correctness we require that *each context processes a single frame at a time*. This invariant is enforced by the compiler, as detailed in Section 7.1.

The core implements the standardized AES256-GCM algorithm with two restrictions: the additional authenticated data is always empty; and the plaintext is block-aligned and not empty. For convenience, we also treat the IV as a full 16-byte block, including the 32 bits of internal block counter. For each context, the SXP stores an AES key, the Galois-hash authentication key (AK) computed by encrypting 0^{128} when loading the AES key, the encryption of the

initial IV (EK), the current IV including the block counter, and a partial Galois hash (H). In each cycle, the core performs one of the following operations on its context:

- The context is idle (i.e., no frame is being encrypted or decrypted) and the core receives the IV for the frame. It combines IV with the initial block counter (0), encrypts it and stores the result in EK; outputs IV; increments IV; and marks the context as active.
- The context is active and the core receives a block of data. It encrypts IV and XORs it with the data; accumulates this cipherblock into the partial hash H using AK; outputs the cipherblock; and increments IV.
- The context is active and the core receives a MAC. It computes the authentication tag for the frame using AK, EK, IV, and H; compares it with the received MAC (if performing a decryption); outputs the authentication tag; and marks the context as idle.

The core detects context switches by comparing key context identifiers between consecutive cycles (as discussed below), so that it can fetch the next context before the next operation.

Frame encryption/decryption. The SXP receives three types of external exchange packets: read requests (egress), read completions requiring decryption (ingress), write requests requiring encryption (egress). Their headers are extended to carry additional information to help the SXP determine how the packets should be handled: an AES bit indicates that the read completion or the write request is encrypted; a 4-bit KEY_INDEX field identifies the physical key context to use; and a CC bit indicates the last packet of the frame and triggers the computation of its authentication tag.

In write request packets (outbound to the host PCIe domain), the AES bit and the CC bit are set by the tile, whereas the KEY_INDEX is set by the SXP (as described below). In read completions packets, the information is set by the PCIe complex based on trusted state it maintains about pending read requests (as described below).

Read request packets and packets with the AES bit unset do not require encryption/decryption; they are passed unchanged. For all other packets, the header bypasses the AES core, then

- If the packet is the start of a new frame, the first block (16 bytes) of payload is passed to the AES core as AES_IV, and the subsequent blocks are passed as AES_DATA.
- If the packet is the continuation of a frame, its blocks of payload are passed as AES_DATA.
- If the packet is the end of a frame (flagged by the header CC bit), all but the last block of payload are passed as AES_DATA, and the last block is passed as AES_MAC. (This block carries the authentication tag when decrypting, and a padding block otherwise.)

Packets that both start and end a frame are similarly handled.

Key Selection. As described earlier, each SXP supports multiple physical key contexts to enable encryption/decryption of concurrent I/Os. The SXP provides a set of registers that can be programmed by the CCU to define a mapping between packets and the physical key context to use for encrypting/decrypting their payload. The registers, known as the *exchange block context map* (KXBCTXMAP), define a mapping from exchange block contexts to

physical key contexts. The compiler can define this mapping by assigning a set of tiles associated with an exchange block context to read/write from/to a single stream. When the SXP receives a packet, it computes the index of the exchange block context from the source tile identifier in the header, and uses it to look up the physical key context in KXBCTXMAP.

As additional defense-in-depth against misconfiguration or corruption of these registers, the SXP defines two additional sets of registers. The first set of registers, known as the *key region definition* registers (KSELLIMIT), can be used to define up to 17 disjoint tile PCI address regions, with the expectation that the compiler will allocate streams encrypted with different keys in different key regions. The first region is always interpreted as the cleartext region, and is used to map public data; reads from or writes to this region bypass the SXPs. A second set of registers, known as *physical context map* (KPHYSMAP) registers, define a 1:1 mapping between physical key contexts and key region identifiers. After inferring the physical key context using KXBCTXMAP, the SXP looks up KPHYSMAP using the physical key context to obtain a logical key region identifier. Then, it looks up the key region definition registers to obtain the key region. Finally, it checks if the tile PCI address of the request belongs to the region. A failure of this check indicates a misconfiguration of either one of these sets of registers, and causes the SXP to generate a security exception.

Once the SXP infers the physical key context, it updates the KEY_INDEX field in the request packet header. For write requests, the field is then used by the SXP to switch the AES core to the inferred physical context for encrypting its payload. However, for read requests, the situation is more involved, as the read requests bypass the AES core, and the inferred physical key context must be used to decrypt the read completions that will be returned by the host after the read request has been processed. When the PCI complex receives the read request, it caches the KEY_INDEX and AES fields in an on-chip lookup table along with other metadata, such as the source tile identifier. When the corresponding read completions arrive from the host, the PCI complex retrieves these fields from this lookup tables and inserts them into the read completion packets. The SXP can then use these values to identify the physical key context to use for decrypting the payload. The PCI complex also tracks the number of pending read completion packets for each read request, and sets the CC bit on the last read completion packet.

7 SOFTWARE EXTENSIONS

We now describe a set of extensions to the IPU software stack—the XLA backend in Tensorflow, the Poplar compiler and the Poplar runtime—to compile and execute confidential ML tasks using ITX in offline mode. This mode is triggered by a configuration option we have introduced in TensorFlow. When this option is enabled,

- The XLA backend transforms the computation graph to use a new abstraction called *confidential data streams* (Section 7.1) for all data transfers; this includes initial weights, training data, checkpoints and the trained model.
- The Poplar compiler usually compiles the computation graph into a set of IPU application binaries (one for each IPU), where each binary is a concatenation of tile-specific binaries. In confidential mode, the compiler encrypts each

tile binary into a set of encrypted frames using a freshly sampled model key. Each frame is assigned a unique IV by composing the code type, IPU ID, tile ID and frame index.

- The Poplar runtime is extended to securely bootstrap the task, then transfer its encrypted application binaries and data between the host and the IPU (Appendix A.7 illustrates this process for a sample training scenario.)

7.1 Confidential Data Streams

Confidential data streams are our compiler and runtime abstraction for transferring data to/from the IPU with confidentiality and integrity guarantees, leveraging SXPs. Each stream is a sequence of data instances encrypted with the same symmetric encryption key. Each data instance is partitioned into a sequence of frames, and each frame is encrypted using a unique IV composed of a stream type (data), a stream identifier (one for each stream in the application), and the index of the frame within the stream.

IVs do not depend on application-specific attributes, such as batch sizes, positions in the IPU address space associated with the stream, or the tiles that will issue read or write requests to the stream. Thus, a data stream can be encrypted and stored once, and then used for training multiple models.

The compiler and the runtime implement reads and writes to confidential data streams as follows. As discussed in Section 6.1, the compiler first assigns a region in tile PCI space to each stream, subject to the constraint that it never exceeds the total capacity of the IPU ring buffer (e.g., 256 MB).

Next, the compiler assigns sets of tiles to read from or write to each stream, reserves SRAM on each tile to hold a part of the stream, and generates SXP mappings, subject to the constraints that (a) the exchange block context associated with these tiles map to physical key contexts assigned to the stream, and (b) the number of physical key contexts in use at any point in the program does not exceed 16 for any SXP. To maximize performance under these constraints, the compiler may introduce synchronization points in the application where existing keys are invalidated and new keys are loaded. The compiler includes these synchronization points in the manifest, along with their key identifiers; and the (untrusted) Poplar runtime uses this part of the manifest to ask the CCU to load the next decryption keys into the SXPs at these points.

In multi-party scenarios, where tiles process encrypted data from multiple parties, the compiler may assign different sets of tiles to each party's stream and introduce additional internal exchanges to distribute the data to tiles that process the data altogether. This is due to the constraint that a tile is assigned only one physical key context at a time, and thus cannot interleave accesses to data encrypted with different keys.

The key changes apply only to input streams. Keys for output streams are derived and loaded by the CCU at the start of the TEE, and do not change throughout its lifetime. Therefore, a malicious runtime that does not follow the key schedule of the manifest can only cause decryption failures, resulting in denial-of-service.

Next, the compiler schedules read/write operations on each tile. The schedule is required to satisfy a hardware constraint that, at any point, the tiles that generate requests targeting any given physical key context be associated with a single exchange block context. This

is because, while the exchange block can dynamically synchronize and regulate requests within each exchange block context (so that its physical key context is used by one tile at a time) there is no such synchronization across exchange block contexts.

Finally, the compiler generates code on each tile that implements the schedule, to issue read/write requests for the accessed frames.

For reads, the tile code (i) determines the size and expected IV of the next frame; (ii) issues read request and wait for data to arrive in local memory; (iii) checks that the IV contained in the frame matches the expected IV, and generates security exception if not; (iv) strips IV and authentication tag; (v) strips any application-level padding. This sequence of steps is repeated for a pre-determined number of frames before the communication phase ends and the computation phase begins.

For writes, the tile code repeats the following steps for as many frames as needed to write the data: (i) determines the size and IV of the next frame; (ii) writes the IV to the first 16 bytes of the current frame; (iii) splits the frame into multiple packets, sets the AES bit in the header of all packets and the CC bit in the header of the last packet, and adds padding to the last packet according to padding requirements; and (iv) issues the write requests for the frame.

7.2 Secure Checkpointing

Each IPU periodically checkpoints its state to enable recovery from failures. A checkpoint is created by writing the weights of the model to an output stream. The checkpoint also includes metadata, such as the current offset for all confidential data streams. These offsets are also written in plaintext, so that the Poplar runtime can restart the job and resume loading of confidential data streams at the correct offset. Conversely, a checkpoint is restored by reading the weights using an input stream and resuming confidential streams from the checkpointed offsets. A checkpoint along with the job manifest and binaries suffice to resume an application from the checkpoint instead of restarting from the beginning.

In trusted mode, checkpoints are encrypted and integrity protected. In particular, tiles enforce the integrity of the process of restoring state from a previously created checkpoint. This includes protecting against attacks, such as tampering a checkpoint or loading a wrong checkpoint onto an IPU. (Guaranteeing freshness, e.g., resumption from the latest checkpoint, would involve some form of trusted persistent storage and is out of scope in this paper.)

Checkpoints are implemented using confidential streams. The IV for each frame uniquely encodes the checkpoint type, the epoch counter (incremented at each resumption), the checkpoint identifier (incremented at each saved checkpoint), the IPU and tile IDs, and the frame index. The CCU uses a separate key for each epoch; it installs the key of the epoch of the checkpoint it is resuming from, if any, and the key of the current epoch for writing all its checkpoints.

The tiles read and write checkpoints as follows:

- (1) Tiles obtain initial values of the epoch counter and checkpoint identifier from pre-determined locations in their tile memory; the CCU assigns them along with the bootloader code.
- (2) If the epoch counter is not null, tiles use it to compute their expected IVs and read their part of the corresponding checkpoint.
- (3) Each tile increments their local epoch counter and start (or resume) the application.

- (4) At regular intervals, the tiles checkpoint their part of the state, using IVs computed from their current values, and then increment their local checkpoint identifier.

7.3 Secure Bootstrapping

Secure bootstrapping is the process of securely loading encrypted application binaries into the IPU, either at the start of a job, or while resuming a job from a checkpoint.

Bootstrapping involves the following steps. First, the Poplar runtime loads the encrypted IPU binary in host memory and creates a TEE using the CCU APIs; this switches the IPU into trusted mode. Next, the CCU installs a *bootloader* (shown in Appendix A.5) onto every IPU tile using the autoloader described in Section 2.1, and also configures the SXPs with the model key and key regions in the tile PCI address space where the binary is loaded. The bootloader on each tile fetches the tile’s binary from host memory by issuing a sequence of read requests. Each frame received from the host is intercepted by the SXPs, authenticated and decrypted, and copied into tile memory. The bootloader then checks that the received IV matches the expected IV built into the bootloader logic; this check is performed in software because the SXPs only guarantee authenticity of each frame, not the integrity of the entire code or data stream. The failure of this check indicates an attempt by the host to tamper with the code stream (e.g., by replaying or reordering frames). In such an event, the tile raises a security exception, which is handled by the CCU. If all checks pass, the bootloader finally reconstruct the original cleartext binary by stripping the IVs and authentication tags from all frames.

Finally, the bootloader computes a hash of the tile binary; the tiles accumulate a hash of the whole application binary; and the CCU checks that it matches the measurement in the job manifest and generates a security exception otherwise. This protocol, together with the integrity of the bootloader whose measurement is included in the attestation report, guarantees application integrity.

7.4 Discussion: Online Mode and Inferencing

The software extensions described above can also be used in a configuration where IPUs are coupled with a CPU TEE such as an Intel SGX enclave or AMD SEV-SNP protected VM. For example, an Intel SGX enclave can host TensorFlow, the Poplar compiler and runtime, with an untrusted IPU driver running in the guest OS. In this configuration, the enclave would receive an encrypted model script from the model developer, and the Poplar runtime would encrypt the compiled IPU binary with fresh keys. Similarly, the enclave would receive encrypted training data from data providers on the basis of an Intel SGX and IPU attestation. The data can be decrypted, pre-processed and aggregated within the CPU enclave (in parallel with job execution) and re-encrypted by the Poplar runtime with fresh keys. Encrypted code/data still then need to be copied to a run buffer allocated outside the enclave (in the host process) accessible to the IPU. Inferencing can be supported in a similar way. We leave support for such scenarios as future work.

8 EVALUATION

Our evaluation focuses on the overhead of TEEs for ML training, using either CPUs or IPUs. TEEs for GPUs are discussed in the next

section; it would be hard to perform a precise comparison with their prototypes—we report on a first complete hardware implementation, whereas their experiments relied on simulations with benchmarks that are now outdated—but they exhibit 15–30% overheads due to software encryption/decryption on GPUs, which our design eliminates using hardware encryption. A general performance comparison with GPUs is out of scope; see [12].

Implementation. We have implemented ITX on a Graphcore GC200 IPU on a non-production development board. The IPU chip has been fabricated in TSMC’s 7nm technology node, including the on-chip security extensions, which account for less than 1% of the chip size. The CCU has been integrated on the development board and implements the firmware architecture described in Section 5, including the protocols for measured boot and TEE management. As part of post-fabrication validation, the on-chip IPU security extensions have been tested to verify they conform to their specified behavior. We leave in-depth hardware security analysis and procedures that seek to defeat an IPU TEE for future work.

We have implemented a software prototype for confidential training tasks where the host CPU server is untrusted, as discussed in Sections 4 and 7. Our current prototype includes experimental support in the ML framework, Poplar compiler and runtime. There are a few gaps in our prototype. (1) Our implementation currently supports only one IPU on the board; (2) For simplicity, the compiler makes use of only one logical key region onto which code, data, label, checkpoints, and outputs are mapped; Nevertheless, every encrypted frame is statically assigned a unique IV, preserving the invariant that each IV is used only once; (3) Secure resumption is not yet implemented; (4) The bootloader deployed on IPU tiles does not measure the application binary after authenticated decryption.

Experimental Results. Table 1 summarizes the hardware and software configuration of our test beds. We evaluate the performance of confidential training on ResNet models of various sizes (20, 56, and 110) on the Cifar-10 dataset. The dataset consists of 60,000 32x32 images spanning 10 classes; 50,000 of these images are used for training the dataset and the remaining are used for testing the resulting model. We ran the same training code and data configurations in clear and confidential mode, and confirmed that they both yield models with the same prediction accuracy.

We compare IPU TEEs against CPU TEEs based on the largest AMD SEV-SNP server we could find. Since these are early development boards, we operate them at a reduced frequency of 900 MHz; we expect better performance at higher frequencies. The AMD CPU testbed utilizes 48 single-threaded AMD CPU cores (out of 64); Hyperthreading does not improve performance due to high vector unit utilization leaving little room for another hyperthread. Moving from 32 to 48 cores improved performance by 10%.

Figure 8 shows the training throughput that we achieve in clear and confidential modes. IPU-based training even with a single IPU operating at reduced frequency is 12–20x and 13–17x faster than CPU-based training in clear and confidential modes respectively. Enabling SEV-SNP introduces modest overheads, ranging from 8% (small model) to 14% (large model) while the overheads of enabling ITX range from 3% (large model) to 58% (small model). Virtually all the overheads of ITX can be attributed to the time spent in programming SXPs; the cost of encrypted I/O accounts for only

Testbed	Training configuration
AMD SEV-SNP	ResNet-20. Batch size: 1534; 32 epochs.
48-core VM on 64-core	ResNet-56. Batch size: 768; 32 epochs.
EPYC 7763 @ 2.4GHz	ResNet-110. Batch size: 384; 64 epochs.
Graphcore GC200 ITX	ResNet-20. Batch size: 64; 32 epochs.
IPU @ 900 MHz, 2x24-	ResNet-56. Batch size: 32; 32 epochs.
core Intel Xeon 8168	ResNet-110. Batch size: 16; 64 epochs.

Table 1: Testbed configuration for TensorFlow training of ResNet models on Cifar-10 dataset. In each configuration, batch sizes are optimized to yield maximum performance. (Smaller batches do not affect correctness, but may improve convergence or accuracy.)

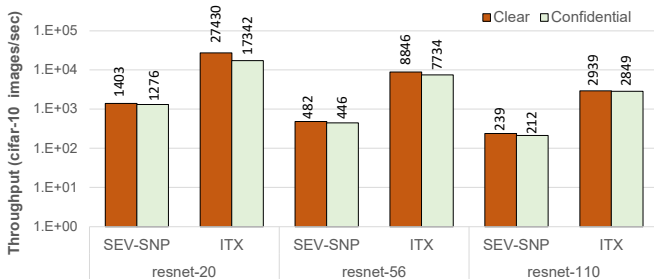

Figure 8: Training throughput of ResNet models on cifar-10.

1.3% of the overheads. This is a temporary artifact of our prototype firmware, and can be easily optimized. More generally, we expect the startup cost (TEE initialization, remote attestation, SXP setup) to be negligible with state-of-the-art models, which take weeks or days to train. With ResNet-110 model, the overall overhead is just 3% (1123 vs 1089 seconds for running 64 epochs). We also expect that utilizing both IPUs at full frequency would deliver an additional performance improvement (of up to 3.5x) over CPUs. In summary, the preliminary evaluation shows that using ITX, AI workloads can continue to benefit from the use of accelerators without compromising on performance or security.

9 RELATED WORK

ML Privacy. Machine learning involves many security and privacy issues, which often need to be addressed both in their application algorithms (applying, e.g., differential privacy and federated learning) and in their system implementations.

Several interesting lines of work develop novel cryptographic schemes for inference and training, relying on homomorphic encryption or secure multi-party computation instead of trusted hardware. These approaches can be implemented in software on existing CPUs, and even benefit from GPU acceleration—see e.g. [34, 35]. They offer strong confidentiality, notably against side-channels. However, they remain order-of-magnitude slower and more resource-intensive than TEE-based approaches—see [17] for a comparison. They also require significant algorithmic changes (to reduce the cost of fully implementing floating-point operations and non-linear layers) and separate mechanisms to protect the integrity of their computation.

Trusted hardware. There is a history of work [7–9, 15, 22, 22, 23, 29, 33, 39] on trusted hardware that isolates code/ data from the rest of the system. Intel SGX [24] and AMD SEV-SNP [5] are the latest

in this line of work. Our work effectively extends this approach from general-purpose CPUs to custom devices and accelerators.

Trusted execution on accelerators. To the best of our knowledge, our work is the first to demonstrate an ASIC with confidential computing capabilities. NVIDIA recently announced confidential computing support in upcoming Hopper GPUs [27]. NVIDIA’s design shares the same core principles as ITX on IPUs. The GPUs are equipped with an on-package hardware root of trust responsible for attestation and enforcing course-grained GPU isolation under the assumption that on-package GPU memory is trusted.

There are some notable differences. For example, in the NVIDIA design, a CPU-based TEE capable of hosting a full OS is necessary because the responsibility of attesting and establishing a secure channel with the GPU lies with the GPU kernel-mode driver. Also, the performance characteristics of NVIDIA’s approach are not yet known. Nevertheless, we believe that support for confidential computing in multiple accelerators will greatly benefit the ecosystem.

Prior work has attempted to reduce trust on privileged host [41] via hardware support on the GPU [38] or on the CPU [18]. Graviton [38] extends the GPU with support for secure resource management, and relies on a trusted GPU runtime hosted in a process-based CPU TEE to manage the TEE lifecycle. HIX [18] provides extensions to process-based CPU TEEs, including the PCI interconnect and the CPU’s MMU, to prevent system software from changing the PCI interconnect configuration and accessing GPU resources.

A number of researchers have identified the need for mechanisms that allow an application hosted in a TEE to securely communicate with I/O devices, such as in-storage processors [20], GPUs [18, 38, 41], FPGAs [21, 28, 31, 42], and AI accelerators [16, 40].

GuardNN removes the CPU from the TCB of AI systems [16]. It introduces instructions for establishing a secure channel between a remote user and the accelerator, and for decrypting/ encrypting inputs/outputs. Integrity is not guaranteed as an attacker controlling the CPU can tamper with the instruction schedule.

HETEE [43] enables confidential rack-scale AI computing using a tamper-resistant chassis that consists of computing nodes, commodity accelerators, a PCI switch, and a security controller. The security controller enables remote attestation and remote users to establish a secure channel with the chassis.

PCIe-level encryption. The deployment of devices that support standardized PCIe-level encryption [30] is expected to start in a few years. Compared to application-level encryption (Section 6) it may enable a more transparent and more efficient CPU–IPU protocol (removing the need for explicit IVs in ML applications.) However, it would involve a larger TCB with an auxiliary host CPU TEE.

10 CONCLUSION

We presented ITX, a set of experimental hardware extensions for the Graphcore IPU, a state-of-the-art AI accelerator. Our design provides application-level confidentiality and integrity for ML tasks offloaded to an untrusted cloud provider. We also presented a software architecture that avoids the need to trust host CPUs, thereby minimizing the trusted computing base and removing dependencies on CPU-based TEEs. We implemented them in the Graphcore GC200 IPU, and experimentally confirmed small performance overheads for training large models with strong security and privacy.

REFERENCES

- [1] 2022. Confidential Computing Consortium. <https://confidentialcomputing.io/>. (2022).
- [2] Alibaba. 2022. Alibaba unveils AI chip to enhance cloud computing power. https://www.alibabacloud.com/blog/alibaba-unveils-ai-chip-to-enhance-cloud-computing-power_595409. (2022).
- [3] Amazon. 2021. AWS Inferentia: High performance machine learning inference chip, custom designed by AWS. <https://aws.amazon.com/machine-learning/inferentia>. (2021).
- [4] Amazon. 2022. Confidential Computing. <https://aws.amazon.com/blogs/compute/tag/confidential-computing/g>. (2022).
- [5] AMD. 2021. AMD SEV-SNP: Strengthening VM isolation with integrity protection and more. <https://www.amd.com/system/files/TechDocs/SEV-SNP-strengthening-vm-isolation-with-integrity-protection-and-more.pdf>. (2021).
- [6] ARM. 2018. Security on ARM Trustzone. <https://www.arm.com/products/security-on-arm/trustzone>. (2018).
- [7] Rick Boivie. 2011. SecureBlue++: CPU Support for Secure Execution.
- [8] Victor Costan, Iliia A. Lebedev, and Srinivas Devadas. 2016. Sanctum: Minimal Hardware Extensions for Strong Software Isolation. In *USENIX Security Symposium*.
- [9] Dmitry Evtvushkin, Jesse Elwell, Meltem Ozsoy, Dmitry V. Ponomarev, Nael B. Abu-Ghazaleh, and Ryan Riley. 2014. Iso-X: A Flexible Architecture for Hardware-Managed Isolated Execution. In *International Symposium on Microarchitecture (MICRO)*.
- [10] Google. 2022. Confidential Computing. <https://cloud.google.com/confidential-computing>. (2022).
- [11] Graphcore. 2022. Graphcore IPU overview. <https://www.graphcore.ai/products/ipu>. (2022).
- [12] Graphcore. 2022. Performance at scale. Graphcore’s latest mlperf training results. <https://www.graphcore.ai/posts/performance-at-scale-graphcores-latest-mlperf-training-results>. (2022).
- [13] Trusted Computing Group. January 7, 2020. Symmetric Identity Based Device Attestation. Version 1.0, Revision 0.95. <https://trustedcomputinggroup.org/resource/symmetric-identity-based-device-attestation/>. (January 7, 2020).
- [14] Trusted Computing Group. March 22, 2018. Hardware Requirements for a Device Identifier Composition Engine Family 2.0, Level 00, Revision 78. https://trustedcomputinggroup.org/wp-content/uploads/Hardware-Requirements-for-Device-Identifier-Composition-Engine-r78_For-Publication.pdf. (March 22, 2018).
- [15] Owen S. Hofmann, Sangman M Kim, Alan M. Dunn, Michael Z. Lee, and Emmett Witchel. 2013. InkTag: Secure applications on an untrusted operating system. In *International Conference on Architectural Support for Programming Languages and Operating Systems (ASPLOS)*.
- [16] Weizhe Hua, Muhammad Umar, Zhiru Zhang, and G. Edward Suh. 2020. GuardNN: Secure DNN accelerator for privacy-preserving deep learning. In *ArXiv*.
- [17] Tyler Hunt, Congzheng Song, Reza Shokri, Vitaly Shmatikov, and Emmet Witchel. 2018. Chiron: Privacy-preserving machine learning as a service. In *ArXiv*.
- [18] Insu Jang, Adrian Tang, Taehoon Kim, Simha Sethumadhavan, and Jaehyuk Huh. 2019. Heterogeneous isolated execution for commodity GPUs. In *International Conference on Architectural Support for Programming Languages and Operating Systems (ASPLOS)*.
- [19] Norman P. Jouppi, Cliff Young, Nishant Patil, David Patterson, Gaurav Agrawal, Raminder Bajwa, Sarah Bates, Suresh Bhatia, Nan Boden, and et. al. 2017. Indatacenter performance analysis of a Tensor Processing Unit. In *International Symposium on Computer Architecture (ISCA)*.
- [20] Luyi Kang, Yuqi Xue, Weiwei Jia, Xiaohao Wang, Jongryool Kim, Changhwan Youn, Myeong Joon Kang, Hyung Jin Lim, Bruce Jacob, and Jian Huang. 2021. Ice-Clave: A trusted execution environment for in-storage computing. In *IEEE/ACM International Symposium on Microarchitecture (MICRO)*.
- [21] A. Khawaja, Landgraf, J. R. Prakash, M. Wei, E. Schkufza, and C. J. Rossbach. 2018. Sharing, protection, and compatibility for reconfigurable fabric with AmorphOS. In *USENIX Symposium on Operating System Design and Implementation (OSDI)*.
- [22] David Lie, Chandramohan A. Thekkath, Mark Mitchell, Patrick Lincoln, Dan Boneh, John C. Mitchell, and Mark Horowitz. 2000. Architectural Support for Copy and Tamper Resistant Software. In *International Conference on Architectural Support for Programming Languages and Operating Systems (ASPLOS)*.
- [23] Jonathan M. McCune, Ning Qu, Yanlin Li, Anupam Datta, Virgil D. Gligor, and Adrian Perrig. 2009. Efficient TCB reduction and attestation.
- [24] Frank McKeen, Ilya Alexandrovich, Alex Berenzon, Carlos V. Rozas, Hisham Shafi, Vedvyas Shanbhogue, and Uday R. Savagaonkar. 2013. Innovative Instructions and Software Model for Isolated Execution. In *International Workshop on Hardware and Architectural Support for Security and Privacy (HASP)*.
- [25] ST Microelectronics. 2022. STM32 MCUs secure firmware install overview. https://www.st.com/resource/en/application_note/an4992-stm32-mcus-secure-firmware-install-sfi-overview-stmicroelectronics.pdf. (2022).
- [26] ST Microelectronics. 2022. STM32H573 microcontroller with crypto accelerators. <https://www.st.com/en/microcontrollers-microprocessors/stm32h743-753.html#documentation>. (2022).
- [27] NVIDIA. 2022. NVIDIA Confidential Computing. <https://www.nvidia.com/en-in/data-center/solutions/confidential-computing/>. (2022).
- [28] Hyunyoung Oh, Kevin Nam, Seongil Jeon, Yeongpil Cho, and Yuneheung Paek. 2021. MeetGo: A trusted execution environment for remote applications on FPGA. *IEEEAccess* 9 (2021), 51313–51324.
- [29] Emmanuel Owusu, Jorge Guajardo, Jonathan M. McCune, James Newsome, Adrian Perrig, and Amit Vasudevan. 2013. OASIS: On achieving a sanctuary for integrity and secrecy on untrusted platforms. In *ACM Conference on Computer and Communications Security (CCS)*.
- [30] PCI-SIG. 2022. Integrity and Data Encryption (IDE). <https://members.pcisig.com/wg/PCI-SIG/document/15149>. (2022).
- [31] S. Pereira, D. Cerdeira, C. Rordrigues, and S. Pinto. 2021. Towards a trusted execution environment via reconfigurable FPGA. In *ArXiv*.
- [32] Mark Russinovich, Manuel Costa, Cedric Fournet, David Chisnall, Antoine Delignat-Lavaud, Sylvan Clebsch, Kapil Vaswani, and Vikas Bhatia. 2021. Toward confidential cloud computing. *Communications of ACM* 64 (2021), 54–61. Issue 6.
- [33] Richard Ta-Min, Lionel Litty, and David Lie. 2006. Splitting Interfaces: Making trust between applications and operating systems configurable. In *USENIX Symposium on Operating System Design and Implementation (OSDI)*.
- [34] Sijun Tan, Brian Knott, Yuan Tian, and David J. Wu. 2021. CryptGPU: Fast Privacy-Preserving Machine Learning on the GPU. In *2021 IEEE Symposium on Security and Privacy (SP)*. 1021–1038.
- [35] Florian Tramer and Dan Boneh. 2019. Slalom: Fast, verifiable and private execution of neural networks in trusted hardware. In *International Conference on Learning Representations (ICLR)*.
- [36] Trusted Computing Group. 2022. DICE. <https://trustedcomputinggroup.org/work-groups/dice-architectures/>. (2022).
- [37] Trusted Computing Group. March 5, 2018. Trusted Computing Group: Implicit Identity Based Device Attestation. Version 1.0, Revision 0.93. <https://trustedcomputinggroup.org/resource/implicit-identity-based-device-attestation/>. (March 5, 2018).
- [38] Stavros Volos, Kapil Vaswani, and Rordrigo Bruno. 2018. Graviton: Trusted execution environments on GPUs. In *USENIX Symposium on Operating System Design and Implementation (OSDI)*.
- [39] Samuel Weiser and Mario Werner. 2017. SGXIO: Generic trusted I/O Path for Intel SGX. In *ACM Conference on Data and Application Security and Privacy (CODAPSY)*.
- [40] Peichen Xie, Xuanle Ren, and Guangyu Sun. 2020. Customizing trusted AI accelerators for efficient privacy-preserving machine learning. In *ArXiv*.
- [41] Miao Yu, Virgil D. Gligor, and Zongwei Zhou. 2015. Trusted Display on Untrusted Commodity Platforms. In *ACM Conference on Computer and Communications Security (CCS)*.
- [42] Mark Zhao, Mingyu Gao, and Christos Kozyrakis. 2021. ShEF: Shielded enclaves for cloud FPGAs. In *ArXiv*.
- [43] Jianping Zhu, Rui Hou, Xiaofeng Wang, Wenhao Wang, Jiangfeng Cao, Boyan Zhao, Zhongpu Wang, Yuhui Zhang, Lixin Zhang, and Dan Meng. 2020. Enabling rack-scale confidential computing using heterogeneous trusted execution environment. In *IEEE Symposium on Security and Privacy (SP)*.

A APPENDIX

A.1 Attack Vectors and Security Analysis

Table 2 summarizes the attack vectors discussed in Section 3 and, for those covered by our threat model, how ITX mitigates each of these attacks.

A.2 Firmware Provisioning and Device Certification

In this section, we describe an example process for firmware provisioning and device certificates that would be followed if ITX were to be used in a production Graphcore IPU products in a production environment. During board manufacturing, the CCU would be provisioned with firmware followed by a board reset to harvest certificate signing requests (CSRs) generated by the execution of the primary and secondary bootloaders. The CSRs would then be used by Graphcore to issue device certificates.

Threat	Mitigation
Host (Software, Physical) <i>IPU Memory Access</i> , e.g., host software uses MMIO and PCI BARs, physical attacker tampers with on-chip memory <i>Host CPU, Memory, and PCIe bus</i> , e.g., read, write, replay, or re-ordering of code and data in host memory or in transit, including DMA buffers and PCIe bus <i>IPU Binary Malleability</i> , e.g., host replaces model encryption key or encrypted code <i>IPU Connectivity</i> , ICU-CCU or ICU-IPU Tampering on the development board IPU-IPU Tampering	MMIO blacklist prevents CPU from accessing code and data in IPU; access via interfaces like JTAG is prohibited; IPU memory cannot be physically accessed without breaking into the package. Code and data are encrypted with AES-GCM using explicit IVs, and keys not shared with the host; uniqueness and integrity of IVs are ensured by trusted code executed on tiles. Bootloader computes hash of the tile binary; hash accumulated and checked against expected measurement in the job manifest. (Not implemented in the evaluated prototype.) no ; attacker can mount a physical attack to (1) retrieve the key(s) sent to IPU, and (2) tamper with ICU firmware measurement sent to CCU no ; attacker can mount physical attacks against multi-IPU tasks by tampering with data sent between IPU.
Supply Chain and Firmware Primary Bootloader Provisioning Tampering Using non-genuine, known vulnerable TCB components	Graphcore checks whether the signed bootloader manifest includes the expected nonce provisioned into the CCU primary bootloader. Firmware authorization; hardened measurement protocol outlined in Appendix A.4.
Side-channels IPU Memory Host Memory and PCIe bus Power- and timing-level	IPU memory access patterns cannot be observed by co-located attacker as the IPU is entirely assigned to one job at a time. no : attacker can observe access patterns to host memory and on PCIe bus. However, these patterns do not leak much information in the BSP model, e.g., the size and number of minibatches, but not their contents. no : attacker can measure power consumption and/or execution time of a superstep. Similarly, this does not leak much information for typical ML tasks.

Table 2: Potential threats and how ITX mitigates them. Physical access attacks on the CCU-ICU-IPU and the IPU-IPU channels can be mitigated once the CCU is integrated on the IPU and AES-GCM is utilized to protect the IPU-IPU channels.

Firmware Provisioning. The CCU is provisioned with firmware using the SoC’s Secure Firmware Install (SFI) feature [25]. The

firmware package consists of all firmware layers discussed in Section 5.1 and the configuration bytes (called `OPTION`), whose secure user memory registers are configured so that secure user memory includes only the regions onto which the secure bootloader is deployed. The firmware package is encrypted with a symmetric key, which is provisioned to a hardware security module (HSM).

The encrypted firmware package and the HSM are used by the board manufacturer to deploy CCU firmware during the manufacturing and testing of the Graphcore products. The chip tester implements a multi-stage protocol between the CCU secure bootloader and the HSM, during which the HSM authenticates the certificate issued by the CCU and wraps its firmware encryption key using the certified public key. This enables the CCU secure bootloader to decrypt the firmware package, to install the firmware, and to configure the `OPTION` bytes based on the requested configuration.

While this SFI process guarantees confidentiality of the firmware, it does not directly protect its integrity: the provisioning process may be subject to supply-chain attacks that would replace CCU parts provisioned using SFI with CCU parts containing malicious firmware. We extend SFI with protection against such attacks by injecting a secret known only to Graphcore into the primary bootloader. Once the CCU has been integrated onto a Graphcore board, a challenger can ask the primary bootloader to prove possession of the secret.

This process entails the following three steps. First, Graphcore generates a fresh secret for every batch of CCUs. The secret is injected to the primary bootloader of the CCU firmware. Second, Graphcore derives from the secret an asymmetric batch-specific bootloader manifest signing key. After deriving this key, Graphcore keeps only the public part. Third, Graphcore issues a certificate for the public bootloader manifest signing key. The certificate is signed by the Graphcore Firmware certificate authority (CA). This certificate contains a batch number, and is valid till the production date of the batch of CCUs.

Device Certification. In order to certify its device identity keys, the board tester resets the board and harvests the CIK and PIK CSRs generated for the board and platform identity keys, as well as the bootloader manifest. The command to harvest the bootloader manifest includes a fresh nonce, to be echoed in the signed bootloader manifest.

In response, Graphcore verifies the CSRs received by the card manufacturer and issues CIK and PIK certificates that are signed by the Graphcore CIK and PIK CAs. In addition, Graphcore validates the bootloader manifest against the bootloader manifest signing key certificate expected specific to the batch to which the CCU belongs, and ensures that the nonce matches the expected nonce.

A.3 Firmware Updates

The CCU firmware consists of mutable secondary bootloader and CCE, both authenticated by the primary bootloader and possibly updated after the Graphcore card has been deployed in production.

Updates to Secondary Bootloader. The secondary bootloader involves relatively complex cryptographic operations, and may need to be updated in the field. As discussed in Section 5.1, the platform identity key (PIK) is derived from UDS depending on the hash of the secondary bootloader. Therefore, any updates to the secondary

bootloader changes the platform identity, and PIK certificates issued by the manufacturer are no longer valid, requiring re-certification of the device by the manufacturer.

Unfortunately, re-certification of a remote device by the manufacturer can be a complex and lengthy operation as the manufacturer (by design) does not retain unique device keys. Thus, it requires collection of CSRs from the device, and more importantly an authentication mechanism to ensure that the manufacturer signs only PIK certificates exported from devices in the cloud provider’s datacenters.

We overcome this challenge via a protocol that enables updates to the secondary bootloader without invalidating manufacturer-issued certificates.

Prior to updating the secondary bootloader (say to version Y), the cloud provider’s Graphcore Firmware CA issues a TCB update certificate capturing the measurement of the new version of the secondary bootloader and revokes previous certificates for versions of the secondary bootloader that should no longer be deployed.

After a firmware update has been deployed, the primary bootloader generates a new CDI (CDI^Y). The secondary bootloader generates platform identity and attestation keys specific to this version of firmware (PIK^Y and AK^Y). However, the card identity key (CIK) stays the same as it does not depend on the measurement of the secondary bootloader. The PIK^Y certificate, hence, is signed by the original CIK, which has been certified by the manufacturer.

Subsequently, a remote challenger can combine the TCB update certificate with the CIK certificate originally issued by the manufacturer to verify the PIK^Y certificate is issued by the device using the original CIK, and that the measurement of the new secondary bootloader in the PIK^Y certificate matches the measurement of the secondary bootloader in the TCB update certificate.

Updates to CCE. They can be applied at any point without the need for any additional certification from the manufacturer. When a device boots with a new version of CCE, it generates a new attestation key with a signature over the public AK along with a hash of the CCE using the PIK. Quotes generated by the updated version of CCE firmware can be validated using a valid PIK certificate.

A.4 Measured Boot Protocol

As discussed in Section 5.1, the measured boot protocol is susceptible to advanced impersonation attacks. We can harden the boot protocol further by moving CIK and PIK generation into the primary bootloader (as shown in Figure 9) without revealing the private CIK to the secondary bootloader.

In this protocol, the primary bootloader generates CIK from UDS, and generates PIK using CDI and the measurement of the secondary bootloader. To allow a relying party (such as the Graphcore CA) to attest that the PIK was indeed generated by the primary bootloader, the primary bootloader creates a custom structure known as PIK endorsement containing the PIK public key along with a measurement of the secondary bootloader, and a signature over these two attributes using the CIK. The bootloader then scrubs the CIK private key and passes public CIK and PIK keys along with the private PIK and the PIK endorsement to secondary bootloader. During manufacturing, the Graphcore PKI issues a PIK certificate only after validating the PIK endorsement structure.

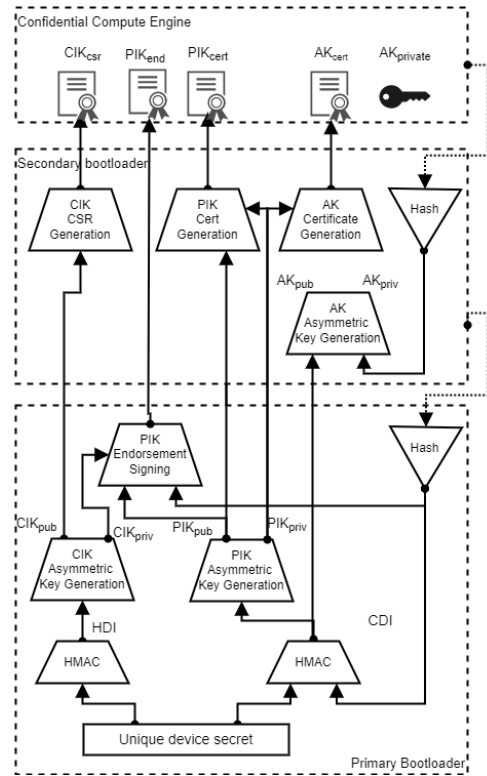

Figure 9: Hardened boot protocol that protects against bootloader impersonation attacks.

Our prototype CCU does not implement this protocol to keep the primary bootloader simple, but this is easy to address in the future.

A.5 Compiled Manifests and Bootloader

Job Manifest. The Poplar compiler generates a job manifest, which includes all the information required by the Poplar runtime and CCU to create and launch a new TEE, which will host the ML task. The manifest contains the hash digest of the application binary loaded into each IPU. Finally, it lists the synchronization barriers (or points) at which the IPU needs to synchronize with the host, and for each synchronization point, it keeps the following information:

- the key region identifier assigned to each stream that will be read or written following the end of synchronization (i.e., the mapping between a stream identifier j to a key region identifier);
- the ring buffer region (i.e., Tile PCI space in the ring buffer) assigned to each key region (key region definition registers);
- the part of each stream that has been mapped to the ring buffer region (stream offset);
- the set of physical key contexts to which the stream key needs to be loaded;
- the physical key context assigned to each exchange block context (exchange block context map registers); and

- the key region to which each physical key context is assigned (physical key map registers).

Secure Code Bootstrapping. The code snippet below illustrates the bootloader code that fetches the frames of an application binary and confirms the integrity of the IV of each frame.

```
def bootloader():
    ipu_id = get_current_ipu_id()
    tile_id = get_current_tile_id()
    num_frames = TOTAL_TILE_MEMORY / (MAX_FRAME_SIZE -
        IV_SIZE - TAG_SIZE)

    for index in range(1, num_frames):
        expected_iv = StreamType:CODE | ipu_id | tile_id |
            index
        frame = read_next_frame_from_host()
        if expected_iv != get_iv(frame):
            raise_security_exception()
        strip_iv_and_tag(frame)
        compute_hash()
```

A.6 Attestation

Cryptographic Operations. Table 3 details the keys sampled, derived, and exchanged at the start of a run in trusted mode. We rely on standard algorithms: Elliptic Curve Diffie-Hellman for establishing shared secrets, a KDF for deriving keys, and an AES-based authenticated key-wrapping scheme. These operations rely on the attestation of the manifest and runtime parameters (including all public keyshares). Each party provides its own random nonce, and the CCU combines them to deterministically derive keys for checkpoints and the final model; these keys are fresh secrets as long as one party is honest. In order to resume from a checkpoint saved in a previous run, the attested runtime parameters ensures that all parties agree on the epoch and checkpoint identifiers, and the parties provide their nonces both for the previous run and for the new run.

Remote Attestation. During TEE creation, the CCU generates an attestation report that captures security-critical attributes about the IPU and runtime configuration, including

- the measurement of configuration registers;
- the measurement of the IPU bootloader used for loading application binaries onto IPU;
- the measurement of the job manifest;
- the hash digest of the attributes for this run, including:
 - the public keyshare of the CCU for this run (Y);
 - the epoch e and checkpoint counter c from which the job is restarted (if any);
 - the certificate fingerprints of all parties (\vec{X}_p);
 - a stream assignment, specifying a party for each input, and parties (model receivers) that receive the model key;

The host collects the attestation report, along with a CCU-issued certificate chain, which includes the AK, PIK and CIK certificates, and is rooted at the self-signed CIK certificate. These are presented to relying parties along with: the original CIK and PIK certificates, the TCB update certificates for the secondary bootloader and ICU firmware, and any intermediate CA certificates.

A relying party can verify the attestation report as follows:

Key or secret	Provider	CCU	
public/private keyshare for each relying party p	X_p, x_p	fresh EC share	receive X_p
encryption key for each input stream j	k_j	fresh key	unwrapped
public/private keyshare for the CCU in this run	Y, y	receive Y	fresh EC share
nonce for p in this run	$s_{p,Y}$	fresh secret	unwrapped
wrapping key for p, Y with salt $a = X^p Y M$	w_p	$\text{KDF}[x_p \cdot Y](a)$	$\text{KDF}[y \cdot X_p](a)$
key to load checkpoints saved by prior run Z	k_{load}	N/A	$\text{KDF}[\vec{s}_{p,Z}]('ck')$
key to save checkpoints	k_{save}	N/A	$\text{KDF}[\vec{s}_{p,Y}]('ck')$
key to save final model	k_m	unwrapped	$\text{KDF}[\vec{s}_{p,Y}]('m')$

Table 3: Keying for a workload with manifest M between relying parties identified by their public keyshares \vec{X}_p and a CCU identified by its fresh CCU public keyshare Y for this run. After attestation, an ECDH shared secret w_p is used for wrapping $k_j, s_{p,Y}$, and $s_{p,Z}$ when resuming from Z from p to the CCU, and optionally for wrapping k_m from CCU to any party p designated as a receiver of the final model. The keys used for encrypting checkpoints and the final model are derived from nonces from all relying parties, ensuring these keys are fresh (as soon as one party is honest) and require agreement from all parties to be released.

- (1) Validate the CCU-generated certificate chain and auxiliary certificates. This includes checking for certificate revocation.
- (2) Confirm that public key of the CIK certificate issued by Graphcore matches the public key in the CIK certificate obtained from the CCU.
- (3) Confirm that any updates to the secondary bootloader and ICU firmware are rooted to a valid certificate chain. In doing so, two checks are required: (i) if there exists a TCB update certificate issued for the secondary bootloader with a hash digest matching the hash digest in the CCU- issued PIK certificate; (ii) if there exists a TCB update certificate issued for ICU firmware with a hash digest matching the hash digest in the CCU- issued PIK certificate.
- (4) Review the attested manifest and attributes for this run.

Secure Key Exchange. For each run, each party p derives a fresh wrapping key w_p using its private keyshare x_p and the public keyshare of the attested CCU Y . This key is used to wrap a key package containing the streams identifiers assigned to the party and the party’s key for these streams k_j , and the nonce(s) $s_{p,Y}$ for the current run (and $s_{p,Z}$ for the previous run if the current run is resuming from a checkpoint saved in run Z .) The CCU can derive the wrapping key for party p using its private keyshare y and the party’s public keyshare X_p . In possession of w_p , the attested CCU can unwrap the key packages of all parties, which are made available during the TEE launch stage.

The parameters of the model are encrypted using the final-model key k_m that has been derived by the CCU using the nonces obtained from all parties. The parties engage in a protocol for exchanging their nonces so they can derive the key once they possess all nonces. The CCU can additionally release the final-model key to model

receivers listed in the attestation report using the wrapping key shared between itself and each model receiver.

A.7 Sample Training Scenario

Figure 10 illustrates a sample training scenario with three parties. Given the job manifest generated by the Poplar compiler, Poplar runtime, CCU, and IPU synchronize at various points where the Poplar runtime populate the ring buffer with the data expected by the IPU, and the CCU loads encryption keys to the IPU SXPs.

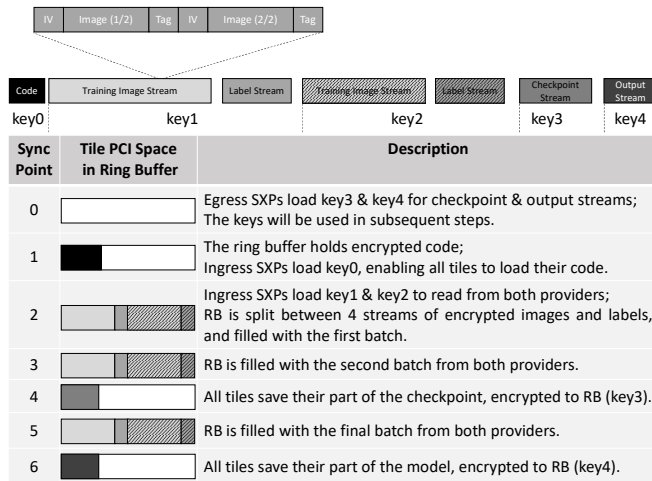

Figure 10: Sample training scenario with 3 parties: one providing model code (using key0) and the others (using key1 and key2) each providing their own streams of training images and labels; this task saves checkpoints (using key3) and a final model (using key4). The compiler emits a job manifest that indicates, for each synchronization point of the task, which part of each stream is mapped to the ring buffer (1..6) and which keys the CCU should load for ingress. The keys for egress streams are programmed in the start of the job (0).