

Edge Resolvability of Crystal Cubic Carbon Structure

Sahil Sharma¹, Vijay Kumar Bhat^{2,*}, Sohan Lal³

School of Mathematics,

Shri Mata Vaishno Devi University,

Katra-182320, Jammu and Kashmir, India.

1. sahilsharma2634@gmail.com 2. vijaykumarbhat2000@yahoo.com 3.
sohan1993sharma@gmail.com

Abstract Chemical graph theory is commonly used to analyse and comprehend chemical structures and networks, as well as their features. The resolvability parameters for graph $G = (V, E)$ are a relatively new advanced field in which the complete structure is built so that each vertex (atom) or edge (bond) represents a distinct position. In this article, we study the resolvability parameters i.e., edge resolvability of chemical graph of crystal structure of cubic carbon $CCS(n)$.

Keywords: Edge metric dimension, metric dimension, crystal cubic carbon, cubes

MSC(2020): 13A99, 05C12

1. Introduction

Mathematical applications have been increasingly popular in recent years. Graph theory has rapidly grown in theoretical conclusions as well as applicability to real-life issues as a handy tool for dealing with events relations. Distance is a concept that penetrates all of the graph theory, and it is utilized in isomorphism tests, graph operations, maximal and minimal connectivity problems, and diameter problems. Several characteristics linked to graph distances have piqued the interest of several scholars. One of them is the metric dimension.

The notion of *metric dimension* (MD) was introduced by Slater [18], Melter and Harary [5] independently. They termed the ordered subset $K = \{\alpha_1, \alpha_2, \alpha_3, \dots, \alpha_m\}$ of vertices of graph $G = (V, E)$ as resolving set, if the representation $r(u|K) = (d(u, \alpha_1), d(u, \alpha_2), \dots, d(u, \alpha_m))$ for each $u \in V$ is unique, where $d(u, \alpha_m)$ is the shortest path between u and α_m . The cardinality of the minimal resolving set is called MD (locating number) of G , and is denoted by $dim(G)$. Chartrand et al. [3] studied MD of path graphs (P_n) and complete graph (K_n). Later on, Caceres et al. [2] studied about MD of the cartesian product of graphs, hypercubes, and cycles graphs. MD of regular graphs, Jahangir graphs, prism graphs, and circulant graphs was examined by several different authors. In chemistry, MD is used to give a series of compounds a unique representation, which leads to drug discovery. Other applications of MD include navigation, combinatorial optimization, and games such as coin weighing, etc. [3, 15].

However in connection with the study of a new variant of metric generator in graphs Kelenc et al. [8], introduced *edge metric dimension of a graph* (EMD). This is based on the fact that an ordered subset H of vertices of $G = (V, E)$ is called an edge resolving set (edge metric generator), if for $e_1 \neq e_2 \in E$, there is a vertex $h \in H$ such that $d(e_1, h) \neq d(e_2, h)$, where $d(e, h) = \min\{d(a, h), d(b, h)\}$, $ab = e \in E$ and $h \in H$. The cardinality of the smallest edge metric generator (edge basis) is called EMD and is denoted by $edim(G)$. After that, Zhang and Gao [23] discussed EMD of some convex polytopes. EMD of path graphs, complete graphs, bipartite graphs, wheel graphs, and many others have been studied. Recently, Knor et al. [10] studied graphs with $edim(G) < dim(G)$. After the introduction of EMD by Kelenc et al. [8], several other authors [4, 13, 14, 17, 19] have studied it thoroughly.

The structure of a chemical molecule is commonly described by a group of functional groups placed on a substructure. The structure is a graph-theoretic labelled graph, with vertex and edge labels representing atom and bond types, respectively. A collection of compounds is primarily defined by the substructure common to them, which is characterised by modifying the set of functional

groups and/or permuting their locations. Traditionally, these “positions” simply reflect uniquely defined atoms (vertices) of the substructure (common subgraph). These positions seldom form a minimum set K for which every two distinct vertices have distinct ordered k -tuples forming a minimum dimensional representation of the positions definable on the common subgraph. In this context, K is referred to as a resolving set relative to $V(G)$.

We can assess whether any two compounds in the collection share the same functional group at a given position using the standard pattern. When analyzing whether a compound’s characteristics are responsible for its pharmacological activity, this comparison statement is important [2, 3]. Sharma et al. [16] studied the mixed metric resolvability of chemical compound polycyclic aromatic hydrocarbon networks. The problem of computing the edge metric dimension of $CCS(n)$ and certain generalisations of these graphs is discussed in this work. One of the forms of carbon, namely diamond, is anticipated to convert into the C_8 structure, which is a cubic body-centered structure having 8 elements in its unit cell, at pressures exceeding 1000 GPa (gigapascal). Its composition is comparable to cubane and is found in one of silicon’s metastable phases. Carbon sodalite was postulated as the structure of this phase in 2012. This cubic carbon phase could be useful in astronomy.

Several authors studied different topological properties of $CCS(n)$. Yang et al. [21] studied the Augmented Zagreb index, forgotten index, Balaban index, and redefined Zagreb indices of $CCS(n)$. Baig et al. [1] computed the degree-based additive topological indices mainly atom bond connectivity index, geometric index, first and second Zagreb index, etc. Further, Imran et al. [7] studied eccentric based bond connectivity index and eccentric-based geometric arithmetic index of $CCS(n)$. For further studies concerning the $CCS(n)$ one can refer to [20, 22] and references therein.

Zhang and Naeem [24] studied the metric dimension of $CCS(n)$. They computed that for $n = 1$, $dim(CCS(n))$ is 3, and for $n \geq 2$, $dim(CCS(n))$ is $7^{n-2} \times 16$. To the best of our knowledge, no work has been reported regarding the edge metric basis and edge metric dimension (EMD) of $CCS(n)$. For this, we consider the baseline paper reported by (Zhang and Naeem [24]) and further extend the result with comparisons. In this study we compute the EMD of $CCS(n)$ and we also show that MD and EMD of $CCS(n)$ are the same.

2. Crystal Cubic Carbon Structure $CCS(n)$

The valency of carbon allows it to create a variety of allotropes. Diamond and graphite are well-known forms of carbon, while crystal cubic carbon, also known as pcb, is one of its potential allotropes. The chemical structure of $CCS(n)$ is constructed as

1. $CCS(n)$ starts from one unit cube, also called $CCS(1)$, and central cube as shown in Fig. 1.
2. At the second level all the eight vertices of $CCS(1)$ are attached to different cubes through edges (bridge edges), which results in the construction of $CCS(2)$ as shown in Fig. 2.
3. Again at the next level all the 7×8 vertices of degree 3 of $CCS(2)$ are attached to different cubes through edges, which results in the construction of $CCS(3)$.
4. Similarly we construct $CCS(n)$ by attaching new cubes to the vertices of degree 3 at the preceding level as shown in Fig. 3.

At each level, we receive a new set of cubes that are attached to the vertex of degree 3 of cubes of the previous level. These cubes are referred to as the outermost cubes. In $CCS(2)$, we can also see that there are eight outermost cubes and 7×8 vertices of degree 3. So at the third level, 7×8 cubes are attached. Similarly, there are $7^{n-2} \times 8$ vertices of degree 3 at each subsequent level. So, this process is again repeated to get the next level.

2.1 Origin of Crystal Cubic Carbon Structure $CCS(n)$

Carbon, as one of the elements that have been known and used on the planet since ancient times, continues to draw attention due to its wide range of industrial and commercial applications, ranging from cutting tools to electrical and optoelectronic materials, and so on. Carbon exhibits the adaptability of sp , sp^2 , and sp^3 hybridization states, resulting in a variety of rich allotropic carbon forms. Graphite and diamond are two prevalent allotropes of carbon, with the former being the

most thermodynamically stable form of all known carbon allotropes at ambient temperatures (e.g. hexagonal diamond, amorphous carbon, carbyne, fullerenes, carbon nanotubes, crystal cubic carbon and graphene).

Diamond is projected to convert into a body-centered cubic structure at ultra high pressures of above 1000 GPa. This phase is significant in astrophysics and the study of the deep cores of planets such as Uranus and Neptune. In 1979, [11] a super dense and super hard material that looked like this phase was synthesised and published, having the $Im\bar{3}m$ space group and eight atoms per primitive unit cell. It was claimed that the so-called C_8 structure, with eight-carbon cubes comparable to cubane in the $Im\bar{3}m$ space group, had been synthesised, with eight atoms per primitive unit cell or 16 atoms per standard unit cell. The super cubane structure, the BC8 structure, a structure with clusters of four carbon atoms in tetrahedra in space group $I\bar{4}3m$ with four atoms per primitive unit cell (eight per conventional unit cell), and a structure named "carbon sodalite" were all discussed in a report published in 2012, [12]. In 2017, Baig et al. [1] modified and extended the structure of carbon sodalite and named it crystal cubic carbon $CCS(n)$. $CCS(n)$ as a carbon allotrope is assumed to have wide a range of industrial applications. For more study on carbon allotropes one can refer [6, 9].

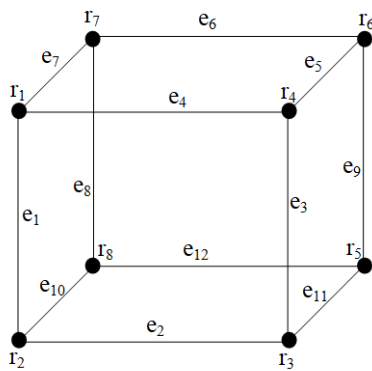

Figure 1: The chemical structure of $CCS(1)$.

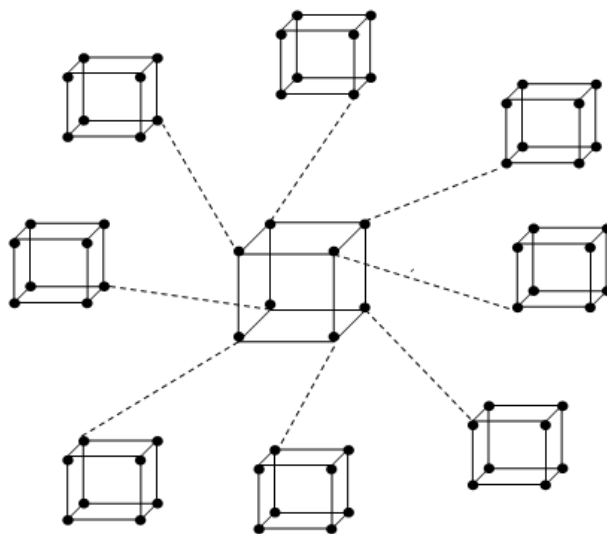

Figure 2: The chemical structure of $CCS(2)$.

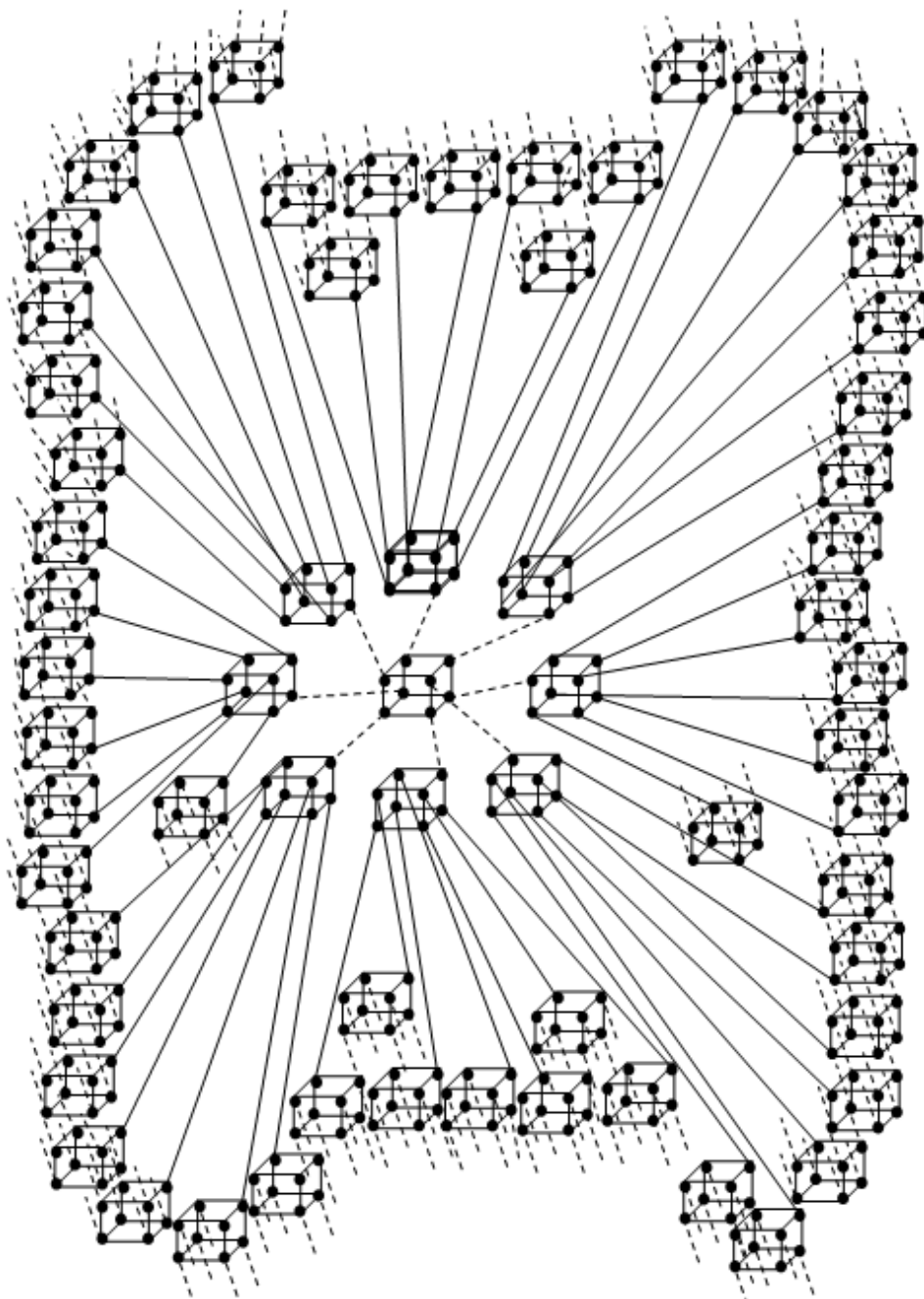

Figure 3: The chemical structure of $CCS(n)$.

3. Edge metric dimension of $CCS(n)$

The EMD of various graphs like Mobius network, wheel graph, convex polytopes, windmill graph, etc. have been studied. We will discuss the EMD of $CCS(n)$, $n \geq 1$ in this section.

Theorem 1. For $n = 1$, the edge metric dimension of $CCS(n) = 3$.

Proof. First, claim that $edim(CCS(1)) \leq 3$. We have labelled all 8 vertices of the cube as r_i , $1 \leq i \leq 8$, and edges as e_i , $1 \leq i \leq 12$ as shown in Fig. 1.

Let $R_E = \{r_1, r_2, r_3\}$ be set of vertices of graph $CCS(1)$. We have to show that R_E is an edge

metric generator of $CCS(1)$.

The representation of each edge e_i , $1 \leq i \leq 12$ with respect to R_E is given as

$$\begin{array}{ll}
r[e_1|R_E] = (0, 0, 1) & r[e_7|R_E] = (0, 1, 2) \\
r[e_2|R_E] = (1, 0, 0) & r[e_8|R_E] = (1, 1, 2) \\
r[e_3|R_E] = (1, 1, 0) & r[e_9|R_E] = (2, 2, 1) \\
r[e_4|R_E] = (0, 1, 1) & r[e_{10}|R_E] = (1, 0, 1) \\
r[e_5|R_E] = (1, 2, 1) & r[e_{11}|R_E] = (2, 1, 0) \\
r[e_6|R_E] = (1, 2, 2) & r[e_{12}|R_E] = (2, 1, 1)
\end{array}$$

The representation of each edge is unique. Therefore $edim(CCS(n)) \leq 3$.

Next, we claim that $edim(CCS(1)) \geq 3$.

Since, for any graph G , $edim(G) = 1$ iff G is a path graph. This implies that $edim(CCS(1)) \neq 1$. Now, if $edim(CCS(1)) = 2$, then edge metric generator R_E of $CCS(1)$ consists of two vertices (say $R_E = \{r_i, r_j\}; i \neq j$). Due to the symmetry of $CCS(1)$, we have two choices for the vertices of R_E .

1. Both the vertices of R_E are on the same face of the cube.

Further, we have two choices

- (i) r_i and r_j are on the face diagonal of the cube.
- (ii) r_i and r_j are on the same edge of the face of the cube.

2. Both the vertices of R_E are on the primary diagonal of the cube.

Case 1: Firstly, when both vertices are on the same face and along the face diagonal, then we consider $R_E = \{r_1, r_3\}$. We have $r[e_1|R_E] = (0, 1) = r[e_4|R_E]$.

Secondly, when both vertices are on the same face and along the same edge, then we consider $R_E = \{r_2, r_3\}$. We have $r[e_4|R_E] = (1, 1) = r[e_{12}|R_E]$.

Case 2: When both vertices are on the primary diagonal of the cube, then we consider $R_E = \{r_3, r_7\}$. We have $r[e_4|R_E] = (1, 1) = r[e_5|R_E]$.

In both cases, we get a contradiction. Therefore $edim(CCS(1)) \geq 3$. Hence $edim(CCS(1)) = 3$.

□

Theorem 2. For $n \geq 2$, the edge metric dimension of $CCS(n) = 7^{n-2} \times 16$.

Proof. Let $R_E = \{r_1, r_2, r_3, \dots, r_k\}$ be the set of vertices of type a_1 and a_2 of outermost cubes U_n as shown in Fig. 4.

The cube U_n is the outermost and attached with the chain of cubes through vertex c . The degree of vertex c is 4, and all other vertices are of degree 3. We assume that R_E is an edge metric generator and $k = 7^{n-2} \times 16$ (since there are $7^{n-2} \times 8$ cubes in the outermost layer of $CCS(n)$). The representation of any two distinct arbitrary edges of $CCS(n)$ can be compared in the following ways.

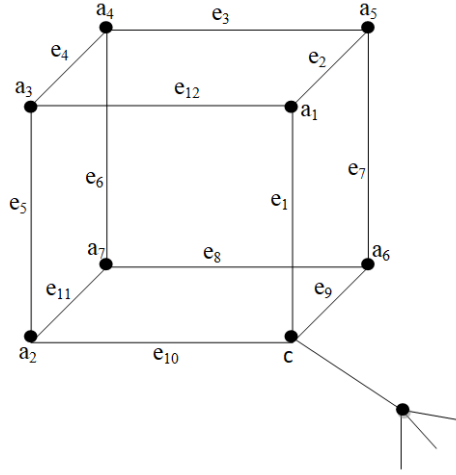

Figure 4: Cube U_n (arbitrary) from the outermost cubes of $CCS(n)$.

(i) When both the arbitrarily selected edges are on U_n of $CCS(n)$ as shown in Fig. 4.

We assume that $r_1 = a_1$ and $r_2 = a_2$, then $R_E = \{a_1, a_2, r_3, r_4, \dots, r_k\}$. The representation of each edge e_i , $1 \leq i \leq 12$ of cube U_n concerning R_E is given as

$$\begin{aligned}
r[e_1|R_E] &= (0, 1, d(c, r_3), d(c, r_4), \dots, d(c, r_k)) \\
r[e_2|R_E] &= (0, 2, d(c, r_3) + 1, d(c, r_4) + 1, \dots, d(c, r_k) + 1) \\
r[e_3|R_E] &= (1, 2, d(c, r_3) + 2, d(c, r_4) + 2, \dots, d(c, r_k) + 2) \\
r[e_4|R_E] &= (1, 1, d(c, r_3) + 2, d(c, r_4) + 2, \dots, d(c, r_k) + 2) \\
r[e_5|R_E] &= (1, 0, d(c, r_3) + 1, d(c, r_4) + 1, \dots, d(c, r_k) + 1) \\
r[e_6|R_E] &= (2, 1, d(c, r_3) + 2, d(c, r_4) + 2, \dots, d(c, r_k) + 2) \\
r[e_7|R_E] &= (1, 2, d(c, r_3) + 1, d(c, r_4) + 1, \dots, d(c, r_k) + 1) \\
r[e_8|R_E] &= (2, 1, d(c, r_3) + 1, d(c, r_4) + 1, \dots, d(c, r_k) + 1) \\
r[e_9|R_E] &= (1, 1, d(c, r_3), d(c, r_4), \dots, d(c, r_k)) \\
r[e_{10}|R_E] &= (1, 0, d(c, r_3), d(c, r_4), \dots, d(c, r_k)) \\
r[e_{11}|R_E] &= (2, 0, d(c, r_3) + 1, d(c, r_4) + 1, \dots, d(c, r_k) + 1) \\
r[e_{12}|R_E] &= (0, 1, d(c, r_3) + 1, d(c, r_4) + 1, \dots, d(c, r_k) + 1)
\end{aligned}$$

We see that all these representations are different.

(ii) When both the arbitrarily selected edges are on the distinct cubes of chain CH_c , one end of which is the cube of the outermost level as shown in Fig. 5.

Let us assume that two selected edges e_L and e_M are on two distinct cubes namely L -cube and M -cube respectively on the chain of cubes. Assume that the chain of cubes CH_c in $CCS(n)$, has one end as its central cube and the other end is the outermost cube which has a pair of distinct arbitrary edge resolving vertices (say r_1 and r_2). Since e_L is one of the edges of L -cube and e_M is edge of M -cube, then it clear that $d(e_L, R_E) < d(e_M, R_E)$. Hence representation of both edges concerning R_E is distinct.

(iii) When both the arbitrarily selected edges are bridge edges on the chain of cubes CH_c , one end of which is the cube of the outermost level as shown in Fig. 5.

Let us assume that two selected edges e_{b_i} and e_{b_j} are on the chain of cubes. Assume that the chain of cubes CH_c in $CCS(n)$, has one end as its central cube and the other end is the outermost cube which has a pair of distinct arbitrary edge resolving vertices (say r_1 and r_2). Then it clear that $d(e_{b_i}, R_E) < d(e_{b_j}, R_E)$. Hence representation of both edges concerning R_E is distinct.

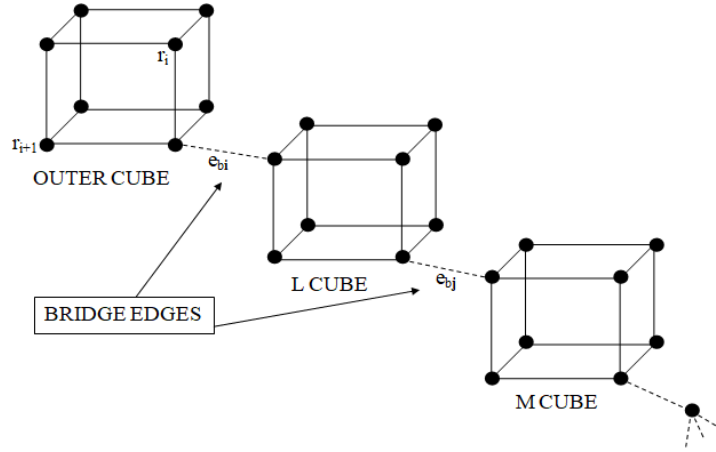

Figure 5: Chain of cubes (CH_c) in $CCS(n)$.

(iv) When both the arbitrarily selected edges are on distinct chains of cubes (say CH_{c_1} and CH_{c_2}) and these two chains are connected to a common cube called branching cube.

Let us assume that the two selected edges e_M and e_N are on two distinct cubes namely M -cube and N -cube respectively. Further, these cubes are on distinct chains of cubes (say CH_{c_1} and CH_{c_2}) connected at branching B cube as shown in Fig. 6.

Assume that the chain of cubes CH_{c_1} and CH_{c_2} in $CCS(n)$, has one end as branching cube and the other end as outermost cubes, which has a pair of distinct arbitrary edge resolving vertices $r_i = r_1, r_{i+1}$ and $r_j = r_3, r_{j+1}$. Also, the length of the shortest path between vertex r_1 and edge e_M on the M cube is greater than the length of the shortest path between vertex r_1 and edge e_N on the N cube. This implies $d(e_N, r_1) \neq d(e_M, r_1)$, and hence $r(e_N, R_E) \neq r(e_M, R_E)$.

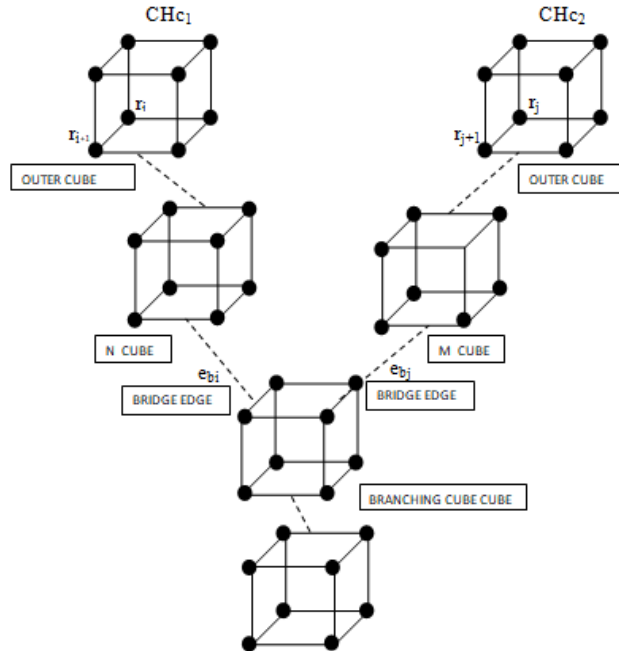

Figure 6: The distinct chains of cubes through branching cube

(v) When both the arbitrarily selected bridge edges are on distinct chains of cubes (say CH_{c_1} and CH_{c_2}) and these two chains are connected to a common cube called branching cube.

Let us assume that the two selected edges e_{b_i} and e_{b_j} are on two distinct chains of cubes namely CH_{c_1} and CH_{c_2} respectively. Further, these distinct chains are connected at branching B cube as shown in Fig. 6.

Assume that the chain of cubes CH_{c_1} and CH_{c_2} in $CCS(n)$, has one end as branching cube and the other end as outermost cubes, which has a pair of distinct arbitrary edge resolving vertices $r_i = r_1, r_{i+1}$ and $r_j = r_3, r_{j+1}$. Also, the length of the shortest path between vertex r_1 and edge e_{b_j} is greater than the length of the shortest path between vertex r_1 and edge e_{b_i} . This implies $d(e_{b_i}, r_1) \neq d(e_{b_j}, r_1)$, and hence $r(e_{b_i}, R_E) \neq r(e_{b_j}, R_E)$.

(vi) When both the arbitrarily selected edges are on the central cube as shown in Fig. 7.

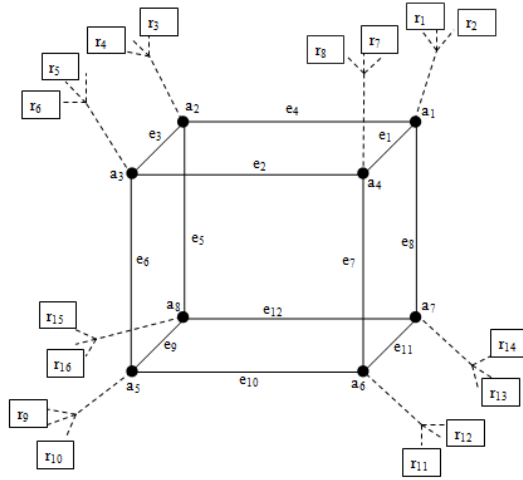

Figure 7: Central Cube of $CCS(n)$ and r_i, r_{i+1} are vertices on the outermost level of cubes.

Assume that the two arbitrary selected edges are on the central cube. We have labelled all 8 vertices as a_1, a_2, \dots, a_8 and edges as $e_i, i = 1, 2, 3, \dots, 12$. Without loss of generality, we assume that vertices $r_{2i-1}, r_{2i}, i = 1, 2, 3, \dots, 8$, are on the outermost layer cubes in $CCS(n)$, and these outermost cubes having vertices r_{2i-1}, r_{2i} are connected to the central cube at vertex $a_i, 1 \leq i \leq 8$, through a chain of cubes. Since each vertex is joined by three edges of the central cube (a_1 is joined by edge e_1, e_4, e_8) so the shortest distance of these edges from vertex r_1 and r_2 is the same but simultaneously edge e_1 is also joined by vertex a_2 but edges e_4 and e_8 are not joined by a_2 . This further implies that the shortest path between edge e_1 and vertex r_3 is not the same as edges e_4 and e_8 , and so on for other edges. Hence the representation is distinct for each edge concerning R_E .

(vii) When both the arbitrarily selected edges are on the middle cube, which is neither the outer cube nor the central cube.

Assume that the middle cube contains two arbitrary selected edges as shown in Fig. 8. We have labelled all 8 vertices as c, a_1, a_2, \dots, a_7 and edges as $e_i, i = 1, 2, 3, \dots, 12$. We can assume that the vertices r_1 and r_2 lie on the cube (say C_j) of the outermost layer of $CCS(n)$ and that C_j is joined to the middle cube C_m at vertex a_1 by a chain of cubes without losing generality. Similarly, we can suppose that r_{2i-1}, r_{2i} lie on the cubes of the outermost layer in $CCS(n)$, and these cubes are connected to middle cube C_m at vertices $a_i, 2 \leq i \leq 7$, through the chain of cubes. As in case (vi), we find that each vertex is joined by three edges of cube C_m . Similar to the above case the representation is distinct for each edge concerning R_E .

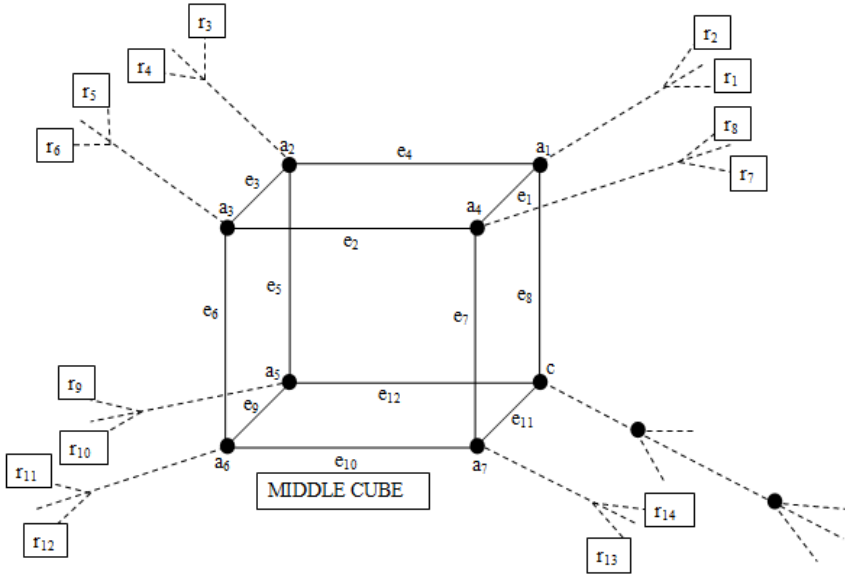

Figure 8: An arbitrary middle cube C_m which is neither the outermost cube nor the central cube of $CCS(n)$.

(viii) When one of the arbitrarily selected edges is on one of the cube, and the other is the bridge edge between cubes.

Clearly, by the symmetry of the structure, the representation is distinct for each edge concerning R_E .

All these cases prove that $R_E = \{r_1, r_2, r_3, \dots, r_k\}$ is resolving set. Hence $\text{edim}(CCS(n)) \leq 7^{n-2} \times 16$.

Next, we claim that $\text{edim}(CCS(n)) \geq 7^{n-2} \times 16$. Let C_n be an arbitrary cube on the outermost layer of $CCS(n)$ as shown in Fig. 9. We have labelled all the vertices of C_n as $a_i, i = 1, 2, 3, \dots, 8$, and edges as $e_i, i = 1, 2, 3, \dots, 12$. The degree of each vertex is 3, except the vertex a_1 , which is attached to the chain through an edge. Let $R_E = \{r_1, r_2, \dots, r_k\}$ be an edge metric generator of $CCS(n)$. In order to complete the proof, we have to show that the edge metric generator R_E has a minimum of two vertices from C_n . To begin, we assume $v \in R_E$ such that $v \notin C_n$, then $r[e_1 | R_E] = (d(a_1, r_1), d(a_1, r_2), d(a_1, r_3), \dots, d(a_1, r_k)) = r[e_{11} | R_E]$ which is a contradiction.

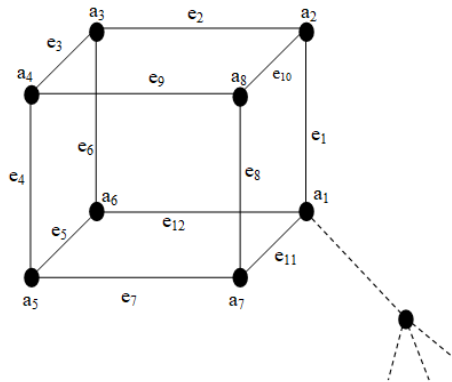

Figure 9: Outermost cube (C_n) of $CCS(n)$.

Secondly, we suppose that only one vertex of R_E belongs to C_n . Without loss of generality, we assume that this common vertex is r_1 .

If $r_1 = a_1$, then
 $d(e_1|R_E) = \{0, d(a_1, r_2), d(a_1, r_3), \dots, d(a_1, r_k)\} = d(e_{11}|R_E)$, a contradiction.

If $r_1 = a_2$, then
 $d(e_2|R_E) = \{0, d(a_1, r_2) + 1, d(a_1, r_3) + 1, \dots, d(a_1, r_k) + 1\} = d(e_{10}|R_E)$, a contradiction.

If $r_1 = a_3$, then
 $d(e_2|R_E) = \{0, d(a_1, r_2) + 1, d(a_1, r_3) + 1, \dots, d(a_1, r_k) + 1\} = d(e_6|R_E)$, a contradiction.

If $r_1 = a_4$, then
 $d(e_3|R_E) = \{0, d(a_1, r_2) + 2, d(a_1, r_3) + 2, \dots, d(a_1, r_k) + 2\} = d(e_9|R_E)$, a contradiction.

If $r_1 = a_5$, then
 $d(e_5|R_E) = \{0, d(a_1, r_2) + 1, d(a_1, r_3) + 1, \dots, d(a_1, r_k) + 1\} = d(e_7|R_E)$, a contradiction.

If $r_1 = a_6$, then
 $d(e_5|R_E) = \{0, d(a_1, r_2) + 1, d(a_1, r_3) + 1, \dots, d(a_1, r_k) + 1\} = d(e_6|R_E)$, a contradiction.

If $r_1 = a_7$, then
 $d(e_7|R_E) = \{0, d(a_1, r_2) + 1, d(a_1, r_3) + 1, \dots, d(a_1, r_k) + 1\} = d(e_8|R_E)$, a contradiction.

If $r_1 = a_8$, then
 $d(e_8|R_E) = \{0, d(a_1, r_2) + 1, d(a_1, r_3) + 1, \dots, d(a_1, r_k) + 1\} = d(e_{10}|R_E)$, a contradiction.

Our claim was backed by the inconsistency in all of the circumstances. As a result, the edge metric generator R_E of $CCS(n)$ has minimum of two vertices from the outermost cube C_n . The cubes in $CCS(n)$ are increased by a number equal to 7 multiplied by the number of cubes in the outermost layer of the preceding level at each step or level, as can be seen from the construction of $CCS(n)$. This implies that $edim(CCS(n)) \geq 7^{n-2} \times 16$. Hence $edim(CCS(n)) = 7^{n-2} \times 16$. \square

4. Conclusion

In this article, the edge metric dimension of $CCS(n)$ has been studied. In particular, we have computed that for $n = 1$, $edim(CCS(n)) = 3$, and for $n \geq 2$, $edim(CCS(n)) = 7^{n-2} \times 16$, which is similar to metric dimension of $CCS(n)$. These results are useful to study the structural properties of the chemical compound $CCS(n)$. In the future, we will extend our approach to find the fault-tolerant metric dimension, and the mixed metric dimension of $CCS(n)$.

5. Declarations

Data availability statement

This article does not qualify for data sharing since no data sets were generated or analysed during this research.

Novelty statement

The edge resolvability of various well-known graphs has recently been computed. For instance, convex polytopes, the web graph, circulant graphs, certain chemical structures, and so on. In chemistry, one of the most important problems is to represent a series of chemical compounds mathematically so that each component has its representation. Graph invariants play an important role to analyze the abstract structures of chemical graphs. But there are still some chemical graphs for which the vertex and edge resolvability has not been found yet, one such compound is crystal cubic carbon structure $CCS(n)$. Therefore, in this article, we compute the edge resolvability of $CCS(n)$,

for $n \geq 1$ and see that $edim(CCS(n)) = dim(CCS(n))$.

Conflict of interest

The authors disclose that they have no competing interests.

References

- [1] A. Q. Baig, M. Imran, W. Khalid, M. Naeem, Molecular description of carbon graphite and crystal cubic carbon structures, *Can. J. Chem.*, 95(6) (2017) 674–686.
- [2] J. Caceres, C. Hernando, M. Mora, I. Pelayo, M. Puertas, C. Seara, D. Wood, On the metric dimension of cartesian products of graphs, *SIAM J. Discrete Math*, 21(2) (2007) 423–441.
- [3] G. Chartrand, L. Eroh, M. A. Johnson, O. R. Oellermann, Resolvability in graphs and metric dimension of a graph, *Discrete Appl. Math*, 105(1-3) (2000) 99–113.
- [4] B. Deng, M. F. Nadeem, M. Azeem, On the Edge Metric Dimension of Different Families of Möbius Networks, *Math. Probl. Eng.*, (2021) 6623208, doi:10.1155/2021/6623208.
- [5] F. Harary, R. A. Melter, On the metric dimension of a graph, *Ars Comb.* 2(1) (1976) 191–195.
- [6] M. Hatala, P. Gemeiner, L. Lorencová et al., Screen-printed conductive carbon layers for dye-sensitized solar cells and electrochemical detection of dopamine. *Chem. Pap.* 75 (2021) 3817–3829.
- [7] M. Imran, M. Naeem, A. Q. Baig, M. K. Siddiqui, M. A. Zahid, W. Gao, Modified eccentric descriptors of crystal cubic carbon, *J. Discret. Math. Sci. Cryptogr.*, 22(7) (2019) 1215–1228.
- [8] A. Kelenc, N. Tratnik, I.G. Yero, Uniquely identifying the edges of a graph: the edge metric dimension, *Discrete Appl. Math*, 251 (2018) 204–220.
- [9] O. V. Kharissova, J. Rodríguez, B. I. Kharisov, Non-standard ROS-generating combination “theraphthal–ascorbic acid” in low-temperature transformations of carbon allotropes. *Chem. Pap.*, 73 (2019) 239–248.
- [10] M. Knor, S. Majstorović, A. T. M. Toshi, R. Škrekovski, I. G. Yero, Graphs with the edge metric dimension smaller than the metric dimension, *Appl. Math. Comput.*, 401 (2021) 126076.
- [11] N. N. Matyushenko, V. E. Strel’Nitskiĭ, V. A. Gusev, 1979. A dense new version of crystalline carbon C_8 , *ZhETF Pisma Redaktsiiu*, 30 (1729) 218.
- [12] A. Pokropivny, S. Volz, ‘ C_8 phase’: Supercubane, tetrahedral, BC-8 or carbon sodalite?, *Phys. Status Solidi B*, 249(9) (2012) 1704–1708.
- [13] J. Sedlar, R. Škrekovski, Bounds on metric dimensions of graphs with edge disjoint cycles, *Appl. Math. Comput.*, 396 (2021) 125908.
- [14] S. Sharma, V. K. Bhat, Fault-tolerant metric dimension of zero-divisor graphs of commutative rings. *AKCE Int. J. Graphs Comb.*, (2021) 1-7, doi:10.1080/09728600.2021.2009746.
- [15] S. K. Sharma, V. K. Bhat, Metric dimension of heptagonal circular ladder, *Discrete Math. Algorithms Appl.*, 13(1) (2021) 20500095.
- [16] S. K. Sharma, V. K. Bhat, H. Raza, S. Sharma, On mixed metric dimension of polycyclic aromatic hydrocarbon networks. *Chem. Pap.*, (2022) 1-14, doi:10.1007/s11696-022-02151-x.
- [17] P. Singh, S. Sharma, S. K. Sharma, V. K. Bhat, Metric dimension and edge metric dimension of windmill graphs, *AIMS Math*, 6(9) (2021) 9138–9153.
- [18] P. J. Slater, Leaves of trees, *Congress. Numer*, 14 (1975) 549–559.
- [19] C. Wei, M. Salman, S. Shahzaib, M. U. Rehman, J. Fang, Classes of Planar Graphs with Constant Edge Metric Dimension, *Complexity*, (2021), doi:10.1155/2021/5599274.
- [20] H. Yang, M. Naeem, A. Q. Baig, H. Shaker, M. K. Siddiqui, Vertex Szeged index of crystal cubic carbon structure, *J. Discret. Math. Sci. Cryptogr*, 22(7) (2019) 1177–1187.

- [21] H. Yang, M. Naeem, M. K. Siddiqui, Molecular properties of carbon crystal cubic structures, *Open Chem.*, 18(1) (2020) 339–346.
- [22] M. A. Zahid, M. Naeem, A. Q. Baig, W. Gao, General fifth M-zagreb indices and fifth M-zagreb polynomials of crystal cubic carbon, *Util. Math.*, 109 (2018) 263–270.
- [23] Y. Zhang, S. Gao, On the edge metric dimension of convex polytopes and its related graphs, *J. Comb. Optim.*, 39(2) (2020) 334–350.
- [24] X. Zhang, M. Naeem, Metric dimension of crystal cubic carbon structure, *J. Math.*, (2021), doi:10.1155/2021/3438611.