

Crude Oil-related Events Extraction and Processing: A Transfer Learning Approach

Meisin Lee^a (mei.lee@monash.edu), Lay-Ki Soon^a (soon.layki@monash.edu),
Eu-Gen Siew^a (siew.eu-gene@monash.edu)

^a Monash University (Malaysia Campus), Jalan Lagoon Selatan, Bandar Sunway,
47500, Selangor, Malaysia

Corresponding Author:

Meisin Lee

Tel: +603-5514 6000

Email: mei.lee@monash.edu

Crude Oil-related Events Extraction and Processing: A Transfer Learning Approach

Meisin Lee^{a,*}, Lay-Ki Soon^a, Eu-Gen Siew^a

^a*Monash University (Malaysia Campus), Jalan Lagoon Selatan, Bandar Sunway, 47500, Selangor, Malaysia*

Abstract

One of the challenges in event extraction via traditional supervised learning paradigm is the need for a sizeable annotated dataset to achieve satisfactory model performance. It is even more challenging when it comes to event extraction in the finance and economics domain, a domain with considerably fewer resources. This paper presents a complete framework for extracting and processing crude oil-related events found in *CrudeOilNews* corpus Lee et al. (2022), addressing the issue of annotation scarcity and class imbalance by leveraging on the effectiveness of transfer learning. Apart from event extraction, we place special emphasis on event properties (Polarity, Modality, and Intensity) classification to determine the factual certainty of each event. We build baseline models first by supervised learning and then exploit Transfer Learning methods to boost event extraction model performance despite the limited amount of annotated data and severe class imbalance. This is done via methods within the transfer learning framework such as *Domain Adaptive Pre-training*, *Multi-task Learning* and *Sequential Transfer Learning*. Based on experiment results, we are able to improve all event extraction sub-task models both in F1 and MCC¹-score as compared to baseline models trained via the standard supervised learning. Accurate and holistic event extraction from crude oil news is

*Corresponding author.

Email addresses: mei.lee@monash.edu (Meisin Lee), soon.layki@monash.edu (Lay-Ki Soon), siew.eu-gene@monash.edu (Eu-Gen Siew)

¹Matthews correlation coefficient

very useful for downstream tasks such as understanding event chains and learning event-event relations, which can be used for other downstream tasks such as commodity price prediction, summarisation, etc. to support a wide range of business decision making.

Keywords: event extraction, transfer learning, commodity news, information extraction, low resource domain

1. Introduction

Event extraction is an important task in Information Extraction. It is the process of gathering knowledge about incidents found in texts, automatically identifying information about what happened, when it happened, and other details. Event extraction has long been a challenging task, addressed mostly with supervised methods² that require massive amounts of annotated data. However, annotated data is hard and expensive to obtain. This is evident that even canonical datasets such as ACE2005 and TAC KBP are moderate in size. This challenge is even more apparent in specialised domains such as finance and economics, where only experts can provide reliable labels Konyushkova et al. (2017). The challenge of annotation scarcity and class imbalance is acknowledged in Chen (2021), to which the authors proposed to use transfer learning by using a number of corpora within the BioMedical domain to increase the coverage of event detection (event trigger detection) on their target corpus of the same domain.

In this work, we investigate the task of event extraction in *CrudeOilNews* corpus, a dataset released by Lee et al. (2022) where commodity news articles are annotated for the task of event extraction. More information about the *CrudeOilNews* corpus is laid out in Section 1.1. Events found in commodity news articles are mainly Geo-political, Macro-economics, supply and demand in

²Apart from supervised methods, there is a smaller number of work proposed the use some form of Weak Supervision, Distant Supervision, etc (see Xiang & Wang (2019) for a survey of existing event extraction methods).

nature. Transfer Learning has been proven to be effective for a wide range of applications, especially for low-resourced domains Meftah et al. (2021). Inspired by this, we explore the usage of transfer learning to produce event extraction and event property classification models with the best possible accuracy despite of the limited training size. Transfer learning is a set of methods that leverages resources from other domains or resources intended from other tasks to train a model with better generalization properties. Resources from other domains are known as *source domain*, while resources intended for a different task is known as *source task*. Transfer learning aims at performing a task on a target dataset using features learned from a source dataset Pan & Yang (2010). In this work, we experimented with various approaches within the Transfer Learning paradigm³, namely *Domain Adaptive Pre-training*, *Sequential Transfer Learning* and *Multi-task Learning*. Definition of the various types of Transfer Learning are laid out in Section 1.3.

1.1. Dataset

The dataset used here is the *CrudeOilNews* corpus introduced in Lee et al. (2022). The dataset size is moderate where it contains, in total, **425 documents**, **approx. 11k events**, about **approx. 23k arguments**, and each event is classified according to Polarity, Modality, and Intensity properties. There are 21 entity types⁴, 18 event types. Broadly, the events can be grouped into the following main categories:

- **geo-political:** Geo-political tension, civil unrest, embargo/sanctions, trade tensions, and other forms of geo-political crisis.
- **macro-economic:** US employment data, economic/gross domestic product (GDP) growth, economic outlook, growth forecast, supply and demand

³The definition of Transfer Learning is aligned to the taxonomy of Transfer Learning described in Ruder (2019).

⁴for simplicity and convenience, **values** and **temporal expressions** are also considered as entity mentions

- **Supply-Demand related:** oversupply
- **price movement:** price increase, price decrease, price forecast.

As for event arguments, there are 21 argument types; each event type is associated with a set of argument roles. For more details, such as entity mention examples and description of event types, refer to Appendix A.

1.2. Definitions

Before we dive into the technical details of the proposed solution, this section is dedicated to laying out the terminologies and task descriptions.

Terminologies:

1. An **entity mention** is an explicit mention of an entity in a text that has an entity type.
2. An **event trigger** is the main word(s) that most clearly expresses the occurrence of an event, usually a word or a multiword phrase. It can come in the form of verb, noun, adjective, or adverb).
3. An **event argument** is an argument filler that plays a certain role in an event.
4. **Polarity**, which is also known as negation in Morante & Blanco (2012), denotes whether an event actually happened or was negated, not to be confused with the polarity in sentiment analysis. Its value can be POSITIVE or NEGATIVE.
5. **Modality**, also known as hedge in Farkas et al. (2010), denotes whether an event actually happened or will happen in the future, or whether it is a generic event. Its value can be ASSERTED or OTHER.
6. **Intensity** denotes if an event further intensified and lessen. Its value can be INTENSIFIED, NEUTRAL, and EASED.

According to Lee et al. (2022), the definition of Event Polarity and Modality in *CrudeOilNews* corpus are aligned with *ACE2005*, while Event Intensity is a newly defined property specially crafted for events found in commodity news.

World oil prices are set to fall further , extending a months-long rout as Saudi Arabia is unlikely to make deep enough production cuts to erase a growing surplus of supply.

Figure 1: This is an example taken from *CrudeOilNews* corpus; event trigger words are underlined.

We propose a solution for sentence-level Event Extraction, which is made up of a few sub-tasks. These tasks⁵ are described below:

Tasks.

1. Entity Mention Detection (**EMD**): a task to detect entity mentions (named or nominal) and assign each token an entity type or NONE for tokens that are not an entity mention. See Table 1 top section for EMD task on the example shown in Figure 1.
2. Event Extraction :
 - (a) Event Detection (**ED**): similar to EMD, it is a task to detect event trigger word(s) and assign it to an event type or NONE for tokens that are not an event trigger. See Table 1 bottom section for ED task on the example in Figure 1.
 - (b) Argument Role Prediction (**ARP**): a task aims to assign an argument role label or NONE to a candidate entity mention. If the candidate entity is not linked to the event. See Table 2 for ARP task on the example shown in Figure 1.
3. Event Properties Classification: Classifying each event's in terms of their Polarity, Modality, and Intensity classes. See Table 3 for the classification of each event against Polarity, Modality and Intensity.

Based on the example in Figure 1 and information extracted via regular event extraction, which is made up subtasks (1) EMD and ED (Table 1), and (2)

⁵We follow the same naming convention in Nguyen & Nguyen (2019)

| Task | Text | Entity Type |
|------------|-----------------|--------------------------|
| EMD | World | Location |
| | oil | COMMODITY |
| | prices | FINANCIAL ATTRIBUTE |
| | months-long | DATE |
| | Saudi Arabia | COUNTRY |
| | production | FINANCIAL ATTRIBUTE |
| | supply | FINANCIAL ATTRIBUTE |
| Task | Trigger Word(s) | Event Type |
| ED | fall | MOVEMENT_DOWN_LOSS |
| | rout | SLOW-WEAK |
| | cuts | CAUSE MOVEMENT_DOWN_LOSS |
| | surplus | OVERSUPPLY |

Table 1: Entity Mention Detection (EMD) and Event Detection (ED) for the example sentence shown in Figure 1.

| Event | Text | Argument Role |
|----------------|--------------|---------------|
| <u>fall</u> | oil | ITEM |
| | prices | ATTRIBUTE |
| <u>rout</u> | months-long | DURATION |
| <u>cuts</u> | Saudi Arabia | SUPPLIER |
| | production | ATTRIBUTE |
| <u>surplus</u> | supply | ATTRIBUTE |

Table 2: Argument Role Prediction (ARP) for the example sentence shown in Figure 1.

APR (Table 2), we argue that the extracted information is incomplete without taking into consideration its events’ properties shown in Table 3,

1.3. Transfer Learning

Here we provide the formal definition of Transfer Learning based on Weiss et al. (2016); Pan & Yang (2010); Alyafeai et al. (2020). Given a source-domain task tuple (D_s, T_s) and different target domain-task pair (D_t, T_t) , we

| Event | Polarity | Modality | Intensity |
|------------------------|-----------------|-----------------|------------------|
| prices <u>fall</u> | POSITIVE | OTHER | NEUTRAL |
| <u>rout</u> | POSITIVE | ASSERTED | INTENSIFIED |
| production <u>cuts</u> | NEGATIVE | OTHER | NEUTRAL |
| supply <u>surplus</u> | POSITIVE | OTHER | EASED |

Table 3: Event properties (Polarity, Modality and Intensity) for each of the events from the example sentence in Figure 1.

define transfer learning as the process of using the source domain and task in the learning process of the target domain task.

The definition of transfer learning used here is aligned to Ruder (2019), and the taxonomy diagram used in Ruder (2019) is shown in Figure 2. According to this taxonomy, the main branches of Transfer Learning are:

1. **Transductive transfer Learning:** It is the setting where source and target tasks are the same; we don’t have labeled data at all or we have very few labeled data in the target domain, but sufficient labeled data in the source domain.
2. **Inductive transfer learning:** It is the setting where the source task and the target task are different; labeled data is only available in the target domain.

Based on the above definition and given that we intend to fully utilize the labels in our dataset (target domain) to train (or fine-tune) the model, we will only focus on **Inductive transfer learning** and its sub-types, namely:

1. **Sequential Transfer Learning (STL):** the process of learning multiple tasks (T_1, T_2, \dots, T_n) . At each step t , we learn a specific task T_t . There are two types of STL, each illustrated by an example below:
 - (a) Cross-domain STL: A model is first trained on task T using a source dataset D_s and is then transferred to train on the target dataset D_t on the same task $(T_s = T_t)$. In Gui et al. (2018b), authors used cross-domain STL to transfer a POS-tagging model trained using News,

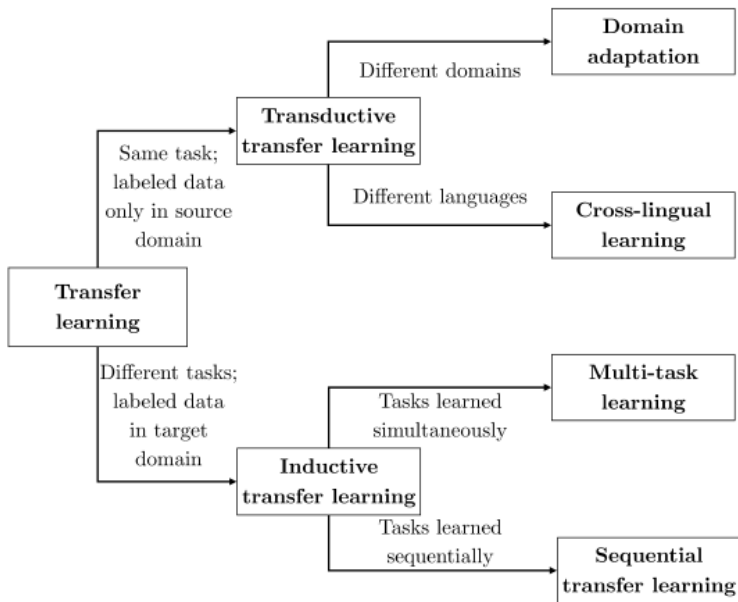

Figure 2: A taxonomy of Transfer Learning for NLP (image taken from Ruder (2019))

- a resource-rich domain, to train on the same task using Tweets, a lower resource domain;
- (b) **Cross-task STL**: A model is first trained on task T_s and is then transferred to train on a different but related task T_t in the same domain. This is seen in Meftah & Semmar (2018), where the authors first train a Named Entity Recognition (NER) model and then transfer the model to train on POS-tagging task in the same dataset Meftah & Semmar (2018).
2. **Multi-task Learning (MTL)**: the process of learning multiple tasks (T_1, T_2, \dots, T_n) at the same time. All tasks are learned in a parallel fashion. For example, both chunking and POS-tagging are trained concurrently in Søgaard & Goldberg (2016); Ruder et al. (2017), as chunking has been shown to benefit from being jointly trained with low-level tasks such as POS tagging.

Negative Transfer There are cases when transfer learning can lead to a drop in performance instead of improving it. Negative transfer refers to scenarios where the transfer of knowledge from the source to the target does not lead to improvements, but rather causes a drop in the overall performance of the target task that might be lower than that with a solely supervised training on in-target data Torrey & Shavlik (2010). There can be various reasons or various situation that resulted in negative transfer, such as:

1. in MTL or STL task-centered transfer learning when the source task is not sufficiently related to the target task or if the transfer method could not leverage the relationship between the source and target tasks very well Rosenstein et al. (2005);
2. in domain adaptation when the source domain is dissimilar or less related to target domain Meftah et al. (2021); Blitzer et al. (2007); Ruder (2019); Gui et al. (2018a)

In this work, we look into the training of event extraction and event classification on crude oil-related events on *CrudeOilNews* corpus. The contributions of this work is summarized as follows:

1. Proposed an end-to-end Event Extraction solution placing equal emphasis on accurate event properties classification apart from event extraction;
2. Utilize Transfer Learning to improve final model performance through improving embeddings or model representations to overcome issues of labeled data scarcity and class imbalance.

The rest of the article is organized as follows: In Section 2, we lay out related work according to each sub-task; in Section 3, we present our proposed framework for a complete event extraction for *CrudeOilNews* corpus. We dive deeper into the respective sub-tasks in subsequent sections: Section 4 covers event extraction while Section 5 focuses on event properties classification. Lastly, we present the conclusion in Section 6.

2. Related Work

This section is structured such that related work will be discussed based on the specific area of interest, giving a targeted analysis of each area or sub-task within the overall event extraction task.

2.1. Event Extraction

The question of how to improve the extraction accuracy from a somewhat limited set of labeled gold data has become an important one. Recently many have started exploring transfer learning to improve event extraction through various types of Transfer Learning described below:

Multi-task Learning (MTL). Multi-task Learning is also known as *joint learning* or *joint training* in most event extraction literature. Here we list the past work according to the different combinations of sub-tasks:

1. Partial Multi-task learning: jointly training ED + APR. This approach is very common in event extraction literature and is found in Lee et al. (2021); Liu et al. (2018); Li et al. (2013); Nguyen et al. (2016); Sha et al. (2018). Although the approach of jointly training ED and APR is the same, all of them used different deep learning architecture. Lee et al. (2021) used Graphical Convolution Network (GCN) + Pruned Dependency Parse Tree, Liu et al. (2018) used GCN with Attention Mechanism, Nguyen et al. (2016) uses Recurrent Neural Network (RNN), Sha et al. (2018) uses Dependency-Bridge RNN and Tensor-Based Argument Interaction.
2. Full Multi-task learning: Joint modeling of all three sub-tasks : EMD, ED and ARP extraction. This approach was in reported in Li et al. (2014); Yang & Mitchell (2016); Judea & Strube (2016); Nguyen & Nguyen (2019); Zhang et al. (2019). The authors in Yang & Mitchell (2016) consider structural dependencies among sub-tasks by adopting a two-stage reranking procedure, first selecting the k-best output of event triggers and entity mentions, then performing joint inference via reranking. Nguyen

& Nguyen (2019) build a multi-task model that exploits mutual benefits among the three tasks by sharing common encoding layers given an input sentence. In this setting, output structures of entity mentions, event triggers, and argument semantic roles are decoded separately. Zhang et al. (2019), on the other hand, used a neural transition-based framework to predict complex joint structures incrementally in a state-transition process.

3. Hierarchical Multi-task learning: training sub-tasks according to a hierarchical fashion. The idea is to utilize a set of low-level tasks learned at the bottom layers of the model to create a set of shared semantic representations that will progressively have a more complex representation from the more complex tasks at the higher-level. The authors in Sanh et al. (2019) showed that these low and higher level tasks benefit trained in a hierarchical fashion benefit each other. The authors trained Named Entity Recognition (NER), EMD, Entity Coreference Resolution, and Relation Extraction via a hierarchical fashion. Similarly, authors in Wadden et al. (2019) also aims to train the same set of sub-tasks (but treating entity co-reference as an auxiliary task) using span representation from BERT (and Graph propagation).

Note: Multi-task solutions involving auxiliary tasks other than event extraction, for example, the combination of *ED + Entity Relation Extraction* is excluded here.

Sequential Transfer Learning (STL). According to Ruder (2019), STL is a type of transfer learning. In this approach, We train a model on a task or a dataset, and then ‘transfer’ the model to another task or dataset. This means that, as opposed to MTL, STL models are not optimized jointly, but each task is learned sequentially. Chen (2021) is an example of cross-domain STL; the authors used multiple source datasets to help achieve a wider coverage of events in the target dataset using adversarial network-based transfer learning. The authors capitalized on four other corpora with varying degrees of relevance to their target

dataset (all within the BioMedical domain) to extract and transfer common features from the related source corpora effectively to boost the performance of event trigger detection in the target dataset.

Other forms of Transfer Learning. In Huang et al. (2018), the authors used zero-shot transfer learning to allow their event extraction model to generalize to new unseen event types (events without annotation). They model event extraction as a generic grounding problem and designed a transferable architecture of structural and compositional neural network, that leverages existing event schemas and human annotations for a small set of seen types, and transfers the knowledge from the existing types to the extraction of unseen types. In Lyu et al. (2021), on the other hand, the authors formulate *zero-shot* event extraction as a set of Textual Entailment (TE) and / or Question Answering (QA) queries, exploiting pretrained (TE/QA) models for direct transfer (transfer learning) to do the new target task of event extraction.

2.2. Event Properties Classification

Even though the ACE2005 dataset is annotated with not just event details but also properties such as *Polarity, Tense, Genericity, and Modality*, previous work within the ACE2005 and TAC-KBP stream focused almost exclusively on event detection and event extraction and under-utilizing the annotation on event properties. Even in survey papers such as Xiang & Wang (2019) and Hogenboom et al. (2016), the focus is solely on event extraction, omitting event properties classification and other event-related task. Instead, event properties related tasks are established separately from event extraction through several shared tasks that are not necessarily event extraction related. These tasks come in various variations and different focuses, they are:

1. Event Realis classification Mitamura et al. (2015) in TAC KBP dataset. There are three types of Ralis values: ACTUAL, GENERIC, and OTHER. This is equivalent to our Modality property;

2. CoNLL-2010 shared task: Hedge detection and scope resolution. The task is to detect hedges and their scope in natural language text. A detailed task description is found in Farkas et al. (2010). This is equivalent to our Modality property;
3. SEM 2012 Shared Task: Negation detection and scope resolution. The task is to detect negation and resolve its scope and focus. A detailed description of the task is found in Morante & Blanco (2012). This is equivalent to our Polarity property;
4. Modal sense classification Marasović & Frank (2016). This is similar to Uncertainty hedge / Modality cue word detection;
5. Event Factuality Prediction (EFP) Saurí & Pustejovsky (2009). This is a combination of Negation and Speculation detection but instead of classification, EFP is a regression task to predict a score between [+3, -3].

Even though none of the corpora above are related to Economic / Finance domain, their tasks are similar to our event property classification. Therefore they are potential resources for consideration for using them as resources as source datasets in cross-domain STL.

3. Proposed Framework

We present a framework for end-to-end event processing that includes both event extraction and as well as event properties classification. First, we build baseline models via supervised learning for each sub-task using only the *CrudeOil-News* dataset. Then we explore various transfer learning techniques and leverage on available resources (source task or source dataset) to train target models with better performance. We demonstrate, through experiments, how much improvement (if any) these new models show compared to the baseline models.

By referring to Figure 3, the proposed framework is described in detail in the following sections:

1. Domain Adaptive Pre-training on BERT to produce ComBERT for contextualized word embedding in Section 3.1

2. Data pre-processing in Section 3.2;
3. Event Extraction (EE) and its sub-task: (1) Entity Mention (EMD) and Event Detection (ED) and (2) Argument Role Prediction (ARP) in Section 4. Here, we explore the usage of cross-domain sequential transfer learning and inductive transfer learning.
4. Event properties classification in Section 5. We explore cross-task sequential learning.

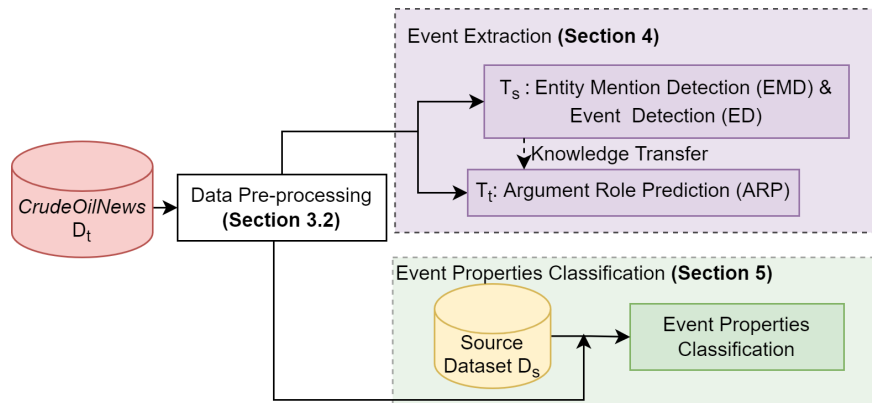

Figure 3: The framework is made up of different components, each corresponding to the sub-tasks in EE. Event extraction (EMD, ED and ARP) is covered in Section 4 while event properties classification (Polarity, Modality and Intensity) is covered in Section 5.

3.1. ComBERT: Domain Adaptive Pre-training

As for tokens, the model takes an input sentence as a sequence of word tokens encoded through ComBERT, as introduced in Lee et al. (2021). As shown in Figure 4, ComBERT is produced from BERT-based domain adaptive pre-training on a large collection of commodity news on the task of masked language modeling. It was trained on a collection of commodity news extracted from www.investing.com, the same source as the *CrudeOilNews* corpus. The idea is to adapt BERT, which was trained on English Wikipedia and Brown corpus Devlin et al. (2019) to the finance and economics domains via Domain

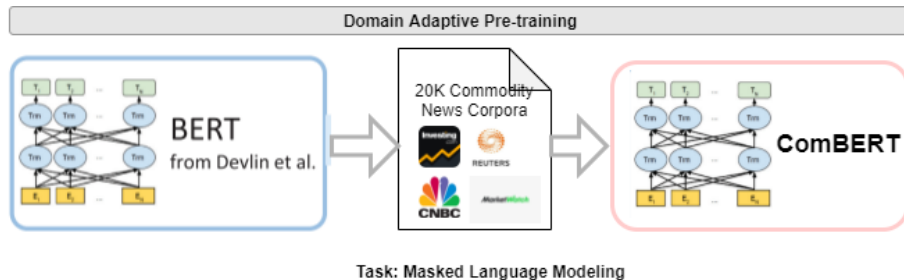

Figure 4: Domain Adaptive Pre-training: Using BERT as baseline, we have further pre-trained BERT on a commodity news corpus, adapting the model to the finance and economic news domain.

Adaptive Pre-training. In Lee et al. (2021), it is shown that ComBERT produced better event extraction results than BERT and other generic language models. This is consistent with language models produced through domain adaptive pre-training on in-domain corpus such as SciBERT Beltagy et al. (2019) and BioBERT Lee et al. (2020). All event extraction tasks described later use ComBERT embeddings and models are trained via fine-tuning from ComBERT.

3.2. Data Preprocessing

The annotation files made public in Lee et al. (2022) were first converted from Brat Annotation standoff format (*.ann* files) along with their corresponding news articles (*.txt* files) to *json* format. Each sentence in the dataset was parsed using Stanford CoreNLP toolkit Manning et al. (2014), including sentence splitting, tokenization, POS-tagging (lexical information), NER-tagging, and dependency parsing to generate dependency parse trees (syntactic information). For all the sub-tasks, we adopt the “multi-channel” channel strategy where apart from using word embeddings from ComBERT, we include, as input, additional information on each token, ie. their POS tag, NER tag and dependency parse tree tags.

Input. Let $W = w_1, w_2, \dots, w_n$ be a sentence of length n where w_i is the i -th token:

1. The word embedding vector of w_i : this is the feature representation from a word embedding of ComBERT. It is made up of WordPiece tokenization Wu et al. (2016) with [CLS] and [SEP]⁶ are placed at the start and end of the sentence.
2. The Part-of-Speech-tagging (POS-tagging) label embedding vector of w_i : This is generated by looking up the POS-tagging label embedding.
3. Dependency tags: The same "Multi-channel" approach is used where the tokens' Universal Dependency dependency tags embedding are used. Examples of tags are *nmod*, *nsubj*, *dobj*, *neg*, etc. This is based on the fact that entity mentions do not influence the Polarity and Modality of an event. On the other hand, modifier words and modal auxiliary such as **not**, which has the dependency tag *neg*, are key to determining the Modality / Polarity / Intensity of an event. Dependency tags provide additional syntactic information, which is helpful in the classification task.

3.3. Train-Test split

Due to the limited size of *CrudeOilNews* corpus, we run the experiments by using 5-fold cross-validation. Out of the 5-folds, one fold is for testing while the remaining four folds are for training (80% for training and 20% for testing).

3.4. Measurement for dataset with class imbalance

F1-Score. F1-score reported here is macro-average F1-score averaged across k experiments. We compute the F1 score for each fold (iteration); then, we compute the average F1 score from these individual F1 scores.

$$F1_{avg} = \frac{1}{k} \sum_{i=1}^k F1_i \quad (1)$$

⁶[CLS], [SEP], [MASK] are special tokens of BERT. For experiments involving RoBERTa, Byte-Pair Encoding (BPE) tokenization and its special tokens are used.

MCC. In Xie et al. (2013), apart from the familiar F1-measurement the authors used an additional evaluation metric known as the Matthew Correlation Coefficient (MCC) to avoid bias due to the skewness of data. It takes into account true and false positives and negatives and is generally regarded as a balanced measure, which can be used even if the classes are of very different sizes. MCC is a single summary value that incorporates all four cells of a 2×2 confusion matrix⁷.

The equation for Binary Classification:

$$MCC = \frac{TP \times TN - FP \times FN}{\sqrt{(TP + FP)(TP + FN)(TN + FP)(TN + FN)}} \quad (2)$$

and for Multi-class Classification:

$$MCC = \frac{c \times s - \sum_k^K p_k \times t_k}{\sqrt{(s^2 - \sum_k^K p_k^2) \times (s^2 - \sum_k^K t_k^2)}} \quad (3)$$

with the following intermediate variables:

- $t_k = \sum_i^K C_{ik}$ is the number of times class k truly occurred,
- $p_k = \sum_i^K C_{ki}$ is the number of times class k was predicted,
- $c = \sum_k^K C_{kk}$ is the total number of samples correctly predicted,
- $s = \sum_i^K \sum_j^K C_{ij}$ is the total number of samples,
- TP is True Positive, FP is False Positive, TN is True Negative and FN is False Negative.

4. Event Extraction

In this section, we first build baseline models for all event extraction subtasks in Section 4.1. Then we investigate the extent of how transfer learning improves the performance of Event Extraction models from our baseline models. First, we look at cross-domain STL in Section 4.2, and then Inductive Transfer Learning can be used among the sub-tasks in Section 4.3.

⁷For more information on Matthews Correlation Coefficient (MCC), visit

4.1. Baseline Model

First, we start with our baseline model, where we train each sub-task individually. The model architecture of each sub-task is described below:

4.1.1. Model Architecture

Entity Mention Detection (EMD) & Event Trigger Detection (ED).

We formalize both Entity Mention Detection Model (EMD) and Event Trigger Detection (ED) tasks as multi-class token classification where a token is classified as being at the beginning, inside, or outside an entity mention/event trigger (BIO notation). Similar to the approach used in Nguyen et al. (2016), we employ BIO annotation schema to assign entity type labels to each token in the sentences. For the model architecture, we use Huggingface’s `BERTForTokenClassification` with ComBERT embedding to fine-tune on this task. Both EMD and ED are trained separately on minimizing the cross-entropy loss function.

Pipeline versus Golden Entity Mention: A large portion of prior work on Event Extraction has taken a simplified approach that only focused on ED and ARP, ignoring the training of EMD Li et al. (2013); Chen et al. (2015); Nguyen et al. (2016); Lee et al. (2021); Liu et al. (2018). Experiments for ED and ERP are ran based on golden annotation for entity mentions as input. Here in this work, we aim to have a more realistic approach where we start with the EMD sub-task and train other sub-tasks based on the entity mentions predicted by the EMD model. We explore various task setups, i.e. various combinations of single task, multi-task joint training, and sequential transfer learning to minimize the issue of error propagation inherent in the pipeline approach. Details of the various task setups are covered in Section 4.3.

Argument Role Prediction (ARP). We use the solution proposed by Lee et al. (2021), where each sentence’s syntactic information (the dependency parse tree) is used to assist with the classification of event argument roles even though they are identical in terms of entity type, which also includes the abundant numerical values that play different event roles. Specifically, the proposed solution

uses the pruned dependency parse tree along with Graphical Convolution Network (GCN) as the architecture.

The architecture for the task of Argument Role Prediction (ARP) is similar to that of Lee et al. (2021), which uses Graph Convolutional Network (GCN) with pruned contextual parse tree. Here we explain what pruned contextual parse tree is and how to encode this pruned tree to be used as input in the ARP training. As part of data pre-processing, we use Stanford CoreNLP to generate a dependency parse tree for each sentence. We pruned the dependency tree to obtain a sub-tree between each candidate trigger with each candidate entity within a sentence. To further provide more contextual information, the dependency parse tree is pruned based on k distance away. Figure 5 shows the comparison between a pruned tree of the shortest path of the candidate trigger-entity pair and a pruned tree of the same pair but pruned to include additional words k distance away. This task is trained on minimizing the cross-entropy loss.

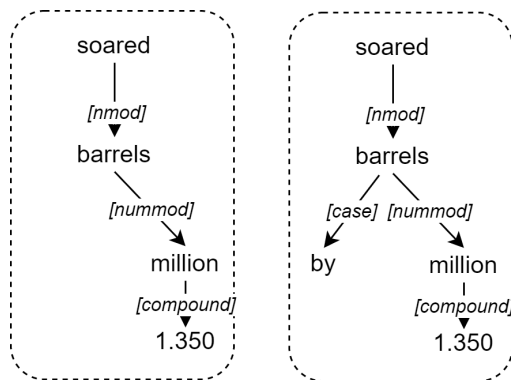

Figure 5: Left: pruned dependency parse with the shortest path between candidate trigger-entity. Right: pruned dependency parse tree with $k = 1$ distance with additional contextual information for the classification of argument roles.

This task is trained to minimize cross-entropy loss. For technical details of the implementation of Graph Convolutional Network (GCN) over pruned contextual parse tree, see Lee et al. (2021).

4.1.2. Experiments

The result of the baseline solution is shown in Table 4 (see first row), with results for individual sub-tasks under their respective header.

4.2. Cross-domain Sequential Transfer Learning

Inspired by the works of Meftah & Semmar (2018) of using cross-domain STL in transferring model trained on POS-tagging task from Newswire domain (source domain) to Twitter text (target domain), here we investigate if we can utilize available source datasets on event extraction to improve performance of the same task in our target dataset further, *CrudeOilNews*. There are two event extraction datasets annotated according to the ACE/ERE standards: (1) benchmark event extraction dataset ACE2005 in the generic domain, and (2) SENTiVENT Jacobs & Hoste (2021) for company-specific events in the finance and economics domain. However, unlike Chen (2021), the source datasets that they used are basically from the same domain, i.e., BioMedical Domain. In our case, we do not have any other event extraction corpus from the same domain as *CrudeOilNews*. The only two candidate corpus identified above are rather different from our target dataset; analysis for each one is listed down below:

ACE2005. is a general domain corpus; out of its 33 sub-event types, almost none overlap with the events defined in *CrudeOilNews* corpus. Even though 2 of the events (*Conflict - Attack*, *Conflict - Demonstrate*) may seem the same as *Civil-unrest*, however upon closer scrutiny, the types of conflict here are rather different: ACE2005 ones are at a personal level, such as a person attacking another person, while in *CrudeOilNews* the conflicts are geo-political, such as social unrest, large-scale demonstration.

SENTiVENT. is a corpus made up of business news and its event types, mainly company-related or company-level events. Among the event types, there is a ‘placeholder’ event type called ‘Macroeconomic’, a broad category that captures all non-company specific events such as market trends, market-share, competition, regulation issues, etc. This ‘Macroeconomic’ event type is the only

event type that overlaps with *CrudeOilNews* corpus, unfortunately, while they lump non-company events into one category, *CrudeOilNews* corpus focuses on Macro-economic and Geo-political events in a finer-detail. Furthermore, *SENTiVENT* corpus is annotated with discontinuous, multiword triggers, e.g., “upgraded ... to buy”, “cut back ... expenses”, “EPS decline”). This is distinctly different from the way triggers are annotated in *ACE2005* and *CrudeOilNews* where triggers are single-word or continuous multiwords. The baseline model developed for event detection in *CrudeOilNews* cannot be readily applied to *SENTiVENT* without any modification.

Based on the fact that there is minimal overlap of event types between the candidate corpus above and our target dataset, we conclude that we are not able to utilize these two candidate corpora for cross-domain STL. This observation is supported by the results in Chen (2021), where two out of four of the source dataset has a very low proportion of trigger overlap that produced worse performance in the target dataset. This is the result of Negative Transfer.

4.3. Inductive Transfer Learning

As shown in the section above, we are not able to utilize any available source datasets to boost task model performance via cross-domain STL. Instead, here we explore Inductive Transfer Learning, where we experimented with multi-task learning (MTL) and sequential transfer learning (STL) and the combination of the two among event extraction sub-tasks within our own dataset to obtain the best possible model performance. In the experiment section, we investigate **Single Task (baseline) vs Multi-task Learning (MTL) vs Sequential transfer Learning (STL) vs a combination of MTL and STL**.

As observed by authors in Sanh et al. (2019), hierarchical multi-task transfer learning in a neural network typically allows the different tasks involved to benefit from each other via sharing the learned representations. STL consists of two stages: a pre-training phase in which general representations are learned on a *source* task or domain, followed by an adaptation phase during which the learned knowledge is applied to a target task or domain. Figure 6 shows the

‘model transfer’ from the *source task* - EMD + ED (top box) to the *target task* - ARP (top box).

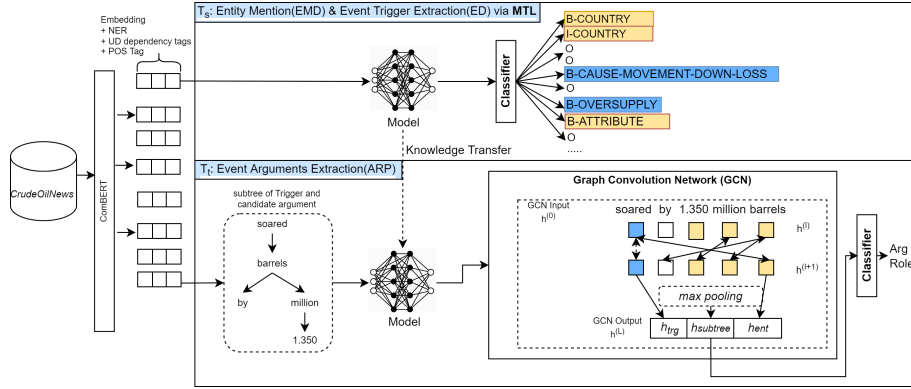

Figure 6: The combination of MTL and STL: First, the model is jointly trained on Entity Mention (EMD) and Trigger Extraction (ED) tasks via MTL and then the model is transferred sequentially to train on the task of Entity Arguments Extraction (ARP).

4.4. Experiments and Analysis

We carried out five types of experiments with different combinations of task setups to determine the best transfer learning configuration with maximum benefits in terms of sharing learned representations of source tasks and target tasks. These five different task setups are:

1. Single Task Learning (Baseline): this is also known as the pipeline approach where the sub-tasks are trained independently one after another, each model is trained from scratch (no transfer learning): EMD, ED, ARP.
2. Full Multi-task training: For the experiment, we use the approach in Zhang et al. (2019), where all sub-tasks are trained jointly using neural transition-based framework, predicting joint output structure as a single task.

3. Full Sequential Training: in this approach, we start training for the EMD task and upon completion, transfer the model to train on ED and lastly on ARP: EMD \rightarrow ED \rightarrow ARP.
4. Combination of MTL and STL:
 - (a) Combination #1: EMD \rightarrow ED + ARP. the approach of jointly training ED + ARP is very common in event extraction literature. This setup is used in Lee et al. (2021), and many others see Section 2.1. The difference between Lee et al. (2021) and this work is that in Lee et al. (2021), they jointly trained ED + ARP together using golden entity mentions, while in this work we use the more realistic setting where the input to the ED + ARP task is based on entities predicted from the earlier EMD + ED model (EMD \rightarrow ED + ARP).

$$joint_loss = loss_EMD + \beta(loss_ED) \quad (4)$$

. In the experiment, we use $\beta=2$ to give a higher weightage to the loss of the ED task.

- (b) Combination #2: EMD + ED \rightarrow ARP as shown in Figure 6. The resulting model from training EMD + ED via MTL (in the upper box of Figure 6) is then transferred to train for ARP (lower box in the figure). EMD + ED acts as the source task T_s in the context of cross-task STL to benefit the ARP task, the target task T_t . The joint loss for EMD + ED is as follows:

$$joint_loss = loss_EMD + loss_ED \quad (5)$$

The results of these experiments are shown in Table 4. The detailed breakdown by entity mention type and event type are reported in Table C.10 while results breakdown by event argument roles are reported in Table C.11, both in Appendix C.

⁷The results presented here is not a like-for-like comparison to the results presented in Lee et al. (2021). This is because in the paper golden entity mention was used as input to

| Task setup | EMD | | | ED | | | ARP | |
|--|-------|-------|-------|-------|-------|-------|-------|-------|
| | P | R | F1 | P | R | F1 | F1 | MCC |
| 1. Individual sub-task training (Baseline) | 0.903 | 0.912 | 0.907 | 0.915 | 0.899 | 0.907 | 0.802 | 0.694 |

| Task setup | EMD + ED + ARP | | | | | | | |
|---|----------------|-------|-------|-------|-------|-------|-------|-------|
| | P | R | F1 | P | R | F1 | F1 | MCC |
| 2. Full Multi-task Training Zhang et al. (2019) | 0.879 | 0.891 | 0.880 | 0.901 | 0.905 | 0.904 | 0.854 | 0.710 |

| Task setup | EMD → ED → ARP | | | | | | | |
|----------------------------------|----------------|-------|-------|-------|-------|-------|-------|-------|
| | P | R | F1 | P | R | F1 | F1 | MCC |
| 3. Full Sequential Task Training | 0.879 | 0.891 | 0.880 | 0.901 | 0.905 | 0.904 | 0.854 | 0.710 |

| Task setup | EMD → (ED + ARP) | | | | | | | |
|--|------------------|-------|-------|-------|-------|-------|-------|-------|
| | P | R | F1 | P | R | F1 | F1 | MCC |
| 4. Combination #1: EMD → ED+ARP Lee et al. (2021) ⁸ | 0.903 | 0.912 | 0.907 | 0.905 | 0.890 | 0.902 | 0.833 | 0.723 |

| Task setup | (EMD + ED) → ARP | | | | | | | |
|-----------------------------------|------------------|--------------|--------------|----|----|----|--------------|--------------|
| | P | R | F1 | P | R | F1 | F1 | MCC |
| 5. Combination #2: EMD + ED → ARP | 0.926 | 0.937 | 0.931 | xx | xx | xx | 0.888 | 0.797 |

Table 4: Experiments with various different task-setups for Event Extraction to investigate **Single Task Learning vs Multi-task Learning vs Sequential transfer Learning**. All setups use the list of entities extracted from the EMD task and not based on Golden annotation.

the joint-training of ED+ARP, while in this work, the output for EMD is used as input to joint-training of ED+ARP.

4.4.1. Analysis

As expected, the worst-performing setup is the individual tasks-pipeline approach, where it not only suffers from error propagation, but each model is trained from scratch for each sub-task (without any interaction between them). Both full MTL and full STL achieved slightly better results. Between these two, the full multi-task training took a few more iterations and took longer to train because the approach is more complex.

The best performing models are those that utilize a combination of MTL and STL task setups. Jointly training ED and ARP together (part of the combination #1) is a common approach in the event extraction literature Liu et al. (2018); Lee et al. (2021). However, in our case, we find that jointly training EMD + ED (combination #2) brings better performance. This is because *CrudeOilNews* does not exhibit strong interdependence between event type and argument roles as it is in ACE2005. This can be explained using example sentences found in the respective datasets in Table 5.

The best performing task setup is *Combination #2: EMD + ED → ARP*. The training of EMD and ED can be done jointly via MTL without much impact on both task. This is because we noticed that entity mentions and trigger words, by definition, are mutually exclusive, e.g. an entity such as *crude oil* is never an event trigger, vice versa an event trigger such as *glut*, though a noun, is never an entity mention. Treating EMD+ED as the source task is useful for the target task. This is related to the fact that the lower embedding and semantic information learned from joint training EMD + ED has a good level of knowledge about entities and triggers, the resulting model has a presentation that is useful for the ARP target task.

5. Event Properties Classification

5.1. Baseline Model

One of the challenges we face when training a model for event properties classification is to classify each event in sentences that contain multiple events

| Dataset | Analysis |
|---|--|
| <p>ACE2005:</p> <p>(1) <i>In Baghdad, a cameraman <u>died</u> when an American tank <u>fired</u> on Palestine Hotel</i></p> <p>(2) <i>He has <u>fired</u> his air defence chief.</i></p> | <p>The first occurrence of “fired” is an event trigger of type ATTACK while the second “fired” takes END-POSITION as its event type. The authors in Li et al. (2013) argues that event arguments play a key role in helping classifying the correct event. For example, the presence of “tank” plays the role of WEAPON helps determine the right event type. Likewise, in the second sentence, “defence chief” plays the role of POSITION can help the model classify the second “fired” as END-POSITION. Hence jointly training both ED and ARP helps improve the accuracy of both ED and APR.</p> |
| <p>CrudeOilNews: <i>U.S. crude stockpiles <u>soared</u> by 1.350 million barrels in December from a mere 200 million barrels to 438.9 million barrels, due to this <u>oversupply</u> crude oil prices <u>plunged</u> more than 50% on Tuesday.</i></p> | <p>Events are more straight forward, ie. trigger words are tied to just one type of event, therefore there is no need to utilize arguments to help differentiate the event type.</p> |

Table 5: Analysis of events in *ACE2005* and in *CrudeOilNews* respectively. Both datasets exhibit different level of interdependence between event trigger words and its event arguments. The difference in the level of interdependence influenced the selection of the best MTL and STL combination for each of the dataset.

accurately. According to Lee et al. (2022), on average, the sentences in the *CrudeOilNews* corpus has about 2 to 3 events. Accurate classification of event properties requires identifying cue words at the event scope level and not at the sentence level, i.e., classify the entire sentence. In comparison, both Negation

and Uncertainty detection tasks in SEM2012 and CoNLL2011 are done at the sentence level. Therefore to accurately classify event properties, rather than using the whole sentence that may consist of several events, we have to narrow down the scope to use only the event scope, which is just a portion of the sentences.

5.1.1. Model Architecture

To obtain this ‘scope’, we experimented with the following inputs:

1. use the fixed window of words around event trigger word(s) ($x_{i-r} \dots x_{i-1} \oplus x_i \oplus x_{i+1} \dots x_{i+r}$) where \oplus is the concatenation operation, r represents the length from trigger word x_i . The sequential word representation is fed into an MLP to generate a vector and then through a *softmax* activation function.
2. Use dependency parse sub-tree of event trigger in Lee et al. (2021)
3. Use `SelfAttentiveSpanExtractor` Gardner et al. (2018) (part of the AllenNLP library) to weightedly combine the representations of multiple tokens and create a single vector for the original event span. The span vectors are fed into a two-layer feed-forward network with a *softmax* activation function.

5.2. Experiments

Train-Test Split. The main challenge in Event Property classification with the *CrudeOilNews* corpus is class imbalance. To address this, we modified the k-fold cross-validation from random sampling to stratified sampling. This is done to ensure that both the training and testing set in each cross-validation maintain the same class distribution (label ratio) of the original dataset as shown in Figure A.10.

Results. All three sub-tasks (Polarity, Modality, and Intensity classification) are standalone and independent tasks where the outcome of one does not influence the outcome of others. Therefore all three classification models were

trained independently of each other. Event Modality and Polarity classification is a binary classification task, the labels for Modality are: `ASSERTED` and `OTHER`, and for Polarity are: `POSITIVE` and `NEGATIVE`. Both classification tasks are trained on Binary Cross-entropy Loss. As for Event Intensity, it is a multi-class classification task, the labels are: `NEUTRAL`, `EASED`, and `INTENSIFIED`. It is trained on multi-class Cross-entropy Loss. We run experiments to determine the most suitable text span for the classification of Event Property Classification by the text processing methods listed in Table 6.

| Text Span Generation Methods | Polarity | | Modality | | Intensity | |
|---|--------------|--------------|--------------|--------------|--------------|--------------|
| | F1 | MCC | F1 | MCC | F1 | MCC |
| 3-grams fixed window centered around event trigger | 0.685 | 0.285 | 0.699 | 0.305 | 0.701 | 0.320 |
| Dependency parse tree Lee et al. (2021) | 0.759 | 0.305 | 0.723 | 0.298 | 0.699 | 0.298 |
| SelfAttentiveSpanExtractor Jiang & de Marneffe (2021) | 0.892 | 0.385 | 0.851 | 0.462 | 0.751 | 0.665 |

Table 6: Experiment results of different Input Text Span.

Analysis. Based on the results in Table 6, we conclude that the best text span is the ones generated by `SelfAttentiveSpanExtractor`, then followed by using a dependency parse tree. Dependency parse tree utilizes the syntactic structures of the input sentence and work well for identifying modifiers and negations such as `WILL` and `NOT` that are linked to the event trigger’s sub-parse tree. However, it does not work for cases where event trigger is not a verb that forms its sub-tree. We illustrate this with an example sentence: “The Trump administration will not consider reimposing sanctions on the OPEC member nation.” and a portion of the dependency tree in Figure 7.

The worst performing text span is using neighboring words centering around event trigger because it does not capture words that are far away from the trigger (i.e.: words are located outside of the 3-grams window). Based on the example

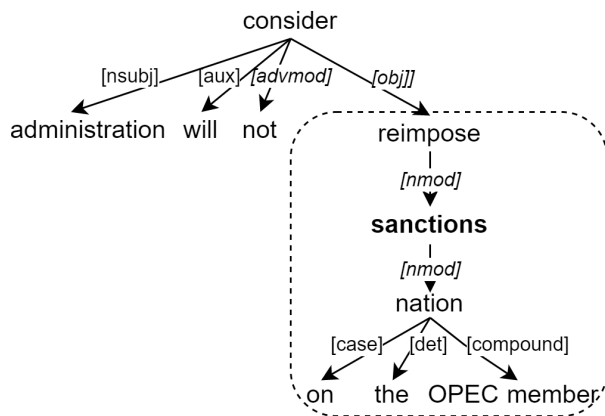

Figure 7: An example of a pruned dependency parse tree (enclosed in dotted lines) that did not generate a good text input for modality and polarity classification. Based on the event trigger word - **sanctions**, this pruned dependency parse tree does not contain the modality and polarity cue words: *will* and *not*.

above, the word cue word ‘will’ is not extracted as part of the text span for **sanctions** because it is located outside of the fixed window centered around the event trigger. In the section that follows, cross-domain sequential transfer learning is done using `selfAttentiveSpanExtractor` approach, the input text span that produces the best event property classification results.

The F1-score for both Polarity and Modality classification is high, while their respective MCC scores are much lower. This situation is caused by class imbalance in these two classifications, as shown in Figure A.10. Error analysis on these two tasks showed the errors are primarily False Positives. The models tend to classify everything to the majority class (POSITIVE for Polarity classification and ASSERTED for Modality classification), which result in low precision. Given that MCC score takes into account all four values in the confusion matrix, a low MCC score shows that the models are not good at classifying the minority classes.

The most challenging among the three tasks is Event Intensity classification. Some of the cue words for determining the event intensity (NEUTRAL, EASED, INTENSIFIED) are themselves trigger words. For example, *Oversupply could*

rise next year when Iraq starts to export more oil. The correct interpretation should be: The event oversupply might be further INTENSIFIED (cue word: rise, but this word is also a trigger word for the event - MOVEMENT-UP-GAIN.

5.3. Cross-Domain Sequential Transfer Learning

Here we investigate the usage of other available corpora in all domains for the purpose of cross-domain STL. The idea is to use resources from different source domains to train a model on a task before fine-tuning the model to adapt to a new domain on the same task. We carry out this STL by first training the corpora from the *source domain* on Event Polarity / Modality classification and then transfer the model to fine-tune on the same task on the *target domain*, i.e., *CrudeOilNews* corpus. Figure 8 shows a graphical depiction of the idea of STL. In the top section, a labeled dataset in the source domain is used to train a model on event polarity or modality classification. The model is then trained using the dataset from the target domain and fine-tuned on the same task, as shown in the bottom section.

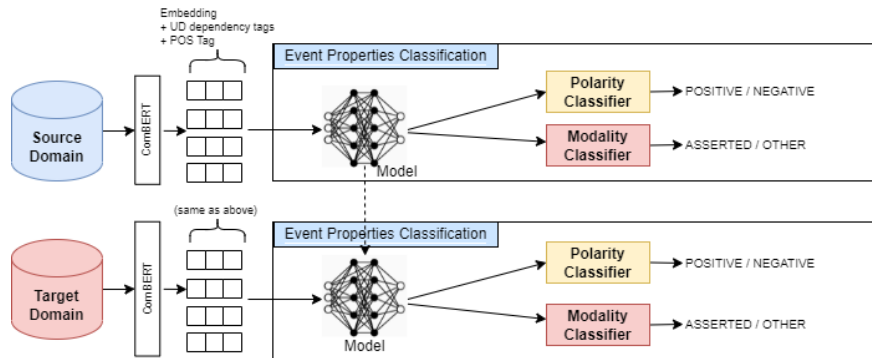

Figure 8: *Sequential Transfer Learning (STL)*: The model is first trained on labeled dataset in the source domain (see list of corpora listed in Table 7) before being transferred to train on the Target Domain (*CrudeOilNews*). STL is done for Polarity and Modality Classification. On the other hand, intensity classification is trained from scratch with just the *CrudeOilNews* corpus due to the lack of resources.

Before going into the implementation details of cross-domain STL, it is important we align the task definitions as they may appear as different names:

1. **Event Polarity Classification**⁹ can be aligned to **Negation Detection**, such as in *SEM 2012 Shared Task: Negation Detection and Scope Resolution*.
2. **Event Modality Classification** can be aligned to **Hedge / Uncertainty / Speculation Detection** such as in *CoNLL 2010 shared task: Hedge detection and scope resolution*.

In the subsections that follow, we lay out the available resources for both negation detection and uncertainty detection. Resources for Event Factuality Prediction (EFP) is excluded here because EFP combines both negation and speculation detection to determine the ‘factuality’ of an event. Instead, we look to corpora that have Negation and Uncertainty annotated individually to match how event polarity and modality are annotated in *CrudeOilNews* corpus.

Corpora for Negation Detection.

1. In SEM2012 Shared Task Morante & Blanco (2012), two corpora in the general text were released for negation scope and focus detection; they are the *Conan Doyle stories* and the *Penn TreeBank* corpus;
2. In the survey paper Jiménez-Zafra et al. (2020), the authors listed out all English and Spanish corpora annotated with negation (negation cue and its respective scope). According to the list, majority of the available corpora are in the following domains:
 - (a) Bio-related text domain: *BioInfer*, *Genia Event*, *BioScope*, and *DrugDDI*;
 - (b) Consumer reviews: *product review Corpus*, *SFU Review*, *Movie review*;
 - (c) General Domain: *Prop Bank* and *SFU Opinion & Comments (SOCC)*

⁹Not to be confused with Sentiment Polarity(Positive / Negative sentiment)

Corpora for Uncertainty Detection.

1. The CoNLL2010 share task Farkas et al. (2010) is made up of a collection of corpora include Biology-related publications and general domain factual text from Wikipedia;
2. Financial domain, Theil et al. (2018) introduced the *10-k financial disclosures corpus* for the task of classifying financial statements whether they are *certain* or *uncertain*.
3. Consumer reviews : SFU Reviews corpus Konstantinova et al. (2012) contains both uncertainty and negation cue words and scope annotated.

| Dataset | Domain | Negation | | Uncertainty | |
|---|--------------------------------|-------------------|-------|-------------------|-------|
| | | Cue | Scope | Cue | Scope |
| 1. ConanDoyle(neg) Morante & Blanco (2012) | Fiction | ✓ | ✓ | | |
| 2. SFU OCC(neg) Kolhatkar et al. (2020) | Opinion News & Comments | ✓ | ✓ | | |
| 3. 10kFinStatement(unc) Theil et al. (2018) | Corporate Financial Disclosure | | | only class labels | |
| 4. Wikipedia(unc) Farkas et al. (2010) | General | | | ✓ | |
| 5. Reviews(neg & unc) Konstantinova et al. (2012) | Product Reviews | ✓ | ✓ | ✓ | ✓ |
| 6. SENTiVENT Jacobs & Hoste (2021) | Economic news | only class labels | | only class labels | |

Table 7: The list of open source corpora with Negation and Uncertainty Annotation.

5.3.1. Domain Similarity

In transfer learning, it is observed that the more related the tasks, the easier it is for transfer or cross-utilize the knowledge Sanh et al. (2019). The same holds

true for data where the more related the source domain to the target domain, the easier it is for effective transfer learning Meftah et al. (2021); Gururangan et al. (2020). Based on this, we excluded Bio-medical-related corpora from our experiments because the Bio-medical domain has its specific vocabulary deemed different from the Finance and Economics domain and is an ill-fit with ComBERT embeddings¹⁰. Five corpora was selected and are listed in Table 7; the details of each of these corpora are found in Appendix A.

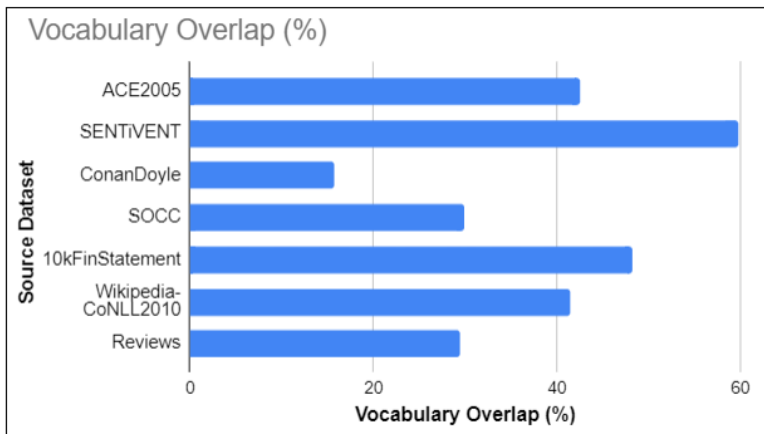

Figure 9: Vocabulary overlap (%) between source datasets and *CrudeOilNews* target dataset. Vocabularies of each domain are made up of the top 10K most frequent words (excluding stopwords) in each corpus.

We evaluate domain similarity between the source datasets and *CrudeOilNews* by obtaining the percentage of vocabulary overlap of the two as shown in Figure 9. On a continuum of the proximity between source datasets and target dataset, the source datasets can be ranked as *SENTiVENT* \rightarrow *10kFinStatement* \rightarrow *Wikipedia-CoNLL2010* \rightarrow *ACE2005* \rightarrow *SOCC* \rightarrow *Reviews* \rightarrow *ConanDoyle*.

¹⁰see Section 3.1 for more details about ComBERT

5.3.2. Task Modification

The shared task of CoNLL2010 (for Uncertainty Detection) and SEM2010 (for Negation Detection) consist of two sub-tasks: (1) it involves first detecting the cue words at the sentence level and then (2) resolving the scope based on the cue words detected. Event property classification, on the other hand, is slightly different where the main aim is to detect the event first and then determine the event properties based on the event and its scope. Due to the difference in the original source tasks and how the source datasets listed in Table 7 are annotated, we modify the original tasks and adapted them to our task of event property classification by making the following modifications:

1. Simplify the shared task to just one task. The original Negation / Uncertainty detection involves two sub-tasks : (1) cue word detection and (2) scope resolution. This is simplified into a single sequence classification task.
2. Align class labels:
 - (a) Event Polarity: For sentences that contain Negation cue words, we assign the label NEGATIVE for the whole sentence. For sentences without, we assign the label POSITIVE instead.
 - (b) Event Modality: Similar to polarity classification, sentences with Uncertainty cue words or has the labeled ‘uncertain’ are labeled with OTHER. For sentences without, we assign the label ASSERTED.

5.4. Experiments

First, we train Event Polarity / Modality using the corpora listed in Table 7; these corpora are known as the “source domain” D_s . Then we transfer the model to train on the same task on the “target corpus” D_t , the *CrudeOilNews* corpus. In our experiments, we use the best model trained on the source dataset for STL on *CrudeOilNews*. In other words, we picked the model at the epoch with the highest performance on the source validation set.

| Event Polarity Classification | | | |
|-------------------------------|--------------|-----------------|-----------------|
| Source D_s | Target D_t | F1 | MCC |
| 1a. - | CrudeOilNews | 0.892 | 0.385 |
| 1b. ConanDoyle | CrudeOilNews | 0.699(↓) | 0.305(↓) |
| 1c. OCC | CrudeOilNews | 0.893(↑) | 0.498(↑) |
| 1d. Reviews | CrudeOilNews | 0.713(↓) | 0.412(↑) |
| 1e. SENTiVENT | CrudeOilNews | 0.895(↑) | 0.678(↑) |
| Event Modality Classification | | | |
| Source D_s | Target D_t | F1 | MCC |
| 2a. - | CrudeOilNews | 0.851 | 0.462 |
| 2b. 10kFinStatement | CrudeOilNews | 0.879↑ | 0.695↑ |
| 2c. Wikipedia | CrudeOilNews | 0.841(↓) | 0.501(↑) |
| 2d. Reviews | CrudeOilNews | 0.723(↓) | 0.395(↓) |
| 2e. SENTiVENT | CrudeOilNews | 0.883(↑) | 0.715(↑) |

Table 8: The results of Polarity and Modality classification of *CrudeOilNews* using various source datasets (identified in Table 7) as source domain D_s in Sequential transfer learning.

Results. Event Intensity classification is excluded from cross-domain STL because to the best of our knowledge, there is no available labeled dataset annotated for event intensity classification.

Analysis. We analyze the results shown in Table 8 by the list of event properties below:

1. Event Polarity: there is some form of improvement when the model is trained on a source domain first before fine-tuning the model on the target domain on the same task. The best “source domain” corpus for Event Polarity is *SENTiVENT*, while models trained on *ConanDoyle* and *Reviews* performed worst than the baseline model. The main reason is that these corpora are somewhat dissimilar to *CrudeOilNews* corpus that resulted in Negative Transfer. Performance deterioration is especially apparent

in *ConanDoyle* because it is a corpus made up of dialogues or conversations and has negation cues mainly in a conversational form such as *don't*, *doesn't*, *didn't*, *isn't*, *can't*, *wasn't* that are not found in the target corpus.

2. Event Modality: Due to the similarity between the *CrudeOilNews* and the two finance-related corpora : *SENTiVENT* and *10KFinStatement*, the resulting cross-domain STL models are able to provide a significant boost to model classification performance. Similar to the *ConanDoyle* corpus, the *Reviews* contains conversational-like sentences that have minimal overlap with *CrudeOilNews* in terms of uncertainty cue words that resulted in model performance worse than the baseline.

It is worth highlighting that by comparing between F1-score and MCC-score, MCC-score has a more significant jump in improvement. As highlighted in Section 5.2, results of baseline models show a lower MCC-score because of class imbalance; the models tend to classify everything to the majority class leading to a high number of False Positives. Upon training the model with source datasets that do not have a serious class imbalance issue, the final models have higher MCC-scores. Based on error analysis, it is shown that the final models have higher True Negatives (higher prediction on minority class) and thus lead to better MCC-score.

It can be concluded from the results above that the more similar the source domain is to the target domain, the easier we can use cross-domain STL to improve the final classifier’s performance. It is also observed in Ruder (2019) that the more distant two domains are, the harder it is to adapt from one to the other. Apart from improving the models’ F1 score, it is also observed that the models’ MCC improves as well. An improved MCC score means classification performance improves across all classes, including the minority class, therefore addressing the issue of class imbalance.

| | Type | Accuracy | Precision | Recall | F1 | MCC |
|-------|--|----------|-----------|--------|-------|-------|
| EE | 1. Entity Mention Detection (EMD) + Event Detection (ED) | 0.977 | 0.933 | 0.949 | 0.941 | - |
| | 2. Argument Role Prediction (ARP) | 0.914 | 0.913 | 0.914 | 0.913 | 0.840 |
| Prop. | 1. Event Polarity | 0.821 | 0.697 | 0.917 | 0.792 | 0.717 |
| | 2. Event Modality | 0.852 | 0.803 | 0.842 | 0.822 | 0.771 |
| | 3. Event Intensity | 0.702 | 0.765 | 0.664 | 0.751 | 0.665 |

Table 9: Final results

6. Conclusion & Future Work

It is known that training models via the traditional approach of supervised learning requires a substantial amount of annotated data. This challenge becomes even more apparent for a lower-resource domain such as Finance and Economics. To produce accurate event extraction models from the *CrudeOil-News* corpus, we leveraged the effectiveness of transfer learning to build event extraction and event classification models with the best possible performance despite limited resources.

In the transfer learning setting, we are able to utilize source task T_s or source domain D_s to improve model embeddings and representations in order to produce better model performance in target task T_t or target domain D_t . Based on the experiment results, we come to the following conclusions:

1. Domain Adaptive Pre-Training: Further pre-training BERT on in-domain data to produce ComBERT produced better contextualized embedding that improved model performance;
2. Combination of Multi-Task Learning and Sequential Transfer Learning: After experimenting with various permutations of MTL and STL sub-tasks configurations, the best configuration for event extraction in *CrudeOil-News* is EMD + ED \rightarrow ARP, where EMD + ED are trained via MTL before sequentially transferring the resulting model to train on ARP.

3. Cross-domain Sequential Transfer Learning: Source datasets annotated for the same tasks can be used to boost the performance of event property classification in *CrudeOilNews* corpus despite the severe class imbalance. However, it is worth noting that selecting a source domain with high source-target similarity is vital to have the best model performance and to avoid the undesirable result of negative transfer.

The final model performance for each sub-task is tabulated and shown again in Table 9 for easier reference. Even though we have managed to use transfer learning to achieve better model performance, one of the major weaknesses of the framework is that the current event ontologies are exhaustive and will not cater to new events. As part of future work, we are interested in investigating ways to increase event coverage for crude oil news. One promising direction is to use zero-shot learning like in Huang et al. (2018). Another promising direction is to investigate domain adaptation of event extraction from crude oil news to a similar domain, such as in gold-related news or even FoRex (Foreign Exchange) news.

Appendix A. Target Dataset: CrudeOilNews Corpus

- Tasks: Event Extraction, Event Modality, Polarity and Intensity Classification.
- Domain: Commodity news surrounding Crude Oil.
- Size: 425 documents, 7,059 sentences, 10,578 events, and 22,267 event arguments.
- Event Types: Movement-down-loss, movement-up-gain, movement-flat, cause-movement-down-loss, caused-movement-up-gain, position-high, position-low, slow-weak, grow-strong, prohibiting, oversupply, shortage, civil-unrest, embargo, geo-political tension, crisis and negative-sentiment.

Here is a list of characteristics exhibited by this dataset and each pose a unique challenge to the overall event extraction task:

1. Limited amount of labeled data;
2. Class imbalance / topic bias: serious class imbalance in event Properties distribution as shown in Figure A.10 where the majority class outnumbers the minority classes by a large margin;
3. Homogenous entity types but playing different argument roles; **One or two examples here will be good.**
4. Number intensity: Numbers (e.g., price, difference, percentage of change) and dates (including date of the opening price, dates of closing price) are abundant in commodity news.

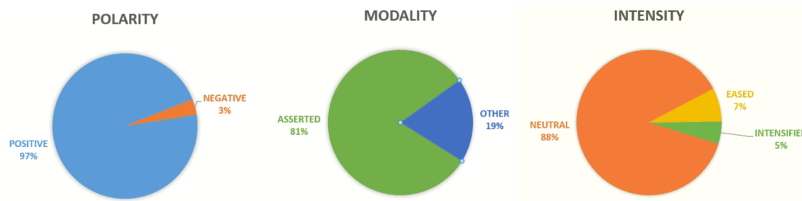

Figure A.10: Event Polarity, Modality and Intensity Distribution

Appendix A.1. Event Properties Examples

1. Event Polarity

- POSITIVE: *OPEC members agreed to cut oil supplies.*
- NEGATIVE: *OPEC countries **refused** to cut oil suppliers.*

2. Event Modality:

- ASSERTED: *Saudi Arabia continues to cut its production.*
- OTHER: *Analysts were **anticipating** oil inventories to fall by 800,000.*

3. Event Intensity:

- NEUTRAL: *Oil rise third day in a row to all time high.*
- EASED: *Libya 's civil strife has been **eased** by potential peace talks.*
- INTENSIFIED: *...could hit Iraq 's output and **deepen** a supply shortfall.*

Appendix B. Source Datasets

1. ACE2005

- Tasks: Event Extraction, Event Modality and Polarity classification.
- Domain: General, corpus made up of conversations, broadcast news, newsgroups, weblogs.
- Size: 587 documents, 5,055 events, 18,927 sentences, 6,040 event arguments, 34,474 entities.
- Event Types: Life, Movement, Transaction, Business, Conflict, Contact, Personnel, Justice

2. SENTiVENT Jacobs & Hoste (2021)

- Tasks: Event Extraction, Event Modality and Polarity Classification.
- Domain: Business / Finance News
- Size: 288 documents, 6,203 events, 6,883 sentences, 13,675 arguments.

- Event Types: CSR / Brand, Deal, Dividend, Employment, Expense, Facility, Financial Report, Financing, Investing, Legal, Macroeconomics, Merger / Acquisition, Product / Service, Profit / Loss, Rating, Revenue, Sales Volume, Security Value

3. **ConanDoyle** Morante & Blanco (2012)

- Tasks: Negation detection
- Domain: Fiction / stories
- Size: 3640 sentences from The Hound of the Baskervilles story, out of which 850 contain negations, and 783 sentences from The Adventure of Wisteria Lodge story, out of which 145 contain negations.
- Description: a corpus of Conan Doyle stories annotated with negation cues and their scopes, as well as the event or property that is negated. Negation cues are made up of the following types: lexical, syntactic, and morphological.

4. **SOCC(neg)** Kolhatkar et al. (2020)

- Tasks: Negation detection
- Domain: opinion, review and comments
- Size: 10399 opinion articles (editorials, columns and op-eds); 663,173 comments from 303,665 comment threads, from the main Canadian daily newspaper (from January 2012 to December 2016)
- Description: The corpus is organized into three subcorpora: the articles corpus, the comments corpus, and the comment-threads corpus. Only the articles sub-corpora is used for this work.

5. **10kFinStatement(unc)** Theil et al. (2018)

- Tasks: Uncertainty detection
- Domain: Finance - 10-k reports

- Size: 1000 sentences from 10-Ks¹¹
- Description: each labeled with *certain* and *uncertain* but does not have uncertainty cue words nor scope annotated.

6. **Wikipedia-CoNLL2010(unc)**

- Tasks: dataset is provided as part of CoNLL2010 shared task - Learning to Detect Hedges and their Scope in Natural Language Text.
- Domain: General - Wikipedia articles
- Size: 2,186 paragraphs collected from Wikipedia archives were also offered as Task1 training data (11,111 sentences containing 2,484 uncertain ones). The evaluation dataset contained 2,346 Wikipedia paragraphs with 9,634 sentences, out of which 2234 were uncertain.
- Description:

7. **Reviews(neg & unc)** Konstantinova et al. (2012)

- Tasks: Negation and Uncertainty detection
- Domain: Reviews of movie, book and consumer product, taken from www.Epinions.com.
- Size: 400 documents

Appendix C. Additional results

Detail breakdown of Event Extraction results by their respective classes are presented here. Entity Mention Detection (EMD) + Event Detection (ED) results are presented in Table C.10 while Argument Role Prediction (ARP) results are listed in Table C.11.

¹¹A 10-K is a comprehensive report filed annually by public companies about their financial performance.

References

- Alyafeai, Z., AlShaibani, M. S., & Ahmad, I. (2020). A survey on transfer learning in natural language processing. *arXiv preprint arXiv:2007.04239*, .
- Beltagy, I., Lo, K., & Cohan, A. (2019). Scibert: A pretrained language model for scientific text. In *Proceedings of the 2019 Conference on Empirical Methods in Natural Language Processing and the 9th International Joint Conference on Natural Language Processing (EMNLP-IJCNLP)* (pp. 3615–3620).
- Blitzer, J., Dredze, M., & Pereira, F. (2007). Biographies, bollywood, boom-boxes and blenders: Domain adaptation for sentiment classification. In *Proceedings of the 45th annual meeting of the association of computational linguistics* (pp. 440–447).
- Chen, Y. (2021). A transfer learning model with multi-source domains for biomedical event trigger extraction. *BMC Genomics* 22, .
- Chen, Y., Xu, L., Liu, K., Zeng, D., & Zhao, J. (2015). Event extraction via dynamic multi-pooling convolutional neural networks. In *Proceedings of the 53rd Annual Meeting of the Association for Computational Linguistics and the 7th International Joint Conference on Natural Language Processing (Volume 1: Long Papers)* (pp. 167–176).
- Devlin, J., Chang, M.-W., Lee, K., & Toutanova, K. (2019). BERT: Pre-training of deep bidirectional transformers for language understanding. In *Proceedings of the 2019 Conference of the North American Chapter of the Association for Computational Linguistics: Human Language Technologies, Volume 1 (Long and Short Papers)* (pp. 4171–4186). Minneapolis, Minnesota: Association for Computational Linguistics. URL: <https://www.aclweb.org/anthology/N19-1423>. doi:10.18653/v1/N19-1423.

- Farkas, R., Vincze, V., Móra, G., Csirik, J., & Szarvas, G. (2010). The conll-2010 shared task: learning to detect hedges and their scope in natural language text. In *Proceedings of the fourteenth conference on computational natural language learning-Shared task* (pp. 1–12).
- Gardner, M., Grus, J., Neumann, M., Tafjord, O., Dasigi, P., Liu, N. F., Peters, M. E., Schmitz, M., & Zettlemoyer, L. (2018). Allennlp: A deep semantic natural language processing platform. In *Proceedings of Workshop for NLP Open Source Software (NLP-OSS)* (pp. 1–6).
- Gui, L., Xu, R., Lu, Q., Du, J., & Zhou, Y. (2018a). Negative transfer detection in transductive transfer learning. *International Journal of Machine Learning and Cybernetics*, 9, 185–197.
- Gui, T., Zhang, Q., Gong, J., Peng, M., Liang, D., Ding, K., & Huang, X.-J. (2018b). Transferring from formal newswire domain with hypernet for twitter pos tagging. In *Proceedings of the 2018 Conference on Empirical Methods in Natural Language Processing* (pp. 2540–2549).
- Gururangan, S., Marasović, A., Swayamdipta, S., Lo, K., Beltagy, I., Downey, D., & Smith, N. A. (2020). Don’t stop pretraining: Adapt language models to domains and tasks. In *Proceedings of the 58th Annual Meeting of the Association for Computational Linguistics* (pp. 8342–8360).
- Hogenboom, F., Frasinca, F., Kaymak, U., De Jong, F., & Caron, E. (2016). A survey of event extraction methods from text for decision support systems. *Decision Support Systems*, 85, 12–22.
- Huang, L., Ji, H., Cho, K., Dagan, I., Riedel, S., & Voss, C. (2018). Zero-shot transfer learning for event extraction. In *Proceedings of the 56th Annual Meeting of the Association for Computational Linguistics (Volume 1: Long Papers)*.
- Jacobs, G., & Hoste, V. (2021). Sentivent: enabling supervised information

- extraction of company-specific events in economic and financial news. *Language Resources and Evaluation*, (pp. 1–33).
- Jiang, N., & de Marneffe, M.-C. (2021). He thinks he knows better than the doctors: Bert for event factuality fails on pragmatics. *Transactions of the Association for Computational Linguistics*, 9, 1081–1097.
- Jiménez-Zafra, S. M., Morante, R., Teresa Martín-Valdivia, M., & Ureña-López, L. A. (2020). Corpora annotated with negation: An overview. *Computational Linguistics*, 46, 1–52.
- Judea, A., & Strube, M. (2016). Incremental global event extraction. In *Proceedings of COLING 2016, the 26th International Conference on Computational Linguistics: Technical Papers*.
- Kolhatkar, V., Wu, H., Cavasso, L., Francis, E., Shukla, K., & Taboada, M. (2020). The sfu opinion and comments corpus: A corpus for the analysis of online news comments. *Corpus Pragmatics*, 4, 155–190.
- Konstantinova, N., De Sousa, S. C., Díaz, N. P. C., López, M. J. M., Taboada, M., & Mitkov, R. (2012). A review corpus annotated for negation, speculation and their scope. In *Proceedings of the Eighth International Conference on Language Resources and Evaluation (LREC'12)* (pp. 3190–3195).
- Konyushkova, K., Sznitman, R., & Fua, P. (2017). Learning active learning from data. *Advances in neural information processing systems*, 30.
- Lee, J., Yoon, W., Kim, S., Kim, D., Kim, S., So, C. H., & Kang, J. (2020). Biobert: a pre-trained biomedical language representation model for biomedical text mining. *Bioinformatics*, 36, 1234–1240.
- Lee, M., Soon, L.-K., & Siew, E.-G. (2021). Effective use of graph convolution network and contextual sub-tree for commodity news event extraction. In *Proceedings of the Third Workshop on Economics and Natural Language Processing* (pp. 69–81).

- Lee, M., Soon, L.-K., Siew, E.-G., & Sugianto, L. F. (2022). Crudeoilnews: An annotated crude oil news corpus for event extraction. *arXiv preprint arXiv:2204.03871*, .
- Li, Q., Ji, H., Hong, Y., & Li, S. (2014). Constructing information networks using one single model. In *Proceedings of the 2014 Conference on Empirical Methods in Natural Language Processing (EMNLP)*.
- Li, Q., Ji, H., & Huang, L. (2013). Joint event extraction via structured prediction with global features. In *Proceedings of the 51st Annual Meeting of the Association for Computational Linguistics (Volume 1: Long Papers)* (pp. 73–82).
- Liu, X., Luo, Z., & Huang, H. (2018). Jointly multiple events extraction via attention-based graph information aggregation. In *Proceedings of the 2018 Conference on Empirical Methods in Natural Language Processing* (pp. 1247–1256). Brussels, Belgium: Association for Computational Linguistics. URL: <https://www.aclweb.org/anthology/D18-1156>. doi:10.18653/v1/D18-1156.
- Lyu, Q., Zhang, H., Sulem, E., & Roth, D. (2021). Zero-shot event extraction via transfer learning: Challenges and insights. In *Proceedings of the 59th Annual Meeting of the Association for Computational Linguistics and the 11th International Joint Conference on Natural Language Processing (Volume 2: Short Papers)* (pp. 322–332).
- Manning, C. D., Surdeanu, M., Bauer, J., Finkel, J. R., Bethard, S., & McClosky, D. (2014). The stanford corenlp natural language processing toolkit. In *Proceedings of 52nd annual meeting of the association for computational linguistics: system demonstrations* (pp. 55–60).
- Marasović, A., & Frank, A. (2016). Multilingual modal sense classification using a convolutional neural network. In *Proceedings of the 1st Workshop on Representation Learning for NLP* (pp. 111–120).

- Meftah, S., & Semmar, N. (2018). A neural network model for part-of-speech tagging of social media texts. In *Proceedings of the Eleventh International Conference on Language Resources and Evaluation (LREC 2018)*.
- Meftah, S., Semmar, N., Tamaazousti, Y., Essafi, H., & Sadat, F. (2021). On the hidden negative transfer in sequential transfer learning for domain adaptation from news to tweets. In *Proceedings of the Second Workshop on Domain Adaptation for NLP* (pp. 140–145).
- Mitamura, T., Yamakawa, Y., Holm, S., Song, Z., Bies, A., Kulick, S., & Strassel, S. (2015). Event nugget annotation: Processes and issues. In *Proceedings of the The 3rd Workshop on EVENTS: Definition, Detection, Coreference, and Representation* (pp. 66–76).
- Morante, R., & Blanco, E. (2012). * sem 2012 shared task: Resolving the scope and focus of negation. In * *SEM 2012: The First Joint Conference on Lexical and Computational Semantics–Volume 1: Proceedings of the main conference and the shared task, and Volume 2: Proceedings of the Sixth International Workshop on Semantic Evaluation (SemEval 2012)* (pp. 265–274).
- Nguyen, T. H., Cho, K., & Grishman, R. (2016). Joint event extraction via recurrent neural networks. In *Proceedings of the 2016 Conference of the North American Chapter of the Association for Computational Linguistics: Human Language Technologies* (pp. 300–309).
- Nguyen, T. M., & Nguyen, T. H. (2019). One for all: Neural joint modeling of entities and events. In *Proceedings of the AAAI Conference on Artificial Intelligence* (pp. 6851–6858). volume 33.
- Pan, S. J., & Yang, Q. (2010). A survey on transfer learning. *IEEE Transactions on Knowledge and Data Engineering*, 22, 1345–1359.
- Rosenstein, M. T., Marx, Z., Kaelbling, L. P., & Dietterich, T. G. (2005). To

- transfer or not to transfer. In *In NIPS'05 Workshop, Inductive Transfer: 10 Years Later*.
- Ruder, S. (2019). *Neural transfer learning for natural language processing*. Ph.D. thesis NUI Galway.
- Ruder, S., Bingel, J., Augenstein, I., & Søgaard, A. (2017). Sluice networks: Learning what to share between loosely related tasks. *arXiv preprint arXiv:1705.08142*, 2.
- Sanh, V., Wolf, T., & Ruder, S. (2019). A hierarchical multi-task approach for learning embeddings from semantic tasks. In *Proceedings of the AAAI Conference on Artificial Intelligence* (pp. 6949–6956). volume 33.
- Saurí, R., & Pustejovsky, J. (2009). Factbank: a corpus annotated with event factuality. *Language resources and evaluation*, 43, 227–268.
- Sha, L., Qian, F., Chang, B., & Sui, Z. (2018). Jointly extracting event triggers and arguments by dependency-bridge rnn and tensor-based argument interaction. *Proceedings of the AAAI Conference on Artificial Intelligence*, 32.
- Søgaard, A., & Goldberg, Y. (2016). Deep multi-task learning with low level tasks supervised at lower layers. In *Proceedings of the 54th Annual Meeting of the Association for Computational Linguistics (Volume 2: Short Papers)* (pp. 231–235).
- Theil, C. K., Štajner, S., & Stuckenschmidt, H. (2018). Word embeddings-based uncertainty detection in financial disclosures. In *Proceedings of the First Workshop on Economics and Natural Language Processing* (pp. 32–37).
- Torrey, L., & Shavlik, J. (2010). Transfer learning. In *Handbook of research on machine learning applications and trends: algorithms, methods, and techniques* (pp. 242–264). IGI global.

- Wadden, D., Wennberg, U., Luan, Y., & Hajishirzi, H. (2019). Entity, relation, and event extraction with contextualized span representations. In *Proceedings of the 2019 Conference on Empirical Methods in Natural Language Processing and the 9th International Joint Conference on Natural Language Processing (EMNLP-IJCNLP)*.
- Weiss, K., Khoshgoftaar, T. M., & Wang, D. (2016). A survey of transfer learning. *Journal of Big data*, 3, 1–40.
- Wu, Y., Schuster, M., Chen, Z., Le, Q. V., Norouzi, M., Macherey, W., Krikun, M., Cao, Y., Gao, Q., Macherey, K., Klingner, J., Shah, A., Johnson, M., Liu, X., Kaiser, L., Gouws, S., Kato, Y., Kudo, T., Kazawa, H., Stevens, K., Kurian, G., Patil, N., Wang, W., Young, C., Smith, J., Riesa, J., Rudnick, A., Vinyals, O., Corrado, G., Hughes, M., & Dean, J. (2016). Google’s neural machine translation system: Bridging the gap between human and machine translation. *CoRR*, abs/1609.08144. URL: <http://arxiv.org/abs/1609.08144>. arXiv:1609.08144.
- Xiang, W., & Wang, B. (2019). A survey of event extraction from text. *IEEE Access*, 7, 173111–173137. doi:10.1109/ACCESS.2019.2956831.
- Xie, B., Passonneau, R., Wu, L., & Creamer, G. G. (2013). Semantic frames to predict stock price movement. In *Proceedings of the 51st annual meeting of the association for computational linguistics* (pp. 873–883).
- Yang, B., & Mitchell, T. M. (2016). Joint extraction of events and entities within a document context. In *Proceedings of the 2016 Conference of the North American Chapter of the Association for Computational Linguistics: Human Language Technologies* (pp. 289–299). San Diego, California: Association for Computational Linguistics. URL: <https://aclanthology.org/N16-1033>. doi:10.18653/v1/N16-1033.
- Zhang, J., Qin, Y., Zhang, Y., Liu, M., & Ji, D. (2019). Extracting entities and events as a single task using a transition-based neural model. In *IJCAI* (pp. 5422–5428).

| | Type | P | R | F1 |
|----------------|-----------------------------|------|------|------|
| Entity Mention | 1. COMMODITY | 0.98 | 0.98 | 0.98 |
| | 2. COUNTRY | 0.97 | 0.98 | 0.98 |
| | 3. DATE | 0.94 | 0.96 | 0.95 |
| | 4. DURATION | 0.87 | 0.90 | 0.89 |
| | 5. ECONOMIC_ITEM | 0.89 | 0.95 | 0.92 |
| | 6. FINANCIAL_ATTRIBUTE | 0.98 | 0.99 | 0.99 |
| | 7. FORECAST_TARGET | 0.92 | 0.95 | 0.94 |
| | 8. GROUP | 0.56 | 0.50 | 0.53 |
| | 9. LOCATION | 0.90 | 0.91 | 0.90 |
| | 10. MONEY | 0.92 | 0.94 | 0.93 |
| | 11. NATIONALITY | 0.96 | 0.92 | 0.94 |
| | 12. NUMBER | 0.97 | 0.88 | 0.92 |
| | 13. ORGANIZATION | 0.94 | 0.96 | 0.95 |
| | 14. OTHER_ACTIVITY | 0.33 | 0.50 | 0.40 |
| | 15. PERCENT | 0.96 | 0.95 | 0.95 |
| | 16. PERSON | 0.98 | 0.97 | 0.98 |
| | 17. PHENOMENON | 0.0 | 0.0 | 0.0 |
| | 18. PRICE_UNIT | 0.96 | 0.99 | 0.97 |
| | 19. PRODUCTION_UNIT | 0.90 | 0.95 | 0.92 |
| | 20. QUANTITY | 0.80 | 0.92 | 0.86 |
| | 21. STATE_OR_PROVINCE | 0.77 | 0.85 | 0.80 |
| Event Trigger | 1. CAUSE_MOVEMENT_DOWN_LOSS | 0.92 | 0.93 | 0.92 |
| | 2. CAUSE_MOVEMENT_UP_GAIN | 0.87 | 0.89 | 0.88 |
| | 3. CIVIL_UNREST | 1.00 | 0.92 | 0.96 |
| | 4. CRISIS | 1.00 | 1.00 | 1.00 |
| | 5. EMBARGO | 0.97 | 1.00 | 0.98 |
| | 6. GEOPOLITICAL_TENSION | 0.75 | 0.88 | 0.81 |
| | 7. GROW_STRONG | 0.79 | 0.84 | 0.81 |
| | 8. MOVEMENT_DOWN_LOSS | xx | xx | xx |
| | 9. MOVEMENT_FLAT | 1.00 | 0.86 | 0.92 |
| | 10. MOVEMENT_UP_GAIN | xx | xx | xx |
| | 11. NEGATIVE_SENTIMENT | 0.93 | 0.94 | 0.93 |
| | 12. OVERSUPPLY | 0.80 | 0.83 | 0.82 |
| | 13. POSITION_HIGH | 0.91 | 1.00 | 0.96 |
| | 14. POSITION_LOW | 0.91 | 0.97 | 0.94 |
| | 15. PROHIBITING | 0.83 | 0.83 | 0.83 |
| | 16. SHORTAGE | 0.91 | 1.00 | 0.95 |
| | 17. SLOW_WEAK | 0.93 | 0.73 | 0.82 |
| | 18. TRADE_TENSIONS | 0.75 | 0.88 | 0.81 |

| Type | P | R | F1 |
|-----------------------------|----------|----------|-----------|
| 1. NONE | 0.94 | 0.95 | 0.95 |
| 2. ATTRIBUTE | 0.92 | 0.93 | 0.93 |
| 3. ITEM | 0.88 | 0.84 | 0.86 |
| 4. FINAL_VALUE | 0.85 | 0.78 | 0.82 |
| 5. INITIAL_VALUE | 0.50 | 0.30 | 0.37 |
| 6. DIFFERENCE | 0.89 | 0.91 | 0.90 |
| 7. REFERENCE_POINT | 0.79 | 0.77 | 0.78 |
| 8. INITIAL_REFERENCE_POINT | 0.43 | 0.53 | 0.47 |
| 9. CONTRACT_DATE | 1.00 | 0.94 | 0.97 |
| 10. DURATION | 0.83 | 0.87 | 0.85 |
| 11. TYPE | 0.79 | 0.74 | 0.76 |
| 12. IMPOSER | 0.84 | 1.00 | 0.91 |
| 13. IMPOSEE | 0.84 | 0.84 | 0.84 |
| 14. PLACE | 0.81 | 0.77 | 0.79 |
| 15. SUPPLIER_CONSUMER | 0.84 | 0.82 | 0.83 |
| 16. IMPACTED_COUNTRIES | 0.93 | 0.87 | 0.90 |
| 17. PARTICIPATING_COUNTRIES | 0.86 | 0.92 | 0.89 |
| 18. FORECASTER | 0.80 | 0.63 | 0.71 |
| 19. FORECAST | 0.76 | 0.59 | 0.67 |
| 20. SITUATION | 0.67 | 0.50 | 0.57 |

Table C.11: Argument Role Prediction