

DACSR: Decoupled-Aggregated End-to-End Calibrated Sequential Recommendation

Jiayi Chen¹, Wen Wu^{1*}, Liye Shi¹, Yu Ji¹, Wenxin Hu², Wei Zheng³ and Liang He¹

¹School of Computer Science and Technology, East China Normal University, 200062, Shanghai, China.

²School of Data Science and Engineering, East China Normal University, 200062, Shanghai, China.

³Information Technology Services, East China Normal University, 200062, Shanghai, China.

*Corresponding author(s). E-mail(s): wwu@cc.ecnu.edu.cn;
Contributing authors: jychen@ica.stc.sh.cn; lyshi@ica.stc.sh.cn;
52205901009@stu.ecnu.edu.cn; wxhu@cc.ecnu.edu.cn;
wzheng@admin.ecnu.edu.cn; lhe@cs.ecnu.edu.cn;

Abstract

Sequential recommendations have made great strides in accurately predicting the future behavior of users. However, persuading accuracy alone may bring side effects such as unfair and overspecialized recommendation results. In this work, we focus on the calibrated recommendations for sequential recommendation, which is connected to both fairness and diversity. On the one hand, it aims to provide fairer recommendations whose preference distributions are consistent with users' historical behaviors. On the other hand, it can improve the diversity of recommendations to a certain degree. But existing methods for calibration have mainly relied on the post-processing on the candidate lists, which require more computation time in generating recommendations. In addition, they normally sacrifice the accuracy to improve the calibration, because they fail to establish the relationship between accuracy and calibration. To handle these problems, we propose an end-to-end framework to provide both accurate and calibrated recommendations for sequential recommendation. We design an objective function to calibrate the interests between

recommendation lists and historical behaviors. Therefore, the sequential recommendation model can be trained by accuracy and calibration simultaneously, and generate calibrated recommendations without the post-processing stage. Moreover, we design a decoupled-aggregated model to improve the recommendation. The framework assigns two objectives to two individual sequence encoders, and aggregates the outputs by extracting useful information. Experiments on two benchmark datasets demonstrate the ability of our model to provide accurate and calibrated recommendations. Meanwhile, our model requires less response time than post-processing-based models, which is more efficient.

Keywords: Sequential Recommendation, Calibrated Recommendation, Fairness, Diversity

1 Introduction

Recommender systems aim to help users find their interests among large-scale items. In recent years, sequential recommendation has achieved great attention, which predicts users' future behaviors according to sequences of historical behaviors. Existing studies focus on modeling sequences, learning item transitions and obtaining accurate recommendations. The deep learning-based architectures, such as Recurrent Neural Networks and Graph Neural Networks, have progressed in sequential recommendation [1–3]. Until now, most studies have focused on obtaining high accuracy of recommendation lists. However, previous studies argue that recommendation algorithms should consider more than accuracy. For example, diversity [4–8], coverage [9–11], unexpectedness [12–14] and fairness [15, 16] are also important concepts in measuring a recommender system.

Among these concepts, diversity requires the recommender system to generate item lists that contain more item attributes (e.g., genres of movies), and a fair recommender can provide unbiased recommendation lists for consumers or providers. From these two perspectives, we focus on the calibration of sequential recommendation, which is related to diversity and fairness. The calibrated recommendation was first proposed in [17]. It aims to provide the recommendation list which reflects the user's historical behaviors [17]. For example, if a user has watched 70% action movies and 30% comedies, a fully calibrated recommendation list should also contain action and comedy movies with this ratio. Compared to diversity, it can also provide diversified recommendation lists to a certain degree [18]. The difference between calibration and diversity is that calibration limits the covered item attributes which follow the user's historical behaviors. It is a type of C-fairness according to the taxonomy proposed by [19], which is from the consumer's perspective. For users with similar historical interests, the calibrated recommendation model is able to provide recommendation lists with similar interest distributions. This somehow avoids bias and reflects the fairness of the recommendation system.

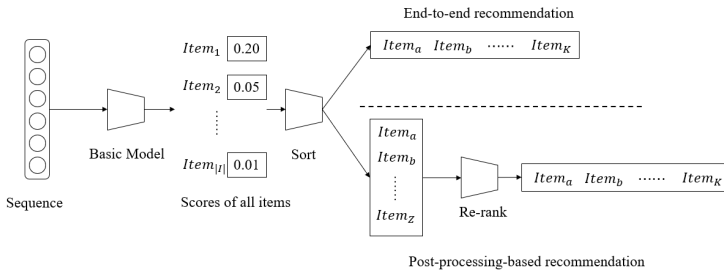

Fig. 1 An illustration of end-to-end and post-processing-based recommendation

Existing studies in calibrated recommendations adopt a post-processing paradigm, which ranks items from a candidate list that has been generated by a basic recommendation model such as neural collaborative filtering [17, 20, 21]. This is different from the end-to-end recommendation paradigm of sequential recommendation. As illustrated in Fig. 1, both end-to-end and post-processing-based models require predicted scores of all items. The difference is that the end-to-end models directly select the top-K items as final recommendations, while post-processing-based models apply a re-ranking stage on the top-Z ($Z > K$) items. For example, Kaya et al. [18] and Silva et al [21] generated calibrated recommendations based on the top-100 items provided by the basic algorithms. The advantage of post-processing-based approaches is that they can be applied to almost any recommendation model, because it only requires the items and scores of the candidate list generated by the base model. However, the post-processing-based models have two limitations. On the one hand, these models do not consider the relation between accuracy and calibration. The post-processing-based models make calibrated predictions based on the trained basic models which is optimized by the accuracy objective. In this scenario, accuracy and calibration are separate concepts, so that recommendation accuracy is limited by the trained basic model and considering calibration may sacrifice the accuracy. On the other hand, these models need more response time in generating recommendation lists because they have one more extra ranking stage than the end-to-end models. During the ranking stage, the items of the final recommendation list are decided step by step, in which the model needs to compute the gains of all candidates. Though the number of candidates can be much less than the size of the item set by selecting top-Z items, the ranking stage is still time-consuming.

To handle these problems, we focus on providing accurate and calibrated recommendation lists in an end-to-end framework. We propose a **Decoupled-Aggregated Calibrated Sequential Recommendation** framework, namely “**DACSR**”. First, we define a loss function for calibration to allow models can be optimized by accuracy and calibration simultaneously. We combine the prediction scores of all items and the item attribute information to estimate the distribution of the recommendation list. Then we use cosine similarity to measure the consistency between distributions of the recommendation

list and behavior sequence. With the designed loss function, the calibration is involved in the sequential recommendation model training and prediction paradigm, so that the model does not require an extra stage to re-rank the items. Next, to better capture the relation between accuracy and calibration, we propose a decoupled-aggregated framework to provide accurate and calibrated recommendations. We utilize two individual sequence encoders which only focus on accuracy and calibration, respectively. Then we concatenate the item embeddings and sequence representations, and obtain final representations of the sequence and items by an extractor network with a feed-forward network and residual connection. The scores of all items are computed by the final representations, and are optimized according to the weighted sum of accuracy and calibration loss functions.

The contributions of this paper are listed as follows:

- We propose an end-to-end framework to provide accurate and calibrated recommendation lists for sequential recommendation.
- We design a calibration loss function for model optimization, which aligns the preference distribution of recommendations to the historical distribution. In addition, we propose a decoupled-aggregated framework which aggregates information from individual sequence encoders which are optimized by calibration and accuracy separately.
- Experiments on benchmark datasets show that our model can achieve accurate and calibrated recommendations, with less time consumption than post-processing-based models.

The rest of this paper is organized as follows. We first review the existing literature in Sec. 2 and provide some preliminaries about sequential and calibrated recommendation in Sec. 2 and 3. Then we introduce our model in Sec. 4. We provide experimental settings in Sec. 5 and show results and analysis in Sec. 6. Finally, we discuss our work in Sec. 7 and conclude our paper and indicate some future work in Sec. 8.

2 Related Work

In this section, we provide a literature review of our work. We first introduce existing studies in sequential recommendation. Then we review the recent advances in calibrated recommendation.

2.1 Sequential Recommendation

Sequential recommendation relies on users' historical behavior sequences to predict their future behaviors. Existing studies focused on modeling sequences and obtained better sequence representations to achieve higher recommendation accuracy. Hidasi et al. [1] first utilized gated recurrent units for sequential recommendations and provided a parallel training strategy. Li et al. [22] further proposed an attention mechanism to capture the main purposes of the sequence. Tang et al. [23] utilized convolutional neural networks to

extract information from short-term sequences. With the development of self-attention, self-attentive-based models were proposed to achieve better sequence representations. For example, SASRec applied a self-attentive mechanism to learn both long-term and short-term preferences of user behavior sequences, which achieved satisfactory performance of recommendation accuracy [24]. Xu et al. [25] divided sequences into subsequences and captured users' long- and short-term preferences by applying two self-attention networks. In addition, transformer-based sequence encoders were proposed, such as BERT4Rec and Transformer4Rec [26, 27]. In recent years, graph neural networks were also utilized for sequential recommendation [2, 3, 28]. For example, Wu et al. [3] applied GGNN to learn item transitions from historical behaviors which treated sequences as graphs. In addition, multi-interest-based models were proposed that used multiple vectors to represent a sequence in order to disentangle users' diverse intentions [5, 6, 29, 30].

2.2 Calibrated Recommendation

Existing sequential recommendation models achieved satisfactory recommendation accuracy. From the concerns of fairness and filter bubble, we focus on the calibration of recommendation lists of sequential recommendation algorithms. In recent years, calibration was proposed, which aimed to generate recommendation lists whose preference distributions are less divergent with the users' profile [17]. Steck [17] also provided a post-processing greedy re-ranking model which considered both accuracy and calibration at each step of generating results. Abdollahpouri et al. [31] studied the connections between popularity bias and calibration. They found that users who are affected more by popularity bias tend to achieve less calibrated recommendation lists. Kaya and Bridge [18] compared intent-aware algorithms and calibration algorithms. They found that the diversity-oriented intent-aware models can achieve calibrated recommendations and calibration-oriented models can obtain diversity to some extent. Seymen et al. [20] proposed weighted total variation to measure the consistency between two distributions and a constrained optimization model to improve the ranking stage for calibration. Silva et al. [21] proposed new metrics to evaluate calibrated recommendations and adaptive selection strategies for the trade-off weight in the post-processing algorithms.

The calibration of recommendations is connected to two types of concepts. One is diversity, which aims to provide diversified recommendations for users. Persuading accuracy may lead to skewed recommendation lists which only focused on the main interest area of users, but users may be interested in diversified lists [17, 29]. Metrics that measures diversity are various, such as intra-list diversity (ILD) [4–6], coverage [7, 9, 10] and unexpectedness [12–14]. The calibrated recommendation algorithms constrained the recommendations to match the user's historical preference distribution, which can also improve diversity to a certain degree [18]. The calibration is also a type of fairness. Fairness in recommender systems aimed to provide unbiased results for users. From the perspective of stakeholder, it can be defined as C-fairness, P-fairness

and CP-fairness, which stand for consumers, providers, and the combination, respectively [19]. The calibrated recommender system can be treated as one of C-fairness [21]. The fairness is reflected by the less divergence of preference distributions between the user’s profile and the recommendation list.

Despite previous advances in calibrated recommendation, it still suffers from the following problems. First, existing methods for calibration required a post-processing stage to re-rank the candidate lists generated by basic recommendation models. Although these models can be used for almost all basic recommendation models, they require more computational time because the ranking process is time-consuming. In addition, the post-processing models may sacrifice accuracy to improve calibration, because they do not consider the relationship between accuracy and calibration. In our work, we would like to explore whether calibrated recommendations can be provided in an end-to-end way without post-processing. In addition, we investigate whether considering both calibration and accuracy can contribute to the performance of sequential recommendation.

3 Preliminary

3.1 The Sequential Recommendation Paradigm

The sequential recommendation predicts items that the user may interact in the future based on the user’s historical behavior sequence. In general, it can be decomposed into two parts, the sequence encoder and the prediction layer. The sequence encoder takes the historical behavior sequence as the input, and represents it to a vector. Formally, the procedure can be written as:

$$h = f(s | E^I, \theta, L) \quad (1)$$

where $f(\cdot)$ is the sequence encoder and h is the sequence representation of sequence s . E^I represents the item embedding matrix of all items I , and θ stands for the parameters of the sequence encoder. L is the loss function that is used to optimize the sequence encoder f .

The sequence representation h is further used to predict the score of all items. The prediction layer is usually a linear transformation layer:

$$\hat{y} = Wh^T + b \quad (2)$$

where W and b are $|I| \times d$ and $|I|$ dimensional learnable parameters. A common setting is that W is the item embedding matrix which is used in f and bias b is removed:

$$\hat{y} = E^I h^T \quad (3)$$

where E_I is the item embedding matrix. This prediction layer is widely used in existing studies [3, 22, 24, 25, 32], and we also follow this setting in our work. In our work, we select SASRec [24] as the basic sequence encoder, because

our goal is not to investigate modeling sequences and the SASRec model has achieved satisfactory performances in existing studies.

3.2 Preference Distributions

The calibrated recommendations aim to provide unbiased results, where preferences reflected from historical behaviors and recommendation lists are consistent. We use symbols $p(s)$ and $q(s)$ which stand for the preference distributions from historical behaviors and recommendation lists, respectively. We follow previous work which applied item attributes to define preference distributions [17], which are introduced below in detail.

- $p(s)$ is the preference distribution from the sequence s . For each attribute g , the distribution value is computed as:

$$p(g | s) = \frac{\sum_{x \in s} p(g | x)}{|s|} \quad (4)$$

where $p(g | x)$ is the indicator function of item x and attribute g , which satisfies $\sum_{g \in G} p(g | x) = 1$. If item x does not contain attribute g , the value of $p(g | x)$ is 0. If the item contains two attributes, the value of $p(g | x)$ equals to 0.5 for each attribute g . Finally, the preference distribution can be represented as a G -dimensional vector $\{p(g = 1 | x), p(g = 2 | x), \dots, p(g = G | x)\}$, where $|G|$ is the total amount of item attributes.

- $q(s)$ is the preference distribution of the recommendation list. For each attribute g , the distribution value is computed as:

$$q(g | RL) = \frac{\sum_{x \in RL} p(g | x)}{K} \quad (5)$$

where RL is the recommendation list, and K is the size of RL . Similar to $p(s)$, the distribution $q(s)$ can also be represented as a G -dimensional vector $\{q(g = 1 | x), q(g = 2 | x), \dots, q(g = G | x)\}$.

4 Methodology

In this section, we introduce our DACSR model in detail. We first introduce our proposed calibration loss function for end-to-end sequential recommendation. Then we introduce the Decoupled-Aggregated architecture in detail.

4.1 The Calibration Loss Function

Loss Function for Calibration To generate a calibrated recommendation list, we design the loss function for the model training. The calibration measures the consistency between the recommendation list and the historical sequence. The distribution of historical sequence $p(s)$ can be computed as Eq.

4. For the recommendation list, we estimate its preference distribution $\hat{q}(s)$ as follows:

$$\hat{q}(g | s) = \sum_i^{\|I\|} \hat{y}_i \cdot p(g | i) \quad (6)$$

$$\hat{y}_i = \text{softmax}(\hat{y}_i / \tau) \quad (7)$$

where \hat{y}_i is the score of the item i predicted by the model, and it is further processed by a softmax function. If an item has a higher prediction score, it contributes more to $\hat{q}(g | s)$. The softmax function also amplifies the difference in scores. Items with high scores will still be given higher weights, while weights of other items are close to 0. τ ($\tau > 0$) is the temperature parameter of softmax function. If $\tau < 1$, the score distribution becomes sharper and items with higher scores get more emphasis. In contrast, an extremely large value of τ will make the score distribution more uniform.

After estimating $\hat{q}(g | s)(g \in G)$, we define the loss function of calibration as:

$$L_{Calib}(I, \hat{y}) = 1 - \cos(\hat{q}(s), p(s)) \quad (8)$$

where $\hat{q}(s)$ is the estimated distribution vector $\{\hat{q}(g = 1 | s), \dots, \hat{q}(g = G | s)\}$ and $\cos()$ is the cosine similarity between two vectors. If the two distributions are more consistent, the value of L_{Calib} will be lower.

Calibration and Diversity However, a calibrated recommendation list is not always a diversified list (e.g., a user who only focused on a few types of items). If we want a diversified recommendation list to a certain degree, we can modify the distribution as follows:

$$p_d(s) = \text{softmax}(p(s) / \tau_{div}) \quad (9)$$

In this equation, the historical distribution $p(s)$ is normalized by a softmax function. For item attribute g that the user did not interacted (i.e., $p(g | s) = 0$), it will obtain a positive value. Therefore, all attributes are considered. The parameter τ_{div} is also used to control the distribution, similar to τ .

Loss Function for Accuracy and Calibration To obtain recommendation lists with accuracy and calibration, an intuitive way is directly optimizing the sequential recommendation model with a weighted sum of loss function:

$$L_w = (1 - \lambda) \times L_{Acc} + \lambda \times L_{Calib} \quad (10)$$

where $\lambda \in [0, 1]$ is the trade-off factor between accuracy and calibration. A higher value of λ means more consideration on calibration. L_{Acc} is the accuracy-based loss function. In our work, we choose the cross-entropy loss function:

$$L_{Acc}(y, \hat{y}) = \sum_{i=0}^{|I|} y_i \log(\hat{y}_i) \quad (11)$$

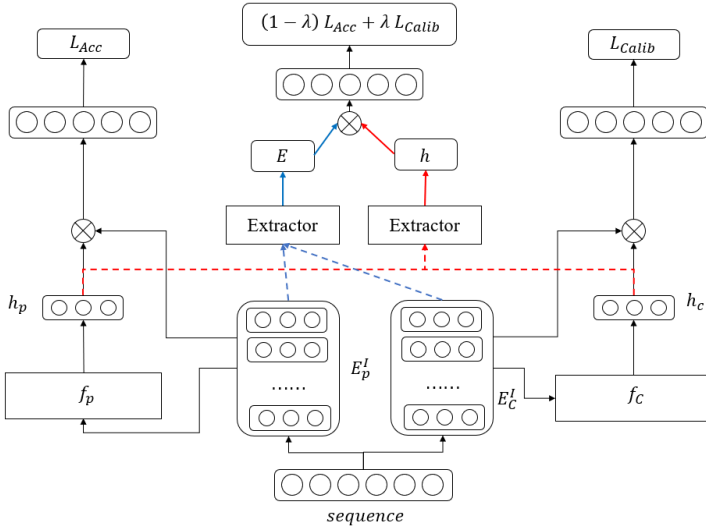

Fig. 2 The architecture of our DACSR model

where y and \hat{y} are the vectors of the ground-truth and predicted scores of all items, respectively. The y is an one-hot vector where $y_i = 1$ means item i is the next item of the sequence, and 0 otherwise.

4.2 The Decoupled-Aggregated Framework

Directly optimizing a sequence encoder by the weighted loss function may lead to a seesaw problem. For example, the performance of calibration increases by sacrificing the recommendation accuracy. Therefore, we propose our Decoupled-Aggregated framework, which includes two basic sequence encoders, as shown in Fig. 2. The two sequence encoders are optimized separately. One is to accurately predict the next behavior, while the other one is to provide a fully calibrated recommendation list. Formally, this can be represented as:

$$h_p = f_p(s | E_p^I, \theta_p, L_{Acc}) \quad (12)$$

$$h_c = f_c(s | E_c^I, \theta_c, L_{Calib}) \quad (13)$$

where f_p and f_c are two different sequence encoders with different parameters and objective functions. E_p^I and E_c^I are item embedding matrices of the two sequence encoders. θ_p and θ_c are their parameters. Note that the two encoders f_p and f_c do not share the same parameters and item embedding matrices, and are optimized by their unique loss functions L_{Acc} and L_{Calib} , respectively.

Next, we use the sequence representations and item embeddings of the two encoders to provide calibrated recommendation list. A direct way is to

concatenate the representations of two sequence encoders:

$$h_a = [h_p, h_c] \quad (14)$$

$$E_a^I = [E_p^I, E_c^I] \quad (15)$$

Based on this, we concatenated vectors are input to two extractor nets:

$$h_a = EX_{seq}^a([h_p, h_c]) \quad (16)$$

$$E_a^I = EX_{emb}^a([E_p^I, E_c^I]) \quad (17)$$

where $[\cdot]$ is the concatenation execution of two vectors or matrices. EX_{seq}^a and EX_{emb}^a are two extractor nets. The extractor net is a feed-forward network which can be defined as follows:

$$h^t = W^t \sigma(h^{t-1}) + b^t \quad (t = 1, 2, 3\dots) \quad (18)$$

where W^0, W^1, \dots, W^t and b^0, b^1, \dots, b^t are $2d \times 2d$ and $2d$ dimensional parameters need to learn (d is the dimension of hidden states). t is the number of layers in the extractor net. σ is the activation function. In our work, we use *ReLU* as the activation function. h_0 is the input of the feed-forward network (i.e., $[h_p, h_c]$ and $[E_p^I, E_c^I]$). Inspired by [33], we add the original input as the final representation:

$$h^t = h^t + h^0 \quad (19)$$

Finally, the scores of all items can be computed as:

$$\hat{y}_a = E_a^I h_a^T \quad (20)$$

which is similar to Eq. 3. We also use the weighted loss function L_w to optimize the model. In conclusion, the loss function of the DACSR model can be written as:

$$L = L_w(\hat{y}_a) + L_{Acc}(y, \hat{y}_p) + L_{Calib}(I, \hat{y}_c) \quad (21)$$

where \hat{y}_p and \hat{y}_c are scores of all items generated by f_p and f_c .

5 Experiments

5.1 Dataset

We adopted two commonly-used benchmark datasets to evaluate the performance of our model. The first one is Movielens-1m¹, which contains interaction logs of more than 6000 users and 3000 movies. The other is Tmall², which includes user behavior logs on an e-commerce platform. For both datasets, we sorted each user's behaviors according to the timestamp. We followed a 5-core strategy that removes the users and items whose number of occurrences is less

¹<https://grouplens.org/datasets/movielens/1m>

²<https://tianchi.aliyun.com/dataset/dataDetail?dataId=53>

Table 1 Statistics of Datasets

Statistics	MI-1m	Tmall
Number of users	6,040	31,854
Number of Items	3,883	58,343
Number of Training Sequences	981,504	832,603
Number of Testing Sequences	6,040	31,854
Number of Attributes	18	70
Average Length of Sequence	164.50	28.13

than 5. We also applied the leave-one-out evaluation protocol [24]. The latest clicked item of a user belongs to the testing set, and the previous one of this item belongs to the validation set. The remaining sequences construct the training set. To augment the training data, we extended the user's sequence following [3, 22]. We set the maximum sequence length equal to 200 and 100 for the MI-1m and Tmall dataset, respectively. The statistics are listed in Table 1.

5.2 Comparison Models

We selected the following methods as baselines:

- **SASRec** [24] is a self-attentive-based sequential recommendation model, and is a strong baseline. We apply the SASRec model as the sequence encoder for f_p and f_c , and compare our model with SASRec.
- **CaliRec** [17] is a post-processing model which re-ranks the results generated by the sequence encoder. It makes a trade-off between accuracy and calibration at each time step.
- **CaliRec-GC** [21] utilizes an adaptive selection for the trade-off factor. The higher coverage of item attributes of the user historical sequence results in more consideration for calibration.

5.3 Evaluation Metrics

We evaluate models from accuracy and calibration perspectives. Following previous work[3, 22], we use Recall and MRR as evaluation metrics to measure the recommendation accuracy of models.

- **Recall@K** (Rec@K) is a widely used metric in recommendation and information retrieval areas. Recall@K computes the proportion of correct items in the top-N items of the list.

$$Recall@K = \frac{1}{N} \sum_s 1(x_{n+1} \in RL_s) \quad (22)$$

where $1(\cdot)$ is an indication function whose value equals 1 when the condition in brackets is satisfied and 0 otherwise.

- **MRR@K** is another important metric that considers the rank of correct items. The score is computed by the reciprocal rank when the rank is within

N ; otherwise the score is 0.

$$MRR@K = \frac{1}{\|N\|} \sum_s \frac{1}{rank(x_{n+1}, RL_s)} \quad (23)$$

To evaluate the effectiveness in terms of calibration, we adopt C_{KL} which is a common metric used for calibrated recommendation [17]. The C_{KL} compares the consistency between two distribution:

$$C_{KL}(RL, s) = \frac{1}{N} \sum_s \sum_{g \in G} p(g | s) \frac{p(g | s)}{\tilde{q}(g | s)} \quad (24)$$

where N is the number of testing cases. The lower C_{KL} value means we provide more calibrated recommendation lists. To avoid the division-by-zero error, we use $\tilde{q}(g | s) = (1 - \alpha)(g | s) + \alpha p(g | s)$ to replace the original preference distribution $q(g | s)$. The value of α also equals to 0.01 according to [17, 18, 20, 21].

In addition, to better compare performances of our model and baseline models, we define the improvement as follows:

$$Improv. = \frac{Metric_{DACSR} - Metric_{Baseline}}{Metric_{Baseline}} \quad (25)$$

where *Metric* can be any metric mentioned above.

5.4 Experimental Setup

We fixed the dimension of sequence representations and item embeddings equal to 64 for the DACSR model. For a fair comparison, we set the dimension of hidden states of the SASRec model to 128, so that the numbers of parameters are close. The number of layers in the extractor net t of the DACSR model equals 2 for all datasets. We used the Adam [34] optimizer with the batch size of 256 and the learning rate of 0.001. We reported the performance under the model parameters with the optimal prediction accuracy on the validation set. We made hyper-parameter $\lambda = 0.5$ and $\tau = 1$ as the default setting, and analyzed their influence in following sections. To accelerate the training procedure, we initialized the parameters of sequence encoders used in our models by pre-trained parameters. For the top-K recommendation, we set $K = 10$ and 20 which is a common setting.

6 Results and Analysis

In this section, we provided results and analysis of our work. In general, we aimed to answer the following research questions:

- **RQ1** How the performances and efficiency of our DACSR model in achieving accurate and calibrated recommendation lists?

Table 2 Performances of our models and baselines (best performances are marked in bold)

Datasets	Metrics	SASRec	CaliRec	CaliRec-GC	DACSR
ML-1m	Rec@10	0.2627	0.2636	0.2225	0.2811
	MRR@10	0.1203	0.1101	0.0712	0.1267
	C_{KL} @10	1.2385	0.9722	0.4553	1.0615
	Rec@20	0.3613	0.3616	0.3258	0.3844
	MRR@20	0.1271	0.1168	0.0784	0.1338
	C_{KL} @20	0.8548	0.7322	0.3847	0.7262
Tmall	Rec@10	0.1451	0.1464	0.1454	0.1517
	MRR@10	0.0862	0.0846	0.0861	0.0857
	C_{KL} @10	2.5004	2.0710	2.4139	2.0114
	Rec@20	0.1749	0.1753	0.1751	0.1855
	MRR@20	0.0883	0.0866	0.0882	0.0881
	C_{KL} @20	2.1103	1.7943	2.0459	1.6240

- **RQ2** How the performances of our model change as the parameters change?
- **RQ3** How the modules of our DACSR model contribute to the performance improvement?
- **RQ4** What is the connection between calibration and diversity in our DACSR model?

6.1 RQ1: Overall Performance

In this section, we answer the research question RQ1 about whether our model can provide calibrated and accurate recommendations. The performances of baselines and our model are listed in Table 2, where the best performance is marked in bold.

Recommendation Accuracy We first analyze the performance from the perspective of accurate recommendation (i.e., Recall and MRR). In general, on both datasets, our model achieves the best prediction accuracy in terms of Recall and MRR. By considering calibration, users' preference distributions are incorporated. In addition, our model decoupled the two objectives by two sequence encoders and aggregated their outputs. Therefore, the preference distribution contributed to the prediction of the next item, leading to the improvement of accuracy. For example, on the ML-1m dataset, the Recall and MRR of our model are higher than the original SASRec model (e.g., 0.1338 v.s. 0.1271 in terms of MRR@20). In contrast, the post-processing-based models fragmented the relationship between accuracy and calibration and therefore resulted in a reduction in accuracy. For example, on the ML-1m dataset, the

MRR@20 of our model is 0.1338, while it is 0.1168 and 0.0784 for CaliRec and CaliRec-GC model, with the improvement of 18.67% and 74.66%, respectively. On the Tmall dataset, the CaliRec model also decreases the prediction accuracy.

Calibrated Recommendation Our model can provide more calibrated recommendation lists compared to the original sequential recommendation model. On both datasets, $C_{KL}@10$ and $C_{KL}@20$ of our model are lower than the original SASRec model. For example, the $C_{KL}@20$ of our model is 0.7262, which is 15.04% better than the 0.8548 of the SASRec model. On the Tmall dataset, our model also achieves a 23.04% improvement in terms of $C_{KL}@20$. Compared to the post-processing-based CaliRec model, our model still achieves competitive performances in terms of calibration. For example, on the ML-1m dataset, the performances of $C_{KL}@20$ of our model and the CaliRec model are 0.7262 and 0.7322. On the Tmall dataset, our model achieves an improvement of 9.49% in terms of $C_{KL}@20$. The comparisons show the ability of our model to achieve better accuracy while obtaining competitive performances of calibration compared to the post-processing-based models. As for the possible reasons, on the one hand, the proposed loss function calibrated the preference distribution of items with the highest scores to the historical preference distribution. On the other hand, the decoupled-aggregated framework ensures accuracy when improving the calibration.

We also observe that the CaliRec-GC model performs differently on the two datasets. On the ML-1m dataset, the CaliRec-GC model achieves the lowest C_{KL} value among all models, including our proposed model (e.g., 0.3847 v.s. 0.7262 of $C_{KL}@20$). While on the Tmall dataset, the CaliRec-GC model cannot provide calibrated recommendation lists. For example, the $C_{KL}@20$ of CaliRec-GC is 2.0459, which is close to the original SASRec model. We think this phenomenon results from two aspects. On the one hand, the number of item attributes of the Tmall dataset is much more than that of the ML-1m dataset. The ML-1m dataset contains 18 different item attributes, while the Tmall dataset has 70 attributes. On the other hand, the average length of the user behavior sequence of the Tmall dataset is less than the ML-1m dataset, as shown in Table 1. The shorter sequence and larger item attributes set lead to the lower coverage of item attributes. The CaliRec-GC model adopts an adaptive selection of the trade-off factor λ for calibration based on the coverage of item attributes. The greater coverage leads to the higher value of λ . Therefore, it performs best in terms of calibration on the ML-1m dataset, and almost does not work on the Tmall dataset.

The differences between the two datasets also lead to the different calibration performances of the two datasets. In general, performances of C_{KL} on the ML-1m dataset are better than the Tmall dataset. For example, the $C_{KL}@20$ of our DACSR model is 1.6240 on the Tmall dataset, which is much higher than the 0.7262 on the ML-1m dataset. This is similar for the original SASRec model, with 2.1103 v.s. 0.8548 on the two datasets. A possible reason is that the lower coverage of item attributes mentioned above results in the

Table 3 Average time consumption for each sequence.

Response time (10^{-4} s)	MI-1m	Tmall
<i>SASRec</i> _{D64}	2.67	1.40
<i>SASRec</i> _{D128}	5.55	2.48
CaliRec	580.15	668.69
DACSR	5.59	4.68

higher divergence. The large amount of 0 in $p(s)$ makes it difficult in achieving calibration, especially with the concern of accuracy.

Time Consumption In addition, we also compared the response time of our model against the post-processing based CaliRec model and the original SASRec model. We focused on the average time required to generate the recommended list for each sequence. For the SASRec model, we reported the time consumption when the dimension of hidden states equals to 64 and 128 (namely *SASRec*_{D64} and *SASRec*_{D128}). This is because the size 64 is the setting of each sequence encoder of our DACSR model. We conducted experiments on the same device, and removed the GPU acceleration for a fair comparison. The performance is listed in Table 3.

Compared to the original SASRec model, our model needs more computation. For example, on the MI-1m dataset, the time consumption for each sequence of the *SASRec*_{D64} model is 2.67×10^{-4} seconds, which is approximately half of our DACSR model. This is because it incorporates two SASRec encoders and an extraction net, which is more complex than the single SASRec model. In contrast, our model can provide more accurate and calibrated recommendations than the original SASRec model. The *SASRec*_{D128} requires more time than *SASRec*_{D64} because it contains larger scale of parameters. Compared to the CaliRec model, our model costs much less time to generate recommendation lists. For a single sequence, our model only needs 5.59 and 4.68×10^{-4} seconds on the MI-1m and Tmall datasets, respectively. In contrast, the CaliRec requires approximately 0.06 seconds for a sequence, which needs 200 times more time than our model. This is because the CaliRec model needs an extra ranking stage. The original SASRec model provided scores of all items, and selected top-100 items with the highest scores. The post-processing-based CaliRec model then re-ranks the top-100 items with K steps (K stands for the top-K recommendation). At each step, it computes the gains of the candidate items when they are added to the recommendation list. However, our model follows an end-to-end framework only with a sorting stage to select top-K items after the scores of all items are computed. Therefore, our model obtains better performance and requires less time consumption than the CaliRec model for each sequence.

Generalization of DACSR Model We are also interested in whether our model is also effective when the sequence encoder changes. We incorporated the GRU4Rec model [1] as the sequence encoder, which is also a widely used sequential recommendation model. The experimental settings were same to the previous section with $\lambda = 0.5$. We use DACSR(G) to denote our DACSR

model which takes GRU4Rec as the sequence encoder, and CaliRec(G) to denote the post-processing-based CaliRec model with candidates provided by the GRU4Rec model. The performances are listed in Table. 4.

As shown in the table, our model can still achieve calibrated and accurate recommendation lists when we use GRU4Rec as the sequence encoder. On the Ml-1m dataset, the performances of $C_{KL}@20$ are 0.6840 and 0.8356 of our DACSR(G) model and the GRU4Rec model, respectively. On the Tmall dataset, our model also obtains an improvement of 21.95% in terms of calibration. Toward recommendation accuracy, the performances of our model are still better than the original GRU4Rec model. The improvement is not as great as the DACSR model with the SASRec sequence encoder. We think that this is because the ability to model sequences of GRU4Rec is worse than that of the SASRec model. The SASRec model with self-attention mechanisms can better find the user’s preference and represent the sequence. The CaliRec(G) model also sacrificed the ranking performance to improve the calibration, which is similar to the CaliRec model with the SASRec model. Compared to the CaliRec(G) model, our DACSR(G) model can also achieve better performance in terms of accuracy and calibration, as listed in Table. 4. The performance comparisons indicates that our model can be used to other basic sequence encoders, which is not specifically designed for the SASRec model.

Table 4 Performances of our DACSR(G) model with the GRU4Rec sequence encoder (best performances are marked in bold).

Dataset	Method	Rec@20	MRR@20	$C_{KL}@20$
Ml-1m	GRU4Rec	0.346	0.1142	0.8356
	CaliRec(G)	0.3454	0.1105	0.7013
	DACSR(G)	0.3472	0.1161	0.6840
Tmall	GRU4Rec	0.1724	0.0863	2.2123
	CaliRec(G)	0.1732	0.0846	1.8597
	DACSR(G)	0.1750	0.0878	1.7266

6.2 RQ2: Parameter Influence

In this section, we answer the research question RQ2 about the influence of hyperparameters. Specifically, we investigate the two hyperparameters λ and τ (see Sec. 4.1). The trade-off parameter λ controlled the importance of calibration during the optimization stage of our model. The parameter τ reshaped the predicted scores of all items, which can affect the computation of the calibration loss function.

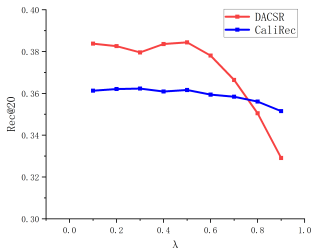

(a) Rec@20 on the ML-1m dataset

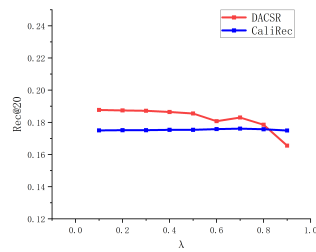

(b) Rec@20 on the Tmall dataset

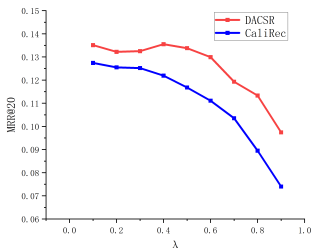

(c) MRR@20 on the ML-1m dataset

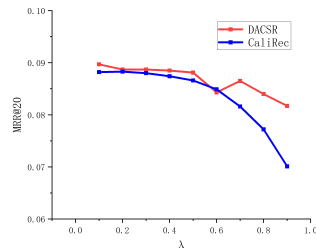

(d) MRR@20 on the Tmall dataset

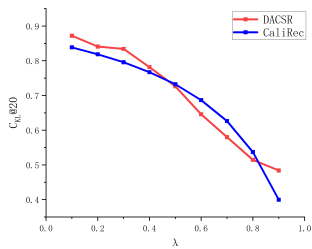
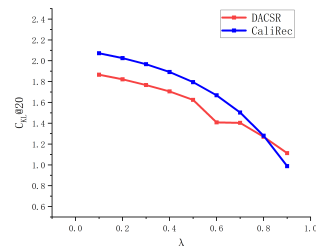
(e) $C_{KL}@20$ on the ML-1m dataset(f) $C_{KL}@20$ on the Tmall dataset**Fig. 3** Performance comparison when λ changes.

6.2.1 Trade-off Factor λ

We first analyze the influence of hyperparameter λ by changing it from 0.1 to 1.0. Since the CaliRec model also required a parameter to control the importance of calibration and accuracy which was similar to our model, we displayed the changes in the performance of our DACSR model and compared it with the CaliRec model simultaneously. The performances on the two datasets are shown in Fig. 3, where red lines and blue lines represent our DACSR model and the CaliRec model, respectively.

In general, a greater value of λ leads to a lower recommendation accuracy and higher calibration. When λ has a high value (e.g., $\lambda = 0.7$), the performance of Rec@20 of our model decreases greatly, while the CaliRec model does not decrease as large as our model. A possible reason is the difference in the process of generating recommendation lists. The CaliRec re-ranks the candidate list generated by the SASRec model whose size is 100 and finally selects top-K ($K = 10$ or 20) items as the final recommendation list. However, our model computes scores of all items, and directly selects top-K items. For some sequences, the users' next items achieve relatively lower ranks. When considering more for calibration, these items may be replaced by items whose attributes are consistent with the historical distributions but not sequential correlated to the sequences. While for post-processing methods, the range of items for re-ranking is narrowed. Therefore, it can preserve the performance of Rec@20. In contrast, our model outperforms CaliRec when considering ranking performances in terms of MRR. As shown in Fig. 3(c) and 3(d), the MRR@20 of our model is always higher than the CaliRec model. This is because although target items may be replaced, these items do not contribute to the ranking performance greatly. In contrast, our model improves the ranking of the target items for most of the sequences, resulting in an improvement in overall ranking performance.

In terms of calibration, our model achieves better performances compared to the CaliRec model under the same λ in general. On the Tmall dataset, the performances of calibration of our DACSR model are better than the CaliRec model during the major changing process of λ . On the MI-1m dataset, the performances are close. Our model performs better than the CaliRec model when λ is greater than 0.5. When λ is close to 1, our DACSR model cannot perform as well as the CaliRec model. A possible reason is that the CaliRec model utilized a greedy-based ranking strategy so that it can select the most calibrated recommendations from top-100 items when λ is close to 1. In contrast, the deep learning-based optimization strategy always have gap in fitting the target distribution and therefore do not perform as well as the CaliRec model at very high values of λ . However, a large λ leads to lower recommendation accuracy. Though it achieves better calibration, it is not suggested to use high value of λ because accurately predicting the user's next behavior is still an important concern.

6.2.2 Temperature Factor τ

In this section, we analyze the influence of parameter τ , which controls the sharpness of the distribution in the calibration loss function. We tune τ in $\{0.25, 0.5, 0.75, 1.0, 1.25, 1.5, 1.75, 2.0\}$, and show the performances in Fig. 4. Red lines represent the performance of $MRR@20$ and correspond to the right axis, and green lines stand for the $C_{KL}@20$ performance which follows the left axis.

On the two datasets, a relatively lower value of τ can achieve a better performance of calibration and lower accuracy in general. For example, on the

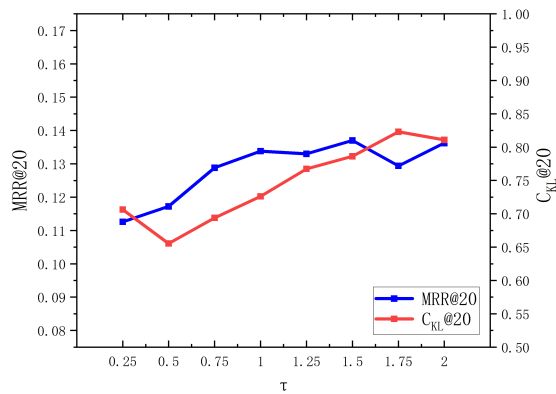

(a) Performance change on the MI-1m dataset

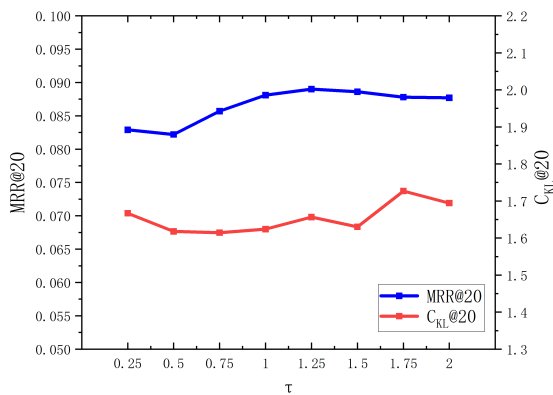

(b) Performance change on the Tmall dataset

Fig. 4 Performance comparison when τ changes.

MI-1m dataset, the $C_{KL}@20$ performances are 0.6466 and 0.6915 when τ equals to 0.25 and 1.0 respectively. This is because a lower value of τ amplifies the scores of top items, and other items are ignored because their scores are normalized to 0. The lower value of τ increases the calibration, but decreases the recommendation accuracy as shown by blue lines in Fig. 4. In contrast, a higher value of τ ($\tau > 1$) causes a negative impact on calibration, because scores of all items are normalized to close values (i.e., $1/|I|$ for all items). Therefore, no useful information for calibration can be propagated to the model.

6.3 RQ3: Ablation Studies

To answer the research question RQ3, we conduct ablation experiments in this section by comparing our model with two variants. The first variant is the original SASRec model optimized by the loss function L_w . We aim to investigate the performance of a single sequence encoder optimized by both accuracy and calibration. We also reported the performances when the dimension of hidden states equals to 64 and 128 (namely $SASRec_{D64}^{L_w}$ and $SASRec_{D128}^{L_w}$). The other one is the direct concatenation of sequence representations and item embedding matrices without extraction nets (namely DACSR-C). We compare our model with these variants by setting $\lambda = 0.5$. The performances are listed in Table 5. In general, our DACSR model obtains the best performance in terms of recommendation accuracy and calibration.

The effectiveness of our designed loss function for calibration can be reflected by the performance of $SASRec_{D64}^{L_w}$ and $SASRec_{D128}^{L_w}$. By applying the loss function L_w , the SASRec model is able to provide more calibrated recommendation lists than the original SASRec model only optimized by L_{Acc} . For example, the $C_{KL}@20$ of SASRec on the Tmall dataset decreases from 2.1103 to 1.8845. Also it achieves close performance compared to our DACSR model on the MI-1m dataset in terms of calibration.

Table 5 Performance comparisons between our DACSR model and its variants (best performances are marked in bold)

Dataset	Metrics	$SASRec_{D64}^{L_w}$	$SASRec_{D128}^{L_w}$	DACSR-C	DACSR
MI-1m	Rec@10	0.2551	0.2730	0.2710	0.2811
	MRR@10	0.1088	0.1206	0.1187	0.1267
	$C_{KL}@10$	1.0780	1.0765	1.0909	1.0615
	Rec@20	0.3599	0.3657	0.3719	0.3844
	MRR@20	0.1161	0.1269	0.1257	0.1338
	$C_{KL}@20$	0.7281	0.7253	0.7433	0.7262
Tmall	Rec@10	0.1508	0.1482	0.1464	0.1517
	MRR@10	0.0854	0.0862	0.0813	0.0857
	$C_{KL}@10$	2.1490	2.2499	1.9816	2.0114
	Rec@20	0.183	0.1787	0.1804	0.1855
	MRR@20	0.0876	0.0884	0.0837	0.0881
	$C_{KL}@20$	1.7810	1.8845	1.5960	1.6240

To demonstrate the effectiveness of decoupled-aggregated framework, we compare the performances of DACSR-C and $SASRec_{D64}^{L_w}$ model in Table 5.

On the MI-1m dataset, the DACSR-C model achieves higher recommendation accuracy and close calibration performances compared to the $SASRec_{D64}^{L_w}$ model. On the Tmall dataset, although the performance of accuracy is lower than the $SASRec_{D64}^{L_w}$ model (e.g. 0.0813 v.s. 0.0854 with the improvement of -4.80%), the DACSR-C model can achieve more calibrated recommendation lists (1.5960 v.s. 1.7810 with the improvement of 10.39%). By concatenating the two sequence encoders, the model contains more parameters, so that the performances are improved. On the MI-1m dataset, the DACSR-C model performs closely to the $SASRec_{D128}^{L_w}$ model. While on the Tmall dataset, it improves the calibration performance but sacrifices the accuracy.

Finally, our DACSR model further outperforms the DACSR-C model. For example, on the MI-1m dataset, the $MRR@20$ of our DACSR model is 0.1338, while it is 0.1257 for the DACSR-C model. The performance comparison is similar on the Tmall dataset. In terms of calibration, on the MI-1m dataset, the $C_{KL}@20$ of DACSR model is 0.7262, which is slightly better than the 0.7433 of the DACSR-C model. While on the Tmall dataset, our model achieves 1.6240, which is slightly worse than the 1.5960 of the DACSR-C model. Compared to the $SASRec_{D128}^{L_w}$ model, our DACSR model also obtains better performances. The comparison shows that the extraction net is useful in capturing information from two sequence encoders for accurate and calibrated recommendation. We believe that the model is able to establish a link between accuracy and calibration with the two optimisation objectives working together, and therefore the performance of the model is improved.

6.4 RQ4: Calibration and Diversity

As mentioned above, calibration is connected to diversity to a certain degree. Therefore, it is necessary to investigate the relation between the two concepts under the end-to-end recommendation framework. We first compared the diversity of recommendations of our DACSR model and the original SASRec model. We adopted the ILD metric with Jaccard similarity to measure the diversity of the recommendation list:

$$ILD(s) = \frac{2}{|RL_s| (|RL_s| - 1)} \sum_{(i,j \in RL_s)} \left(1 - \frac{|Attr_i \cap Attr_j|}{|Attr_i \cup Attr_j|} \right) \quad (26)$$

where $Attr_i$ is the item attribute set that the item i has, and RL_s is the generated recommendation list for sequence s . The larger ILD value represents the higher diversity of the recommendation list. To improve the diversity, we replaced the user's historical distribution $p(s)$ with the diversified distribution $p_d(s)$ (see Eq. 9) when calculating the loss function L_w . We set the factor $\tau_{div} = 0.5$ on the two datasets. We listed the performances of our DACSR model with the raw historical preference distribution (namely DACSR- $p(s)$) and the normalized preference distribution (namely DACSR- $p_d(s)$) along with the original SASRec model in Table 6.

Table 6 Performances of calibration and diversity (best performances are marked in bold)

Datasets	Models	ILD@10	$C_{KL}@10$	ILD@20	$C_{KL}@20$
MI-1m	SASRec	0.6356	1.3029	0.6584	0.9045
	DACSR- $p(s)$	0.6593	1.0303	0.6736	0.7046
	DACSR- $p_d(s)$	0.7012	1.1347	0.7123	0.7649
Tmall	SASRec	0.7086	2.4871	0.7405	2.1092
	DACSR- $p(s)$	0.6714	2.0114	0.7045	1.624
	DACSR- $p_d(s)$	0.7419	2.2662	0.7725	1.8412

On the two datasets, the diversity of our model is improved by sacrificing the calibration. For example, on the MI-1m dataset, the performances of $ILD@10$ are 0.7012 and 0.6593 for the normalized distribution $p_d(s)$ and the original distribution $p(s)$, respectively. However, the $C_{KL}@10$ increases from 1.0303 to 1.1347, which means the ability of calibration of our model is weakened. On the Tmall dataset, the performance comparisons are similar. This is because applying the normalized distribution amplifies the effect of item attributes that the user did not interacted in the behavior sequence. Though it does not largely affect the true distribution $p(s)$, it deviates from the calibration to a certain degree.

We also observe that our DACSR model performed differently on the two datasets. On the MI-1m dataset, the diversity is higher for our DACSR model than the original SASRec model, while it is totally different on the Tmall dataset. On the Tmall dataset, our DACSR model achieves worse performance in terms of diversity (e.g., 0.6714 v.s. 0.7086 of DACSR and SASRec model). It is possibly due to the difference between two datasets. On the MI-1m dataset, the coverage of item attributes is higher than the Tmall dataset. Users have more historical behaviors than the Tmall dataset. On the Tmall dataset, users always interacted with several types of items, so that the $p(g | s)$ score of most attributes equals to 0. The limited interest areas resulted in less diversified recommendation lists under the calibration objective. We also find that there are some imbalanced cases on the Tmall dataset. As illustrated in Fig. 5(a), the attribute A occupies the 80% of the sequence, while attribute B and C only account for the 20%. For such an imbalanced distribution, our DACSR model amplifies the major attribute, as shown in Fig. 5(b). The recommended list only contains items with attribute A . This gives our model a negative impact in terms of diversity.

In conclusion, the relationship between calibration and diversity varies from person to person. For users with homogeneous interests, our model amplifies the effect of the imbalanced distribution. By applying the normalized preference distribution, our model increases the diversity by sacrificing the calibration. We proposed a way to provide diversified recommendations for these users under the constraint of calibration. However, whether it is necessary

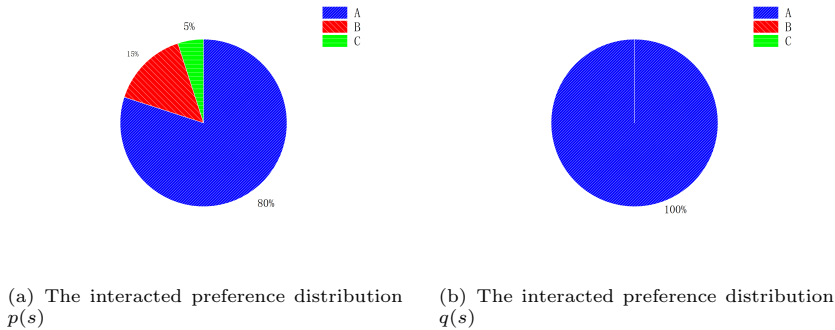

Fig. 5 A case of the imbalanced preference distribution and the overwhelming recommendation list.

to provide these users with diversified recommendations is a question worth investigating.

7 Discussion

In this paper, we proposed the DACSR model to provide accurate and calibrated recommendation lists for end-to-end sequential recommendation. We conducted experiments on benchmark datasets to demonstrate the effectiveness of our model. By applying the calibration loss function, the sequential recommendation models became aware of preference distribution of recommended items, and aligned it to the historical preference distribution. Therefore, the process of training and prediction was conducted in an end-to-end paradigm. With the decoupled-aggregated framework, the positive information for calibrated and accurate recommendation was extracted from two individual sequence encoders to improve the performance. Compared to the post-processing-based CaliRec model, our model achieved better performance in terms of calibration and accuracy, because the training process considers the relationship between calibration and accuracy, which was isolated in post-processing-based models. Meanwhile, the end-to-end framework required much less time for providing recommendations than the post-process-based models. Because calibration is connected to diversity to a certain degree, we also analyzed the diversity performance of our model. We found that it differed on the two datasets because of the item attribute coverage and the length of the sequence. For sequences with homogeneous preferences, considering calibration reduced the diversity of recommendations. Therefore, we normalized the preference distribution with a temperature factor to make a trade-off between calibration and diversity. However, there are some limitations in our work:

- Our model assigned the objectives of accuracy and calibration to two individual sequence encoders, and combined them with an extraction net to make accurate and calibrated recommendation lists. This structure requires more parameters and time for computation than a single sequence encoder.

It should be worth exploring cleaner models with fewer parameters in the future.

- We proposed the DACSR model to improve the accurate and calibrated sequential recommendation, but we did not investigate the reasons that cause the miscalibration. For example, previous work has shown there exists correlations between popularity bias and miscalibration [31]. Besides popularity bias, it is worth investigating other factors that may cause miscalibration, and incorporating them to improve the performance.

8 Conclusion and Future Work

In this paper, we were committed to exploring the provision of accurate and calibrated recommendation lists based on user behavioural sequences. We proposed a DACSR model to provide accurate and calibrated results for end-to-end sequential recommendation. Specifically, we designed a loss function that estimates the preference distribution of the recommendation list by predicted scores of all items, and measures the consistency with the preference distribution of historical behaviors. In addition, we proposed a decoupled-aggregated framework which includes two individual sequence encoders that were assigned with the accuracy and calibration objectives, respectively. Then we utilized an aggregation module to extract information from two sequence encoders to make both accurate and calibrated recommendations. By experiments on benchmark datasets, our model can achieve better accuracy and calibration than the original sequence encoder and the post-processing methods. The ablation studies proved the effectiveness of the general architecture and the extractor net of our model. Finally, we investigated the connection between calibration and diversity, and balanced them by normalizing the historical preference distribution.

For the future work, we first want to explore the cleaner sequence encoder with fewer parameters. Specifically, we focus on the advanced training paradigm rather than the traditional sequence-to-item paradigm to improve the calibrated sequential recommendation. On one hand, we aim to follow the distillation paradigm, which learns useful information from our DACSR model to make the basic sequence encoder more accurate and calibrated. On the other hand, we also want to explore data augmentation and apply contrastive learning to debias the sequential recommendation models. In addition, different from lighter models, we aim to extend our decoupled-aggregated framework by designing more complex models to achieve better performance of accuracy and calibration. Finally, we are also interested in exploring the reasons that cause the miscalibration, and apply them with causal inference to obtain calibrated recommendations.

Declarations. This work is funded by National Natural Science Foundation of China (under project No. 61907016) and Science and Technology Commission of Shanghai Municipality, China (under project No. 19511120200 and No. 21511100302) for sponsoring the research work. All authors certify that they

have no affiliations with or involvement in any organization or entity with any financial interest or non-financial interest in the subject matter or materials discussed in this manuscript.

References

- [1] Hidasi, B., Karatzoglou, A., Baltrunas, L., Tikk, D.: Session-based recommendations with recurrent neural networks. In: Proceedings of the International Conference on Learning Representations, ICLR 2016 (2016)
- [2] Chang, J., Gao, C., Zheng, Y., Hui, Y., Niu, Y., Song, Y., Jin, D., Li, Y.: Sequential recommendation with graph neural networks. In: Proceedings of the ACM SIGIR Conference on Research and Development in Information Retrieval, SIGIR, 2021, pp. 378–387 (2021). <https://doi.org/10.1145/3404835.3462968>
- [3] Wu, S., Tang, Y., Zhu, Y., Wang, L., Xie, X., Tan, T.: Session-based recommendation with graph neural networks. In: Proceedings of the AAAI Conference on Artificial Intelligence, AAAI 2019, pp. 346–353 (2019). <https://doi.org/10.1609/aaai.v33i01.3301346>
- [4] Huang, J., Zhao, W.X., Dou, H., Wen, J.-R., Chang, E.Y.: Improving sequential recommendation with knowledge-enhanced memory networks. In: Proceedings of the International ACM SIGIR Conference on Research & Development in Information Retrieval, SIGIR 2018, pp. 505–514 (2018). <https://doi.org/10.1145/3209978.3210017>
- [5] Lu, Y., Zhang, S., Huang, Y., Wang, L., Yu, X., Zhao, Z., Wu, F.: Future-aware diverse trends framework for recommendation. In: Proceedings of the World Wide Web Conference, WWW, 2021, pp. 2992–3001 (2021). <https://doi.org/10.1145/3442381.3449791>
- [6] Cen, Y., Zhang, J., Zou, X., Zhou, C., Yang, H., Tang, J.: Controllable multi-interest framework for recommendation. In: Proceedings of the ACM SIGKDD Conference on Knowledge Discovery and Data Mining, SIGKDD, 2020, pp. 2942–2951 (2020). <https://doi.org/10.1145/3394486.3403344>
- [7] Zheng, Y., Gao, C., Chen, L., Jin, D., Li, Y.: DGCN: diversified recommendation with graph convolutional networks. In: Proceedings of the World Wide Web Conference, WWW, 2021, pp. 401–412 (2021). <https://doi.org/10.1145/3442381.3449835>
- [8] Parapar, J., Radlinski, F.: Towards unified metrics for accuracy and diversity for recommender systems. In: Proceedings of the ACM Conference on Recommender Systems, Recsys, 2021, pp. 75–84 (2021). <https://doi.org/10.1145/3460231.3474234>

- [9] Liu, S., Zheng, Y.: Long-tail session-based recommendation. In: Proceedings of the ACM Conference on Recommender Systems, RecSys 2020, pp. 509–514 (2020). <https://doi.org/10.1145/3383313.3412222>
- [10] Kim, Y., Kim, K., Park, C., Yu, H.: Sequential and diverse recommendation with long tail. In: IJCAI 2019, pp. 2740–2746 (2019)
- [11] Sreepada, R.S., Patra, B.K.: Mitigating long tail effect in recommendations using few shot learning technique. *Expert Systems with Applications*. **140** (2020). <https://doi.org/10.1016/j.eswa.2019.112887>
- [12] Chen, L., Yang, Y., Wang, N., Yang, K., Yuan, Q.: How serendipity improves user satisfaction with recommendations? A large-scale user evaluation. In: Proceedings of the World Wide Web Conference, WWW, 2019, pp. 240–250 (2019). <https://doi.org/10.1145/3308558.3313469>
- [13] Xu, Y., Yang, Y., Wang, E., Han, J., Zhuang, F., Yu, Z., Xiong, H.: Neural serendipity recommendation: Exploring the balance between accuracy and novelty with sparse explicit feedback. *ACM Transactions on Knowledge Discovery from Data* **14**(4), 50–15025 (2020). <https://doi.org/10.1145/3396607>
- [14] Li, P., Que, M., Jiang, Z., Hu, Y., Tuzhilin, A.: PURS: personalized unexpected recommender system for improving user satisfaction. In: Proceedings of the ACM Conference on Recommender Systems, Recsys, 2020, pp. 279–288 (2020). <https://doi.org/10.1145/3383313.3412238>
- [15] Dai, E., Wang, S.: Say no to the discrimination: Learning fair graph neural networks with limited sensitive attribute information. In: Proceedings of the ACM International Conference on Web Search and Data Mining, WSDM, 2021, pp. 680–688 (2021). <https://doi.org/10.1145/3437963.3441752>
- [16] Ge, Y., Liu, S., Gao, R., Xian, Y., Li, Y., Zhao, X., Pei, C., Sun, F., Ge, J., Ou, W., Zhang, Y.: Towards long-term fairness in recommendation. In: Proceedings of the ACM International Conference on Web Search and Data Mining, WSDM, 2021, pp. 445–453 (2021). <https://doi.org/10.1145/3437963.3441824>
- [17] Steck, H.: Calibrated recommendations. In: Proceedings of the ACM Conference on Recommender Systems, RecSys 2018, pp. 154–162 (2018). <https://doi.org/10.1145/3240323.3240372>
- [18] Kaya, M., Bridge, D.G.: A comparison of calibrated and intent-aware recommendations. In: Bogers, T., Said, A., Brusilovsky, P., Tikk, D. (eds.) Proceedings of the ACM Conference on Recommender Systems, Recsys, 2019, pp. 151–159 (2019). <https://doi.org/10.1145/3298689.3347045>

- [19] Burke, R.: Multisided fairness for recommendation. CoRR **abs/1707.00093** (2017)
- [20] Seymen, S., Abdollahpouri, H., Malthouse, E.C.: A constrained optimization approach for calibrated recommendations. In: Proceedings of the ACM Conference on Recommender Systems, Recsys, 2021, pp. 607–612 (2021). <https://doi.org/10.1145/3460231.3478857>
- [21] da Silva, D.C., Manzato, M.G., Durão, F.A.: Exploiting personalized calibration and metrics for fairness recommendation. Expert Syst. Appl. **181**, 115112 (2021). <https://doi.org/10.1016/j.eswa.2021.115112>
- [22] Li, J., Ren, P., Chen, Z., Ren, Z., Lian, T., Ma, J.: Neural attentive session-based recommendation. In: Proceedings of the ACM on Conference on Information and Knowledge Management, CIKM 2017, pp. 1419–1428 (2017). <https://doi.org/10.1145/3132847.3132926>
- [23] Tang, J., Wang, K.: Personalized top-n sequential recommendation via convolutional sequence embedding. In: Proceedings of the ACM International Conference on Web Search and Data Mining, WSDM, 2018, pp. 565–573 (2018). <https://doi.org/10.1145/3159652.3159656>
- [24] Kang, W., McAuley, J.J.: Self-attentive sequential recommendation. In: Proceedings of the IEEE International Conference on Data Mining, ICDM, 018, pp. 197–206 (2018). <https://doi.org/10.1109/ICDM.2018.00035>
- [25] Xu, C., Feng, J., Zhao, P., Zhuang, F., Wang, D., Liu, Y., Sheng, V.S.: Long- and short-term self-attention network for sequential recommendation. Neurocomputing **423**, 580–589 (2021). <https://doi.org/10.1016/j.neucom.2020.10.066>
- [26] Sun, F., Liu, J., Wu, J., Pei, C., Lin, X., Ou, W., Jiang, P.: Bert4rec: Sequential recommendation with bidirectional encoder representations from transformer. In: Proceedings of the International Conference on Information and Knowledge Management, CIKM, 2019, pp. 1441–1450 (2019). <https://doi.org/10.1145/3357384.3357895>
- [27] de Souza Pereira Moreira, G., Rabhi, S., Lee, J.M., Ak, R., Oldridge, E.: Transformers4rec: Bridging the gap between NLP and sequential / session-based recommendation. In: Proceedings of the ACM Conference on Recommender Systems, Recsys, 2021, pp. 143–153 (2021). <https://doi.org/10.1145/3460231.3474255>
- [28] Wang, Z., Wei, W., Cong, G., Li, X., Mao, X., Qiu, M.: Global context enhanced graph neural networks for session-based recommendation. In: Proceedings of the International ACM SIGIR Conference on Research and

- Development in Information Retrieval, SIGIR 2020, pp. 169–178 (2020). <https://doi.org/10.1145/3397271.3401142>
- [29] Chen, W., Ren, P., Cai, F., Sun, F., de Rijke, M.: Improving end-to-end sequential recommendations with intent-aware diversification. In: Proceedings of the International Conference on Information and Knowledge Management, CIKM, 2020, pp. 175–184 (2020). <https://doi.org/10.1145/3340531.3411897>
- [30] Tan, Q., Zhang, J., Yao, J., Liu, N., Zhou, J., Yang, H., Hu, X.: In: Proceedings of the ACM International Conference on Web Search and Data Mining, WSDM, 2021, pp. 598–606 (2021). <https://doi.org/10.1145/3437963.3441811>
- [31] Abdollahpouri, H., Mansoury, M., Burke, R., Mobasher, B.: The connection between popularity bias, calibration, and fairness in recommendation. In: Proceedings of the ACM Conference on Recommender Systems, Recsys, 2020, pp. 726–731 (2020). <https://doi.org/10.1145/3383313.3418487>
- [32] Zhang, L., Wang, P., Li, J., Xiao, Z., Shi, H.: Attentive hybrid recurrent neural networks for sequential recommendation. *Neural Computing and Applications* **33**(17), 11091–11105 (2021). <https://doi.org/10.1007/s00521-020-05643-7>
- [33] He, K., Zhang, X., Ren, S., Sun, J.: Deep residual learning for image recognition. In: Proceedings of the IEEE Conference on Computer Vision and Pattern Recognition, CVPR, 2016, pp. 770–778 (2016). <https://doi.org/10.1109/CVPR.2016.90>
- [34] Kingma, D.P., Ba, J.: Adam: A method for stochastic optimization. In: Proceedings of the International Conference on Learning Representations, ICLR 2015 (2015)