

Efficient Table-based Function Approximation on FPGAs using Interval Splitting and BRAM Instantiation

CHETANA PRADHAN, MARTIN LETRAS, and JÜRGEN TEICH,

Hardware/Software Co-Design, Department of Computer Science

Friedrich-Alexander-Universität Erlangen-Nürnberg (FAU)

This paper proposes a novel approach for the generation of memory-efficient table-based function approximation circuits for FPGAs. Given a function $f(x)$ to be approximated in a given interval $[x_0, x_0 + a]$ and a maximum approximation error E_a , the goal is to determine a function table implementation with a minimized memory footprint, i.e., number of entries that need to be stored. Rather than state-of-the-art work performing an even sampling of the given interval by so-called breakpoints and using linear interpolation between two adjacent breakpoints to determine $f(x)$ at the maximum error bound, first, we propose three interval-splitting algorithms to reduce the required memory footprint drastically based on the observation that in sub-intervals of low gradient, a coarser sampling grid may be assumed to satisfy the maximum interpolation error bound. Experiments on elementary mathematical functions show that a large fraction in memory footprint may be saved. Second, a hardware architecture implementing the sub-interval selection, breakpoint lookup and interpolation at a latency of just 9 clock cycles is introduced. Third, within each generated circuit design, BRAMs are automatically instantiated rather than synthesizing the reduced footprint function table using LUT primitives providing an additional degree of resource efficiency.

CCS Concepts: • **Hardware** → **Power and energy**; • **Computer systems organization** → **Embedded hardware**.

Additional Key Words and Phrases: FPGA, Approximate Computing, Function Approximation, BRAM

ACM Reference Format:

Chetana Pradhan, Martin Letras, and Jürgen Teich. 2022. Efficient Table-based Function Approximation on FPGAs using Interval Splitting and BRAM Instantiation. *ACM Trans. Embedd. Comput. Syst.* 1, 1, Article 1 (April 2022), 23 pages. <https://doi.org/10.1145/nnnnnnn.nnnnnnn>

1 INTRODUCTION

Approximate computing [21] is a new research field that investigates the trade-off between accuracy, latency, energy [11, 21], and cost of computations. Fig. 1 presents a comparison between approximate computing and conventional computing. Here, approximate computing primes high-performance at the expense of low accuracy. For example, many applications like video and image processing tolerate a certain degree of errors made during acquisition, processing and rendering of images. There already exists a plethora of work on approximate circuit design for basic arithmetic operations such as additions [4, 10, 17], multiplications [2, 16], or divisions [5]. However, much less effort has been invested on efficient implementation of function approximation in hardware including trigonometric, exponential, and logarithmic functions. Here, Taylor series expansions or iterative approximation techniques are well known and often applied, but these also come at either very high resource or latency demands. Tabular representations of functions can serve as an alternative solution in case of small quantization and approximation errors. Indeed, they play an important role in function approximation due to providing constant-time evaluations at the cost of high memory demands. E.g., Matlab/Simulink [13] already offers an available optimization framework named Look-up-table (LUT) Optimizer [14] that computes a function table approximation for a given mathematical function to be approximated within a given interval subject to a maximal approximation error. Notably, this framework also allows to semi-automatically generate code (C++ and VHDL) for tabular function approximations. Unfortunately, when synthesizing this VHDL

code to a circuit implementation, e.g., for a Field Programmable Gate Array (FPGA) target, the tables are implemented quite inefficiently by using LUTs structures. Consequently, novel Hardware Description Language (HDL) generation and synthesis techniques are needed for resource-efficient function approximation on modern FPGAs. One contribution of this paper is to instantiate internal so-called Block RAM (BRAM) structures [20]. These BRAMs can even be configured individually in terms of number of entries and bit width of each entry. For example, a so-called BRAM18 block can be alternatively configured to store 16,384 entries of 1 bit, 8,192 entries of 2 bits, or up to just 1,024 entries of 32 bits.

In this realm, this paper presents a fully novel table-based approach for function approximation with contributions to drastically reduce the memory footprint compared to a state-of-the-art method and without any sacrifice in approximation error bounds. Concretely, our contributions are:

- Three *interval splitting algorithms* based on the observation that in sub-intervals of low gradient, a coarser sampling grid may be assumed to satisfy a user-given maximum interpolation error bound E_a at any point x within a given interval $[x_0, x_0 + a)$ of interest. Accordingly, each sub-interval owns an individually optimized spacing between breakpoints. The overall memory footprint is minimized by assigning a coarser breakpoint spacing to sub-intervals with small slope. Only sub-intervals with larger slopes require a fine quantization in order to satisfy E_a . The proposed algorithms deliver a partition of the given interval into proper sub-intervals such that E_a is never violated over the whole interval range. It is shown that memory footprint reductions of up to 70% in average are achieved over tables optimized and generated using the state-of-the-art tool LUT Optimizer by Matlab/Simulink [13].
- An *automated design flow* that uses the interval-based tabular function approximation to generate a hardware description in VHDL automatically. The proposed hardware circuit consists of three units. First, an interval selection circuit determines the index of the sub-interval containing the two breakpoints closest to x . Second, a table lookup unit that retrieves the two range values (y) of the breakpoints enclosing x . Finally, a linear interpolation is

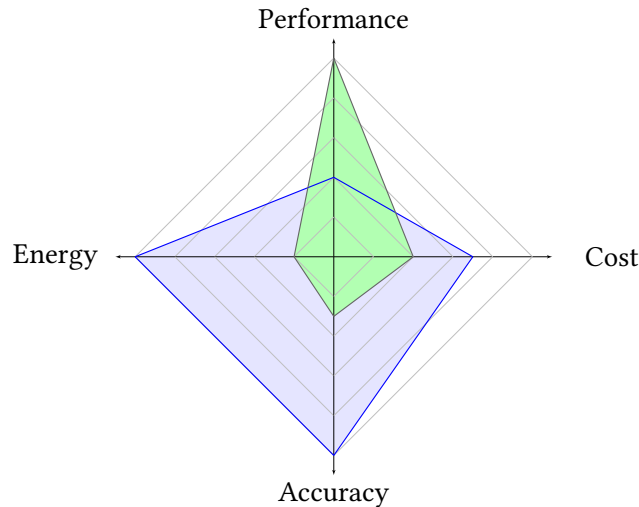

Fig. 1. Approximate computing (green) exploits the error tolerance and robustness of certain applications in order to trade-off accuracy against latency, energy and cost.

performed on these two looked-up values to return the approximation of $f(x)$. The whole architecture (depicted in Fig. 7) performs a function evaluation at a latency of 9 clock cycles.

- Finally, instead of synthesizing the reduced footprint tables using LUTs, BRAMs are instantiated, providing an additional degree of resource efficiency.

The paper is structured as follows: Sec. 2 gives an overview on related work. Then, Sec. 3 presents fundamentals and definitions. Sec. 4 then presents a reference approach according to [13] that will be used for comparison. Subsequently, Sec. 5 introduces the three interval-splitting algorithms and Sec. 6 contains the proposed hardware architecture, and overall design flow. Then, Sec. 7 presents the experimental results. Finally, Sec. 9 concludes our work.

2 RELATED WORK

Approximate computing approaches for elementary functions can be classified into three families. i) Polynomial-based approaches [1, 6, 8, 9, 12, 18] approximate a function by an approximating polynomial. Here, the complexity of the hardware implementation is closely related to the degree of the polynomial. In consequence, polynomial-based approaches tend to be expensive in terms of hardware as high degree polynomials are usually required for achieving low maximal approximation errors.

ii) Iterative approximation algorithms, as the name suggests, calculate a function based on iterative evaluations. Despite being resource-efficient, these algorithms typically suffer from slow convergence, thus requiring many iterations to achieve a certain approximation error. One prominent representative for this type of evaluators are CORDIC algorithms [3, 7], used to approximate trigonometric and hyperbolic functions.

iii) The third family of approximate evaluators is table-based [14, 19]. Table-based approaches split the given interval into a set of discrete points called breakpoints and store the function values evaluated at these breakpoints in a lookup table. Although offering constant-time lookup, the main drawback is often the size of the resulting lookup tables, that grows exponentially with the bit-width of the input. Hence, the table-based method is often combined with the polynomial-based approximation to reduce the memory footprint. This combination usually performs the piecewise-polynomial approximation [6, 8, 9, 12] of the target function.

E.g., similar to our approach, [9] and [6] segment a given interval to be approximated using piece-wise linear interpolations of the form $kx + b$. Both these approaches produce gradient-based non-uniform segments such that the approximation error in each segment does not exceed the specified maximal error. The number of segments determines the number of comparisons performed to place a given input in the correct interval. Both of these numbers increase with the input interval length and the steepness of the function.

Contrary to this, our implementation combines the concept of (1) gradient-based segmentation of the given interval with an input threshold parameter to control the number of segments, and (2) even sampling within a segment to guard a given maximal approximation error bound. Note also that we do not have to store any coefficient at all, but only the range values of the nearest breakpoints y_i and y_{i+1} and we do this in a memory of equal output bit-width for each value.

In this paper, we have shown that the proposed idea of interval-splitting can help to drastically reduce the memory footprint without sacrificing given error bounds.

3 FUNDAMENTALS

Storing the range values of a given function $f(x)$ for a discretized domain can help to avoid a computationally expensive polynomial approximation of $f(x)$. Unfortunately, this approach is impractical in case the given approximation error demands fine quantizations of the domain. Indeed,

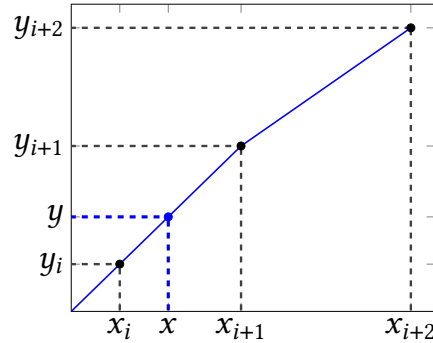

Fig. 2. Piecewise linear interpolation in between two breakpoints x_i and x_{i+1} .

the table size required to store the range values grows exponentially with the bit-width of x . E.g., if the bit-width for quantization of x is 8 bits, the size of the lookup table is $2^8 = 255$. However, if the bit-width of x is 32, the lookup table contains $2^{32} = 4,294,967,296$ entries, thus resulting in a memory footprint of 16 GB. Consequently, this method cannot be applied for resource-constrained devices such as FPGAs due to the limited amount of available memory and other hardware resources. As a solution, the combination of tabular function representation and polynomial interpolation has emerged as a widespread technique for function approximation on FPGAs [15]. Instead of storing all the range values of $f(x)$ for a given quantization of x , a more efficient approach is to use a coarser quantization of x and perform polynomial approximation in between two adjacent points called breakpoints in the following. In [15], it is proposed to use a degree n polynomial $p(x)$ as follows:

$$p(x) = a_0 + a_1x + \dots + a_nx^n \quad (1)$$

Here, $a_i : 0 \leq i \leq n$ denotes the coefficients of the approximating polynomial $p(x)$. Accordingly, the number of entries of the table can be reduced. Still, this requires to store the $n + 1$ additional coefficients of each polynomial in between two adjacent breakpoints.

In the rest of this paper, we consider piecewise linear interpolations to avoid the increased computational complexities and memory requirements of higher degree polynomials. In general, breakpoints do not have to be located equidistantly. In this case, linear interpolation can be performed using Eq. (2).

For example, the set of $k + 1$ breakpoints is denoted as $X = \{x_0, x_1, \dots, x_k\}$. Y represents the range value of $f(x)$ for X as domain $Y = \{f(x_0), f(x_1), \dots, f(x_k)\} = \{y_0, y_1, \dots, y_k\}$. The first and last breakpoints $\{x_0, x_k = x_0 + a\} \in X$ enclose the interval of approximation. Fig. 2 illustrates the calculation of $f(x)$ for any given $x \in \mathbf{R}$. If x matches with any value in X , the result can be directly retrieved from a table storing the values of Y . Otherwise, the first step is to find the closest breakpoints x_i and x_{i+1} of the input. Their corresponding range values y_i and y_{i+1} are then looked up. Finally, the value of $f(x)$ is computed according to Eq. (2).

$$y = y_i + \frac{x - x_i}{x_{i+1} - x_i} (y_{i+1} - y_i) \quad (2)$$

If $x_{i+1} - x_i$ is not constant $\forall i \in \{0, 1, \dots, k\}$, then the enclosing breakpoints can only be located by a search method. To this end, the number of comparisons performed grows with the number of breakpoints k . This can be avoided by even sampling of the interval $[x_0, x_0 + a]$. Now, when defining a uniform spacing $\delta = (x_{i+1} - x_i) > 0$ between two breakpoints, it is possible to determine the index i describing the interval $[x_i, x_{i+1})$ that includes x as follows:

$$i = \left\lfloor \frac{(x - x_0)}{\delta} \right\rfloor \quad (3)$$

Here, only the first value x_0 and the spacing δ are required to calculate i . Finally, with $x_i = x_0 + i \cdot \delta$, Eq. (2) can be re-written to only use the points in Y , x_0 , the location i according to Eq. (3) and the spacing δ :

$$y = y_i + \frac{x - (x_0 + i \cdot \delta)}{\delta} (y_{i+1} - y_i) \quad (4)$$

Thus, the function approximation can be achieved just by storing the $k + 1$ range values of X . Henceforth, we only consider equidistant spacing between two breakpoints. The required memory footprint is referred to as M_F in the following sections. For the linear interpolation scheme used in this paper:

$$M_F = k + 1 \quad (5)$$

4 REFERENCE APPROACH

In this section, we introduce the *Reference* approach [14] used later (see Sec. 7) for comparison. According to Eq. (5), the memory footprint M_F is linear in k , the number of breakpoints. An obvious remaining problem here is how to determine an equi-distant spacing δ being as large as possible such that still a user-given maximal approximation error bound E_a is never exceeded for any evaluation of $f(x)$ inside the given interval domain $[x_0, x_0 + a]$. Let $p_i(x)$ denotes the linear polynomial used to approximate the function $f(x)$ between the adjacent breakpoints $[x_i, x_{i+1}]$. A two-point line expression can be derived from Eq. (2) as follows:

$$p_i(x) = p_i(x_i) + \frac{x - x_i}{x_{i+1} - x_i} (p_i(x_{i+1}) - p_i(x_i)) \quad (6)$$

If the second derivative $f(x)''$ of $f(x)$ does exist at each point in $[x_i, x_{i+1}]$, then the difference between the exact function value $f(x)$ and the value of the approximating polynomial $p_i(x)$ in $x_i \leq x < x_{i+1}$ is given as:

$$f(x) - p_i(x) = \frac{(x - x_i)(x - x_{i+1})}{2} f''(\varepsilon_x) \quad (7)$$

In Eq. (7), ε_x is some value between x_i and x_{i+1} . In consequence, an error bound can be formulated based on Eqs. (6) and (7) as:

$$|f(x) - p_i(x)| \leq \frac{(x - x_i)(x_{i+1} - x)}{2} \max_{x_i \leq x < x_{i+1}} |f''(x)| \quad (8)$$

With the spacing $\delta_i = x_{i+1} - x_i$ between x_i and x_{i+1} , the maximum value of $(x - x_i)(x_{i+1} - x)$ in Eq. (8) can be constrained as:

$$\max_{x_i \leq x < x_{i+1}} (x - x_i)(x - x_{i+1}) = \frac{\delta_i^2}{4} \quad (9)$$

By combining Eqs. (8) and (9), we obtain a maximum approximation error bound E_i given a spacing δ_i :

$$E_i = \frac{\delta_i^2}{8} \max_{x_i \leq x < x_{i+1}} |f''(x)| \quad (10)$$

The dependence of the approximation error on the second derivative of a function is intuitive from the perspective of linearity. If f is truly linear in the interval $[x_i, x_{i+1}]$, then the second derivative vanishes implying an exact representation. The value of $\max_{x_i \leq x < x_{i+1}} |f''(x)|$ can be expressed in closed

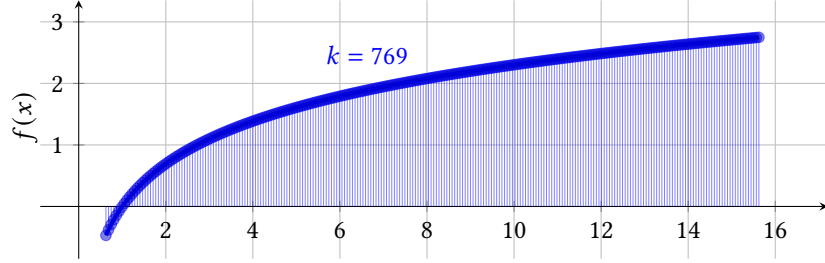

(a) Table-based approximation of $f(x) = \log(x)$. Here, $\delta = 0.019$, resulting in a memory footprint of $M_F = k + 1 = 770$ entries.

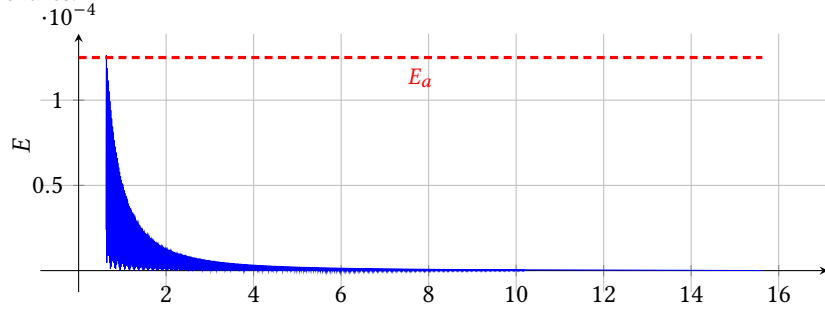

(b) Approximation Error obtained using Eq. (11) given $E_a = 1.25E - 04$.

Fig. 3. Function approximation of $f(x) = \log(x)$ in the interval $[0.625, 15.625]$.

form for elementary functions as well as some of the non-elementary functions due to their well-defined second derivatives. Finally, for a given user-defined maximal approximation error bound E_a to hold between any pair of breakpoints and assuming equi-distant spacings $\delta = \delta_i$, $0 \leq i \leq k - 1$, we can infer the biggest permissible spacing δ from the segment i with the smallest value of δ_i in Eq. (10):

$$\delta(f, E_a, [x_0, x_k]) = \min_{0 \leq i \leq k-1} \left(8 \cdot \frac{E_a}{\max_{x_i \leq x < x_{i+1}} |f''(x)|} \right)^{\frac{1}{2}} \quad (11)$$

E.g., Fig. 3 illustrates the approximation of $f(x) = \log(x)$ in the interval $[0.625, 15.625]$ and $E_a = 1.25E - 04$. This results in an spacing $\delta(\log(x), E_a, [0.625, 15.625]) = 0.019$. From spacing δ and the interval $[x_0, x_0 + a)$, it is possible to generate the entries to be stored in the lookup table (see Fig. 3a). Given a spacing δ and an interval $[x_0, x_0 + a)$, the memory footprint of the *Reference* approach can be calculated as:

$$M_F^R(\delta, [x_0, x_0 + a)) = \left\lceil \frac{x_0 + a - x_0}{\delta} \right\rceil + 1 \quad (12)$$

Thus, the memory footprint of $f(x) = \log(x)$, given the interval $[0.625, 15.625]$, and $\delta = 0.019$ is $M_F^R(0.019, [0.625, 15.625]) = 770$ entries.

The *Reference* approach performs the function approximation given a maximum approximation error E_a by delivering a set of evenly spaced breakpoints. However, this approach does not take into account the gradient in different regions of the interval. This may be result inefficient, e.g., in Fig. 3, the sub-interval $[0.625, 2.5)$ determines the maximal spacing for the given approximation error E_a . However, it can be seen that outside of this *critical* interval (see Fig. 3b), a coarser spacing

could be used when splitting the domain into sub-intervals and using different spacings δ_i within these. This is one of the major ideas of the three proposed approaches introduced in the following.

5 INTERVAL SPLITTING ALGORITHMS

Uniform spacing schemes such as even spacing (see the *Reference* approach in Sec. 4) or power of two spacing do not consider the varying local behavior of elementary functions in the interval of approximation. This section introduces three approaches to partition a given interval $[x_0, x_0 + a)$ into a set of non-uniform sub-intervals and determine a uniform spacing of breakpoints in each sub-interval given a maximum tolerable approximation error E_a . The proposed approaches perform the segmentation of the interval $[x_0, x_0 + a)$ to search for partitions exploiting the granularity in the spacing according to the steepness of a given function in different sub-intervals. Here, we trade between the number of generated sub-intervals and the memory footprint reduction rate.

The presented algorithms differ mainly in the heuristic utilized to compute the set of sub-interval partitions. The first two algorithms (Algorithms 1 and 2) split a given interval into two sub-intervals recursively until the corresponding stopping criterion is satisfied. Algorithm 1, called *binary segmentation* always splits a sub-interval at the midpoint. In contrast, Algorithm 2, called *hierarchical segmentation* finds the best splitting point by sweeping over the given interval such that the reduction in memory footprint M_F when splitting is maximized. Here, the step size for the sweep is then given as an input. Finally, Algorithm 3 named *sequential segmentation* also performs a sweep-based interval splitting. However, the interval splitting is performed iteratively. Hence, we can guarantee that Algorithm 3 always delivers a set of sub-interval boundaries P after a single sweep over the interval $[x_0, x_0 + a)$.

5.1 Binary Segmentation

Algorithm 1 performs the *binary segmentation* of a given interval $[p_i, p_{i+1})$ in which the function $f(x)$ is to be approximated. The inputs of Algorithm 1 are the function $f(x)$, the interval $[x_0, x_0 + a)$, the maximum approximation error E_a and a threshold value ω which determines whether a new sub-interval is accepted. *Binary segmentation* determines a partition of sub-intervals P , from which a set of spacings S and a list of breakpoint values K can be obtained. Each element of P represents a left (sub-interval) delimiter value. As an example for illustration, assume Algorithm 1 determines the following sub-interval splitting for a given function $P = \{p_0, p_1, p_2\}$, that yields the sets of values $S = \{\delta_0, \delta_1\}$ and $K = \{\kappa_0, \kappa_1\}$. P represents a partitioning into two sub-intervals $[p_0, p_1)$ and $[p_1, p_2)$. Here, δ_0 and κ_0 corresponds to the spacing and the number of breakpoints for the sub-interval $[p_0, p_1)$ as well as δ_1 and κ_1 corresponds to sub-interval $[p_1, p_2)$. The number of sub-intervals is thus $|P| - 1$. The memory footprint corresponding to P is given by:

$$M_F^P([p_0, p_{|P|-1})) = \sum_{j=0}^{|P|-1} \kappa_j \quad (13)$$

Binary segmentation is a recursive algorithm, which evaluates the reduction in M_F obtained by splitting the current interval $[p_i, p_{i+1})$ at the midpoint bp . The lower and upper bounds of the interval of approximation ($[x_0, x_0 + a)$) are provided as the inputs $p_i = x_0$ and $p_{i+1} = x_0 + a$ to the function *Binary*. The first step is to initialize P as $\{p_i, p_{i+1}\}$ (see Line 4 in Algorithm 1). The spacing δ_p and the number of breakpoints κ_p are obtained by using the *Reference* approach in the interval $[p_i, p_{i+1})$ (see Sec. 4).

The midpoint bp of the input interval is used to create the left sub-interval $bp_1 = [p_i, bp)$ and right sub-interval $bp_2 = [bp, p_{i+1})$. The spacings δ_{bp_1} and δ_{bp_2} , and the number of breakpoints κ_{bp_1} and κ_{bp_2} of sub-intervals bp_1 and bp_2 are calculated according to Eq. (10) and Eq. (12) (see Lines 8-12 in

Algorithm 1: Binary Interval-Splitter $[p_i, p_{i+1}]$

```

1 Function Binary( $\omega, E_a, f, p_i, p_{i+1}$ ):
2   Inputs :  $f$  is the function to be approximated
               $p_i$  is the lower bound of the interval
               $p_{i+1}$  is the upper bound of the interval
               $\omega$  is the reduction threshold (0,1)
               $E_a$  is the maximum approximation error
   Outputs:  $P = \{p_0, p_1, \dots, p_n\}$  is the set of sub-interval boundaries
3   begin
4      $P \leftarrow \{p_i, p_{i+1}\}$  // Initial set of sub-intervals boundaries
5      $\delta_p \leftarrow \delta(f, E_a, [p_i, p_{i+1}])$  // Calculate the spacing in the interval
6      $\kappa_p \leftarrow M_F(\delta_p, [p_i, p_{i+1}])$  // Calculate the  $M_F$  of the interval
7      $bp \leftarrow \frac{p_i + p_{i+1}}{2}$  // Midpoint between  $p_i$  and  $p_{i+1}$ 
8      $\delta_{bp_1} \leftarrow \delta(f, E_a, [p_i, bp])$  // Calculate the spacing of sub-intervals
9      $\delta_{bp_2} \leftarrow \delta(f, E_a, [bp, p_{i+1}])$ 
10    if  $\delta_{bp_1} \neq \delta_{bp_2}$  then
11       $\kappa_{bp_1} \leftarrow M_F(\delta_{bp_1}, [p_i, bp])$  // Calculate the  $M_F$  of sub-intervals
12       $\kappa_{bp_2} \leftarrow M_F(\delta_{bp_2}, [bp, p_{i+1}])$ 
13      if  $\kappa_{bp_1} + \kappa_{bp_2} < \kappa_p \cdot \omega$  then // If true, there is a reduction in  $M_F$ 
14         $P \leftarrow \{\text{Binary}(\omega, E_a, f, p_i, bp) \cup \text{Binary}(\omega, E_a, f, bp, p_{i+1})\}$  // Recursive call for
          sub-intervals  $[p_i, bp]$  and  $[bp, p_{i+1}]$ 
15      end
16    end
17    return  $P$ 
18  end
19 End Function

```

Algorithm 1). The sum of κ_{bp_1} and κ_{bp_2} is denoted as $M_F^{P'}$ where $P' = \{p_i, bp, p_{i+1}\}$.

If $M_F^{P'}$ is less than a specified fraction (threshold ω) of κ_p (see Line 13 in Algorithm 1), an acceptable memory footprint reduction exists. Then, the *binary* function is called recursively for the sub-intervals bp_1 and bp_2 respectively. Otherwise, the algorithm terminates and returns the current input interval boundaries ($\{p_i, p_{i+1}\}$). The union of all the returned sets form the final output set P . The value $\omega \in (0, 1]$ indicates the threshold of an acceptable memory footprint reduction. E.g., $\omega = 0.2$ indicates that a split interval must lead to at least a footprint reduction of 20% in order to continue splitting the left and right sub-intervals.

Fig. 4 illustrates the proposed sub-interval splitting approximation method using an example.

Let the function $f = \log(x)$ be approximated in the interval $[p_i, p_{i+1}] = [0.625, 15.625)$ with a maximum approximation error of $E_a = 1.22E - 04$ and splitting threshold $\omega = 0.3$. To find a partition of the interval, *binary segmentation* is performed with the inputs ω, E_a, f and $[p_i, p_{i+1}]$. Here, the spacing and the number of breakpoints obtained by the *Reference* approach are $\delta_p = 0.019$ and $k_p = 770$, respectively. At this point, the set of partitions $P = \{0.625, 15.625\}$, the set of spacings $S = \{0.019\}$ and the list of breakpoint numbers is $K = \{770\}$. Then, Algorithm 1 determines the first middle point $bp = 8.125$ of the interval $[0.625, 15.625)$. The left and right sub-intervals are derived using bp , thus $bp_1 = [0.625, 8.125)$ and $bp_2 = [8.125, 15.625)$. After calculating the spacing $\delta_{bp_1} = 0.0195$ and $\delta_{bp_2} = 0.25$ for these two sub-intervals, respectively, the number of breakpoints results in $\kappa_{bp_1} = 384$ and $\kappa_{bp_2} = 31$. The new partition has a memory

(a) Function approximation of $\log(x)$ obtained by *binary segmentation*.(b) Error margins obtained by *binary segmentation*.

Fig. 4. The *binary segmentation* identifies the partition $P = \{0.625, 2.5, 4.375, 8.125, 15.625\}$ describing four sub-intervals $[0.625, 2.5)$, $[2.5, 4.375)$, $[4.375, 8.125)$ and $[8.125, 15.625)$. Here, a total of $M_F = 182$ entries represents a reduction in memory footprint of 76 % compared to the *Reference* approach (see Fig. 3a) for a user-given maximal approximation error bound of $E_a = 1.22E - 04$.

footprint of $M_F = (384 + 31) = 415$. Compared to the previous memory footprint of 770, the achieved reduction in memory footprint is 46 % which is greater than the required threshold of 30 % ($\omega = 0.3$). Then, the function *binary* is called recursively for the accepted right and left sub-intervals $[0.625, 8.125)$ and $[8.125, 15.625)$, respectively. The previous is repeated until no more partitionings can be achieved with an accepted memory footprint reduction. Algorithm 1 stops with the final partition $P = \{0.625, 2.5, 4.375, 8.125, 15.625\}$. Hence, four sub-intervals $[0.625, 2.5)$, $[2.5, 4.375)$, $[4.375, 8.125)$, and $[8.125, 15.625)$ were identified. The spacings and the number of breakpoints of each sub-intervals are $S = \{0.02, 0.08, 0.13, 0.25\}$ and $K = \{97, 25, 29, 31\}$. From the list of memory footprints K , the memory footprint of the proposed approach can be calculated. The reported memory footprint presented in Fig. 4 is $M_F^P([0.625, 15.625)) = (97 + 25 + 29 + 31) = 182$. Compared to the reported memory footprint $M_F^R = 770$ for the same function, interval, and error bound (see Fig. 3) using the *Reference* approach, binary segmentation is able to reduce the memory footprint by 76 % while respecting the maximum approximation error bound imposed by the given E_a (see Fig. 4b).

Using the midpoint as a partitioning heuristic might lead to a sub-optimal exploration of the partitions in approximation of a given function $f(x)$. The next section introduces another recursive

approach which employs a different heuristic in attempt to achieve more considerable memory footprint reductions.

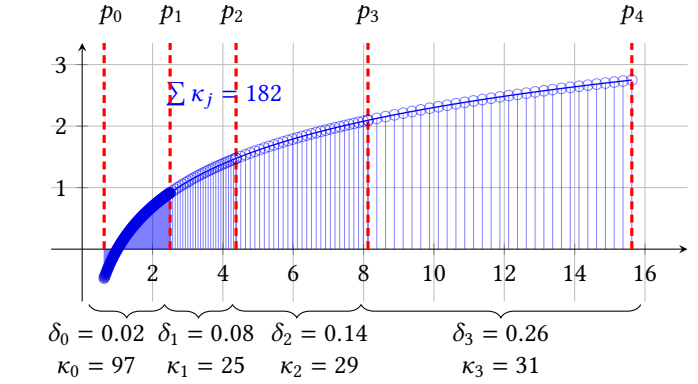
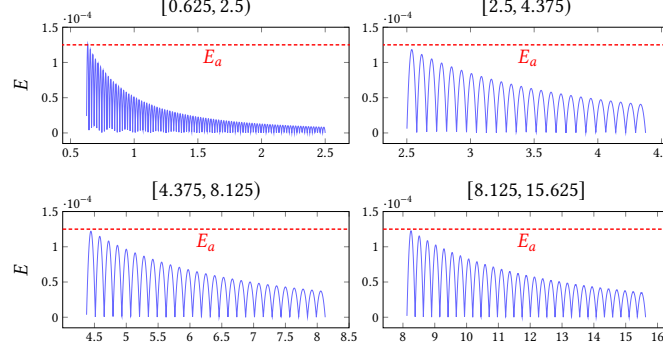
5.2 Hierarchical Segmentation

Hierarchical segmentation is carried out by function *Hierarchical* in Algorithm 2. Despite having a similar recursive behavior as Algorithm 1, this approach performs linear sweeps of the input interval $[p_i, p_{i+1})$ instead of using the midpoint to generate new partitions. *Hierarchical segmentation* chooses the best partitioning sp among a set of candidate splitting points in $[p_i, p_{i+1})$. Here, the step size ε denotes the uniform distance between two adjacent splitting points. The value of ε , the function f , the interval $[p_i, p_{i+1})$, the reduction threshold ω , and the maximum approximation error E_a are passed as inputs to Algorithm 2 (see Line 2 of Algorithm 2). The expected output is the set of partitions P , from which a set of spacings S and a list of breakpoint values K can be determined (see Line 3 of Algorithm 2).

First, Algorithm 2 initializes the set $P = \{p_i, p_{i+1}\}$ with the lower p_i and upper p_{i+1} bounds of the input interval (see Line 4 in Algorithm 2). The number of splitting points j_{max} is determined using the step size ε as a parameter (see Line 5 in Algorithm 2). As the next step, we evaluate all the possible memory footprints by splitting the input interval at each candidate point. The next partitioning sp is chosen as the point delivering the smallest memory footprint (see Lines 6 and 7 in Algorithm 2). The left and right sub-intervals are derived as $sp_1 = [p_i, sp)$ and $sp_2 = [sp, p_{i+1})$, respectively. The spacings δ_{sp_1} and δ_{sp_2} and number of breakpoints κ_{sp_1} and κ_{sp_2} of sub-intervals sp_1 and sp_2 are calculated using the *Reference* approach (see Lines 9-12 in Algorithm 2). The memory footprint $M_F^{P'}$ after splitting is equal to the sum of κ_{sp_1} and κ_{sp_2} , where $P' = \{p_i, sp, p_{i+1}\}$.

Suppose the memory footprint of the new sub-intervals $M_F^{P'}$ is less than a specified fraction ω of κ_p (the memory footprint over the interval $[p_i, p_{i+1})$). In that case, the new sub-intervals are accepted, and the hierarchical function is called recursively to explore the right and left sub-intervals (see Line 13 in Algorithm 2). Otherwise, the algorithm terminates returning the current upper and lower interval bounds (see Line 16 in Algorithm 2). In the end, the union of all the returned sets forms the output set of partitions P .

Fig. 5a shows the hierarchical segmentation approach over the interval $[p_i, p_{i+1}) = [0.625, 15.625)$. E.g., let $f(x) = \log(x)$, the reduction threshold $\omega = 0.3$, the maximum absolute error $E_a = 1.22E-04$, and the sweep size $\varepsilon = 0.015$. At this point, the number of candidate splitting points is $j_{max} = \frac{15.625 - 0.625}{0.015} = 1000$. This set of points can be expressed in terms of ε and j_{max} as $\{p_i + j \cdot \varepsilon \mid i \leq j < j_{max}\}$. After evaluating each point, Algorithm 2 determines $sp = 2.90$ as the best candidate resulting in the left sub-interval $sp_1 = [0.625, 2.90)$ and the right sub-interval $sp_2 = [2.90, 15.625)$.

The value of κ_{sp_1} is calculated to be 117 and that of κ_{sp_2} is 141. The partition has a memory footprint of $M_F^{P'} = (117 + 141) = 258$ which implies a 66.5 % reduction in memory footprint compared to M_F^R obtained by the *Reference* approach. The achieved reduction is greater than the required threshold reduction of 30 % ($\omega = 0.3$). Thus, the recursive splitting continues for the sub-intervals sp_1 and sp_2 . The previous steps are repeated until no more splitting can be performed resulting in the set of partitions $P = \{0.6250, 1.2106, 2.9073, 6.2556, 15.6250\}$, as illustrated in Fig. 5a where the set of spacings $S = \{0.01, 0.06, 0.09, 0.19\}$, and the set of breakpoints $K = \{30, 25, 37, 49\}$. The value of $M_F^P([0.625, 15.625)) = 30 + 45 + 37 + 49 = 161$. Hierarchical segmentation is able to reduce the memory footprint by 79 % with respect to *Reference* approach and by 11.5 % compared to binary segmentation (Algorithm 1).

5.3 Sequential Segmentation

Algorithm 2: Hierarchical Interval-Splitter $[p_i, p_{i+1})$

```

1 Function Hierarchical( $\omega, E_a, f, p_i, p_{i+1}$ ):
2   Inputs :  $f$  is the function to be approximated
               $p_i$  is the lower bound of the interval
               $p_{i+1}$  is the upper bound of the interval
               $\omega$  is the reduction threshold (0,1]
               $E_a$  is the maximum approximation error
               $\varepsilon$  is the sweep step size
   Outputs:  $P = \{p_0, p_1, \dots, p_n\}$  is set of sub-interval boundaries
3   begin
4      $P \leftarrow \{p_i, p_{i+1}\}$  // Initial set of sub-intervals boundaries
5      $j_{max} \leftarrow \left\lceil \frac{p_{i+1} - p_i}{\varepsilon} \right\rceil$  // Calculate the number of test-points in the interval
6      $j^* \leftarrow \arg \min_{1 \leq j \leq j_{max}} M_F(\delta(f, E_a, [p_i, p_i + j \times \varepsilon]), [p_i, p_i + j \times \varepsilon]) + M_F(\delta(f, E_a, [p_i + j \times \varepsilon, p_{i+1}]), [p_i + j \times \varepsilon, p_{i+1}])$ 
7      $sp \leftarrow p_i + j^* \times \varepsilon$  // Determine the splitting point
8      $\kappa_p \leftarrow M_F(\delta_p, [p_i, p_{i+1}])$  // Calculate the  $M_F$  of the interval
9      $\delta_{sp_1} \leftarrow \delta(f, E_a, [p_i, sp])$  // Calculate the spacing of sub-intervals
10     $\delta_{sp_2} \leftarrow \delta(f, E_a, [sp, p_{i+1}])$ 
11     $\kappa_{sp_1} \leftarrow M_F(\delta_{sp_1}, [p_i, sp])$  // Calculate the  $M_F$  of sub-intervals
12     $\kappa_{sp_2} \leftarrow M_F(\delta_{sp_2}, [sp, p_{i+1}])$ 
13    if  $\kappa_{sp_1} + \kappa_{sp_2} < \kappa_p \cdot \omega$  then // If true, there is a reduction in the  $M_F$ 
14       $P \leftarrow \{\text{Hierarchical}(\omega, E_a, f, p_i, sp, \varepsilon) \cup \text{Hierarchical}(\omega, E_a, f, sp, p_{i+1}, \varepsilon)\}$ 
              // Recursive call for sub-intervals  $[p_i, sp]$  and  $[sp, p_{i+1}]$ 
15    end
16    return  $P$ 
17  end
18 End Function

```

Algorithm 3 describes the third approach called *sequential segmentation* and receives as inputs the function $f(x)$ to approximate, the interval $[x_0, x_0 + a)$, maximum approximation error E_a , the reduction threshold ω and the sweep size ε . The sequential segmentation performs a linear sweep of the input interval similar to the hierarchical segmentation. However, the sequential segmentation is an iterative process that produces a set of partitions P after a single sweep of the interval $[x_0, x_0 + a)$. The set of sweep values can be represented as $\{sp \mid sp = x_0 + i \cdot \varepsilon\}$ where $1 \leq i < i_{max}$. Here, the distance between two adjacent elements in the set is ε . The number of sweep values i_{max} depends on the length of interval a and the step size ε (see Line 2 in Algorithm 3).

Algorithm 3 initializes P and x_p with the lower bound x_0 of the input interval (see Lines 1-2 in Algorithm 3). The value of x_p always corresponds to the last entry of the set of partitions P . The spacing δ_p and the memory footprint κ_p of the input interval $[x_0, x_0 + a)$ are calculated following the *Reference* approach (Sec. 4). The algorithm iterates through the sweep values sp and calculates the memory footprints κ_{sp_1} and κ_{sp_2} of the sub-intervals $sp_1 = [x_p, sp)$ and $sp_2 = [sp, x_0 + a)$, respectively. If the memory footprint $M_F^{P'}$ of the new sub-intervals leads to a reduction satisfying the threshold ω , then the set of partitions P is updated with sp as a new splitting point. The values x_p , δ_p and κ_p are updated accordingly (see Lines 13-16 in Algorithm 3). Algorithm 3 stops with the last sweep value which is one step size smaller than $x_0 + a$.

The main difference of *sequential segmentation* between *binary* and *hierarchical* is how the partition

Algorithm 3: Sequential Interval-Splitter $[x_0, x_0 + a)$

```

1 Function Sequential( $\omega, E_a, f, x_0, x_0 + a$ ):
   Inputs :  $f$  is the function to be approximated
              $x_0$  is the lower bound of the interval
              $x_0 + a$  is the upper bound of the interval
              $\omega$  is the reduction threshold (0,1]
              $E_a$  is the maximum approximation error
              $\varepsilon$  is the sweep step size
   Outputs:  $P = \{p_0, p_1, \dots, p_n\}$  is the set of sub-interval boundaries
2    $P \leftarrow \{x_0\}$  // Initialize  $P$  with the lower bound of the interval
3    $x_p \leftarrow x_0$ 
4    $i_{max} \leftarrow \left\lceil \frac{a}{\varepsilon} \right\rceil$  // Calculate the number of required steps to reach  $x_0 + a$ 
5    $\delta_p \leftarrow \delta(f, E_a, [x_p, x_0 + a))$  // Calculate the spacing of sub-interval  $[x_p, x_0 + a)$ 
6    $\kappa_p \leftarrow M_F(\delta_p, [x_p, x_0 + a))$  // Calculate the  $M_F$  of sub-interval  $[x_p, x_0 + a)$ 
7   for  $i \leftarrow 1$  to  $i_{max}$  do
8      $sp \leftarrow x_0 + i \cdot \varepsilon$  // Determine the splitting point
9      $\delta_{sp_1} \leftarrow \delta(f, E_a, [x_p, sp))$  // Calculate the spacing of sub-intervals
10     $\delta_{sp_2} \leftarrow \delta(f, E_a, [sp, x_0 + a))$ 
11     $\kappa_{sp_1} \leftarrow M_F(\delta_{sp_1}, [x_p, sp))$  // Calculate the  $M_F$  of sub-intervals
12     $\kappa_{sp_2} \leftarrow M_F(\delta_{sp_2}, [sp, x_0 + a))$ 
13    if  $\kappa_{sp_1} + \kappa_{sp_2} < \kappa_p \cdot \omega$  then // If true, there is a reduction in the  $M_F$ 
14       $P \leftarrow P \cup \{sp\}$  // Updating  $P$ 
15       $x_p \leftarrow sp$  // Updating  $x_p$ 
16       $\delta_p \leftarrow \delta(f, E_a, [x_p, x_0 + a))$  // Calc. the spacing
17       $\kappa_p \leftarrow M_F(\delta_p, [x_p, x_0 + a))$  // Calc. the  $M_F$  of the interval to split
18    end
19  end
20   $P \leftarrow P \cup \{x_0 + a\}$  // Updating  $P$  with the upper bound of the interval
21 End Function

```

points are generated. Here, *sequential segmentation* sweeps from left to right to find the set of partitions, and only one iteration over the given interval is required. In contrast, *binary* and *hierarchical* perform a recursive exploration of the interval. Every time a new partition point is found, two new sub-intervals located at the right and the left are generated and explored until no more memory footprint reductions are achieved.

Fig. 5b presents the set of partitions obtained by the *sequential segmentation* for $f(x) = \log(x)$, over the interval $[0.625, 15.625)$, the reduction threshold $\omega = 0.3$, maximum absolute error $E_a = 1.22E-04$, and the sweep size $\varepsilon = 0.3$. Algorithm 3 determines the first splitting point as $sp = 0.9250$ while sweeping the interval $[0.625, 15.625)$. Thus, resulting in the new sub-intervals $sp_1 = [0.625, 0.925)$ and $sp_2 = [0.925, 15.625)$ with a memory footprint of $\kappa_{sp_1} = 16$ and $\kappa_{sp_2} = 510$, respectively. The partition has a memory footprint of $M_F^{P'} = (16 + 510) = 526$ which results in a reduction of 31.6% compared to *Reference* approach. Then, the partition generated using $sp = 0.9025$ is accepted because the memory footprint reduction obtained is greater than the required threshold of 30% ($\omega = 0.3$). The previous steps are repeated for all the sweep values sp in the interval $[0.625, 15.625)$. Fig. 5b shows that the completed sweep over the interval $[0.625, 15.625)$ produces the set of partitions $P = \{0.625, 0.925, 1.525, 2.425, 3.625, 6.025, 15.625\}$, resulting in a memory

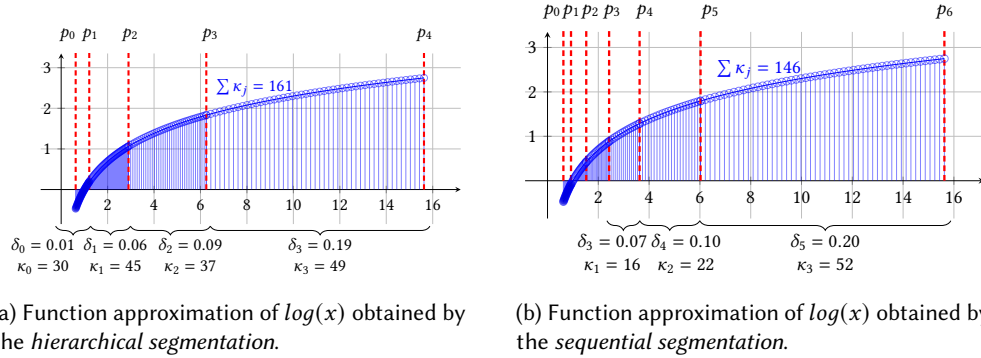

Fig. 5. The *hierarchical segmentation* identifies the partition $P = \{0.625, 1.21, 2.90, 6.25, 15.625\}$ describing four sub-intervals $[0.625, 1.21)$, $[1.21, 2.90)$, $[2.90, 6.25)$ and $[6.25, 15.625)$. Here, a total of $M_F = 161$ entries represents a reduction in memory footprint of 79 % compared to the *Reference* approach (see Fig. 3a) for a user-given maximal approximation error bound of $E_a = 1.22E - 04$. On the other hand, the *sequential segmentation* obtained the partition $P = \{0.625, 1.21, 2.90, 6.25, 15.625\}$ with $M_F = 146$ resulting in a memory footprint reduction of 81 % compared to the *Reference*.

footprint $M_F^P([0.625, 15.625]) = (16 + 21 + 19 + 16 + 22 + 52) = 146$. *Sequential segmentation* is able to reduce the memory footprint by 81 % with respect to *Reference*. Compared to *binary* and *hierarchical* segmentation approaches, the memory footprint reduction is increased by 18 % and 9 %, respectively. Finally, the *sequential segmentation* generated six sub-intervals that are larger in number than the sub-intervals produced by the other two heuristics. *Sequential segmentation* performs a fine-grained exploration of the splitting points where most of the partitions are placed on those locations where the function is steeper.

The following section presents a statistical analysis of the proposed approaches to determine which delivers the most significant memory footprint reduction.

5.4 Comparison of Proposed Approaches

As shown by the previous three examples (see Figs. 4 and 5), the partitioning heuristics can achieve significant overall memory footprint reductions by splitting the interval of approximation. This section presents the statistical evaluation of the three presented approaches in terms of the memory footprint reductions delivered compared to the *Reference* approach. We define the memory footprint reduction as:

$$\Delta_{\downarrow}(M_F)[\%] = \frac{M_F^R - M_F^P}{M_F^R} \quad (14)$$

Where M_F^R and M_F^P correspond to the memory footprints obtained respectively by the *Reference* approach and any of the three proposed approaches. Our first analysis compares the mean memory footprint reductions of the presented approaches by varying the reduction threshold ω . Six different functions are used as test cases with respective intervals of approximation presented in Table 2.

Fig. 6a shows the memory footprint evaluation of the binary, hierarchical, and sequential segmentation colored in red, gray, and blue. The x -axis corresponds to the reduction threshold varying from 0.01 to 0.3 (1 % to 30 % of memory footprint reductions). The y -axis represents the mean memory footprint reduction over a population X of 100 randomly generated intervals contained in the interval $[x_0, x_0 + a)$. Table 2 shows the intervals under consideration for each of the test functions. Each point in Fig. 6a represents the mean memory footprint reduction $mean(\Delta M_F)$ obtained by the binary, hierarchical and sequential approaches using the population X , a given

Table 1. Null (H_0) and alternate (H_a) hypotheses of two-tailed and one-tailed Student's t test

Tail-type	Null Hypothesis H_0	Alternative Hypothesis H_a
Two-tailed	$H_0 : \mu_1 = \mu_2$	$H_a : \mu_1 \neq \mu_2$
Right-tailed	$H_0 : \mu_1 \leq \mu_2$	$H_a : \mu_1 > \mu_2$
Left-tailed	$H_0 : \mu_1 \geq \mu_2$	$H_a : \mu_1 < \mu_2$

reduction threshold ω , and maximum absolute error $E_a = 9.5367E - 07$. We can observe the impact of the reduction threshold ω on $mean(\Delta M_F)$ obtained by the proposed approaches. As the reduction threshold ω gets closer to 0, all three approaches report maximum memory footprint reductions due to an increase in the number of generated intervals. Accordingly, a fine-grained exploration of the partitions over the interval is performed. On the other hand, as the value of threshold ω gets closer to 0.3, the number of generated intervals reduces. Thus, a coarse grain exploration of the partitions is achieved, and the reduction of memory footprint decreases.

As the reduction threshold increases, the sequential segmentation approach (colored in blue) performs better than the other two approaches. For $f(x) = e^{-\frac{x^2}{2}}$ and $f(x) = \tan(x)$, the sequential segmentation delivered the maximum memory footprint reductions when the threshold was closer to 0.3 because of the shape of the second derivative (see Eq. (10)), which is irregular and steeper compared with the rest of the test functions.

However, as the reduction threshold ω gets close to 0 (between 0.01 and 0.04), the hierarchical approach (colored in gray) performs better for almost all the reported test functions. Only when $f(x) = e^x$, the hierarchical and sequential delivered similar reductions. We reported a maximum mean memory footprint reductions using the hierarchical segmentation of 44.5 % for $f(x) = e^x$, 43.5 % for $f(x) = \log(x)$, 69.8 % for $f(x) = \tanh(x)$, 51.6 % for $f(x) = \frac{1}{1+e^{-x}}$, and 65.8 % for $f(x) = e^{-\frac{x^2}{2}}$.

The second part of the presented statistical analysis consists of a two-sample Student's t -test. This statistical test is used to compare the means of two independent groups of samples. The samples are assumed to be normally distributed with an unknown variance. The types of t -tests and the corresponding null (H_0) and alternative hypotheses (H_a) are given in Table 1. A test decision accepts or rejects these hypotheses with a confidence level of $1 - \alpha$ depending on the absolute value of the statistics, the significance level α (usually set to 0.05), the sample size, and the population means (μ_1 and μ_2) of the two compared populations (henceforth groups G_1 and G_2). Here, we want to compare the mean memory footprint reductions produced by the three proposed methods. The null hypothesis H_0 must be accepted in the right-tailed t -test and rejected in the left-tailed t -test to establish that the samples in group G_2 outperform those in group G_1 . To perform the one-tailed two-sample t -test, we employed the Matlab [13] function $ttest2(G_1, G_2)$ from the Statistics and Machine Learning Toolbox. The output of $ttest2(G_1, G_2)$ is 1 if the null hypothesis H_0 is rejected and 0 otherwise. Accordingly, the method represented by G_2 yields more significant average memory footprint reductions than the method defined by G_1 if the values returned by the right and left tailed t -test are 0 and 1, respectively. For the t -test, the considered groups are the mean memory footprint reductions that we have previously introduced in Fig. 6a. Groups G_1 , G_2 and G_3 corresponds to binary, hierarchical and sequential approaches, respectively, each with a sample size of 30 elements.

Each sample in a group represents the average memory footprint reduction achieved by one of the proposed methods for 100 different input intervals and a given threshold reduction ω . To obtain all the samples in a group, ω is varied between 0.01 and 0.3, in steps of 0.01. The set of input

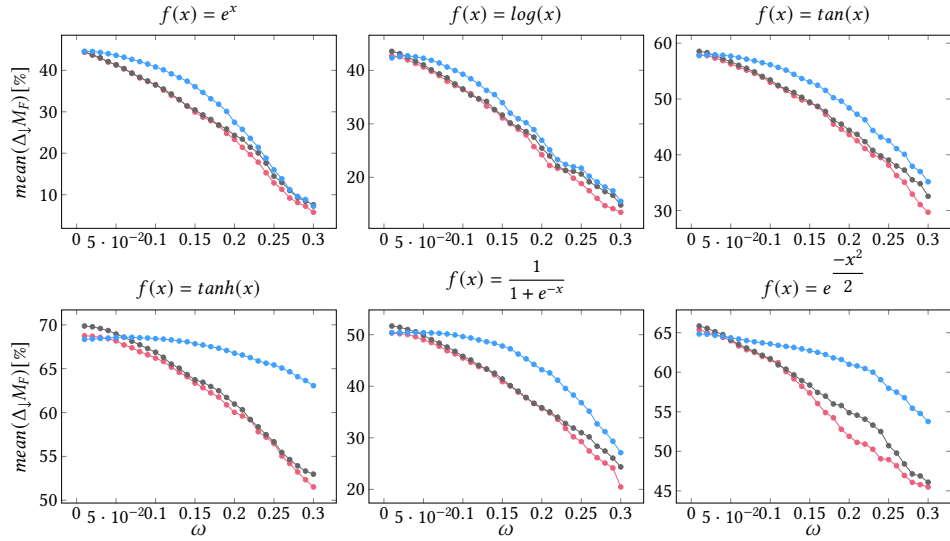

(a) Memory footprint reduction analysis of the proposed binary, hierarchical and sequential approaches.

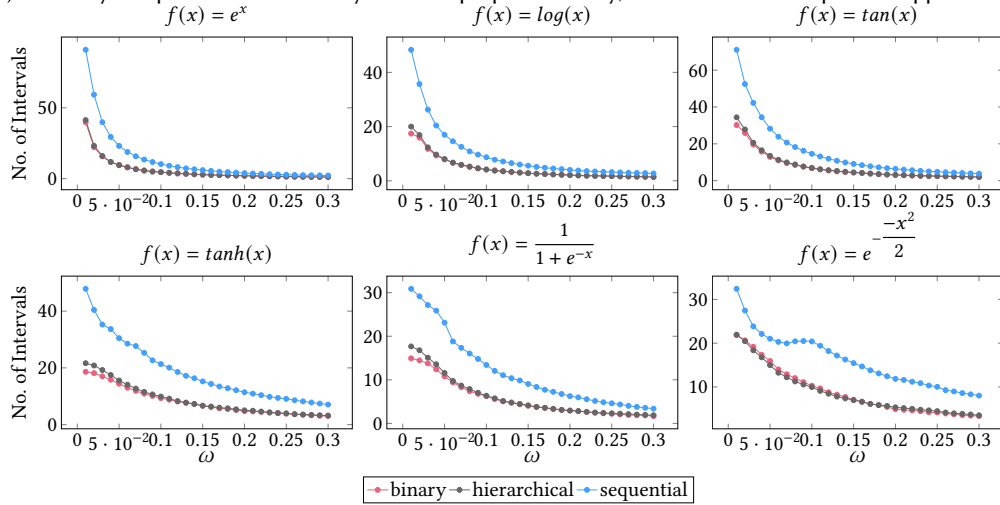

(b) Number of intervals obtained by the proposed binary, hierarchical and sequential approaches.

Fig. 6. Memory footprint reduction analysis of the proposed binary, hierarchical and sequential interval-based segmentation approaches colored in red, gray, and blue, respectively. The x -axis presents 30 threshold values ω ranging from 0.01 to 0.3. In contrast, each point represents the mean memory footprint reduction $mean(\Delta_{\perp} M_F)$ for 100 randomly generated sub-intervals in the interval range presented in Table 2 for each given value ω .

intervals remains the same for evaluation of the samples in any group. The results of the one-tailed two-sample t -tests are presented in Table 2.

We can observe that the t -test is not statistically conclusive for $f(x) = \log(x)$ and $f(x) = e^x$. Here, the confidence level does not allow us to conclude the existence of an algorithm that outperforms the others in terms of memory footprint reductions. We might say that the three approaches deliver similar reductions.

Table 2. Result of right-tailed and left-tailed two-sample t -test for pair-wise proposed algorithms (groups G_1 , G_2 and G_3 corresponds to binary, hierarchical and sequential, respectively.)

$f(x)$	$[x_0, x_0 + a)$	Pair-wise test	Right-tailed t -test	Left-tailed t -test
$\log(x)$	[0.625, 15.625)	(G_1, G_2)	0	0
		(G_1, G_3)	0	0
		(G_2, G_3)	0	0
e^x	[0, 5)	(G_1, G_2)	0	0
		(G_1, G_3)	0	0
		(G_2, G_3)	0	0
$\tan(x)$	[-1.5, 0)	(G_1, G_2)	0	0
		(G_1, G_3)	0	1
		(G_2, G_3)	0	0
$\tanh(x)$	[-8, 0)	(G_1, G_2)	0	0
		(G_1, G_3)	0	1
		(G_2, G_3)	0	1
$\frac{1}{1 + e^{-x}}$	[-10, 0)	(G_1, G_2)	0	0
		(G_1, G_3)	0	1
		(G_2, G_3)	0	1
$\frac{-x^2}{e^2}$	[-6, 0)	(G_1, G_2)	0	0
		(G_1, G_3)	0	1
		(G_2, G_3)	0	1

In the case of $f(x) = \tan(x)$, we can conclude that the sequential approach only outperforms the binary segmentation, whereas the comparison between sequential and hierarchical t -test is non-conclusive. For the rest of the functions in Table 2, we can conclude that the sequential segmentation outperforms the binary and hierarchical approaches with a confidence level of 95% (see rows colored in gray and the values 0 and 1 for the right-tailed and left-tailed t -test, respectively). Following the results of the t -test, we might conclude that the interval splitting heuristic based on sequential segmentation delivers the maximum mean memory footprint reductions. However, heuristics that allow a fine grain exploration of the possible partitioning points, such as the hierarchical segmentation, is observed to have greater sample mean reductions even compared to the sequential segmentation when the reduction threshold value ω lies between 0.01 and 0.04. Moreover, the average number of sub-intervals for hierarchical segmentation remains smaller than sequential segmentation as shown in Fig. 6b. For reduction threshold values ω greater than 0.04, the sequential segmentation results in the best approach.

6 HARDWARE IMPLEMENTATION

Our second major contribution is the introduction of a generic, automatically synthesizable hardware implementation of the proposed approaches for the table-based function approximation. Fig. 7 depicts this hardware architecture. The architecture's input is a bit vector Ξ to be evaluated by the approximation of $f(x)$. The architecture's output is a bit vector Y . The input and the output are assumed to be user-defined as fixed point numbers represented by the tuples $(S^\Xi, W_L^\Xi, f_L^\Xi)$ and (S^Y, W_L^Y, f_L^Y) , respectively. Here, S indicates the sign, W_L corresponds to the length of the binary bit string, and f_L denotes the number of bits used for the fractional part.

First, the input Ξ passes through the interval selector determining the sub-interval containing Ξ

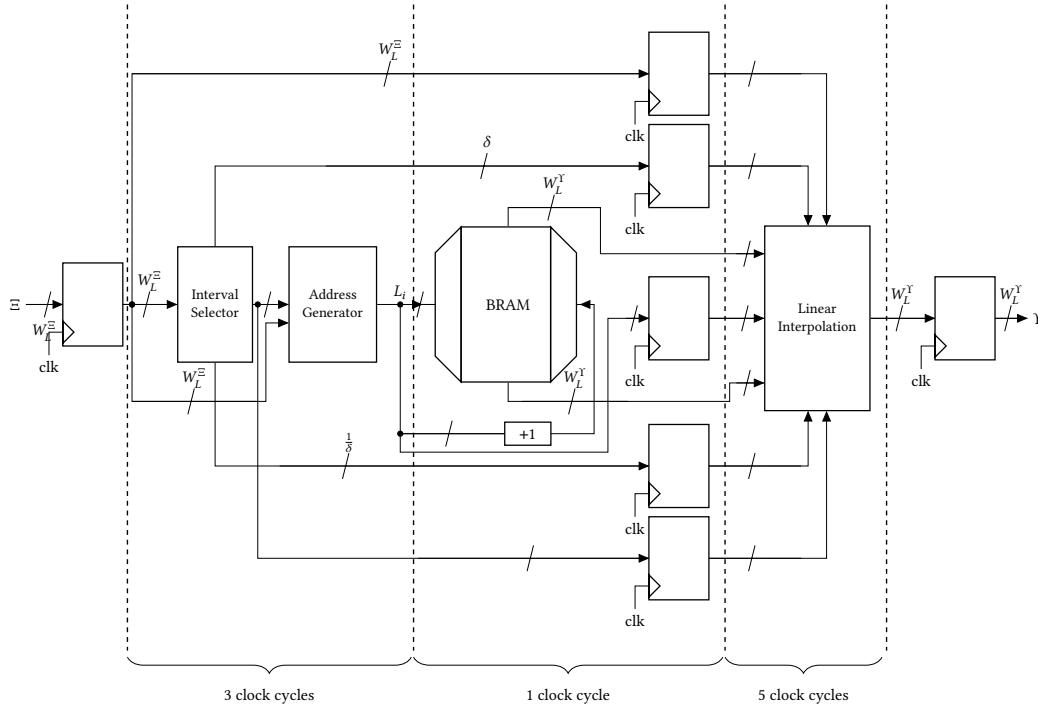

Fig. 7. Proposed generic hardware implementation for table-based function approximation using interval-splitting and BRAM instantiation. An input Ξ of W_L^Ξ bits in pre-specified fixed-point number format is evaluated. In three clock cycles, the interval selector determines in which partition Ξ is and its respective base address L_i in the BRAM, as well as, a valid address is generated. In the next clock cycle, the two breakpoints required to evaluate Ξ are looked up in the BRAM. Then, in five clock cycles, the linear interpolation block calculates the approximated value of $f(x)$. The shown pipelined implementation allows for a throughput of one function evaluation after nine clock cycles.

and consequently, the values of parameters specific to the sub-interval e.g., the spacing between breakpoints. Since the implemented interval selector is a set of comparators which traverses a binary tree generated from the set of sub-intervals, there might exist differences in aspects such as the latency of each proposed approach, which depend on the depth of the binary tree. E.g., the sequential segmentation approach generates an unbalanced binary tree, resulting in a larger set of cascaded comparators than the other two segmentation approaches that deliver more balanced trees. Our proposed design flow solves this issue by introducing a pre-processing balancing strategy that always delivers a balanced binary tree of comparators. Then, the address generator determines the addresses of the stored function values L_i and L_{i+1} corresponding to the breakpoints enclosing the input. These values are read from the BRAM. In the last stage, the subsequent block calculates the linear interpolation to determine Y .

We implemented a design flow that automates the generation of the hardware architecture. First, the tabular-based function approximation is performed using one of our proposed approaches (see Sec. 5). Then, the output of the algorithm is used to generate a hardware description in VHDL. We employ the HDL coder of Matlab [13] to generate VHDL code for the implementation of the range values y of the breakpoints to be stored and adapted the code generation to instantiate BRAMs.

We use the set of partitions P to implement the interval selector and the linear interpolation blocks.

The arithmetic operations performed to compute the output are pipelined to increase the throughput of the circuit. The interval selector and address generator take three clock cycles to generate valid address signals. The y values are obtained from the BRAMs in the next clock cycle. Then, the linear interpolation block requires five clock cycles to produce the output. Therefore, the latency of the proposed architecture is constant at nine clock cycles per function evaluation, and independent of the function that is approximated, number formats, and number of sub-intervals determined by interval splitting. In the following, we evaluate the implementation of our segmentation approach in a target FPGA device to measure the memory footprint reductions, logic utilization (LUTs), BRAM utilization, and the operating frequency.

7 RESULTS

To evaluate the benefits and the impact of the interval splitting approaches introduced in Sec. 5, we compare the even spacing table-based function approximation approach (*Reference*) against our newly introduced hierarchical interval segmentation table-based approximation approach. Here, we only consider the hierarchical approach because it performs better than the binary and sequential in terms of mean memory footprint reductions ($\Delta_{\downarrow}(M_F)$) and the number of generated intervals for smaller reduction threshold values ω as discussed in Sec. 5.4. The goal of the *Reference* and the hierarchical approach is to generate an efficient memory footprint function approximation of $f(x)$ for a given interval $[x_0, x_0 + a)$ and maximum absolute error E_a .

Apart from comparing the memory footprint reductions obtained by each approach, we performed hardware implementations of both approaches and compared them regarding the number of utilized BRAMs, the number of utilized LUTs, and the operating frequency in MHz. Here, we used the Matlab/Simulink LUT Optimizer [14] to obtain the VHDL implementation of the *Reference* approach. We customize the code delivered by Matlab's HDL coder to force the instantiation of the tabular function representation in the BRAMs instead of using LUTs and Flip-Flops.

Regarding the hierarchical approach, we utilized our newly introduced design flow (see Sec. 6) that semi-automatically performs VHDL code generation and BRAM instantiation of the table-based function approximation. The benchmark considered for comparison consists of six test functions presented in Table 3. We selected these functions because they present different gradient regions to examine the benefits of our proposed segmentation approach.

In the following, we will show that our proposed hierarchical segmentation-based approach is able to achieve drastic memory footprint reductions and efficient utilization of BRAMs.

7.1 Test Setup

The benchmark composed of six test functions is presented in Table 3. Each function is evaluated by the *Reference* and the hierarchical approach with an absolute approximation error $E_a = 9.5367E-07$ over the interval $[x_0, x_0 + a)$ presented in the second column in Table 3. The third and fourth columns in Table 3 show the input ($S^{\Xi}, W_L^{\Xi}, f_L^{\Xi}$) and output (S^Y, W_L^Y, f_L^Y) fixed-point format used to approximate the proposed test functions. Here, S corresponds to the bit used to represent the sign, being 1 for a negative number and 0 for a positive. W_L is the bit-width, and f_L is the number of bits used for the fractional part.

As a target FPGA, we selected the Zynq-7000 Programmable System-on-Chip (PSoC) with 53, 200 LUTs, 106, 400 Flip-Flops, and up to 4.9 MB of BRAMs. We performed the synthesis of the circuits for the *Reference* and the hierarchical approach using Vivado 2021.2. We synthesized six samples per approximated function for the hierarchical approach by varying the number of generated intervals $1 \leq n < 30$, where n stands for the number of generated intervals. For the trivial case of $n = 1$ (no partitioning is performed), the results are equal to those delivered by the *Reference*.

7.2 Analysis of Synthesis Results

Fig. 8 presents the synthesis results obtained by the *Reference* and the hierarchical approach regarding memory footprint (M_F), number of instantiated BRAMS, number of utilized LUTs, and operating frequency in MHz.

Our proposed hierarchical approach is able to drastically reduce the memory footprint resulting in very efficient utilization of BRAMS (see Fig. 8a). Regarding logic utilization of the target FPGA, our hierarchical approach utilizes more LUT than the reference approach due to the number of generated intervals impacting the size and depth of the binary tree of comparators (see Sec. 5). However, this only represents a 3% overall utilization of the LUTs available in the target FPGA. Finally, our proposed approach ranges between 86.5 MHz and 88.5 MHz in terms of operating frequency (see Fig. 8b).

7.2.1 Memory Footprint and BRAMS Utilization. Fig. 8a presents the memory footprint, and the number of utilized BRAMS colored in blue and green, respectively, for the *Reference* ($n=1$) and the hierarchical segmentation approaches. Here, we generated six implementations using the hierarchical approach and varying the number of generated intervals n for each explored function. For example, when approximating the function $f(x) = \tan(x)$, we generated six implementations generating $n \in \{1, 3, 5, 13, 17, 29\}$ partitions. The calculation of the memory footprint obtained by the *Reference* approach ($n = 1$) is according to Eq. (12).

At first, we can observe a considerable decrease in the memory footprint and the number of used BRAMS when we apply the hierarchical segmentation approach ($n > 1$) for all the presented functions. The sixth and the seventh columns in Table 3 present the memory footprint ($\Delta_{\downarrow}(M_F)$) and the utilized BRAM ($\Delta_{\downarrow}(BRAMS)$) reductions obtained by our proposed hierarchical approach compared to the *Reference* for each obtained partitioning. The memory footprint reduction rate was calculated according to Eq. (14).

In general, we can observe that as the number of obtained sub-intervals increases, the memory footprint decreases as well as the number of utilized BRAMS. E.g., for $f(x) = \tan(x)$, the *Reference* results in a table with a $M_F^R = 81,543$ entries stored in 95 BRAMS. On the other hand, the table obtained by our approach for partitioning $n = 3$ resulted in a memory footprint reduction $\Delta_{\downarrow}(M_F) = 75\%$ and BRAM reduction $\Delta_{\downarrow}(BRAMS) = 66\%$. For $n = 5$, the corresponding memory footprint and BRAMS usage reduction resulted in $\Delta_{\downarrow}(M_F) = 80\%$ and $\Delta_{\downarrow}(BRAMS) = 83\%$, respectively. However, for $n = 13$ the memory footprint reduced in $\Delta_{\downarrow}(M_F) = 89\%$ but the $\Delta_{\downarrow}(BRAMS) = 83\%$ remained the same as $n = 5$. Intuitively, we would expect a reduction in the BRAM usage as the memory footprint reduces. Nevertheless, this might not always be the case because of the storage capacity of each BRAM and how the data is internally stored. According to the Xilinx 7-series specification, it is important to note that each BRAM has a depth of 1,024 (2^{10}) for an input bit-width of 32 bits.

Thus, each address is represented as a bit string of 10 bits length. To store more than 1,024 entries, we require a bus address size larger than 10. Let w denote the address length. If $w > 10$, then 2^m BRAMS will be instantiated such that $2^w = 2^m \times 2^{10}$ where $m = w - 10$.

Consider $n = 5$ for $f(x) = \tan(x)$, the reported memory footprint is $M_F^P = 15,644$ which is bigger than 1,024. Thus the width of the address bus is $w = \lceil \log_2(15,644) \rceil = 14$ and $m = 14 - 10 = 4$. Then, the number of utilized BRAMS is $2^4 = 16$. Let consider now $n = 13$ for the same $f(x) = \tan(x)$, the reported memory footprint is $M_F^P = 8,798$ and $w = \lceil \log_2(8,798) \rceil = 14$. This results in 16 utilized BRAMS which is the same for $n = 5$. Accordingly, the number of utilized BRAMS is not only affected by the memory footprint but also by the capacity of storage of each BRAM.

For the rest of the test functions, we also obtained significant memory footprint reductions and efficient BRAMS utilization. For $f(x) = \log(x)$, we reported memory footprint reductions ranging from 66% to 85% and BRAMS reduction ranging from 75% to 87.5%. In case of $f(x) = e^x$, the

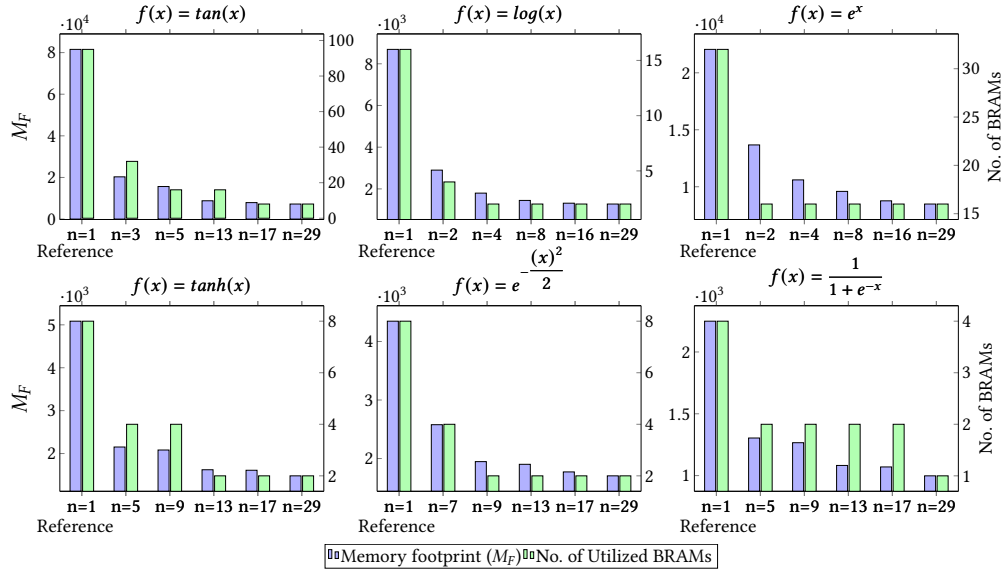

(a) Memory footprint and BRAM utilization

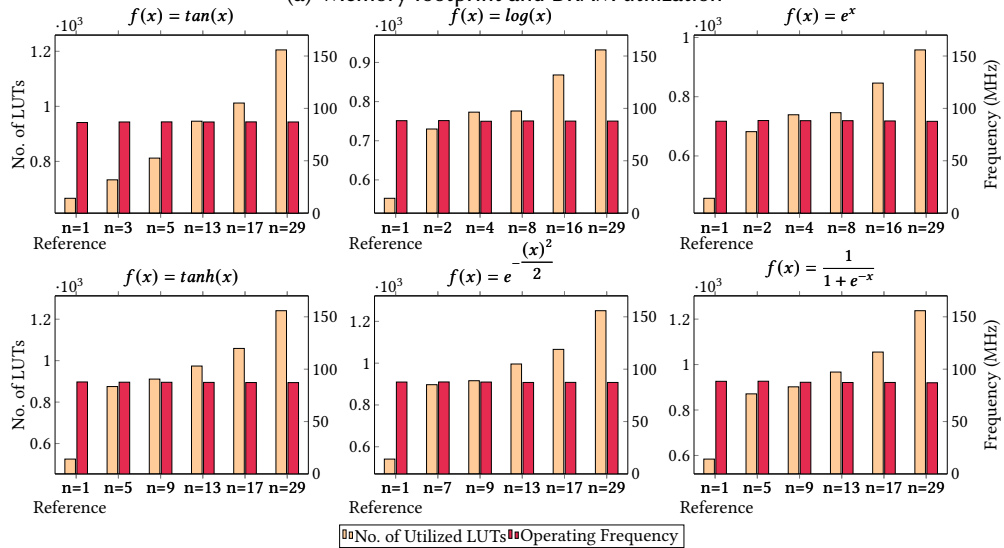

(b) LUT Utilization and Operating Frequency

Fig. 8. Synthesis results obtained by the *hierarchical segmentation* approach obtained for the approximation of benchmark functions in Table 3 against the number of generated sub-intervals ($1 \leq n < 30$). In (a), we can observe that as the number of sub-intervals increases, there exists reductions in the memory footprint and the number of utilized BRAMs. In (b), the number of utilized LUTs and operating frequency are presented. Here, the number of intervals directly affects the number of utilized LUTs which are used to implement the interval selector. Finally, we can observe that the operating frequency is between 86.5 – 88.5 MHz.

memory footprint reductions $\Delta_{\downarrow}(M_F)$ ranged from 38 % to 61 % with a BRAMs reduction $\Delta_{\downarrow}(BRAMs)$ of 50 %. For $f(x) = \tan(x)$, the $\Delta_{\downarrow}(M_F)$ ranged from 57 % to 70 % with a BRAMs reduction

Table 3. Evaluation benchmark composed of six test functions and their characteristics presented from column two to four. Columns fifth to seventh present the memory footprint reduction $\Delta_{\downarrow}(M_F)$, the BRAM utilization reduction $\Delta_{\downarrow}(BRAMs)$ and the increment of LUTs $\Delta_{\uparrow}(LUTs)$ compared to the *Reference*. The last column presents the average operating frequency.

$f(x)$	$[x_0, x_0 + a)$	$(S^{\Xi}, W_L^{\Xi}, f_L^{\Xi})$	$(S^{\Upsilon}, W_L^{\Upsilon}, f_L^{\Upsilon})$	n	$\Delta_{\downarrow}(M_F)$ [%]	$\Delta_{\downarrow}(BRAMs)$ [%]	$\Delta_{\uparrow}(LUTs)$ [%]	Avg. Freq. (MHz)
$\tan(x)$	[-1.5, 1.5)	(1, 32, 30)	(1, 32, 27)	3	75 %	66 %	10 %	86.9
				5	80 %	83 %	21 %	
				13	89 %	83 %	42 %	
				17	90 %	91 %	52 %	
				29	91 %	91 %	81 %	
$\log(x)$	[0.625, 15.625)	(0, 32, 28)	(1, 32, 29)	2	66 %	75 %	32 %	88.0
				4	79 %	87.5 %	39 %	
				8	83 %	87.5 %	40 %	
				16	84 %	87.5 %	57 %	
				29	85 %	87.5 %	68 %	
e^x	[0, 5)	(0, 32, 29)	(0, 32, 24)	2	38 %	50 %	49 %	88.1
				4	51 %	50 %	61 %	
				8	56 %	50 %	63 %	
				16	60 %	50 %	85 %	
				29	61 %	50 %	109 %	
$\tanh(x)$	[-8, 8)	(1, 32, 27)	(1, 32, 31)	5	57 %	50 %	66 %	87.5
				9	59 %	50 %	73 %	
				13	68 %	75 %	85 %	
				17	68 %	75 %	102 %	
				29	70 %	75 %	136 %	
$e^{-\frac{x^2}{2}}$	[-6, 6)	(1, 32, 28)	(1, 32, 32)	7	40 %	50 %	66 %	87.6
				9	55 %	75 %	69 %	
				13	56 %	75 %	84 %	
				17	59 %	75 %	97 %	
				29	60 %	75 %	131 %	
$\frac{1}{1+e^x}$	[-10, 10)	(1, 32, 27)	(0, 32, 32)	5	42 %	50 %	49 %	87.7
				9	43 %	50 %	54 %	
				13	51 %	50 %	65 %	
				17	52 %	50 %	81 %	
				29	55 %	75 %	111 %	

$\Delta_{\downarrow}(BRAMs)$ up to 75 %. For $f(x) = e^{-\frac{x^2}{2}}$, the $\Delta_{\downarrow}(M_F)$ ranged from 40 % to 60 % with a BRAMs reduction $\Delta_{\downarrow}(BRAMs)$ up to 75 %. Finally, for $f(x) = \frac{1}{1+e^x}$, the $\Delta_{\downarrow}(M_F)$ ranged from 42 % to 55 % with a BRAMs reduction $\Delta_{\downarrow}(BRAMs)$ up to 75 %.

7.2.2 LUTs Utilization. In Fig. 8b, the light orange bars present the number of LUTs utilized for the six implementations obtained by the proposed hierarchical segmentation approach ranging the number of generated intervals from 1 to 30. Here, the *Reference* corresponds to the case with no partitionings ($n = 1$). We can observe that the number of utilized LUTs increases with the number of generated intervals n for all the presented benchmark functions. The increment in LUTs can be attributed to an increase in the number of comparisons required to traverse the binary tree in the interval selection block (see Fig. 7), which are tightly related to the number of generated intervals n obtained by our proposed hierarchical approach. Compared to the *Reference*, our approach reported an increment in the number LUTs up to $\Delta_{\uparrow}(LUTs) = 81\%$ for $f(x) = \tan(x)$, up to $\Delta_{\uparrow}(LUTs) = 68\%$ for $f(x) = \log(x)$, up to $\Delta_{\uparrow}(LUTs) = 109\%$ for $f(x) = e^x$, up to $\Delta_{\uparrow}(LUTs) = 136\%$ for $f(x) =$

$\tanh(x)$, up to $\Delta_{\uparrow}(LUTs) = 131\%$ for $f(x) = e^{-\frac{x^2}{2}}$ and up to $\Delta_{\uparrow}(LUTs) = 111\%$ for $f(x) = \frac{1}{1+e^x}$. However, the reported increase in LUTs only represents a minor overall utilization of 3% of the available LUTs in the target FPGA.

7.2.3 Operating Frequency. In Fig. 8b, the red bars shows the operating frequency reached by six implementations of the proposed hierarchical segmentation approach by varying the number of generated intervals n between 1 to 30. We can generally observe that the operating frequency lies between 86.5 MHz to 88.5 MHz for the six analyzed functions. The last column in Table 3 presents the average operating frequency for each of the benchmark functions. We can observe that our proposed hierarchical approach reached an overall average operating frequency of 87.5 MHz. Accordingly, the hardware implementation is able to produce an approximated function evaluation every $\frac{9 \text{ clock cycles}}{87.5 \text{ MHz}} \approx 102.8 \text{ ns}$.

8 CONCLUSION

In this article, we investigated an efficient way to approximate elementary functions given an interval and a maximum absolute error. First, we realized that by splitting the given interval into a set of sub-intervals and assuming a coarser sampling grid for low gradient regions, while respecting the given maximum approximation error E_a . Second, we proposed a generic hardware architecture to automatically synthesize such interval-split tabular function approximators with an evaluation latency of 9 clock cycles per function evaluation. For resource efficiency, we made use of BRAMs by automatically inferring them in our design flow during the code generation of the hardware description. In consequence, reductions in the memory footprint and BRAM usage were shown to be achievable by our proposed approach. As future work, we want to explore more efficient packing of BRAMs and alternative sub-interval determination algorithms.

REFERENCES

- [1] Ben Adcock, Simone Brugiapaglia, and Clayton G. Webster. 2017. *Compressed Sensing Approaches for Polynomial Approximation of High-Dimensional Functions*. Springer International Publishing, 93–124.
- [2] Mohammad Ahmadinejad, Mohammad Hossein Moaiyeri, and Farnaz Sabetzadeh. 2019. Energy and area efficient imprecise compressors for approximate multiplication at nanoscale. *International Journal of Electronics and Communications* 110 (2019), 152859.
- [3] Ray Andraka. 1998. A Survey of CORDIC Algorithms for FPGA Based Computers. In *Proceedings of the 1998 ACM/SIGDA Sixth International Symposium on Field Programmable Gate Arrays (FPGA '98)*. Association for Computing Machinery, 191–200.
- [4] A. Becher, J. Echavarría, D. Ziener, S. Wildermann, and J. Teich. 2016. A LUT-Based Approximate Adder. In *Proceedings of FCCM 2016*. 27–27.
- [5] M. Brand, M. Witterauf, F. Hannig, and J. Teich. 2019. Anytime instructions for programmable accuracy floating-point arithmetic. In *Proceedings of ACM Int. Conf. on Comp. Fronts. (CF)*, 2019. 215–219.
- [6] Jon T. Butler, C.L. Frenzen, Njuguna Macaria, and Tsutomu Sasao. 2011. A fast segmentation algorithm for piecewise polynomial numeric function generators. *J. Comput. Appl. Math.* 235, 14 (2011), 4076–4082. <https://doi.org/10.1016/j.cam.2011.02.033>
- [7] Linbin Chen, Jie Han, Weiqiang Liu, and Fabrizio Lombardi. 2017. Algorithm and Design of a Fully Parallel Approximate Coordinate Rotation Digital Computer (CORDIC). *IEEE Transactions on Multi-Scale Computing Systems* 3, 3 (2017), 139–151.
- [8] Davide De Caro, Nicola Petra, and Antonio G. M. Strollo. 2011. Efficient Logarithmic Converters for Digital Signal Processing Applications. *IEEE Transactions on Circuits and Systems II: Express Briefs* 58, 10 (2011), 667–671. <https://doi.org/10.1109/TCSII.2011.2164159>
- [9] Hongxi Dong, Manzhen Wang, Yuanyong Luo, Muhan Zheng, Mengyu An, Yajun Ha, and Hongbing Pan. 2020. PLAC: Piecewise Linear Approximation Computation for All Nonlinear Unary Functions. *IEEE Transactions on Very Large Scale Integration (VLSI) Systems* 28, 9 (2020), 2014–2027. <https://doi.org/10.1109/TVLSI.2020.3004602>
- [10] Jorge Echavarría, Stefan Wildermann, Andreas Becher, Jürgen Teich, and Daniel Ziener. 2016. FAU: Fast and Error-optimized Approximate Adder Units on LUT-Based FPGAs. In *Proceedings of Field-Programmable Technology (FPT)*.

- 213–216. <https://doi.org/10.1109/FPT.2016.7929536>
- [11] J. Han and M. Orshansky. 2013. Approximate computing: An emerging paradigm for energy-efficient design. In *2013 18th IEEE European Test Symposium (ETS)*. 1–6.
- [12] Dong-U Lee, Ray C. C. Cheung, Wayne Luk, and John D. Villasenor. 2009. Hierarchical Segmentation for Hardware Function Evaluation. *IEEE Transactions on Very Large Scale Integration (VLSI) Systems* 17, 1 (2009), 103–116. <https://doi.org/10.1109/TVLSI.2008.2003165>
- [13] MATLAB. 2019. *version 9.6.0 (R2019a)*. The MathWorks Inc., Natick, Massachusetts.
- [14] MATLAB. 2021. *Optimize Lookup Tables for Memory-Efficiency Programmatically*. The MathWorks Inc. <https://de.mathworks.com/help/fixedpoint/ug/optimize-lookup-tables-for-memory-efficiency-programmatically.html>
- [15] Jean-Michel Muller. 1999. A Few Results on Table-Based Methods. *Reliable Computing* 5 (1999), 279–288.
- [16] Srinivasan Narayanamoorthy, Hadi Asghari Moghaddam, Zhenhong Liu, Taejoon Park, and Nam Sung Kim. 2015. Energy-Efficient Approximate Multiplication for Digital Signal Processing and Classification Applications. *IEEE Transactions on Very Large Scale Integration Systems* 23, 6 (2015), 1180–1184. <https://doi.org/10.1109/TVLSI.2014.2333366>
- [17] Hyoju Seo, Yoon Seok Yang, and Yongtae Kim. 2020. Design and Analysis of an Approximate Adder with Hybrid Error Reduction. *Electronics* 9, 3 (2020).
- [18] David I Shuman, Pierre Vanderghyest, and Pascal Frossard. 2011. Chebyshev polynomial approximation for distributed signal processing. In *2011 International Conference on Distributed Computing in Sensor Systems and Workshops (DCOSS)*. 1–8.
- [19] Ye Tian, Ting Wang, Qian Zhang, and Qiang Xu. 2017. ApproxLUT: A novel approximate lookup table-based accelerator. In *2017 IEEE/ACM International Conference on Computer-Aided Design (ICCAD)*. 438–443.
- [20] Xilinx. 2019. *7 Series FPGA Memory Resources*. <https://www.xilinx.com/>. https://www.xilinx.com/support/documentation/user_guides/ug473_7Series_Memory_Resources.pdf
- [21] Q. Xu, T. Mytkowicz, and N. Kim. 2015. Approximate computing: A survey. *IEEE Design & Test* 33, 1 (2015), 8–22.