

Symmetry as a shadow of topological order and a derivation of topological holographic principle

Arkya Chatterjee and Xiao-Gang Wen

Department of Physics, Massachusetts Institute of Technology, Cambridge, Massachusetts 02139, USA

Symmetry is usually defined via transformations described by a (higher) group. But a symmetry really corresponds to an algebra of local symmetric operators, which directly constrains the properties of the system. In this paper, we point out that the algebra of local symmetric operators contains a special class of extended operators – transparent patch operators, which reveal the selection sectors and hence the corresponding symmetry. The algebra of those transparent patch operators in n -dimensional space gives rise to a non-degenerate braided fusion n -category, which happens to describe a topological order in one higher dimension (for finite symmetry). Such a holographic theory not only describes (higher) symmetries, it also describes anomalous (higher) symmetries, non-invertible (higher) symmetries (also known as algebraic higher symmetries), and non-invertible gravitational anomalies. Thus, topological order in one higher dimension, replacing group, provides a unified and systematic description of the above generalized symmetries. This is referred to symmetry/topological-order (Symm/TO) correspondence. Our approach also leads to a derivation of topological holographic principle: *boundary uniquely determines the bulk*, or more precisely, the algebra of local boundary operators uniquely determines the bulk topological order. As an application of the Symm/TO correspondence, we show the equivalence between $\mathbb{Z}_2 \times \mathbb{Z}_2$ symmetry with mixed anomaly and \mathbb{Z}_4 symmetry, as well as between many other symmetries, in 1-dimensional space.

CONTENTS

<p>I. Introduction 2</p> <p>II. Notations and terminology 4</p> <p>III. Bosonic quantum system and its algebra of local operators 5</p> <p style="padding-left: 20px;">A. Total Hilbert space, local operator algebra, and local Hamiltonian 5</p> <p style="padding-left: 20px;">B. Transparent patch operators 5</p> <p style="padding-left: 20px;">C. Patch symmetry and patch charge operators 6</p> <p style="padding-left: 20px;">D. Algebra of t-patch operators and Categorical symmetry 6</p> <p>IV. A 1d bosonic quantum system with \mathbb{Z}_2 symmetry 7</p> <p style="padding-left: 20px;">A. \mathbb{Z}_2 symmetry and its algebra of local symmetric operators 7</p> <p style="padding-left: 20px;">B. Patch symmetry transformation 8</p> <p style="padding-left: 20px;">C. The algebra of patch charge operators and its braided fusion category 8</p> <p style="padding-left: 20px;">D. Representation category and symmetry 10</p> <p style="padding-left: 20px;">E. The algebra of patch symmetry operators and its braided fusion category – transformation category 11</p> <p style="padding-left: 20px;">F. The algebra of all string operators and its non-degenerate braided fusion category 11</p> <p style="padding-left: 20px;">G. A holographic way to compute categorical symmetry 12</p> <p>V. A 1d bosonic quantum system with anomalous \mathbb{Z}_2 symmetry 12</p> <p style="padding-left: 20px;">A. Braided fusion category of patch symmetry transformation operator 13</p> <p style="padding-left: 20px;">B. Braided fusion category of patch charge operator 14</p> <p style="padding-left: 20px;">C. Braided fusion category of all t-patch operators 14</p>	<p style="padding-left: 20px;">D. A holographic way to compute categorical symmetry 14</p> <p>VI. A 1d bosonic quantum system with $\mathbb{Z}_2 \times \mathbb{Z}_2$ symmetry with a mixed anomaly 14</p> <p style="padding-left: 20px;">A. Braided fusion category of patch operators 14</p> <p style="padding-left: 20px;">B. A holographic calculation of categorical symmetry 15</p> <p style="padding-left: 20px;">C. The equivalence between 1d $\mathbb{Z}_2 \times \mathbb{Z}_2$ symmetry with mixed anomaly and 1d \mathbb{Z}_4 symmetry 16</p> <p style="padding-left: 20px;">D. A new duality mapping 16</p> <p>VII. A 1d bosonic quantum system with an emergent $\mathbb{Z}_2 \times \mathbb{Z}_2$ symmetry which is “beyond anomaly” 18</p> <p>VIII. 2d \mathbb{Z}_2 symmetry and its dual 19</p> <p style="padding-left: 20px;">A. \mathbb{Z}_2 symmetry transformation and t-patch operators as local symmetric operators 19</p> <p style="padding-left: 20px;">B. Algebra of patch charge operators and braided fusion higher category of charge objects 19</p> <p style="padding-left: 20px;">C. $\mathbb{Z}_2^{(1)}$ 1-symmetry in 2d space 22</p> <p style="padding-left: 20px;">D. The equivalence between \mathbb{Z}_2 0-symmetry and $\mathbb{Z}_2^{(1)}$ 1-symmetry in 2d space 24</p> <p>IX. A review of holographic theory of (algebraic higher) symmetry 24</p> <p style="padding-left: 20px;">A. Representation category 24</p> <p style="padding-left: 20px;">B. A holographic point view of symmetry 25</p> <p style="padding-left: 20px;">C. Transformation category – dual of the representation category 26</p> <p style="padding-left: 20px;">D. A simple example 26</p> <p style="padding-left: 40px;">1. Holographic view of 2d \mathbb{Z}_2 0-symmetry 26</p> <p style="padding-left: 40px;">2. Holographic view of 2d \mathbb{Z}_2 1-symmetry 27</p> <p style="padding-left: 40px;">3. Symmetry $\mathcal{R} = 2\text{Rep}_{\mathbb{Z}_2}$ and dual-symmetry $\tilde{\mathcal{R}} = 2\text{Vec}_{\mathbb{Z}_2}$ 27</p> <p>X. A derivation of topological holographic principle 27</p>
--	--

XI. Equivalent symmetries	28
A. Some known examples	28
B. Equivalence between anomalous and anomaly-free \mathbb{Z}_n and $\mathbb{Z}_{n_1} \times \mathbb{Z}_{n_2}$ symmetries in 1-dimensional space	29
XII. Summary – The essence of a symmetry	30
A. Local symmetric operator algebra and non-degenerate braided fusion 3-category – a 3-dimensional example without symmetry	31
B. Detailed calculations	32
1. Calculation of $F(s, s, s)$	32
2. Self-statistics of s particles	32
3. Mutual and self statistics of m, \tilde{m}, s particles in $\mathbb{Z}_2 \times \mathbb{Z}_2$ with mixed anomaly	33
C. Global action of 1+1D $\mathbb{Z}_2 \times \mathbb{Z}_2$ symmetry with mixed anomaly	34
D. 2d non-Abelian symmetry and its dual	34
1. The G 0-symmetry in 2d space	34
2. The $G_{\text{rep}}^{(1)}$ 1-symmetry in 2d space	35
References	37

I. INTRODUCTION

It is well known that symmetry, higher symmetry,[1–4] gravitational anomaly,[5, 6] and anomalous (higher) symmetry[7] can all constrain the properties of quantum many-body systems or quantum field theory.[3, 4, 8–32] Recently, motivated by anomaly in-flow[33–37] as well as the equivalence[38] between non-invertible gravitational anomalies[38–43] and symmetries, it was proposed that non-invertible gravitational anomalies, (higher) symmetries, anomalous symmetries,[7] algebraic higher symmetries,[44, 45] etc, can be unified by viewing all of them as shadow of topological order[46, 47] in one higher dimension.[38–41, 45, 48–53] A comprehensive theory was developed along this line.[44, 45, 53] More specifically, the properties of quantum many-body systems constrained by a non-invertible gravitational anomaly or a finite (anomalous and/or higher and/or algebraic) symmetry are the same as the boundary properties constrained by a bulk topological order in one higher dimension. Thus gravitational anomaly and/or finite symmetry can be fully replaced and is equivalent to topological order in one higher dimension. Such a point of view is called the *holographic point view of symmetry*.

To place the above holographic point view on a firmer foundation, we note that even though we use transformations described by groups or higher groups to define symmetries, in fact, a symmetry is not about transformations. What a symmetry really does is to select a set of local symmetric operators which form an algebra. The algebra of all local symmetric operators determines the possible quantum phases and phase transitions, as well as all other properties allowed by the symmetry. However,

the algebra of local symmetric operators does not contain symmetry transformations and it is hard to identify the corresponding symmetry group from such an algebra (but see Refs. 54 and 55 where symmetry is reconstructed using commutant algebras).

In this paper, we show that the algebra generated by local symmetric operators includes not only point-like local operators, but it also includes extended operators algebraically generated by local symmetric operators, such as string-like operators, membrane-like operators, *etc.* We find that a subclass of the extended operators – transparent patch operators – are important. These transparent patch operators reveal the symmetry selection sectors hidden in the algebra of local symmetric operators, and thus reveal the selection rules and the corresponding symmetry. Thus, isomorphic algebras of transparent patch operators give rise to equivalent symmetries.¹ Those isomorphic classes of algebra were referred to as **categorical symmetries** in Ref. 45 and 53, which, by definition, describe all known and unknown types of symmetries. However, the term “categorical symmetry” has also been used to refer to algebraic higher symmetry (*i.e.* non-invertible symmetry) by some authors. So here, we use **categorical symmetry** to stress that the term is used in the sense of Ref. 45 and 53.

We find that, for a finite symmetry in n -dimensional space, such an algebra of transparent patch operators determines a braided fusion n -category. If the algebra include all local symmetric operators, the braided fusion n -category will be non-degenerate. Further more, isomorphic algebras of transparent patch operators give rise to the same non-degenerate braided fusion n -category. Thus **categorical symmetries** are described by non-degenerate braided fusion n -categories, which happen to correspond to topological orders in one higher dimension.[44, 45] In other words, we suggest that group is not a proper description of symmetry, since (higher) symmetries and anomalous (higher) symmetries described by different (higher) groups can be equivalent. Finite symmetries are really described by non-degenerate braided fusion n -categories (*i.e.* topological orders in one higher dimension).

The calculation in this paper is based on operator algebra². A similar picture was obtained in Ref. 56 based on ground state and their excitations. The operator algebra discussed in this paper may be related to the nets of local observable algebras in Ref. 57 and topological net of extended defects in Ref. 58. See also Ref. 50 for related discussion on some of the examples discussed in this paper.

The holographic theory of symmetry allows us to identify equivalent (higher and/or anomalous) symmetries,

¹ Such equivalent symmetries were call holo-equivalent symmetries in Ref. 45.

² *i.e.* algebra generated by local symmetric operators (LSOs), which we will refer to as LSO algebra for short throughout the rest of the paper

that can look quite different. For example, two (higher and/or anomalous) symmetries can be realized at boundaries of two symmetry protected topological (SPT) states with those symmetries in one higher dimension. If after gauging the respected symmetries in the SPT states, we obtain the same topological order, then the two corresponding symmetries have the same categorical symmetry and are equivalent. This is a systematic way to identify equivalent symmetries and their categorical symmetry.

In Ref. 45 it was conjectured that *if two anomaly-free (invertible or non-invertible) symmetries described by local fusion higher categories, \mathcal{R} and \mathcal{R}' , are equivalent (i.e. have the equivalent monoidal center $\mathcal{Z}(\mathcal{R}) \simeq \mathcal{Z}(\mathcal{R}')$), then the two symmetries provide the same constraint on the physical properties.* This leads to the following conjecture: for any pair of equivalent symmetries, there is a lattice duality map, that maps a lattice model with one symmetry \mathcal{R} to a lattice model with another symmetry \mathcal{R}' . More specifically, the sets of local symmetric operators selected by the two symmetries, $\{O_{\mathcal{R}}\}$ and $\{O_{\mathcal{R}'}\}$, have an one-to-one correspondence and generate the same algebra, under such a duality map. The duality map also maps the lattice Hamiltonians (as sums of local symmetric operators) of the two lattice models into each other. The two lattice models have identical dynamical properties, e.g. they have identical energy spectrum in symmetric sub Hilbert space.[53] This can be viewed as the physical meaning of “equivalent symmetry”.

This conjecture is motivated and supported by the studies of some explicit examples of well known and new dualities. The notion of dual symmetry was introduced in Ref. 16 and 17 via gauging. Ref. 53 used Kramers–Wannier duality and its generalization to study the equivalence and its holographic understanding of 1d $\text{Rep}_{\mathbb{Z}_2}$ -symmetry (the \mathbb{Z}_2 0-symmetry) and $\text{Vec}_{\mathbb{Z}_2}$ -symmetry (the dual \mathbb{Z}_2 0-symmetry), as well as 2d $2\text{Rep}_{\mathbb{Z}_2}$ -symmetry (the \mathbb{Z}_2 0-symmetry) and $2\text{Vec}_{\mathbb{Z}_2}$ -symmetry (the $\mathbb{Z}_2^{(1)}$ 1-symmetry). Ref. 45 used a lattice duality map to study the equivalence and its holographic understanding of nd $n\text{Rep}_G$ -symmetry (the 0-symmetry described by a finite group G) and $n\text{Vec}_G$ -symmetry (the dual non-invertible $(n - 1)$ -symmetry). Ref. 56 studied the duality maps and holographic equivalence of 1d $\text{Rep}_{\mathbb{Z}_2}$ -symmetry, $\text{Vec}_{\mathbb{Z}_2}$ -symmetry, and $s\text{Rep}_{\mathbb{Z}_2}$ -symmetry (the 1d \mathbb{Z}_2^f fermionic symmetry). In the above examples, the duality map can be viewed as gauging process. In Ref. 59 and 60, a more general duality map between lattice systems is discussed via category theory and tensor network.

In this paper, we studied a duality between anomaly-free symmetry and anomalous symmetry. We obtain new duality maps between many pairs of equivalent symmetries, such as 1d $\mathbb{Z}_2 \times \mathbb{Z}_2$ symmetry with the mixed anomaly and anomaly-free \mathbb{Z}_4 symmetry (see Section XI for many more examples).

Viewing symmetry as topological order in one higher dimension generalizes the fundamental concept of symmetry. It allows us to describe new type of non-

invertible symmetries (also called algebraic (higher) symmetries)[45, 51, 61–64] that are beyond group and higher group, as well as new type of symmetries that are neither anomalous nor anomaly-free. But why do we want a more general notion of symmetry?

We know that symmetry can emerge at low energies. So we hope our notion of symmetry can include all the possible emergent symmetry. It turns out that the low energy emergent symmetries can be the usual higher and/or anomalous symmetries. They can also be non-invertible symmetries. They can even be symmetries that are neither anomalous nor anomaly-free. Therefore, we need a most general and unified view of higher and/or anomalous symmetries and beyond, if we want to use emergent symmetry as a guide to systematically understand or even classify gapless states of matter.

For example, using this generalized notion of symmetry, we gain a deeper understanding of quantum critical points. We find that the symmetry breaking quantum critical point for a symmetry described by a finite group G in n -dimensional space is the same as the symmetry breaking quantum critical point for an algebraic higher symmetry described by fusion n -category $n\text{Vec}_G$. [45, 53] In fact, both the ordinary symmetry described by group G and the algebraic higher symmetry (a non-invertible symmetry) described by fusion n -category $n\text{Vec}_G$ are present and are not spontaneously broken at this critical point. The G -symmetry and the algebraic higher symmetry $n\text{Vec}_G$ may give us a more comprehensive understanding of the symmetry breaking quantum critical point.

Symmetry can constrain the properties of a physical system. On the other hand, when certain excitations in a system have a large energy gap, below that energy gap, the system can have emergent symmetry, which can be anomalous and/or non-invertible.[45, 53, 65] In this case, we can use the emergent symmetry to reflect and to characterize the special low energy properties of the system below the gap. Here we make a preparation to go one step further. We intend to propose that the low energy properties and the emergent symmetries are the same thing. In other words, we intend to propose that the full emergent symmetry may fully characterize the low energy effective theory. We may be able to study and to classify all possible low energy effective theories by studying and classifying all possible emergent symmetries.

Such an idea cannot be correct if the above symmetries are still considered as being described by groups and higher groups. This is because the symmetries described by groups and higher groups are quite limited, and they cannot capture the much richer varieties of possible low energy effective theories. However, after we greatly generalize the notion of symmetry to algebraic higher symmetry, and even further to topological order in one higher dimensions – which includes (anomalous and/or higher) symmetries, (invertible and non-invertible) gravitational anomalies, and beyond – then it may be possible that

those generalized symmetries can largely capture the low energy properties of quantum many-body systems. This may be a promising new direction to study low energy properties of quantum many-body systems.

The above proposal is supported by the recent study of 1d gapless conformal field theory where a topological skeleton was identified for each conformal field theory.[66–68] Such a topological skeleton is a non-degenerate braided fusion category corresponding to a 2d topological order, where the involved conformal field theory is one of the gapless boundary.

The low energy properties of quantum many-body systems are described by quantum field theories. A systematic understanding and classification of low energy properties is equivalent to a systematic understanding and classification of quantum field theories. Thus the holographic view of symmetry can have an impact on our general understanding of quantum field theories. Using this holographic point of view of symmetry, one can also obtain a classification of topological order and symmetry protected topological orders, with those generalized symmetry, for bosonic and fermionic systems, and in any dimensions.[44, 45]

The holographic point view of symmetry has a close relation to AdS/CFT duality, where a boundary CFT and a bulk quantum gravity in AdS space determine each other. In the holographic point view of symmetry, there is a topological holographic principle: *boundary determines bulk, while bulk does not determine boundary*. In this paper, we give the above statement a more precise meaning which allows us to derive the topological holographic principle. We regard *boundary* as an algebra of local boundary operators. From the algebra of local boundary operators, we can obtain the sub-algebra of a special class of extended operators – transparent patch operators, which in turn encodes a non-degenerate braided fusion (higher) category. This category describes a topological order in one higher dimension, which is the *bulk*. We see that *boundary uniquely determines bulk*.

II. NOTATIONS AND TERMINOLOGY

In this paper, we will use $n+1$ D to represent spacetime dimensions, and nd to represent spatial dimensions. We will use mathcal font $\mathcal{A}, \mathcal{B}, \mathcal{C}$ to describe fusion categories, and euscript font $\mathcal{A}, \mathcal{B}, \mathcal{C}$ to describe braided fusion categories. We will use the theorem style **Definition^{ph}** to provide “physical definitions”, which serve the purpose of introducing concepts without delving into mathematical rigor.

Let us also remark on some terminology. In this paper we use **categorical symmetry** to mean the combination of symmetry and dual symmetry [53]. If a **categorical symmetry** is finite, it turns out that the **categorical symmetry** corresponds to a topological order [69, 70] in one higher dimension.[44, 45] Such a topological order in one higher dimension has also been referred to as symmetry topo-

logical field theory (symmetry TFT) in the field theory literature.[71] In this context, one describes the topological operators corresponding to the (finite) symmetries of a quantum field theory in d dimensions in terms of the topological excitations of a corresponding TFT in $d+1$ dimensions. The symmetry data are encoded in the global topological properties of this TFT, which may be described in the form of some action. However, such an action is not necessarily unique. So one should keep in mind that “symmetry TFT” really refers to the topological data of the theory which is independent of the fields one uses to describe it. The topological data encoded by such a TFT may also be captured by a lattice model exhibiting topologically ordered ground states. In this limit, the two notions of symmetry TFT and categorical symmetry coincide. This concept was also explored under the name of “topological symmetry” in Ref. 72.

Let us note that in physics contexts, one usually interprets topological field theory as a particular kind of *field theory*, *i.e.* a theory in terms of smoothly varying fields. If we have a lattice regularization in mind for the field theory, we must first take the limit where the lattice spacing vanishes. Under such an interpretation, topological field theory describes a topological order near a critical point, where the smoothly varying field describes the long wavelength fluctuations near the critical point. Since a topologically ordered phase can have many different phase boundaries described by different critical points, it is common that different topological field theories can describe the same topological order. Moreover, for continuous or infinite symmetry, **categorical symmetry** does not correspond to topological order or symmetry TFT in one higher dimension. We need some generalization of fusion categories with an infinite number of objects to describe such symmetries. Whatever this generalization is, it is clear that the notion of **categorical symmetry** for such symmetries is more general than topological order/TFT in one higher dimension.

In this paper, we conjecture that **categorical symmetry** (as the combination of symmetry and dual symmetry) corresponds to equivalence class of isomorphic algebra of transparent patch operators. So we will use this as a more precise definition of **categorical symmetry**. We conjecture that, in n -dimensional space, **categorical symmetry** (as equivalence class of isomorphic algebras of transparent patch operators) is described by non-degenerate braided fusion n -category. For continuous or infinite symmetry, the corresponding braided fusion n -category will have infinite objects/morphisms. We will discuss some simple examples to support our conjecture.

In this paper, we also interpret *quantum field theory* as an algebra of local operators, along with a Hamiltonian. Under such an interpretation, the algebra of local operators may have an energy dependence: we may exclude some local operators that generate high energy excitations. Then, the remaining local operators may generate a different algebra. This low energy operator algebra gives rise to emergent **categorical symmetry**. We propose

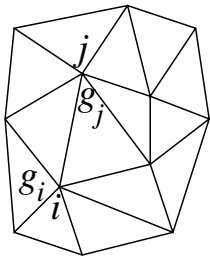

FIG. 1. A 2d lattice bosonic model, whose degrees of freedom live on the vertices and are labeled by the elements in a set: $g_i \in G$

that the full low energy emergent categorical symmetry may largely characterize gapless liquid states.

Similarly, we also interpret *boundary* of a topological order as an algebra of local boundary operators along with a boundary Hamiltonian. Here, the local boundary operators only create excitations with energy less than the bulk energy gap which is assumed to be infinite. Under such an interpretation, we see a close connection between quantum field theory and boundary of topological order.

We would like to point out that categorical symmetry (as non-degenerate braided fusion n -category \mathcal{M}) is not algebraic higher symmetry [44, 45] nor fusion category symmetry [51]. The latter are described by local fusion higher category \mathcal{R} . In fact, the categorical symmetry \mathcal{M} is given by the center of \mathcal{R} [44, 45]

$$\mathcal{M} = \mathcal{Z}(\mathcal{R}). \quad (1)$$

III. BOSONIC QUANTUM SYSTEM AND ITS ALGEBRA OF LOCAL OPERATORS

A. Total Hilbert space, local operator algebra, and local Hamiltonian

A lattice bosonic quantum system is defined by four components:

1. A triangulation of space (see Fig. 1).
2. A total Hilbert space

$$\mathcal{V} = \bigotimes_i \mathcal{V}_i, \quad (2)$$

where $\mathcal{V}_i = \text{span}\{|g\rangle \mid g \in G\}$ is the local Hilbert space on vertex- i . The basis vectors of \mathcal{V}_i are labeled by the elements in a finite set G .

3. An **algebra of local operators** formed by all the local operators, $\mathcal{A} = \{O_i\}$. Here **local operator** is defined as an operator O_i that acts within the tensor product of a few nearby local Hilbert spaces, say near a vertex- i .

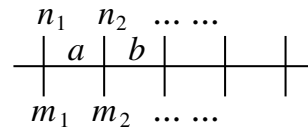

FIG. 2. The matrix elements of a string-like tensor network operator, $O_{m_1, m_2, \dots; n_1, n_2, \dots}$, can be given by a contraction of rank-4 tensors $T_{n_2, m_2, a, b}$, etc. Each tensor is represented by a vertex, where the legs of the vertex correspond to the indices of the tensor. The connected legs have the same index and is summed over (which correspond to the tensor contraction). This is just one representation of tensor network operator.

4. A local Hamiltonian $H = -\sum_i O_i$ which is a sum of hermitian local operators.

B. Transparent patch operators

The algebra of local operators will play a central role in this paper. This algebra, which is generated by the local operators, does not only contain local operators but, beyond 0-dimensional space, also contains the products of local operators. These products can generate extended operators that can be string-like, membrane-like, etc. Thus the closure of the algebra of local operators must contain those extended operators. An algebra of local operators may have many different extensions. Since we are going to use the algebra of local operators to describe symmetries, we will consider a particular extension. We would like to organize those local and extended operators into point operators, string operators, disk operators, etc, with a special transparency property. We refer to these operators generally as transparent patch operators. More precisely,

Definition^{ph} 1. a *patch operator* is a *tensor network operator* (see Fig. 2). It also has the following form

$$O_{\text{patch}} = \sum_{\{a_i\}} \Phi(\{a_i\}) \prod_{i \in \text{patch}} O_i^{a_i} \quad (3)$$

where “patch” has a topology of n -dimensional disk, $n = 0, 1, 2, \dots$. A **transparent patch (t-patch) operator** is a patch operator that satisfies the following **transparency condition** (or **invisible-bulk condition**):

$$O_{\text{patch}} O_{\text{LSO}} = O_{\text{LSO}} O_{\text{patch}}, \quad (4)$$

if the boundaries of the patch, ∂patch is **far away** from the LSO O_{LSO} . The above condition is also equivalent to

$$O_{\text{patch}} O_{\text{patch}'} = O_{\text{patch}'} O_{\text{patch}}, \quad (5)$$

if the boundaries of two patches, ∂patch and $\partial \text{patch}'$, are not linked and are **far away** from each other.

In the above definition, $O_i^{a_i}$'s are local operators acting near vertex- i . For each vertex, there can be several different local operators (including the trivial identity operator) which are labeled by a_i . $\prod_{i \in \text{patch}} O_i^{a_i}$ is a product of those local operators over all the vertices i in the patch. Different choices of $\{a_i\}$ give rise different operator pattern. $\sum_{\{a_i\}} \Phi(\{a_i\})$ is the sum of all operator pattern with complex weight $\Phi(\{a_i\})$. One may think $O_i^{a_i}$'s create different types of particles labeled by a_i at vertex- i . Then $O_{\text{patch}} = \sum_{\{a_i\}} \Phi(\{a_i\}) \prod_{i \in \text{patch}} O_i^{a_i}$ creates a quantum liquid state of those particles on the patch. The quantum liquid state is described by the many-body wave function $\Phi(\{a_i\})$.

In the above definition, we also used a notion of *far away* which is not rigorously defined. To define such a notion, we first introduce a notion of **small local** operators as operators acting on vertices whose separations are less than a number L_{op} . (The separations between two vertices is defined as the minimal number of links connecting the two vertices.) In the rest of this paper, the terms ‘‘local operator’’ and ‘‘0-dimensional patch operator’’ will refer to this kind of small local operators.

However, the algebra of small local operators contains **big local** operators, acting on vertices whose separations are larger than the number L_{op} . ‘‘ n -dimensional patch operator’’ for $n > 0$ refer to those big local operators. The notion of far away means further than the distance L_{op} . When we take the large system size limit: $L_{\text{sys}} \rightarrow \infty$, we also assume $L_{\text{op}} \rightarrow \infty$ and $L_{\text{op}}/L_{\text{sys}} \rightarrow 0$. We will see in this paper that it is this particular way to take the large system size limit that ensures the algebra of small local operators to contain large extended operators. Such an algebra of small local operators and large extended operators in n -dimensional space have a structure of *non-degenerate braided fusion n -category*. This emergent phenomenon is the key point of this paper.

There is another important motivation to introduce transparent patch operators. The bulk of transparent patch operators is invisible. Thus a transparent open string operator can be viewed as two point-like particles, one for each string end. A transparent disk operator can be viewed as a closed string at the boundary of the disk. In general, a transparent patch operator gives rise to an extended excitation in one lower dimension, corresponding to the boundary of the patch. Later we will see that those point-like, string-like, *etc* excitations can fuse and braid, forming a braided fusion category that describe the operator algebra.

The boundaries of transparent patch operators can be viewed as charged particles, although the patch operators are formed by LSO's that carry no symmetry charge. The boundaries of transparent patch operators can also be viewed as fractionalized particles, which may carries fractionalized degrees of freedom and/or fractionalized quantum numbers. So the boundaries of transparent patch operators reveal the selection sectors of a symmetry. Such selection sectors are hidden in the algebra generated by the LSOs.

C. Patch symmetry and patch charge operators

Symmetry transformation operators and symmetry-charge creation operators play important roles in our theory about symmetry (including higher symmetry and algebraic higher symmetry). Those operators also appear in our setup of local operator algebra after we include the extended operators.

Definition^{ph} 2. A t -patch operator is said to have an **empty bulk** if $O_i^{a_i} = \text{id}_i$ for all i 's far away from the boundary of the patch. A t -patch operator with an empty bulk is also referred to as a **patch charge operator**. A t -patch operator with non-empty bulk is referred to as a **patch symmetry operator** (see Section IV B for a concrete example).

We would like to remark that due to the transparency condition eqn. (5), a charge patch operator always commutes with symmetry transformation operator (acting on the whole space for 0-symmetry, or closed sub-manifold for higher symmetries). Thus the patch charge operator always carry zero total charge. So the patch charge operators are not charged operators, since charged operators do not commute with symmetry transformations. The patch charge operators defined above are something like operators that create a pair of charge and anti-charge, which correspond to a charge fluctuations with vanishing total net charge.

We want to point out that the definition 2 is not that important physically, since the notations of *charge* and *symmetry transformation* are not the notions of algebra of local operators. They are the notions of a representation of an operator algebra. For different representations of the same operator algebra, the same operator in the algebra can some times be patch charge operator and other times be patch symmetry operator.

In next section, we will discuss a concrete simple example: a bosonic system in 1-dimensional space with \mathbb{Z}_2 symmetry, to illustrate the above abstract definition. We will give the explicit form of t -patch operators, to show how they reveal a braided fusion category in the algebra of local operators. In Appendix A, we will discuss an example of bosonic system in 3-dimensional space without symmetry. We will illustrate how they give rise to a non-degenerate braided fusion 3-category $3\mathcal{Vec}$.

D. Algebra of t -patch operators and Categorical symmetry

The symmetric Hamiltonian is a sum of local symmetric operator $H = \sum_i O_i^{\text{symm}}$. If our measurement equipments do not break the symmetry, then the measurement results are correlations of local symmetric operators. We see that a symmetry is actually described by the algebra of local symmetric operators, rather than by the symmetry transformations. Or more precisely, symmetry is

defined by the commutant algebra of local symmetric operators. Here a commutant algebra of a local operator algebra is formed by all the operators (local or non-local) that commute with all the operators in the local operator algebra. In particular

Isomorphic commutant algebras \leftrightarrow Equivalent symmetry. (6)

In this paper, we will view symmetry from this operator algebra point of view:

Definition^{Ph} 3. A **categorical symmetry** is an equivalence class of isomorphic commutant algebra.

We remark that if the operator algebra contains all the local operators in a lattice model, then the **categorical symmetry** is trivial, describing a trivial symmetry (*i.e.* no symmetry). If the local operator algebra contain only a subset of local operators (such as containing only symmetric local operators), then the **categorical symmetry** is non-trivial. Also note that categorical symmetry is different from the usual symmetry defined via the symmetry transformations. Two symmetries defined by different symmetry transformations may have isomorphic algebra of local symmetric operators. In that case, the two symmetries correspond to the same categorical symmetry, and are said to be equivalent.

IV. A 1d BOSONIC QUANTUM SYSTEM WITH \mathbb{Z}_2 SYMMETRY

In this section, we consider the simplest symmetry – \mathbb{Z}_2 symmetry in one spatial dimension. A bosonic system with \mathbb{Z}_2 symmetry is obtained by modifying the algebra of the local operators. For convenience, let us assume the degrees of freedom live on vertices, which are labeled by elements in the \mathbb{Z}_2 group +1 and -1.

A. \mathbb{Z}_2 symmetry and its algebra of local symmetric operators

In the standard approach, a symmetry is described by a symmetry transformation, which has the following form for our example:

$$W = \bigotimes_{i \in \text{whole space}} X_i, \quad X = \begin{pmatrix} 0 & 1 \\ 1 & 0 \end{pmatrix}. \quad (7)$$

Since $W^2 = 1$ which generates a \mathbb{Z}_2 group, we call the symmetry a \mathbb{Z}_2 symmetry. We can use the \mathbb{Z}_2 transformation W to define an algebra of local operators:

$$\mathcal{A} = \{O_i^{\text{symmm}} \mid O_i^{\text{symmm}} W = W O_i^{\text{symmm}}\} \quad (8)$$

The local operator O_i^{symmm} , satisfying $O_i^{\text{symmm}} W = W O_i^{\text{symmm}}$, is called *local symmetric operator*.

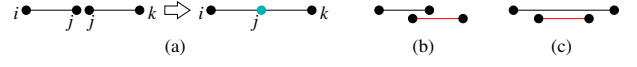

FIG. 3. (a) “Fusion” of two string operators. (b) Non-trivial “braiding” between two string operators. (c) Trivial “braiding” between two string operators.

To see the connections between operator algebra and braided fusion category, we use the t-patch operators introduced in last section to organize the local symmetric operators:

- 0-dimensional t-patch operators: $X_i, Z_i Z_{i+1}$,

$$\text{where } Z = \begin{pmatrix} 1 & 0 \\ 0 & -1 \end{pmatrix}.$$

- 1-dimensional t-patch operators – string operators: for $i < j$

$$Z_{\text{str}_{ij}} = Z_i Z_j, \quad Z_{\text{str}_{ji}} \equiv Z_{\text{str}_{ij}}^\dagger, \quad (9)$$

where the string $_{ij}$ connects the vertex- i and vertex- j . The above string operator has an empty bulk and is called as patch charge operator. We have another string operator: for $i < j$

$$X_{\text{str}_{ij}} = X_{i+1} X_{i+2} \cdots X_j, \quad X_{\text{str}_{ji}} \equiv X_{\text{str}_{ij}}^\dagger. \quad (10)$$

Note that the boundaries of X -strings actually live on the links $\langle i, i+1 \rangle$ and $\langle j, j+1 \rangle$. We labeled those links by i, j . This leads to the special choice of the boundary of the string operator. The second string operator has a non trivial bulk, which generates our \mathbb{Z}_2 symmetry.

We remark that, in general, the operators in the string may not commute and the order of the operator product will be important in that case. Here we adopted a convention that in string operator $O_{\text{str}_{ij}}$, the operators near i appear on the left side of the operators near j .

In terms of t-patch operators, algebra of local symmetric operators takes the following form (only important operator relations are listed)

$$Z_{\text{str}_{ij}} Z_{\text{str}_{jk}} = Z_{\text{str}_{ik}}, \quad (11)$$

$$X_{\text{str}_{ij}} X_{\text{str}_{jk}} = X_{\text{str}_{ik}}, \quad (12)$$

$$Z_{\text{str}_{ij}} X_{\text{str}_{kl}} = -X_{\text{str}_{kl}} Z_{\text{str}_{ij}}, \quad (i < k < j < l) \quad (13)$$

$$Z_{\text{str}_{ij}} X_{\text{str}_{kl}} = +X_{\text{str}_{kl}} Z_{\text{str}_{ij}}, \quad (\text{else}) \quad (14)$$

Eqn. (11) and (12) describe the fusion of string operators (see Fig. 3a). The commutator between the two kinds of string operators depends on their relative positions. If one string straddles the boundary of the other string, such as $i < k < j < l$ as in Fig. 3b, commutator has a non-trivial phase. Otherwise (see Fig. 3c), the string operators commute, which ensure the string operators are indeed *transparent* patch (t-patch) operators. All such

“non-straddling” orderings of i, j, k, l are understood to be captured in eqn. (14). In Section IV F, we will discuss the full algebra of extended t-patch operators in more detail.

B. Patch symmetry transformation

We note that Z_i operator transforms as the non-trivial representation of \mathbb{Z}_2 group:

$$WZ_iW^{-1} = -Z_i. \quad (15)$$

Thus we say Z_i carries a non-trivial representation, or more commonly, a non-trivial \mathbb{Z}_2 charge. The string operator Z_{str} is formed by two \mathbb{Z}_2 charges and carry a trivial total \mathbb{Z}_2 charge. In fact, by definition, all local symmetric operators carry trivial \mathbb{Z}_2 charge (see later discussion).

We have stressed that a symmetry is fully characterized by its algebra of local symmetric operators. But all those local symmetric operators carry no symmetry charge. It appears that a key component of symmetry, the symmetry charge (*i.e.* the symmetry representation) is missing in our description.

In fact, the symmetry representation can be recovered. As pointed out in Ref. 53, there is a better way to describe symmetry transformations using t-patch operators. We notice that the only use of the symmetry transformations is to select local symmetric operators. After that we no longer need the symmetry transformations. Since local symmetric operators are local, we do not need the symmetry transformations that act on the whole space. We only need symmetry transformations that act on patches to select local symmetric operators. This motivates us to introduce patch symmetry transformation

$$W_{\text{patch}} = \bigotimes_{i \in \text{patch}} X_i. \quad (16)$$

We can use the patch symmetry transformation W_{patch} to define the local symmetric operators:

$$\mathcal{A} = \{O_i^{\text{symm}} \mid O_i^{\text{symm}} W_{\text{patch}} = W_{\text{patch}} O_i^{\text{symm}}, \quad i \text{ far away from } \partial \text{patch}\}. \quad (17)$$

So a symmetry can also be defined via the patch symmetry transformations.

For the \mathbb{Z}_2 symmetry in 1-dimensional space, the patch symmetry transformations happen to be generated by one of the string operators with non-empty bulk, X_{str} , and this is why we call them patch symmetry operators. In this example, we also see that the string operator $Z_{\text{str}_{ij}}$ with empty bulk corresponds to a charge-anti-charge pair operator. This is the why we call t-patch operators with empty bulk as patch charge operators.

The patch symmetry transformations have an advantage that they can detect the symmetry charge hidden in the patch charge operators (which have zero total charge): when the patch charge operator Z_{str} straddle the



FIG. 4. Non-trivial “braiding” between two string operators, the patch symmetry operator (the solid line) and the patch charge operator (the dashed-line), measures the symmetry charge carried by boundary of patch charge operator, if the patch symmetry operator generates the symmetry.

boundary of the patch symmetry transformation W_{patch} , the two operators have a non-trivial commutation relation:

$$Z_{\text{str}}W_{\text{patch}} = -W_{\text{patch}}Z_{\text{str}}. \quad (18)$$

This non-trivial commutation relation measures the charge carried by one end of the string operator.

If we view the order of the operator product as the order in time, and view the string as world line of a particle in spacetime (see Fig. 4), then the commutation relation eqn. (18) can be viewed as a braiding of the charged particle around the boundary of the patch symmetry operator. The boundary of the patch symmetry operator can be viewed as a “symmetry twist flux”. The charge is measured by a braiding of symmetry charge around symmetry twist flux. This is why we refer to eqn. (13) and eqn. (14) as “braiding” relations in Fig. 3.

C. The algebra of patch charge operators and its braided fusion category

Let us concentrate on patch charge operators. The properties of the charges of a symmetry can be systematically and fully described by a braided fusion category. To connect the \mathbb{Z}_2 symmetry charges to fusion category, we view the local symmetric operators O_i^{symm} as the morphisms, and the ends of string operator $Z_{\text{str}_{ij}}$ (*i.e.* the point-like \mathbb{Z}_2 -charge) as objects e_i and \bar{e}_j in a fusion category. In other words, we write the string operator as

$$Z_{\text{str}_{ij}} = T_e(i \rightarrow j). \quad (19)$$

The notation $T_e(i \rightarrow j)$ is more precise and carries several meanings. (1) We view $T_e(i \rightarrow j)$ as a world-line of a particle labeled by e that travels from i to j . $T_e(i \rightarrow j)$ can also be viewed as a hopping operator of e from i to j . Here, we have adopted a convention that the arrow indicate the direction of the hopping. (2) The notation of string operator $T_e(i \rightarrow j)$ also specify the ordering of operators: the operators near left index i appears to the left of the operators near the right index j .

Since the local symmetric operators $Z_{\text{str}_{ii'}}$ (the morphisms) can move the string ends (the \mathbb{Z}_2 -charges):

$$e_i \xrightarrow{O_i^{\text{symm}}} e_{i'}, \quad e_{i'} \xrightarrow{O_{i'}^{\text{symm}}} e_i, \quad (20)$$

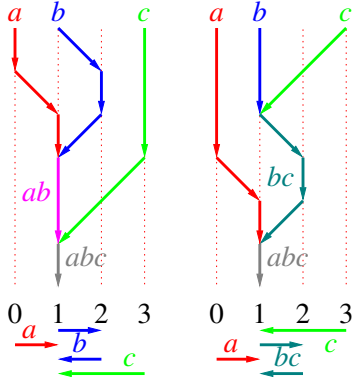

FIG. 5. Two ways to fuse three particles a, b, c into abc , as operator product. The phase difference of the two resulting operators is $F(a, b, c)$. The horizontal lines and the corresponding 45° lines correspond to hopping operators. For example $1 \xrightarrow{b} 2 \sim T_b(1 \rightarrow 2)$. The hopping operators with higher location are applied first. Thus we have the relation $T_c(3 \rightarrow 1)T_b(2 \rightarrow 1)T_a(0 \rightarrow 1) = F(a, b, c)T_a(0 \rightarrow 1)T_c(3 \rightarrow 1)T_b(2 \rightarrow 1)$.

the \mathbb{Z}_2 -charges (at the string ends) at different places are isomorphic $e_i \cong e_{i'}$, *i.e.* they belong to the same type of excitations. More generally, two excitations that can be connected by local symmetric operators are regarded as the same type of excitations.

From the above expression of t-patch operators, we can compute the fusion ring

$$a \otimes b = \bigoplus_c N_c^{ab} c \quad (21)$$

of the braided fusion category. Notice that $T_e(-\infty \rightarrow i)$ creates an e particle at i (and creates another particle at $-\infty$ which we ignore). Creating two e particles, we obtain

$$T_e(-\infty \rightarrow i)T_e(-\infty \rightarrow i) = \text{id}. \quad (22)$$

In other words, we get a trivial particle $\mathbf{1}$. This allows us to obtain the fusion rule

$$e_i \otimes e_i = \mathbf{1}. \quad (23)$$

The isomorphic relation is an equivalence relation. After quotienting out the equivalence relation, $e_i \cong e_j$, we find that the fusion category has only two objects: $\mathbf{1}, e$. The morphism of the fusion category is given by local symmetric operators O_i^{symm} near a vertex- i . Also, with this equivalence relation, we can interpret eqn. (23) as

$$e \otimes e = \mathbf{1}, \quad (24)$$

which tells us that the e particle is its own anti-particle.

However, the fusion rule N_c^{ab} fails to completely determine the fusion category, because it is possible for two different fusion categories to have the same fusion ring. To complete the description of the fusion category, we

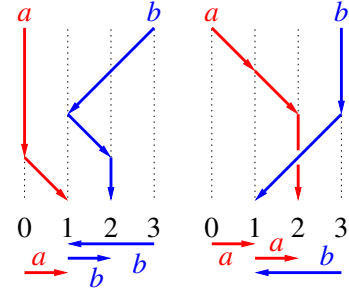

FIG. 6. The two ways of a, b particle hopping give rise to two configurations which exchange their positions. When $a = b$, the phase difference of the two resulting operators is $e^{i\theta_a}$, which is the self statistics of the a -particle. Thus we have a relation $T_b(3 \rightarrow 1)T_b(1 \rightarrow 2)T_a(0 \rightarrow 1) = e^{i\theta_a}T_a(0 \rightarrow 1)T_b(1 \rightarrow 2)T_b(3 \rightarrow 1)$.

also need to compute the F -symbol, which is defined as the relative phases of different ways to fuse three particles a, b, c together, $a \otimes b \otimes c \rightarrow (ab) \otimes c \rightarrow (ab)c$ and $a \otimes b \otimes c \rightarrow a \otimes (bc) \rightarrow a(bc)$ (see Fig. 5), if we treat the result of fusion, as quantum state or as operator:

$$\begin{aligned} |(ab)c\rangle &= F(a, b, c)|a(bc)\rangle, \\ O((ab)c) &= F(a, b, c)O(a(bc)). \end{aligned} \quad (25)$$

Following Ref. 73, the F -symbol is computed from the relative phase of the two ways to compute operator products in Fig 5. It is trivial to check that

$$\begin{aligned} &T_e(1 \rightarrow 2)T_e(0 \rightarrow 1)T_e(2 \rightarrow 1)T_e(3 \rightarrow 1) \\ &\equiv Z_{\text{str}_{12}}Z_{\text{str}_{01}}Z_{\text{str}_{12}}^\dagger Z_{\text{str}_{13}}^\dagger \\ &= Z_{\text{str}_{13}}^\dagger Z_{\text{str}_{01}} \\ &= T_e(3 \rightarrow 1)T_1(1 \rightarrow 2)T_e(0 \rightarrow 1)T_1(2 \rightarrow 1) \end{aligned} \quad (26)$$

therefore $F(e, e, e) = 1$. Similarly, we can show that $F(\mathbf{1}, \mathbf{1}, \mathbf{1}) = F(e, \mathbf{1}, \mathbf{1}) = F(\mathbf{1}, e, \mathbf{1}) = F(\mathbf{1}, \mathbf{1}, e) = F(e, e, \mathbf{1}) = F(e, \mathbf{1}, e) = F(\mathbf{1}, e, e) = 1$, since the hopping operators of e and $\mathbf{1}$ particles all commute. This implies that the category formed by $\mathbf{1}, e$ and described by data N_c^{ab} , $F(a, b, c)$ is a fusion category $\mathcal{R}\text{ep}_{\mathbb{Z}_2}$ – the fusion category of the representations of \mathbb{Z}_2 group.

In fact, the $\mathbf{1}, e$ particles not only form a fusion category, they actually form a braided fusion category. To calculate the braiding properties, we first calculate the self statistics of e particle using the statistical hopping algebra prescription introduced in Ref. 74 and depicted in Fig 6,

$$\begin{aligned} &T_e(0 \rightarrow 1)T_e(1 \rightarrow 2)T_e(3 \rightarrow 1) \\ &= Z_{\text{str}_{01}}Z_{\text{str}_{12}}Z_{\text{str}_{13}}^\dagger \\ &= e^{i\theta_e}Z_{\text{str}_{13}}^\dagger Z_{\text{str}_{12}}Z_{\text{str}_{01}} \\ &= e^{i\theta_e}T_e(3 \rightarrow 1)T_e(1 \rightarrow 2)T_e(0 \rightarrow 1) \end{aligned} \quad (27)$$

from which we can read off the self-statistical angle $e^{i\theta_e} = 1$. This shows that e particles have *bosonic* self-statistics. We can also use Fig 7 to compute mutual

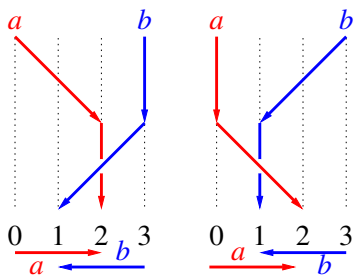

FIG. 7. The two ways of a, b particles hopping give rise to the same final configuration but via different braiding paths. The phase difference of two hopping processes is $e^{i\theta_{ab}}$, which is the mutual statistics of the a - and b -particles. Thus we have a relation $T_b(3 \rightarrow 1)T_a(0 \rightarrow 2) = e^{i\theta_{ab}}T_a(0 \rightarrow 2)T_b(3 \rightarrow 1)$.

statistics of $\mathbf{1}, e$ particles. We find that $\mathbf{1}, e$ particles are bosons with trivial mutual statistics. This implies that the category formed by $\mathbf{1}, e$ is a braided fusion category $\text{Rep}_{\mathbb{Z}_2}$. It is actually a special braided fusion category called symmetric fusion category, since all the mutual statistics are trivial.

According Tannaka duality, the symmetric fusion category $\text{Rep}_{\mathbb{Z}_2}$ can fully describe the symmetry group $G = \mathbb{Z}_2$. So, instead of using a group G (formed by the transformations), we can also use a symmetric fusion category of patch charge operators (*i.e.* formed by charged objects or the representations) to fully describe a symmetry.

D. Representation category and symmetry

Above picture also works for generic finite group G : a symmetry G can also be described by a symmetric fusion category Rep_G (formed by the representations of G). This is the categorical point of view of symmetry, which was used in Ref. 44 and 75 and will be used in this paper. The symmetric fusion category generated by patch charge operators is nothing but the mathematical framework that describes the properties of symmetry charges (such as their fusion and braiding).

Definition^{Ph} 4. We will call the symmetric fusion category \mathcal{R} formed by patch charge operators as **representation category**. [32]

In fact, there is another definition of representation category. We may ignore the braiding structure and consider the fusion category \mathcal{R} formed by patch charge operators. Instead of the braiding structure, we consider a symmetry-breaking structure, *i.e.* a faithful functor $\beta : \mathcal{R} \rightarrow \text{Vec}$ (which is also called fiber functor) that describe the process of ignoring the symmetry:

Definition^{Ph} 5. If a fusion category \mathcal{R} has a fiber functor β , then the pair (\mathcal{R}, β) will be called a **local fusion category**. Such a local fusion category can also be viewed as the **representation category** of the symmetry. [45].

In higher dimension, the notion of symmetric fusion higher category used in Ref. 44 may be hard to define. In this case, the second Definition 5 is can be used as in Ref. 45.

Thus we can say that an anomaly-free symmetry in 1-dimensional space described by a finite group G is fully described by its representation category, a symmetric fusion category Rep_G or a local fusion category (Rep_G, β) . This point of view can be generalized to described anomaly-free symmetries beyond group and higher group. In Ref. 45, it is proposed that the most general anomaly-free symmetries in n -dimensional space are fully described by **local fusion n -categories** (\mathcal{R}, β) . Such a description includes non-invertible symmetries (*i.e.* algebraic higher symmetries).

In the above we have used a notion of **anomaly-free symmetry**. For symmetry described by group and/or higher group, an anomaly-free symmetry is defined as a symmetry that can be gauged. But such a definition does not apply to non-invertible symmetries, for which we do not how to gauge them. To solve this problem, Ref. 45 proposed the following macroscopic definition without using gauging

Definition^{Ph} 6. **Anomaly-free symmetry** is the symmetry that allows non-degenerate symmetric gapped states for any closed space manifolds.

A microscopic definition was also proposed

Definition^{Ph} 7. **Anomaly-free symmetry** is the symmetry that allows symmetric state of form $|\Psi\rangle = \bigotimes_i |\psi_i\rangle$, where $|\psi_i\rangle$ is a symmetric state on site- i .

We would like to remark that representation categories (*i.e.* symmetric fusion n -categories or local fusion n -categories) only fully describe anomaly-free symmetries, but fail to fully describe anomalous symmetries. This is because different anomalous symmetries can have the same representation category. In fact, an anomalous symmetry G can be described by symmetry transformations W_g , $g \in G$: $W_g W_h = W_{gh}$ that may not be on-site. The non-invariant local operators that form representations of of the symmetry group G . Thus

Proposition 1. all the different anomalous symmetries of the same group G have the same representation category Rep_G .

Later in Section VII, we will give a 1d example of emergent $\mathbb{Z}_2 \times \mathbb{Z}_2$ symmetry, whose representation category formed by the $\mathbb{Z}_2 \times \mathbb{Z}_2$ charge is not a local fusion category. This implies that the emergent $\mathbb{Z}_2 \times \mathbb{Z}_2$ symmetry is not an anomaly-free symmetry, since the representation categories of all anomaly-free symmetries are local fusion categories. This also implies that the emergent $\mathbb{Z}_2 \times \mathbb{Z}_2$ symmetry is not an anomalous symmetry (in the usual sense), since the representation categories of all anomalous symmetries are also described by local fusion categories. Here we have an example of an emergent symmetry that is neither anomalous nor anomaly-free.

E. The algebra of patch symmetry operators and its braided fusion category – transformation category

In the above, we show that the operator algebra of a class of string operators, the patch charge operators Z_{str} , gives rise to a symmetric fusion category $\text{Rep}_{\mathbb{Z}_2}$. In this section, we are going to consider the operator algebra of another class of t-patch operators X_{str} , the patch symmetry operators, and show that they give rise to a fusion category $\text{Vec}_{\mathbb{Z}_2}$ which happens to be isomorphic to $\text{Rep}_{\mathbb{Z}_2}$.

Patch symmetry operators are defined by restricting the global symmetry to finite patches as discussed in Sec IV B (assume $i < j$)

$$W_{\text{patch}_{ij}} = X_{\text{str}_{ij}} = X_{i+1} \cdots X_{j-1} X_j. \quad (28)$$

Since the bulk of a patch symmetry operator is invisible, it is completely legitimate to think of the boundary of the 1d patch symmetry operator as particles. We can define a fusion operation of those particles, which is called m .³ Analogous to the discussion in the previous subsection, we may construct a braided fusion category corresponding to these m particles.

To do so, we can think of these patch symmetry operators as operators that transport m particles from one point to another on the one-dimensional space

$$W_{\text{patch}_{ij}} = T_m(i \rightarrow j), \quad (29)$$

The above can also be viewed as a world-line of m particle from i to j . In fact, the m particle live on the link, such as $\langle i, i+1 \rangle$. In the above, we view such a m particle as located at i .

We can work out the fusion of the m particles as we did for the e particles in Sec IV C. From

$$T_m(-\infty \rightarrow i) T_m(-\infty \rightarrow i) = \text{id} \quad (30)$$

we find the fusion rule $m \otimes m = \mathbf{1}$. It tells us that the m particles are their own antiparticles.

Next, we work out F -symbol from Fig. 5. We find that $F(a, b, c) = 1$ for $a, b, c = \mathbf{1}, m$. This is not surprising because the patch operators all commute with each other since they are just products of Pauli X operators and identity operators. Thus $\mathbf{1}, m$ form a fusion category $\text{Vec}_{\mathbb{Z}_2}$, which is isomorphic to $\text{Rep}_{\mathbb{Z}_2}$.

$\mathbf{1}, m$ also have a braiding structure and form a braided fusion category. Using Fig. 6, we find that m particles have trivial self-statistics. Using Fig. 7, we find that $\mathbf{1}$ and m particles have trivial mutual statistics. This allows us to show that $\mathbf{1}, m$ form a symmetric fusion category $\text{Vec}_{\mathbb{Z}_2}$.

Definition^{ph} 8. We will call the symmetric fusion category \mathcal{T} formed by patch symmetry operators as **transformation category**. [32]

Similar to representation category, we believe that the transformation category in n -dimension space can also be described by local fusion n -categories. We ignore the braiding structure and consider the fusion category \mathcal{T} formed by patch symmetry operators. We replace braiding structure with a faithful functor $\beta : \mathcal{T} \rightarrow \text{Vec}$. [45] The local fusion category (\mathcal{T}, β) can also be viewed as the transformation category of the symmetry.

F. The algebra of all string operators and its non-degenerate braided fusion category

In this subsection, we are going to consider the operator algebra of all string operators, *i.e.* the patch charge operators Z_{str} and the patch symmetry operators X_{str} . The isomorphic class of such a complete operator algebra is called a **categorical symmetry**.

We have seen that the algebra of Z_{str} corresponds to a symmetric fusion category $\text{Rep}_{\mathbb{Z}_2}$, and the algebra of X_{str} corresponds to a symmetric fusion category $\text{Vec}_{\mathbb{Z}_2}$. The algebra of Z_{str} and X_{str} corresponds to a braided fusion category formed by $\text{Rep}_{\mathbb{Z}_2}$ and $\text{Vec}_{\mathbb{Z}_2}$. Here, we would like to show that such a braided fusion category describes the topological excitations in \mathbb{Z}_2 -topological order with topological excitations $\mathbf{1}, e, m, f$ in 2-dimensional space. We will denote such a braided fusion category as $\mathcal{Gau}_{\mathbb{Z}_2}$.

The algebra of Z_{str} and X_{str} also contain their product

$$X_{\text{str}_{ij}} Z_{\text{str}_{ij}} = T_f(i \rightarrow j) \quad (31)$$

$T_f(i \rightarrow j)$ is the world-line of a new particle f . We see that a f particle at i is the bound state of an e particle at i and an m particle on the link $\langle i, i+1 \rangle$. $T_f(i \rightarrow j)$ satisfies the following algebra

$$\begin{aligned} T_f(i \rightarrow j) T_f(j \rightarrow k) &= X_{i+1} \cdots X_j Z_i Z_j X_{j+1} \cdots X_k Z_j Z_k \\ &= X_{i+1} \cdots X_k Z_i Z_k = T_f(i \rightarrow k) \end{aligned}$$

Next, we compute the fusion rules for the f particles:

$$T_f(-\infty \rightarrow i) T_f(-\infty \rightarrow i) = -\text{id} \quad (32)$$

This implies the fusion rule $f \otimes f = \mathbf{1}$, upto an overall phase factor. This phase factor does not carry any meaning for the fusion rule.

We can also compute the F symbol for the f particle, using the prescription in Fig 5. It is easy to check that all the components of $F(a, b, c)$ with $a, b, c = \mathbf{1}, f$ are equal to 1. Let us compute two cases explicitly, $F(f, f, f)$ and $F(f, \mathbf{1}, f)$. The first, $F(f, f, f)$, is obtained as follows:

$$\begin{aligned} &T_f(1 \rightarrow 2) T_f(0 \rightarrow 1) T_f(2 \rightarrow 1) T_f(3 \rightarrow 1) \\ &\equiv X_{\text{str}_{12}} Z_{\text{str}_{12}} X_{\text{str}_{01}} Z_{\text{str}_{01}} Z_{\text{str}_{12}}^\dagger X_{\text{str}_{12}}^\dagger Z_{\text{str}_{13}}^\dagger X_{\text{str}_{13}}^\dagger \\ &= Z_{\text{str}_{13}}^\dagger X_{\text{str}_{13}}^\dagger X_{\text{str}_{01}} Z_{\text{str}_{01}} \\ &= T_f(3 \rightarrow 1) T_1(1 \rightarrow 2) T_f(0 \rightarrow 1) T_1(2 \rightarrow 1) \end{aligned} \quad (33)$$

³ The reason for this name will become clear in next subsection.

i.e. $F(f, f, f) = 1$ and the second, $F(f, 1, f)$, is obtained from:

$$\begin{aligned} & T_1(1 \rightarrow 2)T_f(0 \rightarrow 1)T_1(2 \rightarrow 1)T_f(3 \rightarrow 1) \\ & \equiv X_{\text{str}_{01}}Z_{\text{str}_{01}}Z_{\text{str}_{13}}^\dagger X_{\text{str}_{13}}^\dagger \\ & = Z_{\text{str}_{13}}^\dagger X_{\text{str}_{13}}^\dagger X_{\text{str}_{12}}Z_{\text{str}_{12}}X_{\text{str}_{01}}Z_{\text{str}_{01}}Z_{\text{str}_{12}}^\dagger X_{\text{str}_{12}}^\dagger \\ & = T_f(3 \rightarrow 1)T_f(1 \rightarrow 2)T_f(0 \rightarrow 1)T_f(2 \rightarrow 1) \end{aligned} \quad (34)$$

i.e. $F(f, 1, f) = 1$. The product $F(f, f, f)F(f, 1, f) = 1$ is gauge invariant; in fact, (the sign of) this product encodes the Frobenius-Schur indicator of f .

Further, we can calculate the self-statistics of the f particle using the hopping algebra method used in previous subsections,

$$\begin{aligned} & T_f(3 \rightarrow 1)T_f(1 \rightarrow 2)T_f(0 \rightarrow 1) \\ & = (X_2X_3Z_1Z_3)^\dagger(X_2Z_1Z_2)(X_1Z_0Z_1) \\ & = -(X_1Z_0Z_1)(X_2Z_1Z_2)(X_2X_3Z_1Z_3)^\dagger \\ & = -T_f(0 \rightarrow 1)T_f(1 \rightarrow 2)T_f(3 \rightarrow 1), \end{aligned} \quad (35)$$

from which we find that f particles have fermionic self-statistics.

Mutual statistics of e , m , and f particles can be obtained by the use of the patch operators. For example, when $i < k < j < l$, we have

$$Z_{\text{str}_{ij}}X_{\text{str}_{kl}} = -X_{\text{str}_{kl}}Z_{\text{str}_{ij}}. \quad (36)$$

Thus the e and m particles have π mutual statistics. In fact, the e , m , and f particles all have π mutual statistics respect to each other.

Since every non-trivial topological excitations (*i.e.* e, m, f) can be detected remotely via mutual statistics, the particles $\mathbf{1}, e, m, f$ form a non-degenerate braided fusion category $\mathcal{G}\text{au}_{\mathbb{Z}_2}$. We believe that such a non-degenerate braided fusion category fully characterized the isomorphic class of the algebras of local symmetric operators. Thus **categorical symmetry** is fully characterized by non-degenerate braided fusion category. Since the non-degenerate braided fusion category describes a topological order in 2-dimensional space, we can also say that **categorical symmetry** is fully characterized by topological order in one higher dimension. This connection between algebra of local symmetric operators and non-degenerate braided fusion category, as well as topological order in one higher dimension is the key result of this paper.

G. A holographic way to compute categorical symmetry

In the above, we have computed the **categorical symmetry** of \mathbb{Z}_2 symmetry directly from the definition of **categorical symmetry**, *i.e.* from the algebra of local symmetry operators and their string extensions. We find that the

categorical symmetry of \mathbb{Z}_2 symmetry is a topological order in one higher dimension. In fact, we can compute this topological order in one higher dimension directly.

We know that a system with \mathbb{Z}_2 symmetry can be realized as a boundary of a trivial product state with \mathbb{Z}_2 symmetry in one higher dimension. If we gauge the bulk symmetric product state, we will obtain a \mathbb{Z}_2 topological order in one higher dimension happen to be the **categorical symmetry** of \mathbb{Z}_2 symmetry.

This result can be generalized. An anomaly-free (higher) symmetry described by (higher) group G can be realized as a boundary of a trivial product state with G (higher) symmetry in one higher dimension. If we gauge the bulk symmetric product state, we will obtain a topological order $\mathcal{G}\text{au}_G$ described by G (higher) gauge theory. Such a topological order in one higher dimension is the **categorical symmetry** of the G (higher) symmetry.

We note that in Ref. 76, the authors consider various G -symmetric 1+1D models as realized on the edge of 2+1D G -gauge theory (*i.e.* G quantum double). This is one particular instance of the general argument we present in this paper.

V. A 1d BOSONIC QUANTUM SYSTEM WITH ANOMALOUS \mathbb{Z}_2 SYMMETRY

Now we discuss the next simplest example: a bosonic system

$$\begin{aligned} H_{\text{a}\mathbb{Z}_2} & = -B \sum_{i=1}^L Z_i Z_{i+1} - J_1 \sum_{i=1}^L (X_i - Z_{i-1} X_i Z_{i+1}) \\ & \quad + J_2 \sum_{i=1}^L Z_{i-1} (X_i + Z_{i-1} X_i Z_{i+1}), \end{aligned} \quad (37)$$

in 1-dimensional space with an anomalous \mathbb{Z}_2 symmetry (*i.e.* a non-on-site symmetry). Our discussions here follow closely the discussions in the last section.

The non-on-site \mathbb{Z}_2 symmetry [53, 77–79]) is described by the symmetry operator

$$W = \prod_i X_i \prod_i s_{i,i+1} = \prod_i X_i \prod_i i^{\frac{-Z_i + Z_{i+1} + Z_i Z_{i+1} - 1}{2}} \quad (38)$$

which we represent pictorially as

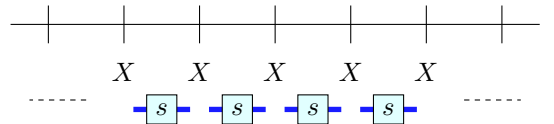

where the operators on top act first. The phase factor $s_{i,i+1}$ is real despite appearances as can be checked by substituting $\{+1, -1\}$ for Z_i and Z_{i+1} (*i.e.* we work in the Z basis). It's easy to see that it evaluates to $+1$ when there is no domain wall between i and $i+1$. Moreover it evaluates to -1 for only one kind of domain walls, the $+1 \rightarrow -1$ kind; it evaluates to $+1$ for the $-1 \rightarrow +1$ kind.

A. Braided fusion category of patch symmetry transformation operator

In order to identify the braided fusion category (*i.e.* the categorical symmetry) corresponding to this anomalous symmetry, we will work out the patch symmetry operators corresponding to the above global symmetry operation. Legitimate patch symmetry operators must satisfy the transparent and fusion properties *i.e.*

1. $W_{\text{patch}_{ij}} W_{\text{patch}_{jk}} = W_{\text{patch}_{ik}}$ for $i < j < k$
2. $W_{\text{patch}_{ij}} W_{\text{patch}_{kl}} W_{\text{patch}_{ij}}^\dagger = W_{\text{patch}_{kl}}$ for $i < k < l < j$

In order to ensure these properties are satisfied, we need to choose appropriate boundary operators for the $W_{\text{patch}_{ij}}$. To that end, we propose the following definition:

$$W_{\text{patch}_{ij}} = O_i^\dagger \prod_{k=i+1}^j X_k (-Z_j O_j) \prod_{k=i+1}^j s_{k,k+1} \quad (39)$$

where $O_j = (1 - iZ_j)/\sqrt{2}$. We may write this operator pictorially as

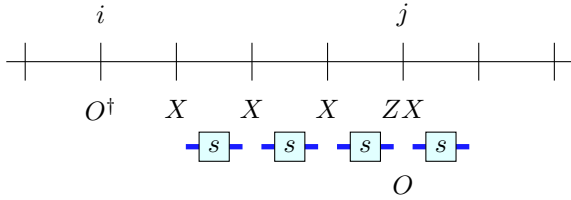

It is straightforward to check that this satisfies the properties mentioned above. Let us label the particles at the boundaries of this patch operator as s . The patch symmetry operator $W_{\text{patch}_{ij}}$ can also be understood as an operator transporting an s particle from i to j , *i.e.*

$$T_s(i \rightarrow j) = W_{\text{patch}_{ij}} \quad (40)$$

The fusion of s particles turns out to be identical to that of the e particles discussed above: they are their own antiparticles so that $s \otimes s = \mathbf{1}$. Here $\mathbf{1}$ is the trivial particle, an end of trivial string formed by product of identity operators. To see this fact, we consider the product of two semi-infinite strings as in eqn. (22).

$$T_s(-\infty \rightarrow i) T_s(-\infty \rightarrow i) = O_{-\infty} (-Z_i Z_{i+1}) \quad (41)$$

where we use $O_{-\infty}$ to represent a local symmetric operator at $-\infty$ of the type $Z_j Z_{j+1}$ (see section VB). Note that such a local symmetric operator represents a trivial particle $\mathbf{1}$, so we can ignore it. A graphical representation

of this is shown below.

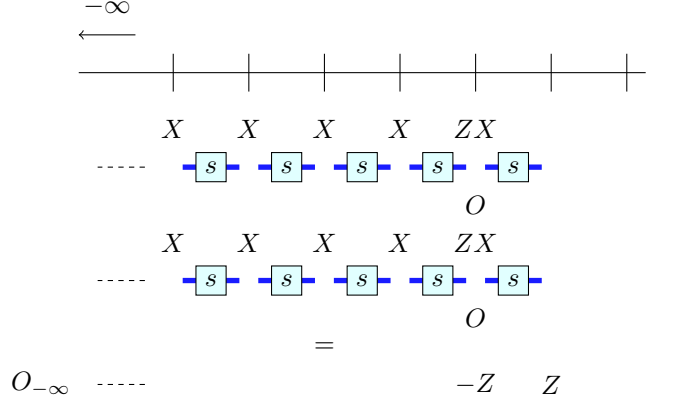

The product is identical to a $\mathbf{1}$ -patch operator modulo the LSOs at $-\infty$ and near i . So we can conclude that this corresponds to the fusion $s \otimes s = \mathbf{1}$. The complete fusion ring is given by

$$s \otimes s = \mathbf{1}, \quad s \otimes \mathbf{1} = s, \quad \mathbf{1} \otimes \mathbf{1} = \mathbf{1}, \quad (42)$$

or equivalently,

$$N_1^{\mathbf{1}\mathbf{1}} = N_1^{s s} = N_s^{s\mathbf{1}} = N_s^{\mathbf{1}s} = 1, \quad \text{others} = 0. \quad (43)$$

Fusion ring N_c^{ab} is only a part of data that describe the braided fusion category. We need to supply the F -symbol, $F(a, b, c)$, to promote the fusion ring to a fusion category. Similar to the e and f particles, we have $F(s, \mathbf{1}, s) = 1$. However, the F -symbol $F(s, s, s)$ is different (again, referring to Fig 5):

$$W_{\text{patch}_{jk}} W_{\text{patch}_{ij}} W_{\text{patch}_{jk}}^\dagger W_{\text{patch}_{jl}}^\dagger = F(s, s, s) W_{\text{patch}_{jl}}^\dagger \mathbf{1}_{\text{patch}_{jk}} W_{\text{patch}_{ij}} \mathbf{1}_{\text{patch}_{jk}}^\dagger \quad (44)$$

Working out the algebra (see Appendix B1) gives us $F(s, s, s) = -1$. The gauge-invariant product $F(s, s, s) F(s, \mathbf{1}, s) = -1$ gives us a non-trivial Frobenius-Schur indicator, unlike in the cases of e and f discussed in the previous sections. This distinguishes the fusion category encoded by the anomalous \mathbb{Z}_2 patch symmetry operators from that of the anomaly-free \mathbb{Z}_2 symmetry without even considering the braiding structure.

Similarly, the fusion category data, $(N_c^{ab}, F(a, b, c))$, is only a part of data to describe a braided fusion category. To obtain the full data to describe a braided fusion category, we need to supply the data that describes mutual and self statistics. The mutual statistics between s and $\mathbf{1}$ is trivial $\theta_{s\mathbf{1}} = 0$. We can calculate the self statistics of s by calculating the statistical hopping algebra of the particle-like endpoints of the patch symmetry operator, as outlined above in Fig. 6. In this case, we find (see Appendix B2) $e^{i\theta_s} = i$, *i.e.* a statistical phase of $\theta_s = \pi/2$. This shows that the endpoints are *semions*. Thus unlike the anomaly-free \mathbb{Z}_2 symmetry, the transformation category of anomalous \mathbb{Z}_2 symmetry is not

a symmetric fusion category. The transformation category happens to be non-degenerate, and correspond to the single-semion topological order in 2d, which will be denoted as $\mathcal{M}_{\text{single-semion}}$. Note that, in general, a transformation category may be degenerate, in which case it does not correspond to a topological order in one higher dimension.

B. Braided fusion category of patch charge operator

We can also define patch charge operators for anomalous \mathbb{Z}_2 symmetry, which have empty bulk and a pair of \mathbb{Z}_2 charges at the endpoints,

$$Z_{\text{string}_{ij}} = Z_i Z_j \quad (45)$$

Let us label the particles at the ends of this operator as b . This operator is identical to the patch charge operator in the case of anomaly-free \mathbb{Z}_2 symmetry discussed in the previous section. All the results discussed there carry forward to this case. In particular, these patch charge operators produce the representation category, which is a symmetric fusion category $\text{Rep}_{\mathbb{Z}_2}$. We see that the representation category cannot distinguish anomalous and anomaly-free symmetries, but the transformation category can.

C. Braided fusion category of all t-patch operators

To consider all t-patch operators, we must consider fusion of the semion and the boson. The b particles fuse with s to give another semion, let's call it \tilde{s} . Along with the trivial one, we thus end up with four particles. We can easily check that s and b have π mutual statistics,

$$Z_{\text{string}_{ij}} W_{\text{patch}_{kl}} = -W_{\text{patch}_{kl}} Z_{\text{string}_{ij}} \quad (46)$$

Combining this with the fact that s has semionic self-statistics, we see that s and $\tilde{s} \equiv s \otimes b$ have trivial mutual statistics.

Putting the transformation category $\mathcal{M}_{\text{single-semion}}$ and the representation category $\text{Rep}_{\mathbb{Z}_2}$ together, the above set of anyons and their braiding and fusion data corresponds to the double-semion topological order $\mathcal{M}_{\text{double-semion}}$. Double-semion is an Abelian topological order which are classified K -matrix.[80, 81] The K -matrix for the double-semion topological order is given by

$$K_{\text{DS}} = \begin{pmatrix} -2 & 0 \\ 0 & 2 \end{pmatrix} \quad (47)$$

The topological quasiparticles are described by integer vectors l , and there $\det(K) = 16$ is them. The trivial particle $\mathbf{1}$ is described by $\mathbf{1} \sim (0, 0)^\top$, semion $s \sim (0, 1)^\top$, semion $\tilde{s} \sim (1, 0)^\top$, and boson $b \sim (1, 1)^\top$. The self statistics of anyon l is given by $\theta_l = \pi l^\top K_{\text{DS}}^{-1} l$, the

mutual statistics between anyon l_1 and l_2 is given by $\theta_{l_1 l_2} = 2\pi l_1^\top K_{\text{DS}}^{-1} l_2$. The above K -matrix reproduces the self/mutual statistics of s, \tilde{s}, b . Thus, the categorical symmetry for the anomalous \mathbb{Z}_2 symmetry in 1-dimensional space is the double-semion topological order $\mathcal{M}_{\text{double-semion}}$ in 2-dimensional space.

D. A holographic way to compute categorical symmetry

We can also compute categorical symmetry of anomalous symmetry directly by computing the corresponding topological order in one higher dimension. We know that a system with (certain) anomalous G (higher) symmetry can be realized as a boundary of a G -symmetry protected topological (SPT) state in one higher dimension. If we gauge the G -symmetry in the bulk SPT state, we will obtain a topological order described by a twisted G (higher) gauge theory. Such a topological order in one higher dimension is the categorical symmetry of the G (higher) symmetry.

Applying this method to 1d anomalous \mathbb{Z}_2 symmetry, we find the corresponding categorical symmetry to be the 2d double-semion topological order. The connection between 1d anomalous \mathbb{Z}_2 symmetry and 2d double-semion topological order was first observed in Ref. 82.

VI. A 1d BOSONIC QUANTUM SYSTEM WITH $\mathbb{Z}_2 \times \mathbb{Z}_2$ SYMMETRY WITH A MIXED ANOMALY

In this section, we calculate the categorical symmetry (*i.e.* the non-degenerate braided fusion category) for bosonic $\mathbb{Z}_2 \times \mathbb{Z}_2$ symmetry with the mixed anomaly in 1-dimensional space. Following Ref. 79, (see Appendix C for details) we have two qubits on each site and two symmetry generators of $\mathbb{Z}_2 \times \mathbb{Z}_2$,

$$W = \prod_i X_i \quad (48)$$

$$\tilde{W} = \prod_i \tilde{X}_i \prod_i s_{i,i+1} \quad (49)$$

where $s_{i,i+1} = i^{\frac{1}{2}(Z_{i+1}-Z_i)} (\tilde{Z}_{i+1}+1)$ is the non-on-site phase factor that encodes the mixed anomaly. X_i, Z_i act on one qubit and \tilde{X}_i, \tilde{Z}_i on the other qubit.

A. Braided fusion category of patch operators

The operators W and \tilde{W} above are global symmetry transformations, which have corresponding t-patch sym-

metry operators as discussed in the previous sections.

$$W_{\text{patch}_{ij}} = \tilde{O}_i \left(\prod_{k=i}^{j-1} X_k \right) \tilde{O}_j^\dagger \quad (50)$$

$$\tilde{W}_{\text{patch}_{ij}} = \prod_{k=i+1}^j \tilde{X}_k \prod_{k=i}^{j-1} s_{k,k+1} \quad (51)$$

To satisfy the transparency condition and the composition algebra of the t-patch operators (see Fig. 3), \tilde{O}_j in eqn. (50) needs to be chosen carefully: $\tilde{O}_j = (1 - i\tilde{Z}_j)/\sqrt{2}$. Pictorially, we can represent $W_{\text{patch}_{ij}}$ as

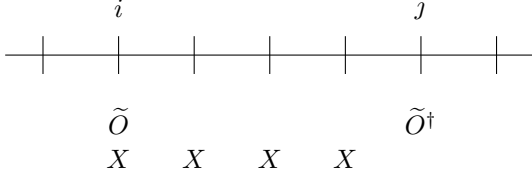

and $\tilde{W}_{\text{patch}_{ij}}$ as

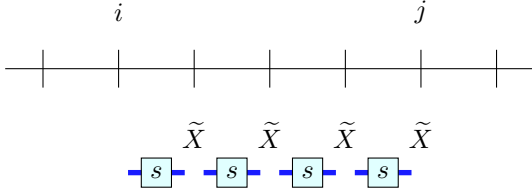

We label the endpoints of these patch operators m and \tilde{m} , respectively. More carefully, we should choose one end of the string to be m (or \tilde{m}) while the other end is its antiparticle \tilde{m} (m respectively). The patch charge operators are generated by

$$Z_{\text{string}_{ij}} = Z_i Z_j \quad (52)$$

$$\tilde{Z}_{\text{string}_{ij}} = \tilde{Z}_i \tilde{Z}_j \quad (53)$$

Let us name the charge operators at the ends of these as e and \tilde{e} . We note here that m, \tilde{m} are order 4 whereas e, \tilde{e} are order 2. We can see this from the fact that $W_{\text{patch}_{ij}}^4 = \mathbf{1} = \tilde{W}_{\text{patch}_{ij}}^4$ while $W_{\text{patch}_{ij}}^2 \neq \mathbf{1}, \tilde{W}_{\text{patch}_{ij}}^2 \neq \mathbf{1}$. On the other hand, $Z_{\text{string}_{ij}}^2 = \mathbf{1} = \tilde{Z}_{\text{string}_{ij}}^2$. The fusion of m and \tilde{m} gives s (say). The self-statistics of e and \tilde{e} are trivial, by the same logic as in the anomaly-free \mathbb{Z}_2 symmetry discussed in Sec IV C. We can also check that m and \tilde{m} have trivial self-statistics. However, s particles have semionic self-statistics, as can be seen from the hopping algebra calculation. This is closely related to the fact that m and \tilde{m} have $\pi/2$ mutual statistics; we find (cf. Fig 7)

$$W_{\text{patch}_{02}} \tilde{W}_{\text{patch}_{13}} = i \tilde{W}_{\text{patch}_{13}} W_{\text{patch}_{02}} \quad (54)$$

Further details may be found in Appendix B3. We also note that the m and e particles have π mutual statistics, and so do \tilde{m} and \tilde{e} .

The particles $m, \tilde{m}, e, \tilde{e}$ generate a non-degenerate braided fusion category that correspond to a 2d Abelian topological order. By comparing the self/mutual statistics of those topological excitations, we find that the 2d Abelian topological order is described by the K -matrix

$$K = \begin{pmatrix} 0 & 2 & -1 & 0 \\ 2 & 0 & 0 & 0 \\ -1 & 0 & 0 & 2 \\ 0 & 0 & 2 & 0 \end{pmatrix} \quad (55)$$

This 2d topological order is the categorical symmetry for the $\mathbb{Z}_2 \times \mathbb{Z}_2$ symmetry with the mixed anomaly in 1-dimensional space. The topological excitations in such an Abelian topological order are labeled by integer vectors l . The $m, \tilde{m}, e, \tilde{e}$ correspond to the following integer vectors:

$$\begin{aligned} e &\sim (1, 0, 0, 0)^\top, & m &\sim (0, 1, 0, 0)^\top, \\ \tilde{e} &\sim (0, 0, 1, 0)^\top, & \tilde{m} &\sim (0, 0, 0, 1)^\top. \end{aligned} \quad (56)$$

The self statistics of particle l and mutual statistics between particles l_1 and l_2 can be calculated via

$$\theta_l = \pi l^\top K^{-1} l, \quad \theta_{l_1, l_2} = 2\pi l_1^\top K^{-1} l_2, \quad (57)$$

where

$$K^{-1} = \begin{pmatrix} 0 & \frac{1}{2} & 0 & 0 \\ \frac{1}{2} & 0 & 0 & \frac{1}{4} \\ 0 & 0 & 0 & \frac{1}{2} \\ 0 & \frac{1}{4} & \frac{1}{2} & 0 \end{pmatrix}. \quad (58)$$

The entry $\frac{1}{4}$ in K^{-1} gives rise to the $\pi/2$ mutual statistics between m and \tilde{m} .

B. A holographic calculation of categorical symmetry

The above 2d Abelian topological order (*i.e.* the categorical symmetry) can be obtained via another approach. We know that the $\mathbb{Z}_2 \times \mathbb{Z}_2$ symmetry with the mixed anomaly is realized by the boundary of a 2d $\mathbb{Z}_2 \times \mathbb{Z}_2$ SPT state. If we gauge the 2d $\mathbb{Z}_2 \times \mathbb{Z}_2$ symmetry, we will turn the 2d $\mathbb{Z}_2 \times \mathbb{Z}_2$ SPT state into a 2d topological order. Such a 2d topological order is the Abelian topological order described above. Such an Abelian topological order was given by the K -matrix in equations (64) and (67) in Ref. 83. For our case, we need to substitute the values $n_1 = n_2 = 2$, and $m_0 = m_3 = 0, m_2 = 1$, which gives us the K -matrix in eqn. (55). This Abelian topological order is the categorical symmetry for the 1d $\mathbb{Z}_2 \times \mathbb{Z}_2$ symmetry with the mixed anomaly. The holographic calculation gives rise to the same result as the operator algebra calculation.

C. The equivalence between 1d $\mathbb{Z}_2 \times \mathbb{Z}_2$ symmetry with mixed anomaly and 1d \mathbb{Z}_4 symmetry

Generalizing our \mathbb{Z}_2 result, we know that the categorical symmetry of 1d anomaly-free \mathbb{Z}_4 symmetry is the 2d \mathbb{Z}_4 topological order (\mathbb{Z}_4 gauge theory), denoted as $\mathcal{Gau}_{\mathbb{Z}_4}$ and described by the K -matrix,

$$K_{\mathbb{Z}_4} = \begin{pmatrix} 0 & 4 \\ 4 & 0 \end{pmatrix} \quad (59)$$

The set of topological quasiparticle is described by integer vectors $\{(a, b)^\top | a, b \in \mathbb{Z}_4\}$, and there also $|\det K_{\mathbb{Z}_4}| = 16$ of them. Their self and mutual statistics can be read off from the inverse of the 2×2 K -matrix, which are the same as those for the 4×4 K -matrix in eqn. (55). This allows us to make the following identification

$$\begin{aligned} (0, 1)^\top &\leftrightarrow m, & (1, 0)^\top &\leftrightarrow \tilde{m}, & (1, 1)^\top &\leftrightarrow s \\ (2, 0)^\top &\leftrightarrow e, & (0, 2)^\top &\leftrightarrow \tilde{e} \end{aligned} \quad (60)$$

For example, note that $(0, 1)^\top$ and $(1, 0)^\top$ have trivial self statistics,

$$\pi (0, 1) \cdot K^{-1} \cdot (0, 1)^\top = 0 \quad (61)$$

$$\pi (1, 0) \cdot K^{-1} \cdot (1, 0)^\top = 0 \quad (62)$$

but have $\frac{\pi}{2}$ mutual statistics,

$$2\pi (0, 1) \cdot K^{-1} \cdot (1, 0)^\top = \frac{\pi}{2} \quad (63)$$

so these must correspond to the m, \tilde{m} particles. Note also that these are order 4 quasiparticle vectors, *i.e.* 4 of them will fuse to a trivial quasiparticle. On the other hand, the quasiparticle vectors $(2, 0)^\top$ and $(0, 2)^\top$ correspond to e, \tilde{e} particles because not only do they have trivial self statistics,

$$\pi (0, 2) \cdot K^{-1} \cdot (0, 2)^\top = 0 \quad (64)$$

$$\pi (2, 0) \cdot K^{-1} \cdot (2, 0)^\top = 0 \quad (65)$$

but they also have trivial mutual statistics,

$$2\pi (0, 2) \cdot K^{-1} \cdot (2, 0)^\top = 2\pi \quad (66)$$

Similar calculations show that $(0, 2)^\top$ and $(1, 0)^\top$ have π mutual statistics, and so do $(2, 0)^\top$ and $(0, 1)^\top$.

In fact, 2d Abelian topological orders described by (55) and (59) are actually the same topological order [84]. It turns out, this K -matrix in (55) can be transformed $K \rightarrow WKW^\top$ by an integer matrix W with $\det(W) = \pm 1$ into a \mathbb{Z}_4 K -matrix, direct summed with a trivial block.

$$W = \begin{pmatrix} 1 & 0 & 0 & 0 \\ 0 & 0 & 1 & 0 \\ 0 & 1 & 2 & 0 \\ 2 & 0 & 0 & 1 \end{pmatrix} \implies WKW^\top = \begin{pmatrix} 0 & -1 & 0 & 0 \\ -1 & 0 & 0 & 0 \\ 0 & 0 & 0 & 4 \\ 0 & 0 & 4 & 0 \end{pmatrix} \quad (67)$$

TABLE I. Group ‘‘multiplication’’ table of $\mathbb{Z}_4 \equiv \mathbb{Z}_2 \rtimes_{e_2} \mathbb{Z}_2$. The entries left blank are redundant since the group is Abelian.

$\mathbb{Z}_2 \rtimes_{e_2} \mathbb{Z}_2$	(0,0)	(0,1)	(1,0)	(1,1)
(0,0)	(0,0)			
(0,1)	(0,1)	(0,0)		
(1,0)	(1,0)	(1,1)	(0,1)	
(1,1)	(1,1)	(1,0)	(0,0)	(0,1)

To summarize, 1d $\mathbb{Z}_2 \times \mathbb{Z}_2$ symmetry with the mixed anomaly is realized by the boundary of a 2d $\mathbb{Z}_2 \times \mathbb{Z}_2$ SPT state. 1d anomaly-free \mathbb{Z}_4 symmetry is realized by the boundary of a 2d trivial \mathbb{Z}_4 SPT state. The categorical symmetry of the 1d mixed-anomalous $\mathbb{Z}_2 \times \mathbb{Z}_2$ symmetry is the $\mathbb{Z}_2 \times \mathbb{Z}_2$ gauging of the 2d $\mathbb{Z}_2 \times \mathbb{Z}_2$ SPT state. The categorical symmetry of the 1d \mathbb{Z}_4 symmetry is the \mathbb{Z}_4 gauging of the 2d trivial \mathbb{Z}_4 SPT state. The two symmetries give rise to the same 2d topological order. Thus 1d $\mathbb{Z}_2 \times \mathbb{Z}_2$ symmetry with the mixed anomaly and 1d anomaly-free \mathbb{Z}_4 symmetry have the same categorical symmetry and are equivalent.

D. A new duality mapping

By comparing with the corresponding table for \mathbb{Z}_4 in the additive presentation $\{0, 1, 2, 3\}$, we can make the following (non-unique) one-to-one mapping between these two representations of \mathbb{Z}_4 .

$$(0, 0) \leftrightarrow 0 \quad (0, 1) \leftrightarrow 2 \quad (68)$$

$$(1, 0) \leftrightarrow 3 \quad (1, 1) \leftrightarrow 1 \quad (69)$$

The above holographic equivalence of 1d mixed-anomalous $\mathbb{Z}_2 \times \mathbb{Z}_2$ symmetry and 1d anomaly-free \mathbb{Z}_4 symmetry suggests the existence of a new duality mapping, between a model with $\mathbb{Z}_2 \times \mathbb{Z}_2$ non-on-site symmetry and model with \mathbb{Z}_4 on-site symmetry. Such an exact duality maps between the \mathbb{Z}_4 patch symmetry/charge operators and the patch symmetry/charge operators of the mixed-anomalous $\mathbb{Z}_2 \times \mathbb{Z}_2$ symmetry we have been outlining in this section. This duality is a Kramers-Wannier-like transformation that transforms one set of \mathbb{Z}_2 variables from order to disorder (or site to link) variables, followed by an on-site (local) unitary transformation. To state the duality mapping, we first re-write the group \mathbb{Z}_4 as a cocycle-twisted product of two \mathbb{Z}_2 groups, as described in Appendix N of Ref. 85. With $G = \mathbb{Z}_4$, and $A = \mathbb{Z}_2 \leq G$, we extend A by $H = \mathbb{Z}_2$ with $\alpha = \text{id}$ and $e_2(h_1, h_2) = [h_1 \cdot h_2]_{\text{mod } 2}$.⁴ The group operation with

⁴ The multiplication of elements of H in the definition of e_2 is understood to be done in \mathbb{Z} and then mapped back to \mathbb{Z}_2 .

TABLE II. Patch operators of $\mathbb{Z}_2 \times \mathbb{Z}_2$ with mixed anomaly and their dual \mathbb{Z}_4 patch operators. ($O'_i = \frac{1-iZ'_i}{\sqrt{2}}$)

$\mathbb{Z}_2 \times \mathbb{Z}_2$ with mixed anomaly	Anomaly-free \mathbb{Z}_4
$W_{\text{patch}_{ij}} = \tilde{O}_i \left(\prod_{k=i}^{j-1} X_k \right) \tilde{O}_j^\dagger$	$O'_i \bar{Z}_{i-\frac{1}{2}} (O'_j)^\dagger \bar{Z}_{j-\frac{1}{2}}$
$\widetilde{W}_{\text{patch}_{ij}} = \prod_{k=i+1}^j \tilde{X}_k \prod_{k=i}^{j-1} s_{k,k+1}$	$\prod_{k=i}^j X'_k C X (g'_k, \bar{g}_{k-\frac{1}{2}}) \equiv \prod_{k=i}^j L_{+3 k}$
$Z_{\text{string}_{ij}} = Z_i Z_j$	$\prod_{i}^{j-1} \bar{X}_{k+\frac{1}{2}} \equiv \prod_{k=i+1}^j L_{+2 k}$
$\tilde{Z}_{\text{string}_{ij}} = \tilde{Z}_i \tilde{Z}_j$	$Z'_i Z'_j$

these choices can be expressed as

$$(h_1, x_1) * (h_2, x_2) = (h_1 + h_2, x_1 + x_2 + e_2(h_1, h_2)) \quad (70)$$

where the additions are to be understood modulo 2. Using this, we may write elements of \mathbb{Z}_4 using two \mathbb{Z}_2 labels as $g \equiv (h, x)$ where $x \in A$ and $h \in H$. There are four \mathbb{Z}_4 symmetry transformations: one trivial and three non-trivial. Taking \mathbb{Z}_4 to be represented as $\{0, 1, 2, 3\}$, with the group operation being addition modulo 4, we have two generators L_{+1} and L_{+3} of the symmetry group,

$$\begin{aligned} L_{+1} |g\rangle &= |g + 1 \bmod 4\rangle \\ L_{+3} |g\rangle &= |g + 3 \bmod 4\rangle \end{aligned} \quad (71)$$

In the (h, x) representation, what do these generators look like? We can work this out by looking at the group ‘‘multiplication’’ table of \mathbb{Z}_4 in this representation: see Table I.

Using this mapping, we re-write eqn. (71) as follows.

$$\begin{aligned} L_{+1} |(h, x)\rangle &= |(h, x) * (1, 1)\rangle \\ L_{+3} |(h, x)\rangle &= |(h, x) * (1, 0)\rangle \end{aligned} \quad (72)$$

Inspecting this case-by-case, one observes that the generator L_{+3} is nothing but the operator $X_1 C X_{1,0}$, acting on kets $|(h, x)\rangle$. Here h and x are labeled as qubits 1 and 0 respectively, and $C X_{1,0}$ denotes the controlled NOT gate with qubit 1 as the control.

Now we apply a duality transformation on the t-patch operators of the $\mathbb{Z}_2 \times \mathbb{Z}_2$ symmetry with mixed anomaly in order to show that we recover the t-patch operators of anomaly-free \mathbb{Z}_4 symmetry. The reader who is interested in the explicit form of the duality instead of the steps leading up to it is invited to skip to the end of this subsection.

On the $\mathbb{Z}_2 \times \mathbb{Z}_2$ side, our states are defined by a pair of \mathbb{Z}_2 variables on each site i , denoted (g_i, \tilde{g}_i) . The definitions $g_i = \frac{Z_i - 1}{2}$, $\tilde{g}_i = \frac{\tilde{Z}_i - 1}{2}$ map the Z-basis $\{\pm 1\}$ to the additive \mathbb{Z}_2 basis $\{0, 1\}$.

Step 1 of duality transformation \mathcal{D} : We transform (g_i, \tilde{g}_i) to $(g'_i, \bar{g}_{i-1/2})$ by defining $\bar{g}_{i-1/2} = g_i - g_{i-1} \bmod 2$ and $g'_i = \tilde{g}_i$. The Pauli operators transform as

$$X_i \rightarrow \bar{X}_{i-\frac{1}{2}} \bar{X}_{i+\frac{1}{2}}, \quad Z_i Z_{i+1} \rightarrow \bar{Z}_{i+\frac{1}{2}} \quad (73)$$

The new degrees of freedom may be shown pictorially as

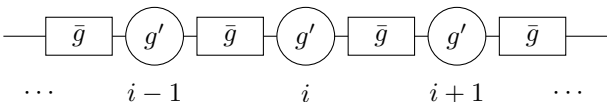

For each site i , let us define $g''_i = \bar{g}_{i-\frac{1}{2}}$. Then we have a two-qubit Hilbert space labeled as (g'_i, g''_i) associated with site i . Let us choose g'_i as qubit-1 and g''_i as qubit-2.

Step 2 of duality transformation \mathcal{D} : Now we perform a Hadamard transformation on qubit-2 of each site. The states transform as

$$|g'_i\rangle \otimes |g''_i\rangle \rightarrow |g'_i\rangle \otimes (H |g''_i\rangle) \quad (74)$$

where H is the Hadamard operator. We will instead work in the Heisenberg picture, where the Hadamard transformation acts on the operators and interchanges \bar{X} and \bar{Z} . Then the states on which these transformed operators act are labeled by \mathbb{Z}_4 elements in the (h, x) representation with $h_i = g'_i$ and $x_i = g''_i = \bar{g}_{i-\frac{1}{2}} = g_i - g_{i-1} \bmod 2$.

Summarizing the mapping of the basis states,

$$(g_i, \tilde{g}_i) \rightarrow (g'_i = \tilde{g}_i, g''_i = g_i - g_{i-1} \bmod 2) \quad (75)$$

with $(g_i, \tilde{g}_i) \in \mathbb{Z}_2 \times \mathbb{Z}_2$ and $(g'_i, g''_i) \in \mathbb{Z}_2 \times_{e_2} \mathbb{Z}_2 \cong \mathbb{Z}_4$. On the other hand, under the combined effect of steps 1 and 2 of \mathcal{D} , we have the operator maps

$$X_i \rightarrow Z''_i Z''_{i+1}, \quad Z_i Z_{i+1} \rightarrow X''_{i+1} \quad (76)$$

Using this, one finds that the operator $s_{i-1,i}$ becomes $C X (g'_i, g''_i)$. We can also denote this as $C X_{1,0} |i\rangle$ with the qubit labels 1 and 0 as described above. In fact, we can check that the patch operators in the left column of Table II are transformed to those in the right column, under the transformation \mathcal{D} .

In particular, we find the dual of $\widetilde{W}_{\text{patch}_{ij}}$ to be the patch symmetry operator corresponding to the L_{+3} transformation discussed above. This operator then generates all the \mathbb{Z}_4 patch symmetry operators in the $\mathbb{Z}_2 \times_{e_2} \mathbb{Z}_2$ representation. On the other hand, the dual of $W_{\text{patch}_{ij}}$ is a t-patch operator with empty bulk that has order 4. This operator may be identified with one of the charge patch operators of anomaly-free \mathbb{Z}_4 symmetry. This completes the mapping between patch operators on both sides of our duality $\mathcal{D} : (\mathbb{Z}_2 \times \mathbb{Z}_2)^{\omega_{12}} \leftrightarrow \mathbb{Z}_4$. This exact duality mapping allows us to show that the 1d $\mathbb{Z}_2 \times \mathbb{Z}_2$ symmetry with mixed anomaly and anomaly-free \mathbb{Z}_4 symmetry have *isomorphic local symmetric operator algebra i.e.* they have the *same categorical symmetry*.

A comment on gauging: The duality we described above can also be understood as coupling the degrees of freedom of \mathbb{Z}_4 symmetric system to a \mathbb{Z}_2 gauge field. The

Kramers-Wannier-like transformation in the first step of \mathcal{D} essentially amounts to such a gauging procedure. In the case of \mathbb{Z}_2 symmetry in 1d, the Kramers-Wannier duality transformation allows one to relate \mathbb{Z}_2 order and disorder operators, where the latter can be obtained from the former by gauging the local \mathbb{Z}_2 symmetry and then restricting to the \mathbb{Z}_2 charge even sector of the Ising gauge theory. Our duality transformation above involves an on-site unitary (Hadamard) transformation in addition to this gauging procedure.

VII. A 1d BOSONIC QUANTUM SYSTEM WITH AN EMERGENT $\mathbb{Z}_2 \times \mathbb{Z}_2$ SYMMETRY WHICH IS “BEYOND ANOMALY”

In this section, we are going to study a case of emergent symmetry. We find that the emergent symmetry is neither anomaly-free nor anomalous. It illustrates that categorical symmetry (*i.e.* topological order in one higher dimension) is a better way to view symmetry. We get a simpler, more uniform, and more systematic picture.

Let us briefly recall the model from section II.C of Ref. 53. This model describes a 1+1D bosonic quantum system with spin-1/2 degrees of freedom on each site and each link. The Hamiltonian describing the model is:

$$H = - \sum_i \left(B \tilde{X}_{i-\frac{1}{2}} X_i \tilde{X}_{i+\frac{1}{2}} + J \tilde{Z}_{i+\frac{1}{2}} \right) + U \sum_i \left(1 - Z_i \tilde{Z}_{i+\frac{1}{2}} Z_{i+1} \right) \quad (77)$$

This Hamiltonian has two on-site (*i.e.* anomaly-free) \mathbb{Z}_2 symmetries, generated by

$$W = \prod_k X_k, \quad \tilde{W} = \prod_k \tilde{Z}_{k+\frac{1}{2}} \quad (78)$$

Let us denote the corresponding symmetries as \mathbb{Z}_2 and $\tilde{\mathbb{Z}}_2$. The algebra of local operators is constrained by these symmetries. We add an additional constraint on this algebra: the *low-energy constraint*. This constraint is imposed by taking the limit of $U \rightarrow \infty$. Low energy sector of the Hilbert space must then satisfy

$$1 - Z_i \tilde{Z}_{i+\frac{1}{2}} Z_{i+1} = 0, \quad \forall i \quad (79)$$

In operator language, we demand that the allowed local operators commute with the operator appearing in eqn. (79). The algebra of the allowed local operators will give rise to emergent low energy symmetry.

The question is then, how does this additional constraint⁵ change the algebra of t-patch operators? It turns

⁵ The experienced reader may note that this is sometimes colloquially referred to as “gauging” in the literature. We are particular about not calling it by this name since we don’t introduce any extra unphysical, or *gauge*, degrees of freedom in this discussion. Instead we are restricting to a subspace of the full Hilbert space to focus on the effective theory.

out that this modified algebra involves a non-trivial relationship between the \mathbb{Z}_2 and $\tilde{\mathbb{Z}}_2$ symmetries. To be clear, this is not a case of mixed anomaly of two \mathbb{Z}_2 symmetries like the case discussed in the previous section. Nor is this a case of an anomaly-free symmetry: the patch symmetry operators form a non-symmetric fusion category. This is thus an example of a symmetry that is, in some sense, beyond the usual notion of “anomalous symmetry”. The categorical symmetry of the low-energy sector of this model is not $\text{Gau}_{\mathbb{Z}_2 \times \mathbb{Z}_2}$ (*i.e.* $\mathbb{Z}_2 \times \mathbb{Z}_2$ gauge theory coupled to matter), as would be the case for an anomaly-free global $\mathbb{Z}_2 \times \mathbb{Z}_2$ symmetry. Instead it has the categorical symmetry $\text{Gau}_{\mathbb{Z}_2}$, same as that of anomaly-free global \mathbb{Z}_2 symmetry. Let us now expand on this using the language we have been developing in the previous sections.

The algebra generated by the LSOs can be organized in terms of the t-patch operators, which serve as a particular convenient choice of generators:

1. 0-dimensional t-patch operators are the local symmetric operators that act within the low-energy sector:

$$\tilde{X}_{i-\frac{1}{2}} X_i \tilde{X}_{i+\frac{1}{2}}, \quad \tilde{Z}_{i+\frac{1}{2}}. \quad (80)$$

2. 1-dimensional t-patch operators – string operators:

$$Z_{\text{str}_{ij}} = \prod_{k=i}^{j-1} \tilde{Z}_{k+\frac{1}{2}} = Z_i Z_j, \quad X_{\text{str}_{ij}} = \tilde{X}_{i-\frac{1}{2}} \prod_{k=i}^j X_k \tilde{X}_{j+\frac{1}{2}}. \quad (81)$$

One may note that the new constraint, eqn. (79) has the effect of restricting the set of allowed t-patch operators. For example, the two string operators $\prod_{k=i}^{j-1} \tilde{Z}_{k+\frac{1}{2}}$ and $Z_i Z_j$ become identical within the low energy subspace. Also two string operators $\prod_{k=i}^j X_k$ and $\tilde{X}_{i+1/2} \tilde{X}_{j+1/2}$ must appear together. Without this constraint, the list of t-patch operators would be a bigger one – one that would encode anomaly-free $\mathbb{Z}_2 \times \mathbb{Z}_2$ symmetry.

The algebra of the *extended* t-patch operators takes the form:

$$Z_{\text{str}_{ij}} X_{\text{str}_{kl}} = \pm X_{\text{str}_{kl}} Z_{\text{str}_{ij}} \quad (82)$$

$$Z_{\text{str}_{ij}} Z_{\text{str}_{jk}} = Z_{\text{str}_{ik}} \quad (83)$$

$$X_{\text{str}_{ij}} X_{\text{str}_{jk}} = X_{\text{str}_{ik}} \quad (84)$$

where the sign in eqn. (82) is $-$ if $i < k < j < l$, and $+$ otherwise. We see here that the algebra of the patch operators above mirrors that of anomaly-free \mathbb{Z}_2 symmetry, as discussed in Section IV F. Specifically, note that eqn. (83) and eqn. (84) are identical to eqn. (11) and eqn. (12) respectively. These represent the fusion of the endpoints of these t-patch operators. The mutual statistics of these endpoints are also identical in the two cases as can be seen by comparing eqn. (82) with eqn. (13) and eqn. (14).

Therefore, the exact 1d $\mathbb{Z}_2 \times \mathbb{Z}_2$ on-site symmetry in the model (77) becomes a different $\mathbb{Z}_2 \times \mathbb{Z}_2$ symmetry at low energies. The new $\mathbb{Z}_2 \times \mathbb{Z}_2$ symmetry has the categorical symmetry $\mathcal{G}_{\text{au}_{\mathbb{Z}_2}}$, while the original $\mathbb{Z}_2 \times \mathbb{Z}_2$ on-site symmetry has the categorical symmetry $\mathcal{G}_{\text{au}_{\mathbb{Z}_2 \times \mathbb{Z}_2}}$. The new $\mathbb{Z}_2 \times \mathbb{Z}_2$ symmetry has a special property: a gapped state must spontaneously break one of the \mathbb{Z}_2 symmetry. A state with both \mathbb{Z}_2 symmetry must be gapless. There is no state that can spontaneously break both the \mathbb{Z}_2 symmetries.[53, 86] Those properties have some similarities to $\mathbb{Z}_2 \times \mathbb{Z}_2$ symmetry with the mixed anomaly. But the $\mathbb{Z}_2 \times \mathbb{Z}_2$ symmetry with the mixed anomaly has the categorical symmetry $\mathcal{G}_{\text{au}_{\mathbb{Z}_4}}$. Since the categorical symmetry $\mathcal{G}_{\text{au}_{\mathbb{Z}_2}}$ for the new $\mathbb{Z}_2 \times \mathbb{Z}_2$ symmetry is different from both the categorical symmetry $\mathcal{G}_{\text{au}_{\mathbb{Z}_2 \times \mathbb{Z}_2}}$ for anomaly-free $\mathbb{Z}_2 \times \mathbb{Z}_2$ symmetry and the categorical symmetry $\mathcal{G}_{\text{au}_{\mathbb{Z}_4}}$ for $\mathbb{Z}_2 \times \mathbb{Z}_2$ symmetry with the mixed anomaly, the new $\mathbb{Z}_2 \times \mathbb{Z}_2$ symmetry is beyond anomaly.

VIII. 2d \mathbb{Z}_2 SYMMETRY AND ITS DUAL

In the above, we have discussed symmetries and categorical symmetries in 1-dimensional space. In this section, we will start to consider symmetries in higher dimensions, where we will encounter higher symmetries.

First, we consider the simplest symmetry – \mathbb{Z}_2 symmetry, in 2-dimensional space. For convenience, let us assume the degrees of freedom on each vertex (labeled by i) are labeled by elements in the \mathbb{Z}_2 group.

A. \mathbb{Z}_2 symmetry transformation and t-patch operators as local symmetric operators

The \mathbb{Z}_2 symmetry is described by a symmetry transformation:

$$W = \prod_{i \in \text{whole space}} X_i, \quad W^2 = \text{id}. \quad (85)$$

The \mathbb{Z}_2 transformation W select a set of local symmetric operators which form an algebra:

$$\mathcal{A} = \{O_i^{\text{symm}} \mid O_i^{\text{symm}} W = W O_i^{\text{symm}}\} \quad (86)$$

As before, we can use the t-patch operators to organize the local symmetric operators:

1. 0-dimensional t-patch operators, $X_i, Z_i Z_{i+\mu}$, where μ connects vertex- i to its neighbors.
2. 1-dimensional t-patch operators – string operators,

$$Z_{\text{str}_{ij}} = Z_i Z_j, \quad (87)$$

where the string $_{ij}$ connects the vertex- i and vertex- j . We see that the string operator has an empty bulk.

3. 2-dimensional t-patch operators – disk operators,

$$X_{\text{disk}} = \prod_{i \in \text{disk}} X_i. \quad (88)$$

The disk operator has a non trivial bulk, which generate our \mathbb{Z}_2 symmetry.

In terms of t-patch operators, algebra of local symmetric operators takes the following form

$$Z_{\text{str}_{ij}} Z_{\text{str}_{jk}} = Z_{\text{str}_{ik}}, \quad (89)$$

$$X_{\text{disk}_1} X_{\text{disk}_2} = X_{\text{disk}_{1+2}} \quad (90)$$

$$Z_{\text{str}} X_{\text{disk}} = -X_{\text{disk}} Z_{\text{str}}, \quad (91)$$

$$Z_{\text{str}} X_{\text{disk}} = +X_{\text{disk}} Z_{\text{str}} \quad (92)$$

Eqn. (89) describes the fusion of string operators (see Fig. 12a). Eqn. (90) describes the fusion of disk operators (see Fig. 12b). The commutator between the string and the disk operators depends on their relative positions. If the string straddle the boundary of the disk as in Fig. 12c, commutator has a non-trivial phase as in eqn. (91). Otherwise (see Fig. 12d), the string and the disk operators commute as in eqn. (92).

Since the string operators have empty bulk, they correspond to patch charge operators, and the ends of the string operators correspond to charged particles. The disk operators have non-trivial bulk, and correspond to patch \mathbb{Z}_2 -symmetry operators, which generate the \mathbb{Z}_2 symmetry transformations and select local symmetric operators.

As before, the patch symmetry transformations can detect the symmetry charge hidden in the local symmetric operators: when the string operator Z_{str} straddle the boundary of the disk operator W_{patch} , the two operators have a non-trivial commutation relation:

$$Z_{\text{str}} X_{\text{disk}} = -X_{\text{disk}} Z_{\text{str}}. \quad (93)$$

This non-trivial commutation relation measures the charge carried by one end of the string operator. If we view the order of the operator product as the order in time, and view the string as world line of a particle in spacetime (see Fig. 13), then the commutation relation eqn. (93) can be viewed as a braiding of the particle around the boundary of the disk operator. The charge is measured by such a braiding process.

B. Algebra of patch charge operators and braided fusion higher category of charge objects

The properties of the charges of an anomaly-free symmetry in n -dimensional space can be systematically and fully described by a braided fusion n -category or a local n -fusion category.[45] Let us first give a brief physical introduction of fusion n -category (see Fig. 8). A fusion n -category can be used to describe extended physical objects in nd space. For example, in 3d space,

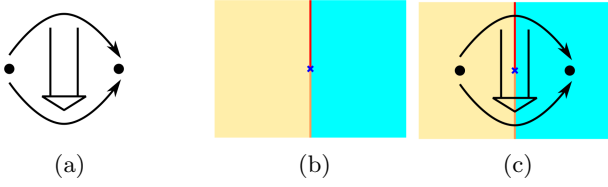

FIG. 8. (a) A graphic representation of objects (the points), 1-morphism (the lines connecting points), and 2-morphism (the disk connecting lines), in a higher category. (b) In 2d spacetime (the vertical direction is the time direction), two world sheets of string-like excitations are separated by two world lines of point-like excitations. The two world lines of point-like excitations are separated by an instanton (a local operator). (c) A higher category describes the structure of extended excitations: in 2d, object \leftrightarrow co-dimension-1 excitation (string); 1-morphism \leftrightarrow co-dimension-2 excitation (particle); 2-morphism \leftrightarrow co-dimension-3 instanton (local operator).

2-dimensional membranes (co-dimension-1) correspond to the objects in the fusion 3-category. 1-dimensional strings (co-dimension-2) correspond 1-morphisms, and 0-dimensional particles (co-dimension-3) correspond 2-morphisms. The above are physical excitations. Instantons or local operators (0-dimensional in spacetime) correspond 3-morphisms, which are top morphisms. The physical excitations and local operators form the fusion n -category.

To connect the \mathbb{Z}_2 symmetry in 2-dimensional space to a braided fusion 2-category, we view the local symmetric operators O_i^{symm} as the 2-morphisms, and the end of string operator Z_{str} (*i.e.* \mathbb{Z}_2 -charge) as a 1-morphism e in a fusion 2-category. Operator product of string operator can be viewed as fusion of string ends, which gives rise to the fusion rule of the 1-morphisms e_i :

$$e \otimes e = \mathbf{1}, \quad \mathbf{1} \otimes e = e \otimes \mathbf{1} = e. \quad (94)$$

e 's are the point-like \mathbb{Z}_2 -charges for \mathbb{Z}_2 symmetry. Those \mathbb{Z}_2 -charges can form a 1d quantum liquid state, which correspond to a string excitation [40]. Let $s_{\mathbb{Z}_2}$ be a string excitation that corresponds to the 1d spontaneous symmetry breaking state formed by the \mathbb{Z}_2 -charges (which is a state with a non-zero energy gap). (Note that the \mathbb{Z}_2 -charges have a \mathbb{Z}_2 conservation as implies by the \mathbb{Z}_2 fusion $e \otimes e = \mathbf{1}$. So they can form a non-trivial 1d gapped quantum liquid state – a spontaneous symmetry breaking state.) We have another string excitation $\mathbf{1}_{\text{str}}$ which is formed by \mathbb{Z}_2 charges along the string in a gapped symmetric state. Note that a string with no \mathbb{Z}_2 charge is also a symmetric gapped state. So $\mathbf{1}_{\text{str}}$ may mean null string, a string that does not have any thing. The string formed by \mathbb{Z}_2 charges in gapped symmetric state and the string formed by nothing are equivalent (*i.e.* they can deform into each other without closing the energy gap), and both are denoted as $\mathbf{1}_{\text{str}}$.

In addition to the point-like excitation e , we have another point-like excitation, denoted as b_s , which is the

domain wall that connects the string- $s_{\mathbb{Z}_2}$ and string- $\mathbf{1}_{\text{str}}$. Since, string- $\mathbf{1}_{\text{str}}$ is trivial (*i.e.* can be nothing), b_s can also be viewed as a boundary of string $s_{\mathbb{Z}_2}$. The fusion of e and b_s gives us the third point-like excitation $e \otimes b_s$.

The above excitations, plus the \mathbb{Z}_2 symmetric local operators form a symmetric fusion 2-category denoted as $2\text{Rep}_{\mathbb{Z}_2}$: [45]

1. The string-like excitations $\mathbf{1}_{\text{str}}$ and $s_{\mathbb{Z}_2}$ are objects in $2\text{Rep}_{\mathbb{Z}_2}$.
2. The point-like excitations $\mathbf{1}$, e , and b_s are 1-morphisms:

$$\begin{aligned} \mathbf{1}_{\text{str}} &\xrightarrow{b_s} s_{\mathbb{Z}_2}, & s_{\mathbb{Z}_2} &\xrightarrow{b_s} \mathbf{1}_{\text{str}}, & \mathbf{1}_{\text{str}} &\xrightarrow{e \otimes b_s} s_{\mathbb{Z}_2}, & s_{\mathbb{Z}_2} &\xrightarrow{e \otimes b_s} \mathbf{1}_{\text{str}}, \\ \mathbf{1}_{\text{str}} &\xrightarrow{\mathbf{1}} \mathbf{1}_{\text{str}}, & \mathbf{1}_{\text{str}} &\xrightarrow{e} \mathbf{1}_{\text{str}}, & s_{\mathbb{Z}_2} &\xrightarrow{\mathbf{1}} s_{\mathbb{Z}_2}. \end{aligned} \quad (95)$$

The 1-morphisms describe how objects are connected — in our case, how strings are connected by point-like domain walls. The point-like domain walls connecting trivial string $\mathbf{1}_{\text{str}}$ to trivial string $\mathbf{1}_{\text{str}}$ are what we usually call point-like excitations.

3. The symmetric operators O^{symm} are 2-morphisms:

$$\begin{aligned} \mathbf{1} &\xrightarrow{O^{\text{symm}}} \mathbf{1}, & e &\xrightarrow{O^{\text{symm}}} e, & e \otimes b_s &\xrightarrow{O^{\text{symm}}} e \otimes b_s, \\ b_s &\xrightarrow{O^{\text{symm}}} b_s, & b_s &\xrightarrow{O^{\text{symm}}} e \otimes b_s, & e \otimes b_s &\xrightarrow{O^{\text{symm}}} b_s. \end{aligned} \quad (96)$$

The symmetric operators O^{symm} describe the possible ways a point-like excitation can change (*i.e.* possible “domain walls” on world lines of point-like excitations in spacetime). We note that, $e \otimes b_s$ and b_s are connected by 2-morphisms. Physically, it means that the \mathbb{Z}_2 charge e can disappear or appear by itself near b_s , by processes induced by symmetric operators. This is expected b_s is connected to a spontaneous symmetry breaking state. We also note that e is the \mathbb{Z}_2 charge which is not connected to the trivial excitation $\mathbf{1}$ by any 2-morphisms.

Here we would like to introduce a notion elementary-type: [40, 45]

Definition^{Ph} 9. *Two morphisms (or objects which can be viewed as 0-morphisms) connected by higher morphisms are said to have the same elementary-type.*

We see that $2\text{Rep}_{\mathbb{Z}_2}$ has only one elementary-types of objects, which is the trivial elementary-type, *i.e.* both string- $\mathbf{1}_{\text{str}}$ and string- $s_{\mathbb{Z}_2}$ belong to trivial elementary-type. $2\text{Rep}_{\mathbb{Z}_2}$ has only three elementary-types of 1-morphisms (particles), $\mathbf{1}$, e , and $b_s \cong e \otimes b_s$. e is an excitation in the usual physics sense since it connect string- $\mathbf{1}_{\text{str}}$ to string- $\mathbf{1}_{\text{str}}$. e is not connected to trivial excitation $\mathbf{1}$ by 2-morphisms, and thus is a non-trivial elementary excitation.

In the above, we describe the symmetric fusion 2-category $2\text{Rep}_{\mathbb{Z}_2}$ from the point of view of excitations.

We can also describe the symmetric fusion 2-category $2\text{Rep}_{\mathbb{Z}_2}$ from the point of view of patch charge operators, generated by $Z_{\text{str}_{ij}}$. Note that patch charge operators from a sub-algebra of the algebra of all t-patch operators.

To switch from the excitation point of view to operator point of view, we replace the excitations by the patch charge operators, that create the corresponding excitations from \mathbb{Z}_2 symmetric product state. Here, the \mathbb{Z}_2 symmetric product state is given by

$$|\Psi_{\text{symm}}\rangle = \bigotimes_i |0\rangle_i, \quad |0\rangle = \frac{|+1\rangle + |-1\rangle}{\sqrt{2}}, \quad (97)$$

where the \mathbb{Z}_2 -symmetry action W is given by $|+1\rangle \leftrightarrow |-1\rangle$. This gives rise to a description of symmetric fusion 2-category $2\text{Rep}_{\mathbb{Z}_2}$ in terms of patch charge operators (*i.e.* t-patch operator with empty bulk)

1. The object $\mathbf{1}_{\text{str}}$ in $2\text{Rep}_{\mathbb{Z}_2}$ corresponds to a disk-operator (a patch-operator with 2-dimensional patch) with empty bulk

$$\hat{\mathbf{1}}_{\text{str}}(\text{loop}) = \prod_{i' \in \text{loop} = \partial \text{disk}} \text{id}_{i'}. \quad (98)$$

where id_i is the identity operator. Here loop is a closed string, corresponding to the boundary of the disk. The algebra of the operator $\hat{\mathbf{1}}_{\text{str}}$

$$\hat{\mathbf{1}}_{\text{str}}(\text{loop})\hat{\mathbf{1}}_{\text{str}}(\text{loop}) = \hat{\mathbf{1}}_{\text{str}}(\text{loop}). \quad (99)$$

is consistent with the fusion of the object

$$\mathbf{1}_{\text{str}} \otimes \mathbf{1}_{\text{str}} = \mathbf{1}_{\text{str}}. \quad (100)$$

The object $s_{\mathbb{Z}_2}$ corresponds to a different disk-operator with empty bulk

$$\hat{s}_{\mathbb{Z}_2}(\text{loop}) = \prod_{i' \in \text{loop} = \partial \text{disk}} P_{+,i'} + \prod_{i' \in \text{loop} = \partial \text{disk}} P_{-,i'},$$

$$P_{\pm} = \frac{\text{id} \pm Z}{2}. \quad (101)$$

(Here P_{\pm} can be any local operators that satisfy $P_+ \neq P_-$ and $WP_+ = P_-W$.) Again, $s_{\mathbb{Z}_2}$ is a closed string, corresponding to the boundary of the disk. We note that string $s_{\mathbb{Z}_2}$ correspond to a spontaneous symmetry breaking state that has a 2-fold degenerate ground states, $\otimes_i |+1\rangle_i$ and $\otimes_i |-1\rangle_i$. The operator $\prod_{i' \in \text{loop} = \partial \text{disk}} P_{+,i'}$ creates the state $\otimes_i |+1\rangle_i$ from $|\Psi_{\text{symm}}\rangle$, while the operator $\prod_{i' \in \text{loop} = \partial \text{disk}} P_{-,i'}$ creates the state $\otimes_i |-1\rangle_i$. A particular superposition of the two states $\prod_{i' \in \text{loop} = \partial \text{disk}} P_{+,i'} + \prod_{i' \in \text{loop} = \partial \text{disk}} P_{-,i'}$ is invariant under the \mathbb{Z}_2 symmetry transformation W . The operator $\hat{s}_{\mathbb{Z}_2}(\text{loop})$ creates such \mathbb{Z}_2 symmetric state, and satisfies

$$\hat{s}_{\mathbb{Z}_2}(\text{loop})X_{\text{disk}} = X_{\text{disk}}\hat{s}_{\mathbb{Z}_2}(\text{loop}) \quad (102)$$

as long as the string is far away from the boundary of patch symmetry operator X_{disk} .

The operator algebra

$$\begin{aligned} & \hat{s}_{\mathbb{Z}_2}(\text{loop})\hat{s}_{\mathbb{Z}_2}(\text{loop}') \quad (103) \\ &= \left(\prod_{i' \in \text{loop}} P_{+,i'} \prod_{i' \in \text{loop}'} P_{+,i'} + \prod_{i' \in \text{loop}} P_{-,i'} \prod_{i' \in \text{loop}'} P_{-,i'} \right) \\ &+ \left(\prod_{i' \in \text{loop}} P_{+,i'} \prod_{i' \in \text{loop}'} P_{-,i'} + \prod_{i' \in \text{loop}} P_{-,i'} \prod_{i' \in \text{loop}'} P_{+,i'} \right) \\ &\equiv \hat{s}_{\mathbb{Z}_2}(\text{loop}'_1) + \hat{s}_{\mathbb{Z}_2}(\text{loop}'_2). \end{aligned}$$

implies the following fusion rule for the loop-like object $s_{\mathbb{Z}_2}$:

$$s_{\mathbb{Z}_2} \otimes s_{\mathbb{Z}_2} = s_{\mathbb{Z}_2} \oplus s_{\mathbb{Z}_2} = 2s_{\mathbb{Z}_2}, \quad (104)$$

which is non-trivial. Here, we have assumed that the two strings, loop and loop', are not on top of each other, but are just nearby. Also

$$\begin{aligned} \hat{s}_{\mathbb{Z}_2}(\text{loop}'_1) &\equiv \prod_{i' \in \text{loop}} P_{+,i'} \prod_{i' \in \text{loop}'} P_{+,i'} + \prod_{i' \in \text{loop}} P_{-,i'} \prod_{i' \in \text{loop}'} P_{-,i'}, \\ \hat{s}_{\mathbb{Z}_2}(\text{loop}'_2) &\equiv \prod_{i' \in \text{loop}} P_{+,i'} \prod_{i' \in \text{loop}'} P_{-,i'} + \prod_{i' \in \text{loop}} P_{-,i'} \prod_{i' \in \text{loop}'} P_{+,i'}, \end{aligned} \quad (105)$$

and they both create spontaneous symmetry breaking states.

2. The 1-morphisms $\mathbf{1}$, e , and b_s (or more precisely, pairs of 1-morphisms) correspond to boundary of open-string operators:

$$\begin{aligned} \hat{\mathbf{1}}_i \hat{\mathbf{1}}_j &= \prod_{i' \in \partial \text{str}_{ij}} \text{id}_{i'} = \text{id}_i \text{id}_j, \\ \hat{e}_i \hat{e}_j &= \prod_{i' \in \partial \text{str}_{ij}} Z_{i'} = Z_i Z_j, \\ \hat{b}_{s,i} \boxtimes_s \hat{b}_{s,j} &= \prod_{i' \in \text{str}_{ij}} P_{+,i'} + \prod_{i' \in \text{str}_{ij}} P_{-,i'} \end{aligned} \quad (106)$$

They are consistent with eqn. (95), which describes how objects are connected by the 1-morphisms.

We would like to remark that $\hat{\mathbf{1}}_i \hat{\mathbf{1}}_j$ and $\hat{e}_i \hat{e}_j$ are t-patch operators with an 1-dimensional patch, while $\hat{b}_{s,i} \boxtimes_s \hat{b}_{s,j}$ is a t-patch operators with a 2-dimensional patch (*i.e.* a disk). The string $s_{\mathbb{Z}_2}$ form a part of the boundary of the disk, and the string $\mathbf{1}_{\text{str}}$ form the other part of the boundary. The two types of boundaries are connected by the 1-morphism b_s .

3. The symmetric operators O^{symm} are 2-morphisms.

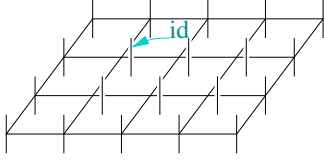

FIG. 9. The structure of a disk-like operator with empty bulk in term of tensor network. The short detached vertical lines represent identity operators on different sites, which given rise to the empty bulk of the disk-like operator. The non-trivial string operator on the boundary of the disk may have a Wess-Zumino form, *i.e.* may be given by a tensor network on the disk bounded by the string.

From the operator algebra

$$\begin{aligned}
& \hat{e}_i \hat{e}_j (\hat{b}_{s,i} \boxtimes_s \hat{b}_{s,j}) \\
&= Z_i Z_j \prod_{i' \in \text{str}_{ij}} P_{+,i'} + Z_i Z_j \prod_{i' \in \text{str}_{ij}} P_{-,i'} \\
&= \prod_{i' \in \text{str}_{ij}} P_{+,i'} + \prod_{i' \in \text{str}_{ij}} P_{-,i'} \\
&= \hat{b}_{s,i} \boxtimes_s \hat{b}_{s,j}
\end{aligned} \tag{107}$$

we see that we cannot distinguish $b_{s,i}$ from $e_i \otimes b_{s,i}$, *i.e.* they are connected by identity operator. This implies the relations $b_{s,i} \xrightarrow{O^{\text{symm}}} e_i \otimes b_{s,i}$ and $e_i \otimes b_{s,i} \xrightarrow{O^{\text{symm}}} b_{s,i}$, proposed in eqn. (96). We also note that operator $\hat{\mathbf{1}}_i \hat{\mathbf{1}}_j = \text{id}_i \text{id}_j$ cannot be connected to operator $\hat{e}_i \hat{e}_j = Z_i Z_j$ via local symmetric operators near vertex- i and vertex- j . This implies that there is no 2-morphisms connecting $\mathbf{1}$ and e .

In our above description of symmetric fusion 2-category $2\mathcal{R}\text{ep}_{\mathbb{Z}_2}$, we include a descendant excitation[40, 45, 87, 88] $s_{\mathbb{Z}_2}$ formed by elementary excitations e . Such a descendant string excitation $s_{\mathbb{Z}_2}$ is a spontaneous \mathbb{Z}_2 symmetry breaking state formed by 1d e gas.

In the above description of operator algebra, we construct the string operators (or the disk operator with empty bulk) via operators P^\pm on the string. In general, the disk operator with empty bulk is given by a tensor network operator, whose structure is given in Fig. 9.

Since descendant excitations are formed by lower dimensional excitations, their existence and properties can be derived. Thus, we may drop all the descendant excitations and use only elementary excitations,[40, 41]⁶ to obtain a simpler description of the symmetric fusion 2-category:

1. The string-like excitations $\mathbf{1}_{\text{str}}$ is the only elementary object in $2\mathcal{R}\text{ep}_{\mathbb{Z}_2}$.

⁶ The elementary excitations are not formed by lower dimensional excitations. They are defined as the excitations that do not have any domain wall with the trivial excitations.

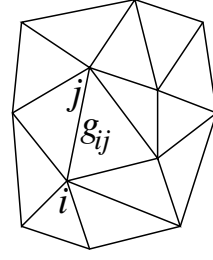

FIG. 10. A 2d lattice bosonic model, whose degrees of freedom live on the links and are labeled by the elements in a group: $g_{ij} \in G$

2. The point-like excitations $\mathbf{1}$ and e are the only elementary 1-morphisms:

$$\mathbf{1}_{\text{str}} \xrightarrow{\mathbf{1}} \mathbf{1}_{\text{str}}, \quad \mathbf{1}_{\text{str}} \xrightarrow{e} \mathbf{1}_{\text{str}}, \tag{108}$$

3. The symmetric operators O^{symm} are all the 2-morphisms:

$$\mathbf{1} \xrightarrow{O^{\text{symm}}} \mathbf{1}, \quad e \xrightarrow{O^{\text{symm}}} e. \tag{109}$$

Note that the elementary morphisms (or objects) $\mathbf{1}$ and e are not connected to any other elementary morphisms (except themselves) by higher morphisms. This defines the **elementary** morphisms or objects[40, 41].

Through the above example, we see that the algebra of the patch charge operators generated by $Z_{\text{str}_{ij}}$ from a symmetric fusion 2-category $2\mathcal{R}\text{ep}_{\mathbb{Z}_2}$. Such a symmetric fusion 2-category $2\mathcal{R}\text{ep}_{\mathbb{Z}_2}$ fully characterize \mathbb{Z}_2 symmetry in 2-dimensional space, which is called the representation category of the symmetry.

Similarly, we can use a fusion 2-category to describe the symmetry transformations of the \mathbb{Z}_2 0-symmetry, *i.e.* to describe the operator algebra generated by the patch symmetry operators X_{disk} . The boundary of the disk operators X_{disk} are labeled by the group elements in $G = \mathbb{Z}_2$, and correspond to the objects in the fusion 2-category. Adding the trivial 1-morphisms and the top 2-morphisms formed by the local operators X_i (*i.e.* the small disk operators), we get a fusion 2-category $2\mathcal{V}\text{ec}_{\mathbb{Z}_2}$. The fusion 2-category $2\mathcal{V}\text{ec}_{\mathbb{Z}_2}$ fully describes the \mathbb{Z}_2 0-symmetry in 2d space, which is the transformation category of the symmetry.

C. $\mathbb{Z}_2^{(1)}$ 1-symmetry in 2d space

In this section, we are going to discuss a lattice model with the simplest higher symmetry, and the algebra of its local symmetric operators, as well as its categorical description. Let us consider a 2d lattice bosonic quantum

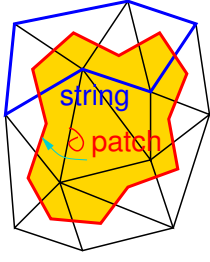

FIG. 11. A loop formed by links and a patch formed by vertices. The boundary of the patch is formed by the links of the dual lattice.

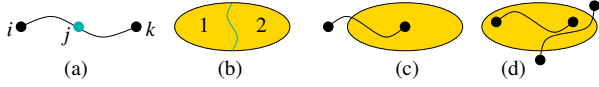

FIG. 12. (a) “Fusion” of two string operators. (b) “Fusion” of two disk operators. (c) Non-trivial “braiding” between string operator and disk operator. (d) Trivial “braiding” between string operator and disk operator.

system with two state on every link of the lattice (see Fig. 10). The \mathbb{Z}_2 1-symmetry is defined by the transformations on all the loops S^1 (formed by the links, see Fig. 11):

$$W(S^1) = \bigotimes_{\langle ij \rangle \in S^1} \tilde{X}_{ij}, \quad (110)$$

where \tilde{X}_{ij} are the Pauli X-operators acting in the link $\langle ij \rangle$. Local symmetric operators satisfy

$$W(S^1)O_i^{\text{symm}} = O_i^{\text{symm}}W(S^1), \quad \forall \text{ loops } S^1. \quad (111)$$

Such kind of symmetry was called d -dimensional gauge-like symmetry [1] or higher form symmetry [4].

The algebra of local symmetric operators is generated by the following open string operators and disk operators:

$$\tilde{X}_{\text{str}_{ij}} = \bigotimes_{\langle i'j' \rangle \in \text{str}_{ij}} \tilde{X}_{i'j'}, \quad \tilde{Z}_{\text{disk}} = \bigotimes_{\langle i'j' \rangle \in \partial \text{disk}} \tilde{Z}_{i'j'} \quad (112)$$

The key relations of the patch operator algebra are given by (see Fig. 12)

$$\begin{aligned} \tilde{X}_{\text{str}_{ij}} \tilde{X}_{\text{str}_{jk}} &= \tilde{X}_{\text{str}_{ik}}, & \tilde{Z}_{\text{disk}_1} \tilde{Z}_{\text{disk}_2} &= \tilde{Z}_{\text{disk}_{1+2}} \\ \tilde{X}_{\text{str}} \tilde{Z}_{\text{disk}} &= \pm \tilde{Z}_{\text{disk}} \tilde{X}_{\text{str}}, \end{aligned} \quad (113)$$

where the \pm signs depend on the relation between the string and the disk (see Fig. 12(c,d)). Here and later in this paper, we will ignore the operators associated with the descendant excitations. All those descendant operators are generated by the elementary operators (associated with the elementary excitations) listed above.

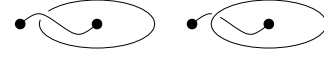

FIG. 13. Non-trivial “braiding” between string operator and disk operator measures the 0-symmetry charge carried by boundary of string, if the disk operator generates a 0-symmetry. It measures the 1-symmetry charge carried by boundary of disk, if the string operator generates a 1-symmetry.

We can also use the patch operators \tilde{X}_{str} on open strings to define the 1-symmetry (see Fig. 13):

$$\tilde{X}_{\text{str}} O_i^{\text{symm}} = O_i^{\text{symm}} \tilde{X}_{\text{str}}, \quad (114)$$

where i is far away from string ends. Using such patch symmetry operators, we can measure the $\mathbb{Z}_2^{(1)}$ 1-charge on the boundary of the disk operator \tilde{Z}_{disk} :

$$\tilde{Z}_{\text{disk}} \tilde{X}_{\text{str}} = -\tilde{X}_{\text{str}} \tilde{Z}_{\text{disk}} \quad (115)$$

when the string straddle across the boundary of the disk. We see that a $\mathbb{Z}_2^{(1)}$ 1-charge in 2-dimensional space is a 1-dimensional extended object. In general, an n -dimensional charge object correspond to n -symmetry, in any space dimensions.

We can use a fusion 2-category to describe the charges of the $\mathbb{Z}_2^{(1)}$ 1-symmetry, *i.e.* to described the operator algebra of the patch charge operators \tilde{Z}_{disk} . The 1-dimensional (co-dimension-1) extended charge objects (the boundary of the disk operators \tilde{Z}_{disk}) are labeled by the group elements in $G = \mathbb{Z}_2$, and correspond to the objects in the fusion 2-category. Adding the trivial 1-morphisms and the top 2-morphisms formed by the local operators $\prod_{i \in \text{small loop}} \tilde{Z}_i$ (*i.e.* the small disk operators), we get a fusion 2-category $2\text{Vec}_{\mathbb{Z}_2}$. The fusion 2-category $2\text{Vec}_{\mathbb{Z}_2}$ fully describes the \mathbb{Z}_2 1-symmetry in 2d space. Such a fusion 2-category $2\text{Vec}_{\mathbb{Z}_2}$ is the representation category of the symmetry.

We can also use a fusion 2-category to describe the symmetry transformations of the $\mathbb{Z}_2^{(1)}$ 1-symmetry, *i.e.* to describe the operator algebra of the patch symmetry operators \tilde{X}_{str} . The boundary of the string operators \tilde{X}_{str} are labeled by the representations in $G = \mathbb{Z}_2$, and correspond to the 1-morphisms in the fusion 2-category. Adding the trivial objects and the top 2-morphisms formed by the local operators \tilde{X}_i (*i.e.* the small string operators), we get a fusion 2-category $2\text{Rep}_{\mathbb{Z}_2}$.⁷ The fusion 2-category $2\text{Rep}_{\mathbb{Z}_2}$ fully describes the \mathbb{Z}_2 1-symmetry in 2d space. Such a fusion 2-category $2\text{Rep}_{\mathbb{Z}_2}$ is the transformation category of the $\mathbb{Z}_2^{(1)}$ 1-symmetry in 2-dimensional space.

⁷ In this paper, when we refer to 2Rep_G , we mostly only consider its associated elementary excitations and the related structures (which correspond to a pre-fusion 2-category). We do not fully discuss the associated descendant excitations in 2Rep_G .

D. The equivalence between \mathbb{Z}_2 0-symmetry and $\mathbb{Z}_2^{(1)}$ 1-symmetry in 2d space

We have seen that a \mathbb{Z}_2 0-symmetry can be fully described by a representations category $2\mathcal{R}ep_{\mathbb{Z}_2}$ or by a transformation category $2\mathcal{V}ec_{\mathbb{Z}_2}$. We also see that a $\mathbb{Z}_2^{(1)}$ 1-symmetry can be fully described by a representations category $2\mathcal{V}ec_{\mathbb{Z}_2}$ or by a transformation category $2\mathcal{R}ep_{\mathbb{Z}_2}$. Now it is clear that the two very different looking symmetries, \mathbb{Z}_2 and $\mathbb{Z}_2^{(1)}$, are closely related, *i.e.* they become identical if we exchange what we call patch charge operators and what we call patch symmetry operators.

In fact, the two symmetries, \mathbb{Z}_2 and $\mathbb{Z}_2^{(1)}$, are indeed equivalent, if we consider the operator algebras of all local symmetric operators, *i.e.* the operator algebras generated by both patch charge operators and patch symmetry operators. The full operator algebra of \mathbb{Z}_2 symmetry is defined via the following operator relations

$$\begin{aligned} Z_{\text{str}_{ij}} Z_{\text{str}_{jk}} &= Z_{\text{str}_{ik}}, & X_{\text{disk}_1} X_{\text{disk}_2} &= X_{\text{disk}_{1+2}} \\ Z_{\text{str}} X_{\text{disk}} &= \pm X_{\text{disk}} Z_{\text{str}}, \end{aligned} \quad (116)$$

The full operator algebra of $\mathbb{Z}_2^{(1)}$ symmetry is defined via the following operators relations

$$\begin{aligned} \tilde{X}_{\text{str}_{ij}} \tilde{X}_{\text{str}_{jk}} &= \tilde{X}_{\text{str}_{ik}}, & \tilde{Z}_{\text{disk}_1} \tilde{Z}_{\text{disk}_2} &= \tilde{Z}_{\text{disk}_{1+2}} \\ \tilde{X}_{\text{str}} \tilde{Z}_{\text{disk}} &= \pm \tilde{Z}_{\text{disk}} \tilde{X}_{\text{str}}, \end{aligned} \quad (117)$$

We see that the two operator algebras are isomorphic. Thus the \mathbb{Z}_2 and $\mathbb{Z}_2^{(1)}$ symmetries have the same categorical symmetry, which implies that they are equivalent.

In fact, the categorical symmetry from the full algebra of extended t-patch operators corresponds to a non-degenerate braided fusion 2-category $2\mathcal{G}au_{\mathbb{Z}_2}$ (which describes the excitations in a 2d \mathbb{Z}_2 -gauge theory). The boundary of the disk operators are labeled by the group elements of \mathbb{Z}_2 , and correspond to the object in the braided fusion 2-category $2\mathcal{G}au_{\mathbb{Z}_2}$. The ends of the string operators are labeled by the group representations, and correspond to the 1-morphisms in $2\mathcal{G}au_{\mathbb{Z}_2}$. The local symmetric operators (*i.e.* the small string and small disk operators) correspond to the 2-morphisms in $2\mathcal{G}au_{\mathbb{Z}_2}$. The string-like elementary excitations (the objects) and the point-like elementary excitations (the 1-morphisms) can fully detect each others, due to their non-trivial mutual statistics, as implied by the operator relation

$$Z_{\text{str}} X_{\text{disk}} = \pm X_{\text{disk}} Z_{\text{str}}. \quad (118)$$

Thus the braided fusion 2-category for the full algebra of extended t-patch operators is non-degenerate.⁸

A mathematically rigorous proof of this equivalence was presented in Ref. 89, in terms of the category theoretical notion of Morita equivalence.

⁸ The adjective ‘‘full’’ here refers to the ‘‘non-degeneracy’’ of the associated braided fusion category.

IX. A REVIEW OF HOLOGRAPHIC THEORY OF (ALGEBRAIC HIGHER) SYMMETRY

In the previous sections, we studied many simple examples, trying to demonstrate a holographic theory of (algebraic higher) symmetry via algebras of local symmetric operator. In this section, we are going to present the holographic theory for generic cases. Such a holographic theory was developed in Ref. 45 via excitations above the symmetric ground state. Here we will present a simplified version, ignoring some subtleties.

A. Representation category

We know that symmetries are classified by groups and higher symmetries are classified by higher groups. As demonstrated in the last section, it turns out that algebraic higher symmetries (*i.e.* non-invertible symmetries) are described by fusion higher categories, [45] which is the representation category [32] generated by patch charge operators that we introduced in Section IV D.

However, not all fusion higher categories can be representation categories that describe algebraic higher symmetries. To identify which fusion higher category can describe a symmetry, we note that a symmetry is breakable. The symmetry breaking will change the fusion higher category into a trivial fusion higher category $n\mathcal{V}ec$. This motivate Ref. 45 to conjecture that local fusion higher categories \mathcal{R} (*i.e.* representation categories generated by patch charge operators) describe and classify algebraic higher symmetries:

Definition^{Ph} 10. *A fusion n -category \mathcal{R} equipped with a **top-faithful** surjective monoidal functor β from \mathcal{R} to the trivial fusion n -category, $\mathcal{R} \xrightarrow{\beta} n\mathcal{V}ec$, is called a **local fusion n -category**. Here, **top-faithful** means that the functor β is injective when acting on the top morphisms (*i.e.* the n -morphism in this case). The pair (\mathcal{R}, β) classify anomaly-free algebraic higher symmetries in n -dimensional space (which include anomaly-free symmetries, higher symmetries, and non-invertible symmetries).*

To be brief, we usually drop β in the pair. This generalizes the discussion in Section IV D. Physically, the functor β means ‘‘ignore the symmetry’’ or ‘‘explicitly break the symmetry by small perturbations’’. Thus at the top-morphism level, β maps local symmetric operators to local operators, which is a injective map. At lower-morphism/object level, the charged excitations in \mathcal{R} are mapped to the excitations in $n\mathcal{V}ec$. This implies that all the objects and morphisms in a local fusion higher category \mathcal{R} have integral quantum dimensions.

For example, if we have an $SU(2)$ symmetry, then there is a ‘‘charged’’ excitation, spin-1/2 excitation (carrying the 2-dim representation of $SU(2)$). If we ignore the $SU(2)$ symmetry, such a spin-1/2 excitation can be

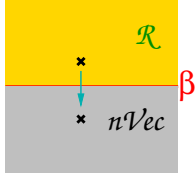

FIG. 14. A spacetime picture of the symmetry breaking process β (the vertical direction is the time). β can be viewed as a domain wall between a product state with the symmetry and a product state with no symmetry. The (extended) excitations on the product state with the symmetry are described by a fusion higher category \mathcal{R} . The (extended) excitations on the product state with no symmetry are described by the fusion higher category $n\mathcal{Vec}$. All the top morphisms (the symmetric spacetime instantons or symmetric local operators) in \mathcal{R} can go through the domain wall β and become the top morphisms (the spacetime instantons or local operators) in $n\mathcal{Vec}$ without modification.

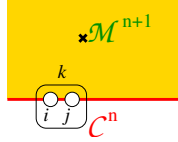

FIG. 15. The holographic principle of topological order: *boundary \mathcal{C}^n uniquely determines bulk \mathcal{M}^{n+1} .*

viewed as an accidental degeneracy of two trivial excitations:

$$\underbrace{\text{spin-1/2}}_{\in \mathcal{R}} \xrightarrow{\beta} \underbrace{\mathbf{1} \oplus \mathbf{1}}_{\in n\mathcal{Vec}}. \quad (119)$$

As we have mentioned above, β is a symmetry breaking process. We can also view \mathcal{R} as the fusion higher category describing the (extended) excitations in a symmetric product state with the symmetry. From this angle, we can view β as a domain wall between \mathcal{R} and $n\mathcal{Vec}$. The domain wall is transparent to all the top morphisms in \mathcal{R} (see Fig. 14).

B. A holographic point view of symmetry

Consider two nd (algebraic higher) symmetries described by two local fusion n -categories, \mathcal{R} and \mathcal{R}' . We know that the two symmetries are equivalent if their algebras of local symmetric operators are isomorphic. We have demonstrated that an isomorphic class of local symmetric operator algebras is described by a braided fusion n -category, and called such an isomorphic class as a *categorical symmetry*. So what is the *categorical symmetry* for a symmetry described by local fusion higher categories, \mathcal{R} ?

To answer this question, let us first review the holographic principle of topological order: *boundary*

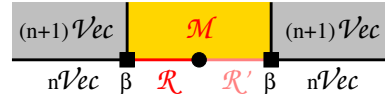

FIG. 16. Two symmetries described by fusion n -categories \mathcal{R} and \mathcal{R}' are equivalent (*i.e.* have the same *categorical symmetry*) iff they have the same bulk topological order in one higher dimension: $\mathcal{Z}(\mathcal{R}) \cong \mathcal{Z}(\mathcal{R}')$.

uniquely determines bulk. In physics, topological orders (*i.e.* gapped quantum liquids) in $n + 1$ d space are characterized by their co-dimension-1, co-dimension-2, ... excitations. In other words, such a topological orders are characterized by fusion $n + 1$ -category \mathcal{M}^{n+1}

On a n -dimensional gapped boundary of the $n + 1$ -dimensional topological order, the excitations are described by a fusion n -category \mathcal{C}^n . The holographic principle of topological order state that the boundary \mathcal{C}^n uniquely determines the bulk \mathcal{M}^{n+1} . Such a boundary-bulk relation is given by the center map \mathcal{Z} in mathematics (see Fig. 15):[40, 41, 49, 90, 91]s

$$\mathcal{Z}(\mathcal{C}^n) = \mathcal{M}^{n+1}. \quad (120)$$

We see that the physical meaning of “center” is “bulk”. The center map (or the bulk map) \mathcal{Z} has a property that the center of a center (or the bulk of a bulk) is trivial

$$\mathcal{Z}(\mathcal{Z}(\mathcal{C}^n)) = (n + 2)\mathcal{Vec}. \quad (121)$$

This is dual to the well known fact: the boundary of a boundary is trivial.

It was conjectured that,[45] in n -dimensional space, the relation between the representation category \mathcal{R} generated by all the patch charge operators and the braided fusion n -category \mathcal{M} (*i.e.* the *categorical symmetry*) generated by all the patch charge operators and the patch symmetry operators is given by another center map, denoted as \mathcal{Z} , [40, 41, 49] that maps a fusion n -category \mathcal{R} into a braided fusion n -category \mathcal{M} . The new center map \mathcal{Z} is closely related to the previous center map \mathcal{Z} that maps a fusion n -category \mathcal{R} into a fusion $(n + 1)$ -category \mathcal{M} . This is because both fusion $(n + 1)$ -category \mathcal{M} and braided fusion n -category \mathcal{M} can be use to fully describe an anomaly-free topological order in $n + 1$ -dimensional space.

We note that in an anomaly-free topological order in $(n + 1)$ -dimensional space, all the co-dimension-1 excitations are descendant (*i.e.* formed by lower dim excitations). Dropping the co-dimension-1 excitations (called looping Ω) maps a fusion $(n + 1)$ -category \mathcal{M} into a braided fusion n -category \mathcal{M} : $\mathcal{M} = \Omega\mathcal{M}$. Adding back the descendant co-dimension-1 excitations is called de-looping followed by Karoubi completion: $\Sigma\mathcal{M} = \mathcal{M}$. [40, 88] Thus the anomaly-free topological order can be described either by the braided fusion n -category \mathcal{M} , or by fusion $(n + 1)$ -category \mathcal{M} . The anomaly-free

condition of topological order corresponds to the non-degeneracy condition for the braided fusion n -category \mathcal{M} , which becomes the trivial center condition for the fusion $(n+1)$ -category \mathcal{M} : $\mathcal{Z}(\mathcal{M}) = (n+2)\mathcal{V}ec$. The two kinds of center maps are related by

$$\Sigma\mathcal{Z} = \mathcal{Z}, \quad \Omega\mathcal{Z} = \mathcal{Z}. \quad (122)$$

This mathematical result provides a macroscopic way to compute the holographic equivalence classes of symmetries (*i.e.* the topological order in one higher dimension). In particular, the two symmetries, described by two representations categories \mathcal{R} and \mathcal{R}' , are equivalent, iff they have equivalent centers (*i.e.* have the same bulk topological order, or have the same categorical symmetry, see Fig. 16)[45]

$$\mathcal{Z}(\mathcal{R}) \cong \mathcal{Z}(\mathcal{R}'). \quad (123)$$

Not every braided fusion higher category describes a categorical symmetry. The operator algebra is formed by *all* the local symmetric operators. The condition of *all*, is translated into a condition on the braided fusion higher category \mathcal{M} : \mathcal{M} must be *non-degenerate*, *i.e.* satisfying $\mathcal{Z}(\Sigma\mathcal{M}) = (n+1)\mathcal{V}ec$. Therefore, categorical symmetries (*i.e.* the isomorphic classes of algebras of symmetric local operator) in nd space are classified by non-degenerate braided fusion n -categories \mathcal{M} .

C. Transformation category – dual of the representation category

Instead of representation category generated by patch charge operators, we can also use transformation category generated by patch symmetry operators to fully describe an (algebraic higher) symmetry. We believe both characterizations are complete characterizations. This belief is supported by the following result [45]:

Proposition 2. *Consider two fusion n -category \mathcal{R} and $\tilde{\mathcal{R}}$, such that $\mathcal{M} = \mathcal{Z}(\mathcal{R}) = \mathcal{Z}(\tilde{\mathcal{R}})$. If $n\mathcal{V}ec = \mathcal{R} \boxtimes_{\mathcal{M}} \tilde{\mathcal{R}}^{\text{rev}}$ (see Fig. 17), then both \mathcal{R} and $\tilde{\mathcal{R}}$ are local fusion n -categories. Furthermore, for each \mathcal{R} , $\tilde{\mathcal{R}}$ is unique. We say that $\tilde{\mathcal{R}}$ is the **dual** of \mathcal{R} .*

For example, an nd bosonic lattice model with a finite symmetry G has a representations category $n\text{Rep}_G$ and a transformation category is $n\mathcal{V}ec_G$. $n\mathcal{V}ec_G$ happens to be the dual of $n\text{Rep}_G$. Such a bosonic model has a dual lattice model with a dual symmetry $G_{\text{rep}}^{(n-1)}$ (see Ref. 45 for an explicit construction). The representations category of the dual symmetry $G_{\text{rep}}^{(n-1)}$ is $n\mathcal{V}ec_G$, and the transformation category of the dual symmetry is $n\text{Rep}_G$. This example illustrates the dual relation between the representations category and the transformation category.

Putting the representation category and the transformation category together – *i.e.* combining the algebras of patch charge operators and patch symmetry operators

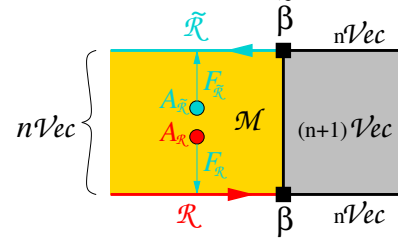

FIG. 17. $\mathcal{R} \boxtimes_{\mathcal{M}} \tilde{\mathcal{R}}^{\text{rev}}$ is a fusion n -category that describes the excitations in a slab of topological order in $(n+1)$ -dimensional space. One boundary of the slab has excitations described by fusion n -category \mathcal{R} . The other boundary of the slab has excitations described by fusion n -category $\tilde{\mathcal{R}}^{\text{rev}}$. The condition $\mathcal{R} \boxtimes_{\mathcal{M}} \tilde{\mathcal{R}}^{\text{rev}} = n\mathcal{V}ec$ ensure that all the excitations on the boundary \mathcal{R} and $\tilde{\mathcal{R}}$ comes from symmetry described by the bulk \mathcal{M} . In other words, all the excitations on the boundary are symmetry charges. There is no topological excitations. $F_{\mathcal{R}}$ is the forgetful functor that maps bulk excitations described by \mathcal{M} to boundary excitations described by \mathcal{R} . $A_{\mathcal{R}}$ is a Lagrangian condensable algebra formed by bulk excitations, which are mapped to trivial excitations on the boundary \mathcal{R} . $A_{\mathcal{R}}$, with a trivial action on the symmetric boundary, correspond to the patch symmetry operators on the boundary. The non-trivial excitations \mathcal{R} on the \mathcal{R} -boundary are created by the patch charge operator. \mathcal{R} and $\tilde{\mathcal{R}}$ are dual to each other is all the bulk excitations either condense on the \mathcal{R} -boundary or $\tilde{\mathcal{R}}$ -boundary.

– gives us the full algebra of local symmetric operators. This algebra contains the full information of the categorical symmetry, which represents the essence of symmetry. From this point of view, symmetry and dual symmetry have the same categorical symmetry and are equivalent. They only differ by swapping the names for patch charge operators and patch symmetry operators.

D. A simple example

In this subsection, we are going to discuss a simple example, to illustrate the above abstract discussions.

1. Holographic view of 2d \mathbb{Z}_2 0-symmetry

As we have discussed in Section VIII A, the representation category of 2d \mathbb{Z}_2 0-symmetry is a fusion 2-category $\mathcal{R} = 2\text{Rep}_{\mathbb{Z}_2}$. The transformation category of 2d \mathbb{Z}_2 0-symmetry is a fusion 2-category $\tilde{\mathcal{R}} = 2\mathcal{V}ec_{\mathbb{Z}_2}$. It has the categorical symmetry $2\mathcal{G}au_{\mathbb{Z}_2} = \mathcal{Z}(2\text{Rep}_{\mathbb{Z}_2}) = \mathcal{Z}(2\mathcal{V}ec_{\mathbb{Z}_2})$, which is the 3d topological order described by \mathbb{Z}_2 gauge theory. In the following, we will use the holographic picture to understand the above results.

The elementary excitations in 3d \mathbb{Z}_2 -gauge theory include point-like excitations e (the bosonic \mathbb{Z}_2 charge) and string-like excitations s (the bosonic \mathbb{Z}_2 -flux string), as

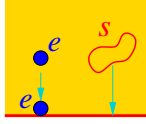

FIG. 18. A boundary of 3d \mathbb{Z}_2 topological order $\mathcal{M} = 2\mathcal{G}\text{au}_{\mathbb{Z}_2}$ induced by s -string condensation. The boundary excitations is described by fusion 2-category $\mathcal{R} = 2\mathcal{R}\text{ep}_{\mathbb{Z}_2}$.

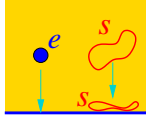

FIG. 19. A boundary of 3d \mathbb{Z}_2 topological order $\mathcal{M} = 2\mathcal{G}\text{au}_{\mathbb{Z}_2}$ induced by e -particle condensation. The boundary excitations is described by fusion 2-category $\tilde{\mathcal{R}} = 2\mathcal{V}\text{ec}_{\mathbb{Z}_2}$.

well as the trivial excitations $\mathbf{1}$ and $\mathbf{1}_{\text{str}}$. They satisfy the fusion rule:

$$e \otimes e = \mathbf{1} \quad s \otimes s = \mathbf{1}_{\text{str}} \quad (124)$$

The string-like excitation s corresponds to the flux line in the 3d \mathbb{Z}_2 -gauge theory, which is an elementary excitation. The 3d \mathbb{Z}_2 -gauge theory also has a non-elementary excitation (*i.e.* descendant) string-like excitation, $s_{\mathbb{Z}_2}$, which is a \mathbb{Z}_2 spontaneous-symmetry-break state formed by the e -particles. Here we ignore all the descendant excitations.

$\mathcal{R} = 2\mathcal{R}\text{ep}_{\mathbb{Z}_2}$ is a boundary of $2\mathcal{G}\text{au}_{\mathbb{Z}_2}$, induced by the \mathbb{Z}_2 -flux loop condensation, so on the boundary $s \sim \mathbf{1}_{\text{str}}$. The boundary excitations then are described by $\{\mathbf{1}, e\} = 2\mathcal{R}\text{ep}_{\mathbb{Z}_2}$. Fig. 18 represents the picture that a symmetry characterized by representation category $\mathcal{R} = 2\mathcal{R}\text{ep}_{\mathbb{Z}_2}$ has the categorical symmetry $2\mathcal{G}\text{au}_{\mathbb{Z}_2}$. The Lagrangian condensible algebra is generated by s , which corresponds to the transformation category $\tilde{\mathcal{R}} = 2\mathcal{V}\text{ec}_{\mathbb{Z}_2}$. Thus Fig. 18 also represents the picture that a symmetry characterized by transformation category $\tilde{\mathcal{R}} = 2\mathcal{V}\text{ec}_{\mathbb{Z}_2}$ has the categorical symmetry $2\mathcal{G}\text{au}_{\mathbb{Z}_2}$.

2. Holographic view of 2d \mathbb{Z}_2 1-symmetry

As we have discussed in Section VIII C, the representation category of 2d \mathbb{Z}_2 0-symmetry is a fusion 2-category $\tilde{\mathcal{R}} = 2\mathcal{V}\text{ec}_{\mathbb{Z}_2}$. The transformation category of 2d \mathbb{Z}_2 0-symmetry is a fusion 2-category $\mathcal{R} = 2\mathcal{R}\text{ep}_{\mathbb{Z}_2}$. It belongs to categorical symmetry $2\mathcal{G}\text{au}_{\mathbb{Z}_2} = \mathcal{Z}(2\mathcal{R}\text{ep}_{\mathbb{Z}_2}) = \mathcal{Z}(2\mathcal{V}\text{ec}_{\mathbb{Z}_2})$, which is the 3d topological order described by \mathbb{Z}_2 gauge theory.

$\tilde{\mathcal{R}} = 2\mathcal{V}\text{ec}_{\mathbb{Z}_2}$ is a boundary of $2\mathcal{G}\text{au}_{\mathbb{Z}_2}$, induced by the \mathbb{Z}_2 -charge condensation, so on the boundary $e \sim \mathbf{1}$. The boundary excitations then are described by $\{\mathbf{1}_{\text{str}}, s\} = 2\mathcal{V}\text{ec}_{\mathbb{Z}_2}$. Fig. 18 represents the picture that a symmetry

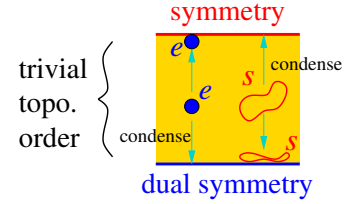

FIG. 20. All the non-trivial excitations in the bulk $2\mathcal{G}\text{au}_{\mathbb{Z}_2}$, either condense on the $2\mathcal{R}\text{ep}_{\mathbb{Z}_2}$ -boundary (s condense) or condense on the $2\mathcal{V}\text{ec}_{\mathbb{Z}_2}$ -boundary (e condense). Thus the slab has no topological excitations and correspond to a trivial topological order.

characterized by representation category $\tilde{\mathcal{R}} = 2\mathcal{V}\text{ec}_{\mathbb{Z}_2}$ has the categorical symmetry $2\mathcal{G}\text{au}_{\mathbb{Z}_2}$. The Lagrangian condensible algebra is generated by e , which corresponds to the transformation category $\mathcal{R} = 2\mathcal{R}\text{ep}_{\mathbb{Z}_2}$. Thus Fig. 19 also represents the picture that a symmetry characterized by transformation category $\mathcal{R} = 2\mathcal{R}\text{ep}_{\mathbb{Z}_2}$ has the categorical symmetry $2\mathcal{G}\text{au}_{\mathbb{Z}_2}$.

3. Symmetry $\mathcal{R} = 2\mathcal{R}\text{ep}_{\mathbb{Z}_2}$ and dual-symmetry $\tilde{\mathcal{R}} = 2\mathcal{V}\text{ec}_{\mathbb{Z}_2}$

In 2d space, \mathbb{Z}_2 0-symmetry and $\mathbb{Z}_2^{(1)}$ 1-symmetry are equivalent, and are dual to each other. This means that \mathbb{Z}_2 0-symmetry and $\mathbb{Z}_2^{(1)}$ 1-symmetry have the same 3d bulk topological order $2\mathcal{G}\text{au}_{\mathbb{Z}_2}$ (*i.e.* have the same categorical symmetry). When we consider a slab 3d bulk topological order $2\mathcal{G}\text{au}_{\mathbb{Z}_2}$ with one boundary being $2\mathcal{R}\text{ep}_{\mathbb{Z}_2}$ and the other boundary being $2\mathcal{V}\text{ec}_{\mathbb{Z}_2}$, then all the non-trivial excitations in the bulk, either condense on the $2\mathcal{R}\text{ep}_{\mathbb{Z}_2}$ -boundary or condense on the $2\mathcal{V}\text{ec}_{\mathbb{Z}_2}$ -boundary (see Fig. 20). So the slab is actually a trivial 2d topological order. This implies that $2\mathcal{R}\text{ep}_{\mathbb{Z}_2}$ and $2\mathcal{V}\text{ec}_{\mathbb{Z}_2}$ are dual to each other.

X. A DERIVATION OF TOPOLOGICAL HOLOGRAPHIC PRINCIPLE

In this paper, we have derived a holographic point of view of symmetry. For a lattice system with a symmetry, we concentrate on the algebra of local symmetric operators, and its irreducible representation – the symmetric sub-Hilbert space. The symmetric sub-Hilbert space does not have a tensor product decomposition, which indicates a (non-invertible) gravitational anomaly.⁹ Since the (non-invertible) gravitational anomaly corresponds to a topological order in one higher dimension (for finite symmetries) [39, 40], the symmetric sub-Hilbert space,

⁹ Here, we view a gravitational anomaly is an obstruction to have a lattice realization *without symmetry*.

plus the algebra of local symmetric operators in it, gives rise to a topological order in one higher dimension.

The above is just some vague ideas. In this paper, we outline a way to compute this topological order in one higher dimension, using the algebra of local symmetric operators. This approach is very general. Even if we do not know the symmetry transformation and do not know the symmetric sub-Hilbert space, but if we know the set of local operators and its algebra, then we can compute the bulk topological order, by compute the braided fusion (higher) category from the operator algebra.

Under such a general setting, our approach can be viewed a derivation of topological holographic principle, which can be simply stated as: *boundary determines the bulk*. The usual holographic principle in AdS/CFT refers to boundary conformal field theory (CFT) with a global symmetry determines a bulk quantum gravity with a gauge theory in an anti-de Sitter (AdS) space in one higher dimension. The topological holographic principle here refers to boundary quantum field theory determines a bulk topological order in one higher dimension. In this paper, we make the above statement more precise by treating quantum field theory as an algebra of local operators. As was shown in this paper, from the algebra of local operators, we can determine a non-degenerate braided fusion (higher) category, which in turn determine the bulk topological order (provided that the braided fusion (higher) category is finite). This corresponds to a derivation of the topological holographic principle.

We may also consider one of the many boundaries of a topological order. The boundary is more precisely described by an algebra of boundary local operators, which create all the low energy boundary excitations.¹⁰ Then, from the boundary operator algebra, we can determine a braided fusion (higher) category which determine the bulk topological order, up to an invertible topological order. The invertible topological order correspond to the usual invertible gravitational anomaly of the boundary theory, which is also determined by the boundary. This way, we showed that

boundary theory uniquely determines the topological bulk,

which is the topological holographic principle.

In this paper, we try to use topological order to describe generalized symmetry (which can go beyond group and higher group) in one lower dimension. We like to remark that, it is the non-invertible topological order that is close to symmetry. The invertible topological order (and the associated usual more familiar invertible gravitational anomaly) is furthest from symmetry. At moment, it is not clear should we generalize the symmetry

even more to include the ones associated with invertible topological order in one higher dimension, or should we use equivalent classes of bulk topological order up to invertible topological order to describe generalized symmetry.

XI. EQUIVALENT SYMMETRIES

One application of the holographic theory of symmetry is to identify equivalence between symmetries, higher symmetries, anomalous (higher) symmetries, algebraic (higher) symmetries, and gravitational anomalies. All those (anomalous and/or higher) symmetries and gravitational anomalies impose constraint on the low energy dynamics of the system. They are equivalent if they impose the identical constraint. Such an equivalence was called holo-equivalence in Ref. 45, to stress its connection holographic picture.

As we have discussed in this paper, two symmetries (described by representation categories \mathcal{R} and \mathcal{R}') are equivalent if they have the same **categorical symmetry**, *i.e.* have the same bulk topological order:

$$\mathcal{Z}(\mathcal{R}) \cong \mathcal{Z}(\mathcal{R}'). \quad (125)$$

In practice, if we know a (higher) symmetry \mathcal{R} is realized as a boundary of a SPT state or a symmetric product state, then the **categorical symmetry** is simply the bulk topological order obtained by gauging the (higher) symmetry in the bulk SPT state or the symmetric product state. We can identify many equivalent symmetries this way.

A. Some known examples

First, let us list some known examples. In nd space, $Z_N^{(m)}$ m -symmetry can be realized by a boundary of $(n+1)d$ product state with $Z_N^{(m)}$ m -symmetry. Thus the **categorical symmetry** of nd $Z_N^{(m)}$ m -symmetry is the $(n+1)d$ Z_N $(m+1)$ -gauge theory. In $(n+1)$ -dimensional space, Z_N $(m+1)$ -gauge theory and Z_N $(n-m)$ -gauge theory correspond to the same topological order. Therefore, in nd space, $Z_N^{(m)}$ m -symmetry is equivalent to $Z_N^{(n-m-1)}$ $(n-m-1)$ -symmetry:

$$Z_N^{(m)} \sim Z_N^{(n-m-1)}. \quad (126)$$

Furthermore, the two symmetries are dual to each other.

Using the similar argument, we can obtain the following results

- In 2d, $\mathbb{Z}_3 \times \mathbb{Z}_2 \sim \mathbb{Z}_3^{(1)} \times \mathbb{Z}_2$. This is actually a direct application of eqn. (126).
- In 2d, $S_3 = \mathbb{Z}_3 \times \mathbb{Z}_2 \sim \mathbb{Z}_3^{(1)} \rtimes \mathbb{Z}_2$. [53] This is the twisted version of the above. $\mathbb{Z}_3^{(1)} \rtimes \mathbb{Z}_2$ is a non-trivial mix of $\mathbb{Z}_3^{(1)}$ 1-symmetry and \mathbb{Z}_2 0-symmetry.

¹⁰ Here, we may assume the bulk topological order to have an infinite energy gap. Then any finite energy excitations can be viewed as boundaries excitations.

The charge objects of $\mathbb{Z}_3^{(1)}$ are strings labeled by s, \bar{s} . The \mathbb{Z}_2 0-symmetry exchange s and \bar{s} .

- In 1d, an anomalous $\mathbb{Z}_2 \times \mathbb{Z}_2 \times \mathbb{Z}_2$ symmetry is equivalent to D_4 symmetry, for a very different reason than the above two examples.[92, 93]

B. Equivalence between anomalous and anomaly-free \mathbb{Z}_n and $\mathbb{Z}_{n_1} \times \mathbb{Z}_{n_2}$ symmetries in 1-dimensional space

In Section VIC, we find an equivalence between 1d \mathbb{Z}_4 symmetry and $\mathbb{Z}_2 \times \mathbb{Z}_2$ symmetry with the mixed anomaly. In this section, we would like to generalize that result. An 1d anomalous \mathbb{Z}_n symmetry is realized by a boundary of 2d \mathbb{Z}_n SPT state. After gauging the \mathbb{Z}_n symmetry in the 2d SPT state, we obtain a 2d Abelian bosonic topological order, which is classified by even K -matrices.[80] In the present case, the corresponding topological order is given by[83]

$$K = \begin{pmatrix} -2m & n \\ n & 0 \end{pmatrix} \quad (127)$$

where $m \in H^3(\mathbb{Z}_n; \mathbb{R}/\mathbb{Z}) = \mathbb{Z}_n$ characterizing the \mathbb{Z}_n anomaly ($m = 0$ for anomaly-free). We will label the anomalous \mathbb{Z}_n symmetry by $(n; m)$.

Similarly, the anomalous 1d $\mathbb{Z}_{n_1} \times \mathbb{Z}_{n_2}$ symmetry is realized by a boundary of 2d $\mathbb{Z}_{n_1} \times \mathbb{Z}_{n_2}$ SPT state. After gauging the $\mathbb{Z}_{n_1} \times \mathbb{Z}_{n_2}$ symmetry, we obtain a 2d Abelian topological order characterized by[83]

$$K = \begin{pmatrix} -2m_2 & n_1 & -m_{12} & 0 \\ n_1 & 0 & 0 & 0 \\ -m_{12} & 0 & -2m_1 & n_2 \\ 0 & 0 & n_2 & 0 \end{pmatrix}, \quad (128)$$

where $m_1 \in \mathbb{Z}_{n_1}$ describing the anomaly of the \mathbb{Z}_{n_1} symmetry, $m_2 \in \mathbb{Z}_{n_2}$ describing the anomaly of the \mathbb{Z}_{n_2} symmetry, and $m_{12} \in \mathbb{Z}_{\text{gcd}(n_1, n_2)}$ describing the mixed anomaly of the $\mathbb{Z}_{n_1} \times \mathbb{Z}_{n_2}$ symmetry. We will label the anomalous $\mathbb{Z}_{n_1} \times \mathbb{Z}_{n_2}$ symmetry by $(n_1, n_2; m_1, m_{12}, m_2)$.

By computing the S, T matrices of the 2d topological orders[47, 94] described by K -matrices, we can identify a set of K -matrices that give rise to the same 2d topological order, and hence correspond to equivalent symmetries. This allows us to find the following sets of equivalent symmetries:

- $(2,2;0,0,1), (2,2;1,0,0), (2,2;1,0,1)$
- $(4;0), (2,2;0,1,0), (2,2;0,1,1), (2,2;1,1,0)$
- $(5;2), (5;3)$
- $(5;1), (5;4)$
- $(6;1), (2,3;1,0,1)$

- $(6;5), (2,3;1,0,2)$
- $(6;3), (2,3;1,0,0)$
- $(6;4), (2,3;0,0,1)$
- $(6;2), (2,3;0,0,2)$
- $(6;0), (2,3;0,0,0)$
- $(7;3), (7;5), (7;6)$
- $(7;1), (7;2), (7;4)$
- $(2,4;0,0,1), (2,4;1,0,1)$
- $(2,4;0,0,3), (2,4;1,0,3)$
- $(2,4;1,1,1), (2,4;1,1,3)$
- $(8;0), (2,4;0,1,0), (2,4;0,1,2), (2,4;1,1,0), (2,4;1,1,2)$
- $(8;4), (2,4;0,1,1), (2,4;0,1,3)$
- $(3,3;1,0,1), (3,3;1,1,2), (3,3;1,2,2), (3,3;2,1,1), (3,3;2,2,1), (3,3;2,0,2)$
- $(3,3;0,0,1), (3,3;1,0,0), (3,3;1,1,1), (3,3;1,2,1)$
- $(9;1), (9;4), (9;7)$
- $(9;2), (9;5), (9;8)$
- $(3,3;0,0,2), (3,3;2,0,0), (3,3;2,1,2), (3,3;2,2,2)$
- $(9;0), (3,3;0,1,0), (3,3;0,2,0), (3,3;0,1,1), (3,3;0,2,1), (3,3;0,1,2), (3,3;0,2,2), (3,3;1,1,0), (3,3;1,2,0), (3,3;1,0,2), (3,3;2,1,0), (3,3;2,2,0), (3,3;2,0,1)$
- $(10;3), (10;7)$
- $(10;1), (10;9)$
- $(10;2), (10;8)$
- $(10;4), (10;6)$
- $(11;2), (11;6), (11;7), (11;8), (11;10)$
- $(11;1), (11;3), (11;4), (11;5), (11;9)$
- $(12;1), (3,4;1,0,1)$
- $(12;7), (3,4;1,0,3)$
- $(12;5), (3,4;2,0,1)$
- $(12;11), (3,4;2,0,3)$
- $(12;9), (3,4;0,0,1)$
- $(12;3), (3,4;0,0,3)$
- $(12;10), (3,4;1,0,2)$
- $(12;4), (3,4;1,0,0)$
- $(12;2), (3,4;2,0,2)$

- (12;8), (3,4;2,0,0)
- (12;6), (3,4;0,0,2)
- (12;0), (3,4;0,0,0)
- (13;2), (13;5), (13;6), (13;7), (13;8), (13;11)
- (13;1), (13;3), (13;4), (13;9), (13;10), (13;12)
- (14;3), (14;5), (14;13)
- (14;1), (14;9), (14;11)
- (14;6), (14;10), (14;12)
- (14;2), (14;4), (14;8)
- (15;7), (15;13)
- (15;1), (15;4)
- (15;2), (15;8)
- (15;11), (15;14)
- (15;3), (15;12)
- (15;6), (15;9)
- (4,4;1,0,1), (4,4;1,2,2), (4,4;2,2,1)
- (4,4;1,0,2), (4,4;1,2,3), (4,4;2,0,1), (4,4;2,0,3),
(4,4;3,2,1), (4,4;3,0,2)
- (4,4;2,2,3), (4,4;3,2,2), (4,4;3,0,3)
- (4,4;0,0,1), (4,4;1,0,0), (4,4;1,2,1)
- (4,4;0,2,1), (4,4;0,2,3), (4,4;1,2,0), (4,4;1,0,3),
(4,4;3,2,0), (4,4;3,0,1)
- (4,4;0,0,3), (4,4;3,0,0), (4,4;3,2,3)
- (4,4;0,0,2), (4,4;2,0,0), (4,4;2,0,2)
- (4,4;0,2,0), (4,4;0,2,2), (4,4;2,2,0)
- (4,4;1,1,1), (4,4;1,3,1), (4,4;1,1,3), (4,4;1,3,3),
(4,4;3,1,1), (4,4;3,3,1), (4,4;3,1,3), (4,4;3,3,3)
- (16;1), (16;9)
- (16;5), (16;13)
- (16;7), (16;15)
- (16;3), (16;11)
- (16;0), (4,4;0,1,0), (4,4;0,3,0), (4,4;0,1,1),
(4,4;0,3,1), (4,4;0,1,2), (4,4;0,3,2), (4,4;0,1,3),
(4,4;0,3,3), (4,4;1,1,0), (4,4;1,3,0), (4,4;1,1,2),
(4,4;1,3,2), (4,4;2,1,0), (4,4;2,3,0), (4,4;2,1,1),
(4,4;2,3,1), (4,4;2,1,2), (4,4;2,3,2), (4,4;2,1,3),
(4,4;2,3,3), (4,4;3,1,0), (4,4;3,3,0), (4,4;3,1,2),
(4,4;3,3,2)

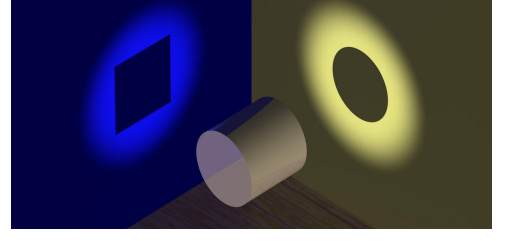

FIG. 21. The same topological order (in one higher dimension) can have different shadows, which correspond to equivalent symmetries, and gives rise to the notion of **categorical symmetry**.

We see that the two symmetries $(4;0)$ and $(2,2;0,1,0)$ are equivalent. This is the equivalence between $\mathbb{Z}_2 \times \mathbb{Z}_2$ symmetry with the mixed anomaly and \mathbb{Z}_4 symmetry in 1d discussed in Section VI C, where we also find a duality transformation, that maps a lattice model with anomalous $\mathbb{Z}_2 \times \mathbb{Z}_2$ symmetry to another lattice model with \mathbb{Z}_4 symmetry. We believe that, in general, for any pair of equivalent symmetries, there is a lattice duality transformation, that maps a lattice model with one symmetry to another lattice model with the other equivalent symmetry. Each pair of the equivalent symmetries in the above list implies a lattice duality map.

We also see that $(4;0)$ and $(2,2;0,1,1)$ are equivalent. Thus the \mathbb{Z}_4 symmetry is also equivalent to $\mathbb{Z}_2 \times \mathbb{Z}_2$ symmetry with the mixed anomaly and an anomaly in one of the \mathbb{Z}_2 symmetry. More generally, it appears that $\mathbb{Z}_n \times \mathbb{Z}_n$ symmetry with a particular mixed anomaly is equivalent to \mathbb{Z}_{n^2} symmetry. It is also interesting to note that, for \mathbb{Z}_p group ($2 < p = \text{prime}$), its $p-1$ anomalous symmetries form just two equivalent classes, and its anomaly-free symmetry form its own equivalent class.

XII. SUMMARY – THE ESSENCE OF A SYMMETRY

With so many equivalences between symmetries labeled by (higher) groups and anomalies, it is clear that group, higher group, anomalies, local fusion higher categories, *etc* are not the best notions to describe a symmetry. The algebra of local symmetric operators provides a more fundamental description of symmetries and (invertible and non-invertible) anomalies of quantum many body systems. In this paper, we show that this algebra contains a special subset of extended operators, dubbed t-patch operators, whose algebraic relations encode the data of a non-degenerate braided fusion n -category. This category happens to capture the universal data of a topological order in one higher dimension. So, this point of view leads to a holographic theory of symmetries and anomalies.

With this, we re-iterate our slogan: “Finite symmetry (with or without anomaly) is the shadow of topological

order in one higher dimension” (see Fig. 21). The topological order in one higher dimension – the categorical symmetry – captures the essence of the symmetry. We end the paper by listing different aspects of categorical symmetry:

A categorical symmetry is

- a symmetry plus its dual symmetry [45, 53].
- a non-invertible gravitational anomaly [38, 40–43, 49].
- a class of isomorphic algebras of local symmetric operators.
- a non-degenerate braided fusion higher category.
- a topological order in one higher dimension [45, 50, 51, 53].

We would like to thank Yu-An Chen, Michael DeMarco, Wenjie Ji, Kyle Kawagoe, Sal Pace, and Carolyn Zhang for useful discussions. This work is partially supported by NSF DMR-2022428 and by the Simons Collaboration on Ultra-Quantum Matter, which is a grant from the Simons Foundation (651446, XGW).

Appendix A: Local symmetric operator algebra and non-degenerate braided fusion 3-category – a 3-dimensional example without symmetry

Let us discuss an example to illustrate the definitions in Section III, for the case without any symmetry. We assume the space to be 3-dimensional. On each vertex- i , we have two degrees of freedom labeled by elements in $\mathbb{Z}_2 \equiv \{+1, -1\}$, *i.e.* the local Hilbert space \mathcal{V}_i on a vertex 2-dimensional. The algebra of local operators is then generated by X_i, Z_i acting on \mathcal{V}_i :

$$\mathcal{A} = \{X_i, Z_i, X_i Z_i, X_i X_j, Z_i Z_j, \dots\} \quad (\text{A1})$$

where i, j are near each other, and the Pauli- X, Z operators are defined by

$$X|\pm 1\rangle = |\mp 1\rangle, \quad Z|\pm 1\rangle = \pm|\pm 1\rangle. \quad (\text{A2})$$

Our local symmetric operator algebra (after the closure by the extended operators) is generated by the following *t-patch operators*:

1. 0-dimensional t-patch operators, X_i, Z_i .
2. 1-dimensional t-patch operators – string operators,

$$X_{\text{str}_{ij}} = X_i X_j, \quad Z_{\text{str}_{ij}} = Z_i Z_j, \quad (\text{A3})$$

where the string $_{ij}$ connects the vertex- i and vertex- j . The string operators must have an empty bulk to commute with the 0-dimensional t-patch operators, when they are far away from the ends of the strings.

3. 2-dimensional t-patch operators – disk operators,

$$\begin{aligned} X_{\text{disk}} &= \prod_{i \in \partial \text{disk}} X_i, & Z_{\text{disk}} &= \prod_{i \in \partial \text{disk}} Z_i, \\ O_{\text{disk}} &= \prod_{i \in \partial \text{disk}} O_i, \end{aligned} \quad (\text{A4})$$

where O_i can be any local operators.

4. 3-dimensional t-patch operators – ball operators,

$$\begin{aligned} X_{\text{ball}} &= \prod_{i \in \partial \text{ball}} X_i, & Z_{\text{ball}} &= \prod_{i \in \partial \text{ball}} Z_i, \\ O_{\text{ball}} &= \sum_{\{m_i\}} \Psi(\{m_i\}) \prod_{i \in \partial \text{ball}} O_i(m_i). \end{aligned} \quad (\text{A5})$$

where $O_i(m_i)$ can be any local operators. For example, $O_i(0) = \text{id}$ and $O_i(1) = X_i$. (More precisely, O_{ball} is a tensor network operator on the boundary of the ball, ∂ball .)

We see that the t-patch operators all have empty bulk, *i.e.* are patch charge operators. There is no patch symmetry operators. This implies that our bosonic system has no symmetry.

If some t-patch operators have non-trivial bulk, then our system will have non-trivial symmetry, as we see in the examples in Section IV and beyond of the main text. In fact, the non-trivial bulk of the t-patch operators will generate the corresponding symmetries, higher symmetries, and/or non-invertible higher symmetries.

We believe that the above algebra of extended t-patch operators is closely related of a braided fusion 3-category 3Vec . At moment, we can only give a very rough description of this connection. A 3-category is formed by 0-morphisms (also called objects), 1-morphisms, 2-morphisms, and 3-morphisms (also called top morphisms). All those morphisms have relations between them. In fact, the collection of all relations between n -morphisms is the collection of all $(n+1)$ -morphisms. The ball operators correspond to the objects, the disk operators the 1-morphisms, the string operators the 2-morphisms, and the local operators the top 3-morphisms. The difference of two ball operators are given by the disk operators, the difference of two disk operators are given by the string operators, etc.

For example, if two string operators $O_{\text{str}_{ij}}$ and $O'_{\text{str}_{ij}}$ are related by local operators O_i and O_j :

$$O'_{\text{str}_{ij}} = O_i O_j O_{\text{str}_{ij}}, \quad (\text{A6})$$

we say the 2-morphism $O_{\text{str}_{ij}}$ connects to the 2-morphism $O'_{\text{str}_{ij}}$ via the 3-morphism $O_i O_j$ on the left:

$$O_{\text{str}_{ij}} \xrightarrow{L: O_i O_j} O'_{\text{str}_{ij}}. \quad (\text{A7})$$

Similarly, if $O_{\text{str}_{ij}}$ and $O'_{\text{str}_{ij}}$ are related by local operators O_i and O_j on the right:

$$O'_{\text{str}_{ij}} = O_{\text{str}_{ij}} O_i O_j, \quad (\text{A8})$$

we also say the 2-morphism $O_{\text{str}_{ij}}$ connects to the 2-morphism $O'_{\text{str}_{ij}}$ via the 3-morphism $O_i O_j$:

$$O_{\text{str}_{ij}} \xrightarrow{R:O_i O_j} O'_{\text{str}_{ij}}. \quad (\text{A9})$$

The 3-morphisms connecting 2-morphisms allow us to defined the notion of **simple** 2-morphisms. A 2-morphism $O_{\text{str}_{ij}}$ is simple if an existence of 3-morphism $O_{\text{str}_{ij}} \xrightarrow{f} O'_{\text{str}_{ij}}$ always implies an existence of 3-morphism $O'_{\text{str}_{ij}} \xrightarrow{g} O_{\text{str}_{ij}}$ in the opposite direction. It turns out that $X_{\text{str}_{ij}}$ and $Z_{\text{str}_{ij}}$ introduced above are not simple. The following string operators are simple

$$P_{\text{str}_{ij}}^\pm = P_i^\pm P_j^\pm, \quad P_i^\pm = \frac{1 \pm Z_i}{2}, \quad P_j^\pm = \frac{1 \pm Z_j}{2}. \quad (\text{A10})$$

Certainly, the notion of simpleness applies to all morphisms.

If two 2-morphisms, $O_{\text{str}_{ij}}$ and $O'_{\text{str}_{ij}}$, satisfy

$$\begin{aligned} O_{\text{str}_{ij}} &\xrightarrow{f} O'_{\text{str}_{ij}}, & O'_{\text{str}_{ij}} &\xrightarrow{g} O_{\text{str}_{ij}}, \\ O_{\text{str}_{ij}} &\xrightarrow{f \circ g = \text{id}} O_{\text{str}_{ij}}, & O'_{\text{str}_{ij}} &\xrightarrow{g \circ f = \text{id}} O'_{\text{str}_{ij}}, \end{aligned} \quad (\text{A11})$$

then we say the two 2-morphisms are isomorphic. In the above example, $O_{\text{str}_{ij}} \xrightarrow{L:O_i O_j} O'_{\text{str}_{ij}}$, if O_i and O_j are invertible, then the 2-morphism $O'_{\text{str}_{ij}}$ connects to the 2-morphism $O_{\text{str}_{ij}}$ via the 3-morphism $O_i^{-1} O_j^{-1}$:

$$\begin{aligned} O_{\text{str}_{ij}} &= O_i^{-1} O_j^{-1} O'_{\text{str}_{ij}}, \\ \text{or } O'_{\text{str}_{ij}} &\xrightarrow{L:O_i^{-1} O_j^{-1}} O_{\text{str}_{ij}} \end{aligned} \quad (\text{A12})$$

In this case, the two 2-morphisms $O_{\text{str}_{ij}}$ and $O'_{\text{str}_{ij}}$ are isomorphic.

The isomorphic relations between 2-morphisms is an equivalent relation. For example $P_{\text{str}_{ij}}^- \cong P_{\text{str}_{ij}}^+$. Although there are infinite many simple 2-morphisms in our example, there is only one equivalence class of simple 2-morphisms. A representative in this equivalence class is given by $P_{\text{str}_{ij}}^- = P_i^- P_j^-$.

In this paper, when we refer to objects and morphisms, we usually refer to the equivalence classes of objects and morphisms, under the isomorphisms discussed above. Combining the definition of simpleness and isomorphism, we see that two simple morphisms cannot be connected by a higher morphism if they are not isomorphic. In other words, different types of morphisms (*i.e.* different equivalence classes of morphisms) cannot be connected by a higher morphism.

We would like to stress that although the t-patch operator considered above all have an empty bulk, the tensor network operator on the boundary can have a Wess-Zumino form. For example, O_{ball} is a tensor network operator on the boundary of the ball, but it can be defined *i.e.* defined by a tensor network on an extension of

∂ball in one higher dimension. Such a tensor network can be viewed as a spacetime path integral on the ball, which can give rise to a topologically ordered state on ∂ball described by wave function $\Psi(\{m_i\})$. We see that we can have infinitely many types of ball operators, each type corresponds to a topological order in 2-dimensional space. Since there is no non-trivial topological order in 0- and 1-dimensional space, thus we have only one type of string-like t-patch operators and one type of membrane-like t-patch operators. Such a structure matches the structure of braided fusion 3-category 3Vec . [45, 88]

Appendix B: Detailed calculations

1. Calculation of $F(s, s, s)$

To compute the F-symbol $F(s, s, s)$, described in eqn. (44), we refer to Fig. 5 and substitute $a = b = c = s$. Using the definitions in equations 39 and 40, this picture translates to the following calculation:

$$\begin{array}{cccc} 0 & 1 & 2 & 3 \\ \hline | & | & | & | \\ \hline \end{array}$$

$$\begin{array}{c} O^\dagger \quad X \quad X \quad ZX \\ \begin{array}{c} \boxed{s} \quad \boxed{s} \quad \boxed{s} \\ \boxed{s} \quad \boxed{s} \quad \boxed{s} \end{array} \\ O \quad O^\dagger \\ \begin{array}{c} \boxed{s} \quad \boxed{s} \quad \boxed{s} \\ O \quad X \quad X \quad XZ \\ \boxed{s} \quad \boxed{s} \quad \boxed{s} \quad \boxed{s} \quad \boxed{s} \\ O \quad X \quad X \quad X \quad X \quad XZ \end{array} \\ = \\ (-1) \cdot \begin{array}{c} \boxed{s} \quad \boxed{s} \quad \boxed{s} \quad \boxed{s} \quad \boxed{s} \\ O \quad X \quad X \quad X \quad X \quad XZ \end{array} \\ O^\dagger \quad X \quad X \quad ZX \\ \begin{array}{c} \boxed{s} \quad \boxed{s} \quad \boxed{s} \\ O \end{array} \end{array}$$

This tells us that $F(s, s, s) = -1$. Note that our operator ordering convention is top-to-bottom and left-to-right (when in the same row).

2. Self-statistics of s particles

We express Fig 6 in equations as

$$\begin{aligned} &T_s(0 \rightarrow 1)T_s(1 \rightarrow 2)T_s(3 \rightarrow 1) \\ &= W_{\text{patch}_{01}} W_{\text{patch}_{12}} W_{\text{patch}_{13}}^\dagger \\ &= e^{i\theta_s} W_{\text{patch}_{13}}^\dagger W_{\text{patch}_{12}} W_{\text{patch}_{01}} \\ &= e^{i\theta_s} T_s(3 \rightarrow 1)T_s(1 \rightarrow 2)T_s(0 \rightarrow 1) \end{aligned} \quad (\text{B1})$$

The l.h.s. can be simplified as

0 1 2 3

O^\dagger X X ZX

\square s \square s \square s

O

O^\dagger X X ZX

\square s \square s \square s

O

O^\dagger X X X X ZX

\square s \square s \square s \square s \square s

O X X X X XZ

=

O^\dagger X X X X ZX

\square s \square s \square s \square s \square s

O

O^\dagger X X X X XZ

\square s \square s \square s \square s \square s

O X X X X XZ

=

O^\dagger X X X X ZX

\square s \square s \square s \square s \square s

O

(-1) ·

O^\dagger X X X X ZX

\square s \square s \square s \square s \square s

O

while the r.h.s. can be simplified as

0 1 2 3

O^\dagger X X ZX

\square s \square s \square s

O

=

O^\dagger X X ZX

\square s \square s \square s

O

i ·

O^\dagger X X X X ZX

\square s \square s \square s \square s \square s

O

Comparing the two, we can see that the self-statistics phase $e^{i\theta_s}$ equals i , *i.e.* $\theta_s = \pi/2$. Thus, the s particles have semionic self-statistics.

3. Mutual and self statistics of m, \tilde{m}, s particles in $\mathbb{Z}_2 \times \mathbb{Z}_2$ with mixed anomaly

First we calculate the mutual statistics of m and \tilde{m} , as discussed in eqn. (54). Representing it pictorially, we find

0 1 2 3

\tilde{O}

X X X X \tilde{O}^\dagger

\square s \square s \square s \square s

=

\tilde{X} \tilde{X} \tilde{X} \tilde{X}

\square s \square s \square s \square s

=

\tilde{O}

X X X X $-i\tilde{Z}$

\square s \square s \square s \square s

=

\tilde{X} \tilde{X} \tilde{X} \tilde{X}

\square s \square s \square s \square s

=

\tilde{O}

X X X X $-\tilde{Z}$

\square s \square s \square s \square s

=

\tilde{X} \tilde{X} \tilde{X} \tilde{X}

\square s \square s \square s \square s

i

This proves eqn. (54). Now, recall that s is a bound state of m and \tilde{m} . In other words,

$$W_{\text{patch}_{ij}}^s \stackrel{\text{def}}{=} W_{\text{patch}_{ij}} \cdot \tilde{W}_{\text{patch}_{ij}} \quad (\text{B2})$$

Then the self-statistics calculation shown in Fig 6 corresponds to the computation of the phase in the following sequence of operations:

0 1 2 3

$m\tilde{m}$

\square $m\tilde{m}$ \square $m\tilde{m}$ \square $m\tilde{m}$ \square $m\tilde{m}$

=

$m\tilde{m}$

\square $m\tilde{m}$ \square $m\tilde{m}$ \square $m\tilde{m}$ \square $m\tilde{m}$

=

$m\tilde{m}$

\square $m\tilde{m}$ \square $m\tilde{m}$ \square $m\tilde{m}$ \square $m\tilde{m}$

=

$m\tilde{m}$

\square $m\tilde{m}$ \square $m\tilde{m}$ \square $m\tilde{m}$ \square $m\tilde{m}$

i

From the above picture, it is clear that the computation of self-statistics of s particles is equivalent to the computation of mutual statistics of m and \bar{m} particles.

Appendix C: Global action of 1+1D $\mathbb{Z}_2 \times \mathbb{Z}_2$ symmetry with mixed anomaly

Symmetry protected topological (SPT) states in d space dimensions are associated with anomalous symmetry actions on their $(d-1)$ -dimensional boundary. Such non-onsite action of the symmetry encodes a 't Hooft anomaly of the symmetry, when considered exclusively on the boundary. In Ref. 79 (Section 4), the authors wrote down an exactly soluble path integral model (also known as cocycle model[95]) to realize SPT states in general d space dimensions. These were then used to construct the corresponding anomalous symmetry action for the boundary effective theory. This framework then provides us with a recipe to write down a representative symmetry action for any anomalous symmetry in any number of dimensions. In particular, we can use this recipe to write down the anomalous (non-onsite) symmetry action for the 1+1D bosonic theory having a $\mathbb{Z}_2 \times \mathbb{Z}_2$ symmetry with a mixed anomaly. For this we must consider an SPT state in 2+1D that is protected by $\mathbb{Z}_2 \times \mathbb{Z}_2$ symmetry.¹¹ The path integral is defined on a 3-manifold M^3 with boundary $M^2 = \partial M^3$, and involves a 3-cocycle ν_3 . In Euclidean signature, the integrand of the path integral reads

$$e^{-\int_{M^3} \mathcal{L}_{\text{Bulk}} d^3x} = \prod_{M^3} e^{2\pi i \nu_3(g_i, g_j, g_k, g_l)} \quad (\text{C1})$$

where the ordered collections (i, j, k, l) are the tetrahedra belonging to the triangulation of M^3 . For the effective boundary theory, one can simplify the bulk so that it contains a single point. This reduces to an effectively 1+1D path integral due to properties of the cocycle which we will not go into here – the interested reader is directed to section 4.2 of Ref. 79. This path integral still has the original protecting symmetry of the SPT state, however it is no longer realized in an on-site manner. In Hamiltonian formalism, this symmetry action on the 1+1D boundary is given by

$$U(g) |\{g_i\}\rangle = \prod_{(i,j)} e^{2\pi i \nu_3(g_i, g_j, g^*, -g+g^*)} |\{g+g_i\}\rangle \quad (\text{C2})$$

where (i, j) are nearest neighbors on the 1d spatial boundary, $-g$ denotes the inverse of the group element $g \in \mathbb{Z}_2 \times \mathbb{Z}_2$, and g^* is an arbitrary reference group element, which can be taken to be the identity element of the symmetry group without any loss of generality. One

¹¹ We use the additive presentation of the \mathbb{Z}_2 group in this appendix.

choice of ν_3 that encodes the mixed anomaly of two \mathbb{Z}_2 symmetries is

$$\nu_3 = a_1 \smile a_2 \smile a_2 \quad (\text{C3})$$

with $a = dg$ taking values on links, and the subscripts on a labeling the two \mathbb{Z}_2 groups. Using equations C2 and C3 allows us to write down the global symmetry generators in equations 48 and 49.

Appendix D: 2d non-Abelian symmetry and its dual

In the section VIII, we see that a 2d \mathbb{Z}_2 0-symmetry is equivalent to its dual, a 2d $\mathbb{Z}_2^{(1)}$ 1-symmetry. The dual symmetry is obtained by exchanging patch charge operators and patch symmetry operators. We note that for a symmetry described by a non-Abelian finite group G , it also has patch charge operators and patch symmetry operators. Naturally, one may ask what is the dual of the G symmetry? Are symmetry and dual symmetry equivalent? In this section, we will discuss briefly the algebra of local symmetric operators for a non-Abelian symmetry, and the dual of a non-Abelian symmetry. Although our discussion is far from complete, it suggests that the dual of the G 0-symmetry (whose charge-objects form a fusion 2-category $2\mathcal{R}\text{ep}_G$) is a symmetry whose charge-objects form a fusion 2-category $2\mathcal{V}\text{ec}_G$. In other words, the symmetries $2\mathcal{R}\text{ep}_G$ and $2\mathcal{V}\text{ec}_G$ are dual to each other.

1. The G 0-symmetry in 2d space

Let us consider a bosonic quantum system, whose degrees of freedoms live on the vertices and are labeled by a non-Abelian group G . In other words, the total Hilbert space is given by $\mathcal{V} = \bigotimes_i \mathcal{V}_i$ ($\mathcal{V}_i = \text{span}\{|g_i\rangle \mid g_i \in G\}$).

The G 0-symmetry is defined by the transformations on the whole 2d space

$$T_h = \prod_i T_i(h), \quad h \in G, \quad (\text{D1})$$

where $T_i(h)$ acts on \mathcal{V}_i :

$$T_i(h)|g_i\rangle = |hg_i\rangle. \quad (\text{D2})$$

The associated t-patch symmetry operator is given by

$$\hat{\chi}_{\text{disk}} = \sum_{h \in \chi} \hat{h}_{\text{disk}}, \quad (\text{D3})$$

where $\hat{h}_{\text{disk}} = \prod_{i \in \text{disk}} T_i(h)$ and χ is a conjugacy class of G . Note that here we need to sum over conjugacy class as required by the transparency condition (*i.e.* $T_{\text{disk}}(\chi)$ must carry vanishing total charge):

$$T_{\text{disk}}(\chi)T_{\text{disk}}(\chi') = T_{\text{disk}'(\chi')}T_{\text{disk}}(\chi), \quad (\text{D4})$$

where the boundaries, ∂disk and $\partial\text{disk}'$, are far away (*i.e.* do not intersect). Local symmetric operators satisfy

$$\hat{\chi}_{\text{disk}} O_i^{\text{symm}} = O_i^{\text{symm}} \hat{\chi}_{\text{disk}}, \quad \forall \chi, \quad (\text{D5})$$

where i is far away from ∂disk .

The patch charge operators, with empty bulk, are given by

$$\hat{R}_{\text{str}_{ij}} = \text{Tr}[R(\hat{g}_i)R(\hat{g}_j^{-1})], \quad \hat{g}_i|g_i\rangle = g_i|g_i\rangle, \quad (\text{D6})$$

where R is an irreducible matrix representation of G . The transparency condition requires us to take the trace:

$$\hat{\chi}_{\text{disk}} \hat{R}_{\text{str}_{ij}} = \hat{R}_{\text{str}_{ij}} \hat{\chi}_{\text{disk}}, \quad (\text{D7})$$

where str_{ij} is far away from ∂disk . But the one end of string operator carries a non-zero charge, which can be seen by trying to calculate the commutation between $\hat{\chi}_{\text{disk}}$ and $\hat{R}_{\text{str}_{ij}}$ with one end of string, i inside the disk and the other end of string, j outside the disk:

$$\begin{aligned} & \hat{\chi}_{\text{disk}} \hat{R}_{\text{str}_{ij}} \quad (\text{D8}) \\ &= \left(\sum_{h \in \chi} \prod_{i \in \text{disk}} T_i(h) \right) \text{Tr}(R(\hat{g}_i)R(\hat{g}_j^{-1})) \\ &= \left(\sum_{h \in \chi} \text{Tr}(R(h)R(\hat{g}_i)R(\hat{g}_j^{-1})) \right) \prod_{i \in \text{disk}} T_i(h) \end{aligned}$$

We see that commutator is complicated. In fact, they do not even form a proper commutator. The non-trivial relation indicates that the ends of string carries non-trivial charge. But for a non-Abelian group G , the charge is not described by a simple phase factor.

We know that the algebra generated by the patch charge operators $\hat{R}_{\text{str}_{ij}}$ and patch symmetry operators $\hat{\chi}_{\text{disk}}$ should correspond to a 3d topological order. For the present case, such a 3d topological order should be the one described by the G -gauge theory. The 1d boundary of the disk operator $\hat{\chi}_{\text{disk}}$ corresponds to the flux loop in the G -gauge theory. When G is non-Abelian, a single flux loop in G -gauge theory is not labeled by a group element in G , but rather by a conjugacy class χ . For n flux loops with gauge flux described by h_1, \dots, h_n , the distinct physical states that labeled the conjugacy class $[h_1, \dots, h_n] = \{hh_1h^{-1}, \dots, hh_nh^{-1} | h \in G\}$. For large n , the number of distinct physical states is of order $|G|^n$. In this case, we may say the gauge flux is labeled by the group elements of G .

Similarly, if we consider a more general patch symmetry operators formed by n disks, it is given by

$$\hat{\chi}_{n\text{-disk}} = \sum_{h_1, \dots, h_n \in [h_1, \dots, h_n]} (\hat{h}_1)_{\text{disk}_1} \cdots (\hat{h}_n)_{\text{disk}_n}. \quad (\text{D9})$$

We see that the number of generalized patch symmetry operators is of order $|G|^n$. We may say n disk-like patch symmetry operators are labeled by the elements in G^n , and each disk-like patch symmetry operators are labeled

by the elements in G . This agrees with the picture from the gauge flux.

The patch charge operator $\hat{R}_{\text{str}_{ij}}$ corresponds to the charge excitations in the 3d G -gauge theory on S^0 , *i.e.* on two points with one carries charge R and the other charge \bar{R} . Here R is a representation of G and \bar{R} is its charge conjugate. The fusion of the charges is given by the fusion of G -representations

$$R_1 \otimes R_2 = \bigoplus_{R_3} N_{R_1, R_2}^{R_3} R_3. \quad (\text{D10})$$

To measure the charge in the G -gauge theory, let us braid a charge R around a single flux χ . When G is non-Abelian, both the charge R and the flux χ can be degenerate. The degeneracy of the charge R is $\dim(R)$. The degeneracy of the flux χ is the number of group elements in conjugacy class χ , $|\chi|$. With those degeneracies, the braiding of a charge around a flux loop is not simply a phase factor. This is why the commutation eqn. (D8) is complicated.

The above correspondence suggests that the categorical symmetry of a 2d G 0-symmetry is a 3d topological order described by a G -gauge theory, which will be denoted as $2\mathcal{Gau}_G$. $2\mathcal{Gau}_G$ can also be viewed as a non-degenerate braided fusion 2-category describing the point-like excitations (the G -gauge charge) and string-like excitations (the G -gauge flux) in the 3d G -gauge theory. Thus the categorical symmetry of a 2d G 0-symmetry is a non-degenerate braided fusion 2-category $2\mathcal{Gau}_G$.

We would like to mention that the patch charge operators \hat{R}_{str} should generate a symmetric fusion 2-category $2\mathcal{Rep}_G$. The patch symmetry operators $\hat{\chi}_{\text{disk}}$ should generate a braided fusion 2-category $2\mathcal{Vec}_G$.

We would like to remark that the simple objects in $2\mathcal{Vec}_G$ are labeled by the elements g of the group G . The boundary of a single patch symmetry operator $\hat{\chi}_{\text{disk}}$ correspond to a composite object $\chi = \bigoplus_{g \in \chi} g$, where χ is a conjugacy class of G . On the other hand, the boundary of n patch symmetry operators $\hat{\chi}_{n\text{-disk}}$, in the large n limit, correspond to the simple objects in $2\mathcal{Vec}_G$. Since both 0-symmetry G and the algebraic 1-symmetry $G_{\text{rep}}^{(1)}$ have the same categorical symmetry, they are equivalent symmetries. The class of quantum systems with 0-symmetry G and the class of quantum systems with algebraic 1-symmetry $G_{\text{rep}}^{(1)}$ will have a 1-to-1 correspondence, so that the corresponding quantum systems have identical local low energy properties.

2. The $G_{\text{rep}}^{(1)}$ 1-symmetry in 2d space

The $\mathbb{Z}_2^{(1)}$ 1-symmetry discussed before is described by a higher group. In this section, we are going to study a symmetry that is beyond higher group since the symmetry transformation is not invertible. Such a symmetry is called algebraic higher symmetry in Ref. 45.

Let us consider a bosonic quantum system, whose degrees of freedoms live on the links and are labeled by an non-Abelian group G . In other words, the total Hilbert space is given by $\mathcal{V} = \bigotimes_{\langle ij \rangle} \mathcal{V}_{ij}$ ($\mathcal{V}_{ij} = \text{span}\{|g_{ij}\rangle \mid g_{ij} \in G\}$)

The symmetry is defined by the transformations on all the loops S^1 :

$$W_R(S^1) = \text{Tr} \prod_{\langle ij \rangle \in S^1} R(\hat{g}_{ij}), \quad \hat{g}_{ij}|g_{ij}\rangle = g_{ij}|g_{ij}\rangle, \quad (\text{D11})$$

for all matrix representation R of G . Local symmetric operators satisfy

$$W_R(S^1)O_i^{\text{symm}} = O_i^{\text{symm}}W_R(S^1), \quad \forall S^1, R. \quad (\text{D12})$$

We will call such a symmetry as $G_{\text{rep}}^{(1)}$ 1-symmetry.

The algebra of local symmetric operators is generated by the following two kinds of operators:

$$\begin{aligned} \hat{R}_{\text{str}_{ij}} &= \text{Tr}(R(\hat{g}_{ik})R(\hat{g}_{kl}) \cdots R(\hat{g}_{mj})), \\ \hat{\chi}_{\text{disk}} &= \sum_{h \in \chi} \hat{h}_{\text{disk}}, \end{aligned} \quad (\text{D13})$$

where χ is a conjugacy class of G , $\hat{h}_{\text{disk}} = \prod_{i \in \text{disk}} T_i(h)$, and the $T_i(h)$ operator (for $h \in G$) is defined as

$$T_i(h)|\cdots, g_{ki}, g_{ij} \cdots\rangle = |\cdots, g_{ki}h^{-1}, hg_{ij} \cdots\rangle. \quad (\text{D14})$$

One can check that the above patch operators are t-patch operators, satisfying the transparency condition eqn. (5). The trace in the definition of $\hat{R}_{\text{str}_{ij}}$ and the sum over conjugacy class in the definition of $\hat{\chi}_{\text{disk}}$ are important to ensure the transparency property.

The symmetry transformations $W_R(S^1) = \text{Tr} \prod_{\langle ij \rangle \in S^1} R(g_{ij})$ are not invertible. They form a more general algebra

$$W_{R_1}(S^1)W_{R_2}(S^1) = \sum_{R_3} N_{R_1, R_2}^{R_3} W_{R_3}(S^1), \quad (\text{D15})$$

where $N_{R_1, R_2}^{R_3}$ is the fusion coefficients of the irreducible representations, R_1, R_2, R_3 , of G (see eqn. (D10)). Thus the symmetry generated by $W_R(S^1)$'s is a new kind of symmetry.

We would like to remark that non-invertible symmetry also exist in 1-dimensional space, which can be constructed in a very similar way. In 1d, the non-invertible symmetry is still described by the transformation $W_R(S^1) = \text{Tr} \prod_{\langle ij \rangle \in S^1} R(g_{ij})$, which correspond to an non-invertible 0-symmetry denoted as G_{rep} . Those 1d beyond-group symmetries have been studied under the name (1) topological defect-lines/twisted-boundary-conditions in 1+1D (spacetime dimension) CFT [64, 96–98]; (2) fusion category symmetry,[51, 99]; (3) quantum group symmetry,[100]; *etc.*

Now let us go back to 2-dimensional space. We can use the t-patch operators \hat{R}_{str} on open strings to define the

1-symmetry, *i.e.* to select the local symmetric operators:

$$\hat{R}_{\text{str}}O_i^{\text{symm}} = O_i^{\text{symm}}\hat{R}_{\text{str}}, \quad i \text{ far away from string ends} \quad (\text{D16})$$

The patch charge operator $\hat{\chi}_{\text{disk}}$ carry vanishing 1-charge since

$$\hat{R}_{\text{str}}\hat{\chi}_{\text{disk}} = \hat{\chi}_{\text{disk}}\hat{R}_{\text{str}} \quad (\text{D17})$$

if the disk of $\hat{\chi}_{\text{disk}}$ is far away from the string ends of \hat{R}_{str} . However, a segment of the boundary of the disk operator $\hat{\chi}_{\text{disk}}$ can carry a non zero 1-charge. To measure such a 1-charge, we try to compute the commutator

$$\begin{aligned} &\hat{\chi}_{\text{disk}}\hat{R}_{\text{str}_{ij}} \\ &= \left(\sum_{h \in \chi} \prod_{i \in \text{disk}} T_i(h) \right) \text{Tr}(R(g_{ik})R(g_{kl}) \cdots R(g_{mj})) \\ &= \left(\sum_{h \in \chi} \text{Tr}(R(h)R(g_{ik})R(g_{kl}) \cdots R(g_{mj})) \prod_{i \in \text{disk}} T_i(h) \right) \end{aligned} \quad (\text{D18})$$

assuming one end of string, i , is inside the disk and the other end of string, j , is outside the disk. We see that commutator is complicated. The non-trivial relation at least indicates that the boundary of the disk carries non-trivial 1-charge. But for a non-Abelian group G , the 1-charge is not described by a simple phase factor. This, in fact, is an expected result.

The above discussion suggests the algebra of local symmetric operator for 2d algebraic 1-symmetry $G_{\text{rep}}^{(1)}$ is isomorphic to the algebra of local symmetric operator from 2d 0-symmetry G . To see this more clearly, we remove the trace and the sum over conjugacy class in equations (D8) and (D18), and rewrite them as

$$\begin{aligned} &\hat{h}_{\text{disk}}\hat{R}_{\text{str}_{ij}}^{\alpha\beta} \\ &= \left(\prod_{i \in \text{disk}} T_i(h) \right) (R(g_i)R(g_j^{-1}))^{\alpha\beta} \\ &= \left(\sum_{\gamma} R(h)^{\alpha\gamma} (R(g_i)R(g_j^{-1}))^{\gamma\beta} \prod_{i \in \text{disk}} T_i(h) \right) \\ &= \sum_{\gamma} R(h)^{\alpha\gamma} \hat{R}_{\text{str}_{ij}}^{\gamma\beta} \hat{h}_{\text{disk}} \end{aligned} \quad (\text{D19})$$

and

$$\begin{aligned} &\hat{h}_{\text{disk}}\hat{R}_{\text{str}_{ij}}^{\alpha\beta} \\ &= \left(\prod_{i \in \text{disk}} T_i(h) \right) (R(g_{ik})R(g_{kl}) \cdots R(g_{mj}))^{\alpha\beta} \\ &= \left(\sum_{\gamma} R(h)^{\alpha\gamma} (R(g_{ik})R(g_{kl}) \cdots R(g_{mj}))^{\gamma\beta} \prod_{i \in \text{disk}} T_i(h) \right) \\ &= \sum_{\gamma} R(h)^{\alpha\gamma} \hat{R}_{\text{str}_{ij}}^{\gamma\beta} \hat{h}_{\text{disk}} \end{aligned} \quad (\text{D20})$$

The above two equations have the same form, suggesting that the two operator algebras are isomorphic. In this

case, the 2d algebraic 1-symmetry $G_{\text{rep}}^{(1)}$ also has the categorical symmetry 2Gau_G , the 3d G -gauge theory. The only difference is that, for 2d algebraic 1-symmetry $G_{\text{rep}}^{(1)}$, the patch symmetry operators generate a symmetric fu-

sion 2-category 2Rep_G , while the patch charge operators generate a braided fusion 2-category 2Vec_G . So compare to 2d 0-symmetry G , the patch symmetry operators and the patch charge operators are switched.

-
- [1] Z. Nussinov and G. Ortiz, Sufficient symmetry conditions for topological quantum order, *Proceedings of the National Academy of Sciences* **106**, 16944 (2009), [arXiv:cond-mat/0605316](#).
- [2] Z. Nussinov and G. Ortiz, A symmetry principle for topological quantum order, *Ann. Phys.* **324**, 977 (2009), [arXiv:cond-mat/0702377](#).
- [3] A. Kapustin and R. Thorngren, Higher symmetry and gapped phases of gauge theories, in *Algebra, Geometry, and Physics in the 21st Century. Progress in Mathematics. Progress in Mathematics*, Vol. 324, edited by D. Auroux, L. Katzarkov, T. Pantev, Y. Soibelman, and Y. Tschinkel (Birkhäuser, Cham., 2017) pp. 177–202, [arXiv:1309.4721](#).
- [4] D. Gaiotto, A. Kapustin, N. Seiberg, and B. Willett, Generalized global symmetries, *J. High Energ. Phys.* **2015** (2), 172, [arXiv:1412.5148](#).
- [5] L. Alvarez-Gaumé and E. Witten, Gravitational anomalies, *Nuclear Physics B* **234**, 269 (1984).
- [6] E. Witten, Global gravitational anomalies, *Commun. Math. Phys.* **100**, 197 (1985).
- [7] G. 't Hooft, Naturalness, chiral symmetry, and spontaneous chiral symmetry breaking, in *Recent Developments in Gauge Theories. NATO Advanced Study Institutes Series (Series B. Physics)*, Vol. 59, edited by G. 't Hooft et al. (Springer, Boston, MA., 1980) pp. 135–157.
- [8] M. B. Hastings and X.-G. Wen, Quasiadiabatic continuation of quantum states: The stability of topological ground-state degeneracy and emergent gauge invariance, *Phys. Rev. B* **72**, 045141 (2005), [arXiv:cond-mat/0503554](#).
- [9] J. C. Baez and U. Schreiber, Higher Gauge Theory, *Contemp. Math.* 431, AMS, Providence, Rhode Island, 7 (2007), [math/0511710](#).
- [10] F. Girelli, H. Pfeiffer, and E. M. Popescu, Topological higher gauge theory: From BF to BFCG theory, *J. Math. Phys.* **49**, 032503 (2008), [arXiv:0708.3051](#).
- [11] J. C. Baez and J. Huerta, An invitation to higher gauge theory, *Gen Relativ Gravit* **43**, 2335 (2010), [arXiv:1003.4485](#).
- [12] E. Sharpe, Notes on generalized global symmetries in QFT, *Fortschr. Phys.* **63**, 659 (2015), [arXiv:1508.04770](#).
- [13] R. Thorngren and C. von Keyserlingk, Higher SPT's and a generalization of anomaly in-flow, (2015), [arXiv:1511.02929](#).
- [14] A. Bullivant, M. Calçada, Z. Kádár, P. Martin, and J. a. F. Martins, Topological phases from higher gauge symmetry in 3+1-dimensions, *Phys. Rev. B* **95**, 155118 (2017), [arXiv:1606.06639](#).
- [15] J. Ibieta-Jimenez, M. Petrucci, L. Q. Xavier, and P. Teotonio-Sobrinho, Topological entanglement entropy in d-dimensions for abelian higher gauge theories, *J. High Energ. Phys.* **2020** (3), [arXiv:1711.04186](#).
- [16] Y. Tachikawa, On gauging finite subgroups, *SciPost Phys.* **8**, 10.21468/scipostphys.8.1.015 (2020), [arXiv:1712.09542](#).
- [17] L. Bhardwaj and Y. Tachikawa, On finite symmetries and their gauging in two dimensions, *Journal of High Energy Physics* **2018**, 189 (2018), [arXiv:1704.02330](#).
- [18] A. J. Parzygnat, Two-dimensional algebra in lattice gauge theory, *J. Math. Phys.* **60**, 043506 (2019), [arXiv:1802.01139](#).
- [19] C. Delcamp and A. Tiwari, From gauge to higher gauge models of topological phases, *J. High Energ. Phys.* **2018** (10), 49, [arXiv:1802.10104](#).
- [20] E. Lake, Higher-form symmetries and spontaneous symmetry breaking, (2018), [arXiv:1802.07747](#).
- [21] C. Córdova, T. T. Dumitrescu, and K. Intriligator, Exploring 2-group global symmetries, *J. High Energ. Phys.* **2019** (2), 184, [arXiv:1802.04790](#).
- [22] D. Hofman and N. Iqbal, Goldstone modes and photonization for higher form symmetries, *SciPost Phys.* **6**, 006 (2019), [arXiv:1802.09512](#).
- [23] B. Bouzid and M. Tahiri, 2-connections, a lattice point of view, *Acta Phys. Pol. B* **49**, 1885 (2018), [arXiv:1803.00529](#).
- [24] F. Benini, C. Córdova, and P.-S. Hsin, On 2-group global symmetries and their anomalies, *J. High Energ. Phys.* **2019** (3), 118, [arXiv:1803.09336](#).
- [25] T. Nikolaus and K. Waldorf, Higher geometry for non-geometric t-duals, *Commun. Math. Phys.* **10.1007/s00220-019-03496-3** (2019), [arXiv:1804.00677](#).
- [26] C. Zhu, T. Lan, and X.-G. Wen, Topological nonlinear σ -model, higher gauge theory, and a systematic construction of 3+1D topological orders for boson systems, *Phys. Rev. B* **100**, 045105 (2019), [arXiv:1808.09394](#).
- [27] D. Harlow and H. Ooguri, Symmetries in quantum field theory and quantum gravity, *Communications in Mathematical Physics* **383**, 1669 (2021).
- [28] Z. Wan, J. Wang, and Y. Zheng, New higher anomalies, su(n) yang-mills gauge theory and cpn-1 sigma model, *Annals of Physics* **414**, 168074 (2020).
- [29] Z. Wan and J. Wang, Non-Abelian Gauge Theories, Sigma Models, Higher Anomalies, Symmetries, and Cobordisms, *Annals of Mathematical Sciences and Applications* **4**, 107 (2019), [arXiv:1812.11967](#).
- [30] M. Guo, K. Ohmori, P. Putrov, Z. Wan, and J. Wang, Fermionic Finite-Group Gauge Theories and Interacting Symmetric/Crystalline Orders via Cobordisms, *Communications in Mathematical Physics* **376**, 1073 (2020), [arXiv:1812.11959](#).
- [31] Z. Wan and J. Wang, Adjoint QCD4, deconfined critical phenomena, symmetry-enriched topological quantum field theory, and higher symmetry extension, *Phys. Rev. D* **99**, 065013 (2019), [arXiv:1812.11955](#).
- [32] X.-G. Wen, Emergent (anomalous) higher symmetries from topological order and from dynamical electromagnetic field in condensed matter systems, *Phys. Rev. B* **99**, 205139 (2019), [arXiv:1812.02517](#).

- [33] C. Callan and J. Harvey, Anomalies and fermion zero modes on strings and domain walls, *Nucl. Phys. B* **250**, 427 (1985).
- [34] E. Witten, Quantum field theory and the Jones polynomial, *Commun. Math. Phys.* **121**, 351 (1989).
- [35] X.-G. Wen, Gapless boundary excitations in the quantum hall states and in the chiral spin states, *Phys. Rev. B* **43**, 11025 (1991).
- [36] A. Kapustin and R. Thorngren, Anomalous discrete symmetries in three dimensions and group cohomology, *Phys. Rev. Lett.* **112**, 231602 (2014), [arXiv:1404.3230](#).
- [37] E. Witten and K. Yonekura, Anomaly inflow and the η -invariant, in *Memorial Volume for Shoucheng Zhang* (World Scientific, 2022) pp. 283–352.
- [38] W. Ji and X.-G. Wen, Non-invertible anomalies and mapping-class-group transformation of anomalous partition functions, *Phys. Rev. Research* **1**, 033054 (2019), [arXiv:1905.13279](#).
- [39] X.-G. Wen, Classifying gauge anomalies through symmetry-protected trivial orders and classifying gravitational anomalies through topological orders, *Phys. Rev. D* **88**, 045013 (2013), [arXiv:1303.1803](#).
- [40] L. Kong and X.-G. Wen, Braided fusion categories, gravitational anomalies, and the mathematical framework for topological orders in any dimensions, (2014), [arXiv:1405.5858](#).
- [41] L. Kong, X.-G. Wen, and H. Zheng, Boundary-bulk relation for topological orders as the functor mapping higher categories to their centers, (2015), [arXiv:1502.01690](#).
- [42] D. Fiorenza and A. Valentino, Boundary conditions for topological quantum field theories, anomalies and projective modular functors, *Commun. Math. Phys.* **338**, 1043 (2015), [arXiv:1409.5723](#).
- [43] S. Monnier, Hamiltonian anomalies from extended field theories, *Commun. Math. Phys.* **338**, 1327 (2015), [arXiv:1410.7442](#).
- [44] L. Kong, T. Lan, X.-G. Wen, Z.-H. Zhang, and H. Zheng, Classification of topological phases with finite internal symmetries in all dimensions, *J. High Energy Phys.* **2020** (9), 93, [arXiv:2003.08898](#).
- [45] L. Kong, T. Lan, X.-G. Wen, Z.-H. Zhang, and H. Zheng, Algebraic higher symmetry and categorical symmetry: A holographic and entanglement view of symmetry, *Physical Review Research* **2**, 043086 (2020), [arXiv:2005.14178](#).
- [46] X.-G. Wen, Vacuum degeneracy of chiral spin states in compactified space, *Phys. Rev. B* **40**, 7387 (1989).
- [47] X.-G. Wen, Topological orders in rigid states, *Int. J. Mod. Phys. B* **04**, 239 (1990).
- [48] D. S. Freed, Anomalies and invertible field theories, in *Proc. Symp. Pure Math*, Vol. 88 (2014) pp. 25–46.
- [49] L. Kong, X.-G. Wen, and H. Zheng, Boundary-bulk relation in topological orders, *Nucl. Phys. B* **922**, 62 (2017), [arXiv:1702.00673](#).
- [50] D. S. Freed and C. Teleman, Topological dualities in the ising model, *Geometry & Topology* **26**, 1907 (2022).
- [51] R. Thorngren and Y. Wang, Fusion Category Symmetry I: Anomaly In-Flow and Gapped Phases, (2019), [arXiv:1912.02817](#).
- [52] W. Ji and X.-G. Wen, Metallic states beyond the tomonaga-luttinger liquid in one dimension, *Phys. Rev. B* **102**, 10.1103/physrevb.102.195107 (2020), [arXiv:1912.09391](#).
- [53] W. Ji and X.-G. Wen, Categorical symmetry and noninvertible anomaly in symmetry-breaking and topological phase transitions, *Phys. Rev. Research* **2**, 033417 (2020), [arXiv:1912.13492](#).
- [54] S. Moudgalya and O. I. Motrunich, Hilbert space fragmentation and commutant algebras, *Physical Review X* **12**, 011050 (2022).
- [55] S. Moudgalya and O. I. Motrunich, From symmetries to commutant algebras in standard hamiltonians, *arXiv preprint arXiv:2209.03370* (2022).
- [56] L. Kong, X.-G. Wen, and H. Zheng, One dimensional gapped quantum phases and enriched fusion categories, *Journal of High Energy Physics* **2022**, 1 (2022).
- [57] R. Haag and D. Kastler, An algebraic approach to quantum field theory, *J. Math. Phys.* **5**, 848–861 (1964).
- [58] L. Kong and H. Zheng, Categories of quantum liquids III, (2022), [arXiv:2201.05726](#).
- [59] O. Buerschaper, M. Christandl, L. Kong, and M. Aguado, Electric-magnetic duality of lattice systems with topological order, *Nuclear Physics B* **876**, 619 (2013), [arXiv:1006.5823](#).
- [60] L. Lootens, C. Delcamp, G. Ortiz, and F. Verstraete, Category-theoretic recipe for dualities in one-dimensional quantum lattice models, (2021), [arXiv:2112.09091](#).
- [61] J. Fröhlich, J. Fuchs, I. Runkel, and C. Schweigert, Duality and defects in rational conformal field theory, *Nucl. Phys. B* **763**, 354 (2007), [arXiv:hep-th/0607247](#).
- [62] A. Davydov, L. Kong, and I. Runkel, Invertible defects and isomorphisms of rational cfts, *Adv. Theor. Math. Phys.* **15**, 43 (2011), [arXiv:1004.4725](#).
- [63] A. Davydov, L. Kong, and I. Runkel, Field theories with defects and the centre functor, *Nuclear Physics B* (2011), [arXiv:1107.0495](#).
- [64] C.-M. Chang, Y.-H. Lin, S.-H. Shao, Y. Wang, and X. Yin, Topological defect lines and renormalization group flows in two dimensions, *J. High Energy Phys.* **2019** (1), 26, [arXiv:1802.04445](#).
- [65] M. A. Metlitski and R. Thorngren, Intrinsic and emergent anomalies at deconfined critical points, *Phys. Rev. B* **98**, 085140 (2018), [arXiv:1707.07686](#).
- [66] L. Kong and H. Zheng, Gapless edges of 2d topological orders and enriched monoidal categories, *Nucl. Phys. B* **927**, 140 (2018), [arXiv:1705.01087](#).
- [67] L. Kong and H. Zheng, A mathematical theory of gapless edges of 2d topological orders I, *J. High Energy Phys.* **2020**, 150, [arXiv:1905.04924](#).
- [68] L. Kong and H. Zheng, A mathematical theory of gapless edges of 2d topological orders. Part II, *Nuclear Physics B* **966**, 115384 (2021), [arXiv:1912.01760](#).
- [69] X. Chen, Z.-C. Gu, and X.-G. Wen, Local unitary transformation, long-range quantum entanglement, wave function renormalization, and topological order, *Phys. Rev. B* **82**, 155138 (2010), [arXiv:1004.3835](#).
- [70] B. Zeng and X.-G. Wen, Gapped quantum liquids and topological order, stochastic local transformations and emergence of unitarity, *Phys. Rev. B* **91**, 125121 (2015), [arXiv:1406.5090](#).
- [71] F. Apruzzi, F. Bonetti, I. García Etxebarria, S. S. Hosseini, and S. Schafer-Nameki, Symmetry TFTs from String Theory, *arXiv e-prints*, [arXiv:2112.02092](#) (2021), [arXiv:2112.02092](#).
- [72] D. S. Freed, G. W. Moore, and C. Teleman, Topological symmetry in quantum field theory, (2022), [arXiv:2209.07471](#).

- [73] K. Kawagoe and M. Levin, Microscopic definitions of anyon data, [arXiv:1910.11353v1](#).
- [74] M. Levin and X.-G. Wen, Fermions, strings, and gauge fields in lattice spin models, *Phys. Rev. B* **67**, 245316 (2003), [arXiv:cond-mat/0302460](#).
- [75] T. Lan, L. Kong, and X.-G. Wen, Modular extensions of unitary braided fusion categories and 2+1D Topological/SPT orders with symmetries, *Commun. Math. Phys.* **351**, 709 (2016), [arXiv:1602.05936](#).
- [76] V. V. Albert, D. Aasen, W. Xu, W. Ji, J. Alicea, and J. Preskill, Spin chains, defects, and quantum wires for the quantum-double edge, arXiv preprint [arXiv:2111.12096](#) (2021).
- [77] X. Chen, Z.-X. Liu, and X.-G. Wen, Two-dimensional symmetry-protected topological orders and their protected gapless edge excitations, *Phys. Rev. B* **84**, 235141 (2011), [arXiv:1106.4752](#).
- [78] X. Chen, Z.-C. Gu, Z.-X. Liu, and X.-G. Wen, Symmetry protected topological orders and the group cohomology of their symmetry group, *Phys. Rev. B* **87**, 155114 (2013), [arXiv:1106.4772](#).
- [79] J. Wang, X.-G. Wen, and E. Witten, Symmetric gapped interfaces of SPT and SET states: systematic constructions, *Phys. Rev. X* **8**, 031048 (2018), [arXiv:1705.06728](#).
- [80] X.-G. Wen and A. Zee, Classification of Abelian quantum Hall states and matrix formulation of topological fluids, *Phys. Rev. B* **46**, 2290 (1992).
- [81] J. Fröhlich and U. M. Studer, Gauge invariance and current algebra in nonrelativistic many-body theory, *Rev. Mod. Phys.* **65**, 733 (1993).
- [82] M. Levin and Z.-C. Gu, Braiding statistics approach to symmetry-protected topological phases, *Phys. Rev. B* **86**, 115109 (2012), [arXiv:1202.3120](#).
- [83] X.-G. Wen, Symmetry-protected topological invariants of symmetry-protected topological phases of interacting bosons and fermions, *Phys. Rev. B* **89**, 035147 (2014), [arXiv:1301.7675](#).
- [84] T. D. Ellison, Y.-A. Chen, A. Dua, W. Shirley, N. Tantivasadakarn, and D. J. Williamson, Pauli Stabilizer Models of Twisted Quantum Doubles, *Phys. Rev. X Quantum* **3**, 010353 (2022), [arXiv:2112.11394](#).
- [85] T. Lan, C. Zhu, and X.-G. Wen, Fermion decoration construction of symmetry protected trivial orders for fermion systems with any symmetries g_f and in any dimensions, *Phys. Rev. B* **100**, 235141 (2019), [arXiv:1809.01112](#).
- [86] M. Levin, Constraints on order and disorder parameters in quantum spin chains, *Commun. Math. Phys.* **378**, 1081 (2020), [arXiv:1903.09028](#).
- [87] T. Lan, L. Kong, and X.-G. Wen, Classification of (3+1)D bosonic topological orders: the case when point-like excitations are all bosons, *Phys. Rev. X* **8**, 021074 (2018), [arXiv:1704.04221](#).
- [88] D. Gaiotto and T. Johnson-Freyd, Condensations in higher categories, (2019), [arXiv:1905.09566](#).
- [89] C. Delcamp, Tensor network approach to electromagnetic duality in (3+1) d topological gauge models, *Journal of High Energy Physics* **2022**, 1 (2022).
- [90] A. Joyal and R. Street, Tortile yang-baxter operators in tensor categories, *Journal of Pure and Applied Algebra* **71**, 43 (1991).
- [91] M. Müger, From subfactors to categories and topology ii: The quantum double of tensor categories and subfactors, *Journal of Pure and Applied Algebra* **180**, 159 (2003).
- [92] C. Goff, G. Mason, and S.-H. Ng, On the gauge equivalence of twisted quantum doubles of elementary abelian and extra-special 2-groups, *Journal of Algebra* **312**, 849 (2007), [arXiv:math/0603191](#).
- [93] J. C. Wang and X.-G. Wen, Non-Abelian string and particle braiding in topological order: Modular $SL(3, \mathbb{Z})$ representation and (3+1)-dimensional twisted gauge theory, *Phys. Rev. B* **91**, 035134 (2015), [arXiv:1404.7854](#).
- [94] X.-G. Wen, A theory of 2+1D bosonic topological orders, *Nat. Sci. Rev.* **3**, 68 (2015), [arXiv:1506.05768](#).
- [95] X.-G. Wen, Exactly soluble local bosonic cocycle models, statistical transmutation, and simplest time-reversal symmetric topological orders in 3+1 dimensions, *Phys. Rev. B* **95**, 205142 (2017), [arXiv:1612.01418](#).
- [96] V. B. Petkova and J. B. Zuber, Generalised twisted partition functions, *Physics Letters B* **504**, 157 (2001), [arXiv:hep-th/0011021](#).
- [97] R. Coquereaux and G. Schieber, Twisted partition functions for ADE boundary conformal field theories and Ocneanu algebras of quantum symmetries, *Journal of Geometry and Physics* **42**, 216 (2002), [arXiv:hep-th/0107001](#).
- [98] J. Fuchs, I. Runkel, and C. Schweigert, TFT construction of RCFT correlators I: partition functions, *Nuclear Physics B* **646**, 353 (2002), [arXiv:hep-th/0204148](#).
- [99] K. Inamura, Topological field theories and symmetry protected topological phases with fusion category symmetries, *Journal of High Energy Physics* **2021**, 204 (2021), [arXiv:2103.15588](#).
- [100] T. Quella, Symmetry-protected topological phases beyond groups: The q-deformed Affleck-Kennedy-Lieb-Tasaki model, *Phys. Rev. B* **102**, 081120 (2020), [arXiv:2005.09072](#).