

Nonergodic Brownian oscillator

Alex V. Plyukhin*

Department of Mathematics, Saint Anselm College, Manchester, New Hampshire 03102, USA

(Dated: January 20, 2022)

We consider an open (Brownian) classical harmonic oscillator in contact with a non-Markovian thermal bath and described by the generalized Langevin equation. When the bath's spectrum has a finite upper cutoff frequency, the oscillator may have ergodic and nonergodic configurations. In ergodic configurations (when exist, they correspond to lower oscillator frequencies) the oscillator demonstrates conventional relaxation to thermal equilibrium with the bath. In nonergodic configurations (which correspond to higher oscillator frequencies) the oscillator in general does not thermalize, but relaxes to periodically correlated (cyclostationary) states whose statistics vary periodically in time. For a specific dissipation kernel in the Langevin equation, we evaluate explicitly relevant relaxation functions, which describe the evolution of mean values and time correlations. When the oscillator frequency is switched from a lower value to higher one, the oscillator may show parametric ergodic to nonergodic transitions with equilibrium initial and cyclostationary final states. These transitions are shown to resemble phase transitions of the second kind.

I. INTRODUCTION: TWO MECHANISMS OF NON-THERMALIZATION

Since thermodynamics is a very general theory, the cases when it does not apply in the ordinary way are intriguing. A thermodynamic description assumes that a system, large or small, in contact with a macroscopic thermal bath at temperature T will thermalize over the course of time, reaching a state of thermodynamic equilibrium characterized by the same temperature T . While this scenario is the most common, there are certain types of open systems for which thermalization does not occur. For a classical particle in contact with the thermal bath we are aware of two mechanisms of relaxation which does not end up with thermal equilibrium. The first mechanism is due to the zero integral friction [1–5], the second is related to the formation of a localized vibrational mode [6–18]. While this paper concerns exclusively the latter, let us start with a brief outline of the former.

Consider a free Brownian particle of mass m described by the generalized Langevin equation [19]

$$\dot{v}(t) = - \int_0^t K(t-\tau) v(\tau) d\tau + \frac{1}{m} \xi(t), \quad (1)$$

where v is the particle's velocity, $K(t)$ is the dissipation kernel, and $\xi(t)$ is the zero-centered stationary random force, connected to $K(t)$ by the conventional fluctuation-dissipation relation. Assuming the random force does not correlate with $v(0)$, one finds from Eq. (1) that the normalized correlation function $R(t) = \langle v(t)v(0) \rangle / \langle v^2(0) \rangle$ satisfies the homogeneous (and deterministic) equation

$$\dot{R}(t) = - \int_0^t K(t-\tau) R(\tau) d\tau \quad (2)$$

with the initial condition $R(0) = 1$. In the Laplace domain the solution is

$$\tilde{R}(s) = \int_0^\infty e^{-st} R(t) dt = \frac{1}{s + \tilde{K}(s)}. \quad (3)$$

Thermalization implies that the system eventually forgets initial conditions, so that $R(t)$ vanishes at long times. On the contrary, the condition of non-thermalization implies that $R(t)$ does not vanish at long times, which leads to the asymptotic condition on the dissipation kernel in the Laplace domain

$$\lim_{t \rightarrow \infty} R(t) = \lim_{s \rightarrow 0} s \tilde{R}(s) = \lim_{s \rightarrow 0} \frac{s}{s + \tilde{K}(s)} \neq 0, \quad (4)$$

*Electronic address: aplyukhin@anselm.edu

provided the limit exists. This condition is satisfied when the Laplace transform of the kernel has the asymptotic form

$$\tilde{K}(s) \sim s^\delta, \quad \delta \geq 1, \quad s \rightarrow 0. \quad (5)$$

In that case the integral of the kernel vanishes

$$\gamma = \int_0^\infty K(t) dt = \tilde{K}(s=0) = 0. \quad (6)$$

This may be called the condition of zero integral friction, because $\gamma = \int_0^\infty K(t)dt$ is just the friction (dissipation) coefficient in the expression for the damping force $-\gamma p$ in the Markovian limit of the Langevin equation (1), $\dot{v} = -\gamma v + m^{-1}\xi$.

The lack of thermalization in the case $\gamma = 0$ is remarkable but appears to be a rather exotic phenomenon. One can show that under condition (5) Brownian motion shows not only the lack of thermalization but also another anomalous phenomenon, namely super-diffusion (which actually takes place for a broader condition $\delta > 0$) [1–5].

At first glance it may appear that the condition of non-thermalization (5) is both sufficient and necessary. Actually it is not necessary because the above discussion assumes, when the relation $\lim_{t \rightarrow \infty} R(t) = \lim_{s \rightarrow 0} s\tilde{R}(s)$ is exploited, that the correlation function $R(t)$ possesses a well-defined long time limit. That is not necessarily the case in general: It is easy to construct a dissipation kernel $K(t)$ with reasonable properties (such as $K(t) \rightarrow 0$ at long times) for which Eq. (2) for $R(t)$ has an oscillating solution and $\lim_{t \rightarrow \infty} R(t)$ does not exist [20]. Can such mathematical possibility be realized in any physical system?

One such system is well-known: it is the harmonic lattice with a light impurity atom. Such atom can be viewed as a lattice defect which is known to generate a localized vibrational mode whose frequency (we shall denote it ω_*) lies outside the spectrum of the unperturbed lattice [6–9]. The localized mode involves the impurity atom and a few neighboring atoms of the lattice, the participation of other atoms is small and decreases exponentially with the distance from the impurity. The formation of the localized mode can be attributed to destructive wave interference and is analogous to localization of the electron wave function near the impurity in the otherwise ideal crystal, see [10] for a pedagogical discussion. For a review of localized modes in anharmonic lattices (called breathers) see [11]. The localized mode does not exchange energy with the bath; as a result the light impurity atom (the system) does not reach thermal equilibrium with the lattice (the bath).

In earlier studies, localized vibrational modes and their unusual relaxation properties were studied by direct solving the equations of motion of the lattice. Later the topic was addressed using the generalized Langevin equation (1), which often offers a more compact, though less detailed, consideration [12–18]. Within that method, the condition of non-thermalization due to localized modes does not imply conditions (5) and (6), yet it puts strong restrictions on the properties of the bath and the system-bath coupling. As mentioned above, the frequency of the localized mode lies outside the spectrum of the bath, which necessarily implies that the latter must have a finite upper cutoff frequency ω_0 . That condition is satisfied neither for Markovian models with $K(t) \sim \delta(t)$, nor for models with monotonically (e.g., exponentially) decaying $K(t)$.

Non-thermalization due to localized modes was demonstrated not only for a light isotope in the harmonic lattice, but for a number of other models [12–16]. While the lattice-like structure of the bath is probably the necessary ingredient (which guarantees that the bath spectrum has a finite upper bound ω_0), the system of interest may be of different nature. The earlier studies mostly concerned lattice models with mass and spring defects and their combinations. More recently, non-thermalization of the Brownian oscillator (both linear and nonlinear) in the presence of localized modes was demonstrated by Dhar and Wagh [16].

The Brownian oscillator in contact with a Markovian bath and described by the standard Markovian Langevin or Fokker-Planck equations is an exemplary system, whose relaxation to thermal equilibrium can be analytically described in full details. However, when the bath is not Markovian and has the frequency spectrum with an upper cutoff ω_0 , the oscillator may thermalize or not thermalize depending on the values of the oscillator frequency ω and parameters of the oscillator-bath coupling. In the model studied in Ref. [16], the oscillator thermalizes for $\omega \leq \omega_c$ and does not thermalize for $\omega > \omega_c$, where ω_c is a critical frequency of order of ω_0 . In configurations with $\omega > \omega_c$ the oscillator evolves at long times into a non-equilibrium and non-stationary state in which the mean values and correlation functions of dynamical variables oscillate with time with the localized normal mode frequency ω_* .

Stochastic processes with periodically varying statistics are called periodically correlated, or cyclostationary [22–25]. They are present in a great variety of physical, biological, meteorological, and technological processes, involving an interplay of randomness and periodicity. While both ingredients are obviously present in the Brownian oscillator, the emergence of cyclostationary states instead of stationary (equilibrium) states is rather unexpected from a thermodynamics point of view. Cyclostationary stochastic processes are not stationary and are therefore manifestly nonergodic: their ensemble and time averages cannot be equal since the former are time periodic and the latter are constant.

If the oscillator, due to the formation of a localized mode, does not thermalize, then it evolves in a cyclostationary and hence nonergodic state.

Since the type of relaxation may depend on the oscillator frequency ω , we shall use the following nomenclature. We will say that the oscillator with a given frequency is in an *ergodic* configuration if the oscillator relaxes to thermal equilibrium. If the oscillator with a given frequency does not thermalize (with the exception of equilibrium initial conditions) but evolves in a cyclostationary state, we shall say that the oscillator is in a *nonergodic* configuration. Based on the results of [16] one would expect ergodic (resp. nonergodic) configurations to correspond to lower (resp. higher) oscillator frequencies. We call a Brownian oscillator nonergodic if it has *both* ergodic and nonergodic configurations, or *only* nonergodic ones. The oscillator with only ergodic configurations (which will hardly appear in this text) may be referred as ergodic.

Note that, in general, the condition of thermalization is stronger than that of ergodicity and non-thermalization does not necessarily imply nonergodicity. But for the nonergodic Brownian oscillator, this is indeed the case: If the oscillator at given frequency fails to thermalize, then it will evolve to a non-stationary (cyclostationary) and therefore nonergodic state.

The purpose of this paper is to evaluate explicitly the relaxation and correlation functions describing a nonergodic Brownian oscillator. Compared to the work by Dhar and Wagh [16], where spectral properties of the bath are not specified (except the part addressing a nonlinear oscillator), in this paper we shall focus on a case study of the oscillator described by the generalized Langevin equation with a specific dissipation kernel $K(t)$. We believe such a study, though not generic, would be of interest since it may share many essential features and technicalities with a variety of similar and extended models. With explicit expressions for relaxation and correlation functions at hands, one can explore quantitatively a variety of nonergodic processes. As an application, we consider (in Sec. XIV) the optical trap like setting when the oscillator frequency is instantaneously switched from a lower to higher value, bringing the oscillator from an ergodic to nonergodic configuration. In that transition, the nonergodic oscillator may get and, in contrast to its ergodic counterpart (whose energy eventually relaxes to $k_B T$), store forever an arbitrary amount of energy. That property may be of interest for designing microscopic machines [35, 36].

We have given the paper a mostly linear structure, with only two Appendices. For the reader's convenience, Secs. VIII through X, which are fairly technical, conclude with brief summaries that suffice for comprehending the following sections. The results of Secs. III and IV are generic and do not depend on a specific form of the dissipation kernel $K(t)$; in the rest of the paper the kernel $K(t)$ is adopted in the form (9).

II. MODEL

We consider a classical Brownian particle of mass m and coordinate q , trapped in the harmonic potential $V(q) = -m\omega^2 q^2/2$, and in contact with a single thermal bath with temperature T . The particle's dynamics is governed by the generalized Langevin equation [19]

$$\ddot{q}(t) = -\omega^2 q(t) - \int_0^t K(t-\tau) \dot{q}(\tau) d\tau + \frac{1}{m} \xi(t). \quad (7)$$

The stationary fluctuating force (the noise) $\xi(t)$ is zero-centered and related to the dissipation kernel $K(t)$ via the standard fluctuation-dissipation relation,

$$\langle \xi(t) \rangle = 0, \quad \langle \xi(t) \xi(\tau) \rangle = m k_B T K(|t-\tau|). \quad (8)$$

We shall assume that the kernel has a specific form,

$$K(t) = \frac{\mu \omega_0^2}{4} [J_0(\omega_0 t) + J_2(\omega_0 t)] = \frac{\mu \omega_0}{2} \frac{J_1(\omega_0 t)}{t}, \quad (9)$$

where μ and ω_0 are arbitrary positive parameters, $J_n(x)$ are Bessel functions of the first kind, and the second expression is defined at $t=0$ by continuity. The kernel (9) oscillates and decays at long times rather slowly as $t^{-3/2}$. Otherwise, it has all properties one expects from the dissipation kernel of the generalized Langevin equation: the function $K(t)$ given by (9) is even, has a maximum at $t=0$, and vanishes at long times.

There are two reasons to pay a special attention to the kernel (9). First, it is one of the simplest kernels for which the Langevin equation may have periodically correlated solutions. Indeed, the corresponding spectral density [21]

$$J(\omega) = M \omega \int_0^\infty K(t) \cos(\omega t) dt = \frac{m\omega_0}{2} \omega \sqrt{1 - \left(\frac{\omega}{\omega_0}\right)^2} \theta(\omega_0 - \omega), \quad (10)$$

where $\theta(\omega)$ is the step function, has the upper cutoff bound ω_0 . As was mentioned in Introduction, this is expected to be the necessary condition of the localized mode formation and nonergodic configurations. The model with the dissipation kernel decaying according to the power law, $K(t) = K_0 t^{-\alpha}$, was considered earlier in Refs. [27, 28]. In that case the oscillator is ergodic and thermalizes for any values of the oscillator frequency ω .

The second special feature of the kernel (9) is that it corresponds to a specific and familiar physical model, namely Rubin's model, where the thermal bath is the infinite harmonic chain of atoms of mass m_0 and the system of interest is an isotope atom of mass m [9, 19, 21]. The Langevin equation (7) describes the original Rubin's model modified by the presence of the external harmonic potential applied to the impurity atom. The parameter ω_0 has the meaning of the highest normal mode frequency of the infinite chain, $\omega_0 = 2\sqrt{k/m_0}$, where k is the stiffness of the spring force connecting atoms of the chain (and also the impurity atom). There are two versions of Rubin's model. In the first version the isotope of mass m is attached to the end of the semi-infinite chain of atoms of mass m_0 , see Fig. 3.1 in Ref. [21]. In that case the parameter μ has the meaning of the mass ratio $\mu = m_0/m$. In the second version, the isotope is embedded in the bulk of the infinite chain, i.e. attached to two semi-infinite chains. For that version μ is the doubled mass ratio, $\mu = 2m_0/m$. The connection to Rubin's model facilitates computer simulations, which may be helpful for extended models (e.g., the oscillator is nonlinear, the oscillator frequency is subjected to a time variation, etc.) when an analytical solution of the Langevin equation is not feasible.

For the given model, it will be shown that for $\mu < 2$ the oscillator has both ergodic and nonergodic configurations. Ergodic configurations correspond to lower frequencies

$$\omega \leq \omega_c, \quad \omega_c = \sqrt{1 - \mu/2} \omega_0, \quad (11)$$

while nonergodic configurations correspond to higher frequencies $\omega > \omega_c$. On the other hand, for $\mu \geq 2$ the oscillator is nonergodic and does not thermalize for any frequency ω . Our goal is to evaluate the relaxation and correlation functions (defined in the next two sections) describing the oscillator's dynamics for both ergodic and nonergodic configurations.

III. SOLVING LANGEVIN EQUATION

The solution of the generalized Langevin equation (7) for the harmonic oscillator with an arbitrary kernel $K(t)$ has been addressed in several studies, see [26–29]. To make the paper self-contained we outline in this section the main points.

Solving Eq. (7) with initial conditions $q(0) = q_i$ and $v(0) = v_i$ using the method of Laplace transform one finds for the coordinate and velocity of the particle the following expressions:

$$\begin{aligned} q(t) &= q_i S(t) + v_i G(t) + \frac{1}{m} \{G * \xi\}(t), \\ v(t) &= -q_i \omega^2 G(t) + v_i R(t) + \frac{1}{m} \{R * \xi\}(t). \end{aligned} \quad (12)$$

Here the asterisk denotes the convolutions, e. g.

$$\{G * \xi\}(t) = \int_0^t G(t - \tau) \xi(\tau) d\tau, \quad (13)$$

the relaxation functions $G(t)$ is defined by its Laplace transform

$$\tilde{G}(s) = \int_0^\infty e^{-st} G(t) dt = \frac{1}{s^2 + s\tilde{K}(s) + \omega^2}, \quad (14)$$

and the other two relaxation functions $R(t)$ and $S(t)$ are derived from $G(t)$ as follows:

$$R(t) = \frac{d}{dt} G(t), \quad S(t) = 1 - \omega^2 \int_0^t G(\tau) d\tau. \quad (15)$$

As obvious from Eq. (12), the initial values of the relaxation functions are

$$G(0) = 0, \quad R(0) = S(0) = 1. \quad (16)$$

Note that $G(t)$ has the dimension of time, while $R(t)$ and $S(t)$ are dimensionless.

In the Laplace domain the relaxation functions are connected as

$$\tilde{R}(s) = s \tilde{G}(s), \quad \tilde{S}(s) = \frac{1}{s} [1 - \omega^2 \tilde{G}(s)]. \quad (17)$$

Using Eqs. (14) and (17) one can directly verify the validity of relations

$$s \tilde{G}(s) = \tilde{S}(s) - \tilde{K}(s) \tilde{G}(s), \quad s \tilde{R}(s) - 1 = -\omega^2 \tilde{G}(s) - \tilde{K}(s) \tilde{R}(s). \quad (18)$$

In the time domain they give expressions for derivatives of G and R :

$$\dot{G}(t) = S(t) - \{K * G\}(t), \quad \dot{R}(t) = -\omega^2 G(t) - \{K * R\}(t). \quad (19)$$

The derivative of S , according to Eq. (15), is

$$\dot{S}(t) = -\omega^2 G(t). \quad (20)$$

As follows from Eq. (12), the relaxation to thermal equilibrium implies the asymptotic vanishing of the relaxation functions

$$G(t), R(t), S(t) \rightarrow 0, \quad \text{as } t \rightarrow \infty, \quad (21)$$

which guarantees that the particle forgets the initial conditions at long times. One can show that the second moments of q and v under conditions (21) relax to the equilibrium values. Indeed, by squaring solutions (12), averaging over the initial parameters q_i, v_i , and assuming that

$$\langle q_i \rangle = \langle v_i \rangle = \langle q_i v_i \rangle = 0 \quad (22)$$

one gets the following expressions for the second moments

$$\begin{aligned} \langle q^2(t) \rangle &= \langle q_i^2 \rangle S^2(t) + \langle v_i^2 \rangle G^2(t) + \frac{1}{m^2} \langle \{G * \xi\}^2(t) \rangle, \\ \langle v^2(t) \rangle &= \langle q_i^2 \rangle \omega^4 G^2(t) + \langle v_i^2 \rangle R^2(t) + \frac{1}{m^2} \langle \{R * \xi\}^2(t) \rangle, \\ \langle q(t) v(t) \rangle &= -\langle q_i^2 \rangle \omega^2 G(t) S(t) + \langle v_i^2 \rangle G(t) R(t) + \frac{1}{m^2} \langle \{G * \xi\} \{R * \xi\} \rangle. \end{aligned} \quad (23)$$

Here the average squares of the convolutions can be readily evaluated using the fluctuation-dissipation relation (8) and also relations (19) and (20),

$$\begin{aligned} \langle \{G * \xi\}^2(t) \rangle &= \frac{m k_B T}{\omega^2} [1 - S^2(t)] - m k_B T G^2(t), \\ \langle \{R * \xi\}^2(t) \rangle &= m k_B T [1 - R^2(t) - \omega^2 G^2(t)]. \end{aligned} \quad (24)$$

(A common trick to derive these results is to write the double integral over the square region $(0, t) \times (0, t)$ of the (t_1, t_2) -space as two times the integral over the triangle bounded by the lines $t_2 = t_1$, $t_2 = 0$ and $t_1 = t$.) The average product of the convolutions is easier to find by noticing that

$$\langle \{G * \xi\} \{R * \xi\} \rangle = \frac{1}{2} \frac{d}{dt} \langle \{G * \xi\}^2 \rangle. \quad (25)$$

Then, recalling that $\dot{S}(t) = -\omega^2 G(t)$ and $\dot{G}(t) = R(t)$, one obtains

$$\langle \{G * \xi\} \{R * \xi\} \rangle = m k_B T G(t) [S(t) - R(t)]. \quad (26)$$

Finally, substituting (24) and (26) into (23) yields

$$\begin{aligned} \langle q^2(t) \rangle &= \langle q_i^2 \rangle S^2(t) + \langle v_i^2 \rangle G^2(t) + \frac{k_B T}{m \omega^2} [1 - S^2(t)] - \frac{k_B T}{m} G^2(t), \\ \langle v^2(t) \rangle &= \langle q_i^2 \rangle \omega^4 G^2(t) + \langle v_i^2 \rangle R^2(t) + \frac{k_B T}{m} [1 - R^2(t) - \omega^2 G^2(t)], \\ \langle q(t) v(t) \rangle &= -\langle q_i^2 \rangle \omega^2 G(t) S(t) + \langle v_i^2 \rangle G(t) R(t) + \frac{k_B T}{m} G(t) [S(t) - R(t)]. \end{aligned} \quad (27)$$

One observes that under conditions (21) the second moments relax at long times, for any initial conditions, to the equilibrium values,

$$\langle q^2(t) \rangle \rightarrow \frac{k_B T}{m \omega^2}, \quad \langle v^2(t) \rangle \rightarrow \frac{k_B T}{m}, \quad \langle q(t) v(t) \rangle \rightarrow 0. \quad (28)$$

On the other hand, if conditions (21) are not satisfied, then it follows from the above relations that the oscillator does not thermalize in the general case.

An exception is the case of equilibrium initial conditions. As one observes from Eqs. (27), if the oscillator at $t = 0$ is prepared in the state of equilibrium with $\langle q_i^2 \rangle = k_B T / (m \omega^2)$ and $\langle v_i^2 \rangle = k_B T / m$ (that can be arranged by connecting the oscillator at $t < 0$ to an additional thermal bath with no upper frequency cutoff) then the terms with relaxation functions are canceled and the moments keep the equilibrium values for $t > 0$ regardless of whether asymptotic conditions (21) hold or not.

IV. TIME CORRELATIONS

Let us show that the relaxation functions $G(t), R(t), S(t)$, introduced in the previous section, not only govern the time dependence of the moments $\langle q^2(t) \rangle, \langle v^2(t) \rangle, \langle q(t) v(t) \rangle$, but also determine the time correlation functions $\langle q(t) q(t') \rangle, \langle v(t) v(t') \rangle, \langle q(t) v(t') \rangle$. The general expressions for the latter, valid for arbitrary initial conditions, can be obtained from Eqs. (12) using the method of double Laplace transforms [28, 29]. Here we consider only the case of equilibrium initial conditions, i.e. when the initial coordinate and velocity (q_i, v_i) of the oscillator are drawn from the equilibrium ensemble with the moments

$$\langle q_i \rangle = \langle v_i \rangle = \langle q_i v_i \rangle = 0, \quad \langle q_i^2 \rangle = k_B T / (m \omega^2), \quad \langle v_i^2 \rangle = k_B T / m. \quad (29)$$

First consider the oscillator in an ergodic configuration. With equilibrium initial conditions the oscillator remains in equilibrium also for $t > 0$, and the correlation functions depend on time only through the time difference. Then, for $t, t' > 0$ we get from Eq. (12),

$$\begin{aligned} \langle q(t) q(t') \rangle &= \langle q_i q(|t - t'|) \rangle = \frac{k_B T}{m \omega^2} S(|t - t'|), \\ \langle v(t) v(t') \rangle &= \langle v_i v(|t - t'|) \rangle = \frac{k_B T}{m} R(|t - t'|). \end{aligned} \quad (30)$$

Here the averaging is taken over the noise and also over the equilibrium distribution for initial values q_i, v_i . Similarly, for the cross-correlation we get from Eq. (12):

$$\langle q(t) v(t') \rangle = \begin{cases} \langle q_i v(t' - t) \rangle = -\frac{k_B T}{m} G(t' - t), & \text{if } t' > t, \\ \langle v_i q(t - t') \rangle = \frac{k_B T}{m} G(t - t'), & \text{if } t > t'. \end{cases} \quad (31)$$

Next, from Eqs. (12) and (15) one can observe that the relaxation function $G(t)$ must be odd, and $R(t)$ and $S(t)$ are both even. Then the above results can be written as

$$\langle q(t) q(t') \rangle = \frac{k_B T}{m \omega^2} S(t - t'), \quad \langle v(t) v(t') \rangle = \frac{k_B T}{m} R(t - t'), \quad \langle q(t) v(t') \rangle = \frac{k_B T}{m} G(t - t'). \quad (32)$$

Thus the relaxation functions not only determine the moments of coordinate and velocity, but also coincide with the time correlation functions in thermal equilibrium: $S(t)$ and $R(t)$ are the normalized auto-correlation functions for the coordinate and velocity, respectively, while $G(t)$ determines the cross-correlation.

Now consider the oscillator in a nonergodic configuration, and the initial conditions are still equilibrium ones, satisfying Eq. (29). As was noted at the end of the previous section, in that case the moments $\langle q^2(t) \rangle, \langle v^2(t) \rangle, \langle q(t) v(t) \rangle$ do not change with time and keep their equilibrium values for $t > 0$. This suggests that the oscillator is in equilibrium at $t > 0$, and therefore the correlations can be evaluated as above and are still given by Eq. (32). Alternatively, the correlations can be evaluated directly. For equilibrium initial conditions (29) that method again recovers the results (32).

Let us demonstrate that for the cross-correlation $\langle q(t) v(t') \rangle$. From Eqs. (12) and (29) we get

$$\langle q(t) v(t') \rangle = \frac{k_B T}{m} [G(t) R(t') - S(t) G(t') + X(t, t')], \quad (33)$$

where $X(t, t')$ is the average product of two convolutions

$$X(t, t') = \frac{1}{m k_B T} \langle \{G * \xi\}(t) \{R * \xi\}(t') \rangle. \quad (34)$$

We can express this function in terms of the relaxation functions as follows. Using the fluctuation-dissipation relation (8), one can write $X(t, t')$ as a double convolution

$$X(t, t') = \{f ** g\}(t, t') = \int_0^t d\tau \int_0^{t'} d\tau' f(t - \tau, t' - \tau') g(\tau, \tau') \quad (35)$$

with

$$f(t, t') = G(t)R(t'), \quad g(t, t') = K(t - t'). \quad (36)$$

Applying the double Laplace transform

$$\mathcal{L}_2\{\dots\} = \int_0^\infty dt e^{-st} \int_0^\infty dt' e^{-s't'} \{\dots\}, \quad (37)$$

and the convolution theorem $\mathcal{L}_2\{f ** g\} = \mathcal{L}_2\{f\} \mathcal{L}_2\{g\}$, we get

$$\mathcal{L}_2\{X(t, t')\} = \mathcal{L}_2\{G(t)R(t')\} \mathcal{L}_2\{K(t - t')\} = \tilde{G}(s) \tilde{R}(s') \mathcal{L}_2\{K(t - t')\}, \quad (38)$$

where the tilde still denotes the one variable Laplace transform. Referring to the properties of double Laplace transforms (see, e.g., Ref. [30]) and noticing that the dissipation kernel $K(t)$ is an even function one gets

$$\mathcal{L}_2\{K(t - t')\} = \frac{\tilde{K}(s) + \tilde{K}(s')}{s + s'}, \quad (39)$$

and therefore

$$\mathcal{L}_2\{X(t, t')\} = \tilde{G}(s) \tilde{R}(s') \frac{\tilde{K}(s) + \tilde{K}(s')}{s + s'}. \quad (40)$$

Using Eq. (18), we can make here the following replacements

$$\tilde{G}(s)\tilde{K}(s) = \tilde{S}(s) - s\tilde{G}(s), \quad \tilde{R}(s')\tilde{K}(s') = 1 - s'\tilde{R}(s') - \omega^2\tilde{G}(s') \quad (41)$$

to get

$$\mathcal{L}_2\{X(t, t')\} = \frac{1}{s + s'} [\tilde{S}(s)\tilde{R}(s') + \tilde{G}(s) - \omega^2\tilde{G}(s)\tilde{G}(s')] - \tilde{G}(s)\tilde{R}(s'). \quad (42)$$

Next, using Eq. (17) one can make another replacements

$$\tilde{R}(s') = s'\tilde{G}(s') \quad \omega^2\tilde{G}(s) = 1 - s\tilde{S}(s), \quad (43)$$

which yields

$$\mathcal{L}_2\{X(t, t')\} = \tilde{S}(s)\tilde{G}(s') - \tilde{G}(s)\tilde{R}(s') + \frac{\tilde{G}(s) - \tilde{G}(s')}{s + s'}. \quad (44)$$

Recalling that $G(t)$ is an odd function and referring again to the properties of double Laplace transform one notices that the last term in the above expression is the double Laplace transform of $G(t - t')$,

$$\mathcal{L}_2\{X(t, t')\} = \tilde{S}(s)\tilde{G}(s') - \tilde{G}(s)\tilde{R}(s') + \mathcal{L}_2\{G(t - t')\}. \quad (45)$$

Therefore in the time domain $X(t, t')$ has the form

$$X(t, t') = S(t)G(t') - G(t)R(t') + G(t - t'). \quad (46)$$

Finally, substituting this expression into Eq. (33) we obtain

$$\langle q(t)v(t') \rangle = \frac{k_B T}{m} G(t - t'), \quad (47)$$

which coincides with the result (32) for the ergodic oscillator in equilibrium.

In a similar manner one can derive the results (32) for auto-correlations $\langle q(t)q(t') \rangle$ and $\langle v(t)v(t') \rangle$. Thus the results (32), connecting the relaxation and correlation functions, hold for both ergodic and nonergodic configurations, provided initial conditions are the equilibrium ones.

V. RELAXATION FUNCTIONS IN LAPLACE DOMAIN

As was shown in the previous sections, the oscillator's dynamics can be described in terms of the relaxation functions $G(t)$, $R(t)$, $S(t)$. Our goal is to find that functions in explicit forms for the specific dissipation kernel $K(t)$ given by Eq. (9). We shall focus on finding $G(t)$, the other two functions can be found by differentiating and integrating $G(t)$, see Eq. (15).

The Laplace transform of the kernel (9) is

$$\tilde{K}(s) = \frac{\mu}{2} \left(\sqrt{s^2 + \omega_0^2} - s \right). \quad (48)$$

Substituting it into Eq. (14) yields the Laplace transform for $G(t)$,

$$\tilde{G}(s) = \frac{2}{(2 - \mu)s^2 + \mu s \sqrt{s^2 + \omega_0^2} + 2\lambda\omega_0^2}, \quad (49)$$

where we introduce the parameter

$$\lambda = (\omega/\omega_0)^2 \quad (50)$$

as a dimensionless alias for the square of the oscillator frequency ω . In what follows, we shall use λ and ω concurrently.

The inversion of transform (49) can be expressed in terms of standard functions only for a few special cases, see the next section. For arbitrary values of λ and μ , the inversion must be performed by evaluating the Bromwich integral

$$G(t) = \frac{1}{2\pi i} \int_{\gamma - i\infty}^{\gamma + i\infty} e^{st} \tilde{G}(s) ds \quad (51)$$

in the complex plane. The character of relaxation (thermalizing or non-thermalizing) is determined by analytical properties of $\tilde{G}(s)$. This can be anticipated as follows. Suppose transform $\tilde{G}(s)$, in addition to the branch points at $\pm i\omega_0$, also has two simple conjugated poles on the imaginary axis $\pm i\omega_*$ with $\omega_* > \omega_0$. Evaluating the Bromwich integral by closing the integration contour, see the right part of Fig. 1, and using Cauchy's residue theorem one expects to get contributions $e^{\pm i\omega_* t}$ which may result in the oscillatory behavior $G(t) \sim \sin\omega_* t$. In that case the condition of thermalization (21) is not satisfied. On the other hand, if $\tilde{G}(s)$ has no poles, or has poles on the real axis, then one expects the relaxation to thermal equilibrium.

According to Eq. (49), the pole positions must be solutions of the equation

$$(2 - \mu)s^2 + \mu s \sqrt{s^2 + \omega_0^2} + 2\lambda\omega_0^2 = 0. \quad (52)$$

The above consideration suggests that the necessary condition of nonergodicity is that Eq. (52) has purely imaginary solutions. The subtlety is that the function $f(s) = \sqrt{s^2 + \omega_0^2}$, and therefore $\tilde{G}(s)$, has two branches and only one of the branches is physically meaningful. Therefore special care is needed to identify the poles of the physical branch of $\tilde{G}(s)$ and to discard the poles for the unphysical branch.

VI. SPECIAL CASES

Let us first consider two cases when the inversion of the transform $\tilde{G}(s)$ given by Eq. (49) is known in closed analytical form. In both cases the oscillator's configuration is ergodic, so from the perspective of this paper those cases are not of particular interest. Yet the special cases can be useful as reference points to verify the validity of the general results.

For the first case

$$\mu = 1, \quad \lambda = (\omega/\omega_0)^2 = 1/2, \quad (53)$$

and transform (49) has the form

$$\tilde{G}(s) = \frac{2}{s^2 + s \sqrt{s^2 + \omega_0^2} + \omega_0^2}. \quad (54)$$

The inverse transform of this expression is given by the Bessel function,

$$G(t) = \frac{2}{\omega_0} J_1(\omega_0 t). \quad (55)$$

The other two relaxation functions, given by Eq. (15), are

$$R(t) = J_0(\omega_0 t) - J_2(\omega_0 t), \quad S(t) = J_0(\omega_0 t). \quad (56)$$

All three relaxation functions vanish at long times and thus satisfy the condition of ergodic relaxation to thermal equilibrium (21).

The second special case corresponds to the parameter values

$$\mu = 1, \quad \lambda = (\omega/\omega_0)^2 = 1/4 \quad (57)$$

when

$$\tilde{G}(s) = \frac{4}{2s^2 + 2s\sqrt{s^2 + \omega_0^2} + \omega_0^2} = \frac{4}{\left(s + \sqrt{s^2 + \omega_0^2}\right)^2}. \quad (58)$$

The inverse transform of this expression is known to be

$$G(t) = \frac{8}{\omega_0^2 t} J_2(\omega_0 t), \quad (59)$$

and the other relaxation functions, according to Eq. (15), are

$$R(t) = \frac{8}{\omega_0 t} J_1(\omega_0 t) - \frac{24}{(\omega_0 t)^2} J_2(\omega_0 t), \quad S(t) = \frac{2}{\omega_0 t} J_1(\omega_0 t). \quad (60)$$

Again, the relaxation functions describe the ergodic relaxation since $G(t), R(t), S(t) \rightarrow 0$ as $t \rightarrow \infty$. It will be shown below that for $\mu < 2$ the condition of nonergodic relaxation reads $\lambda > \lambda_c = 1 - \mu/2$. For both special cases considered in this section $\lambda_c = 1/2$, and the condition is not satisfied.

VII. EQUATIONS FOR POLES

As was noted in Sec. V, the character of the oscillator's relaxation is governed by analytical properties of the function $\tilde{G}(s)$ given by Eq. (49). That function has two branch points at $\pm i\omega_0$ and possibly a number of poles. The positions of poles must satisfy Eq. (52) which we rewrite here as

$$(2 - \mu) s^2 + 2\lambda\omega_0^2 = -\mu s f(s), \quad (61)$$

where the function

$$f(s) = \sqrt{s^2 + \omega_0^2} = \sqrt{(s - i\omega_0)(s + i\omega_0)}, \quad (62)$$

has two branches, which we denote as $f_1(s)$ and $f_2(s)$. Only one of the branches is physically relevant, and our immediate goal is to define and present it in a form convenient for calculations.

To this end, let us write the factors $s \pm i\omega_0$ in Eq. (62) in terms of polar coordinates (r_1, θ_1) and (r_2, θ_2) ,

$$s - i\omega_0 = r_1 e^{i\theta_1}, \quad s + i\omega_0 = r_2 e^{i\theta_2}, \quad (63)$$

see the left part of Fig. 1. Then $f(s)$ takes the form

$$f(s) = \sqrt{r_1 r_2} e^{i\frac{\theta_1 + \theta_2}{2}}. \quad (64)$$

Let us define the first branch $f_1(s)$ of $f(s)$ by Eq. (64) with both polar angles in the interval $(-3\pi/2, \pi/2]$,

$$-\frac{3\pi}{2} < \theta_1 \leq \frac{\pi}{2}, \quad -\frac{3\pi}{2} < \theta_2 \leq \frac{\pi}{2}. \quad (65)$$

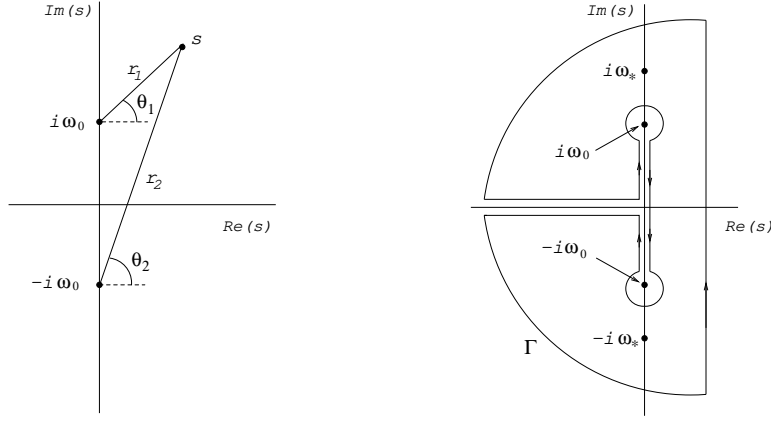

FIG. 1: Left: Polar coordinates used in Eq. (63) to define two branches of the function $f(s) = \sqrt{s^2 + \omega_0^2}$. Right: The integration contour Γ for integral (108). The poles at $\pm i\omega_*$ exist only for nonergodic configurations with $\omega \geq \omega_c$.

The second branch $f_2(s)$ is defined by Eq. (64) with the interval for θ_2 shifted by 2π ,

$$-\frac{3\pi}{2} < \theta_1 \leq \frac{\pi}{2}, \quad \frac{\pi}{2} < \theta_2 \leq \frac{5\pi}{2}. \quad (66)$$

The first branch $f_1(s)$ has, in particular, the following mapping properties:

- (a) If $s = x$ is real and positive (negative), then $f_1(s)$ is also real and positive (negative);
- (b) If $s = \pm i\omega_*$ with real $\omega_* \geq \omega_0$, then $f_1(s) = \pm iz$ with real $z \geq 0$.

One can further elaborate property (b): Suppose $s = \pm i\omega_*$ with $\omega_* \geq \omega_0$, then

$$f_1(\pm i\omega_*) = \pm i\sqrt{\omega_*^2 - \omega_0^2}, \quad (67)$$

where the square root is the unique positive root of a positive real number.

As follows from Eqs.(64)-(66), for any s the two branches of $f(s)$ are connected by the relation $f_2(s) = e^{i\pi} f_1(s) = -f_1(s)$. Therefore, the mapping properties of the second branch $f_2(s)$ are algebraically opposite to that of the first branch, namely:

- (a) If $s = x$ is real and positive (negative), then $f_2(s)$ is real and negative (positive);
- (b) If $s = \pm i\omega_*$ with real $\omega_* \geq \omega_0$, then $f_2(s) = \mp iz$ with real $z \geq 0$.

Keeping in mind the mapping properties of $f(s)$, one can verify that the physically meaningful branches of $\tilde{K}(s)$ and $\tilde{G}(s)$ must involve the first branch $f_1(s)$, because only in that case one recovers the correct initial conditions for $K(t)$ and $G(t)$,

$$K(0) = \lim_{s \rightarrow \infty} s \tilde{K}(s) = \frac{\mu \omega_0^2}{4}, \quad G(0) = \lim_{s \rightarrow \infty} s \tilde{G}(s) = 0. \quad (68)$$

Therefore, in the equation for poles (61) one has to replace the function $f(s)$ by its first (physical) branch,

$$(2 - \mu) s^2 + 2\lambda \omega_0^2 = -\mu s f_1(s). \quad (69)$$

Note that symbolic calculation systems like *Wolfram Mathematica* by default evaluate the function $f(s)$ using its first branch.

Squaring both sides of Eq. (69) and moving all terms to the left hand side, one gets

$$4(1 - \mu) s^4 + [4\lambda(2 - \mu) - \mu^2] \omega_0^2 s^2 + 4\lambda^2 \omega_0^4 = 0. \quad (70)$$

Each solution of Eq. (69) for poles is also a solution of the squared equation (70), but not vice versa. In other words, positions of the poles of $\tilde{G}(s)$ must be among solutions of the squared equation (70), but not every solution of Eq. (70) determines a pole of $\tilde{G}(s)$. A detailed analysis of analytical properties of $\tilde{G}(s)$ is somewhat different for different ranges of μ ; below we shall consider those ranges separately starting with the simpler case $\mu = 1$.

VIII. POLES FOR $\mu = 1$

For $\mu = 1$ equation (69) for the poles of $\tilde{G}(s)$ takes the form

$$s^2 + 2\lambda\omega_0^2 = -s f_1(s), \quad (71)$$

while the squared equation (70), in general of order four, is reduced to a quadratic equation

$$(4\lambda - 1)\omega_0^2 s^2 + 4\lambda^2\omega_0^4 = 0. \quad (72)$$

First consider the case $\lambda > 1/4$ when Eq. (72) has two imaginary solutions

$$s_{1,2} = \pm i\omega_*, \quad \omega_* = \frac{2\lambda}{\sqrt{4\lambda - 1}}\omega_0 \geq \omega_0. \quad (73)$$

Let us show that $s_{1,2}$ are also solutions of Eq. (71), i.e. $\tilde{G}(s)$ has the poles at $s_{1,2}$, but only under the additional constraint $\lambda \geq 1/2$.

To prove that the roots $s_{1,2}$ of the squared equation (72) also satisfy Eq. (71) it is sufficient to show that the left- and right-hand sides of Eq. (71) for $s = s_{1,2}$ have consistent signs. Substituting $s_1 = i\omega_*$ into Eq. (71) one gets for the left-hand side

$$\text{l.h.s.} = \frac{2\lambda(2\lambda - 1)}{4\lambda - 1}\omega_0^2. \quad (74)$$

This expression is non-negative for $\lambda \geq 1/2$. On the other hand, the right-hand side of Eq. (71) for $s = s_1$ is always non-negative,

$$\text{r.h.s.} = -i\omega_* f_1(i\omega_*) \geq 0. \quad (75)$$

This follows from the mapping property (b) for $f_1(s)$ mentioned in Sec. IV, or from Eq. (67). Therefore, the signs of the left- and right-hand sides of Eq. (71) for $s = s_1$ are consistent only for $\lambda \geq 1/2$. A similar consideration applies for $s = s_2$. Thus we conclude that $s_{1,2}$ given by Eq. (73) are solutions of the equation for poles (71) provided $\lambda \geq 1/2$.

The same conclusion can be arrived at by the direct evaluation of the right-hand side of Eq. (71) for $s = s_{1,2}$ taking into account Eqs. (67) and (73). For instance, for $s = s_1$ one gets

$$\text{r.h.s.} = -i\omega_* f_1(i\omega_*) = \omega_* \sqrt{\omega_*^2 - \omega_0^2} = \frac{2\lambda|2\lambda - 1|}{4\lambda - 1}\omega_0^2. \quad (76)$$

For $\lambda \geq 1/2$ this expression equals to the left-hand side (74). This proves that s_1 , and by similar argument s_2 , are solutions of Eq. (71) for poles under condition $\lambda \geq 1/2$.

Next consider the case $\lambda < 1/4$ when the squared equation (72) has two real solutions

$$s_{3,4} = \pm \frac{2\lambda}{\sqrt{1 - 4\lambda}}\omega_0. \quad (77)$$

One observes that $s_{3,4}$ are not solutions of Eq. (71) for poles. Indeed, for $s = s_{3,4}$ the left-hand side of Eq. (71) is still given by expression (74) which is positive for $\lambda < 1/4$. On the other hand, recalling the mapping property (a) for $f_1(s)$, see Sec. VII, one finds that the right-hand side of Eq. (71) is negative for any real s , including $s = s_{3,4}$. Thus, $s_{3,4}$ do not satisfy Eq. (71) and therefore the physical branch of $\tilde{G}(s)$ has no poles at $s_{3,4}$.

For the remaining case $\lambda = 1/4$ the equation (71) for poles takes the factorized form

$$s^2 + s\sqrt{s^2 + \omega_0^2} + \frac{\omega_0^2}{2} = \frac{1}{2} \left(s + \sqrt{s^2 + \omega_0^2} \right)^2 = 0, \quad (78)$$

which has no solutions.

Summarizing, for $\mu = 1$ the physical branch of $\tilde{G}(s)$ has the poles at $s_{1,2} = \pm i\omega_*$ under the condition

$$\lambda \geq \lambda_c = 1/2, \quad (79)$$

i.e. for the oscillator frequency $\omega \geq \omega_c = \omega_0/\sqrt{2}$. The poles are located on the imaginary axis and for $\lambda > \lambda_c$ the corresponding frequency ω_* , given by Eq. (73), is outside the bath spectrum, ($\omega_* > \omega_0$). As was discussed above and will be shown explicitly below, under these conditions the relaxation is nonergodic. For $\lambda < \lambda_c$ the function $\tilde{G}(s)$ has no poles but only the branch points at $\pm i\omega_0$. In that case the relaxation is expected and will be shown to be ergodic. For $\lambda = \lambda_c = 1/2$ we get $\omega_* = \omega_0$, and the poles coincide with the branch points, $s_{1,2} = \pm i\omega_0$. That is one of the special cases ($\mu = 1$ and $\lambda = 1/2$) considered in Sec. VI. The relaxation was shown there to be ergodic. Thus we conclude that for $\mu = 1$ the relaxation is expected to be ergodic for $\lambda \leq \lambda_c = 1/2$ (for lower oscillator frequencies $\omega \leq \omega_c = \omega_0/\sqrt{2}$) and nonergodic for $\lambda > \lambda_c$ (for higher oscillator frequencies $\omega > \omega_c$).

IX. POLES FOR $\mu < 1$

For $\mu \neq 1$ the squared equation (70) is of order four and has four roots which we present as two pairs

$$s_{1,2} = \pm \sqrt{z_+(\lambda, \mu)} \omega_0, \quad s_{3,4} = \pm \sqrt{z_-(\lambda, \mu)} \omega_0, \quad (80)$$

where

$$z_{\pm}(\lambda, \mu) = \frac{1}{8(1-\mu)} \left(\mu^2 + 4\lambda(\mu - 2) \pm \mu \sqrt{D} \right), \quad (81)$$

$$D = 16\lambda^2 + 8\lambda(\mu - 2) + \mu^2. \quad (82)$$

We need to verify which of these roots, if any, are also solutions of the (unsquared) equation for poles (69). Below we show that $\tilde{G}(s)$ has poles only at $s_{1,2}$, but not at $s_{3,4}$, and only under the condition

$$\lambda \geq \lambda_c = 1 - \mu/2. \quad (83)$$

Properties of the roots $s_{1,2}$ and $s_{3,4}$ depend on the sign of the discriminant D . Consider first the case $D \geq 0$ when the functions $z_{\pm}(\lambda, \mu)$ are both real. For the considered domain $\mu < 1$, the inequality $D \geq 0$ holds when

$$\lambda \leq \lambda_-, \quad \text{or} \quad \lambda \geq \lambda_+, \quad (84)$$

where

$$\lambda_{\pm} = \frac{1}{4} \left(2 - \mu \pm 2\sqrt{1-\mu} \right) < \lambda_c. \quad (85)$$

One can verify that for $\lambda \leq \lambda_-$ both functions z_{\pm} are positive, so that all four roots (80) are real. But it is easy to see, recalling mapping rule (a) for $f_1(s)$ in Sec. VII, that equation (69) for poles

$$(2 - \mu) s^2 + 2\lambda \omega_0^2 = -\mu s f_1(s). \quad (86)$$

cannot have real solutions for the given domain $\mu < 1$ since the left- and right-hand sides of the equation for real s have the opposite signs. Thus we find that for $\lambda \leq \lambda_-$ the function $\tilde{G}(s)$ has no poles.

On the other hand, for $\lambda \geq \lambda_+$ both functions z_{\pm} can be shown to be negative, and all four roots (80) are purely imaginary. Consider the first pair of roots, writing it as

$$s_{1,2} = \pm i \omega_*, \quad \omega_* = \beta_*(\lambda, \mu) \omega_0 \quad (87)$$

where the dimensionless function $\beta_*(\lambda, \mu)$ reads

$$\beta_*(\lambda, \mu) = \sqrt{-z_+(\lambda, \mu)} = \left\{ \frac{-1}{8(1-\mu)} \left(\mu^2 + 4\lambda(\mu - 2) + \mu \sqrt{D} \right) \right\}^{1/2}. \quad (88)$$

Here the square roots are the unique positive roots of positive real numbers. Let us define the critical value λ_c for which $\beta_*(\lambda, \mu) = 1$,

$$\beta_*(\mu, \lambda_c) = 1 \quad \Rightarrow \quad \lambda_c = 1 - \mu/2. \quad (89)$$

Note again that $\lambda_c > \lambda_+$. One can verify that for the considered domain $\mu < 1$ the function $\beta_*(\lambda, \mu)$ for any fixed μ has a minimum at $\lambda = \lambda_c$, so that

$$\beta_*(\lambda, \mu) \geq \beta_*(\lambda_c, \mu) = 1, \quad (90)$$

and the equality $\beta_* = 1$ holds only for $\lambda = \lambda_c$. Therefore, the roots $s_{1,2}$ have the structure $s_{1,2} = \pm i \omega_*$ with $\omega_* = \beta_* \omega_0 \geq \omega_0$. Then according to Eq. (67)

$$f_1(s_{1,2}) = f_1(\pm i \omega_*) = \pm i \sqrt{\omega_*^2 - \omega_0^2}. \quad (91)$$

Taking this into account and substituting $s_{1,2}$ into equation (86) for poles we find that the right-hand side of the equation is real and non-negative

$$-\mu s_{1,2} f_1(s_{1,2}) = \mu \omega_* \sqrt{\omega_*^2 - \omega_0^2} \geq 0. \quad (92)$$

The equation is satisfied by $s_{1,2}$ only if the left-hand side is also non-negative,

$$(2 - \mu) (s_{1,2})^2 + 2\lambda\omega_0^2 = -(2 - \mu)\omega_*^2 + 2\lambda\omega_0^2 \geq 0, \quad (93)$$

which gives the condition

$$\lambda \geq \left(1 - \frac{\mu}{2}\right) \left(\frac{\omega_*}{\omega_0}\right)^2 = \lambda_c \beta_*^2(\lambda, \mu). \quad (94)$$

Writing this as

$$\frac{\lambda}{\lambda_c} \geq \beta_*^2(\lambda, \mu), \quad (95)$$

one observes that, since $\beta_*(\lambda, \mu) \geq 1$, the condition necessarily implies $\lambda \geq \lambda_c$. Further, one can directly verify that the condition $\lambda \geq \lambda_c$ is not only necessary but also sufficient for the validity of inequality (95): the latter holds for *any* $\lambda \geq \lambda_c$. Thus we find that the first pair of roots $s_{1,2}$ of the squared equation (70) also satisfy the equation for poles (86), and therefore $\tilde{G}(s)$ has poles at $s_{1,2}$ under the condition $\lambda \geq \lambda_c$. The same conclusion one gets directly evaluating the left- and right-hand sides of equation (86) for poles at $s = s_{1,2}$.

Consider now the second pair of roots of the squared equation (70), writing them as

$$s_{3,4} = \pm i\omega_\dagger, \quad \omega_\dagger = \beta_\dagger(\lambda, \mu)\omega_0 \quad (96)$$

with

$$\beta_\dagger(\lambda, \mu) = \sqrt{-z_-(\lambda, \mu)} = \left\{ \frac{-1}{8(1-\mu)} \left(\mu^2 + 4\lambda(\mu-2) - \mu\sqrt{D} \right) \right\}^{1/2}, \quad (97)$$

and assuming $\lambda \geq \lambda_+$. One can verify that for the considered domain $\mu < 1$

$$\beta_\dagger(\lambda, \mu) > 1, \quad \text{for } \lambda \geq \lambda_+, \quad (98)$$

so that $\omega_\dagger = \beta_\dagger\omega_0 \geq \omega_0$. Repeating the above arguments for $s_{1,2}$ we find that the roots $s_{3,4}$ satisfy Eq. (86) for poles under the condition

$$\frac{\lambda}{\lambda_c} > \beta_\dagger^2(\lambda, \mu), \quad (99)$$

which is similar to condition (95) for $s_{1,2}$. One can directly verify (for instance, graphically) that inequality (99) cannot be satisfied for any $\lambda \geq \lambda_+$ and $\mu < 1$. Therefore, the roots $s_{3,4}$ do not satisfy Eq. (86) and $\tilde{G}(s)$ has no poles at $s_{3,4}$.

Finally, we need to consider the interval $\lambda_- < \lambda < \lambda_+$. In that case the discriminant D in Eq. (81) is negative, and the roots $s_{1,2}$ and $s_{3,4}$ have non-zero real and imaginary parts. In that case the simple arguments we used above, based on the mapping rules for the function $f(s) = \sqrt{s^2 + \omega_0^2}$ for purely real or imaginary s , do not apply. Yet, an explicit evaluation (which is convenient to execute with *Mathematica*) shows that the imaginary parts of the left- and right-hand sides of the equation for poles (86) for $s = s_{1,2}$, and also for $s = s_{3,4}$, have opposite signs. Real parts also have opposite signs except one value of λ for which they are both zero. Thus for $\lambda_- < \lambda < \lambda_+$ neither $s_{1,2}$ nor $s_{3,4}$ give positions of poles of the physical branch of $\tilde{G}(s)$.

Summarizing, for $\mu < 1$ the function $\tilde{G}(s)$ under condition

$$\lambda \geq \lambda_c = 1 - \mu/2 \quad (100)$$

has two poles. The poles positions are given by Eqs. (87) and (88) and have the form $s_{1,2} = \pm i\omega_*$ with $\omega_* \geq \omega_0$. The equality $\omega_* = \omega_0$ occurs for $\lambda = \lambda_c$; for $\lambda > \lambda_c$ the poles frequency ω_* is higher than the maximal mode frequency of the bath, $\omega_* > \omega_0$. Since $\lambda = (\omega/\omega_0)^2$, condition (100) corresponds to higher values of the oscillator frequency ω . For $\lambda < \lambda_c$, i.e. for lower frequencies, $\tilde{G}(s)$ has no poles and its only singularities are the two branch points at $\pm i\omega_0$. These analytical properties are expected and will be shown below to correspond to nonergodic behavior for $\lambda > \lambda_c$ (for the higher frequency domain) and ergodic relaxation to thermal equilibrium for $\lambda \leq \lambda_c$ (for the lower frequency domain).

X. POLES FOR $\mu > 1$

For $\mu > 1$ the roots $s_{1,2}$ and $s_{3,4}$ of the squared equation (70) are given by the same expressions (80)-(82) as for $\mu < 1$, but now the discriminant $D = 16\lambda^2 + 8\lambda(\mu - 2) + \mu^2$ is positive for any λ and the functions $z_{\pm}(\lambda, \mu)$ are both real. Further one finds that $z_+(\lambda, \mu) < 0$ and $z_-(\lambda, \mu) > 0$. Therefore, the first pair of roots $s_{1,2} = \pm\sqrt{z_+}$ are purely imaginary, and the second pair $s_{3,4} = \pm\sqrt{z_-}$ are real. As was noted in the previous section, a real s cannot be a solution of Eq. (86) for poles. Therefore the roots $s_{3,4}$ must be discarded, $\tilde{G}(s)$ has no poles there.

Consider the purely imaginary roots $s_{1,2}$. They are given by the same expressions (87) and (88) as for $\mu < 1$,

$$s_{1,2} = \pm i\omega_*, \quad \omega_* = \beta_*(\lambda, \mu)\omega_0, \\ \beta_*(\lambda, \mu) = \sqrt{-z_+(\lambda, \mu)} = \left\{ \frac{-1}{8(1-\mu)} \left(\mu^2 + 4\lambda(\mu - 2) + \mu\sqrt{D} \right) \right\}^{1/2}. \quad (101)$$

As in the previous section, let us define the critical value λ_c for which $\beta_*(\lambda, \mu) = 1$,

$$\beta_*(\mu, \lambda_c) = 1 \quad \Rightarrow \quad \lambda_c = 1 - \mu/2. \quad (102)$$

In contrast to the case $\mu \leq 1$ discussed in the previous sections, a meaningful (non-negative) λ_c exists only under the additional constraint $\mu \leq 2$. Thus for $\mu > 1$ we need to consider separately the intervals $1 < \mu < 2$ and $\mu \geq 2$.

For $1 < \mu < 2$, substituting $s_{1,2} = \pm i\omega_*$ into Eq. (86) for poles, one finds as in the previous section that the equation is satisfied under condition (94)

$$\lambda \geq \lambda_c \beta_*^2(\lambda, \mu), \quad (103)$$

which holds for $\lambda \geq \lambda_c$.

For $\mu \geq 2$, the substitution of $s_{1,2} = \pm i\omega_*$ into Eq. (86) for poles leads again to condition (103), but now that condition is trivially satisfied for any $\lambda > 0$ since $\lambda_c = 1 - \mu/2 \leq 0$ and the right-hand side of inequality (103) is non-positive.

Summarizing, for $\mu > 1$ analytical properties of $\tilde{G}(s)$ are different for the intervals $1 < \mu < 2$ and $\mu \geq 2$. For the interval $1 < \mu < 2$ we find the properties similar to that for $\mu < 1$, that is $\tilde{G}(s)$ has poles at $s_{1,2}$ given by Eq. (101) under the condition $\lambda \geq \lambda_c = 1 - \mu/2$. For $\lambda = \lambda_c$ the poles coincide with the branch points at $\pm i\omega_0$. On the other hand, for $\mu \geq 2$ the transform $\tilde{G}(s)$ has poles at $s_{1,2}$ for any value of λ . These properties suggest the following: For $\mu < 2$ the relaxation is nonergodic for $\lambda > \lambda_c$ (for higher oscillator frequency ω) and ergodic for $\lambda \leq \lambda_c$ (for lower ω). For $\mu \geq 2$ the relaxation is nonergodic for any λ (for any ω). In what follows, these expectations will be confirmed by explicit evaluation of the relaxation functions in the time domain.

XI. RELAXATION FUNCTIONS FOR $\mu = 1$

For $\mu = 1$ the Laplace transform (49) of the relaxation function $G(t)$ takes the form

$$\tilde{G}(s) = \frac{2}{s^2 + s f_1(s) + 2\lambda\omega_0^2}, \quad (104)$$

where $f_1(s)$ is the physical branch of the function $f(s) = \sqrt{s^2 + \omega_0^2}$ defined in Sec. VII. The inverse transform is given by the Bromwich integral (51),

$$G(t) = \frac{1}{2\pi i} \int_{\gamma-i\infty}^{\gamma+i\infty} e^{st} \tilde{G}(s) ds. \quad (105)$$

The singular points of $\tilde{G}(s)$ are two branch points $\pm i\omega_0$ and also possibly two poles. As was discussed in Sec. VIII, for $\mu = 1$ the poles exist under the condition

$$\lambda \geq \lambda_c = 1/2, \quad \text{or} \quad \omega \geq \omega_c = \sqrt{1/2}\omega_0, \quad (106)$$

and have the form

$$s_{1,2} = \pm i\omega_*, \quad \omega_* = \frac{2\lambda}{\sqrt{4\lambda - 1}}\omega_0 \geq \omega_0. \quad (107)$$

For $\lambda = \lambda_c$ the poles and branch points coincide, and for $\lambda < \lambda_c$ the function $\tilde{G}(s)$ has no poles. Since all singularities are located on the imaginary axis, the integration path in Eq. (105) is along a vertical line to the right of the origin, $\gamma > 0$. With the nature of singular points established, the evaluation of integral (105) is a standard exercise in complex variable analysis; below we outline the main points.

The first step is to consider the auxiliary integral

$$I(t) = \frac{1}{2\pi i} \int_{\Gamma} e^{st} \tilde{G}(s) ds \quad (108)$$

over a closed contour Γ shown in Fig. 1. As the radius of the arc of Γ goes to infinity, the contribution from the arc vanishes. The contributions from the paths above and below the negative real axis are mutually canceled. The integrals over the small circles around the branch points $\pm i\omega_0$ can be shown to vanish as the circles radii goes to zero. The latter is true for any λ including $\lambda = \lambda_c = 1/2$, when the branch points coincide with the poles. The only non-zero contributions to the integral $I(t)$ are those from the the rightmost vertical path and the two shores of the branch cut along the imaginary axis connecting the branch points $\pm i\omega_0$. When the radius of the arc of Γ goes to infinity, the contribution from the rightmost vertical path, according to Eq. (105), equals $G(t)$, therefore

$$I(t) = G(t) + I_0(t), \quad (109)$$

where

$$I_0 = I_0^+ + I_0^- = \frac{1}{2\pi i} \int_{\Gamma_0^+} e^{st} \tilde{G}(s) ds + \frac{1}{2\pi i} \int_{\Gamma_0^-} e^{st} \tilde{G}(s) ds \quad (110)$$

is the contribution from the path along the right (Γ_0^+) and left (Γ_0^-) shores of the branch cut in the clockwise direction. On the other hand, the integral $I(t)$ can be evaluated with Cauchy's integral and residue theorems:

$$I(t) = \begin{cases} 0, & \text{if } \lambda \leq \lambda_c. \\ \sum_{i=1,2} Res[e^{st} \tilde{G}(s), s_i], & \text{if } \lambda > \lambda_c. \end{cases} \quad (111)$$

From (109) and (111) one gets

$$G(t) = \begin{cases} -I_0(t), & \text{for } \lambda \leq \lambda_c, \\ -I_0(t) + \sum_{i=1,2} Res[e^{st} \tilde{G}(s), s_i], & \text{for } \lambda > \lambda_c. \end{cases} \quad (112)$$

The integral $I_0(t)$ along the branch cut for arbitrary μ is evaluated in Appendix A; for $\mu = 1$ the result takes the form

$$I_0(t) = -\frac{4}{\pi\omega_0} \int_0^1 \frac{x \sqrt{1-x^2} \sin(x\omega_0 t) dx}{(1-4\lambda)x^2 + 4\lambda^2}. \quad (113)$$

The residues $Res[e^{st} \tilde{G}(s), s_{1,2}]$ are evaluated for arbitrary μ in Appendix B; for $\mu = 1$ we get

$$Res[e^{st} \tilde{G}(s), s_1] + Res[e^{st} \tilde{G}(s), s_2] = \frac{1}{\omega_0} \frac{4\sqrt{\beta^2-1}}{(2\beta^2-1) + 2\beta\sqrt{\beta^2-1}} \sin(\omega_* t), \quad (114)$$

where

$$\beta = \beta(\lambda) = \frac{\omega_*}{\omega_0} = \frac{2\lambda}{\sqrt{4\lambda-1}}. \quad (115)$$

This quantity has been denoted in the previous sections as β_* ; from now on we drop the asterisk subscript as superfluous. From Eqs. (114) and (115) one gets a more explicit expression

$$Res[e^{st} \tilde{G}(s), s_1] + Res[e^{st} \tilde{G}(s), s_2] = \frac{1}{\omega_0} \frac{8\lambda-4}{(4\lambda-1)^{3/2}} \sin(\omega_* t). \quad (116)$$

Finally, substituting Eqs. (113) and (116) into Eq. (112) yields

$$G(t) = \begin{cases} G_e(t), & \text{if } \lambda \leq \lambda_c, \\ G_e(t) + G_0 \sin(\omega_* t), & \text{if } \lambda > \lambda_c. \end{cases} \quad (117)$$

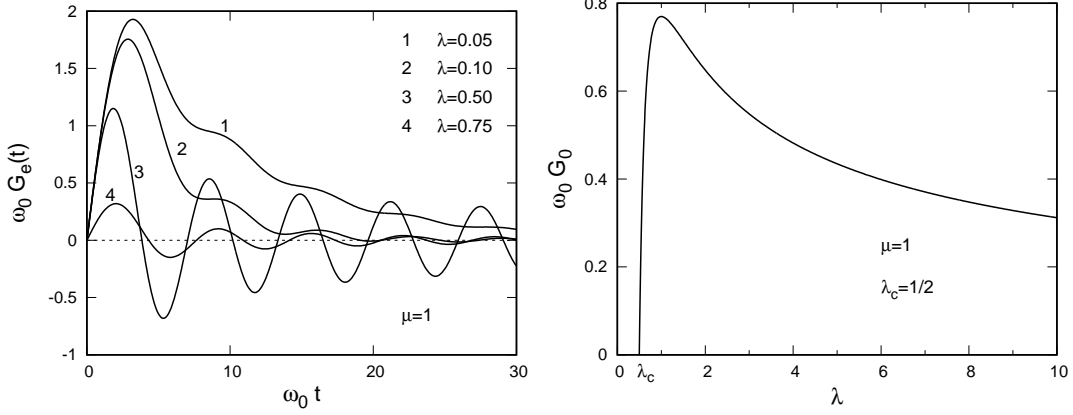

FIG. 2: Left: The ergodic component $G_e(t)$ of the relaxation function $G(t)$, see Eqs. (117) and (118), for the mass ratio parameter $\mu = 1$ and several values of the oscillator frequency parameter $\lambda = (\omega/\omega_0)^2$. Right: The amplitude G_0 of the nonergodic time-periodic component of $G(t)$ as a function of λ . It is zero for $\lambda \leq \lambda_c = 1/2$ and has a maximum at $\lambda = 1$.

where

$$G_e(t) = \frac{4}{\pi\omega_0} \int_0^1 \frac{\sin(x\omega_0 t) x \sqrt{1-x^2} dx}{(1-4\lambda)x^2 + 4\lambda^2}, \quad G_0 = \frac{1}{\omega_0} \frac{8\lambda - 4}{(4\lambda - 1)^{3/2}}, \quad (118)$$

$\lambda_c = 1/2$, and the frequency of the oscillating (nonergodic) term is $\omega_* = \beta\omega_0$ with $\beta = \beta(\lambda)$ given by Eq. (115).

The function $G_e(t)$ for any λ vanishes at long times and thus represents the ergodic component of $G(t)$ (hence the subscript e), while G_0 is the amplitude of the nonergodic component. At long times $G(t)$ has the asymptotic form

$$G(t) \rightarrow \begin{cases} 0, & \text{if } \lambda \leq \lambda_c, \\ G_0 \sin(\omega_* t), & \text{if } \lambda > \lambda_c. \end{cases} \quad (119)$$

As was discussed in Sec. III, see Eq. (21), the asymptotic long time condition $G(t) \rightarrow 0$ corresponds to ergodic relaxation. Thus, as anticipated, the results (117) and (119) show that the oscillator is ergodic (reaches thermal equilibrium with the bath at long times) when $\lambda \leq \lambda_c = 1/2$. For $\lambda > \lambda_c$, the time-periodic component of $G(t)$ develops; the oscillator is nonergodic and does not thermalize.

For $\lambda = 1/4$ and $\lambda = 1/2$ the integral form of the ergodic component $G_e(t)$ given by Eq. (118) can be expressed in terms of the Bessel functions,

$$G(t) = G_e(t) = \begin{cases} \frac{8}{\omega_0^2 t} J_2(\omega_0 t), & \text{for } \lambda = 1/4, \\ \frac{2}{\omega_0} J_1(\omega_0 t), & \text{for } \lambda = 1/2. \end{cases} \quad (120)$$

Those are two special solutions already found in Sec. VI using a table of standard Laplace transforms.

For several values of $\lambda < 1$ the ergodic component $G_e(t)$ is presented on the left plot of Fig. 2. For $\lambda > 1$, $G_e(t)$ has an oscillatory decaying shape similar to that for $\lambda = 1/2$, but its range quickly decreases with increasing λ ; for instance, for $\lambda = 5$ the maximum value of $G_e(t)$ is of order of 10^{-3} .

The amplitude $G_0(\lambda)$ of the nonergodic oscillatory component, given by Eq. (118), as a function of λ is shown on the right plot of Fig. 2. It is zero for $\lambda \leq \lambda_c$, while for $\lambda > \lambda_c$ it first quickly increases, reaches a maximum at $\lambda = 1$, and then monotonically decreases as $1/\sqrt{\lambda}$.

Differentiating and integrating Eq. (117) yield the other two relaxation functions $R(t)$ and $S(t)$, see Eq. (15). They have the structure similar to $G(t)$, i.e. have only ergodic component for $\lambda \leq \lambda_c$ and both ergodic and nonergodic components for $\lambda > \lambda_c$. For $R(t) = \frac{d}{dt}G(t)$ we get

$$R(t) = \begin{cases} R_e(t), & \text{if } \lambda \leq \lambda_c, \\ R_e(t) + R_0 \cos(\omega_* t), & \text{if } \lambda > \lambda_c, \end{cases} \quad (121)$$

where the ergodic component $R_e(t)$ and the amplitude R_0 of the nonergodic component are

$$R_e(t) = \frac{4}{\pi} \int_0^1 \frac{\cos(x\omega_0 t) x^2 \sqrt{1-x^2} dx}{(1-4\lambda)x^2 + 4\lambda^2}, \quad R_0 = \beta\omega_0 G_0 = \frac{8\lambda(2\lambda-1)}{(4\lambda-1)^2}. \quad (122)$$

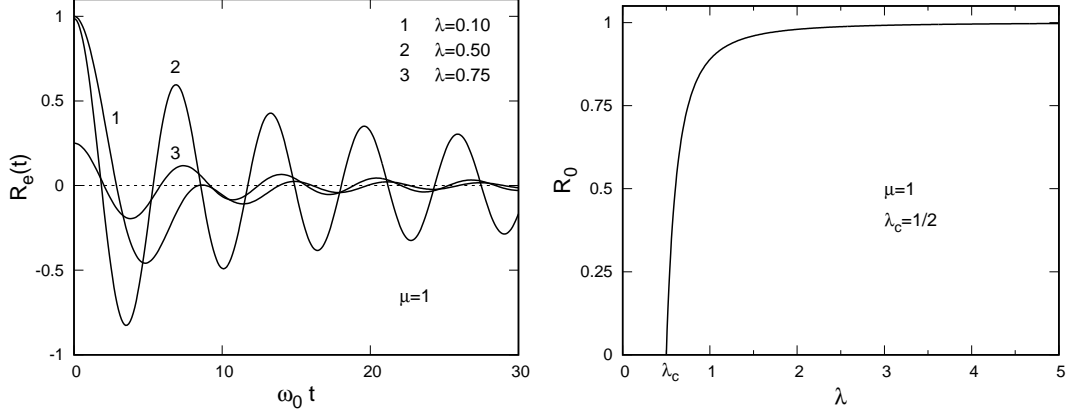

FIG. 3: Left: The ergodic component $R_e(t)$ of the relaxation function $R(t)$, see Eqs. (121) and (122), for the mass ratio parameter $\mu = 1$ and several values of the frequency parameter $\lambda = (\omega/\omega_0)^2$. Right: The amplitude R_0 of the nonergodic time-periodic component of $R(t)$ as a function of λ . The nonergodic component is zero for $\lambda \leq \lambda_c = 1/2$.

The functions $R_e(t)$ and $R_0(\lambda)$ are presented in Fig. 3. Similar to $G_e(t)$, $R_e(t)$ vanishes at long times for any λ , and thus can be interpreted as an ergodic component of $R(t)$. Note that $R_e(0) = 1$ for $\lambda \leq \lambda_c$ and $R_e(0) + R_0 = 1$ for $\lambda > \lambda_c$, so that $R(0) = 1$ for any λ . This is the correct initial condition which can be found without inverting $\tilde{R}(s)$, see Eq. (16).

For the relaxation function $S(t) = 1 - \omega^2 \int_0^t G(t)dt$ we get

$$S(t) = \begin{cases} S_e(t), & \text{if } \lambda \leq \lambda_c, \\ S_e(t) + S_0 [\cos(\omega_* t) - 1], & \text{if } \lambda > \lambda_c. \end{cases} \quad (123)$$

with

$$S_e(t) = 1 - \frac{4\lambda}{\pi} \int_0^1 \frac{[1 - \cos(x\omega_0 t)] \sqrt{1-x^2} dx}{(1-4\lambda)x^2 + 4\lambda^2}, \quad S_0 = \frac{\lambda\omega_0 G_0}{\beta} = \frac{4\lambda - 2}{4\lambda - 1}. \quad (124)$$

The functions $S_e(t)$ and $S_0(\lambda)$ are presented in Fig. 4. At long times $S_e(t)$ has the asymptotic time-independent form

$$S_e(t) \rightarrow 1 - \frac{4\lambda}{\pi} \int_0^1 \frac{\sqrt{1-x^2} dx}{(1-4\lambda)x^2 + 4\lambda^2}, \quad (125)$$

which takes different values for $\lambda \leq \lambda_c$ and for $\lambda > \lambda_c$, namely

$$S_e(t) \rightarrow \begin{cases} 0, & \text{if } \lambda \leq \lambda_c, \\ S_0, & \text{if } \lambda > \lambda_c. \end{cases} \quad (126)$$

As the result, similar to the other two relaxation functions, $S(t)$ at long times vanishes for ergodic configurations and oscillates about zero for nonergodic ones,

$$S(t) \rightarrow \begin{cases} 0, & \text{if } \lambda \leq \lambda_c, \\ S_0 \cos \omega_* t, & \text{if } \lambda > \lambda_c. \end{cases} \quad (127)$$

Summarizing, in this section we obtained explicit expressions for the relaxation functions for the case $\mu = 1$. For $\lambda \leq \lambda_c$ (for lower values of the oscillator frequency, $\omega \leq \omega_c = \sqrt{\lambda_c} \omega_0 = \omega_0/\sqrt{2}$), the relaxation functions vanish at long times. As was discussed in Sec. III, such behavior corresponds to the ergodic relaxation to thermal equilibrium. On the other hand, for $\lambda > \lambda_c$ (for higher frequencies $\omega > \omega_c$) the relaxation functions develop time-periodic terms which do not vanish at long times but oscillate about zero. As a result, the oscillator does not thermalize but reaches a cyclostationary non-equilibrium state characterized by the oscillatory behavior of the relaxation functions. Below we show that similar results hold not only for $\mu = 1$ but for the entire domain $\mu < 2$.

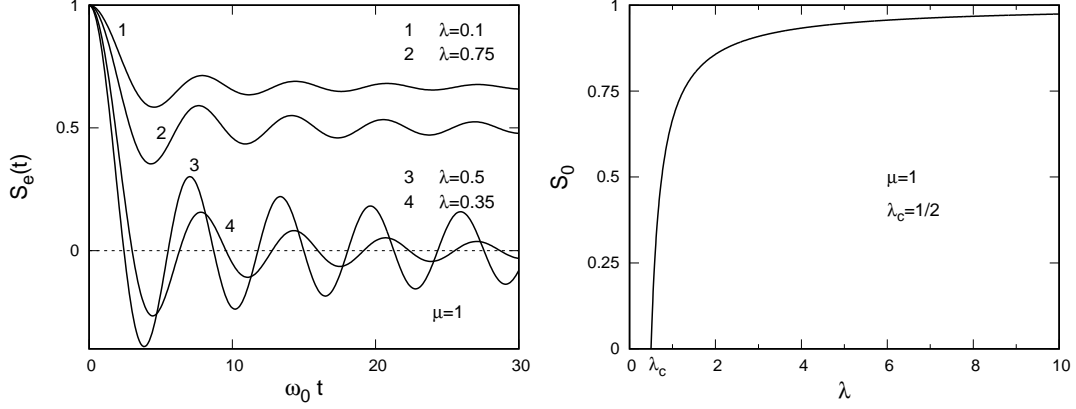

FIG. 4: Left: The ergodic component $S_e(t)$ of the relaxation function $S(t)$, see Eqs. (123) and (124), for the mass ratio parameter $\mu = 1$ and several values of the frequency parameter $\lambda = (\omega/\omega_0)^2$. Right: The amplitude S_0 of the nonergodic component of $S(t)$ as a function of λ .

XII. RELAXATION FUNCTIONS FOR $\mu < 2$

In Secs. IX and X we found that for the intervals $\mu < 1$ and $1 < \mu < 2$, and also under the condition

$$\lambda \geq \lambda_c = 1 - \mu/2, \quad \text{or} \quad \omega \geq \omega_c = \sqrt{1 - \mu/2} \omega_0 \quad (128)$$

the Laplace transform $\tilde{G}(s)$ of the relaxation function $G(t)$ has two poles on the imaginary axis. The poles are given by the following expressions:

$$s_{1,2} = \pm i \omega_*, \quad \omega_* = \beta(\alpha, \mu) \omega_0, \quad (129)$$

$$\beta(\alpha, \mu) = \left\{ \frac{1}{8(\mu-1)} \left(\mu^2 + 4\lambda(\mu-2) + \mu \sqrt{16\lambda^2 + 8\lambda(\mu-2) + \mu^2} \right) \right\}^{1/2},$$

and λ_c is defined by the equation $\beta(\lambda_c, \mu) = 1$. On the other hand, for $\lambda < \lambda_c$ the transform $\tilde{G}(s)$ has no poles. To find $G(t)$ for the combined domain

$$\mu \in (0, 1) \cup (1, 2) \quad (130)$$

by inversion of $\tilde{G}(s)$ we follow the same procedure as in the previous section to find again expression (112),

$$G(t) = \begin{cases} -I_0(t), & \text{for } \lambda \leq \lambda_c, \\ -I_0(t) + \sum_{i=1,2} \text{Res}[e^{st} \tilde{G}(s), s_i], & \text{for } \lambda > \lambda_c, \end{cases} \quad (131)$$

where the integral

$$I_0 = I_0^+ + I_0^- = \frac{1}{2\pi i} \int_{\Gamma_0^+} e^{st} \tilde{G}(s) ds + \frac{1}{2\pi i} \int_{\Gamma_0^-} e^{st} \tilde{G}(s) ds \quad (132)$$

is along the right (Γ_0^+) and left (Γ_0^-) shores of the branch cut in the clockwise direction. As shown in Appendix A, for arbitrary μ this integral has the form

$$I_0(t) = -\frac{4\mu}{\pi\omega_0} \int_0^1 \frac{x \sqrt{1-x^2} \sin(x\omega_0 t) dx}{4(1-\mu)x^4 + [4\lambda(\mu-2) + \mu^2]x^2 + 4\lambda^2}. \quad (133)$$

The sum of residues is evaluated in Appendix B,

$$\text{Res}[e^{st} \tilde{G}(s), s_1] + \text{Res}[e^{st} \tilde{G}(s), s_2] = \frac{1}{\omega_0} \frac{4\sqrt{\beta^2-1}}{\mu(2\beta^2-1) + 2(2-\mu)\beta\sqrt{\beta^2-1}} \sin(\omega_* t). \quad (134)$$

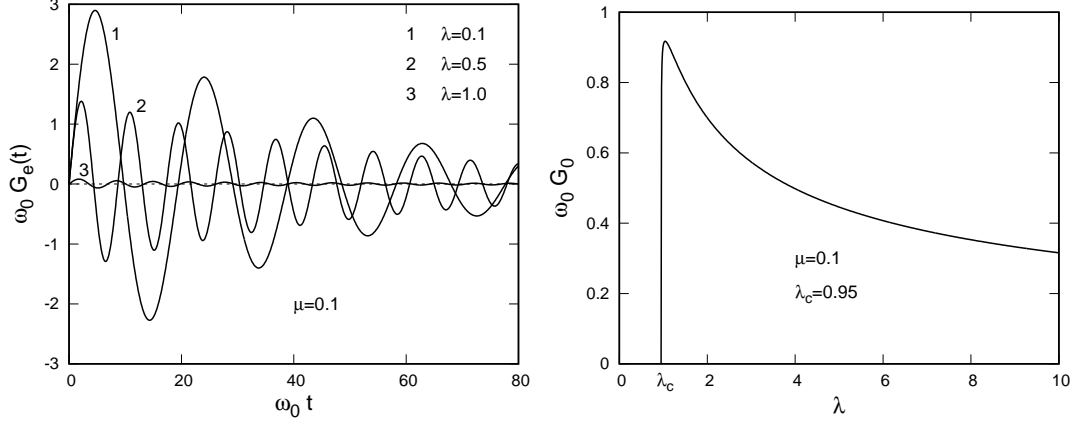

FIG. 5: Left: The ergodic component $G_e(t)$ of the relaxation function $G(t)$, see Eqs. (135) and (136), for the mass ratio parameter $\mu = 0.1$ and several values of the frequency parameter $\lambda = (\omega/\omega_0)^2$. Right: The amplitude G_0 of the nonergodic component of $G(t)$ as a function of λ for $\mu = 0.1$. The nonergodic term is zero for $\lambda \leq \lambda_c = 1 - \mu/2 = 0.95$.

Substituting Eqs.(133) and (134) into Eq.(131) yields

$$G(t) = \begin{cases} G_e(t), & \text{if } \lambda \leq \lambda_c, \\ G_e(t) + G_0 \sin(\omega_* t), & \text{if } \lambda > \lambda_c. \end{cases} \quad (135)$$

where the ergodic component $G_e(t)$ and the amplitude G_0 of the nonergodic oscillatory term are

$$G_e(t) = \frac{4\mu}{\pi\omega_0} \int_0^1 \frac{x \sqrt{1-x^2} \sin(x\omega_0 t) dx}{4(1-\mu)x^4 + [4\lambda(\mu-2) + \mu^2]x^2 + 4\lambda^2},$$

$$G_0 = \frac{1}{\omega_0} \frac{4\sqrt{\beta^2-1}}{\mu(2\beta^2-1) + 2(2-\mu)\beta\sqrt{\beta^2-1}}, \quad (136)$$

the frequency of the nonergodic term is $\omega_* = \beta\omega_0$, and β is given by Eq. (129).

For the relaxation function $R(t) = dG(t)/dt$ we get

$$R(t) = \begin{cases} R_e(t), & \text{if } \lambda \leq \lambda_c, \\ R_e(t) + R_0 \cos(\omega_* t), & \text{if } \lambda > \lambda_c, \end{cases}$$

$$R_e(t) = \frac{4\mu}{\pi} \int_0^1 \frac{x^2 \sqrt{1-x^2} \cos(x\omega_0 t) dx}{4(1-\mu)x^4 + [4\lambda(\mu-2) + \mu^2]x^2 + 4\lambda^2},$$

$$R_0 = \beta\omega_0 G_0 = \frac{4\beta\sqrt{\beta^2-1}}{\mu(2\beta^2-1) + 2(2-\mu)\beta\sqrt{\beta^2-1}}, \quad (137)$$

Finally, for the relaxation function $S(t) = 1 - \omega^2 \int_0^t G(t)dt$ we obtain

$$S(t) = \begin{cases} S_e(t), & \text{if } \lambda \leq \lambda_c, \\ S_e(t) + S_0 [\cos(\omega_* t) - 1], & \text{if } \lambda > \lambda_c, \end{cases}$$

$$S_e(t) = 1 - \frac{4\lambda\mu}{\pi} \int_0^1 \frac{\sqrt{1-x^2} [1 - \cos(x\omega_0 t)] dx}{4(1-\mu)x^4 + [4\lambda(\mu-2) + \mu^2]x^2 + 4\lambda^2},$$

$$S_0 = \frac{\lambda}{\beta} \omega_0 G_0 = \frac{\lambda}{\beta} \frac{4\sqrt{\beta^2-1}}{\mu(2\beta^2-1) + 2(2-\mu)\beta\sqrt{\beta^2-1}}. \quad (138)$$

At long times the time-dependent contribution in the expression for $S_e(t)$ vanishes, and $S_e(t)$ takes the asymptotic form

$$S_e(t) \rightarrow 1 - \frac{4\lambda\mu}{\pi} \int_0^1 \frac{\sqrt{1-x^2} dx}{4(1-\mu)x^4 + [4\lambda(\mu-2) + \mu^2]x^2 + 4\lambda^2}. \quad (139)$$

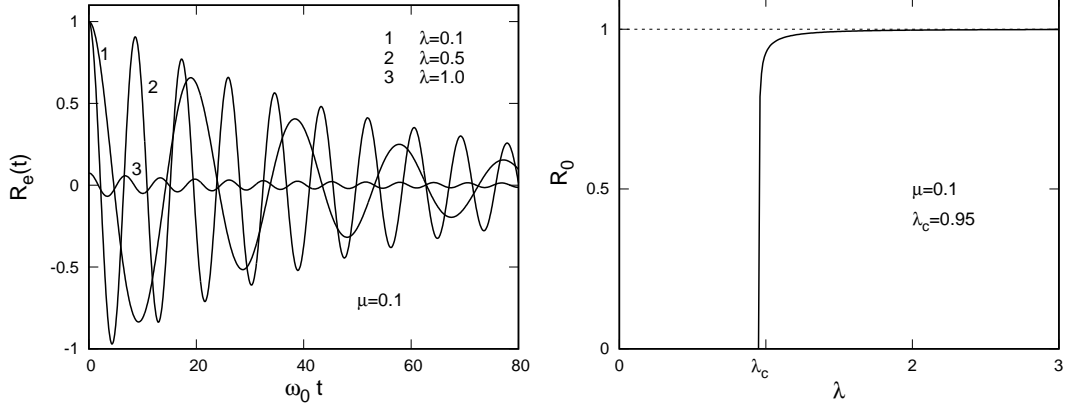

FIG. 6: Left: The ergodic component $R_e(t)$ of the relaxation function $R(t)$, see Eq. (137), for the mass ratio parameter $\mu = 0.1$ and several values of the frequency parameter $\lambda = (\omega/\omega_0)^2$. Right: The amplitude R_0 of the nonergodic component of $R(t)$ as a function of λ for $\mu = 0.1$.

One can verify that, similar to the case $\mu = 1$, the asymptotic expression (139) vanishes for $\lambda \leq \lambda_c$ and equals S_0 otherwise,

$$S_e(t) \rightarrow \begin{cases} 0, & \text{if } \lambda \leq \lambda_c, \\ S_0, & \text{if } \lambda > \lambda_c. \end{cases} \quad (140)$$

Then, as follows from Eqs.(138) and (140), $S(t)$ at long times vanishes for ergodic configurations and oscillates about zero for nonergodic ones,

$$S(t) \rightarrow \begin{cases} 0, & \text{if } \lambda \leq \lambda_c, \\ S_0 \cos \omega_* t, & \text{if } \lambda > \lambda_c. \end{cases} \quad (141)$$

Two other relaxation functions have the similar asymptotic forms.

The behavior of the ergodic and nonergodic components of the relaxation functions $G(t)$, $R(t)$, $S(t)$ for $\mu = 0.1$ is illustrated in Figs. 5, 6, and 7, respectively. The behavior is qualitatively similar to that for the case $\mu = 1$, discussed in the previous section. However, the ergodic components as functions of time decay faster, and the increase of the amplitudes of the nonergodic components (the initial increase for G_0) as functions of λ is steeper than for $\mu = 1$.

The above results for the relaxation functions hold for μ in the interval (130), i.e. for $0 < \mu < 2$ except $\mu = 1$. They do not directly apply for $\mu = 1$ because parameter β , given by Eq. (129), is not defined for $\mu = 1$. Yet one observes that the limit

$$\lim_{\mu \rightarrow 1} \beta(\lambda, \mu) = \frac{2\lambda}{\sqrt{4\lambda - 1}} \quad (142)$$

coincides with the result we found for $\beta = \omega_*/\omega_0$ for $\mu = 1$, see Eq. (107). With that value for β and $\mu = 1$, one finds that the expressions obtained in this section recover those we found in Sec. XI for $\mu = 1$. Therefore, if expression (129) for the function $\beta(\lambda, \mu)$ is defined at $\mu = 1$ by continuity,

$$\beta(\lambda, \mu) = \begin{cases} \left\{ \frac{1}{8(\mu-1)} \left(\mu^2 + 4\lambda(\mu-2) + \mu \sqrt{16\lambda^2 + 8\lambda(\mu-2) + \mu^2} \right) \right\}^{1/2}, & \text{if } \mu \neq 1, \\ \frac{2\lambda}{\sqrt{4\lambda-1}}, & \text{if } \mu = 1, \end{cases} \quad (143)$$

then the results of this sections hold for the whole range $\mu < 2$ including $\mu = 1$.

Summarizing the results of this and previous sections, we found that for the whole interval $\mu < 2$ the relaxation is ergodic for $\lambda \leq \lambda_c = 1 - \mu/2$ (the relaxation functions vanish at long times) and nonergodic for $\lambda > \lambda_c$ (the relaxation functions at long times oscillate about zero). The relaxation functions are given by Eqs. (135)-(138), which hold for the whole interval $\mu < 2$, while the frequency of the nonergodic component is $\omega_* = \beta \omega_0$, where $\beta(\alpha, \mu)$ is a continuous function determined by Eq. (143).

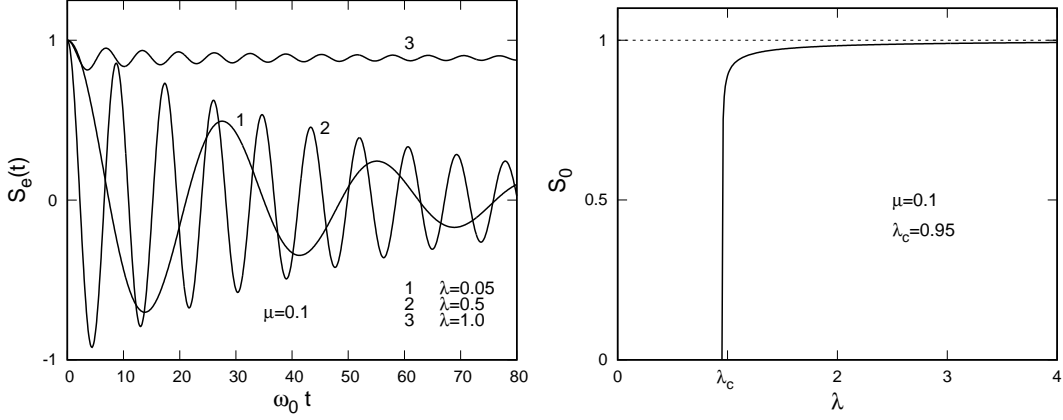

FIG. 7: Left: The ergodic component $S_e(t)$ of the relaxation function $S(t)$, see Eq. (138), for the mass ratio parameter $\mu = 0.1$ and several values of the frequency parameter $\lambda = (\omega/\omega_0)^2$. Right: The amplitude S_0 of the nonergodic component of $S(t)$ as a function of λ for $\mu = 0.1$.

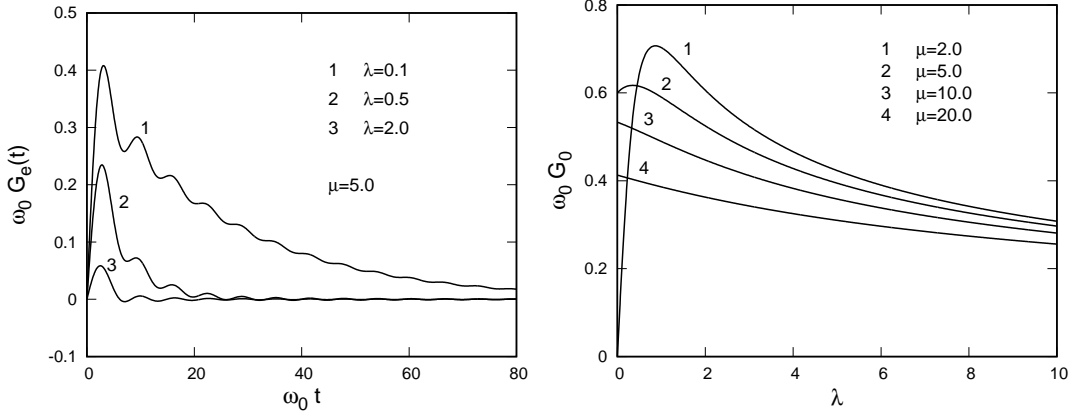

FIG. 8: Left: The ergodic component $G_e(t)$ of the relaxation function $G(t)$ for the mass ratio parameter $\mu = 5.0$ and several values of the oscillator frequency parameter $\lambda = (\omega/\omega_0)^2$. Right: The amplitude G_0 of the nonergodic component of $G(t)$ as a function of λ for several values $\mu \geq 2$.

XIII. RELAXATION FUNCTIONS FOR $\mu \geq 2$

In Sec. X we found that for $\mu \geq 2$ the function $\tilde{G}(s)$ has poles at $s = \pm i\omega_* = \pm i\beta\omega_0$ for any value of the frequency parameter $\lambda = (\omega/\omega_0)^2$. For that case, we obtain

$$\begin{aligned} G(t) &= G_e(t) + G_0 \sin \omega_* t, \\ R(t) &= R_e(t) + R_0 \cos \omega_* t, \\ S(t) &= S_e(t) + S_0 [\cos \omega_* t - 1], \end{aligned} \tag{144}$$

where the functions $G_e(t)$, $R_e(t)$, $S_e(t)$, the amplitudes G_0 , R_0 , S_0 , and the frequency ω_* are given by expressions of the previous section. Thus, for $\mu \geq 2$ the oscillator has only nonergodic configurations and does not thermalize for any λ , i.e. for any value of the oscillator frequency ω . Fig. 8 illustrates the behavior of $G_e(t)$ and $G_0(\lambda)$ for $\mu \geq 2$. Interestingly, for larger values of μ the interval of the initial increase of the function $G_0(\lambda)$ vanishes, and the function decreases monotonically for all λ .

XIV. ERGODIC TO NONERGODIC TRANSITIONS

As an application of the results, let us consider a setting when the oscillator frequency ω , and the frequency parameter $\lambda = (\omega/\omega_0)^2$, can be changed instantaneously by an external agent. Suppose that the mass ratio parameter is $\mu < 2$. In that case the oscillator has both ergodic configurations corresponding to $\omega \leq \omega_c$ and nonergodic ones corresponding to $\omega > \omega_c$, and the critical frequency is

$$\omega_c = \sqrt{\lambda_c} \omega_0 = \sqrt{1 - \mu/2} \omega_0. \quad (145)$$

Let assume that at $t < 0$ the oscillator is in an ergodic initial configuration with the frequency $\omega_i < \omega_c$. Then at $t = 0$ the oscillator is in thermal equilibrium with the average energy $E(\omega_i) = k_B T$ and the coordinate's variance $\langle q_i^2 \rangle = k_B T / (m\omega_i^2)$. At $t = 0$ the frequency is instantaneously changed, $\omega_i \rightarrow \omega$. If the new frequency ω is lower than or equal to ω_c , then the new configuration is also ergodic, so the oscillator, after some transient time, will reach again the equilibrium state with the same energy as for the initial configuration, $E(\omega) = k_B T$. We may call that process an ergodic to ergodic transition. Its characteristic feature is that, except for a transient initial relaxation, the oscillator average energy does not change. Using an ergodic to ergodic transition, an external agent can temporarily supply the oscillator with a large amount of energy, but the oscillator is unable to keep it for long; in the course of time the energy surplus dissipates into the bath. For an ergodic oscillator that is the only scenario.

Now suppose the new frequency is higher than the critical value, $\omega > \omega_c$. In that case the oscillator does not thermalize, but instead reaches at long times a cyclostationary state, characterized by the oscillatory time dependence of the relaxation and correlation functions. The average energy also oscillates in time and depends on both initial ω_i and final ω frequencies. One may say that the system undergoes an ergodic to nonergodic transition. Clearly the properties of such transition depend on the protocol of switching $\omega_i \rightarrow \omega$, or $\lambda_i \rightarrow \lambda$. The presented results allow us to discuss only the case when the switching occurs instantaneously. If instead the switching takes a finite time and is described by a smooth function $\lambda(t)$, then the properties of the cyclostationary final state would be different. That case is more difficult because requires to solve the generalized Langevin equation with a time-dependent oscillator frequency.

The average oscillator energy after the instantaneous switching $\omega_i \rightarrow \omega$ at time $t = 0$ is

$$E(t) = \frac{m\omega^2}{2} \langle q^2(t) \rangle + \frac{m}{2} \langle v^2(t) \rangle, \quad (146)$$

where the second moments of the coordinate and velocity are given by expressions (27). With equilibrium initial conditions

$$\langle q_i^2 \rangle = \frac{k_B T}{m\omega_i^2}, \quad \langle v_i^2 \rangle = \frac{k_B T}{m} \quad (147)$$

that expressions take the form

$$\begin{aligned} \langle q^2(t) \rangle &= \frac{k_B T}{m\omega_i^2} S^2(t) + \frac{k_B T}{m\omega^2} [1 - S^2(t)], \\ \langle v^2(t) \rangle &= \frac{k_B T}{m} [1 - \omega^2 G^2(t)] + \frac{k_B T}{m\omega_i^2} \omega^4 G^2(t). \end{aligned} \quad (148)$$

From Eqs. (146) and (148) we get

$$E(t) = k_B T + \frac{k_B T}{2} \left[\left(\frac{\omega}{\omega_i} \right)^2 - 1 \right] \left\{ S^2(t) + \omega^2 G^2(t) \right\}. \quad (149)$$

In terms of $\lambda = (\omega/\omega_0)^2$ and $\lambda_i = (\omega_i/\omega_0)^2$ the result reads

$$E(t) = k_B T + \frac{k_B T}{2} \left[\frac{\lambda}{\lambda_i} - 1 \right] \left\{ S^2(t) + \lambda \omega_0^2 G^2(t) \right\}. \quad (150)$$

For $\lambda \leq \lambda_c = 1 - \mu/2$, the relaxation functions have only ergodic components vanishing at long times

$$G(t) = G_e(t) \rightarrow 0, \quad S(t) = S_e(t) \rightarrow 0, \quad \text{as } t \rightarrow \infty \quad (151)$$

In that case, as expected, Eq. (150) shows that the oscillator's energy relaxes to the equilibrium value $k_B T$.

Now suppose $\lambda > \lambda_c$. In that case the relaxation functions have both ergodic and nonergodic components,

$$G(t) = G_e(t) + G_0 \sin \omega_* t, \quad S(t) = S_e(t) + S_0 [\cos(\omega_* t) - 1], \quad (152)$$

and the ergodic components have the asymptotic properties

$$G_e(t) \rightarrow 0, \quad S_e(t) \rightarrow S_0, \quad \text{as } t \rightarrow \infty. \quad (153)$$

Then, taking into account that $S_0 = \lambda \omega_0 G_0 / \beta$, see Eq. (138), one finds in the limit of long times the oscillator energy in the cyclostationary (*cs*) state:

$$E_{cs}(t) = k_B T + \frac{k_B T}{2} \left(\frac{\lambda}{\lambda_i} - 1 \right) (\omega_0 G_0)^2 \left\{ \left(\frac{\lambda}{\beta} \right)^2 \cos^2(\omega_* t) + \lambda \sin^2(\omega_* t) \right\}. \quad (154)$$

Instead of relaxing to the equilibrium value $k_B T$, the energy oscillates with time, and its lower bound exceeds the equilibrium value $k_B T$. After the additional averaging over time (denoted by the overbar), the energy of the oscillator in the cyclostationary state takes the form

$$\overline{E}_{cs} = k_B T + \frac{k_B T}{4} \left(\frac{\lambda}{\lambda_i} - 1 \right) \left[\left(\frac{\lambda}{\beta} \right)^2 + \lambda \right] (\omega_0 G_0)^2 \quad (155)$$

Here $\omega_0 G_0$ and $\beta = \beta(\lambda, \mu)$ are given by Eqs. (136) and (143), respectively.

The physical interpretation of the above results is as follows. When the external agent at $t = 0$ instantaneously increases the oscillator frequency $\omega_i \rightarrow \omega$, the oscillator (potential) energy is increased by the amount

$$\Delta E = \frac{m}{2} (\omega^2 - \omega_i^2) \langle q_i^2 \rangle = \frac{k_B T}{2} \left[\left(\frac{\omega}{\omega_i} \right)^2 - 1 \right] = \frac{k_B T}{2} \left(\frac{\lambda}{\lambda_i} - 1 \right). \quad (156)$$

Thus at $t = 0^+$ the oscillator, just kicked out of equilibrium, has the energy

$$E(0^+) = k_B T + \Delta E = k_B T + \frac{k_B T}{2} \left(\frac{\lambda}{\lambda_i} - 1 \right). \quad (157)$$

Note that this expression is consistent with the result (150) for $E(t)$ (taking into account that $G(0) = 0$ and $S(0) = 1$). If the new frequency ω corresponds to an ergodic configuration ($\omega \leq \omega_c$) then the excess energy ΔE is eventually dissipated into the bath, and the oscillator (now with the new frequency ω) returns to thermal equilibrium with the average energy $E = k_B T$. On the other hand, if the new frequency corresponds to a nonergodic configuration ($\omega > \omega_c$) then only a part of the excess energy ΔE dissipates into the bath. The dissipated energy $E_{diss} = E(0^+) - \overline{E}_{cs}(t)$ oscillates in time. Being averaged over time, it takes the form

$$\overline{E}_{diss} = E(0^+) - \overline{E}_{cs} = f(\lambda, \mu) \Delta E \quad (158)$$

with

$$f(\lambda, \mu) = 1 - \frac{1}{2} [(\lambda/\beta)^2 + \lambda] (\omega_0 G_0)^2, \quad (159)$$

and $\lambda > \lambda_c$. According to Eq. (158), the function $f(\lambda, \mu)$ has the meaning of the fraction of the initial excess energy ΔE eventually dissipated into the bath, so one expects $0 < f(\lambda, \mu) \leq 1$.

Consider specifically the case $\mu = 1$ when the expressions for β and G_0 , see Sec. XI, are less bulky,

$$\omega_0 G_0 = \frac{8\lambda - 4}{(4\lambda - 1)^{3/2}}, \quad \beta = \frac{2\lambda}{\sqrt{4\lambda - 1}}, \quad (160)$$

and $\lambda_c = 1 - \mu/2 = 1/2$. For that case $f(\lambda)$ takes the form

$$f(\lambda) = \frac{24\lambda^2 - 12\lambda + 1}{(4\lambda - 1)^3}. \quad (161)$$

One observes that $f(\lambda)$ takes the value 1 for $\lambda = \lambda_c$ and monotonically decreases as $1/\lambda$. This means that for a nonergodic configuration with $\lambda > \lambda_c$ only a part $f \Delta E$ of the excess energy ΔE is dissipated into the bath at long

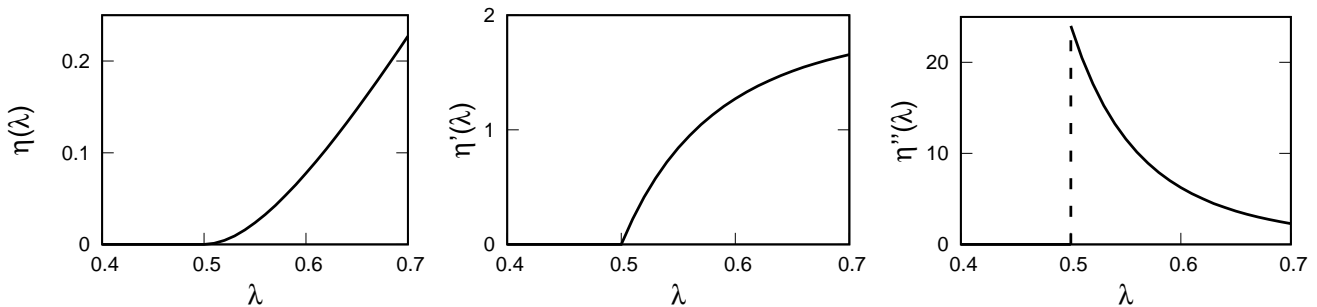

FIG. 9: The order parameter $\eta(\lambda)$, its first $\eta'(\lambda)$ and second $\eta''(\lambda)$ derivatives for $\mu = 1$ and $\lambda_i = 0.25$ near the critical point $\lambda_c = 0.5$.

times, another part $(1 - f)\Delta E$ remains localized in the oscillator. The localized energy monotonically increases with λ and can be arbitrary large.

In our view, the ability to keep permanently the energy exceeding the thermal equilibrium value $k_B T$, in violation of the equipartition theorem, is the key property of the nonergodic oscillator. It is tempting to view configurations with $\lambda \leq \lambda_c$ and $\lambda > \lambda_c$ as two “phases” and to consider ergodic to nonergodic transitions $\lambda_i \rightarrow \lambda$ (with $\lambda_i < \lambda_c$) as a phase transition with the dimensionless order parameter

$$\eta(\lambda) = \frac{\overline{E}_{cs}(\lambda) - k_B T}{k_B T}. \quad (162)$$

In the ergodic phase ($\lambda \leq \lambda_c$) the order parameter vanishes, while in the nonergodic phase ($\lambda > \lambda_c$) it is non-zero and increases with λ ,

$$\eta(\lambda) = \begin{cases} 0, & \text{if } \lambda \leq \lambda_c, \\ \frac{1}{4} \left(\frac{\lambda}{\lambda_i} - 1 \right) \left[\left(\frac{\lambda}{\beta} \right)^2 + \lambda \right] (\omega_0 G_0)^2, & \text{if } \lambda > \lambda_c. \end{cases} \quad (163)$$

For $\mu = 1$, when G_0 and β are given by Eq. (160) (and $\lambda_c = 1/2$), the explicit dependence of the order parameter on λ is

$$\eta(\lambda) = \begin{cases} 0, & \text{if } \lambda \leq \lambda_c, \\ c(\lambda, \lambda_i) (\lambda - \lambda_c)^2, & \text{if } \lambda > \lambda_c, \end{cases} \quad (164)$$

with

$$c(\lambda, \lambda_i) = \frac{4(8\lambda - 1)}{(4\lambda - 1)^3} \left(\frac{\lambda}{\lambda_i} - 1 \right). \quad (165)$$

Since $\eta(\lambda)$ and its first derivatives $\eta'(\lambda)$ are continuous and the second derivative $\eta''(\lambda)$ is discontinuous at $\lambda = \lambda_c$, see Fig. 9, there is a resemblance between ergodic to nonergodic transitions and conventional phase transitions of second order. Note that the presented study is limited to the case when the switching $\lambda_i \rightarrow \lambda$ occurs instantaneously, and there is no reason to believe that the exponent 2 in Eq. (164) would be the same if the switching takes a finite time.

XV. CONCLUSION

In this paper we have evaluated the relaxation and correlation functions for a Brownian oscillator described by the generalized Langevin equation with the dissipation kernel of the form (9). The oscillator may have both ergodic and nonergodic configurations (for $\mu < 2$), or only nonergodic configurations (for $\mu \geq 2$). In ergodic configurations, which correspond to lower oscillator frequencies $\omega \leq \omega_c = \sqrt{1 - \mu/2} \omega_0$, the oscillator relaxes to thermal equilibrium with the external bath. In nonergodic configurations, corresponding to higher oscillator frequencies $\omega > \omega_c$, the

oscillator does not reach thermal equilibrium (unless prepared in equilibrium initially), but evolves to non-equilibrium cyclostationary states in which the average oscillator's energy oscillates with time and exceeds the equilibrium value $k_B T$ prescribed by the equipartition theorem.

In general, we observed that nonergodic configurations emerge when the spectrum of the bath's modes is bounded from the above. That is not the case for gas-like environments, but characteristic for lattices. The specific model considered here corresponds to an isotope atom embedded in an infinite or semi-infinite harmonic chain (Rubin's model) and subjected to the external harmonic potential.

In the limit of zero oscillator frequency $\omega \rightarrow 0$, or $\lambda = (\omega/\omega_0)^2 \rightarrow 0$, the presented results recover that for Rubin's model. In particular, for the relaxation function $R(t)$, which is also the normalized velocity autocorrelation function in equilibrium, in the limit $\lambda \rightarrow 0$ the presented results take the form

$$R(t) = \begin{cases} R_e(t), & \text{if } \mu < 2, \\ R_e(t) + R_0 \cos(\omega_* t), & \text{if } \mu \geq 2. \end{cases} \quad (166)$$

This reflects that for $\mu < 2$ the condition of nonergodic relaxation $\lambda > \lambda_c = 1 - \mu/2$ cannot be satisfied when $\lambda \rightarrow 0$, and that for $\mu \geq 2$ the relaxation is nonergodic for any λ , including the limit $\lambda \rightarrow 0$. As follows from Eq.(137), the ergodic component of $R(t)$ in the limit $\lambda \rightarrow 0$ reads

$$R_e(t) = \frac{4\mu}{\pi} \int_0^1 \frac{\sqrt{1-x^2} \cos(x\omega_0 t) dx}{4(1-\mu)x^2 + \mu^2}. \quad (167)$$

In particular, for $\mu = 2$, which corresponds to the case of a tagged atom in a bulk of the uniform harmonic chain, we recover the well-known result [19]

$$R(t) = R_e(t) = \frac{2}{\pi} \int_0^1 \frac{\cos(x\omega_0 t) dx}{\sqrt{1-x^2}} = J_0(\omega_0 t).$$

For the amplitude and frequency of the nonergodic component we get from Eqs. (129) and (137) in the limit $\lambda \rightarrow 0$

$$R_0 = \frac{\mu - 2}{\mu - 1}, \quad \omega_* = \frac{\mu}{2\sqrt{\mu - 1}} \omega_0. \quad (168)$$

As expected, Eqs. (166)-(168) coincide with the known results for Rubin's model, see Eq. (A28) in Ref. [9] (note that parameter Q of Ref. [9] and parameter μ used in this paper are related as $Q = 2/\mu - 1$).

The relaxation functions evaluated in the paper allow us to describe the evolution of the oscillator for $t > 0$ with a frequency which is either fixed or switched instantaneously at $t = 0$. The latter setting allows one to study a particular type of ergodic to nonergodic transitions. An interesting extension would be to study such transitions when the oscillator frequency is tuned continuously during a finite time. Such an extension would be of interest, in particular, from the perspective of the fluctuation theorems [31]. Their proofs often assume that the system is ergodic for all values of the tunable parameter $\lambda(t)$ [32, 33]. Not much is currently known about what happen if that is not the case (see, however, [34]). Another interesting application is Brownian engines [35-37]. A nonergodic oscillator in a cyclostationary state may store an arbitrary amount of energy. That property may be used beneficially in designing Brownian machines. More generally, the parametric erodic to nonergodic transitions may be of interest because algorithms involving periodically correlated (cyclostationary) processes in nonergodic configurations are often advantageous relative to those based on stationary processes characteristic for ergodic regimes [25].

It might be tempting to seek implications of the presented results in the context of experiments with colloidal particles held in optical traps. In a version called the capture experiment the strength of the optical trap (the oscillator frequency in our model) is changed instantaneously, and the relaxation of the particle's position and velocity is recorded [38, 39]. This is precisely the setting described by the relaxation functions obtained in this paper. However, when the bath is formed by a lattice, nonergodic configurations correspond to frequencies of order of ω_0 which, even for soft lattices, is several orders of magnitude higher than frequencies used in optical trap experiments with colloidal particles in gaseous and aqueous environments.

Appendix A: Evaluation of $I_0(t)$

In this Appendix we evaluate the integral I_0 defined by Eq. (110). Consider the integral

$$I_0^+(t) = \frac{1}{2\pi i} \int_{\Gamma_0^+} e^{st} \tilde{G}(s) ds = \frac{1}{\pi i} \int_{\Gamma_0^+} \frac{e^{st} ds}{(2-\mu)s^2 + \mu s f_1(s) + 2\lambda\omega_0^2} \quad (A1)$$

along the right shore of the branch cut, see Fig. 1, in the direction from $i\omega_0$ to $-i\omega_0$. Recall that $f_1(t)$ is the physical branch of the function $f(s) = \sqrt{s^2 + \omega_0^2}$ and can be evaluated as

$$f_1(s) = \sqrt{r_1 r_2} e^{i\frac{\theta_1 + \theta_2}{2}} \quad (\text{A2})$$

in terms of polar coordinates defined in Fig.1 with both polar angles $\theta_{1,2}$ in the range $(-3\pi/2, \pi/2]$, see Eqs. (64) and (65). For points $s \in \Gamma_0^+$ once can use the parametrization $s = iy + \epsilon$ with $-\omega_0 \leq y \leq \omega_0$; then in the limit $\epsilon \rightarrow 0$ one finds:

$$\theta_1 = -\frac{\pi}{2}, \quad \theta_2 = \frac{\pi}{2}, \quad r_1 = \omega_0 - y, \quad r_2 = \omega_0 + y, \quad (\text{A3})$$

Therefore

$$f_1(s) = \sqrt{\omega_0^2 - y^2} \quad \text{for } s \in \Gamma_0^+, \quad (\text{A4})$$

and

$$I_0^+(t) = -\frac{1}{\pi} \int_{-\omega_0}^{\omega_0} \frac{e^{iyt} dy}{(\mu - 2)y^2 + i\mu y \sqrt{\omega_0^2 - y^2} + 2\lambda\omega_0^2}. \quad (\text{A5})$$

In a similar manner we can evaluate the integral

$$I_0^-(t) = \frac{1}{2\pi i} \int_{\Gamma_0^-} e^{st} \tilde{G}(s) ds = \frac{1}{\pi i} \int_{\Gamma_0^-} \frac{e^{st} ds}{(2 - \mu)s^2 + \mu s f_1(s) + 2\lambda\omega_0^2} \quad (\text{A6})$$

along the left shore of the branch cut in the direction from $-i\omega_0$ to $i\omega_0$. In that case

$$\theta_1 = -\frac{\pi}{2}, \quad \theta_2 = -\frac{3\pi}{2}, \quad r_1 = \omega_0 - y, \quad r_2 = \omega_0 + y. \quad (\text{A7})$$

This gives

$$f_1(s) = -\sqrt{\omega_0^2 - y^2} \quad \text{for } s \in \Gamma_0^-, \quad (\text{A8})$$

and

$$I_0^-(t) = \frac{1}{\pi} \int_{-\omega_0}^{\omega_0} \frac{e^{iyt} dy}{(\mu - 2)y^2 - i\mu y \sqrt{\omega_0^2 - y^2} + 2\lambda\omega_0^2}. \quad (\text{A9})$$

Considering the sum $I_0 = I_0^+ + I_0^-$ and evaluating its real and imaginary parts, one finds that the latter is zero due to symmetry, and the result is

$$I_0(t) = -\frac{4\mu}{\pi} \int_0^{\omega_0} \frac{y \sqrt{\omega_0^2 - y^2} \sin(yt) dy}{4(1 - \mu)y^4 + [4\lambda(\mu - 2) + \mu^2]\omega_0^2 y^2 + 4\lambda^2\omega_0^4}. \quad (\text{A10})$$

It is convenient to present the result using the dimensionless integration variable $x = y/\omega_0$,

$$I_0(t) = -\frac{4\mu}{\pi\omega_0} \int_0^1 \frac{x \sqrt{1 - x^2} \sin(x\omega_0 t) dx}{4(1 - \mu)x^4 + [4\lambda(\mu - 2) + \mu^2]x^2 + 4\lambda^2}. \quad (\text{A11})$$

This result holds for arbitrary μ .

Appendix B: Evaluation of residues

Here we evaluate the residues in Eqs. (112) and (131) for the relaxation function $G(t)$. One can verify that for arbitrary μ the poles $s_{1,2} = \pm i\omega_*$ of the transform $\tilde{G}(s)$ are of order one (simple poles). Then the residue of $e^{st}\tilde{G}(s)$ at s_1 is evaluated as follows:

$$\text{Res}[e^{st}\tilde{G}(s), s_1] = \lim_{s \rightarrow s_1} e^{st}\tilde{G}(s)(s - s_1) = e^{i\omega_* t} \lim_{s \rightarrow i\omega_*} \tilde{G}(s)(s - i\omega_*) = e^{i\omega_* t} \lim_{s \rightarrow i\omega_*} \frac{2(s - i\omega_*)}{(2 - \mu)s^2 + \mu s f_1(s) + 2\lambda\omega_0^2}.$$

Applying L'Hospital's Rule yields

$$\text{Res}[e^{st}\tilde{G}(s), s_1] = e^{i\omega_*t} \lim_{s \rightarrow i\omega_*} \frac{2f_1(s)}{\mu s^2 + 2(2-\mu)s f_1(s) + \mu f_1^2(s)}. \quad (\text{B1})$$

Then, recalling Eq. (67), $f_1(i\omega_*) = i\sqrt{\omega_*^2 - \omega_0^2}$, one gets

$$\text{Res}[e^{st}\tilde{G}(s), s_1] = \frac{2i\sqrt{\omega_*^2 - \omega_0^2}}{\mu(\omega_0^2 - 2\omega_*^2) - 2(2-\mu)\omega_*\sqrt{\omega_*^2 - \omega_0^2}} e^{i\omega_*t} \quad (\text{B2})$$

Similarly, for the residue at the second pole $s_2 = -i\omega_*$ we obtain

$$\text{Res}[e^{st}\tilde{G}(s), s_2] = \frac{-2i\sqrt{\omega_*^2 - \omega_0^2}}{\mu(\omega_0^2 - 2\omega_*^2) - 2(2-\mu)\omega_*\sqrt{\omega_*^2 - \omega_0^2}} e^{-i\omega_*t}. \quad (\text{B3})$$

The sum of residues is

$$\text{Res}[e^{st}\tilde{G}(s), s_1] + \text{Res}[e^{st}\tilde{G}(s), s_2] = \frac{4\sqrt{\omega_*^2 - \omega_0^2}}{\mu(2\omega_*^2 - \omega_0^2) + 2(2-\mu)\omega_*\sqrt{\omega_*^2 - \omega_0^2}} \sin(\omega_*t), \quad (\text{B4})$$

These expressions hold for arbitrary μ , although the frequency $\omega_* = \omega_*(\lambda)$ has different forms for $\mu = 1$ and for $\mu \neq 1$. Introducing the dimensionless function $\beta(\lambda) = \omega_*(\lambda)/\omega_0$, the above expression can be written as

$$\text{Res}[e^{st}\tilde{G}(s), s_1] + \text{Res}[e^{st}\tilde{G}(s), s_2] = \frac{1}{\omega_0} \frac{4\sqrt{\beta^2 - 1}}{\mu(2\beta^2 - 1) + 2(2-\mu)\beta\sqrt{\beta^2 - 1}} \sin(\omega_*t). \quad (\text{B5})$$

-
- [1] I.V.L. Costa, R. Morgado, M.V.B.T. Lima and F.A. Oliveira, *The fluctuation-dissipation theorem fails for fast superdiffusion*, Europhys. Lett 63,173 (2003).
- [2] J.D. Bao, P. Hanggi, and Y.Z. Zhuo, *Non-Markovian Brownian dynamics and nonergodicity*, Phys. Rev. E 72, 061107 (2005).
- [3] L.C. Lapas, R. Mogrado, M.H. Vainstein, J.M. Rubi, and F.A. Oliveira, *Khinchin theorem and anomalous diffusion*, Phys. Rev. E 101, 230602 (2008).
- [4] R. Morgado, F.A. Oliveira, G.G. Batrouni, and A. Hansen, *Relation between anomalous and normal diffusion in systems with memory*, Phys. Rev. Lett. 89, 100601 (2002).
- [5] P. Siegle, I. Goychuk, P. Talkner, and P. Hanggi, *Markovian embedding of non-Markovian superdiffusion*, Phys. Rev. E 81, 011136 (2010).
- [6] E.W. Montroll and R.B. Potts, *Effect of defects on lattice vibrations*, Phys. Rev. 100, 525 (1955).
- [7] E. Teramoto and S. Takeno, *Time dependent problems of the localized lattice vibration*, Prog. Theor. Phys. 24, 1349 (1960).
- [8] S. Kashiwamura, *Statistical dynamical behaviors of a one-dimensional lattice with an isotopic impurity*, Prog. Theor. Phys. 27, 571 (1962).
- [9] R. Rubin, *Momentum autocorrelation functions and energy transport in harmonic crystals containing isotopic defects*, Phys. Rev. 131, 964 (1963).
- [10] A. Aghamohammadi, M.E. Foulaadvand, M.H. Yaghoubi, and A.H. Mousavi, *Normal mode of a defected linear system of beaded springs*, Am. J. Phys. 85, 193 (2017).
- [11] S. Flach and A.V. Gorbach, *Discrete breathers — Advances in theory and applications*, Phys. Rep. 467, 1 (2008).
- [12] M. Morita M and H. Mori, *Kinetic and hydrodynamic scalings in an exactly-soluble model for the Brownian motion*, Prog. Theor. Phys. 56, 498 (1976).
- [13] S. T. Smith and R. Onofrio, *Thermalization in open classical systems with finite heat baths*, Eur. Phys. J. B 61, 271 (2008).
- [14] Q. Wei, S. T. Smith, and R. Onofrio, *Equilibrium states of a test particle coupled to finite-size heat baths*, Phys. Rev. E 79, 031128 (2009).
- [15] F. Ishikawa F and S. Todo, *Localized mode and nonergodicity of a harmonic oscillator chain*, Phys. Rev. E 98, 062140 (2018).
- [16] A. Dhar and K. Wagh, *Equilibration problem for the generalized Langevin equation*, EPL 79, 60003 (2007).
- [17] A.V. Plyukhin *Non-Clausius heat transfer: The example of harmonic chain with an impurity*, J. Stat. Mech. 063212 (2020).
- [18] A.V. Plyukhin, *Non-Clausius heat transfer: The method of non-stationary Langevin equation*, Phys. Rev. E 102, 052119 (2020).
- [19] R. Zwanzig, *Nonequilibrium Statistical Mechanics*, Oxford University Press, NY (2001).
- [20] A.V. Plyukhin, *Nonergodic solutions of the generalized Langevin equation*, Phys. Rev. E 83, 062102 (2011).

- [21] U. Weiss, *Quantum Dissipative Systems*, World Scientific, Singapore (2008).
- [22] A.M. Yaglom, *Correlation Theory of Stationary and Related Random functions*, Vols. 1 and 2, Springer, New York, 1986.
- [23] W.A. Gardner, *Introduction to Random Processes with Applications to Signals and Systems*, Macmillan, New York, 1985.
- [24] W.A. Gardner, A. Napolitano, and L. Paura, *Cyclostationarity: Half a century of research*, Signal Processing 86, 639 (2006).
- [25] E. Serpedina, F. Pandurua, I. Saria, and G. Giannakis, *Bibliography on cyclostationarity*, Signal Processing 85, 2233 (2005).
- [26] K.G. Wang and M. Tokuyama, *Nonequilibrium statistical description of anomalous diffusion*, Physica A 265, 341 (1999).
- [27] A.D. Vinales and M.A. Desposito, *Anomalous diffusion: Exact solution of the generalized Langevin equation for harmonically bounded particle*, Phys. Rev. E 73, 016111 (2006).
- [28] M.A. Desposito and A.D. Vinales, *Subdiffusive behavior in a trapping potential: Mean square displacement and velocity autocorrelation function*, Phys. Rev. E 80, 021111 (2009).
- [29] I. Goychuk, *Viscoelastic subdiffusion: generalized Langevin equation approach*, Adv. Chem. Phys. 150, 187 (2012).
- [30] L. Debnath, *The double Laplace transforms and their properties with applications to functional, integral and partial differential equations*, Int. J. Appl. Comput. Math 2, 223-241 (2016).
- [31] U. Seifert, *Stochastic thermodynamics, fluctuation theorems and molecular machines*, Rep. Prog. Phys. 75, 126001 (2012).
- [32] C. Jarzynski, *Nonequilibrium equality for the free energy difference*, Phys. Rev. Lett. 78, 2690 (1997).
- [33] T. Speck and U. Seifert, *Jarzynski relation, fluctuation theorems, and stochastic thermodynamics for non-Markovian processes*, J. Stat. Mech. L09002 (2007).
- [34] H. Hasegawa, *Responses to applied forces and the Jarzynski equality in classical oscillator systems coupled to finite baths: An exactly solvable nondissipative nonergodic model*, Phys. Rev. E 84, 011145 (2011).
- [35] T. Schmiedl and U. Seifert, *Efficiency at maximum power: An analytically solvable model for stochastic heat engines*, EPL 81, 20003 (2007).
- [36] I.A. Martinez, E. Roldan, L. Dinis, D. Petrov, J.M.R. Parrondo, and R.A. Rica, *Brownian Carnot engines*, Nature Physics 12, 67–70 (2016).
- [37] A.L.L. Stable, C.E. Fernandez Noa, W.G.C. Oropesa, and C.E. Fiore, *Thermodynamics of collisional models for Brownian particles: General properties and efficiency*, Phys. Rev. Research 2, 043016 (2020).
- [38] D.M. Carberry, J.C. Reid, G.M. Wang, E.M. Sevick, D.J. Searles, and D.J. Evans, *Fluctuations and irreversibility: An experimental demonstration of a second-law-like theorem using a colloidal particle held in an optical trap*, Phys. Rev. Lett. 92, 140601 (2004).
- [39] D.M. Carberry, M.A.B. Baker, G.M. Wang, E.M. Sevick, and D.J. Evans, *An optical trap experiment to demonstrate fluctuation theorems in viscoelastic media*, J. Opt A: Pure Appl. Opt. 9, S204-S214 (2007).