

# Degrees of Freedom Analysis of Mechanisms using a Novel Zebra Crossing Method

Rajashekhar V S<sup>1</sup>

*Project Assistant, Aerospace Engineering Department, Indian Institute of Science, Bangalore, Karnataka, India*

Debasish Ghose

*Professor, Aerospace Engineering Department, Indian Institute of Science, Bangalore, Karnataka, India*

---

## Abstract

Mobility, which is a basic property, has to be analyzed to find the degrees of freedom of a mechanism. A novel and easy to implement method for calculation of degrees of freedom in a mechanism is proposed in this work. The mechanism is represented in a way that resembles a zebra crossing. An algorithm is proposed which is used to determine the mobility from the zebra crossing. This algorithm takes into account the number of patches between the black patches, the number of joints attached to the fixed link and the number of loops in the mechanism. A number of cases have been discussed, which fail to give the desired results using the widely used classical Kutzbach-Grubler formula but are amenable to the Zebra Crossing method proposed in this paper. We also show via an extensive comparison with other methods that the proposed method is comparable to, and often better in terms of its implementability than, the best methods available in the literature.

*Keywords:* Mobility, Degrees of Freedom, serial mechanisms, Parallel Mechanism, Multiloop Mechanism, Planar Mechanism, Spatial Mechanism

---

## 1. Introduction

The degrees of freedom (DoF) or mobility calculation is an important property of mechanisms. It is defined by International Federation for the Promotion of Mechanism and Machine Science (IFToMM) as the number of independent coordinates needed to define the configuration of a kinematic chain or mechanism [1]. A literature review of the DoF works done in the past 150 years is given in [2]. The Chebychev-Grubler-Kutzbach criterion is widely used to determine the DoF of mechanisms. Many mechanisms do not obey the Chebychev-Grubler-Kutzbach criterion for calculating the DoF [3]. Quite often the classical quick formula fails to predict the correct number of DoF in modern mechanisms [4]. Therefore, there is a need to find a quick formula to find the DoF of a mechanism that can be applied to modern multi-loop mechanisms, parallel manipulators, and other classical mechanisms which cannot otherwise be calculated using the existing quick methods.

---

*Email addresses:* [vsrajashekhar@gmail.com](mailto:vsrajashekhar@gmail.com) (Rajashekhar V S), [dghose@iisc.ac.in](mailto:dghose@iisc.ac.in) (Debasish Ghose)

<sup>1</sup>Corresponding author

The past two decades have seen mobility formulas being proposed for a particular family of mechanisms. It can be observed that the ways to determine the mobility of a mechanism can be broadly classified into three methods as mentioned in [5]. The most commonly used method is the quick formulas that takes into account the number of links, joints, loops and other parameters of the mechanism. The second method is finding the rank of the Jacobian matrix which gives the DoF of the mechanism. The third method is the usage of screw theory and other mathematical techniques. They fail to calculate the DoF of modern mechanisms such as the Cartesian Parallel Manipulator. A few of the works done in the past two decades are summerized here.

A formula [6] for DoF of parallel mechanisms and multiloop spatial mechanisms using vector algebra and theory of sets has been proposed. In [4] a method based on screw theory has been proposed to find the mobility of mechanisms. Lie algebra is used to determine the mobility criterion of parallel platforms in [7]. The mobility of spatial mechanisms is calculated by considering polyhedral model [8]. Using Jacobian matrices, mobility of parallel mechanisms can be determined [9]. The DoF for complex spatial mechanisms is calculated by introducing a theory and the concept of configuration degrees of freedom [10]. Mobility of multi-loop mechanisms is found by a combination of bio-inspired cell division method and screw theories [11]. A mobility condition is obtained using Groebner basis which takes into account the dimensional and positional parameters of the links [12]. Similarly, the effect of dimensions of links in a mechanism on the mobility is discussed in [13]. A constraint graph that allows representation of all the constraints which includes multiple joints is introduced in [14] from which the mobility can be determined. Fast and accurate calculation of mobility of overconstraint planar mechanisms are given in [15] by introducing new concepts and theories. The concept of generic mobility which takes into consideration the presence of link imperfection is introduced in [5]. The mobility in kinematic chains cannot be determined correctly using the velocity analysis but can be determined when combined with Lie algebra [16]. The dynamic models that were less used previously were used to establish the mobility criteria in multi-loop mechanisms [17]. A method to find the DoF of the mechanism by using the Macaulay matrices at a given configuration is proposed [18]. The deployable assembly mechanisms have modules that are identical. The concept of null space is used to find the mobility of such mechanisms [19]. Identification of redundant and passive mobilities using the intersection of screw manifolds in parallel manipulators is proposed in [20]. The complex ball mechanism is decomposed and analyzed using the screw system analysis [21]. A method for analyzing limited degrees of freedom parallel manipulators, using geometric algebra, is proposed in [22]. Mobility of overconstrained parallel mechanisms using Grassmann-Cayley algebra is given in [23]. The mobility of parallel manipulators can be calculated by analyzing the pattern of the transformation matrix [24]. Screw theory is used to find the mobility of single-loop mechanisms [25], parallel mechanisms [26], overconstrained parallel mechanisms [27], and spatial mechanisms [28]. The mobility of single-loop overconstrained mechanisms is calculated using Jacobian matrices [29]. The mobility is calculated by finding the rank of position and orientation characteristic equation of single loop mechanisms in [30].

It can be observed that many works have focused on screw theory [4, 20, 21, 25, 26, 27, 28] and on finding the rank of Jacobian matrices [9, 29] as a base for determining the DoF of mechanisms, while the quick methods have not received much attention in the past two decades. It can be noted that works have emerged taking into consideration the dimensions of the links [12, 13] for finding the DoF. The other areas of mathematics have been explored to find the DoF including vector algebra and theory of sets [6], Lie algebra [7, 16] and Grassmann-Cayley algebra [23]. Bio-inspired methods have also started to emerge [11].

The quick methods fail in certain cases where the mechanisms have loops. This failure of

identifying the right degree of freedom is due to the inability to find the kinematically dependant loops in the mechanisms. A detailed explanation for this is given in [2]. Hence a detailed analysis is required for identifying the right degree of freedom. There are cases [31] where these methods also fail to give the right degree of freedom. The Zebra Crossing method (a quick method) proposed in this work provides the right degree of freedom even for mechanisms that get the wrong results using the formulas available in the literature.

## 2. The Zebra Crossing Algorithm

The zebra crossing algorithm helps in finding the degrees of freedom for a mechanism. The given mechanism is converted into a zebra crossing diagram consisting of black, white and grey patches. The degrees of freedom is found based on the number of loops in the mechanism and on counting the number of black, white, and grey patches.

### 2.1. Conversion to Zebra Crossing diagram

The given mechanism is first converted into a Zebra Crossing diagram. The various elements of the Zebra Crossing diagram are shown in Figure 1 and 2. In Figure 1 we show how the unary, binary and ternary joints are represented in Zebra Crossing diagram. In Figure 2 we show how the links, binary, ternary and quaternary links are represented in Zebra Crossing diagram.







Rule	Terminology	Graphical Representation	Zebra Crossing Diagram
1	Unary Joint		
2	Binary Joint		
3	Ternary Joint		

Figure 1: Representation of joints for the Zebra Crossing diagram













Rule	Terminology	Graphical Representation	Zebra Crossing Diagram
4	Link		
5	Binary link		
6	Ternary link		
7	Quaternary link		
8	Pentenary link		
9	Hexanary link		

Figure 2: Representation of links for the Zebra Crossing diagram

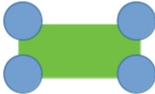
### 2.2. Rules for converting a mechanism diagram to Zebra Crossing diagram

75 It is well known that the mechanism is a collection of links and joints. It can either be open loop or closed loop in nature. For open loop mechanisms the number of joints will be equal to the number of degrees of freedom. For closed loop mechanisms the number of degrees of freedom will always be less than the number of joints. The following are the nine rules that govern the conversion of the mechanism diagram to the Zebra Crossing diagram. This is shown in Figure 1 and Figure 2.

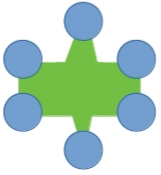
80 *Rule 1:* It represents the unary joint which has one degree of freedom. It can be revolute joint or prismatic joint. In the zebra crossing diagram it is represented by a single black patch.

*Rule 2:* It represents the binary joint which has two degrees of freedom. It can be cylindrical joint or universal joint. In the zebra crossing diagram it is represented by a single grey patch in

between two black patches.

85 *Rule 3:* It represents the ternary joint which has three degrees of freedom. It can be spherical joint or planar joint. In the zebra crossing diagram it is represented by two grey patches in between three black patches.

*Rule 4:* It represents the link of the mechanism. In the zebra crossing diagram it is represented by a white patch.

90 *Rule 5:* It represents the binary link of the mechanism. This means that two joints can be attached to the link. In the zebra crossing diagram it is represented by a white patch in between two black patches.

*Rule 6:* It represents the ternary link of the mechanism. This means that three joints can be attached to the link. In the zebra crossing diagram it is represented by a white patch in between 95 three black patches.

*Rule 7:* It represents the quaternary link of the mechanism. This means that four joints can be attached to the link. In the zebra crossing diagram it is represented by a white patch in between four black patches.

100 *Rule 8:* It represents the pentanary link of the mechanism. This means that five joints can be attached to the link. In the zebra crossing diagram it is represented by a white patch surrounded by five black patches.

*Rule 9:* It represents the hexanary link of the mechanism. This means that six joints can be attached to the link. In the zebra crossing diagram it is represented by a white patch surrounded by six black patches.

105 The conversion to the Zebra Crossing diagram ends once the last link or the white patch is reached. This white patch is the fixed link.

### 2.3. Analogy between mechanisms, graphs and zebra crossing algorithm

In [32], graph theory is used as a tool to represent mechanisms. A comparison is made here between the various parameters of a mechanism, graph theory, and the proposed Zebra Crossing 110 method. The links in the mechanism is equivalent to the vertices of the graph and white patch in the zebra crossing. The joints in the mechanism is equivalent to the edges in the graph and black patch in the zebra crossing. The other parameters comparing the mechanism with the graph theory and zebra crossing are listed in Table 1.

Table 1: A analogy between mechanisms, graphs, and zebra crossing method

<b>Mechanism</b>	<b>Graph Theory</b>	<b>Zebra Crossing Method</b>
Links	Vertices	White patch
Joints	Edges	Black Patch
Number of links having “i” joints	Number of vertices of degree “i”	Number of white patches connected to “i” black patches
Number of joints on link “i”	Degree of vertex “i”	Number of black patches connected to ”i” white patches
Loops=Joints - Links + 1	Loops=Edges - Vertices + 1	Loops=Total Black Patches - Total White Patches + 1
Isomorphic mechanisms	Isomorphic graphs	Isomorphic zebra crossing

115 In [32], although graph theory is used in enumeration of the mechanisms, their degrees of freedom is calculated using the Kutzbach-Grubler formula. It can be seen that the number of loops

are calculated by forming similar formulas from links and joints in graph theory and zebra crossing algorithm.

#### 2.4. The zebra crossing algorithm

The zebra crossing algorithm is summarized in Figure 3. The algorithm is explained as follows.

120 Step 1: Represent the mechanism by sketching clearly its links and joints.

Step 2: Represent the mechanism by using zebra crossing diagram using Rules 1 – 9 given above.

Step 3: Count the number of black, grey and white patches in the zebra crossing diagram. Use Equation 1 to find the total number of loops in the mechanism.

$$L = B - (W + G) + 1 \quad (1)$$

where,

125  $L$  = Number of loops in the mechanism

$B$  = Number of black patches

$W$  = Number of white patches

$G$  = Number of grey patches

130 Step 4: If the number of loops are 0, then it is a open loop mechanism. The degrees of freedom equal the number of black patches in the zebra crossing diagram.

$$M = B \quad (2)$$

Step 5: If the number of loops are more than 0, then it is a closed loop mechanism. Find whether the mechanism can have a configuration where its links and joints lie on a plane.

135 Step 6: If the mechanism can be placed on a plane in atleast one configuration and has black, grey, and white patches use Equation 3 below to find its degrees of freedom.

$$M = N_s - (4 \times L) - J_f + 1 \quad (3)$$

where,

$M$  = Degrees of freedom of the mechanism

$N_s$  = Number of patches between the black patches

$L$  = Number of loops in the mechanism

140  $J_f$  = Number of joints attached to the ground link

Step 7: If the mechanism cannot be placed on a plane, that is the mechanism is spatial in configuration, and has black, grey and white patches or only black and grey patches, then use Equation 4 to find its degree of freedom. If it is a parallel manipulator, then the manipulator platform is treated as link. When counting the number of white patches, this white patch is assigned a number which is one less than the number of legs in the parallel manipulator.

$$M = N_w - L - J_f + 1 \quad (4)$$

where,

$M$  = Degrees of freedom of the mechanism

$N_w$  = Number of white patches between the black patches

$L$  = Number of loops in the mechanism

$J_f$  = Number of joints attached to the ground link

By following the above steps, the degrees of freedom can be obtained. These steps are written in the form of an algorithm as follows.

---

**Algorithm 1** Zebra Crossing Algorithm

---

- 1: Design a mechanism based on the requirement and marks its links and joints clearly.
  - 2: Convert it into the Zebra Crossing diagram.
  - 3: Calculate the number of loops using the formula:  $L = B - (W + G) + 1$
  - 4: **if**  $L = 0$  **then**
  - 5:      $M = B$
  - 6: **else if** the mechanism can be arranged in a plane and has black, grey and white patches in the Zebra Crossing diagram **then**
  - 7:      $M = N_s - (4 \times L) - J_f + 1$
  - 8: **else if** the mechanism can be arranged in a plane and has only Black and White patches in the Zebra Crossing diagram **then**
  - 9:      $M = N_w - L - J_f + 1$
  - 10: **else**
  - 11:     the mechanism cannot be arranged in a plane
  - 12:      $M = N_w - L - J_f + 1$
  - 13: **end if**
-

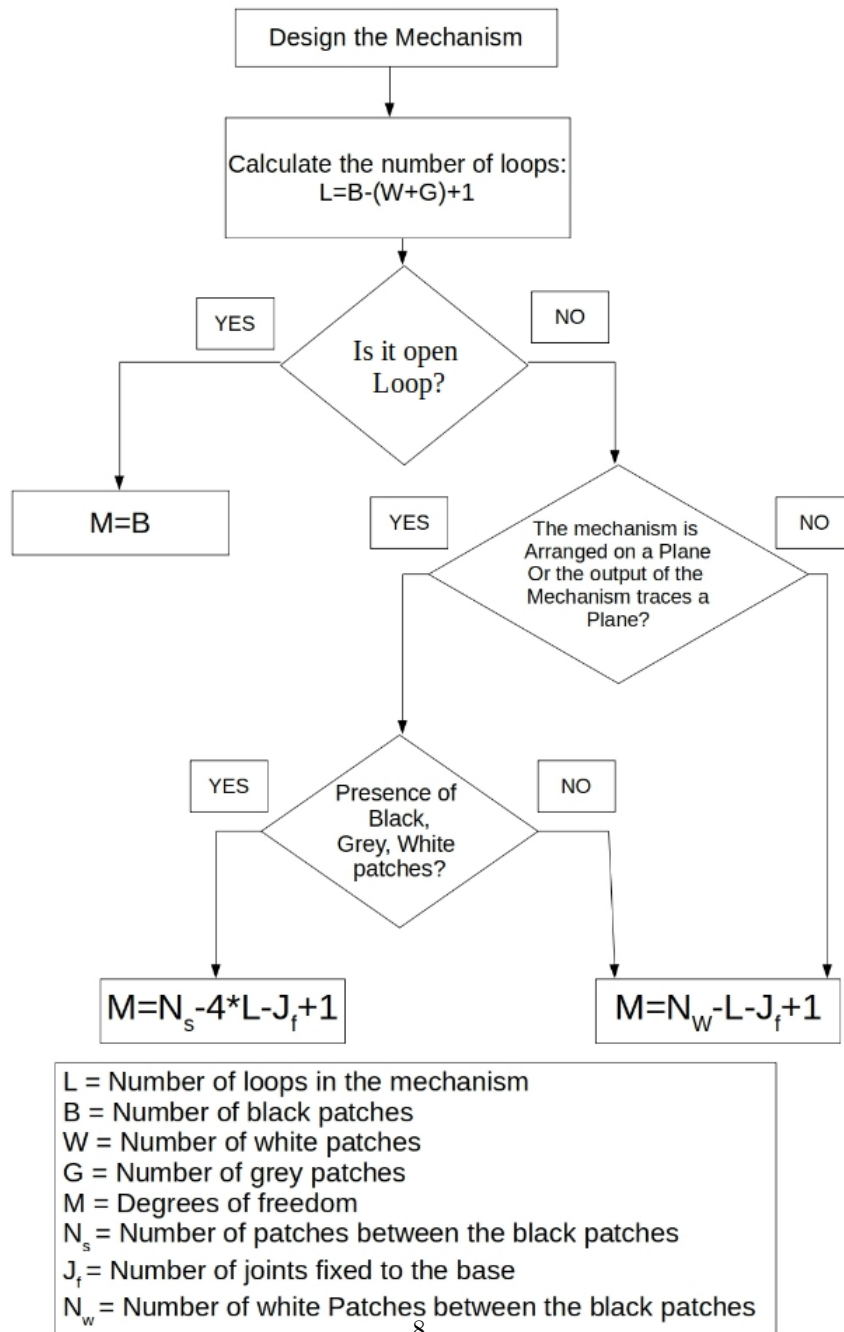

Figure 3: The zebra crossing algorithm



155 **3. Examples**

In this section we consider several examples that have been solved or unsolved in the literature to show that our method works in all of them while others do not.

3.1. Open loop mechanisms

3.1.1. One DOF helical joint mechanism

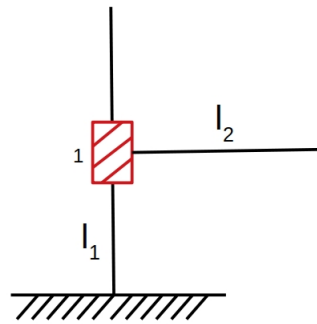

(a)

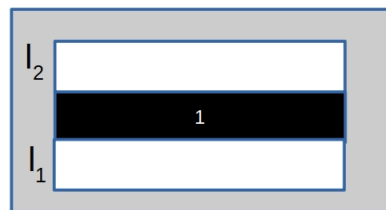

(b)

Figure 4: The zebra crossing algorithm applied to the one DOF helical joint mechanism (a) The one DOF helical joint mechanism (b) The zebra crossing diagram of the mechanism

160 One DOF helical joint mechanism is a simple mechanism with two links connected by a helical joint. This is shown in Figure 4 (a). The Zebra crossing diagram of the mechanism is drawn as follows. The *Rule 4* is applied which represents the fixed link. This is followed by *Rule 1* and *Rule 4*. This completes the Zebra crossing diagram and is shown in Figure 4 (b).

165 From the Zebra Crossing diagram, the number of loops (L) in the mechanism are calculated using the Equation 1. There is 1 black patch and 2 white patches in the zebra crossing diagram. Therefore,

$$L = 1 - 2 + 1 = 0 \quad (5)$$

The number of loops in the mechanism is found to be 0. Hence it is an open loop mechanism. Calculating the degrees of freedom (M) from Equation 2,

$$M = 1 \quad (6)$$

170 Therefore, the mechanism has 1 degree of freedom. The above steps can be followed to find the degrees of freedom in open loop mechanisms.

3.2. Closed loop mechanisms

3.2.1. Planar mechanisms

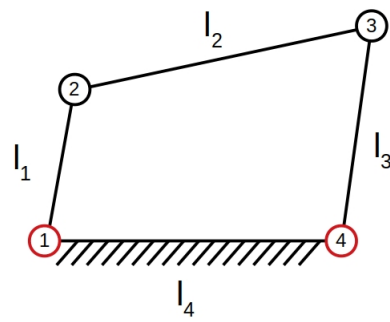

(a)

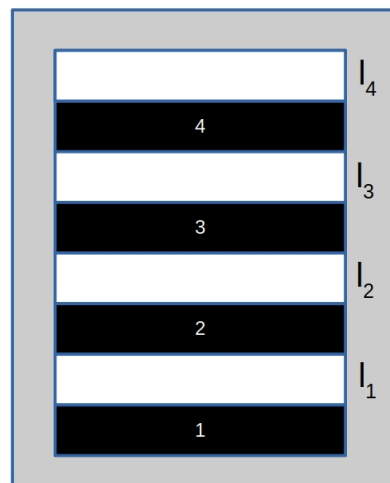

(b)

Figure 5: The zebra crossing algorithm applied to the four bar mechanism (a) The four bar mechanism (b) The zebra crossing diagram of the mechanism

*Four-bar mechanism.* The four bar mechanism is shown in Figure 5 (a). The Zebra crossing diagram is drawn by following the *Rule 1* followed by *Rule 4*. These two rules are repeated till the link  $l_4$  is reached.

There are 4 black patches and 4 white patches in the Zebra crossing diagram. Applying Equation 1, the number of loops ( $L$ ) in the mechanism are

$$L = 4 - 4 + 1 = 1 \quad (7)$$

The number of white patches between the black patches  $N_w$  are 3. The number of loops  $L$  is 1. The number of joints attached to the ground link  $J_f$  are 2. The degrees of freedom ( $M$ ) is calculated using the Equation 4,

$$M = 3 - 1 - 2 + 1 = 1 \quad (8)$$

Therefore, the mechanism has 1 degree of freedom.

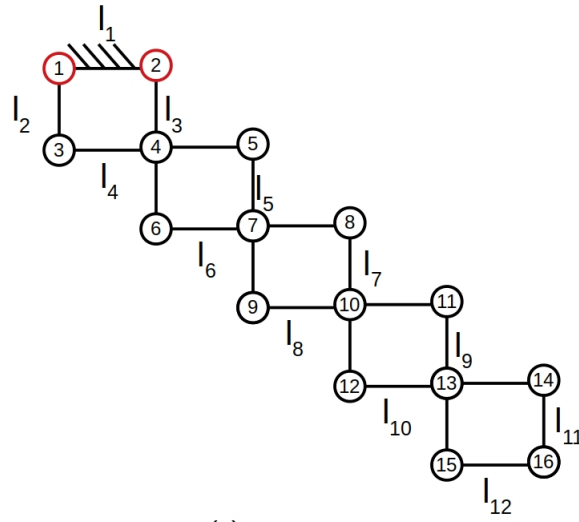

(a)

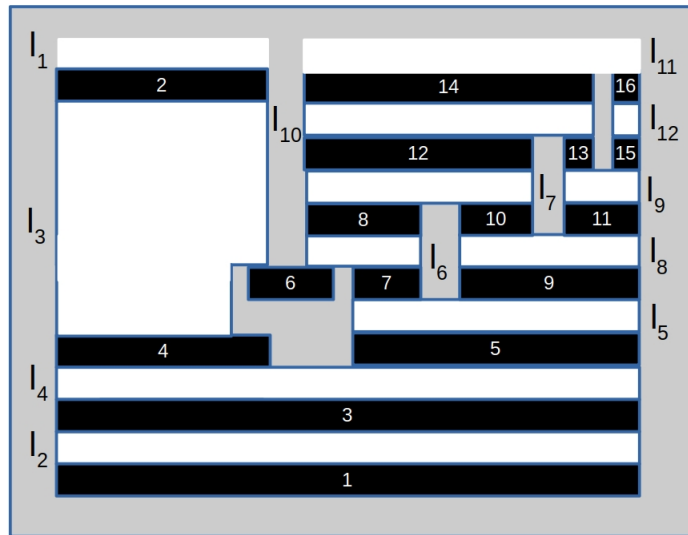

(b)

Figure 6: The zebra crossing algorithm applied to the staircase mechanism (a) The staircase mechanism (b) The zebra crossing diagram of the mechanism

*Staircase mechanism.* The staircase mechanism is shown in Figure 6 (a). The Zebra crossing diagram is drawn by following the *Rule 1*, *Rule 4*, *Rule 6*. From here it forms two branches. For

the first branch *Rule 4*, followed by *Rule 1* and *Rule 4* is drawn. For the second branch, *Rule 4* is applied. Then in the second branch the *Rule 6* is applied twice. Then *Rule 4* is applied to links  $l_7$  and  $l_9$ . Then apply *Rule 6* twice. To end the Zebra Crossing diagram, follow *Rule 5*.

There are 16 black patches and 12 white patches. The number of loops (M) in the mechanism are calculated using the Equation 1, which is

$$L = 16 - 12 + 1 = 5 \quad (9)$$

The number of white patches between the black patches  $N_w$  are 7. The number of loops  $L$  are 5. The number of joints attached to the ground link  $J_f$  are 2. The degrees of freedom is calculated using the Equation 4,

$$M = 7 - 5 - 2 + 1 = 1 \quad (10)$$

Therefore, the mechanism has 1 degree of freedom.

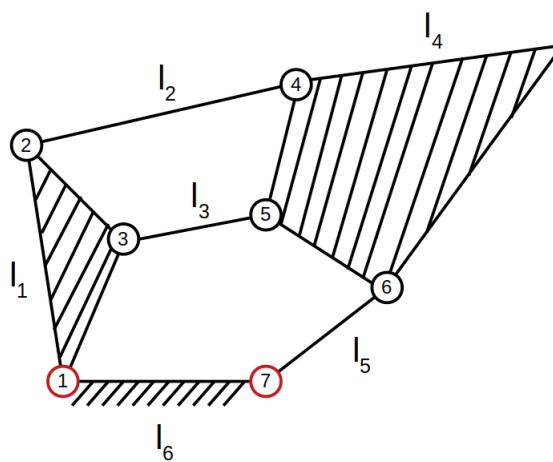

(a)

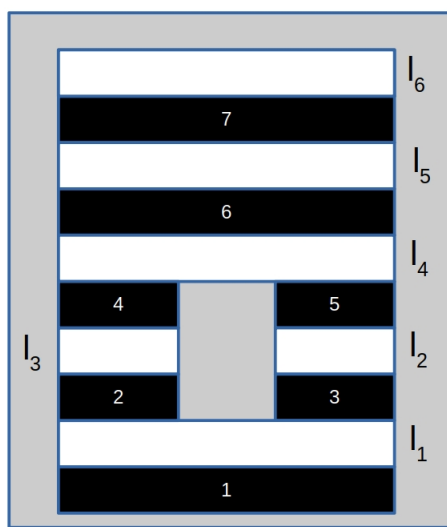

(b)

Figure 7: The zebra crossing algorithm applied to the six-bar mechanism (a) The six-bar mechanism (b) The zebra crossing diagram of the mechanism

*Six-Bar Mechanism.* The six-bar mechanism is shown in Figure 7 (a). The mechanism has 6 links and 7 joints. The zebra crossing diagram for this mechanism is shown in Figure 7 (b). The drawing



195 of the Zebra Crossing diagram starts by applying *Rule 6*. Then on each branch apply *Rule 4*. Then apply *Rule 6*. This followed by *Rule 4*, *Rule 1* and *Rule 4*.

There are 7 black patches and 6 white patches in the zebra crossing diagram. The number of loops in the mechanism are calculated using Equation 1.

$$L = 7 - 6 + 1 = 2 \quad (11)$$

200 The number of white patches between the black patches  $N_w$  are 4. The number of loops  $L$  are 2. The number of joints attached to the ground link  $J_f$  are 2. The degrees of freedom (M) is calculated using the Equation 4,

$$M = 4 - 2 - 2 + 1 = 1 \quad (12)$$

Therefore, the mechanism has 1 degree of freedom.

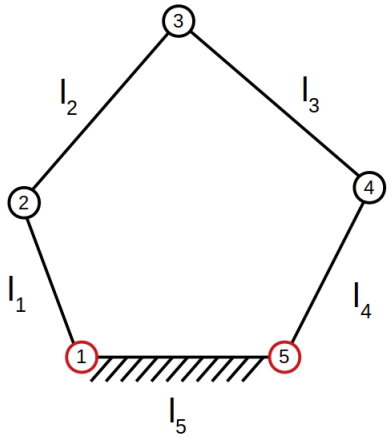

(a)

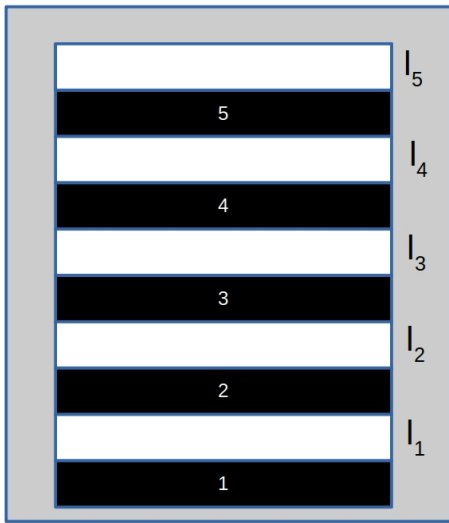

(b)

Figure 8: The zebra crossing algorithm applied to the five-bar mechanism (a) The five bar mechanism (b) The zebra crossing diagram of the mechanism

*Five-Bar Mechanism.* The five-bar mechanism is shown in Figure 8 (a). The Zebra crossing diagram for this mechanism is shown in 8 (b). The steps involved in drawing the Zebra crossing diagram

205 are similar to that of the four bar mechanism. In this case an additional link and joint are added.

There are 5 black patches and 5 white patches in the zebra crossing diagram. The number of loops in the mechanism are calculated using the Equation 1.

$$L = 5 - 5 + 1 = 1 \quad (13)$$

The number of white patches between the black patches  $N_w$  are 4. The number of loops  $L$  is 1. The number of joints attached to the ground link  $J_f$  are 2. The degrees of freedom (M) is  
210 calculated using the Equation 4,

$$M = 4 - 1 - 2 + 1 = 2 \quad (14)$$

Therefore, the mechanism has 2 degrees of freedom.

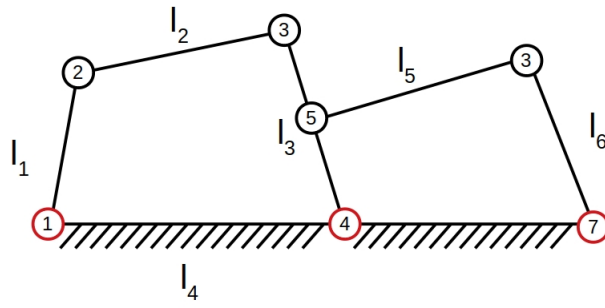

(a)

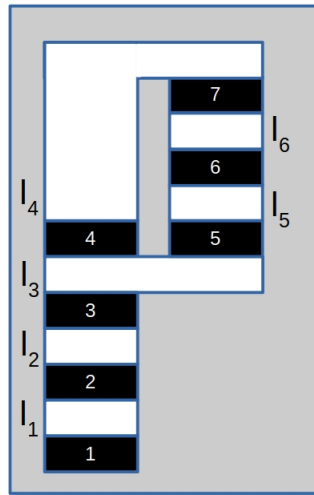

(b)

Figure 9: The zebra crossing algorithm applied to the four-bar mechanism in series (a) The four-bar mechanism in series (b) The zebra crossing diagram of the mechanism

*Four-Bar Mechanism in Series.* The four-bar mechanism in series is shown in Figure 9 (a). The Zebra crossing diagram for this mechanism is shown in Figure 9 (b). The steps followed are similar

to that of a four bar mechanism but the link  $l_3$  is ternary in nature and hence *Rule 6* has to be  
215 applied.

There are 7 black patches and 6 white patches in the zebra crossing diagram. The number of  
loops (L) in the mechanism are calculated using the Equation 1.

$$L = 7 - 6 + 1 = 2 \quad (15)$$

The number of white patches between the black patches  $N_w$  are 5. The number of loops  $L$  are  
2. The number of joints attached to the ground link  $J_f$  are 3. The degrees of freedom is calculated  
220 using the Equation 4,

$$M = 5 - 2 - 3 + 1 = 1 \quad (16)$$

Therefore the mechanism has 1 degree of freedom.

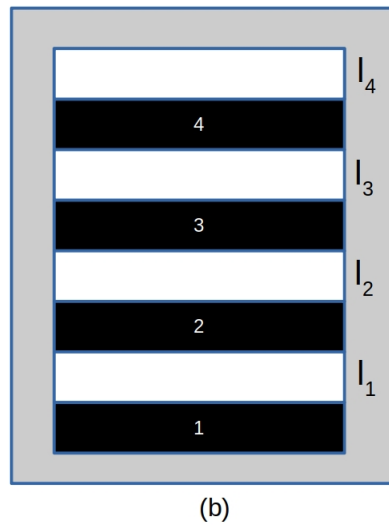
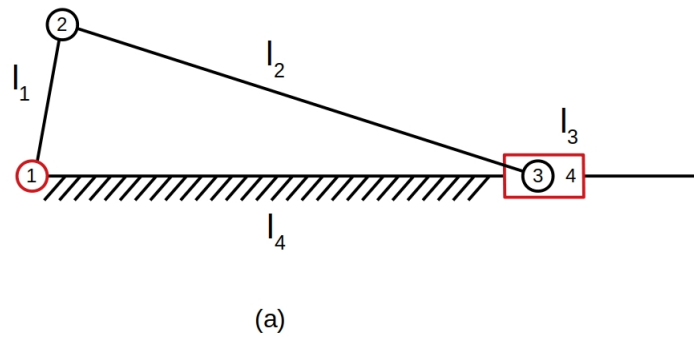

Figure 10: The zebra crossing algorithm applied to the crank and slider mechanism (a) The crank and slider mechanism (b) The zebra crossing diagram of the mechanism

*Crank and Slider Mechanism.* The crank and slider mechanism is shown in Figure 10 (a). This mechanism has 4 links and 4 joints. The number of revolute joints are 3 and prismatic joint is 1.

The zebra crossing diagram for this mechanism is shown in Figure 10 (b). The steps involved in drawing the zebra crossing diagram is similar to that of the four bar mechanism.

There are 4 black patches and 4 white patches in the zebra crossing diagram. The number of loops in the mechanism are calculated using Equation 1. The number of loops are,

$$L = 4 - 4 + 1 = 1 \quad (17)$$

The number of white patches between the black patches  $N_w$  are 3. The number of loops  $L$  is 1. The number of joints attached to the ground link  $J_f$  are 2. The degrees of freedom is calculated using Equation 4,

$$M = 3 - 1 - 2 + 1 = 1 \quad (18)$$

Therefore, the mechanism has 1 degree of freedom.

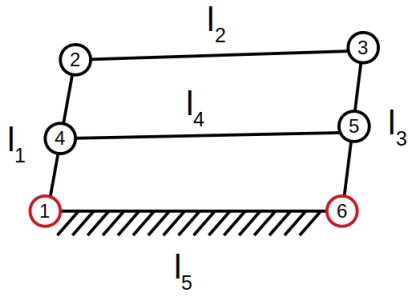

(a)

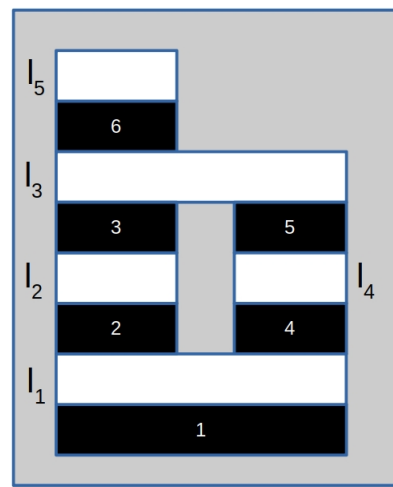

(b)

Figure 11: The zebra crossing algorithm applied to the four-bar mechanism in parallel (a) The four-bar mechanism in parallel (b) The zebra crossing diagram of the mechanism

*Four-bar Mechanism in Parallel.* The four-bar mechanism in parallel is shown in Figure 11 (a). The Zebra crossing diagram is shown in Figure 11 (b). The steps involved in drawing the Zebra



crossing diagram are similar to that of the six bar mechanism. The degree of freedom for this  
235 mechanism depends on the length of the links  $l_2$ ,  $l_4$  and  $l_5$ . There are two cases which arises based  
on the length of the mechanism.

*Case 1:* The links  $l_2$ ,  $l_4$  and  $l_5$  are of same length.

There are 6 black patches and 5 white patches in the zebra crossing diagram. The number of  
loops in the mechanism are calculated using Equation 1. The number of loops are,

$$L = 6 - 5 + 1 = 2 \quad (19)$$

240 The number of white patches between the black patches  $N_w$  are 4. The number of loops  $L$  is  
2. The number of joints attached to the ground link  $J_f$  are 2. The degrees of freedom is calculated  
using Equation 4. Calculating the degrees of freedom,

$$M = 4 - 2 - 2 + 1 = 1 \quad (20)$$

Therefore, the mechanism has 1 degree of freedom.

*Case 2:* The links  $l_2$ ,  $l_4$  and  $l_5$  are of different lengths.

245 There are 6 black patches and 5 white patches in the zebra crossing diagram. The number of  
loops ( $L$ ) in the mechanism are calculated using Equation 1.

$$L = 6 - 5 + 1 = 2 \quad (21)$$

The number of white patches between the black patches  $N_w$  are 3 (the links  $l_2$  and  $l_4$  are treated  
as one white patch). The number of loops  $L$  are 2. The number of joints attached to the ground  
link  $J_f$  are 2. The degrees of freedom ( $M$ ) is calculated using Equation 4.

$$M = 3 - 2 - 2 + 1 = 0 \quad (22)$$

250 Therefore the mechanism has 0 degree of freedom.

The degrees of freedom of a mechanism will vary based on the link lengths and joint ranges.  
This variation will be taken in to account and the degrees of freedom will be calculated in our future  
works.

3.2.2. Spatial mechanisms

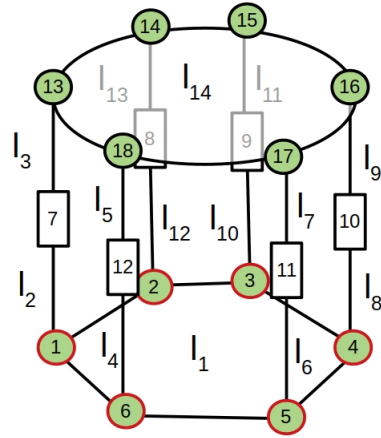

(a)

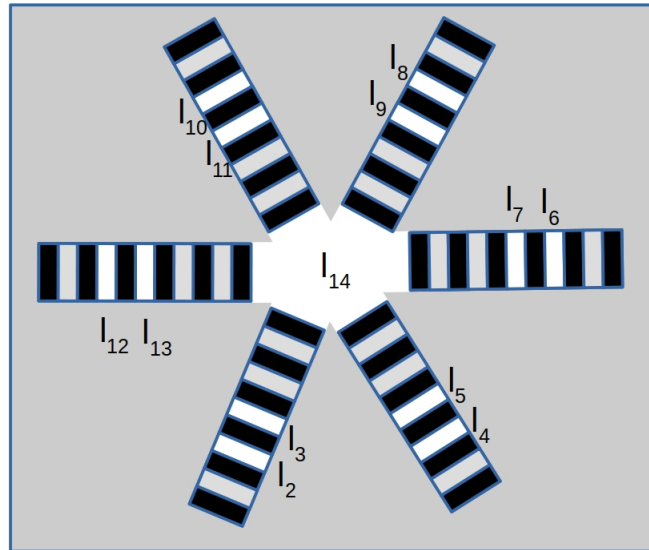

(b)

Figure 12: The zebra crossing algorithm applied to the Stewart platform (a) The Stewart platform (b) The zebra crossing diagram of the mechanism

255 *Stewart Platform.* The Stewart platform is shown in Figure 12 (a). The link  $l_1$  is the fixed link and the link  $l_{14}$  is the moving platform. There are 6 legs which connect the fixed link to the moving platform. To draw the Zebra crossing diagram for this mechanism, one of the legs is considered. The *Rule 2* is applied to start drawing the Zebra Crossing diagram, which is followed by *Rule 4* and *Rule 3*. This is one leg of the parallel manipulator. This terminates at the movable platform  
 260 which is the hexanary link. Similarly, the other 5 legs of the parallel manipulator are drawn.

There are 46 black patches and 37 white and grey patches in the zebra crossing diagram. The number of loops (L) in the mechanism are found out using the Equation 1.

$$L = 42 - 37 + 1 = 6 \quad (23)$$

The number of white patches between the black patches  $N_w$  are 17. It is calculated as follows: The number of white patches between the black patches in the legs are 12. The link  $l_{14}$ , which  
 265 is the white patch, is assigned a number that is one less than the number of legs in the parallel manipulator, which is 5. This is a rule that has to be followed for every parallel manipulator. The number of loops  $L$  are 6. The number of joints attached to the ground link  $J_f$  are 6. The degrees of freedom (M) is calculated using the Equation 4.

$$M = 17 - 6 - 6 + 1 = 6 \quad (24)$$

Therefore the mechanism has 6 degrees of freedom.

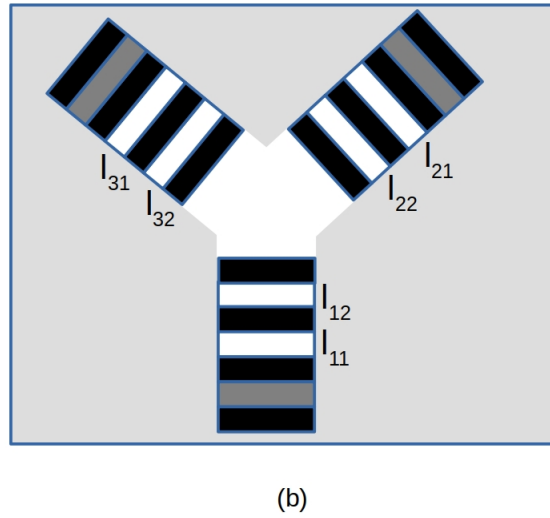
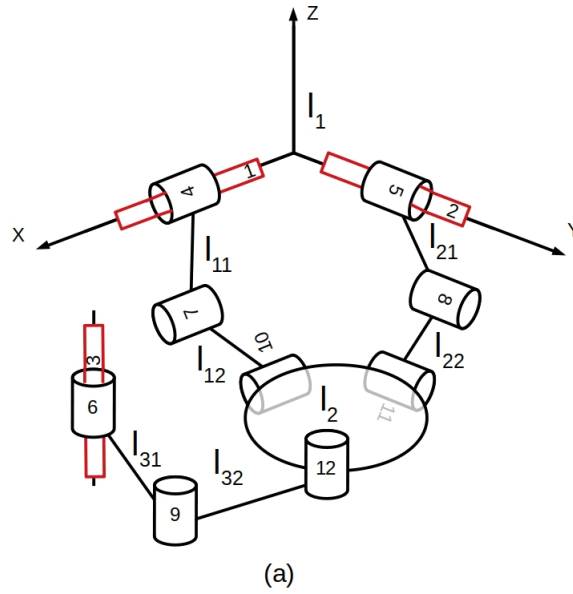

Figure 13: The zebra crossing algorithm applied to the cartesian parallel manipulator (a) The cartesian parallel manipulator (b) The zebra crossing diagram of the mechanism

270 *Cartesian Parallel Manipulator.* The cartesian parallel manipulator is shown in Figure 13 (a). The link  $l_1$  is the fixed link and the link  $l_2$  is the moving platform. They are connected by three legs.

The Zebra crossing diagram is shown in Figure 13 (b). The Zebra Crossing is drawn by applying *Rule 2* followed by *Rule 4*, *Rule 1*, *Rule 4* and *Rule 1*. This is one leg of the manipulator. This leg terminates at the ternary link  $l_2$ . Similarly, the other 2 legs of the parallel manipulator are drawn.

275 There are 12 black patches and 10 white and grey patches in the zebra crossing diagram. The number of loops (L) in the mechanism are calculated using the Equation 1.

$$L = 12 - 10 + 1 = 3 \quad (25)$$

The number of white patches between the black patches  $N_w$  are 8 (the number of white patches between the black patches in the legs are 6 and for the link  $l_2$ , the white patch is assigned a number which is one less than the number of legs in the parallel manipulator, which is 2). The number of loops  $L$  are 3. The number of joints attached to the ground link  $J_f$  are 3. The degrees of freedom is calculated using the Equation 4.

280

$$M = 8 - 3 - 3 + 1 = 3 \quad (26)$$

Therefore the mechanism has 3 degrees of freedom.

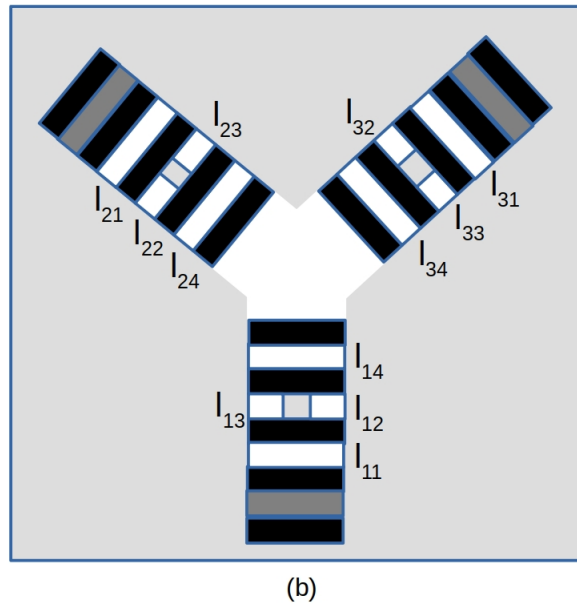
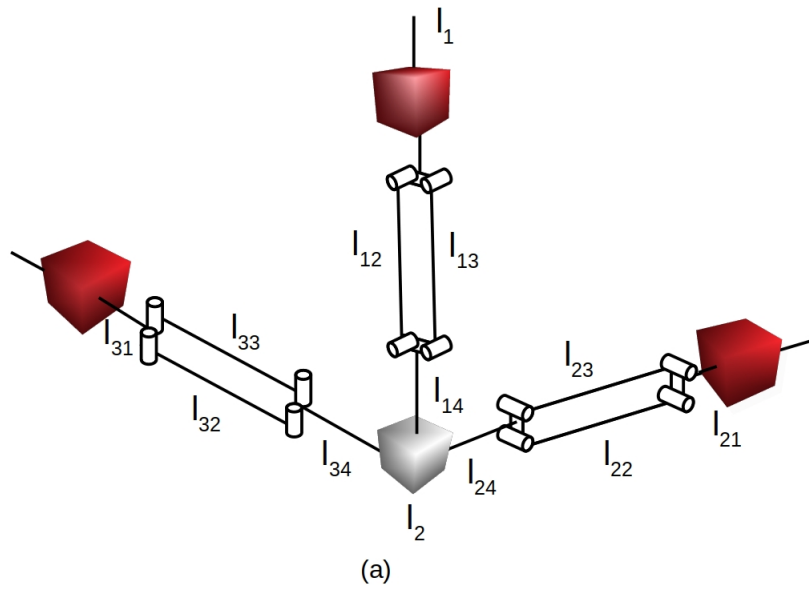

Figure 14: The zebra crossing algorithm applied to the orthoglide manipulator (a) The orthoglide manipulator (b) The zebra crossing diagram of the mechanism

*Orthoglide Manipulator.* The orthoglide manipulator is shown in Figure 14 (a). The link  $l_1$  is the fixed link and the link  $l_2$  is the moving platform. There are three legs which connect the fixed link

285 and the moving platform. The Zebra crossing diagram is drawn as follows. The *Rule 2* is applied to start with, followed by *Rule 4* and *Rule 1*. The *Rule 4* is applied twice to form two white patches. This is followed by *Rule 5*, which connects to the movable platform. Similarly, the other 2 legs of the parallel manipulator are drawn.

290 There are 21 black patches and 16 white and grey patches in the zebra crossing diagram. The number of loops (L) in the mechanism are calculated using the Equation 1.

$$L = 21 - 16 + 1 = 6 \quad (27)$$

The number of white patches between the black patches  $N_w$  are 11 (the number of white patches between the black patches in the legs are 9 and for the link  $l_2$ , the white patch is assigned a number which is one less than the number of legs in the parallel manipulator, which is 2). The number of loops  $L$  are 6. The number of joints attached to the ground link  $J_f$  are 3. The degrees of freedom (M) is calculated using Equation 4.

$$M = 11 - 6 - 3 + 1 = 3 \quad (28)$$

Therefore the mechanism has 3 degrees of freedom.

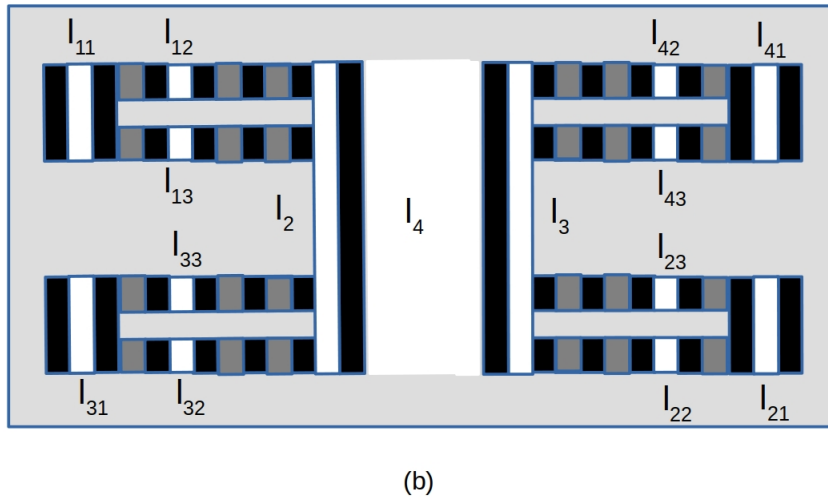
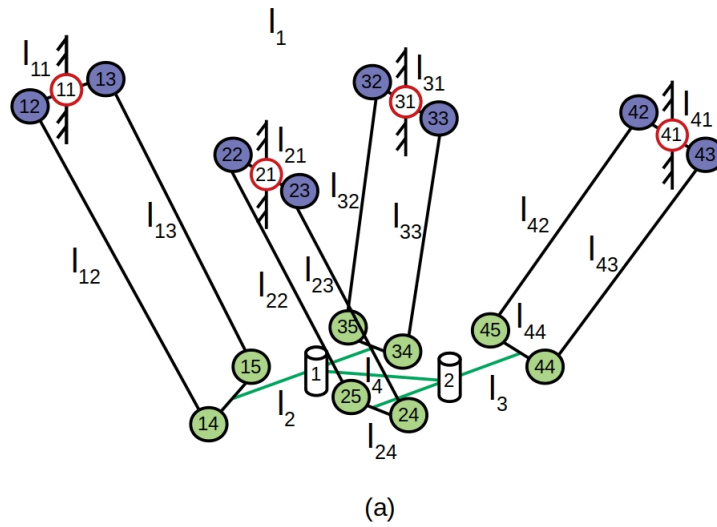

Figure 15: The zebra crossing algorithm applied to the H4 parallel manipulator (a) The H4 parallel manipulator (b) The zebra crossing diagram of the mechanism

*H4 Parallel Manipulator.* The H4 Parallel Manipulator is shown in Figure 15 (a). This manipulator has a fixed link  $l_1$  and a moving platform  $l_4$ . It has four legs which connect the fixed link and the



moving platform. The Zebra crossing diagram is drawn as follows. The *Rule 1* is applied, which is  
300 followed by *Rule 4*. Now the branching happens where the *Rule 2*, *Rule 4* and *Rule 3* are applied  
in two branches. Similarly, the second is drawn. The two legs are connected using *Rule 4* and *Rule*  
*1* to the movable platform  $l_4$ . Similarly, the other 2 legs of the parallel manipulator are drawn.

There are 46 black patches and 39 white and grey patches in the zebra crossing diagram. The  
number of loops in the mechanism are calculated using Equation 1.

$$L = 46 - 39 + 1 = 8 \quad (29)$$

305 The number of white patches between the black patches  $N_w$  are 15. The number of loops  $L$  are  
8. The number of joints attached to the ground link  $J_f$  are 4. The degrees of freedom is calculated  
using Equation 4.

$$M = 15 - 8 - 4 + 1 = 4 \quad (30)$$

Therefore, the mechanism has 4 degrees of freedom.

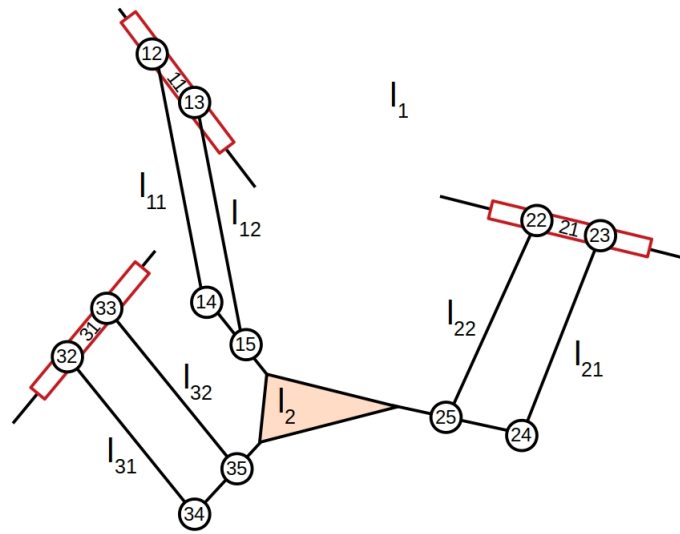

(a)

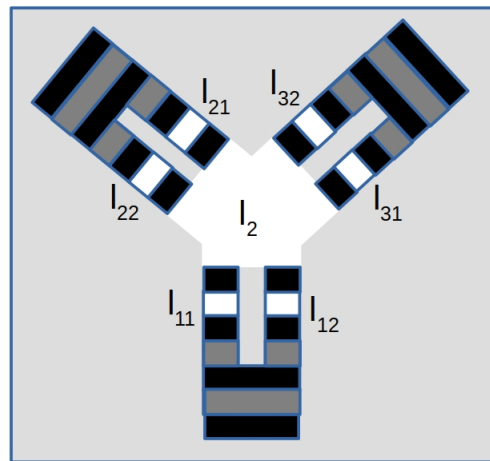

(b)

Figure 16: The zebra crossing algorithm applied to the STAR manipulator (a) The STAR manipulator (b) The zebra crossing diagram of the mechanism

*STAR Manipulator.* The STAR manipulator is shown in Figure 16 (a). The link  $l_1$  is the fixed link and the link  $l_2$  is the moving platform. The link  $l_1$  is connected to the link  $l_2$  through three

310

legs. The Zebra crossing diagram for this manipulator is shown in Figure 16 (b). One leg of the manipulator is drawn as follows. Apply *Rule 2* which represents the cylindrical joint. This joint branches in to two and the *Rule 2* is applied. Then the *Rule 4* followed by *Rule 1* and *Rule 9*. Similarly, the other two legs are represented in Zebra crossing diagram.

315 There are 21 black patches and 16 white and grey patches in the zebra crossing diagram. The number of loops in the mechanism are calculated using the Equation 1.

$$L = 21 - 16 + 1 = 6 \quad (31)$$

The number of white patches between the black patches  $N_w$  are 11 (the number of white patches between the black patches in the legs are 9 and for the link  $l_2$ , the white patch is assigned a number which is one less than the number of legs in the parallel manipulator, which is 2). The number of loops  $L$  are 6. The number of joints attached to the ground link  $J_f$  are 3. The degrees of freedom (M) is calculated using the Equation 4.

$$M = 11 - 6 - 3 + 1 = 3 \quad (32)$$

Therefore the mechanism has 3 degrees of freedom.

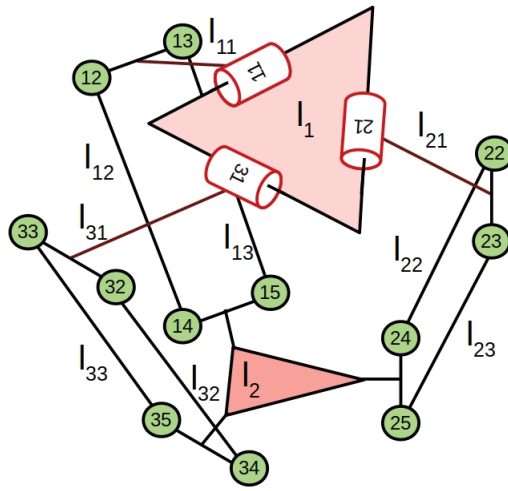

(a)

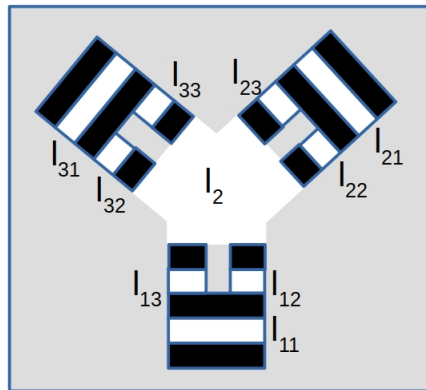

(b)

Figure 17: The zebra crossing algorithm applied to the DELTA manipulator (a) The DELTA manipulator (b) The zebra crossing diagram of the mechanism

*DELTA Manipulator.* The DELTA manipulator is shown in Figure 17 (a). The link  $l_1$  is fixed and the link  $l_2$  is the moving platform. There are three legs which connect the fixed link to the moving

325 platform. The Zebra crossing diagram for this mechanism is shown in Figure 17 (b). It is drawn by applying *Rule 1* followed by *Rule 4*. From this, two links branch out which is drawn by applying *Rule 5* and ends by applying *Rule 9*. Similarly, the other two legs are drawn.

There are 15 black patches and 10 white patches in the zebra crossing diagram. The number of loops ( $L$ ) in the mechanism are calculated using the Equation 1.

$$L = 15 - 10 + 1 = 6 \quad (33)$$

330 The number of white patches between the black patches  $N_w$  are 11 (the number of white patches between the black patches in the legs are 6 and for the link  $l_2$ , the white patch is assigned a number which is one less than the number of legs in the parallel manipulator, which is 5). The number of loops  $L$  are 6. The number of joints attached to the ground link  $J_f$  are 6. The degrees of freedom ( $M$ ) is calculated using the Equation 4.

$$M = 11 - 6 - 3 + 1 = 3 \quad (34)$$

335 Therefore the mechanism has 3 degrees of freedom.

#### 4. A comparison the Zebra Crossing Method with other quick methods

In [2], details about the existing methods in the literature for calculating degrees of freedom of mechanisms are given. We compare the results of Zebra Crossing method with the quick methods mentioned in it for the mechanisms analysed above. The consolidated results are given in the Table 18. It can be seen in the Table 18 that applying the quick methods for planar mechanisms gives the correct degrees of freedom for most of the cases. But considering the spatial mechanisms, especially the modern parallel manipulators, the quick methods fail to give the correct degrees of freedom. The reason for this is the inability to find kinematically dependant loops in the mechanisms. A detailed explanation for this is given in [2].

345 The proposed Zebra crossing method can be applied to both planar and spatial mechanisms. The Stewart platform, Cartesian Parallel manipulator, Orthoglide manipulator and the STAR manipulator are a few modern manipulators. Most of the quick methods that exist in the literature are either not applicable or give wrong results for these modern mechanisms. But when the Zebra crossing method is applied to these modern mechanisms, we obtain the correct degrees of freedom.

350 The traditional formulae used to calculate the degrees of freedom does not take into account the number of loops and the number of joints attached to the fixed link. The Zebra Crossing method takes into account these two critical parameters which aid in exact prediction of the degrees of freedom.

In summary, the Zebra Crossing method, proposed by us, can solve the degrees of freedom for all the given mechanisms. None of the other methods proposed in the literature have this capability. Even a combination of all the earlier proposed methods are not be able to solve all the mechanisms given here which the Zebra Crossing method can do.

#### 5. Conclusions

360 A novel Zebra Crossing method to find the degees of freedom for a mechanism is proposed in this work. The designed mechanism is converted into a zebra crossing diagram. The number of

Names of Contributors	Condition/Formula	Mechanism Applicable	Planar Mechanism						Spatial Mechanism							
			4 Bar	Staircase	6 bar	5 bar	4 bar in series	Crank and slider	4 bar parallel	1-loop Helical Link	Stewart platform	CPM	Orthoglide	H4	STAR	DELTA
Chebyshev's contribution	Formula	Planar mechanism with 1 DOF joints	YES	YES	YES	YES	YES	YES	NO	N/A	N/A	N/A	N/A	N/A	N/A	N/A
Sylvester's contribution	Condition	1 DOF pin-connected planar mechanisms	YES	YES	YES	N/A	YES	YES	NO	N/A	N/A	N/A	N/A	N/A	N/A	N/A
Grubler's contribution	Condition	1 DOF pin-connected planar mechanisms	YES	YES	YES	N/A	YES	YES	NO	N/A	N/A	N/A	N/A	N/A	N/A	N/A
Grubler's contribution	Condition	1 DOF spatial complex mechanisms with helical joints	N/A	N/A	N/A	N/A	N/A	N/A	NO	N/A	N/A	N/A	N/A	N/A	N/A	N/A
Somov's contribution	Condition	1 DOF planar and spatial mechanisms	YES	YES	YES	YES	YES	YES	NO	N/A	N/A	N/A	N/A	N/A	N/A	N/A
Hochmann's contribution	Condition	1 DOF mechanisms	YES	YES	YES	YES	YES	YES	NO	N/A	N/A	N/A	N/A	N/A	N/A	N/A
Somov-Waltyshev's formula	Formula	Spatial mechanisms	N/A	N/A	N/A	N/A	N/A	N/A	N/A	N/A	N/A	N/A	N/A	N/A	N/A	N/A
Koenigs' formula	Formula	Spatial mechanisms	N/A	N/A	N/A	N/A	N/A	N/A	N/A	N/A	N/A	N/A	N/A	N/A	N/A	N/A
Kozlov's mobility equation	Formula	Planar and spatial mechanisms	N/A	N/A	N/A	N/A	N/A	N/A	N/A	N/A	N/A	N/A	N/A	N/A	N/A	N/A
Kozlov's mobility equation	Formula	Planar and spatial mechanisms	YES	YES	YES	YES	YES	YES	NO	N/A	N/A	N/A	N/A	N/A	N/A	N/A
Kochan's mobility equation	Formula	Planar and spatial mechanisms	YES	YES	YES	YES	YES	YES	NO	N/A	N/A	N/A	N/A	N/A	N/A	N/A
Kochan's mobility equation	Formula	Planar and spatial mechanisms	N/A	N/A	N/A	N/A	N/A	N/A	NO	N/A	N/A	N/A	N/A	N/A	N/A	N/A
Rössler's contribution	Formula	Spatial mechanisms	N/A	N/A	N/A	N/A	N/A	N/A	N/A	N/A	N/A	N/A	N/A	N/A	N/A	N/A
Borden's mobility equation	Formula	Spatial mechanisms	N/A	N/A	N/A	N/A	N/A	N/A	N/A	N/A	N/A	N/A	N/A	N/A	N/A	N/A
Manalau's formula	Formula	Complex Kinematic Chain	N/A	N/A	YES	N/A	N/A	N/A	N/A	N/A	N/A	N/A	N/A	N/A	N/A	N/A
Oxel's formula	Formula	Spatial mechanisms	N/A	N/A	N/A	N/A	N/A	N/A	N/A	N/A	N/A	N/A	N/A	N/A	N/A	N/A
Contribution of Waldron	Formula	Spatial mechanisms	YES	N/A	N/A	N/A	N/A	N/A	N/A	N/A	N/A	N/A	N/A	N/A	N/A	N/A
Contribution of Manolescu	Formula	Spatial mechanisms	N/A	N/A	N/A	N/A	N/A	N/A	N/A	N/A	N/A	N/A	N/A	N/A	N/A	N/A
Contribution of Baiqi	Formula	Loop mechanisms	YES	YES	YES	YES	YES	YES	NO	N/A	N/A	N/A	N/A	N/A	N/A	N/A
Contribution of Antonescu	Formula	Planar and spatial mechanisms	YES	YES	YES	YES	YES	YES	NO	N/A	N/A	N/A	N/A	N/A	N/A	N/A
Hunt's contribution	Formula	Planar and spatial mechanisms	YES	YES	YES	YES	YES	YES	NO	N/A	N/A	N/A	N/A	N/A	N/A	N/A
Hervé's contribution	Formula	Planar and spatial mechanisms	YES	YES	YES	YES	YES	YES	NO	N/A	N/A	N/A	N/A	N/A	N/A	N/A
Gronowicz's contribution	Formula	Complex Kinematic Chain	N/A	YES	YES	N/A	N/A	YES	N/A	N/A	N/A	N/A	N/A	N/A	N/A	N/A
Contribution of Agrawal and Rao	Formula	Simple and Complex Kinematic Chain	N/A	YES	YES	N/A	N/A	YES	N/A	N/A	N/A	N/A	N/A	N/A	N/A	N/A
Contribution of Duffell & Diaconescu	Formula	Simple and Complex Kinematic Chain	YES	YES	YES	YES	YES	YES	NO	N/A	N/A	N/A	N/A	N/A	N/A	N/A
Tsai's formula	Formula	Planar and spatial mechanisms	YES	YES	YES	YES	YES	YES	NO	N/A	N/A	N/A	N/A	N/A	N/A	N/A
McCarthy's formula	Formula	Planar and spatial mechanisms	N/A	N/A	N/A	N/A	N/A	N/A	N/A	N/A	N/A	N/A	N/A	N/A	N/A	N/A
Contribution of Huang, Kong and Fang	Formula	Platform is connected to the ground by serial chains	YES	YES	YES	YES	YES	YES	NO	N/A	N/A	N/A	N/A	N/A	N/A	N/A
GOGU's contribution	Formula	Planar and spatial mechanisms	N/A	N/A	N/A	N/A	N/A	N/A	N/A	N/A	N/A	N/A	N/A	N/A	N/A	N/A
Zebra Crossing Method	Formula	Parallel Mechanism	YES	YES	YES	YES	YES	YES	YES	YES	YES	YES	YES	YES	YES	YES
Zebra Crossing Method	Formula	Planar and spatial mechanisms	YES	YES	YES	YES	YES	YES	YES	YES	YES	YES	YES	YES	YES	YES

Figure 18: The zebra crossing algorithm compared with the other methods in the literature

loops are calculated. Based on the number of loops and the nature of the mechanism, a suitable formula for calculating degrees of freedom is chosen. The degrees of freedom of the mechanism is calculated using it. To the best of authors knowledge, this quick method can be applied to any mechanism. About 14 mechanisms of which a few of them whose degrees of freedom can not be found using the methods existing in the literature can be found using the zebra crossing method. Thus the proposed Zebra Crossing method is more universal in its applicability than other similar methods.

**Acknowledgment:** The authors acknowledge partial funding support from RBCCPS, IISc Bangalore, Karnataka, India.

## References

### References

- [1] G. Bgelsack, Terminology for the theory of machines and mechanisms, *Mech. Mach. Theor.* 26 (5) (1983) 435–539.
- [2] G. Gogu, Mobility of mechanisms: a critical review, *Mechanism and machine Theory* 40 (9) (2005) 1068–1097.
- [3] J.-P. Merlet, *Parallel robots*, Vol. 128, Springer Science & Business Media, 2006.
- [4] Z. Huang, J. Liu, D. Zeng, A general methodology for mobility analysis of mechanisms based on constraint screw theory, *Science in China Series E: Technological Sciences* 52 (5) (2009) 1337–1347.
- [5] A. Müller, Generic mobility of rigid body mechanisms, *Mechanism and Machine Theory* 44 (6) (2009) 1240–1255.
- [6] T.-L. Yang, D.-J. Sun, A general degree of freedom formula for parallel mechanisms and multiloop spatial mechanisms, *Journal of Mechanisms and Robotics* 4 (1).
- [7] J. Rico, L. Aguilera, J. Gallardo, R. Rodriguez, H. Orozco, J. Barrera, A more general mobility criterion for parallel platforms, in: *International Design Engineering Technical Conferences and Computers and Information in Engineering Conference*, Vol. 46954, 2004, pp. 163–184.
- [8] C. Wampler, B. T. Larson, A. G. Erdman, A new mobility formula for spatial mechanisms, in: *International Design Engineering Technical Conferences and Computers and Information in Engineering Conference*, Vol. 48094, 2007, pp. 561–570.
- [9] D.-C. Yang, J. Xiong, X.-D. Yang, A simple method to calculate mobility with jacobian, *Mechanism and machine theory* 43 (9) (2008) 1175–1185.
- [10] J.-S. Zhao, K. Zhou, Z.-J. Feng, A theory of degrees of freedom for mechanisms, *Mechanism and Machine Theory* 39 (6) (2004) 621–643.
- [11] C. Li, H. Guo, D. Tang, R. Liu, Z. Deng, X. Song, S. I. Zahin, Cell division method for mobility analysis of multi-loop mechanisms, *Mechanism and Machine Theory* 141 (2019) 67–94.
- [12] J.-F. Rameau, P. Serré, Computing mobility condition using groebner basis, *Mechanism and Machine Theory* 91 (2015) 21–38.

- [13] J.-F. Rameau, P. Serré, Dimensional perturbation of rigidity and mobility, *Computer-Aided Design* 71 (2016) 1–14.
- 400 [14] A. Müller, O. Shai, Constraint graphs for combinatorial mobility determination, *Mechanism and Machine Theory* 108 (2017) 260–275.
- [15] D. Zeng, W. Lu, Z. Huang, Determination of overconstraint and mobility analysis for planar mechanisms, *Proceedings of the Institution of Mechanical Engineers, Part C: Journal of Mechanical Engineering Science* 230 (20) (2016) 3743–3754.
- 405 [16] J. Rico, J. Cervantes, A. Tadeo, J. Gallardo, L. Aguilera, C. Diez, Infinitesimal kinematics methods in the mobility determination of kinematic chains, in: *International Design Engineering Technical Conferences and Computers and Information in Engineering Conference*, Vol. 49040, 2009, pp. 1195–1204.
- [17] D. Talaba, Mechanical models and the mobility of robots and mechanisms., *Robotica* 33 (1) 410 (2015) 181–193.
- [18] C. W. Wampler, J. D. Hauenstein, A. J. Sommese, Mechanism mobility and a local dimension test, *Mechanism and machine theory* 46 (9) (2011) 1193–1206.
- [19] Y. Yang, X. Ding, W. Zhang, Mobility analysis for deployable assemblies of mechanisms based on nullspace, in: *Advances in Reconfigurable Mechanisms and Robots II*, Springer, 2016, pp. 415 1049–1059.
- [20] W. Bu, S. Yan, J. Chen, X. An, Mobility analysis for parallel manipulators based on intersection of screw manifolds, *Journal of Mechanical Science and Technology* 30 (9) (2016) 4345–4352.
- [21] J. S. Dai, D. Li, Q. Zhang, G. Jin, Mobility analysis of a complex structured ball based on mechanism decomposition and equivalent screw system analysis, *Mechanism and Machine Theory* 39 (4) (2004) 445–458. 420
- [22] Q. Li, X. Chai, J. Xiang, Mobility analysis of limited-degrees-of-freedom parallel mechanisms in the framework of geometric algebra, *Journal of Mechanisms and Robotics* 8 (4).
- [23] X. Chai, Q. Li, W. Ye, Mobility analysis of overconstrained parallel mechanism using grassmann–cayley algebra, *Applied Mathematical Modelling* 51 (2017) 643–654.
- 425 [24] C. Chen, Mobility analysis of parallel manipulators and pattern of transform matrix, *Journal of Mechanisms and Robotics* 2 (4).
- [25] P. Milenkovic, Mobility of single-loop kinematic mechanisms under differential displacement, *Journal of Mechanical Design* 132 (4).
- [26] L. Wang, H. Xu, L. Guan, Mobility analysis of parallel mechanisms based on screw theory and mechanism topology, *Advances in Mechanical Engineering* 7 (11) (2015) 1687814015610467. 430
- [27] J. S. Dai, Z. Huang, H. Lipkin, Mobility of overconstrained parallel mechanisms.
- [28] D. Zeng, W. Lu, Z. Huang, Over-constraint and a unified mobility method for general spatial mechanisms part 1: Essential principle, *Chinese Journal of Mechanical Engineering* 28 (5) (2015) 869–877.



- 435 [29] J. Rico, B. Ravani, On calculating the degrees of freedom or mobility of overconstrained linkages: single-loop exceptional linkages.
- [30] T.-L. Yang, D.-J. Sun, Rank and mobility of single loop kinematic chains, in: International Design Engineering Technical Conferences and Computers and Information in Engineering Conference, Vol. 43260, 2008, pp. 1369–1378.
- 440 [31] F. Freudenstein, R. Alizade, On the degree of freedom of mechanisms with variable general constraint, in: Proceedings Fourth World Congress on the Theory of Machines and Mechanisms, 1975, pp. 51–56.
- [32] L.-W. Tsai, Mechanism design: enumeration of kinematic structures according to function, CRC press, 2000.