

Popcorns-Pro: A Cooperative Network-Server Approach for Data Center Energy Optimization

Sai Santosh Dayapule, Kathy Nguyen, Gregory Kahl,
Suresh Subramaniam, Guru Venkataramani
Department of Electrical and Computer Engineering
The George Washington University, Washington, DC, USA
{saisantoshd, kathymn, gkahl, suresh, guruv}@gwu.edu



Abstract—Data centers have become a popular computing platform for various applications, and they account for nearly 2% of total US energy consumption. Therefore, it has become important to optimize data center power, and reduce their energy footprint. With newer power-efficient designs in data center infrastructure and cooling equipment, active components such as servers and data center networks consume a majority of power. Most existing work optimize power in servers and networks independently, and do not address them together in a holistic fashion that has the potential to achieve greater power savings. In this article, we present Popcorns-Pro, a cooperative server-network framework for energy optimization. We present a comprehensive power model for heterogeneous data center switches along with low power mode designs in combination with the server power model. We design job scheduling algorithms that place tasks onto servers in a power-aware manner, such that servers and network switches can take effective advantage of low power states and available network link capacities. Our experimental results show that we are able to achieve significantly higher savings upto 80% compared to the previously well-known server and network power optimization policies.

1 INTRODUCTION

Data centers have spurred rapid growth in computing, and an increasing number of user applications have continued to migrate toward cloud computing in the past few years. With this growing trend, data centers now account for about 2% of US energy consumption [1]. Many public cloud computing environments have power consumption in the order of several Gigawatts. Therefore, energy is key challenges in data centers.

Data center servers are typically provisioned for peak performance to always satisfy user demands. This, however, also translates to higher power consumption. Hardware investments have resulted in power saving mechanisms, such as DVFS and low-power or idle states [2].

We note that power reduction strategies in network switches and routers have been largely studied in large-scale network settings. Gupta et al. [3] proposed a protocol-level support for coordinated entry into low-power states, where routers broadcast their sleep states for routing decisions to be changed accordingly. Adaptive Link Rate (ALR) for ethernet [4] allows the network links to reduce their bandwidth adaptively for increased power efficiency. Such approaches may not be very effective in data center settings where application execution times have a higher dependence on network performance and Quality of Service (QoS) demands by the users.

In this article, we propose PopCorns-Pro, a new framework to holistically optimize data center power through a cooperative

network-server approach. We propose power models for data center servers and network switches (with support for low-power modes) based on power measurements in real system settings and memory power modeling tools from MICRON [5] and Cacti [6]. We then study job placement algorithms that take communication patterns into account while optimizing the amount of sleep periods for both servers and line cards. Our experimental results show that we are able to achieve more than 20% higher energy savings compared to a baseline strategy that relies on server load-balancing to optimize data center energy.

We note that further power savings can be obtained at the application level through carefully tuning them for usage of processor resources [7] or through load-balancing tasks across cores in multicore processor settings to avoid keeping cores unnecessarily active. Such strategies can complement our proposed approach, and boost further power savings in data center settings.

We extended upon our previous work [8] by proposing a multi-state power model for data center network switches and servers based on available power measurements in real system settings and memory power modeling tools. We formulate a power optimization problem that jointly considers both server (with multiple cores) and network switches (with multiple line cards). We improve network traffic modeling accuracy by including link capacities. We also consider realistic heterogeneous switches in the Fat tree topology with different performance and power characteristics for switches at Core, Aggregate and Edge levels. We compare our approach against a server load-balancing mechanism for task placement and a traditional Dijkstra based network routing algorithm. We also consider a server energy optimization algorithm and a greedy bin packing network routing policy which consolidates traffic into fewer switches. These four policy combinations are compared with our Popcorns server algorithm to find that a combined server-network energy aware algorithm is more efficient than optimized versions of individual approaches previously considered as datacenter energy optimization. We consider real world job arrival traces, as well as with synthetic bursty arrivals at different job network demands to characterize the benefits of our combined server network selection policy in terms of energy consumption and job latencies. We found that our approach provides 25-80% reduction in energy consumption compared to the case of optimizing server and network separately with conventional techniques.

important goals and overall contributions of our work are:

- We conceptualize the architectural sleep states for the switch, based on functional components and architectural design of

real world data center switches. We motivate the benefit of such sleep states to the overall system power efficiency.

- We propose a new algorithm that considers servers and networks energy characteristics to coordinate server task placement while considering the power drawn by network components. Transition between power states in switches is controlled by buffer sizes and traffic patterns.
- We evaluate the impact of having the low-power states in the switch and our policy which optimizes for lower energy consumption in our data-center simulator. We consider a FatTree data center topology with various configuration parameters such as network traffic sizes, CPU traces, server and network performance models.

2 POWER MODELS

2.1 Conceptual Network Switch Low Power States

Switch operates as OSI layer 2 network device, forwarding data frame from source port to destination port and a router works at layer 3 for routing interdomain network communication. A modular commercial switch such as the CISCO nexus line of switches consists of the following components:

- *Switch Chassis*: It houses the switch backplane, where all the modules are connected, power and cooling components. The chassis can also contain a variable number of configurable modules containing network interfaces and management modules.
- *Modules*: There can two kinds: Supervisor and I/O modules. The supervisor modules contains the decision making components of the switch, and I/O modules such as linecard where network ports are connected.

Due to lack of detailed power models for commercial switches, we propose and derive our switch power model based on available literature, [9] and corroborating with the cisco power calculator [10] for Nexus line of switches, and tools such as Cacti [6] Micron power modeling tools [11].

2.1.1 Supervisor modules

As shown in figure 1, the control pane where all forwarding decisions is performed by the SUP(Supervisor) module which consists of the Route Processor (OSI layer 3 function) and Switch Processing card(OSI layer 2 functions). The CISCO SUP2E contains DRAM upto 32GB(Core switches). According to Cisco power calculator [10], a routing processor card consumes upto 69W. We breakdown the components of the route processing card in table 2.

2.1.2 Line Card power Model

A linecard consists of several components such as ASICs, TCAMs, DRAM memory, and ports. Our power model for each component is explained below:

Due to lack of detailed power models for commercial switches, we propose and derive our switch power model based on available literature and memory power modeling tools from Micron [11]. A switch used in production uses the several components such as ASICs, TCAMs, DRAM memory, and ports. Our power model for each component is explained below:

1. ASICs/ Network Processors: The data plane operations of the switch such as parsing the packet contents to read the header, looking up routing tables, and forwarding data to the corresponding destination port are performed by the networking processor.

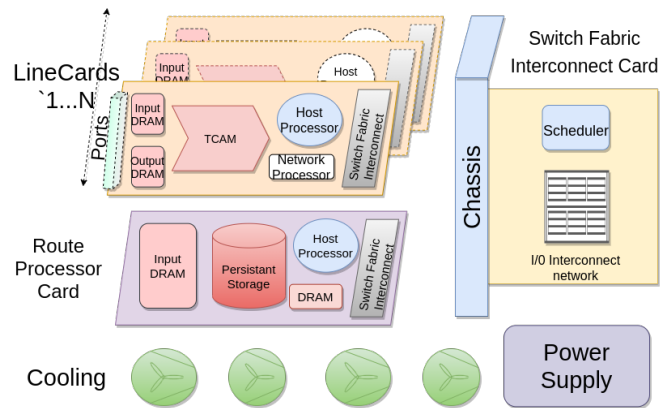

Fig. 1: Illustration of Switch architecture.

The processing is divided by two functional components: Forwarding Engine and Replication Engine. The Replication engine separates the header and data parts of a network packet and passes the header to the forwarding engine. The replication engine also reassembles the packet after its processed by the forwarding engine and in multicast communication duplicate packets to different destination ports. The forwarding engine is the decision making component in the line cards, and it uses the locally synchronized routing tables, QoS and ACL lookups. According to Wobker's report [12], this consumes 52% of the total power in enterprise Cisco line cards. Accordingly, the ASIC/network processor's power consumption is computed to be 165 W. Based on studies done by Iqbal et al. [13] and Luo et al.

To construct the energy saving sleep states, we draw parallels to the design of the sleep states in general purpose processors. In the first idle state, the clock can be set to the lowest frequency thereby resulting in 20% savings. In the first sleep state, the lookup caches in the forwarding engines can be flushed and clock gated along with the replication engines. In the next sleep state, the core processing clock and processor bus is clockgated. In the lowest sleep state state, the entire architectural state of the processor including runtime data from Forwarding information base rules, Qos Classification counters is written to the Linecard DRAM and power gated.

2. VoQ (DRAM memory and SRAM buffer): In Cisco line cards, the Virtual Output Queuing memory is used to provide buffering and queuing function to manage the QoS, packet replication, congestion control functions. The ingress DRAM is used to buffer incoming packets and the egress DRAM buffer is used store data payload while the header is being processed by the forwarding engine. The active power consumption of DRAM depends on the frequency of accesses, and leakage/static power depends on the transistor technology. Micron Power calculators [11] for RLDDR3 (Reduced latency DRAM) show a power consumption of 1571 mW per 1.125 GB of memory when active and 314 mW when in sleep. There is also a high speed SRAM buffer which acts as a write-back cache for the DRAM memory.

3. TCAM (Ternary Content addressable memory): The TCAM structure is used by the L3 routing function and to store routing table entries synchronized locally from the route processing card. A typical 4.5 Mb TCAM structure which is used to offload high-speed packet lookup, consumes 15 W of power [14]. We model the static leakage power for a 4.5 Mb CAM structure using Cacti [6], which estimates the power consumed during the idle sleep period when memory is not accessed.

TABLE 1: Single Linecard Power model for an Edge level Switch with 1 Gbps maximum bandwidth

	Active (1 Gbps Bandwidth)	Low power state 1	Low power state 2	Low Power state 3	Line Card - Deepest Sleep State
Packet Forwarding (Forwarding and replication Engines)	165W	132W	66W	33W	0W
	Active-Max Clock frequency	DVFS savings for the network processor.	Clock gating the lookup caches in the forwarding engines, Replication engines clock gated.	Forwarding engine's Core clock and bus stopped.	Architectural state flushed to DRAM and Forwarding engine and replication engines are power gated.
VoQ (M) (INPUT + OUTPUT)(max)	15.5W + 2 x 6 mW per MB of flow	15.5W+ 1 x 6mW per MB flow	4W	0 W	0 W
	Both Input and Output buffers active	Output VoQ buffer turned off	DRAM clock gated and contents lost.	DRAM Power gated	DRAM power gated
TCAM(max)	12W+ 2.6 mW per MB of flow	12W+2.6 mW per MB of flow	12W+2.6 mW per MB of flow	12W	0W
	TCAM active and synchronized	TCAM Active and synchronized	TCAM active and synchronized	TCAM stopped, synchronized, and clock gated.	TCAM-routing tables flushed and power gated
Interconnect Fabric interface	23W	23W	23W	0 W	0 W
	Active for Control plane operations	Active for Control plane operations	Active for Control plane operations.	Power gated, Control plane operation stopped	Power gated, Control plane operation stopped
Host Processor	24 W	22 W	9 W	9 W	3 W
	Active and running Linecard OS	Active and running Linecard OS, with DVFS	C3 state. Halt mode.	C3 state. Halt mode	C5 state: deeper sleep state
Ports	29 W	15W	4 W	4 W	4 W
	All 24 ports active	Output ports in Low Power Idle- Wake on Arrival	All ports in Low Power Idle-Wake on Arrival	All ports in Low Power Idle- Wake on Arrival	All ports in Low Power Idle- Wake on Arrival
Max Power Consumption in each state (310 W	250 W	151 W	45 W	7 W
1 Gbps when active)					

TABLE 2: Switch Chassis power model.

Switch Chassis components	At-least One Line card Active	All Line Cards in OFF state
Route processing card		
Hostprocessor	24W	0
DRAM-3GB	32.5W	0
Persistent Storage	10W	0
Switch Interconnect card		
Switch Fabric and I/O (40%load)	85W	0
Scheduler ASIC	24W	0
Chassis Controller		
Host-Processor	24W	24W
DRAM-3GB	12W	12W
Power Proportional Chassis Components		
Power supply losses per Active card (25%)	93W	5W
Cooling per Active Line Card (20%)	77W	4W

4. Line card Interconnect fabric: The line card communicates with the chassis bus using the interconnect interface. The line card fabric interconnect consumes 23W during active power state [9].

5. Host processor and local DRAM: Each line card includes a host processor which is used in line card boot and initialization process for copying routing table information from the switch fabric card. The processor is kept running in sleep mode to keep the routing tables synchronized and to wake up the line card on packet arrival. We assume a 30% power reduction due to dynamic

frequency scaling during line card sleep [15].

6. Ports: To tackle the energy consumption in network equipment, the IEEE 802.3az standard introduces the Low Power Idle (LPI) mode of Ethernet ports, which is used when there is no data to transmit, rather than keeping the port in active state all the time [4]. The idea behind LPI is to refresh and wake up the port when there is data to be transmitted; the wakeup duration is usually small.

Apart from the line cards, we model a constant baseline power of 120 W for the rest of the switch in ON state, which includes switch supervisor module, the backplane, cooling systems, switch fabric card based on Pan et al. [9]. The wakeup latency for each of the states is derived from sleep and wake up state conceptualized in section 2.2

2.2 Modeling switch sleep state transition and wake up latency

As shown in the Figure 2, we model the sleep policy for a switch based on the power model described in section 2.1. The line card unit of a switch is considered to be in active state when processing any output traffic, and idle when either there is no incoming traffic for certain period of time. In the first sleep state, the switch stops processing incoming packets but continues to receive new packets in the packet buffer to require the DRAM to be on the State.

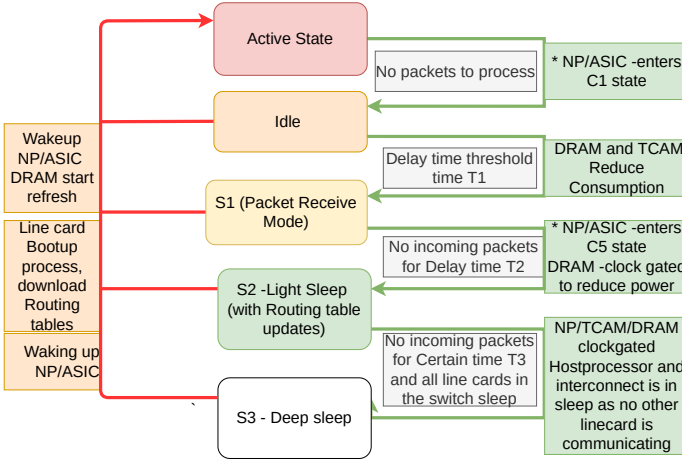

Fig. 2: Illustration of a Switch Sleep and Wakeup Transition process with 3 sleep states.

TCAM is not flushed to avoid the wakeup latency associated with re-populating the routing tables. In the second sleep state S2, the server's Energy consumption is reduced by setting the ASIC or Network processor to clock-gated state. In the second sleep state, additional savings can be achieved by turning off the DRAM, and deeper sleep state for the NP/ASIC. In the last sleep state, we clock gate the TCAM memories storing the routing tables, host processor and switch interconnects to be put in sleep state.

2.3 Server Low-power States and Power Model

With the focus on improving energy efficiency when servers are under-utilized, low-power states were created with goal of reaching energy proportional computing. For standardization across computing platforms, Advanced Configuration and Power Interface (ACPI) [2] specification gives the Operating system developers and hardware vendors common platform independent energy savings. ACPI has been historically well supported by various hardware vendors such as Intel and IBM [16]. ACPI uses global states, G_x , to represent states of the entire system that are visible to the user. We discuss the component-wise breakdown of such system states as described in the table 3.

Although processor sleep states can significantly reduce the power consumed by the processor, servers can still consume a considerable amount of power, as the platform may still remain active. As a result, in order to achieve further energy savings, *system sleep states*, that also put platform components into low-power state, are considered for server farm power management. We consider additional full system sleep state.

- **CPU(s) Power:** Low-power states are now an important feature that are widely supported in today's processors. In a multicore processor, each core can have different architectural components or features disabled or turned off by shutting down the clock signal or turning off power and such states are called C-states. A higher level C state or S state typically indicates more aggressive energy savings but also corresponds to long wakeup latencies. For multi-core processor, low-power sleep states are supported at both core level and package level. When all cores become idle and reside in some *Core C state*, the entire package would be resolved to a greater power saving state, denoted as *package sleep state*, which further reduces power.

- **Chipset** The chipset and board consume energy used to support the main chipset, voltage regulators, bus control chips, interfaces for peripheral devices. According to Intel specifications [17] the chipset has TDP of 6.5W. The minimal power savings in the deeper sleep states of the system can be ignored.

- **DRAM:** The DRAM power consumption can be separated into 3 parts, read/write energy, Activate and pre-charge energy to open the specific row buffer to operate upon and refresh power to continuously perform the refresh cycle. Characterizing the DRAM power depends on several factors such as:

1. DRAM technology DDR3, DDR4, LPDDR3L, etc with their respective power and performance characteristics.
2. Workload : number of last level cache misses: An application whose working memory does not fit into the CPU cache can have a lot misses.
3. Manufacturer optimizations: DRAM powerdown mode can be implemented differently by different manufacturers. The DRAM self-refresh cycle allows DRAM to be clock-gated from the external memory controller for self refreshing cycle.
4. Memory clock speed. Higher clock improves performance but consumes more memory.

We used the micron power calculator to arrive the power consumption of the memory components as shown in the table 1.

- **Power supply** We consider the AC-DC energy conversion loss which are typically 10% of the power consumed by the system.
- **Fans:** The power consumption of a cooling fan is directly proportional to the cubic function of current fan speed utilization

2.4 Modeling Job

More and more applications are being designed using a modular microservices-based paradigm, where inter-dependent tasks are hosted on different servers. The modularisation of job helps reduce complexities in software development, with independently updateable software programs in a scalable 'single-service instance per server' deployment pattern. We model the execution of jobs at the server side as consisting of multiple inter-dependent tasks that include both spatial and temporal inter-dependence. Application tasks are typically executed by specific server types. For example, a web service request will first be processed by an application or web server, and a search request is processed by a database server, and this kind of task relationship is called spatial inter-dependence. In terms of temporal inter-dependence, a task cannot start executing until all of its 'parent' tasks have finished their execution, and until after their results have been communicated to the server assigned to the task. A job is considered to have finished when all of its tasks finish execution. As for servers, there are multiple cores per server and one core can only process one task. We support asynchronous task execution by allowing the server running the parent task to release the cpu, after all flows are completed to the child tasks' server even if it is waiting in the queue for execution.

Each job j can be represented as a directed acyclic graph (DAG) $G^j(V^j, E^j)$, where V^j is the set of tasks of job j . In DAG, if there is a link from task i to task r , then task i^j must finish and communicate its results to task r^j before r^j can start processing. Each task $v^j \in V^j$ has a workload requirement, namely task size

TABLE 3: A Representative Server Power model with Multi-socket Xeon processors and 128GB DDR3

Server Power Component	Number of units	Active	Idle (G0)	G1	G2
CPU (Intel Xeon E5 V2 2690)	2	135W	108W	22W	15W
		Average sustainable power consumption (TDP)	All CPUs/cores set to lowest DVFS frequency with 20% savings	All cores of all CPUs in C3 state- Clock Stopped and Cache flushed but other architectural state maintained	All cores of all CPUs in C6 state- Power gating the CPU, after saving the architectural state to the DRAM
Chipset	1	8W	8W	8W	8W
		Chipset powering the interfaces and peripherals	Chipset powering the interfaces and peripherals	Chipset powering the interfaces and peripherals	Chipset powering the interfaces and peripherals
Memory (8x16GB DDR3)	8	1.45W	0.29W	0.29W	0.29W
		DRAM serving a normal utilization of reads writes (25% of all CPU cycles each) + ACT power (228mW) + I/O power (540mw) + Background + Termination power(672mW)	Memory without new Reads or Writes, with ACT and background power consumption, and Background power 57mW.	Memory without new Reads or Writes, with ACT and background power consumption, and Background power 57mW.	Memory without new Reads or Writes, with ACT and background power consumption, and Background power 57mW.
Disks (8 TB SSDs in RAID)	4	10W	10W	1W	1W
		Active mode	Active mode	standby power	standby power
Network Interface card	2	3W	3W	1W	1W
		Active mode	Wake-on-LAN mode	Wake-on-LAN mode	Wake-on-LAN mode
Power Supply losses	2	38 W	31W	7W	5W
		10% current system power consumption	10% current system power consumption	10% current system power consumption	10% current system power consumption
Cooling Fans 15W fans	2	10.5W	5W	5W	0 W
		70% of Full Power	30% Power	30% Power	Off
Total		385W	308W	73W	51W
Transition Time - To sleep		0usecs	10 usecs	100 usecs	500 msecs
			DVFS transition time	Transition to C3 state	Saving Architectural state of CPU to ram and power supply power up
Wakeup latency		0 usecs	100 usecs	100 msecs	1 second
			CPU frequency scale	Transiting all cores to C0 state	Transitioning CPU to Active state

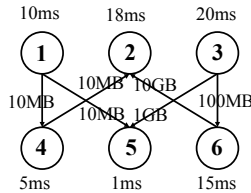

Fig. 3: Example of a job DAG. Numbers 1-6 denote task 1-task 6 respectively. Numbers around the tasks represent task size, while numbers on the links represent flow size.

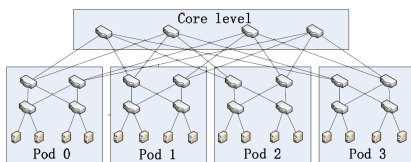

Fig. 4: Fat tree topology with $K=4$ (16 servers).

or execution time requirement w_v^j for the core. For each link in E^j , there is a data transfer size D_l^j associated with it, which denotes the bandwidth requirement to transfer the result over link l (from the task at the head of DAG link to the task at the tail) when assigned a network flow. Figure 3 shows an example of a job DAG.

2.5 Data Center System

Figure 4 shows the classic fat tree topology used in our network-server system, where each subset is called a 'pod'. In our system, each switch consists of a number of distributed cards plugged into the backplane, which provides the physical connectivity [9]. Among these cards, there are multiple line cards for forwarding packets or flows, and can be in active, sleep, or off state. In turn, each line card contains several ports connecting to external links, which can also be in active, LPI, or off state. A typical schematic of switch, line card, and port is shown in Figure 1.

3 DESIGN

3.1 Problem Definition

In this section, we formulate the joint server and data center network power optimization as a constrained optimization problem using the switch power model and job model defined above. First, to obtain the power consumption of a switch k , assume the number of active line cards and ports are ζ_k^{active} and ρ_k^{active} respectively, and the number of line cards in respective sleep states and ports in LPI mode are ζ_k^{sleep} and ρ_k^{LPI} respectively. Since the total power of a switch is the sum of base power P_k^{base} , power of ports, and power of line cards, then we have $P_k^{switch} = P_k^{base} + \zeta_k^{active} * P_{linecard}^{active} + \rho_k^{active} * P_{port}^{active} + \zeta_k^{sleep} * P_{linecard}^{sleep} + \rho_k^{LPI} * P_{port}^{LPI}$. To calculate the power consumption of server i , since our system considers the core as basic processing unit in server, the total

power of a server is the sum of idle power P_i^{idle} and dynamic power which is linear in the number of active cores C_i^{on} . Then we have $P_i^{server} = P_i^{idle} + C_i^{on} * P_{core}^{on}$, where P_{core}^{on} denotes the power consumed by an active core.

Then the joint power optimization problem can be formulated as minimize $\sum_{k=1}^{N_{switch}} P_k^{switch} + \sum_{i=1}^{N_{server}} P_i^{server}$ under both network-side and server-side constraints, such as link capacity, computation resources, etc.

3.2 Estimating the energy consumption

Modeling this joint power optimization problem in Datacenter Networks (DCN) as an Integer Linear Programming (ILP) formulation is a solution, and optimization tools like MathProg can be used to provide a near-optimal result. However, the computation complexity increases exponentially with the number of servers and switches [18]. In a typical data center with tens of thousands of servers and hundreds of switches, it is computationally prohibitive to solve the optimization problem. We therefore propose a computationally-efficient heuristic algorithm in this section.

3.3 Need for Switch sleep states

In this section, we motivate the need for having more sleep states in switches. As discussed in sections 2.2 and 2.1, the switch power consumption can be temporarily reduced by selectively turning off parts of the line cards and woken up when required. For components which do not have any memory or state the wakeup latency is the time it takes to initialize the system. For other components such as DRAM storing address forwarding tables should be reinitialized from the host line cards. In our study, we find that having multiple sleep states for the switch helps in trade-off various levels of wake-up latency for energy consumption reduction. This scheme is inherently useful when the idle period is not large enough to accommodate the high wastage of energy spent during waking from a single deepest sleep state and would cause network transmission to get delayed.

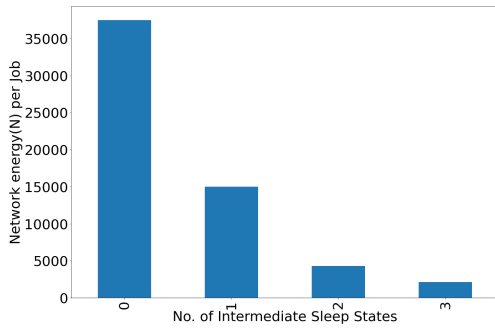

Fig. 5: Network Energy consumption normalized per job for a 1024 server FatTree topology network. Jobs containing two dependent tasks of 500ms CPU duration each arrive at 30 Job/second. The Switch sleep state and latency models are constructed using the power model defined in section 2.1.

3.4 Heuristic Algorithms

In this section, we first present a power management algorithm for the transition of line card and port power state, a simple power transition algorithm for servers, and then propose joint job placement and network routing algorithm for solving the optimization problem efficiently.

3.4.1 Power State Transition Algorithm

As not all switches in DCN need to be active all the time, if we can intelligently control the transition of active and low power state for ports and line cards, then data center network power consumption could be saved. Therefore, we propose the Power State Transition Algorithm 1 to implement network power management. The notations are elaborated in Table 5. We assume that there is a global controller that keeps record of all the line cards, ports, and server status, including their power state, queue size, etc. The global controller monitors the current traffic load (number of pending flows or packets) at each port and decides whether the current line card power state should change. It then decides if the port state should change as a feedback. In our design, we couple the line card and port power state and their transition: if a line card is in sleep or off state, then all the ports are also in LPI or off state; if a line card is active, then its ports can be in LPI or active state, and LPI ports can be woken up to become active in a short time.

Algorithm 1: Power State Transition Algorithm

```

Input:  $T_s, T_a, Q_{iL}$ 
Output: Line card and port state transition
1 Initialization: All line cards are in sleep state, all ports are in LPI state;
2 while there are jobs to be executed do
3   if a flow arrives at port  $i$  of line card  $L$  at time  $t$  then
4     if  $L$  is in sleep state then
5       if  $Q_{iL} > T_s$  then
6          $L$  begins waking up from sleep state;
7          $i$  begins waking up from LPI state;
8       end
9     else
10       $L$  begins waking up after  $\tau_{wakeup}^{LC}$ ;
11       $i$  begins waking up after  $\tau_{wakeup}^{port}$ ;
12    end
13  end
14 end
15 if a flow is transmitted from port  $i$  of line card  $L$  at time  $t$  then
16   if  $Q_{iL} < T_s$  then
17      $i$  starts transition to LPI after  $\tau_{LPI}$ ;
18     if after  $\tau_{LPI}$ , all the ports of  $L$  are in LPI state then
19        $L$  starts transition to deeper sleep state after  $\tau_{sleep}^{LC}$ ;
20     end
21   end
22 end
23 end

```

3.4.2 Popcorns-Pro-Cooperative Algorithm

Network-Server

The main idea of our algorithm is to jointly consider the status of server pool and network before assigning jobs. To be more specific, for a job consisting of several pairs of interdependent tasks, if we place task pairs based on their interdependence, and choose the core pair with the minimum routing cost, instead of randomly placing them on available cores without awareness of communication requirement between tasks, then the placement together with its corresponding routing path must be the optimal. And in the context of this paper, network routing cost is energy consumption, since every line card on the chosen routing path has to be active, or it will have to be woken up.

Based on this idea, we propose the Cooperative Network-Server (CNS) Algorithm 4. The notations are elaborated in Table 5. In the initial stage, we compute and store all possible routing paths between any pair of network nodes. As mentioned in the previous section, we have a global controller to keep track of all the line cards, ports, and server statuses. Thus, when a job consisting of a set of interdependent tasks arrive, we first check the server side

TABLE 4: Estimating the energy consumption

Energy Component		Description
Server Energy		
Candidate server	Server Task Execution Energy	Energy consumed when the task is being executed
	Server waiting for transmission	Energy consumed when the task is waiting for communication to complete.
Server (If sleeping)	Wakeup Energy during transition	Energy spent during wakeup.
	Core Energy savings loss Sleep	If sleeping, Energy savings loss due to Active state
	Package Energy savings loss Sleep	If the first core being woken up, CPU package sleep savings loss.
Network Energy		
For Each Switch in the candidate flow path	Network Energy cost based on Bandwidth-allocated	Every flow is allocated a BW based on the network congestion and link capacity of the entire flow path, flow's minimum bandwidth the requirement to meet QoS.
	Wakeup Energy during transition	Energy spent to transition to active state
	Line card Active energy	If the Linecard is sleeping, the energy cost is the full active power consumption.
For Every flow in common path of the candidate path	Energy savings due to decreased Bandwidth for the every other flow	For every other switch in the current flow path whose BW is reduced, calculate the energy spent on it.

Symbol	Description
P	all the routing paths between any pair of network nodes
Q_s	local queue size of server s
T_s^{server}	local queue size threshold of server s
S	all the servers in DCN
S_{ava}	all the servers whose current queue size doesn't exceed T_s^{server}
$P_{x,y}$	all the routing paths between node x and y in DCN
T_s	traffic threshold for port waking up
T_a	traffic threshold for port turning into LPI state
Q_{iL}	current traffic load at port i in line card L
τ_{wakeup}^{port}	port wakeup delay
τ_{wakeup}^{LC}	line card wakeup delay
τ_{LPI}^{port}	port turning into LPI state delay
τ_{sleep}^{LC}	line card turning into sleep state delay

TABLE 5: Notations in Popcorns-Pro Cooperative Network-Server Algorithm.

to select all server pairs whose power state is active and local queue sizes do not exceed a threshold. If no server satisfies these requirements, then servers with full local queue and servers in C6 sleep state will be selected. Note that if a task is assigned to a server in sleep state, then the server will be activated immediately and enter active state after a wakeup latency. For each server pair we select possible routing paths between them from the pre-computed routing paths set. Along each path, line cards could be active, sleeping, or off, and ports could be active, LPI, or off, but if we assign a path to the task pair, all the line cards and ports along it should become active. In other words, we need to wake up the inactive line cards and ports on the chosen path, which results in extra power consumption and wakeup latency. Based on this, we can compute and assign a weight, which is a measurement of the number of active line cards and ports, to each possible routing path, and choose the server pair with minimum routing cost. And our proposed Cooperative Network-Server Algorithm will output the least-weight path and its corresponding server pair for each task pair.

4 EVALUATION

4.1 Experimental Setup

Our experiments were performed using HoDCSim, an event-driven simulator [19], which simulates interdependent asynchronous task executions, and implement custom server job scheduling and network routing algorithms. This allows us to simulate a large number of servers and switches relatively easily. The simulator allows us to specify our own power model and sleep state transition mechanisms and calculate the overall energy consumption for the simulator. The network is configured using a fat tree-topology as shown in Figure 4. We simulate two classes of real-world applications: *web service*: two large sized (uniformly distributed around 500 ms service time) parent-child tasks, *web*

Algorithm 2: Popcorns-Pro- Cooperative Network-Server Algorithm

Input: P, Q_s, T_s , line cards and ports power state, task dependency within a job
Output: Job placement and corresponding routing path

```

1 while job  $j$  consisting of task set  $T^j$  arrives do
2   for each pair of interdependent tasks  $(T_m^j, T_n^j)$  in  $T^j$  do
3     select  $S_{ava}$  from  $S$ ;
4     for each pair of available servers  $(x, y)$  in  $S_{ava}$  do
5       compute  $P(x, y)$  for server pair  $(x, y)$  from  $P$ ;
6       for each path  $p$  in  $P(x, y)$  do
7         get power states of all the ports and line cards along  $P$  from
           the global controller, compute path weight  $w(x, y)$  in terms
           of energy consumption;
8       end
9     end
10    choose the least-weight path associated with corresponding server pair
        for task pair  $(T_m^j, T_n^j)$ ;
11  end
12 end
```

search: a parent task search task querying five subtasks to run smaller search process (uniformly distributed around 100 ms CPU service time). All the network routing policies consider the QoS threshold of 10X the total CPU time of all tasks in the job when choosing the job selection.

We assume that each of the tasks can be executed on any server machine and if enough processing cores available co-located in the same server. The communication patterns and the DAG for the two workloads are illustrated in Figure 6, and Figure 7.

We carefully select delay timer values for sleep state transitions [20] for server and network by trying each value in the search-space, starting with first determining the delay timer value for Sleep state 1 with the lowest energy consumption, then fixing the lowest timer value found previously for state 1 to determine the delay timer for sleep state 2, and so on.

4.1.1 Job arrivals patterns

We use two kinds of job arrivals in our study. The arrival rate is given by $\lambda = (Numservers * Num * Cores * \rho) / AvgTaskSize * NumTasksperJob$. Thereby targeting ρ values of 15%, 30% and 60% we derive the λ values. Due to the variation in the scheduling policy, task inter-dependency, randomized job task and arrival times and sleep state transitions the resultant server utilization level may not match with targeted utilization levels.

Markov Modulated Poisson Process: Similar to workload used in [20], MMPP arrivals generates a two different states of arrival rates. The normal utilization phase similar to the Poisson workload and a bursty period where the arrival rate is 1.5X the λ in the normal phase. We choose the bursty period to last 10 secs between 20 seconds of normal phase. The load levels of low, medium and

Algorithm 3: Popcorns-Pro- Weight assignment algorithm between two nodes

Input: $Link(i, j)$, QoS , $LinkCapacity$
Output: $W(i, j)$ Weight for the edge connecting nodes i and j

```

1 if Node  $i$  is Server then
2    $LinkWeight(i, j) += (ServerActivePower - CurrentSleepStatePower) * (taskSize + EdgeLinkBW / FlowSize)$ ;
3 end
4 if Node  $j$  is a Switch then
5    $LinkCapacity_{remaining} \leftarrow Link_{fullCapacity}$ ;
6   for EveryFlow  $F_i$  on Link  $(i, j)$  do
7      $Flow_i_{remainingTime} \leftarrow FSize_{remaining} / FcurBW_i$ ;
8     if  $F_i_{remainingTime} > SlowestTime$  then
9        $SlowestTime \leftarrow F_i_{remainingTime}$ ;
10       $SlowestFlow \leftarrow F_i$ ;
11    end
12     $LinkCapacity_{remaining} - = FcurBW_i$ 
13  end
14   $availBW \leftarrow \min(Link_{fullCapacity} - LinkCapacity_{remaining} \text{ and } EdgeLinkBW)$ ;
15  if  $availBW > MinBW \text{ for } QoS$  then
16     $timeForNewFlow \leftarrow availBW / FSize_{newFlow}$ ;
17     $additionalTimeAwake \leftarrow MAX(SlowestTime \text{ and } timeForNewFlow)$ ;
18     $LinkWeight(i, j) += additionalTimeAwake * ActivePower_j$ ;
19  end
20 else
21     $FcurBW_{newFlow} \leftarrow FSize_{newFlow} / QoSRequiredTime$ ;
22     $FcurBW_{Slowest} \leftarrow (FcurBW_{Slowest} - (availBW - (FcurBW_{newFlow} / NumFlowsOnLink)))$ ;
23     $AdditionalTime_{SlowestFlow} \leftarrow (FcurBW_{Slowest} - FcurBW_{Slowest}^i) / FlowData_{remaining}_{Slowest}$ ;
24     $timeForNewFlow \leftarrow QoSRequiredTime$ 
25     $additionalTimeAwake \leftarrow MAX(timeForNewFlow \text{ and } AdditionalTime_{SlowestFlow})$ ;
26     $LinkWeight(i, j) += additionalTimeAwake * ActivePower_j$ ;
27  end
28 end

```

Algorithm 4: Job scheduling Algorithm

Input: P , Q_s , T_s , line cards and ports power state, task dependency within a job
Output: Job placement and corresponding routing path

```

1 while job  $j$  consisting of task set  $T^j$  arrives do
2   for each pair of interdependent tasks  $(T_m^j, T_n^j)$  in  $T^j$  do
3     select  $S_{ava}$  from  $S$ ;
4     for each pair of available servers  $(x, y)$  in  $S_{ava}$  do
5       compute  $P(x, y)$  for server pair  $(x, y)$  from  $P$ ;
6       for each path  $p$  in  $P(x, y)$  do
7         get power states of all the ports and line cards along  $P$  from the global controller, compute path weight  $w(x, y)$  in terms of energy consumption;
8       end
9     end
10    choose the least-weight path associated with corresponding server pair for task pair  $(T_m^j, T_n^j)$ ;
11  end
12 end

```

high arrival rate and obtained in the similar fashion as the basic poisson based arrival workload.

Trace based arrival job arrival pattern: We use publicly available job arrival trace from NLANR [21] for a real world system. We chose NLANR trace since it inherently has a high variation in job inter-arrival rate. The load levels of low, medium and high arrival traces are obtained by scaling the inter-arrival times between the jobs in the original trace by a factor.

4.1.2 Quality of Service Constraints

We consider the minimum time a job takes to complete to be the sum of computation time of each task in the job and time it takes for all the inter-task communications to finish at the fastest possible bandwidth in the network. For instance, for a two-task job with 500ms of CPU cost each and a 10 MB of network communication on the 10 Gbps maximum link capacity between two nodes, the minimum time for job execution will be $500ms \times 2 + 75 \text{ ms (data transfer time)} = 1075 \text{ ms}$. Similar to other works

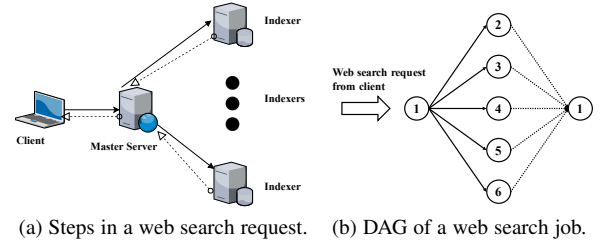

Fig. 6: Web search communication patterns (left) and DAG of a web search job (right). Task 1 is executed by the master server, while task 2 - 6 are processed by different indexers, and master server communicates with all the indices.

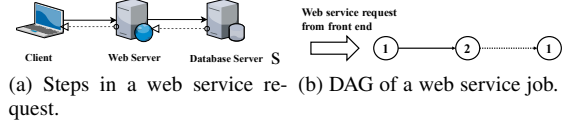

Fig. 7: Web service communication patterns (top) and DAG of a web service job (bottom). Task 1 is executed by application server, while task 2 is assigned to database server.

(e.g., [20]), we consider the quality of Service (QoS) deadline for the job scheduler to be 10 X the minimum job execution to enable enough slack to allow multiple jobs and enable energy optimizations.

4.2 Baseline policies and Evaluation methodology

There are two major objectives: first to prove that the smart use of line card sleep states with our proposed Algorithm 1, does reduce power consumption in Popcorns-Pro compared to no power management policy on the switches at all; second, our proposed Popcorns-Pro algorithm 4 can further save power, compared to other job placement algorithms not taking both the network and server status into consideration. We consider the four combinations of the below server-specific and network-specific energy optimization policies. As shown in the section 3.3, we have seen that switch sleep states without any optimization can still yield some energy savings, and it is important to further optimize the energy savings for them.

4.2.1 Server based policies

The below two policies represent a common server selection policy and energy optimized server policy. **Random Server allocation-SB** Following a traditional server load balancing approach, tasks are assigned randomly to all servers and the processing cores as they come in, without any consideration for task dependency and core locality in the data centers.

Workload Adaptive using Server Low-Power State Partitioning-WASP This policy represents recent works [20] which consolidate jobs into fewer server while optimizing for keeping more servers in sleeping state. These optimizations are typically developed by system developers without considering the network energy optimization. In WASP, a set of servers are kept in the unused state to allow them to achieve the most energy efficient sleep state, while the remaining jobs are processed on the remaining servers. The servers are reassigned between the two sets depending the measured input load on the entire server pool.

4.2.2 Network based policies

The following two approaches to network routing in the data center.

Shortest Path-SP This baseline network path allocation uses Dijkstra’s algorithm to forward flows across the two end points. This policy represents the traditional network routing algorithm available which chooses the shortest number of hops which also considering the QoS latency requirements for the current flow.

Elastic tree-ET Recent work on the improving network energy efficiency have considered various heuristics to consolidate flows into fewer switches. The Elastic tree [22] baseline represents one of the most commonly cited work in this area, which tries keep fewer switches in active state in highly redundant network topologies such as the fat tree topology. We implement the greedy bin packing approach in our experiment where the heuristic chooses the leftmost path at every switch exit to reach the destination. These approaches assume a fixed server task allocation and hence cannot fully optimize for efficiency.

Figure 8, illustrates the heat map after the end of the execution of the same Poisson based random job arrival pattern with mean arrival rate $\lambda=0.5$ Jobs/second using the different server and network job scheduling policies for a small 16 server Fat-Tree topology. We note that with random server selection, all servers are equally utilized with elastic tree based network scheduling performing more network consolidation for better savings. When using random server selection for tasks with Shortest path routing 8a and Elastic based routing 8b, we can see that there are more aggregate switches in the dark green allowing more switches to stay in deep sleep state. Similarly for the WASP server selection scheme in figures 8c and 8d, we see that there are unequal usage of the servers and more flows consolidated into fewer switches. It can be seen that even with server energy optimization in WASP, and our combined server and network policy Popcorns-Pro 8e can achieve much higher savings than each of the individual optimizations. Popcorns-Pro algorithm is able to achieve this mainly due to being aware of network energy aware state when scheduling jobs on the servers. It is further able to reduce energy savings by increased consolidation of flows and servers by utilizing the latency slacks available at each node in the data center.

service and its corresponding job DAG. In simulation, we set the flow size to be 100KBytes and average job service time is randomly generated between 150ms and 200ms based on prior studies [23].

4.3 Evaluation Results

4.3.1 Energy Savings Comparison

We compare the average energy consumption per job, for different combination of network and server selection algorithm with Popcorn’s selection algorithm. We compare against a combination baseline policies WASP and random server allocation policies with Elastic tree and Shortest Path network selection algorithms. As shown in Figure 9, popcorn algorithm for 2-task service based job model for random arrival job provides significant savings compared to Shortest-path based policies. This is attributed to fewer switches and server being active. For ElasticTree based runs in figure 9, using WASP as server allocation policy does provide more opportunities for network consolidation and hence decreased savings. As we increase the arrival rate to 60 Jobs/sec in figure, we see that Elastic tree based runs perform closer to Popcorns-Pro as there are fewer opportunities for savings. We note

that due to the bursty nature of MMPP arrival rates (as discussed in section 4.1.1), the increased delay in waking up additional switches leads to slower flow transmission rate and increased energy consumption. We gather that server-only optimizations are not always optimal when considering the whole data center energy consumption. With NLNR trace based job arrivals.

For Search based workload discussed in beginning of section 4, the Popcorns-Pro algorithm still results in significant savings. We also see WASP based server optimization consistently performing better than Random server allocation. This is attributed to smaller communication size between each parent and child tasks and minimal time wasted waiting for the network data to arrive for processing.

4.4 Flow size sensitivity

The goal of this experiment is to determine if the routing path and server selection by Popcorns-Pro algorithm is resilient to increases in network flow sizes and thereby increased network utilization. As we see in figure 13 the Popcorns-Pro policy’s is able to select paths and servers which are least affected by the increase in flowsizes. Shortestpath based policies use most number of switches and with increasing flow sizes there are fewer chances going to sleep and hence consume the most energy. Elastic tree’s greedy bin packing of flow consolidation benefits from some network consolidation but with the non-optimal server selection leading to longer flow communication times, the energy consumption increases exponentially.

4.5 Job completion latency Comparison

Although all the algorithms discussed, consider the QoS latency threshold of 10x (Sum of Task Size of all the tasks in the job) for network routing path selection, we see that the jobs in the Popcorns-Pro algorithm are much below the threshold in figure 14. Comparing WASP based policies with Server balanced random server selection scheme, fewer servers being utilized in WASP, the transmission time is higher and thus resulting in higher latencies.

4.6 Energy Distribution

In this section we illustrate how system architects can utilize our simulated settings and the power model to understand which component in the hardware 15 shows the energy consumed by each component in the switch power model at each of the sleep state of the switch for typical workload. This allows the system architect to focus their limited resources towards optimizing a particular system architecture. For instance, looking at figures 15 and 16, we see that most energy consumed by the network processor in its deepest sleep state. It can also tell that a high cost design change for Sleep state S1 has more benefit when using the Popcorns policy when compared to WASP and Elastic tree policy.

5 RELATED WORK

With the energy consumption of large data centers reaching Gigawatt scale, its energy saving techniques are increasingly being studied in recent years. Common techniques used for server energy reduction include Dynamic voltage and frequency scaling (DVFS) to reduce the energy at the cost of server performance, Co-ordinated DVFS and sleep states for server processors [24] [20], and virtualization to consolidate VMs into fewer servers [25]. TS-Bat [24] demonstrates that, through temporally batching the jobs

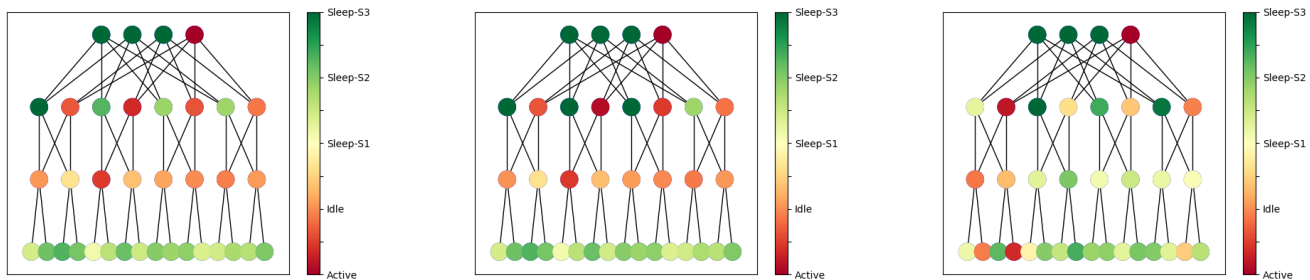

(a) Shortest Path and Random Server job scheduling (b) Elastic Tree and Random Server job scheduling (c) Shortest Path and WASP Server job scheduling

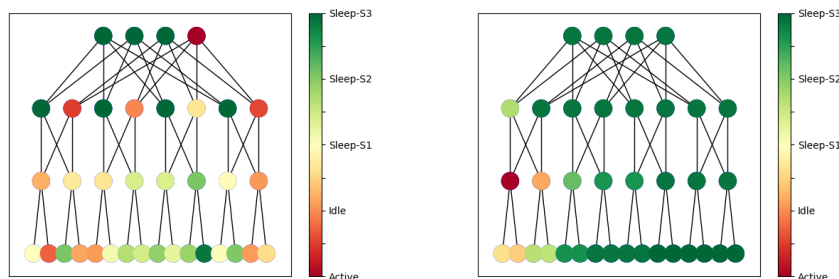

(d) Elastic Tree and WASP Server job scheduling (e) Popcorns based server and network scheduling

Fig. 8: Illustration of the average sleep state for switches and server with different policies. Popcorns-Pro scheduling policy achieves greater consolidation of server and network flows.

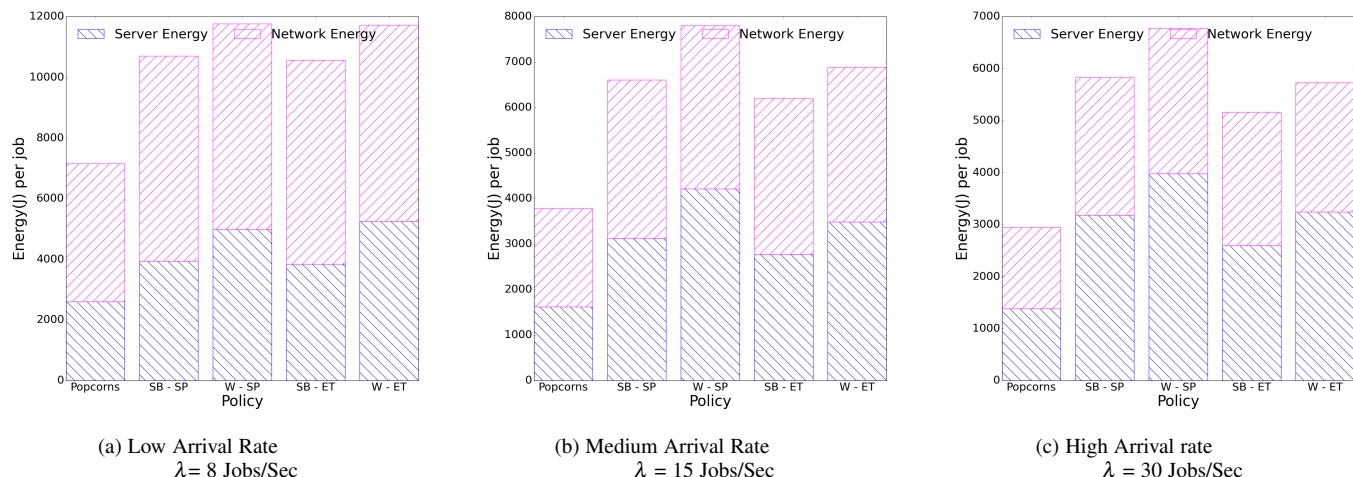

Fig. 9: Energy Savings comparison for different server and network path selection algorithms with MMPP based Job Arrival Pattern for service based 2 task model. Every 30 seconds we have 10-second bursts with 1.5x Arrival rate.

and by grouping them onto specific servers spatially, higher power savings can be obtained. WASP [20] shows that intelligent use of low power states in servers can be used to boost server power savings.

For the energy efficiency in network, earlier works have looked at switches and routers for Internet-scale large area networking. Gupta et al. [3] first proposed the need for power saving in networks and pointed to having network protocol support for energy management. Adaptive Link Rate (ALR) [4] reduces link energy consumption by dynamically adjusting data link rate depending on traffic requirements. Other approaches include turning off switches

when not required, or to put them in sleep mode depending on packet queue length [26] Prior work on reducing data center network power rely on DVFS and sleep states [13] to opportunistically reduce power consumption of individual switches. In these approaches, switches may enter sleep states without knowledge of incoming server traffic and may be forced to wake up prematurely. We study a co-ordinate server job placement and network allocation required to optimize the amount of sleep time and save network energy consumption. Recently, DREAM [27] proposed a probability based network traffic distribution scheme by splitting flows to save network power.

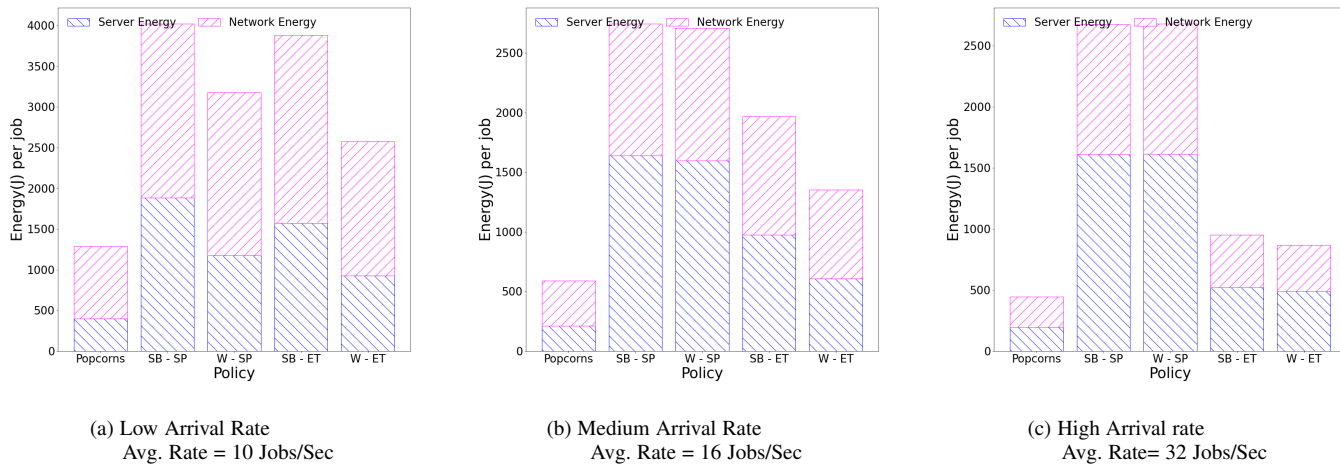

Fig. 10: Energy Savings comparison for different server and network path selection algorithms with NLNR trace based Job Arrival Pattern for service based 2 task model.

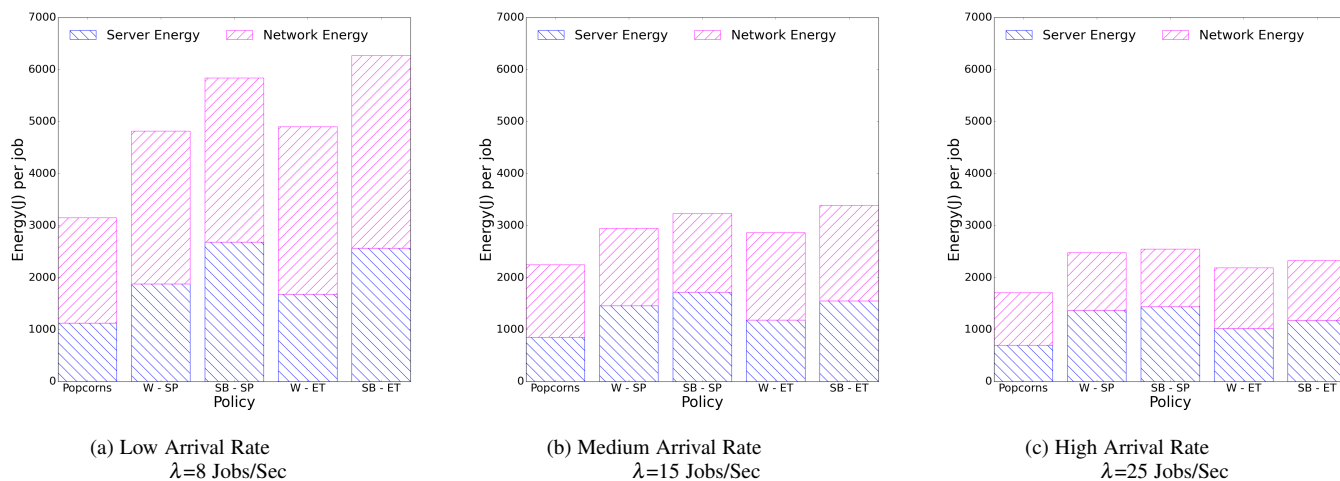

Fig. 11: Energy Savings comparison for different server and network path selection algorithms with MMPP based Job Arrival Pattern for search based 6-task job model. Every 30 seconds we have 10-second bursts with 1.5x Average Arrival rate.

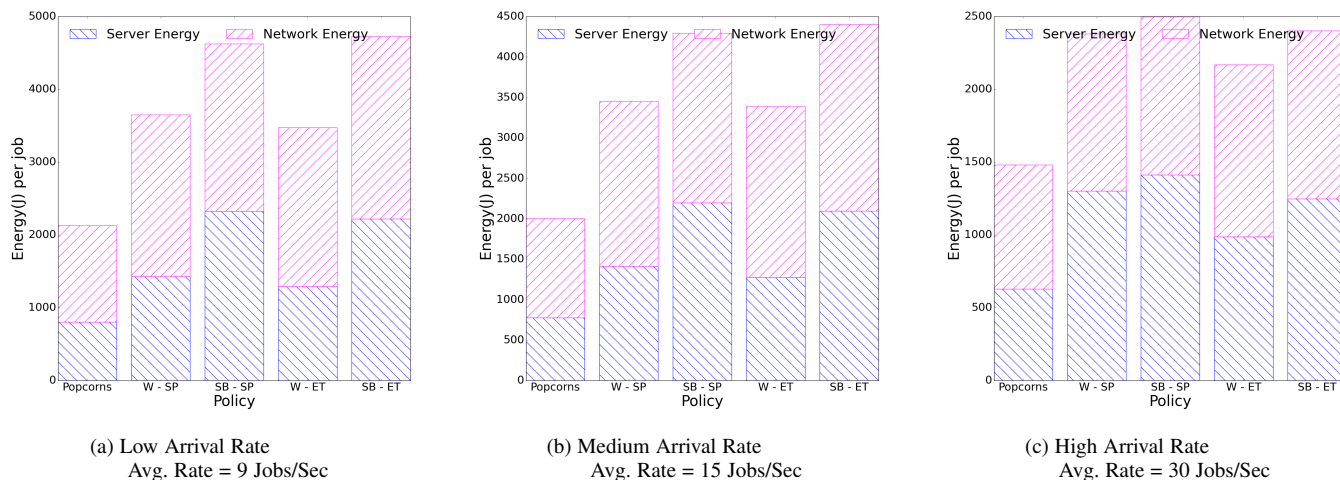

Fig. 12: Energy Savings comparison for different server and network path selection algorithms with NLNR trace based Job Arrival Pattern for search based 6-task job model.

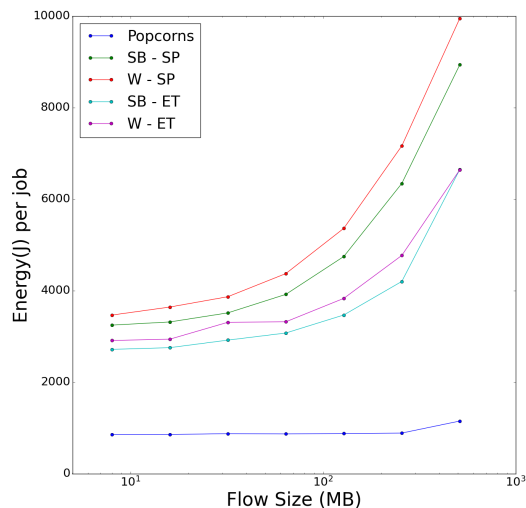

Fig. 13: Energy consumption/Job for various flow sizes for different server scheduling and network routing algorithms. The experiment involves a 1024 server fat-Tree topology with WebService jobs arriving randomly with a Poisson random variable value $\lambda = 25$ jobs/sec and 10X QoS threshold.

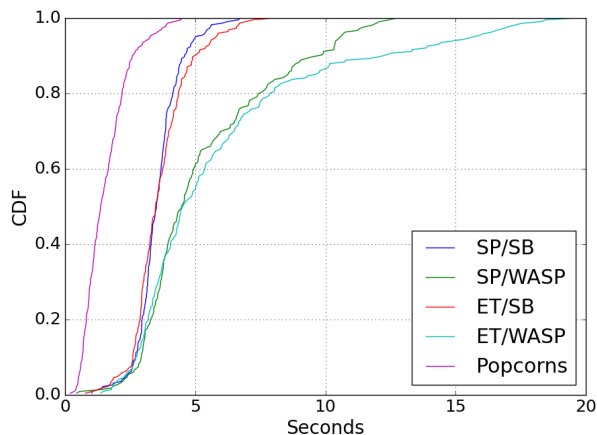

Fig. 14: Cumulative-Distributed-function plot of job latencies for different server scheduling and network routing algorithms. The experiment involves a 1024 server fat-Tree topology with WebService modeled jobs arriving randomly with a Poisson random variable value $\lambda = 25$ jobs/sec and QoS threshold as 10X.

There are existing works which combine server and network power saving. Mahadevan et al. [28] and Heller et al. [22] have proposed a heuristic based algorithm for a coarse-grained load variation which dynamically allocates the servers required for the workload and powers off the unneeded switches for the server configuration. Other approaches consolidate VMs in fewer servers and in turn fewer switches [29]. These approaches assume an unrealistically high amount of idle period to offset the large wakeup latencies to transition between On and Off states. To the best of our knowledge our solution is the only one to consider network sleep states to target higher power savings in the data center. The EEPRON [30] discussed using the network slack available to reduce the energy consumption of servers with frequency scaling.

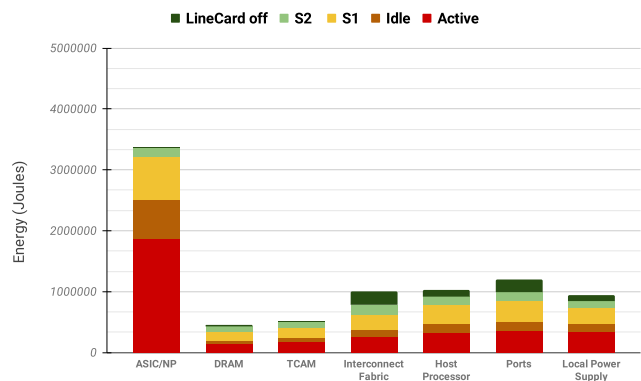

Fig. 15: Component-wise energy distribution for Popcorns in Joules for 500 second execution of 1024 server Fat-Tree topology with WebService model jobs arriving randomly (Poisson distribution) with $\lambda = 25$ jobs per second. The energy consumed at different sleep states of the switch is also shown.

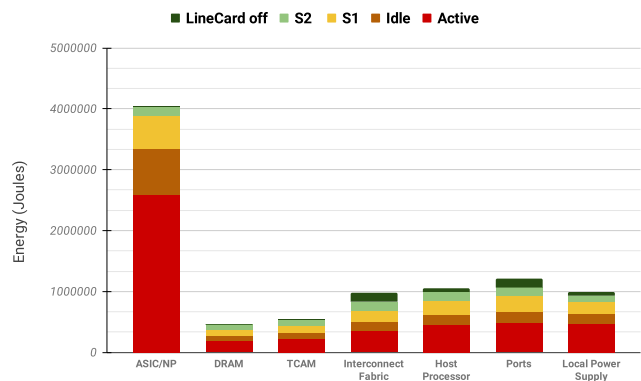

Fig. 16: Component-wise energy distribution for WASP server scheduling policy with Elastic tree as network routing algorithm in Joules for 500 second execution of 1024 server Fat-Tree topology with WebService model jobs arriving randomly (Poisson distribution) with $\lambda=25$ jobs per second. The energy consumed at different sleep states of the switch is also shown.

6 CONCLUSION

In this article, we presented Popcorns-Pro, where we explore techniques that make smart use of line card and port low power states in switches and orchestrate them with intelligent joint task placement and routing algorithm for more effective power management. The results show good promise in achieving considerable power savings compared to the baseline policies. Our experimental results show that smart management of low power states achieves upto 80% over policies optimizing servers and network policies separately, while still keeping energy savings low.

ACKNOWLEDGMENT

This material is based in part upon work supported by the National Science Foundation under Grant Number CNS-178133. Kathy Nguyen and Gregory Kahl were supported through a REU supplement under the NSF award.

REFERENCES

- [1] L. A. Barroso and U. Hözl, "The Case for Energy-Proportional Computing," vol. 40, no. 12, pp. 33–37.

- [2] “ACPI 6.2.”
- [3] M. Gupta and S. Singh, “Greening of the Internet,” in *Proceedings of the 2003 Conference on Applications, Technologies, Architectures, and Protocols for Computer Communications*, SIGCOMM ’03, pp. 19–26, ACM.
- [4] C. Gunaratne, K. Christensen, B. Nordman, and S. Suen, “Reducing the Energy Consumption of Ethernet with Adaptive Link Rate (ALR),” vol. 57, no. 4, pp. 448–461.
- [5] S. Lal, J. Lucas, and B. Juurlink, “SLC: Memory Access Granularity Aware Selective Lossy Compression for GPUs,” in *2019 Design, Automation Test in Europe Conference Exhibition (DATE)*, pp. 1184–1189.
- [6] R. Balasubramanian, A. B. Kahng, N. Muralimanohar, A. Shafiee, and V. Srinivas, “CACTI 7: New Tools for Interconnect Exploration in Innovative Off-Chip Memories,” vol. 14, no. 2, pp. 14:1–14:25.
- [7] J. Chen, F. Yao, and G. Venkataramani, “Watts-inside: A hardware-software cooperative approach for Multicore Power Debugging,” in *2013 IEEE 31st International Conference on Computer Design (ICCD)*, pp. 335–342.
- [8] B. Lu, S. S. Dayapule, F. Yao, J. Wu, G. Venkataramani, and S. Subramaniam, “PopCorns: Power Optimization Using a Cooperative Network-Server Approach for Data Centers,” in *2018 27th International Conference on Computer Communication and Networks (ICCCN)*, pp. 1–9.
- [9] T. Pan, T. Zhang, J. Shi, Y. Li, L. Jin, F. Li, J. Yang, B. Zhang, X. Yang, M. Zhang, H. Dai, and B. Liu, “Towards Zero-time Wakeup of Line Cards in Power-aware Routers,” vol. 24, no. 3, pp. 1448–1461.
- [10] “Cisco Power Calculator.”
- [11] “Micron memory Power Calculators.”
- [12] L. Wobker, “Power Consumption in high-end routing systems..”
- [13] M. F. Iqbal and L. K. John, “Efficient Traffic Aware Power Management in Multicore Communications Processors,” in *Proceedings of the Eighth ACM/IEEE Symposium on Architectures for Networking and Communications Systems*, ANCS ’12, pp. 123–134, ACM.
- [14] Q. Guo, X. Guo, Y. Bai, and E. İpek, “A resistive TCAM accelerator for data-intensive computing,” in *2011 44th Annual IEEE/ACM International Symposium on Microarchitecture (MICRO)*, pp. 339–350.
- [15] Y. Liu, S. C. Draper, and N. S. Kim, “SleepScale: Runtime Joint Speed Scaling and Sleep States Management for Power Efficient Data Centers,” in *Proceeding of the 41st Annual International Symposium on Computer Architecture*, ISCA ’14, pp. 313–324, IEEE Press.
- [16] M. Ware, K. Rajamani, M. Floyd, B. Brock, J. C. Rubio, F. Rawson, and J. B. Carter, “Architecting for power management: The IBM® POWER7™ approach,” in *HPCA - 16 2010 The Sixteenth International Symposium on High-Performance Computer Architecture*, pp. 1–11.
- [17] “Intel® X99 Chipset Product Specifications.”
- [18] P. Wang, H. Xu, Z. Niu, D. Han, and Y. Xiong, “Expeditus: Congestion-Aware Load Balancing in Clos Data Center Networks,” vol. 25, no. 5, pp. 3175–3188.
- [19] “HolDCSim: A Holistic Simulator for Data Centers* — IEEE Conference Publication — IEEE Xplore.”
- [20] F. Yao, J. Wu, S. Subramaniam, and G. Venkataramani, “WASP: Workload Adaptive Energy-Latency Optimization in Server Farms Using Server Low-Power States,” in *2017 IEEE 10th International Conference on Cloud Computing (CLOUD)*, pp. 171–178.
- [21] “National Lab of Applied Network Research..”
- [22] B. Heller, S. Seetharaman, P. Mahadevan, Y. Yiakoumis, P. Sharma, S. Banerjee, and N. McKeown, “ElasticTree: Saving energy in data center networks.,” in *Nsdi*, vol. 10, pp. 249–264.
- [23] D. Meisner, B. T. Gold, and T. F. Wenisch, “PowerNap: Eliminating Server Idle Power,” p. 12.
- [24] F. Yao, J. Wu, G. Venkataramani, and S. Subramaniam, “TS-BatPro: Improving Energy Efficiency in Data Centers by Leveraging Temporal-spatial Batching,” pp. 1–1.
- [25] C.-H. Hsu, K. D. Slaughter, S.-C. Chen, and Y.-C. Chung, “Optimizing Energy Consumption with Task Consolidation in Clouds,” vol. 258, pp. 452–462.
- [26] Q. Yu, T. Znati, and W. Yang, “Energy-efficient, Delay-aware packet scheduling in high-speed networks,” in *2015 IEEE 34th International Performance Computing and Communications Conference (IPCCC)*, pp. 1–8.
- [27] L. Zhou, L. N. Bhuyan, and K. K. Ramakrishnan, “DREAM: DistRibuted Energy-Aware traffic Management for Data Center Networks,” in *Proceedings of the Tenth ACM International Conference on Future Energy Systems*, pp. 273–284, ACM.
- [28] P. Mahadevan, P. Sharma, S. Banerjee, and P. Ranganathan, “Energy Aware Network Operations,” in *Proceedings of the 28th IEEE International Conference on Computer Communications Workshops, INFOCOM’09*, pp. 25–30, IEEE Press.
- [29] K. Zheng, X. Wang, L. Li, and X. Wang, “Joint power optimization of data center network and servers with correlation analysis,” in *IEEE INFOCOM 2014 - IEEE Conference on Computer Communications*, pp. 2598–2606.
- [30] L. Zhou, C. Chou, L. N. Bhuyan, K. K. Ramakrishnan, and D. Wong, “Joint Server and Network Energy Saving in Data Centers for Latency-Sensitive Applications,” in *2018 IEEE International Parallel and Distributed Processing Symposium (IPDPS)*, pp. 700–709.



Sai Santosh D is currently pursuing the Ph.D. degree with the Department of Electrical and Computer Engineering, The George Washington University. His research interests are in Datacenter energy Efficiency and computer architecture.

Kathy Nguyen is a graduate student with the Department of Electrical and Computer Engineering, The George Washington University. Her research interests are in Datacenter energy Efficiency and simulator development.

Gregory Kahl was an undergraduate student with the Department of Electrical and Computer Engineering, The George Washington University. His research interests are in Datacenter energy Efficiency and application development.

Dr. Suresh Subramanian is a Professor and a Chair of Electrical and Computer Engineering with George Washington University, Washington, D.C., where he directs the Lab for Intelligent Networking and Computing. He has published over 230 peer-reviewed papers in these areas. His research interests are in the architectural, algorithmic, and performance aspects of communication networks, with current emphasis on optical networks, cloud computing, data center networks, and IoT.



Dr. Guru Venkataramani is a Professor of Electrical and Computer Engineering at George Washington University, Washington, DC, USA. His research areas are computer architecture, security, and energy optimization.

