

Bipartite Temporal Graphs and the Parameterized Complexity of Multistage 2-Coloring

Till Fluschnik* and Pascal Kunz†

Technische Universität Berlin, Algorithmics and Computational Complexity,
Berlin, Germany
{till.fluschnik, p.kunz.1}@tu-berlin.de

Abstract

We consider the algorithmic complexity of recognizing bipartite temporal graphs. Rather than defining these graphs solely by their underlying graph or individual layers, we define a bipartite temporal graph as one in which every layer can be 2-colored in a way that results in few changes between any two consecutive layers. This approach follows the framework of multistage problems that has received a growing amount of attention in recent years. We investigate the complexity of recognizing these graphs. We show that this problem is NP-hard even if there are only two layers or if only one change is allowed between consecutive layers. We consider the parameterized complexity of the problem with respect to several structural graph parameters, which we transfer from the static to the temporal setting in three different ways. Finally, we consider a version of the problem in which we only restrict the total number of changes throughout the lifetime of the graph. We show that this variant is fixed-parameter tractable with respect to the number of changes.

1 Introduction

Bipartite graphs form a well-studied class of static graphs. A graph $G = (V, E)$ is bipartite if it admits a proper 2-coloring. A function $f: V \rightarrow \{1, 2\}$ is a *proper 2-coloring* of G if for all edges $\{v, w\} \in E$ it holds that $f(v) \neq f(w)$. In this work, we study the question of what a bipartite *temporal* graph is and how fast we can determine whether a temporal graph is bipartite. We approach this question through the prism of the novel program of multistage problems. Thus, we consider the following decision problem:

Problem 1. MULTISTAGE 2-COLORING (MS2C)

Input: A temporal graph $\mathcal{G} = (V, (E_t)_{t=1}^\tau)$ and an integer $d \in \mathbb{N}_0$.

Question: Are there $f_1, \dots, f_\tau: V \rightarrow \{1, 2\}$ such that f_t is a proper 2-coloring for (V, E_t) for every $t \in \{1, \dots, \tau\}$ and $|\{v \in V \mid f_t(v) \neq f_{t+1}(v)\}| \leq d$ for every $t \in \{1, \dots, \tau - 1\}$?

In other words, (\mathcal{G}, d) is a **yes**-instance if \mathcal{G} admits a proper 2-coloring of each layer where only d vertices change colors between any two consecutive layers.

There have been various approaches to transferring graph classes from static to temporal graphs. If \mathcal{C} is a class of static graphs, then the two most obvious ways of defining a temporal analog to \mathcal{C} are (i) including all temporal graphs whose underlying graph is in \mathcal{C} or (ii) including all temporal graphs that have all of their layers in \mathcal{C} (see, for instance, [18]). Most applied research that has employed a notion of bipartiteness in temporal graphs [1, 28, 39] has defined it using the underlying graph, seeking to model relationships between two different types of entities. This is

*Supported by the DFG, project MATE (NI 369/19).

†Supported by the DFG Research Training Group 2434 “Facets of Complexity”.

certainly appropriate as long as the type of an entity is not itself time-varying. Situations where entities can change their types require more sophisticated notions of bipartiteness. With MS2C, we model situations where we expect few entities to change their type between any two consecutive time steps. Later, in Section 5, we will consider a model for settings where we expect few changes overall.

The issue with both of the aforementioned classical approaches to defining temporal graph classes is that they do not take the time component into account when deciding membership in a class. For example, if the order of the layers is permuted arbitrarily, then this has no effect on membership in \mathcal{C} in either approach. Defining bipartiteness in the manner we propose does take the temporal order of the layers into consideration. It also leads to a hierarchy of temporal graph classes that are inclusion-wise between the two classes defined in the two aforementioned more traditional approaches: It is easy to see that $(\mathcal{G}, 0)$ is a **yes**-instance for MS2C if and only if the underlying graph of \mathcal{G} is bipartite. Conversely, if any layer of \mathcal{G} is not bipartite, then (\mathcal{G}, d) is a **no**-instance no matter the value of d . The two main drawbacks to defining temporal bipartiteness in this way are that (i) there is not one class of bipartite temporal graphs, but an infinite hierarchy depending on the value of d and (ii) as we will show, testing for bipartiteness in this sense is computationally much harder, but we will attempt to partially remedy this by analyzing the problem’s parameterized complexity for a variety of parameters.

Related work. The multistage framework is still young, but several problems have been investigated in it, mostly in the last couple of years, including MATCHING [3, 9, 21], KNAPSACK [4], s - t PATH [20], VERTEX COVER [19], COMMITTEE ELECTION [7], and others [2]. The framework has also been extended to goals other than minimizing the number of changes in the solution between layers [22, 25]. Since these types of problems are NP-hard even in fairly restricted settings, most research has focused on their parameterized complexity and approximability. +MS2C is most closely related to MULTISTAGE 2-SAT [16] (see Section 2).

Our contributions. We prove that MS2C remains NP-hard even if $d = 1$ or if $\tau = 2$. We then analyze three ways of transferring structural graph parameters to the multistage setting: the maximum over the layers, the sum over all layers’ values, and its value on the underlying graph times τ . We provide several (fixed-parameter) intractability and tractability results regarding these three notions of structural parameterizations (see Fig. 1). Finally, we show that a slightly modified version of the problem in which there is no restriction on the number of changes between any two consecutive layers, but on the total number of changes throughout the lifetime of the graph, is fixed-parameter tractable with respect to the number of allowed changes.

Discussion and outlook. We proved that MS2C is NP-hard even if $\tau = 2$ or if $d = 1$, but leave open whether it is fixed-parameter tractable for the combined parameter $\tau + d$. We introduce a framework for analyzing the parameterized complexity of multistage problems regarding structural graph parameters. While we resolve the parameterized complexity of MS2C with respect to most of the parameters, two cases are left open (cf. Fig. 1). For instance, we proved that MS2C is in XP when parameterized by $\text{bw}_{U+\tau}$, but we do not know whether it is in FPT or W[1]-hard. Another interesting example is MS2C parameterized by $\text{dcc}_{U+\tau}$, for which we do not know whether it is contained in XP or para-NP-hard. Note that we proved fixed-parameter tractability regarding dcc_{Σ} . Finally, we suspect that it may also be worthwhile to investigate other multistage graph problem in our framework.

2 Preliminaries

We denote by \mathbb{N} (\mathbb{N}_0) the natural number excluding (including) zero. We use standard terminology from graph theory [11] and parameterized algorithmics [10].

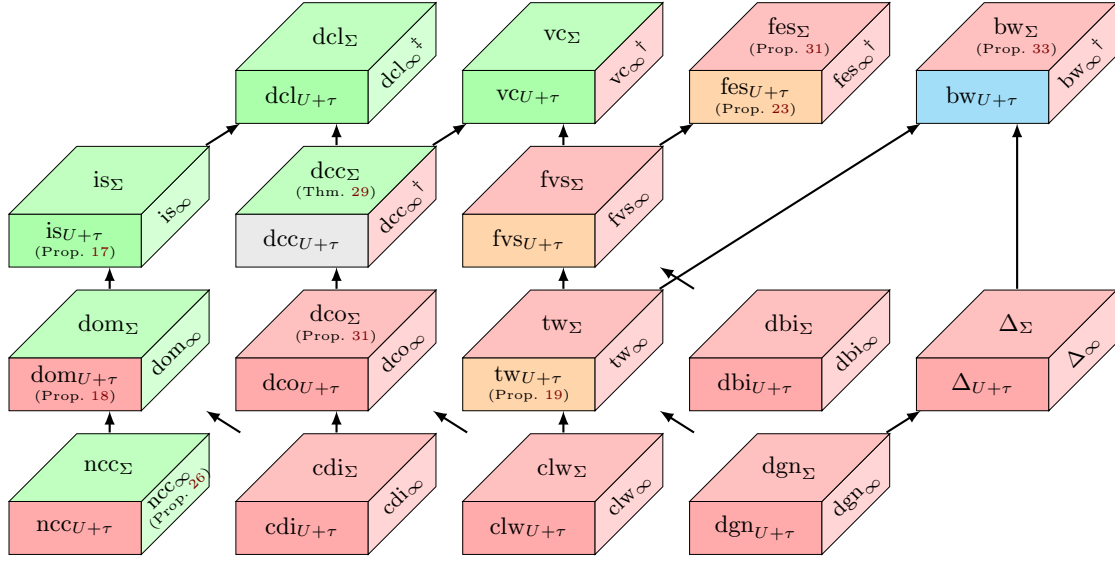

Figure 1: Overview of selected structural parameters and our results (green: in FPT; orange: XP and W[1]-hard; red: para-NP-hard; blue: XP and open whether FPT or W[1]-hard; gray: open). $[\Delta]$: maximum degree; bw: bandwidth; cdi: diameter of connected component; clw: clique-width; dbi: distance to bipartite; dcc: distance to co-cluster; dcl: distance to clique; dco: distance to cograph; dgn: degeneracy; dom: domination number; fes: feedback edge number; fvs: feedback vertex number; is: independence number; ncc: number of connected components; tw: treewidth; vc: vertex cover number; for definitions of these parameters, see Section 6 in the appendix or [37].
 \dagger (Proposition 27) \ddagger (no polynomial kernel unless $\text{NP} \subseteq \text{coNP}$ / poly)

Static and temporal graphs. We will frequently refer to graphs as static graphs in order to avoid confusion with temporal graphs. A static graph $G = (V, E)$ is *2-colorable* if there is a function $f: V \rightarrow \{1, 2\}$ such that $f(u) \neq f(v)$ for all $\{u, v\} \in E$. It is well-known that a static graph is 2-colorable if and only if it does not contain any odd cycle. This can be checked in time $\mathcal{O}(|V| + |E|)$ by a simple search algorithm.

A *temporal graph* $\mathcal{G} = (V, (E_t)_{t=1}^\tau)$ consists of a finite vertex set V and τ edge sets $E_1, \dots, E_\tau \subseteq \binom{V}{2}$. The *underlying graph* of \mathcal{G} is the static graph $\mathcal{G}_U := (V, \bigcup_{t=1}^\tau E_t)$. For $t \in \{1, \dots, \tau\}$, the t -th layer of \mathcal{G} is also a static graph, namely $\mathcal{G}_t := (V, E_t)$. The lifetime of \mathcal{G} is τ , the number of layers.

If $f_1, f_2: X \rightarrow Y$ are two functions that share a domain and a codomain, then $\delta(f_1, f_2) := |\{x \in X \mid f_1(x) \neq f_2(x)\}|$ is the number of elements of X whose value under f_1 differs from the value under f_2 .

Preliminary results. There is a connection between MS2C and the MULTISTAGE 2-SAT problem [16], which implies that positive algorithmic results from the latter transfer to the former.

Observation 1. *There is a polynomial time algorithm that, taking an instance of MULTISTAGE 2-COLORING, constructs an equivalent instance of MULTISTAGE 2-SAT with n variables, $2m$ clauses, and $d' = d$.*

Proof. For each vertex v , construct a variable x_v . For each edge $\{v, w\}$ in a layer, construct the clauses $(x_v \vee x_w), (\overline{x_v} \vee \overline{x_w})$. \square

Results on MULTISTAGE 2-SAT [16] imply the following.

Corollary 2. *MULTISTAGE 2-COLORING is (i) polynomial-time solvable if $d \in \{0, n\}$, (ii) in XP regarding $n - d$ and $\tau + d$, (iii) FPT regarding $m + n - d$ and n , and (iv) admits a polynomial kernel regarding $m + \tau$ and $n + \tau$.*

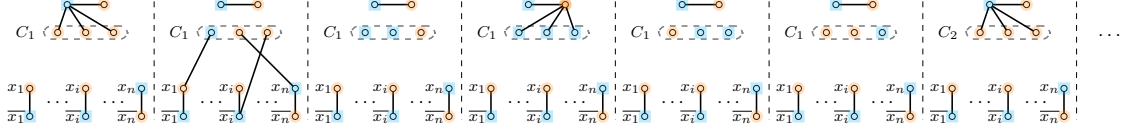

Figure 2: Illustration of Construction 1: The clause C_1 consists of the literals x_1 , $\neg x_i$, and x_n . The assignment represented by the depicted coloring has $\alpha(x_1) = \alpha(x_i) = \top$ and $\alpha(x_n) = \perp$.

We briefly note the following:

Observation 3. *Given two 2-colorable graphs $G = (V, E)$ and $G' = (V, E')$, and two 2-colorings f of G and f' of G' , we can determine $\delta(f, f')$ in linear time.*

We can strengthen the first statement in Corollary 2 with the following proposition:

Proposition 4. MULTISTAGE 2-COLORING is polynomial-time solvable if $d \geq \frac{1}{2}n$.

Proof. Given a temporal graph $\mathcal{G} = (V, (E_t)_{t=1}^\tau)$, we compute an arbitrary 2-coloring $f_t: V \rightarrow \{1, 2\}$ of each layer (V, E_t) . Then, for each $t \in \{2, \dots, \tau\}$ in increasing order, we check whether f_t introduces too many changes relative to f_{t-1} . In other words, we compute $\delta(f_t, f_{t-1})$. If $\delta(f_t, f_{t-1}) > \frac{1}{2}n$, then consider $\tilde{f}_t: V \rightarrow \{1, 2\}$, with $\tilde{f}_t(v) = 3 - f_t(v)$, the coloring that reverses all assignments of f_t . Note that $\delta(\tilde{f}_t, f_{t-1}) = |\{v \in V \mid \tilde{f}_t(v) \neq f_{t-1}(v)\}| = |\{v \in V \mid f_t(v) = f_{t-1}(v)\}| < \frac{1}{2}n$. Hence, we set f_t to \tilde{f}_t and continue. \square

Testing all sequences of functions $f_1, \dots, f_\tau: V \rightarrow \{1, 2\}$ gives us the following:

Observation 5. MULTISTAGE 2-COLORING can be decided in time $\mathcal{O}(2^{\tau n} \cdot m)$ where τ is the lifetime, n the number of vertices, and m the number of time edges in a temporal graph.

3 NP-hard cases

We start by proving some complexity lower bounds for MULTISTAGE 2-COLORING. We will show that the problem is NP-hard in three fairly restricted cases.

3.1 Few changes allowed

Theorem 6. MULTISTAGE 2-COLORING is NP-hard, even if $d = 1$.

The reduction is from the following NP-complete [35] problem:

Problem 2. EXACT 1-IN-3 SAT (X1-3SAT)

Input: A Boolean 3-CNF formula.

Question: Is there a truth assignment that sets exactly one literal to true in each clause?

Construction 1. Suppose that φ is a Boolean formula in 3-CNF over the variables x_1, \dots, x_n with the clauses C_1, \dots, C_m . We will construct a temporal graph $G = (V, (E_t)_{t=1}^\tau)$ with

$$V := \{u_1, u_2, v_1, v_2, v_3\} \cup \{w_i, \bar{w}_i \mid i \in \{1, \dots, n\}\}$$

and $\tau := 6m$. The construction is illustrated in Fig. 2. Each clause corresponds to six layers in G . For $j \in \{1, \dots, m\}$, if C_j consists of the literals ℓ_1, ℓ_2, ℓ_3 , then for $r \in \{1, 2, 3\}$ the vertex

representing ℓ_r is $w_r^j := w_i$ if $\ell_r = x_i$ or $w_r^j := \bar{w}_i$ if $\ell_r = \neg x_i$. Then, the six layers representing C_j are:

$$\begin{aligned} E_{6j-5} &:= \{\{u_1, u_2\}, \{u_1, v_1\}, \{u_1, v_2\}, \{u_1, v_3\}\} \cup \{\{w_i, \bar{w}_i\} \mid i \in \{1, \dots, n\}\} \\ E_{6j-4} &:= (E_{6j-5} \setminus \{\{u_1, v_r\} \mid r \in \{1, 2, 3\}\}) \cup \{\{v_r, w_r^j\} \mid r \in \{1, 2, 3\}\} \\ E_{6j-3} &:= E_{6j-4} \setminus \{\{v_r, w_r^j\} \mid r \in \{1, 2, 3\}\} \\ E_{6j-2} &:= E_{6j-3} \cup \{\{v_2, w_r^j\} \mid r \in \{1, 2, 3\}\} \\ E_{6j-1} &:= E_{6j-3} \\ E_{6j} &:= E_{6j-3} \end{aligned}$$

For a clause C_1 consisting of the clauses $x_1, x_n, \neg x_i$, the six layers are pictured in Fig. 2. \diamond

Proof of Theorem 6. It is easy to see that Construction 1 may be computed in polynomial time. We must show that φ has a truth assignment that sets exactly one literal to true in each clause if and only if there is a multistage 2-coloring f_1, \dots, f_τ , for \mathcal{G} such that $\delta(f_t, f_{t+1}) \leq d := 1$ for all $t \in \{1, \dots, \tau - 1\}$.

(\Rightarrow) Assume that the truth assignment $\alpha: \{x_1, \dots, x_n\} \rightarrow \{\top, \perp\}$ sets exactly one literal in each clause of φ to true. We will give proper 2-colorings $f_1, \dots, f_\tau: V \rightarrow \{1, 2\}$ of each layer of G . For all $t \in \{1, \dots, 6\tau\}$, the following colors remain the same:

$$f_t(u_1) := 1, \quad f_t(u_2) := 2, \quad f_t(w_i) := \begin{cases} 1, & \text{if } \alpha(x_i) = \perp \\ 2, & \text{if } \alpha(x_i) = \top \end{cases} \quad f_t(\bar{w}_i) := 3 - f_t(w_i).$$

For $j \in \{1, \dots, m\}$, we will give the coloring $f_{6j-5}, \dots, f_{6j}: V \rightarrow \{1, 2\}$ of the remaining vertices v_3, v_4 , and v_5 in the six layers that correspond to the clause C_j . Suppose that the vertices representing the literals ℓ_1, ℓ_2, ℓ_3 in C_j (in the sense described in Construction 1) are w_1^j, w_2^j, w_3^j . Exactly one of those three literals is satisfied by α , say ℓ_s , $s \in \{1, 2, 3\}$. Let $s' \in \{1, 2, 3\} \setminus \{s\}$.

$$\begin{aligned} f_{6j-5}(v_1) &= f_{6j-5}(v_2) = f_{6j-5}(v_3) := 2, \\ f_{6j-4}(v_s) &:= 1, \quad f_{6j-4}(v_r) := 2 \text{ for every } r \in \{1, 2, 3\} \setminus \{s\}, \\ f_{6j-3}(v_s) &= f_{6j-3}(v_{s'}) := 1, \quad f_{6j-3}(v_r) := 2 \text{ for every } r \in \{1, 2, 3\} \setminus \{s, s'\}, \\ f_{6j-2}(v_1) &= f_{6j-2}(v_2) = f_{6j-2}(v_3) := 1, \\ f_{6j-1}(v_r) &:= f_{6j-3}(v_r) \text{ for every } r \in \{1, 2, 3\}, \\ f_{6j}(v_r) &:= f_{6j-4}(v_r) \text{ for every } r \in \{1, 2, 3\}. \end{aligned}$$

It is easy to see that this coloring is proper and that only color changes in each layer. The changes in color are illustrated in Fig. 2.

(\Leftarrow) Suppose that f_1, \dots, f_τ are 2-colorings of the layers with the required properties. Without loss of generality, we may assume that $f_1(u_1) = 1$. If not, we can invert all colors. We define a truth assignment $\alpha: \{x_1, \dots, x_\tau\} \rightarrow \{\top, \perp\}$ as follows:

$$\alpha(x_i) := \begin{cases} \top, & \text{if } f_1(w_i) = 2 \\ \perp, & \text{if } f_1(w_i) = 1. \end{cases}$$

We must prove that α satisfies exactly one literal in each clause of φ . We briefly note that, because $d = 1$, if two vertices are adjacent in two consecutive layers, then their colors cannot change between these two layers. This is because if one of the vertices is re-colored, then the other also must be, but this is not possible since at most one vertex can be re-colored from one layer to the next. This implies that only the colors of v_1, v_2, v_3 can change.

Let $j \in \{1, \dots, m\}$. We must show that α satisfies exactly one literal in C_j . Since $f_{6j-5}(u_1) = 1$ (as we noted, the color of u_1 cannot change), it follows that $f_{6j-5}(v_r) = 2$ for every $r \in \{1, 2, 3\}$. Similarly, since $f_{6j-2}(u_2) = 2$, it follows that $f_{6j-2}(v_r) = 1$ for every $r \in \{1, 2, 3\}$. Hence, between

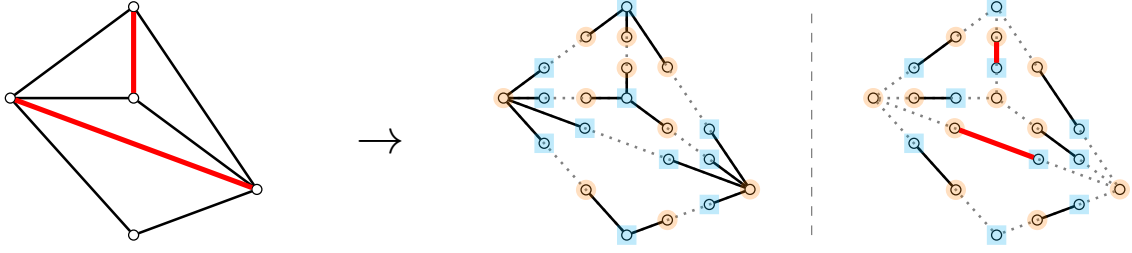

Figure 3: Illustration of Construction 2: The input graph G on the left hand-side (thick/red edges indicate a solution) and the output temporal graph \mathcal{G} on the right-hand side (thick/red edges in the second layer indicate where a recoloring was made; gray/dotted lines help to match with original edges from G).

the layers $6j - 5$ and $6j - 2$ all three vertices v_1, v_2, v_3 change colors, implying that exactly one of these vertices must change colors in each step. Let $v_s, s \in \{1, 2, 3\}$, be the vertex that changes its color to 1 in layer $6j - 4$. Let w_1^j, w_2^j, w_3^j be the vertices corresponding to the literals in C_j (again in the sense described in Construction 1). Since $f_{6j-4}(v_s) = 1, f_{6j-4}(v_r) = 2$ for every $r \in \{1, 2, 3\} \setminus \{s\}$, and the colors of w_i and \bar{w}_i cannot change, it follows that α satisfies exactly one of the literals in C_j . \square

3.2 Few stages

Theorem 7. MULTISTAGE 2-COLORING is NP-hard even on temporal graphs with $\tau = 2$.

To prove Theorem 7, we give a polynomial-time many-one reduction from the NP-complete [40] EDGE BIPARTIZATION problem defined by:

Problem 3. EDGE BIPARTIZATION

Input: An undirected graph $G = (V, E)$ and $k \in \mathbb{N}_0$.

Question: Is there a set of edges $E' \subseteq E$ with $|E'| \leq k$ such that $G - E'$ is bipartite?

Construction 2. Let $G = (V, E)$ be a graph and let $k \in \mathbb{N}_0$. We assume that $V = \{v_1, \dots, v_n\}$. We construct an instance (\mathcal{G}, d) of MS2C with $\mathcal{G} := (V', E_1, E_2)$ and $d := k$ as follows (see Fig. 3 for an illustrative example).

The underlying graph of \mathcal{G} is obtained by subdividing each edge in G twice. Let u_i^e and u_j^e be the two vertices obtained by subdividing $e = \{v_i, v_j\}$ where u_i^e is adjacent to v_i and u_j^e to v_j . Then, $V' := V \cup \{u_i^e, u_j^e \mid e = \{v_i, v_j\} \in E\}$. The first layer of \mathcal{G} has edge set $E_1 := \{\{v_i, u_i^e\} \mid i \in \{1, \dots, n\}, e \in E, v_i \in e\}$. The second layer has edge set $E_2 := \{\{u_i^e, u_j^e\} \mid e = \{v_i, v_j\} \in E\}$. \diamond

Next, we will prove the correctness of Construction 2.

Lemma 8. Instance (G, k) is a *yes-instance* for EDGE BIPARTIZATION if and only if instance (\mathcal{G}, d) output by Construction 2 is a *yes-instance* for MULTISTAGE 2-COLORING.

Proof. (\Rightarrow) Assume that (G, k) is a *yes-instance* and that $E' \subseteq E$ is a set of edges of size at most k such that $G - E'$ is bipartite. Hence, there is a proper 2-coloring $f_0: V \rightarrow \{1, 2\}$ of $G - E'$. We obtain a 2-coloring $f_1: V' \rightarrow \{1, 2\}$ of the first layer of \mathcal{G} by setting $f_1(v_i) := f_0(v_i)$ for all $i \in \{1, \dots, n\}$ and $f_1(u_i^e) := 3 - f_1(v_i)$ for all $e = \{v_i, v_j\} \in E$. It is easy to verify that this coloring is proper. A proper 2-coloring $f_2: V' \rightarrow \{1, 2\}$ may be defined by $f_2(v_i) := f_1(v_i)$ and for any $e = \{v_i, v_j\} \in E$ we set

$$f_2(u_i^e) := \begin{cases} f_1(u_i^e), & \text{if } i < j \text{ or } f_1(u_i^e) \neq f_1(u_j^e), \\ 3 - f_1(u_i^e), & \text{if } i > j \text{ and } f_1(u_i^e) = f_1(u_j^e). \end{cases}$$

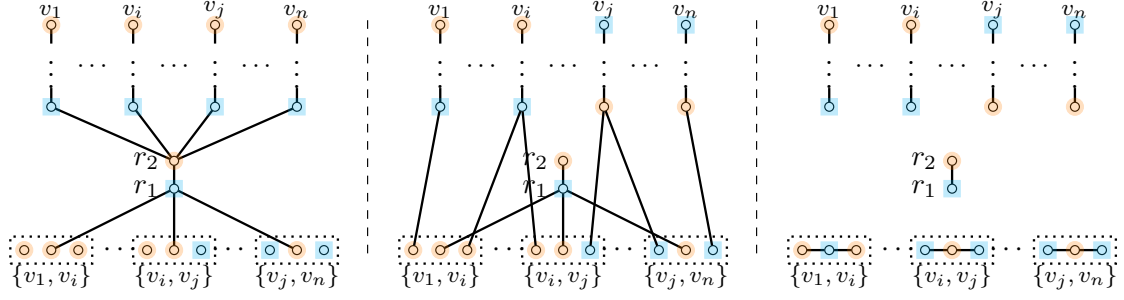

Figure 4: Illustration of Construction 3: This temporal graph represents a static graph with $E = \{\{v_1, v_i\}, \{v_i, v_j\}, \{v_j, v_n\}\}$. The vertices r_3, \dots, r_{d+1} are omitted from the illustration. Blue represents the color 1 in the proof of Theorem 7 and orange the color 2. Then, the coloring depicted represents a clique that contains v_j and v_n , but not v_1 and v_i .

The only vertices that change colors between f_1 and f_2 are u_i^e with $e = \{v_i, v_j\} \in E$, $i > j$, and $f_1(v_i) = f_1(v_j)$. However, $f_1(v_i) = f_1(v_j)$ implies that $f_0(v_i) = f_0(v_j)$ and hence $e \in E'$. Since $|E'| \leq k = d$, it follows that at most d vertices change colors.

(\Leftarrow) Suppose that $f_1, f_2: V' \rightarrow \{1, 2\}$ are proper 2-colorings of \mathcal{G}_1 and \mathcal{G}_2 , respectively. Let $E' := \{e = \{v_i, v_j\} \in E \mid f_1(u_i^e) = f_1(u_j^e)\}$. Since $\{u_i^e, u_j^e\} \in E_2$, it follows that one of the vertices u_i^e, u_j^e must change colors between f_1 and f_2 if $e \in E'$. This implies that $|E'| \leq d = k$. For $e = \{v_i, v_j\} \in E \setminus E'$, it follows that $f_1(u_i^e) \neq f_1(u_j^e)$ and hence $f_1(v_i) \neq f_1(v_j)$. This implies that the restriction of f_1 to V induces a proper 2-coloring of $G - E'$. \square

This allows us to prove Theorem 7.

Proof of Theorem 7. It is easy to see that Construction 2 can be computed in polynomial time. The claim follows by Lemma 8. \square

The reduction also implies the following:

Proposition 9. *Unless the ETH fails, MULTISTAGE 2-COLORING admits no $\mathcal{O}(2^{o(n+m)})$ -time algorithm, where n is the number of vertices and m is the number of time edges in a temporal graph, even for $\tau = 2$.*

Proof. Unless the ETH fails, EDGE BIPARTIZATION cannot be solved in time $\mathcal{O}(2^{o(n)})$, where n is the number of vertices. This follows from the corresponding lower bound for MAXIMUM CUT [31]. The instance output by Construction 2 contains $n + 2m$ vertices. The claim follows by Lemma 8. \square

Next we present a further reduction to MS2C. We will use this reduction to prove parameterized lower bounds in Section 4. The reduction is from the NP-complete CLIQUE problem.

Construction 3. Let $(G = (V, E), k)$ be an instance for CLIQUE. Let $V = \{v_1, \dots, v_n\}$ and $|E| = m$. We may assume that $k \geq 3$ and that $m \geq \binom{k}{2}$ (otherwise, (G, k) is clearly a no-instance). Finally, we assume that $m - \binom{k}{2}$ is divisible by k . If it is not, we can simply add a star with $k - ((m - \binom{k}{2}) \bmod k)$ many leaves since this does not add or remove a k -clique with $k \geq 3$. We will construct an instance (\mathcal{G}, d) for MULTISTAGE 2-COLORING consisting of a temporal graph $\mathcal{G} = (V', E_1, E_2, E_3)$ with three layers and $d := m - \binom{k}{2}$.

The general idea is that each vertex in G is represented by a path, and its coloring in the second and third layer determine whether or not the represented vertex is in the clique. The restriction on the color changes between the layers ensure that at least k vertices are chosen and that all pairs of chosen vertices are adjacent. The construction is illustrated in Fig. 4.

We start by defining the vertex set V' . Let $\ell := (m - \binom{k}{2})/k$. Then, $V_1 := \{u_i^v \mid v \in V, i \in \{1, \dots, \ell\}\}$. Next, we let $V_2 := \{w_1^e, w_2^e, w_3^e \mid e \in E\}$. Finally, $V_3 := \{r_i \mid i \in \{1, \dots, d+1\}\}$. Then, we define $V' := V_1 \cup V_2 \cup V_3$.

We must now define the edge sets E_1, E_2, E_3 . We start by defining a set of edges that will be present in every layer of \mathcal{G} . Essentially, the vertices in V_1 that correspond to the same vertex in G and the vertices in V_3 each form a path. Let $E^P := \{\{u_i^v, u_{i+1}^v\} \mid v \in V, i \in \{1, \dots, \ell-1\}\} \cup \{\{r_i, r_{i+1}\} \mid i \in \{1, \dots, d\}\}$. Then:

$$\begin{aligned} E_1 &:= E^P \cup \{\{r_1, w_2^e\} \mid e \in E\} \cup \{\{r_2, u_1^v\} \mid v \in V\}, \\ E_2 &:= E^P \cup \{\{r_1, w_2^e\} \mid e \in E\} \cup \{\{u_1^{v_i}, w_1^e\}, \{u_1^{v_j}, w_3^e\} \mid e = \{v_i, v_j\} \in E, i < j\}, \\ E_3 &:= E^P \cup \{\{w_1^e, w_2^e\}, \{w_2^e, w_3^e\} \mid e \in E\}. \end{aligned} \quad \diamond$$

Lemma 10. *Construction 3 can be computed in polynomial time and the input instance is equivalent to the output instance.*

Proof. It is easy to verify that Construction 3 can be computed in polynomial time. We must show that $(G = (V, E), k)$ is a **yes**-instance of CLIQUE if and only if $(\mathcal{G} = (V, E_1, E_2, E_3), d)$ is a **yes**-instance of MS2C.

(\Rightarrow) Suppose that $X \subseteq V$ is a clique of size exactly k in G . We will give $f_1, f_2, f_3: V' \rightarrow \{1, 2\}$ proving that (\mathcal{G}, d) is a **yes**-instance. Let

$$f_1(u_i^v) := \begin{cases} 1, & \text{if } i \text{ is odd,} \\ 2, & \text{if } i \text{ is even,} \end{cases} \quad f_1(r_i) := \begin{cases} 1, & \text{if } i \text{ is odd,} \\ 2, & \text{if } i \text{ is even.} \end{cases}$$

For any $e = \{v_i, v_j\} \in E$, $i < j$, let:

$$f_1(w_1^e) := \begin{cases} 1, & \text{if } v_i \in X, \\ 2, & \text{if } v_i \notin X, \end{cases} \quad f_1(w_2^e) := 2, \quad f_1(w_3^e) := \begin{cases} 1, & \text{if } v_j \in X, \\ 2, & \text{if } v_j \notin X. \end{cases}$$

It is easy to see that this coloring of (V', E_1) is proper. We continue by giving the coloring f_2 of the second layer. First, $f_2(x) := f_1(x)$ for all $x \in V_2 \cup V_3$. The colors of vertices in V_1 , however, can change. Let:

$$f_2(u_i^v) := \begin{cases} 1, & \text{if } i \text{ is odd and } v \notin X, \\ 2, & \text{if } i \text{ is even and } v \notin X, \\ 2, & \text{if } i \text{ is odd and } v \in X, \\ 1, & \text{if } i \text{ is even and } v \in X. \end{cases}$$

Again, it is easy to see that f_2 is a proper coloring of (V', E_2) . Note that the only vertices that change colors are u_i^v with $v \in X$. There are exactly $|X| \cdot \ell = m - \binom{k}{2} = d$ such vertices. We conclude by defining f_3 . The colors of V_1 and V_3 do not change, so let $f_3(x) := f_2(x)$ for all $x \in V_1 \cup V_3$. Consider any $e = \{v_i, v_j\} \in E$, $i < j$. Then:

$$\left. \begin{aligned} f_3(w_1^e) &:= 2 \\ f_3(w_2^e) &:= 1 \\ f_3(w_3^e) &:= 2 \end{aligned} \right\} \text{if } v_i, v_j \notin X \quad \text{and} \quad \left. \begin{aligned} f_3(w_1^e) &:= 1 \\ f_3(w_2^e) &:= 2 \\ f_3(w_3^e) &:= 1 \end{aligned} \right\} \text{if } v_i \in X \text{ or } v_j \in X$$

It is also not difficult to see that f_3 is a proper coloring of (V', E_3) . To see that exactly d vertices change colors, first note that only vertices in V_2 change colors. Moreover, if v_i and v_j are both in the clique X , then none of the vertices w_1^e, w_2^e, w_3^e change colors. However, if one of v_i and v_j is not in X , then exactly one of those three vertices changes colors. Hence, the number of changes to the coloring is $m - \binom{k}{2} = d$.

(\Leftarrow) Suppose that $f_1, f_2, f_3: V' \rightarrow \{1, 2\}$ are proper colorings of the layers of \mathcal{G} such that only d vertices change colors between any two consecutive layers. Without loss of generality, we

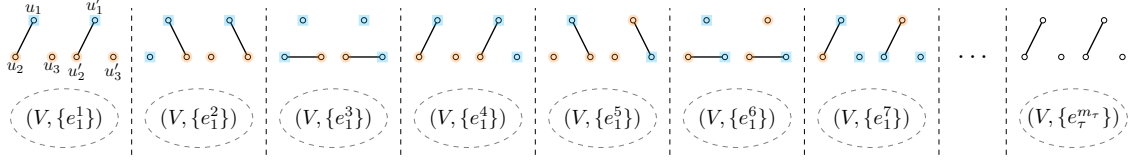

Figure 5: Illustration to Construction 4.

may assume that $f_1(r_1) = 1$. Since the vertices in V_3 form a path in every layer, all of these vertices must be re-colored if any one of them is. Since there are $d + 1$ such vertices, their color cannot be changed. Hence, we assume that for every $t \in \{1, 2, 3\}$ it is the case that $f_t(r_i) = 1$ if i is odd and $f_t(r_i) = 2$ if i is even. This directly implies that for all $v \in V$, $f_1(u_i^v) = 1$ if i is odd and $f_1(u_i^v) = 2$ if i is even. Moreover, by the same reasoning, we conclude that $f_1(w_2^e) = f_2(w_2^e) = 2$ for every $e \in E$. Note that w_1^e and w_3^e are both isolated in (V', E_1) . Hence, their colors in the first layer are irrelevant and we may assume that their color does not change between the first two layers. All in all, it follows that the only vertices that change color between E_1 and E_2 are in V_1 . However, because u_1^v, \dots, u_ℓ^v form a path, we conclude that if u_i^v changes colors for some $i \in \{1, \dots, \ell\}$, then u_j^v changes colors for every $j \in \{1, \dots, \ell\}$. Let $X := \{v \in V \mid f_1(u_1^v) \neq f_2(u_1^v)\}$. We also note that $|X| \leq \frac{d}{\ell} = k$,

It remains to show that X is a clique in G and that $|X| \geq k$. To this end, first note that for any $e = \{v_i, v_j\} \in E$, $i < j$, it is the case that $f_2(w_1^e) = 1$ if and only if $v_i \in X$ and $f_2(w_3^e) = 1$ if and only if $v_j \in X$, while $f_2(w_2^e) = 2$. On the other hand, in the final layer, the edges between these vertices imply that $f_3(w_1^e) \neq f_3(w_2^e)$ and $f_3(w_2^e) \neq f_3(w_3^e)$. Hence, the only way that w_1^e, w_2^e, w_3^e can all keep their colors is if $v_i, v_j \in X$. Hence, the number of edges that do not have both endpoints in X is at most d . Therefore, $m - \binom{|X|}{2} \leq d = m - \binom{k}{2}$, implying that $|X| \geq k$. Since $|X| \leq k$ as we noted above, this forces $|X| = k$. Because the number of edges with both endpoints in X is at least $m - d = \binom{k}{2} = \binom{|X|}{2}$, this leads us to conclude that X is a clique. \square

3.3 Few edges per layer

Theorem 11. MULTISTAGE 2-COLORING is NP-hard even for $d = 1$ and restricted to temporal graphs where each layer contains just three edges and has maximum degree one.

We will prove this using a reduction from MS2C with $d = 1$, which is NP-hard by Theorem 6.

Construction 4. Let $(\mathcal{G} = (V, (E_t)_{t=1}^\tau), d = 1)$ be an instance for MULTISTAGE 2-COLORING where for every $t, t' \in \{1, \dots, \tau\}$ it holds that $|E_t| = |E_{t'}|$, $|E_t| \geq 4$, and $|E_t| \bmod 3 = 1$ (we can guarantee this by adding a star $K_{1,q}$, $q = \binom{|V|}{2}$, to the underlying graph and add edges from the star to layers to fulfill the criterias). We will construct an instance (\mathcal{G}', d) as required (see Fig. 5 for an illustration). The general idea is that we spread the edges of any one layer in \mathcal{G} to several layers in \mathcal{G}' by presenting the edges one at a time. In order to ensure that the solution does not change between the layers in \mathcal{G}' corresponding to the same layer in \mathcal{G} , we additionally introduce a gadget that uses up the budget for changes to the solution.

For every $t \in \{1, \dots, \tau\}$, let $m := |E_t|$ and order the edges in E_t arbitrarily as e_1^t, \dots, e_m^t . Let $V' := V \uplus V^+$ with $V^+ := \{u_1, u_2, u_3, u'_1, u'_2, u'_3\}$. The six new vertices will be used to implement the aforementioned gadget. Let

$$E_1^+ := \{\{u_1, u_2\}, \{u'_1, u'_2\}\}, \quad E_2^+ := \{\{u_1, u_3\}, \{u'_1, u'_3\}\}, \quad \text{and} \quad E_3^+ := \{\{u_2, u_3\}, \{u'_2, u'_3\}\}.$$

For every $t \in \{1, \dots, \tau\}$ and $k \in \{1, \dots, m\}$, let $E_t^k := \{e_t^k\} \cup E_{k'}^+$ where $k' := (k - 1 \bmod 3) + 1$. Note that for every $t \in \{1, \dots, \tau - 1\}$, it holds that $E_1^+ \subseteq E_t^m \cap E_{t+1}^1$ (recall that $1 \leq (m-1)/3 \in \mathbb{N}$). Let $\tau' := \tau \cdot m$. Then, the output instance is (\mathcal{G}', d) with $\mathcal{G}' := (V', (E_t')_{t=1}^{\tau'})$ where $E_{(p-1) \cdot m + k}^p := E_p^k$ for $p \in \{1, \dots, \tau\}$ and $k \in \{1, \dots, m\}$. \diamond

Proof of Theorem 11. It is easy to see that Construction 4 can be computed in polynomial time and that any instance that it outputs has the properties in the statement of the theorem. We must still show that (\mathcal{G}, d) is a **yes**-instance if and only if (\mathcal{G}', d) is.

(\Rightarrow) Suppose that f_1, \dots, f_τ are 2-colorings of the layers of \mathcal{G} such that $\delta(f_t, f_{t+1}) \leq 1$ for every $t \in \{1, \dots, \tau - 1\}$. Then consider $f_t^k: V' \rightarrow \{1, 2\}$ for $t \in \{1, \dots, \tau\}$ and $k \in \{1, \dots, m\}$ defined by

$$f_t^k(v) := \begin{cases} f_t(v), & \text{if } v \in V, \\ g_t^k(v), & \text{if } v \in V^+, \end{cases}$$

where g_t^k , the coloring pictured in Fig. 5, is obtained in the following manner. We use an arbitrary 2-coloring of $(V^+, E_1^+ \cup E_2^+)$ for g_1^1 . Moreover, for $t > 1$ we let $g_t^1 := g_{t-1}^m$. If $2 \leq k < m$ is even, then we obtain g_t^{k+1} from g_t^k by changing the color of one of the vertices $\{u_1, u_2, u_3\}$ such that g_t^{k+1} properly colors $\{u_1, u_2, u_3\}$ with respect to both E_{k+1}^+ and E_{k+2}^+ . If $3 \leq k < m$ is odd, we do the same for $\{u'_1, u'_2, u'_3\}$.

We must show that this coloring is proper and that there is at most one change between any two consecutive colorings. No edge e_t^k from \mathcal{G} is monochromatic because f_1, \dots, f_τ are proper colorings by assumption. If $t = 1$ and $k = 1$ or if $k > 1$, then g_t^k properly colors V^+ by construction. If $t > 1$ and $k = 1$, then $g_t^1 = g_{t-1}^m$. Recall that $E_1^+ \subseteq E_t^1 \cap E_{t-1}^m$. Thus, g_t^1 also properly colors V^+ . It remains to show that there is at most one change between any two consecutive colorings. If $k < m$, then the colors of the vertices in V do not change between the stages E_t^k and E_t^{k+1} , while only one of the vertices in V^+ changes colors by the construction of g_t^k . Between the stages E_t^m and E_{t+1}^1 only one vertex in V changes colors by assumption, while the vertices in V^+ are not re-colored.

(\Leftarrow) Suppose that f_t^k for $t \in \{1, \dots, \tau\}$ and $k \in \{1, \dots, m\}$ are proper colorings of (V', E_t^k) such that at most one vertex changes colors between E_t^k and E_t^{k+1} or between E_t^m and E_{t+1}^1 .

First, we claim that, if $k < m$, then at least one vertex in V^+ must change colors between E_t^k and E_t^{k+1} . If $k < m$, consider the graph $(V, E_t^k \cup E_t^{k+1} \cup E_t^{k+2})$. The vertices $\{u_1, u_2, u_3\}$ and $\{u'_1, u'_2, u'_3\}$ each induce a K_3 in this graph. Hence, at least two changes must be made between E_t^k and E_t^{k+2} . Since only one change can be made in each step, this implies that one must be made in each.

This claim implies that the vertices in V do change colors under f_t^k , except possibly between E_t^m and E_{t+1}^1 . We define $f_1, \dots, f_\tau: V \rightarrow \{1, 2\}$ by $f_t(v) := f_t^1(v) = \dots = f_t^m(v)$. Note that f_t is a proper coloring of (V, E_t) because f_t^1, \dots, f_t^m are proper colorings. Moreover, only one vertex changes colors between f_t and f_{t+1} . \square

4 Parameterized complexity

In the previous section we showed that MULTISTAGE 2-COLORING is NP-hard, even for constant values of τ and d . In this section, we study the parameterized complexity of MULTISTAGE 2-COLORING. To begin with, we will now show that MULTISTAGE 2-COLORING is fixed-parameter tractable with respect to $n - d$. This is in contrast to MULTISTAGE 2-SAT, which is W[1]-hard with respect to this parameter [16, Theorem 3.6].

Proposition 12. MULTISTAGE 2-COLORING is fixed-parameter tractable with respect to $n - d$.

Proof. If $d \geq \frac{n}{2}$, the problem can be solved in polynomial time (see Proposition 4). If $d < \frac{n}{2}$, then it follows that $n < 2(n - d)$. Hence, the fixed-parameter tractability of MS2C with respect to n (see Corollary 2) implies fixed-parameter tractability with respect to $n - d$. \square

Additionally, we note the following kernelization lower bound.

Proposition 13. Unless $\text{NP} \subseteq \text{coNP} / \text{poly}$, MULTISTAGE 2-COLORING admits no problem kernel of size polynomial in the number n of vertices.

Proof. We give an AND-composition [5] from MS2C into MS2C parameterized by n , which then yields the theorem’s statement [12]. Let $\mathcal{I}_1 = (\mathcal{G}^1, d), \dots, \mathcal{I}_p = (\mathcal{G}^p, d)$ be p instances of MS2C with $d = 1$. Note that we can assume [6] that V denotes the vertex set and (E_1^q, \dots, E_τ^q) denotes the edge sequence for each \mathcal{G}^q , $q \in \{1, \dots, p\}$. Let $n := |V|$. We build the temporal graph \mathcal{G} with vertex set V and sequence

$$(E_1^1, \dots, E_\tau^1, E_1^{1,2}, \dots, E_n^{1,2}, E_1^2, \dots, E_\tau^2, E_1^{2,3}, \dots, E_n^{2,3}, E_1^3, \dots, \dots, E_\tau^p),$$

where $E_i^{q,q+1} := \emptyset$ for every $q \in \{1, \dots, p-1\}$ and $i \in \{1, \dots, n\}$. We claim that $\mathcal{I} := (\mathcal{G}, d)$ is a **yes**-instance if and only if \mathcal{I}_q is a **yes**-instance for every $q \in \{1, \dots, p\}$. Since the forward direction is immediate, we only discuss the backward direction in the following.

For each $q \in \{1, \dots, p\}$, let $f_1^q, \dots, f_\tau^q: V \rightarrow \{1, 2\}$ be proper colorings of $(V, E_1^q), \dots, (V, E_\tau^q)$ such that $\delta(f_i^q, f_{i+1}^q) \leq d$ for every $i \in \{1, \dots, \tau-1\}$. Note that for every $q \in \{1, \dots, p-1\}$, since there are n empty layers between (V, E_τ^q) and (V, E_1^{q+1}) , we can get from f_τ^q to f_1^{q+1} in at most n steps with having consecutive coloring not differ in more than one vertex. This way, we can obtain a solution to \mathcal{I} , witnessing that \mathcal{I} is a **yes**-instance. \square

In the following, we will consider the parameterized complexity of MULTISTAGE 2-COLORING with respect to structural graph parameters. Research on the parameterized complexity of multistage problems has thus far mostly focused on the parameters that are given as part of the input such as d or τ . Although Fluschnik et al. [20] considered the vertex cover number and maximum degree of the underlying graph, there has been no systematic study of multistage problems concerned with structural parameters of the input temporal graph. We seek to initiate this line of research in the following. It follows the call by Fellows et al. [13, 15] to investigate problems’ “parameter ecology” in order to fully understand what makes them computationally hard. We will begin with a short discussion of how graph parameters can be applied to multistage problems. This question is closely related to issues that arise when applying such parameters to temporal graph problems (see [17] and [30, Sect. 2.4]).

A (temporal) graph parameter p is a function that maps any (temporal) graph G to a non-negative integer $p(G)$. We will consider three ways of transferring graph parameters to temporal graphs. If p is a graph parameter, $\mathcal{G} = (V, (E_t)_{t=1}^\tau)$ is a temporal graph, $\mathcal{G}_t := (V, E_t)$ its t -th layer, and $\mathcal{G}_U := (V, \bigcup_{t=1}^\tau E_t)$ its underlying graph, then we define:

$$p_\infty(\mathcal{G}) := \max_{t \in \{1, \dots, \tau\}} p(\mathcal{G}_t), \quad (\text{maximum parameterization})$$

$$p_\Sigma(\mathcal{G}) := \sum_{t=1}^\tau \max\{1, p(\mathcal{G}_t)\}, \text{ and} \quad (\text{sum parameterization})$$

$$p_{U+\tau}(\mathcal{G}) := p(\mathcal{G}_U) + \tau. \quad (\text{underlying graph parameterization})$$

We will briefly explain our choice to define these parameters in this manner and describe the relationship between the parameters. For any two (temporal) graph parameters p_1 and p_2 , the first parameter p_1 is larger than p_2 , written $p_1 \succeq p_2$ or $p_2 \preceq p_1$, if there is a function $f: \mathbb{N}_0 \rightarrow \mathbb{N}_0$ such that $f(p_1(G)) \geq p_2(G)$ for all (temporal) graphs G . Such relationships between parameters are useful because, if $p_1 \succeq p_2$, then any problem that is fixed-parameter tractable with respect to p_2 is also fixed-parameter tractable with respect to p_1 . The \succeq -relation between static graph parameters is well-understood [24, 34, 36, 37, 38]. We will use these relationships implicitly and explicitly throughout this article. Many of the results claimed in Fig. 1 will not be explicitly proved, because they are immediate consequences of other results and the \succeq -relation. The relationships under \succeq between selected graph parameters are pictured in that figure.

When it comes to transferring graph parameters from the static to the multistage setting, the parameters p_∞ and $p_{U+\tau}$ simply apply the graph parameter to the individual layers and to the underlying graph, respectively, and were used in a similar manner by Fluschnik et al. [17] and Molter [30]. The reasoning behind the definition of the sum parameterization may not be quite as obvious. It seems natural to consider the sum of the parameters over all layers. The issue with

this is that it may not preserve the \succeq -relation. For example, it is well-known that feedback vertex number is a larger parameter (in the sense of \succeq) than treewidth. However, consider a temporal graph where each layer is a forest. Then, the sum of the feedback vertex numbers of the layers is 0, but the sum of the layers' treewidths is τ . Hence, treewidth is no longer bounded from above by the feedback vertex number. Our definition gets around this problem. In fact, all three aforementioned ways of transferring parameters from the static to the multistage setting preserve the \succeq -relation:

Proposition 14. *Let p and q be graph parameters with $p \succeq q$. Then, $p_\alpha \succeq q_\alpha$ for any $\alpha \in \{\infty, \Sigma, U + \tau\}$.*

Proof. Let $f: \mathbb{N}_0 \rightarrow \mathbb{N}_0$ be a function such that $f(p(G)) \geq q(G)$ for all static graphs G . Without loss of generality, we may assume that (i) f is monotonically increasing, that is, $f(a) \geq f(b)$ if $a \geq b$, and (ii) $f(a) \geq a$ for every $a \in \mathbb{N}_0$ (consider $f'(a) := a + \max_{b \in \{1, \dots, a\}} f(b)$, $a \in \mathbb{N}_0$, for instance).

Let \mathcal{G} be an arbitrary temporal graph. Then:

$$f(p_\infty(\mathcal{G})) = f\left(\max_{t \in \{1, \dots, \tau\}} p(\mathcal{G}_t)\right) \stackrel{(i)}{=} \max_{t \in \{1, \dots, \tau\}} f(p(\mathcal{G}_t)) \geq \max_{t \in \{1, \dots, \tau\}} q(\mathcal{G}_t) = q_\infty(\mathcal{G})$$

For $n \in \mathbb{N}$, let $\text{Part}(n)$ denote the set of all partitions of n , that is all possible ways of writing n as $n = n_1 + n_2 + \dots + n_r$ for $r \geq 1$ and $n_i \in \mathbb{N}$. Let $g: \mathbb{N}_0 \rightarrow \mathbb{N}_0$ with:

$$g(0) := 0, \quad g(n) := \max \left\{ \sum_{i=1}^r f(n_i) \mid (n_1, \dots, n_r) \in \text{Part}(n) \right\} \text{ if } n > 0.$$

The maximum is well-defined, because $\text{Part}(n)$ is finite. For any temporal graph \mathcal{G} , we have:

$$\begin{aligned} g(p_\Sigma(\mathcal{G})) &= g\left(\sum_{t=1}^{\tau} \max\{1, p(\mathcal{G}_t)\}\right) \geq \sum_{t=1}^{\tau} f(\max\{1, p(\mathcal{G}_t)\}) \stackrel{(i)}{=} \sum_{t=1}^{\tau} \max\{f(1), f(p(\mathcal{G}_t))\} \\ &\stackrel{(ii)}{\geq} \sum_{t=1}^{\tau} \max\{1, q(\mathcal{G}_t)\} = q_\Sigma(\mathcal{G}). \end{aligned}$$

(Note that the first inequality relies on the fact that every term in the sum is at least 1, since a partition can only be composed of positive summands. Therefore, this argument would not apply, if we defined the sum parameterization as simply the sum over the parameters of the individual layers.)

Lastly, for any temporal graph \mathcal{G} , we have:

$$g(p_{U+\tau}(\mathcal{G})) = g(p(\mathcal{G}_U) + \tau) \geq f(p(\mathcal{G}_U)) + f(\tau) \stackrel{(ii)}{\geq} q(\mathcal{G}_U) + \tau = q_{U+\tau}(\mathcal{G}). \quad \square$$

Finally, we will briefly consider the relationship between p_∞ , p_Σ , and $p_{U+\tau}$. We will say that a graph parameter p is *monotonically increasing* if for any two static graphs $G = (V, E)$ and $G' = (V, E')$ with the same vertex set, it is the case that $E \subseteq E'$ implies $p(G) \leq p(G')$. Conversely, it is *monotonically decreasing* if $E \subseteq E'$ implies $p(G) \geq p(G')$.

Proposition 15. *Let p be a graph parameter. Then:*

- (i) $p_\infty \preceq p_\Sigma$,
- (ii) $p_\Sigma \preceq p_{U+\tau}$, if p is monotonically increasing, and
- (iii) $p_\Sigma \succeq p_{U+\tau}$, if p is monotonically decreasing.

Proof. (i) Obvious.

(ii) Let \mathcal{G} be a temporal graph. Note that since $\mathcal{G}_t \subseteq \mathcal{G}_U$, it follows that $p(\mathcal{G}_t) \leq p(\mathcal{G}_U)$ for all $t \in \{1, \dots, \tau\}$. Hence:

$$p_\Sigma(\mathcal{G}) = \sum_{t=1}^{\tau} \max\{1, p(\mathcal{G}_t)\} \leq \tau + \sum_{t=1}^{\tau} p(\mathcal{G}_t) \leq \tau + \tau \cdot p(\mathcal{G}_U) \leq (\tau + p(\mathcal{G}_U))^2 = p_{U+\tau}(\mathcal{G})^2.$$

(iii) Let \mathcal{G} be a temporal graph. Note that since $\mathcal{G}_t \subseteq \mathcal{G}_U$, it follows that $p(\mathcal{G}_t) \geq p(\mathcal{G}_U)$ for all $t \in \{1, \dots, \tau\}$. If $\tau = 1$ or $p(\mathcal{G}_U) \leq 1$, the claim is obvious. Otherwise, we have that:

$$p_\Sigma(\mathcal{G}) = \sum_{t=1}^{\tau} \max\{1, p(\mathcal{G}_t)\} \geq \sum_{t=1}^{\tau} \max\{1, p(\mathcal{G}_U)\} \geq \sum_{t=1}^{\tau} p(\mathcal{G}_U) = \tau \cdot p(\mathcal{G}_U) \geq p_{U+\tau}(\mathcal{G}).$$

□

We will now investigate the problem's parameterized complexity with respect to the three types of parameterizations. Fig. 1 gives an overview of our results and of the abbreviations we use for the parameters. Our choice of parameters is partly motivated by Sorge and Weller's compendium [37] on graph parameters, but we limit our attention to those that are most interesting in the context of MS2C. For full definitions of the parameters, we refer the reader to Sorge and Weller's manuscript [37] or Section 6 in the appendix.

4.1 Underlying graph parameterization

Lemma 16. *If $\mathcal{G} = (V, (E_t)_{t=1}^{\tau})$ is a temporal graph and every layer $\mathcal{G}_t = (V, E_t)$ of \mathcal{G} is bipartite for $t \in \{1, \dots, \tau\}$, then $\text{is}_{U+\tau}(\mathcal{G}) \geq 2^{-\tau}|V|$.*

Proof. (By induction on τ .) If $\tau = 1$, then \mathcal{G}_U is bipartite and the larger color class in any 2-coloring of \mathcal{G}_U forms an independent set containing at least $\frac{1}{2}|V|$ vertices. Suppose the claim holds for $\tau - 1$. Then, the underlying graph of $\mathcal{G}' = (V, (E_t)_{t=1}^{\tau-1})$ contains an independent set $X \subseteq V$ of size at least $2^{-(\tau-1)}|V|$. The graph $(X, \binom{X}{2} \cap E_\tau)$ is bipartite since it is a subgraph of (V, E_τ) . Hence, it contains an independent set Y of size at least $\frac{1}{2}|X| \geq 2^{-\tau}|V|$. Then, Y is also an independent set in \mathcal{G}_U . □

Proposition 17. MULTISTAGE 2-COLORING is fixed-parameter tractable with respect to $\text{is}_{U+\tau}$.

Proof. If any layer of \mathcal{G} is not bipartite, then the input can be immediately rejected. Otherwise, let \mathcal{G}_U be the underlying graph of \mathcal{G} . By Observation 5, MS2C can be solved in time $\mathcal{O}^*(2^{\tau|V|}) \leq \mathcal{O}^*(2^{\tau \cdot \text{is}_{U+\tau}(\mathcal{G}) \cdot 2^\tau})$. □

Proposition 18. MULTISTAGE 2-COLORING is NP-hard even if $\tau = 4$, $\text{dom}(\mathcal{G}_U) \leq 2$, and $\text{dco}(\mathcal{G}_U) = 0$. Hence, the problem is para-NP-hard with respect to $\text{dom}_{U+\tau}$ and $\text{dco}_{U+\tau}$.

Proof. The reduction in Construction 3 may be adjusted to prove this claim. In the following, we only describe how that construction and the proof of Theorem 7 must be adjusted, rather than restating the entire proof. We will use notation defined there.

Let $(G = (V, E), k)$ be the input instance for CLIQUE and let Δ be the maximum degree of G . We change the value of d to $d := m - \binom{k}{2} + k\Delta$. We also adjust ℓ accordingly, so that $\ell = d + 1$ remains true, and τ is increased to $\tau = 4$. The layers will be called E_0, \dots, E_3 . Hence, the instance that the reduction outputs is (\mathcal{G}, d) with $\mathcal{G} = (V', E_0, \dots, E_3)$.

We introduce a new vertex set whose sole purpose is to use up budget for changes. Let $V_4 := \{b_1, \dots, b_{k\Delta}\}$. Then, $V' := V_1 \cup \dots \cup V_4$ where V_1, V_2, V_3 are defined as in the original reduction. The internal edges of V_4 do not change. Let

$$E^Q := E^P \cup \{\{b_i, b_{i+1}\} \mid i \in \{1, \dots, k\Delta - 1\}\}.$$

The purpose of the initial layer E_0 is merely to ensure that the underlying graph has domination number 2 and is a cograph. We achieve this by making the initial layer a complete bipartite graph. The other layers are mostly very similar to those defined in the original reduction. Let:

$$\begin{aligned} W_1 &:= \{u_i^v \in V_1, r_i \in V_3, b_i \in V_4 \mid v \in V, i \text{ is odd}\} \\ W_2 &:= V' \setminus W_1. \end{aligned}$$

Then,

$$\begin{aligned} E_0 &:= \{\{x, y\} \mid x \in W_1, y \in W_2\} \\ E_1 &:= E^Q \cup \{\{r_1, w_2^e\} \mid e \in E\} \cup \{\{r_2, u_1^v\} \mid v \in V\} \cup \{\{r_1, b_2\}\}, \\ E_2 &:= E^Q \cup \{\{r_1, w_2^e\} \mid e \in E\} \cup \{\{u_1^{v_i}, w_1^e\}\{u_1^{v_j}, w_2^e\} \mid e = \{v_i, v_j\} \in E, i < j\} \\ &\quad \cup \{\{r_1, a_1\}, \{r_1, b_1\}\}, \\ E_3 &:= E^Q \cup \{\{w_1^e, w_2^e\}, \{w_2^e, w_3^e\} \mid e \in E\} \cup \{\{r_1, b_2\}\}. \end{aligned}$$

We start by showing that $\text{dom}_{U+\tau}(\mathcal{G}) \leq 2$. This follows from the fact that \mathcal{G}_1 is complete bipartite and neither part of the partition is empty. Hence, taking a vertex from each part yields a dominating set of size 2.

Next we will show that \mathcal{G}_U is a cograph. Since \mathcal{G}_0 is complete bipartite with the parts W_1 and W_2 , it suffices to show that E_1 , E_2 , and E_3 do not contain an induced P_4 containing only vertices in W_1 or only vertices in W_2 . The only such edges are those between w_1^e , w_2^e , and w_3^e . These edges clearly do not form a P_4 .

It is easy to see that \mathcal{G} can be computed in polynomial time.

The correctness proof for the reduction mostly follows along the same lines as in the original reduction. We will explain where it must be adjusted.

Suppose that G contains a clique $X \subseteq V$ of size exactly k . We will give $f_0, f_1, f_2, f_3: V' \rightarrow \{1, 2\}$ proving that (\mathcal{G}, d) is a **yes**-instance. Let $f_0(x) = 1$ if $x \in W_1$ and $f_0(x) = 2$ if $x \in W_2$. In the final three layers, the colors of the vertices in V_1, V_2, V_3 do not change compared to the colors in the proof of the original reduction. The colors of the vertices in V_4 are:

$$f_1(b_i) := f_0(b_i), \quad f_2(b_i) := 3 - f_1(b_i), \quad f_3(b_i) := 3 - f_2(b_i).$$

It is easy to see that these colorings are proper. We must argue that at most d vertices change color between any two consecutive layers. Between the first two layers, only the vertices w_1^e if $v_i \in X$ and w_3^e if $v_j \in X$ for any $e = \{v_i, v_j\}$, $i < j$, change colors. Since the vertices in X have at most Δ incident edges, it follows that the number that change colors is $|X| \cdot \Delta = k\Delta \leq d$. Between the layers E_1 and E_2 , the only vertices that change colors are those that change colors in the original reduction and the vertices in V_4 . Hence the total number is at most $m - \binom{k}{2} + |V_4| = m - \binom{k}{2} + k\Delta = d$. The same thing applies to the changes between the final two layers.

Now suppose that f_1, \dots, f_4 are proper 2-colorings of the layers of \mathcal{G} such that at most d vertices change colors between consecutive layers. Like in the original reduction, no vertex in V_3 may change colors. This also implies that the vertices in V_1 cannot change colors between the layers E_0 and E_1 . This implies that the coloring of the vertices in V_1, V_2, V_3 in the layer E_1 is as in the proof of the original reduction. Between the layers E_1 and E_2 and between the layers E_2 and E_3 , all the vertices in V_4 must change colors. Hence, only $m - \binom{k}{2}$ vertices in V_1, V_2, V_3 may change colors. Hence, the same argument as in the original reduction applies. \square

Proposition 19. MULTISTAGE 2-COLORING can be solved in $\mathcal{O}^*(2^{\tau \cdot \text{tw}_{U+\tau}(\mathcal{G})} \cdot (d+1)^{2\tau})$ time. Hence, the problem is in XP when parameterized by $\text{tw}_{U+\tau}$.

Proof. The proof utilizes a standard dynamic programming approach for problems parameterized by treewidth, extending it to the multistage context. Let $(\mathcal{G} = (V, (E_t)_{t=1}^r), d)$ be an instance of MULTISTAGE 2-COLORING.

Let $\mathcal{T} = (\mathcal{X}, T)$ be a tree decomposition of width $\text{tw}_{U+\tau}(\mathcal{G})$ of the underlying graph \mathcal{G}_U where $\mathcal{X} = \{X_1, \dots, X_r\}$ are the bags associated with the vertex sets $V(X_1), \dots, V(X_r) \subseteq V$ and

T is a rooted tree with vertex set \mathcal{X} . Without loss of generality, we may assume that \mathcal{T} is a nice tree decomposition (for a definition, see, e.g., [26, Sect. 13.1]). For any $s \in \{1, \dots, r\}$, let $V_s \subseteq V$ denote the set of all vertices contained in a bag that is part of the subtree of T rooted at X_s . A *partial multistage two-coloring* (pmt) f of $V' \subseteq V$ is a sequence of functions $f = (f_1, \dots, f_\tau)$ with $f_t: V' \rightarrow \{1, 2\}$. We will call f *proper* if each f_t is a proper two-coloring of $(V', E_t \cap \binom{V'}{2})$. Note that the number of pmts of V' is at most $2^{\tau|V'|}$. The *cost* of f is the vector

$$c(f) := (\delta(f_1, f_2), \dots, \delta(f_{\tau-1}, f_\tau)) \in \mathbb{N}_0^{\tau-1}$$

if f is proper and $c(f) = \infty$ if it is not. If $\tilde{V} \subseteq V'$ and \tilde{f} is a pmt of \tilde{V} , then f is an *extension* of \tilde{f} , if $f(v) = \tilde{f}(v)$ for all $v \in \tilde{V}$.

We compute a table C with an entry $C[X_s, f, \delta_1, \delta_2, \dots, \delta_{\tau-1}]$ for every bag $X_s \in \mathcal{X}$, pmt f of $v(X_s)$, and $\delta_1, \dots, \delta_{\tau-1} \in \{0, \dots, d\}$. The value of $C[X_s, f, \delta_1, \delta_2, \dots, \delta_{\tau-1}]$ is 1 if there is a proper pmt \tilde{f} of V_s that is an extension of f and has $c(\tilde{f}) \leq (\delta_1, \dots, \delta_{\tau-1})$ (component-wise). Otherwise, the value is 0. Since $|V(X_s)| \leq \text{tw}(G_U)$ for all s , the number of entries of C is at most $r \cdot 2^{\tau \cdot \text{tw}(G_U)} \cdot (d+1)^\tau$.

We compute C from the leaves of T up. First, assume that X_s with $V(X_s) = \{v\}$ is a leaf node of T . Then, for any pmt f of X_s and $\delta_1, \dots, \delta_{\tau-1} \in \{0, \dots, d\}$, we set $C[X_s, f, \delta_1, \delta_2, \dots, \delta_{\tau-1}] = 1$ if and only if $c(f) \leq (\delta_1, \dots, \delta_{\tau-1})$. Now, suppose that X_s is an insertion node, that $X_{s'}$ is its only child, and that $V(X_s) \setminus V(X_{s'}) = \{v\}$. For any proper pmt f of $V(X_s)$, let f' be the pmt of $V(X_{s'})$ obtained by deleting v from the domain. For $t \in \{1, \dots, \tau-1\}$, let $\delta_t^v = 1$ if $f_t(v) \neq f_{t+1}(v)$ and $\delta_t^v = 0$, otherwise. Then, $C[X_s, f, \delta_1, \delta_2, \dots, \delta_{\tau-1}] = C[X_{s'}, f', \delta_1 - \delta_1^v, \dots, \delta_{\tau-1} - \delta_{\tau-1}^v]$. If f is not proper, then we simply set $C[X_s, f, \delta_1, \delta_2, \dots, \delta_{\tau-1}] = 0$. Next, suppose that X_s is a forget node, let $X_{s'}$ again be its only child, and let $V(X_{s'}) \setminus V(X_s) = \{v\}$. For any pmt f of $V(X_s)$, define two extensions f_1 and f_2 to $V(X_{s'})$ by assigning v the colors 1 and 2, respectively. Then, $C[X_s, f, \delta_1, \delta_2, \dots, \delta_{\tau-1}] = \min_{i \in \{1, 2\}} C[X_{s'}, f_i, \delta_1, \dots, \delta_{\tau-1}]$. Finally, suppose that X_s is a join node with children $X_{s'}$ and $X_{s''}$ such that $V(X_s) = V(X_{s'}) = V(X_{s''})$. Then, we set $C[X_s, f, \delta_1, \delta_2, \dots, \delta_{\tau-1}] = 1$ if there are $\delta'_1, \dots, \delta'_{\tau-1}$ and $\delta''_1, \dots, \delta''_{\tau-1}$ such that the following conditions hold: (i) $\delta_t \geq \delta'_t + \delta''_t$ for all $t \in \{1, \dots, \tau-1\}$, (ii) $C[X_{s'}, f, \delta'_1, \dots, \delta'_{\tau-1}] = 1$, and (iii) $C[X_{s''}, f, \delta''_1, \dots, \delta''_{\tau-1}] = 1$.

The input instance (\mathcal{G}, d) is a **yes**-instance if and only if there is an f with $C[X_a, f, d, \dots, d] = 1$ where X_a is the root of \mathcal{X} .

Running time: As we mentioned before, the table C has at most $r \cdot 2^{\tau \cdot \text{tw}(G_U)} \cdot (d+1)^\tau$ entries. Moreover, $r \in \mathcal{O}(n)$. Computing an entry requires determining whether a pmt is proper and in the worst case (join nodes) $(d+1)^\tau$ look-ups. This leads to a total running time of $\mathcal{O}^*(2^{\tau \cdot \text{tw}(G_U)} \cdot (d+1)^{2\tau})$.

Correctness: By induction on the structure of \mathcal{T} . □

Note that the running time of this algorithm also implies that MULTISTAGE 2-COLORING is fixed-parameter tractable with respect to $\tau + d + \text{tw}_{U+\tau}$.

Proposition 20. MULTISTAGE 2-COLORING is NP-hard even if $\tau = 3$ and $\Delta(G) = 3$. Hence, the problem is para-NP-hard with respect to $\Delta_{U+\tau}$.

Proof sketch. The proof is an adjustment of Construction 3, similar to the proof of Proposition 18. We will only give a brief sketch. Let Δ denote the maximum degree of the graph G in the input instance (G, k) for CLIQUE. We extend the lengths of the paths representing the vertices in G such that they each contain $2\Delta + 1$ vertices. Then, the edges in E_2 between u_1^v and vertices representing the edges incident to v are connected to $u_3^v, u_5^v, \dots, u_{2 \cdot \deg(v)+1}^v$. This requires us to change d to $d := \max\{k(2\Delta + 1), m - \binom{k}{2}\}$. Then, we introduce a gadget (like in the proof of Proposition 18) to use up the extraneous budget either between layers E_1 and E_2 or between E_2 and E_3 . In the same way, we replace the path r_1, \dots, r_{d+1} by a longer path in order to reduce the degree of the vertices r_i . □

Proposition 21. MULTISTAGE 2-COLORING is fixed-parameter tractable with respect to $\text{vc}_{U+\tau}$.

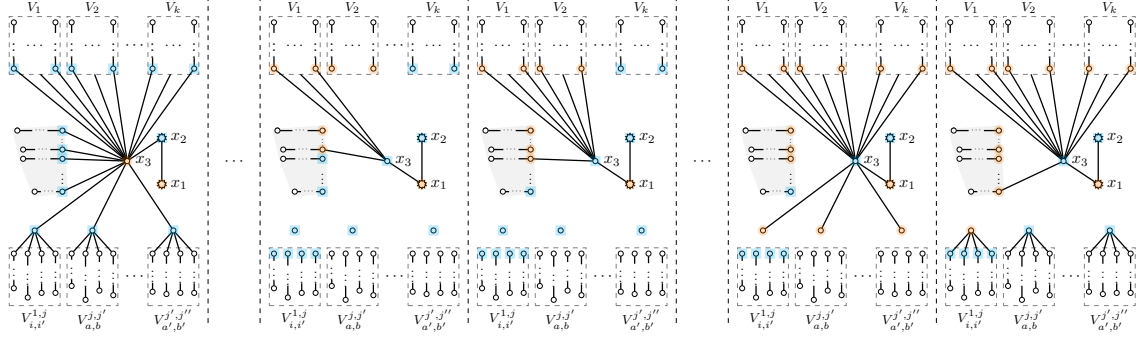

Figure 6: Illustration of Construction 5. Shown are the first layer (left), the two layers when transitioning from the phase regarding V_2 to the phase regarding V_3 (middle), the last two layers (right). In the gray area, the waste-budget gadget is depicted. In this example, the edge $\{v_i^1, v_{i'}^j\}$ is chosen into the clique. Note that many vertices (those from paths and stars) are not depicted.

Proof. Note that $\text{dcc} \preceq \text{vc}$ and, hence, by Proposition 14, $\text{dcc}_\Sigma \preceq \text{vc}_\Sigma$. Moreover, vc is a monotonically increasing parameter. Therefore, by Proposition 15, it follows that $\text{vc}_\Sigma \preceq \text{vc}_{U+\tau}$. As we will show in Theorem 29, MS2C is fixed-parameter tractable when parameterized by dcc_Σ . \square

Proposition 22. MULTISTAGE 2-COLORING is NP-hard even if $\tau = 3$ and $\text{dbi}_{U+\tau} = 2$.

Proof. The claim follows from Construction 3 and the proof of Theorem 7. Note that, if \mathcal{G}_U is the underlying graph of the temporal graph generated by the reduction, then $\mathcal{G}_U - \{r_1, r_2\}$ is bipartite. \square

Next, we will prove that MULTISTAGE 2-COLORING is W[1]-hard with respect to $\text{fes}_{U+\tau}$. In fact, we will prove the following slightly stronger statement:

Proposition 23. MULTISTAGE 2-COLORING is W[1]-hard when parameterized by τ , even if the feedback edge number $\text{fes}(\mathcal{G}_U)$ of the underlying graph is constant.

We already showed that MS2C is XP regarding $\text{tw}_{U+\tau}$ implying that it is XP and W[1]-hard when parameterized by $\text{tw}_{U+\tau}$, $\text{fvs}_{U+\tau}$, and $\text{fes}_{U+\tau}$, since $\text{tw} \preceq \text{fvs} \preceq \text{fes}$. The following hardness proof is a little more involved than most of the previous ones. Our reduction is from the following:

Problem 4. MULTICOLORED CLIQUE (MC)

Input: A k -colored static graph $G = (V, E)$ with $V = V_1 \uplus \dots \uplus V_k$.

Question: Does G contain a clique $X \subseteq V$ such that $|X \cap V_i| = 1$ for all $i \in \{1, \dots, k\}$?

MULTICOLORED CLIQUE is W[1]-hard when parameterized by k [14, 32].

Construction 5. Let $(G = (V, E), k)$ with $V = V_1 \uplus \dots \uplus V_k$ be an instance of MULTICOLORED CLIQUE. We may assume that $|V_1| = \dots = |V_k| = n$ (if color classes do not have the same size, we can add isolated vertices), that all V_i are independent, and that $|E| \geq \binom{k}{2}$ (otherwise, this is clearly a no-instance). Let $V_i = \{v_0^i, \dots, v_{n-1}^i\}$.

We will now describe an instance $(\mathcal{G} = (V', (E_t)_{t=1}^\tau), d)$ of MULTISTAGE 2-COLORING with $\text{fes}(\mathcal{G}_U) = 2$ (see Fig. 6 for an illustration). We let $\tau := 2k(k-1) + 3$ and $d := |E|$.

The general idea behind the reduction is as follows. We consider the steps between consecutive layers and the number of changes to the coloring in those steps. The value of τ implies that there are $2k(k-1) + 2$ steps in total. There are $2k-2$ such steps for each color class in G , while the final two steps do not correspond to any color class. Of the $2k-2$ steps that correspond to $c \in \{1, \dots, k\}$, two will be used to verify adjacency to each of the $k-1$ other color classes. In order

to be able to refer to these steps easily, we will use the following notation for any $c, c' \in \{1, \dots, k\}$, $c \neq c'$:

$$T(c \rightarrow c') := \begin{cases} 2(c-1)(k-1) + c', & \text{if } c < c', \\ 2(c-1)(k-1) + c' - 1, & \text{if } c > c', \end{cases} \text{ and}$$

$$T(c \Rightarrow c') := T(c \rightarrow c') + k - 1$$

We will use several gadgets. The first gadget maintains its coloring throughout most of the lifetime of the instance. We use it to enforce a particular, predictable coloring on vertices in other gadgets at certain points. The second type of gadget represents the selection of a vertex in a certain color class. If the vertex v_j^i is to be added to the clique, it forces any multistage 2-coloring to make j changes in the first $k-1$ steps corresponding to the color class i and $n-j-1$ changes in the following $k-1$ steps corresponding to this class. There is a third type of gadget. Its purpose is to verify that the vertices selected by the first gadget type are pairwise adjacent. There are numerous additional vertices whose sole purpose is to ensure that the coloring of vertices cannot change in unexpected ways. More specifically, when we say that a vertex v is *blocked* in time step t , we mean that we add d vertices that are adjacent to v in the layers $t-1$ and t and isolated in all other layers. There are also further vertices designed to use up extraneous budget for changes during certain time steps.

We start by describing the first gadget, whose purpose is to maintain a predictable coloring so it can be used to enforce a certain coloring on other parts of the instance at particular points in time. This gadget contains the vertices x_1, x_2, x_3 . The edge $\{x_1, x_2\}$ is present in every layer of \mathcal{G} . The edge $\{x_2, x_3\}$ exists only in the first layer, while $\{x_1, x_3\}$ is in the all but the first layers. The vertices x_1 and x_2 are blocked in every step.

Next, we define the second type of gadget, which models the selection of a vertex in a color class. The gadget representing a certain color class V_c , $c \in \{1, \dots, k\}$, consists of $(n-1)(k-1)$ vertices $w_{i,j}^c$ for $i \in \{1, \dots, n-1\}$, $j \in \{1, \dots, k-1\}$. The vertex $w_{i,j}^c$ is blocked in all time steps except for the step $T(c \rightarrow j)$ and the step $T(c \Rightarrow j)$. There is an edge between $w_{i,j}^c$ and $w_{i,j+1}^c$ in the layers from $T(c \rightarrow j+1)$ to $T(c \Rightarrow 1)$ and from $T(c \Rightarrow j)$ to $T(c+1 \rightarrow 1)$. Additionally, in the very first and in the final layer of \mathcal{G} , all edges $\{w_{i,j}^c, w_{i,j+1}^c\}$ are present and there is an edge from x_3 to $w_{i,1}^c$ for all $c \in \{1, \dots, k\}$ and $i \in \{1, \dots, n-1\}$. Moreover, for every $c \in \{1, \dots, k\}$, there is an edge from x_3 to $w_{i,1}^c$ for all $i \in \{1, \dots, n-1\}$ in all layers of index larger than $T(c \Rightarrow c')$, with $c' = \max\{1, \dots, k\} \setminus \{c\}$. This gadget is illustrated in the top part of Fig. 7.

Next, we will describe the gadget that verifies that vertices selected in the previous gadget are pairwise adjacent. There is one such gadget for every edge $e = \{v_j^c, v_{j'}^{c'}\} \in E$, $1 \leq c < c' \leq k$, $j, j' \in \{0, \dots, n-1\}$. The gadget consists of a root vertex u_0^e and four paths. The root is blocked in every step except for the final two. There is an edge between u_0^e and x_3 in the first and the $(\tau-2)$ nd layer. The first vertex of each of the four paths is adjacent to u_0^e in the first and in the final layer. The edges of the paths are present in every layer. These paths consist of $n-1-j$, j , $n-1-j'$, and j' vertices, respectively. The vertices on the path of size $n-1-j$ are blocked in every time step except for step $T(c \rightarrow c')$. Those on the path of size j are blocked except for step $T(c \Rightarrow c')$. The vertices on the path of size $n-1-j'$ are blocked except for step $T(c' \rightarrow c)$. Finally, those on the path of size j' are blocked except for step $T(c' \Rightarrow c)$.

Finally, there is a gadget whose purpose is to waste extraneous budget for changes. It consists of $\tau-2$ paths. There are $\tau-4$ paths $P_3, \dots, P_{\tau-2}$ containing $d-(n-1)$ vertices each, one path P_2 that consists of $d-n$ vertices, and one path P_τ that consists of $\binom{k}{2}$ vertices. For each $i \in \{2, \dots, \tau\} \setminus \{\tau-1\}$, the first vertex in P_i is adjacent to x_3 exactly in the first and i th layer, where in all but the i th layer, all vertices from P_i are blocked. \diamond

Lemma 24. *The input instance to Construction 5 is a **yes**-instance for MULTICOLORED CLIQUE if and only if the output instance is a **yes**-instance for MULTISTAGE 2-COLORING.*

Proof. (\Rightarrow) Suppose that $X = \{v_{i_1}^1, \dots, v_{i_k}^k\}$ with $v_{j_i}^i \in V_i$ is a multicolored clique in G . We must construct proper 2-colorings $f_1, \dots, f_\tau: V^i \rightarrow \{1, 2\}$ with $\delta(f_t, f_{t+1}) \leq d$.

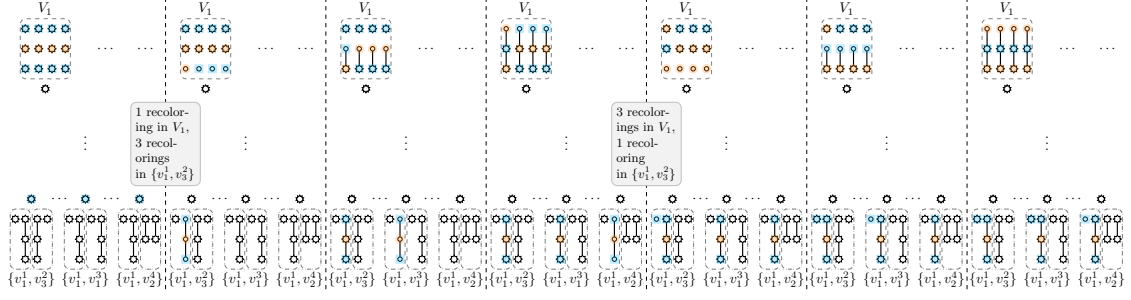

Figure 7: Illustrative example of the recolorings in Construction 5. Here, $n = 5$ and $k = 4$. The recolorings here represents the case that vertex v_1^1 is chosen into the clique, together with its incident edges to v_3^2 , v_1^3 , and v_2^4 .

We let $f_t(x_1) := 1$ and $f_t(x_2) := 2$ for all $t \in \{1, \dots, \tau\}$. The coloring of x_3 is $f_1(x_3) := 1$ and $f_t(x_3) := 2$ for all $t \in \{2, \dots, \tau\}$. Next, we consider the vertices that are part of the second type of gadget (see Fig. 7 for an illustrative example). Let $c \in \{1, \dots, k\}$, then for any $t \in \{1, \dots, \tau\}$, we let:

$$f_t(w_{i,j}^c) := \begin{cases} 1 + (j \bmod 2), & \text{if } t \leq T(c \rightarrow j), \\ 1 + (j \bmod 2), & \text{if } T(c \rightarrow j) + 1 \leq t \leq T(c \Rightarrow j) \text{ and } i > i_c, \\ 1 + (j + 1 \bmod 2), & \text{if } T(c \rightarrow j) + 1 \leq t \leq T(c \Rightarrow j) \text{ and } i \leq i_c, \\ 1 + (j + 1 \bmod 2), & \text{if } t > T(c \Rightarrow j) + 1. \end{cases}$$

Next, we will give the coloring of the vertices in the gadget that verifies adjacency within the clique. First, consider an edge e that has at least one endpoint outside of the clique. Then, $f_t(u_0^e) := 2$ for all $t \in \{1, \dots, \tau - 2\} \cup \{\tau\}$ and $f_{\tau-1}(u_0^e) := 1$. If y is the i -th vertex on one of the four paths in the gadget, then $f_t(y) := 1 + (i + 1 \bmod 2)$ for $t \in \{1, \dots, \tau\}$. Next, consider an edge $e = \{v_{i_c}^c, v_{i_{c'}}^{c'}\}$ with $c \neq c'$ that has both endpoints in X . Then, $f_t(u_0^e) := 2$ for all $t \in \{1, \dots, \tau - 2\}$ and $f_t(u_0^e) := 1$ for $t \in \{\tau - 1, \tau\}$. Let $y_i^{T(c \rightarrow c')}$, $y_i^{T(c \Rightarrow c')}$, $y_i^{T(c' \rightarrow c)}$, and $y_i^{T(c' \Rightarrow c)}$ be the i -th vertex on the path containing $n - 1 - c$, c , $n - 1 - c'$, and c' vertices, respectively. Then, the coloring of this vertex is:

$$f_t(y_i^{t'}) := \begin{cases} 1 + (i + 1 \bmod 2), & \text{if } t \leq t', \\ 1 + (i \bmod 2), & \text{if } t > t', \end{cases}$$

for $t' \in \{T(c \rightarrow c'), T(c \Rightarrow c'), T(c' \rightarrow c), T(c' \Rightarrow c)\}$. As to the gadget used to waste budget, The vertices on the paths P_i only change (completely) their colors in the i th layer. Finally, any vertex u introduced to block another vertex v in step t receives the coloring $f_{t'}(u) := 3 - f_t(v)$ for all $t' \in \{1, \dots, \tau\}$.

It is easy to verify that f_1, \dots, f_τ are proper 2-colorings. We must show that $\delta(f_t, f_{t+1}) \leq d$ for all $t \in \{1, \dots, \tau - 1\}$. First, consider $t = T(c \rightarrow c')$. The number of vertices that change their colors in order to use up budget between f_t and f_{t+1} is $d - (n - 1)$. The vertices $w_{i,c'}^c$ for all $i \in \{1, \dots, i_c\}$ also change colors. Finally, the only vertices in an adjacency verification gadget that change colors are in the gadget for the edge $\{v_{i_c}^c\}$. All vertices in the path containing $n - i_c - 1$ vertices change their colors. No other vertex changes its colors. That accounts for a total of $d - (n - 1) + i_c + (n - i_c - 1) = d$ changes. The argument for $t = T(c \Rightarrow c')$ is analogous. Next, consider $t = \tau - 2$. Between f_t and f_{t+1} , only y_0^e for all $e \in E$ change colors, that is, d changes. For $t = \tau - 1$, the vertices that change colors between f_t and $f_{\tau+1}$ are $\binom{k}{2}$ vertices that waste budget and all y_0^e for any $e \in E$ that does not have both endpoints in X . This accounts for $\binom{k}{2} + (d - \binom{k}{2}) = d$ changes.

(\Leftarrow) Let $f_1, \dots, f_\tau: V' \rightarrow \{1, 2\}$ be proper 2-colorings of the layers of \mathcal{G} with $\delta(f_t, f_{t-1}) \leq d$ for all $t \in \{1, \dots, \tau - 1\}$.

We note that if a vertex $v \in V'$ is blocked in time step t , then $f_{t-1}(v) = f_t(v)$. Otherwise, the d vertices adjacent to v in both E_{t-1} and E_t would also have to be re-colored for a total of $d + 1$ vertices that change colors.

Without loss of generality, we may assume that $f_1(x_1) = 1$. This implies that $f_t(x_1) = 1$ and $f_t(x_2) = 2$ for all $t \in \{1, \dots, \tau\}$, since x_1 is blocked in all steps. This fact, in turn, means that $f_1(x_3) = 1$ and $f_t(x_3) = 2$ for all $t \in \{2, \dots, \tau\}$. Hence, all vertices on the path P_i must change colors between f_{i-1} and f_i . For u_0^e , $e \in E$, we have that $f_t(u_0^e) = 2$ for all $t \in \{1, \dots, \tau - 2\}$. Therefore, $f_{\tau-1}(u_0^e) = 1$. Hence, in the remaining gadgets, at most $n - 1$ vertices may change colors between the layers $T(c \rightarrow c')$ and $T(c \rightarrow c') + 1$, no vertex may be re-colored between layers $\tau - 2$ and $\tau - 1$, and at most $d - \binom{k}{2}$ may change between layers $\tau - 1$ and τ .

Because $f_1(x_3) = 1$, it follows that $f_1(w_{i,j}^c) = 1 + (j \bmod 2)$ for all $c \in \{1, \dots, k\}$, $i \in \{1, \dots, n - 1\}$, and $j \in \{1, \dots, k - 1\}$. Because $f_t(x_3) = 2$ for all $t > 1$, it follows that $f_{t'}(w_{i,j}^c) = 1 + (j + 1 \bmod 2)$ for all $t' > T(c \Rightarrow c')$ with $c' = \max\{1, \dots, k\} \setminus c$. Since $w_{i,j}^c$ is blocked in all other steps, it must change colors between the layers $T(c \rightarrow j) - 1$ and $T(c \rightarrow j)$ or between the layers $T(c \Rightarrow j) - 1$ and $T(c \Rightarrow j)$.

For any $c \in \{1, \dots, k\}$, let $i_{c,j} := |\{i \in \{1, \dots, n - 1\} \mid f_{T(c \rightarrow j)-1}(w_{i,1}^c) \neq f_{T(c \rightarrow j)}(w_{i,1}^c)\}|$ denote the number of vertices in the color class gadget re-colored in step $T(c \rightarrow j)$. We claim that $i_{c,j} = i_{c,j+1}$ for all $j \in \{1, \dots, k - 2\}$ and, hence, $i_{c,j} = i_{c,j'}$ for all $j, j' \in \{1, \dots, k - 1\}$. This follows from the fact that, if $w_{i,j}^c$ is re-colored in step $T(c \rightarrow j)$, then its color is $1 + (j + 1 \bmod 2)$ in layer $T(c \rightarrow j + 1)$. Moreover, the edge $\{w_{i,j}^c, w_{i,j+1}^c\}$ appears in layer $T(c \rightarrow j + 1)$. The color of $w_{i,j}^c$ cannot change in step $T(c \rightarrow j + 1)$, since this vertex is blocked. Hence, $f_{T(c \rightarrow j+1)}(w_{i,j+1}^c) = 1 + (j \bmod 2)$. Since $f_{T(c \rightarrow j)}(w_{i,j+1}^c) = 1 + (j + 1 \bmod 2)$, it follows that $w_{i,j+1}^c$ changes colors in this step. By a similar argument, $w_{i,j+1}^c$ cannot change colors in step $T(c \rightarrow j + 1)$ if the color of $w_{i,j}^c$ does not change in step $T(c \rightarrow j)$. This implies the claim. We also note that this implies that $n - i_{c,j} - 1$ vertices must change colors in step $T(c \Rightarrow j)$. We let $i_c := i_{c,1}$ and $X := \{v_{i_1}^1, \dots, v_{i_k}^k\} \subseteq V$. We will show that X is a clique.

Let $F_i := \{e \in E \mid f_\tau(u_0^e) = i\}$ for $i \in \{1, 2\}$. Since, as we mentioned before, $f_{\tau-1}(u_0^e) = 1$ for all $e \in E$ and at most $d - \binom{k}{2}$ of these vertices can change colors between the layers $\tau - 1$ and τ , it follows that $|F_2| \leq |E| - \binom{k}{2}$ and, thus, $|F_1| \geq \binom{k}{2}$. We will show that the graph (X, F_1) is complete. Since F_1 contains $\binom{k}{2}$ edges, it suffices to prove that all edges in F_1 have both of their endpoints in X .

First, we consider the coloring of the four paths in the gadget representing an edge $e \in E^1$ with $e = \{v_i^c, v_{i'}^{c'}\}$. Let y_i denote the i -th vertex on one of these paths. Since y_1 is adjacent to u_0^e in the first layer and $f_1(u_0^e) = 2$, it follows that $f_1(y_i) = 1 + (i + 1 \bmod 2)$. However, since $e \in F_1$, we have that $f_\tau(u_0^e) = 1$ and thus $f_\tau(y_i) = 1 + (i \bmod 2)$. Hence, the color of each of the four paths must change. Now, assume that one of the endpoints of e , without loss of generality v_i^c , is not in X . Then, $i \neq i_c$. First, suppose that $i < i_c$. Consider the path of length $n - i - 1$ that is part of the gadget for e . As we argued before, the color of every vertex on this path must change in some step. Since all of the vertices are blocked in every step but $T(c \rightarrow c')$, it follows that they must change colors in this step. In that step, i_c vertices in the gadget for color class c are recolored. But then, $i_c + n - i - 1 > i_c + n - i_c - 1 = n - 1$ vertices in those two gadgets are colored in step $T(c \rightarrow c')$. This contradicts the fact that at most $n - 1$ in these gadgets may change colors in that step. A similar argument, but involving the step $T(c \Rightarrow c')$, applies if $i > i_c$. This proves that $i = i_c$ and therefore $v_i^c \in X$. Hence, both endpoints of all edges in F_1 are in X and, therefore, X is a clique with one vertex in each color class. \square

This allows us to prove Proposition 23.

Proof of Proposition 23. It is easy to see that Construction 5 can be computed in polynomial time. Moreover, the edge $\{x_1, x_2\}$ forms a feedback edge set of size 1 in the underlying graph of \mathcal{G} , the temporal graph output by Construction 5. This along with Lemma 24 implies the claim. \square

4.2 Maximum parameterization

We turn our attention to the parameterized complexity of MULTISTAGE 2-COLORING with respect to several structural parameters under the maximum parameterization. We begin with ncc_∞ , the maximum number of connected components over all layers. Observe that under any 2-coloring the color of a single vertex determines the coloring of its entire connected component.

Observation 25. *Every 2-colorable static graph with N connected components admits exactly 2^N different 2-colorings.*

This implies that MS2C is fixed-parameter tractable with respect to ncc_∞ .

Proposition 26. MULTISTAGE 2-COLORING admits an $\mathcal{O}(4^{\text{ncc}_\infty(\mathcal{G})}\tau)$ -time algorithm.

Proof. Let $N := \text{ncc}_\infty(\mathcal{G})$. We create an auxiliary static directed graph in the following manner. For each layer of \mathcal{G} , we include a node for every one of the at most 2^N many 2-colorings of this layer. There is a directed edge from a node representing a coloring of \mathcal{G}_t to a node representing a coloring of \mathcal{G}_{t+1} if the recoloring cost between the two is at most d . Finally, add two nodes s, t and connect s to every node corresponding to a coloring of the first layer and connect every node that corresponds to a coloring of the final layer to t . Then, (\mathcal{G}, d) is a yes-instance if and only if the auxiliary graph contains a path from s to t . Moreover, the auxiliary graph contains at most $\mathcal{O}(4^{\text{ncc}_\infty(\mathcal{G})}\tau)$ edges. \square

This result is essentially a stronger version of the statement in Corollary 2 that MULTISTAGE 2-COLORING is fixed-parameter tractable with respect to n , the number of vertices. However, ncc and larger parameters are the only structural parameters that yield fixed-parameter tractability with respect to the maximum parameterization.

Proposition 27. MULTISTAGE 2-COLORING is NP-hard even for constant values of dcc_∞ , vc_∞ , fes_∞ , and bw_∞ .

Proof. By Theorem 11, MS2C is NP-hard even if each layer contains at most three edges and the maximum degree in each layer is at most one. For temporal graphs \mathcal{G} with this property, $\text{dcc}_\infty(\mathcal{G}), \text{vc}_\infty(\mathcal{G}) \leq 3$, $\text{bw}_\infty(\mathcal{G}) \leq 1$, and $\text{fes}_\infty(\mathcal{G}) = 0$. \square

We note that Proposition 13 implies that MS2C does not admit a polynomial kernel for any parameter p listed in Fig. 1, since $n \geq p_\infty$ for all of these parameters.

4.3 Sum parameterization

We start with the parameterized complexity of MULTISTAGE 2-COLORING with respect to several structural parameters under the sum parameterization. For ncc_Σ , fixed-parameter tractability follows from that for ncc_∞ .

We start by proving that MS2C is fixed-parameter tractable with respect to the distance to co-cluster under the sum parameterization. This stands in contrast to the maximum parameterization (see Proposition 27). A graph is a co-cluster if and only if it does not contain $K_2 + K_1$ as an induced subgraph. By a general result obtained by Cai [8], this implies that the problem of determining whether $\text{dcc}(G) \leq k$ for a static graph G is fixed-parameter tractable with respect to k . We will make use of the following fact:

Observation 28. *If G is a co-cluster, then G is edgeless or connected.*

Theorem 29. MULTISTAGE 2-COLORING is fixed-parameter tractable with respect to dcc_Σ .

We will use the following as an intermediate problem.

Problem 5. MULTISTAGE 2-COLORING EXTENSION (MS2CE)

Input: A temporal graph $\mathcal{G} = (V, (E_t)_{t=1}^\tau)$, proper partial 2-colorings $f_1, \dots, f_\tau: V \rightarrow \{1, 2\}$, and an integer $d \in \mathbb{N}_0$.

Question: Are there 2-coloring extensions $\bar{f}_1, \dots, \bar{f}_\tau$, where \bar{f}_t is the extension of f_t for every $t \in \{1, \dots, \tau\}$, such that \bar{f}_t is a proper 2-coloring of (V, E_t) for every $t \in \{1, \dots, \tau\}$ and $\delta(f_t, f_{t+1}) \leq d$ for every $t \in \{1, \dots, \tau - 1\}$?

We have the following immediate reduction rule.

Reduction Rule 1. If an edge e has two colored endpoints, then delete e .

Lemma 30. MULTISTAGE 2-COLORING EXTENSION is polynomial-time solvable if the input does not contain any edges.

Proof. We reduce MULTISTAGE 2-COLORING EXTENSION with no edges to the following job scheduling problem:

Problem 6. $(1 \mid r_j, p_j = 1 \mid L_{\max})$ SCHEDULING

Input: A list of jobs j_1, \dots, j_n , where each job $j_i = (r_i, d_i)$ has a release date $r_i \in \mathbb{N}_0$ and a due date $d_i \in \mathbb{N}_0$, and a maximum lateness $L \in \mathbb{N}_0$.

Question: Is there a schedule $s: \{j_1, \dots, j_n\} \rightarrow \mathbb{N}_0$ such that (i) $s(j_i) \neq s(j_{i'})$ if $i \neq i'$, (ii) $s(j_i) \geq r_i$ for all $i \in \{1, \dots, n\}$, and (iii) $s(j_i) - d_i \leq L$ for all $i \in \{1, \dots, n\}$?

Horn [23, Sect. 2] showed that this variant of the scheduling problem can be solved by a polynomial-time greedy algorithm that always schedules the available job with the earliest due date. Let $(\mathcal{G} = (V, (\emptyset)_{t=1}^\tau), f_1, \dots, f_\tau, d)$ be an instance for MS2CE. We will say that vertex $v \in V$ between $t_1, t_2 \in \{1, \dots, \tau\}$ is *forced to be re-colored* $i \in \{1, 2\}$ if: (i) $t_1 < t_2$ and there is no t_3 with $t_1 < t_3 < t_2$ such that $f_{t_3}(v)$ is defined, (ii) $f_{t_2}(v) = i$, and (iii) $f_{t_1}(v) = 3 - i$. Let $\mathcal{R} \subseteq V \times \{1, \dots, \tau - 1\} \times \{2, \dots, \tau\} \times \{1, 2\}$ be the set of all forced re-colorings. Specifically, $(v, t_1, t_2, i) \in \mathcal{R}$ if and only if v is forced to be re-colored i between t_1 and t_2 .

In the machine scheduling model, only one job can be performed per time step, but, in a solution for an MS2C instance, up to d vertices can be re-colored. Hence, we each transition between two layers with d time slots. For $t \in \{1, \dots, \tau - 1\}$, the time slots $d(t - 1) + 1, \dots, dt$ correspond to changes in the coloring between the layers t and $t + 1$. For any forced re-coloring $(v, t_1, t_2, c) \in \mathcal{R}$, we create a job j_i with release date $r_i = d(t_1 - 1) + 1$ and due date $d_i = dt_2$. We will show that the given instance of MS2CE admits a solution if and only if this set of jobs admits a schedule with maximum lateness 0.

(\Rightarrow) Suppose that $\bar{f}_1, \dots, \bar{f}_\tau$ is a solution to the instance that extends f_1, \dots, f_τ . It is easy to see that, if $(v, t_1, t_2, i) \in \mathcal{R}$, then $\bar{f}_{t_1}(v) \neq \bar{f}_{t_2}(v)$. Hence, there must be a t with $\bar{f}_t(v) \neq \bar{f}_{t+1}(v)$ and $t \in \{t_1, \dots, t_2 - 1\}$. Then, a machine schedule for the instance described above can be constructed by scheduling the job corresponding to (v, t_1, t_2, i) in one of the slots $d(t - 1) + 1, \dots, dt$. Since $\delta(f_t, f_{t+1}) \leq d$, there are enough slots.

(\Leftarrow) Suppose that we are given a machine schedule with maximum lateness 0 for the aforementioned instance. We construct an initial coloring \bar{f}_1 by assigning each vertex v the color i , if there is a $t \in \{1, \dots, \tau\}$ such that $f_t(v) = 1$ and $f_{t'}(v)$ is undefined for all $t' < t$. If $f_t(v)$ is undefined for all $t \in \{1, \dots, \tau\}$, then we assign $\bar{f}_1(v)$ arbitrarily. We construct f_2, \dots, f_τ as follows. We let $f_{t+1}(v) = 3 - f_t(v)$ if the given schedule assigns a job j_i corresponding to a forced re-coloring $(v, t_1, t_2, 3 - f_t(v)) \in \mathcal{R}$ to a slot between $d(t - 1) + 1$ and dt . Otherwise, we let $f_{t+1}(v) = f_t(v)$. \square

The idea in the proof of Theorem 29 is as follows. After computing a distance-to-co-cluster set for each layer, we check for all possible colorings of these sets, and then propagate the colorings. We finally arrive at an instance of MS2CE with no edges, which is decidable in polynomial time.

Proof of Theorem 29. Let $\mathcal{I} = (G, d)$ be an instance of MULTISTAGE 2-COLORING. Let $G = (V, (E_t)_{t=1}^\tau)$ and $G_t := (V, E_t)$ be the t -th layer of G . Let $k := \sum_{t=1}^\tau \text{dcc}(G_t)$. The following algorithm is summarized in pseudocode in Algorithm 1.

Algorithm 1: FPT-algorithm on input instance $\mathcal{G} = (V, (E_t)_{t=1}^\tau), d \in \mathbb{N}_0$.

```

1  $T^+, T^- \leftarrow \emptyset$ ;
2 foreach  $t \in \{1, \dots, \tau\}$  do
3    $X_t \leftarrow$  a minimum set such that  $G_t - X_t$  is a co-cluster;
4   if  $G_t - X_t$  is connected then  $T^+ \leftarrow T^+ \cup \{t\}$  else  $T^- \leftarrow T^- \cup \{t\}$ ;
5 foreach  $f_1: X_1 \rightarrow \{1, 2\}, \dots, f_\tau: X_\tau \rightarrow \{1, 2\}$  do //  $2^{\text{dcc}_{U+\tau}}$  many
6   foreach  $t \in \{1, \dots, \tau\}$  do
7     if  $t \in T^+$  then while  $\exists \{u, v\} \in E_t$  s.t.  $f_t(u) = i$  and  $f_t(v)$  is undefined, let
8        $f_t(v) \leftarrow 3 - i$ ;
9     if  $t \in T^-$  then  $F_t \leftarrow \{f_t^1, f_t^2\}$  with the two possible colorings  $f_t^1, f_t^2$  of  $G_t - X_t$ ;
10    foreach  $(f'_{t_1}, \dots, f'_{t_{|T^-|}}) \in \times_{t \in T^-} F_t$  do //  $\leq 2^\tau$  many
11      Let  $\tilde{f}_t \leftarrow f_t$  if  $t \in T^+$  and  $\tilde{f}_t \leftarrow f_t \cup f'_t$  if  $t \in T^-$ ;
12      if  $\tilde{f}_1, \dots, \tilde{f}_\tau$  are proper partial colorings then
13        if  $(\mathcal{G}, \tilde{f}_1, \dots, \tilde{f}_\tau, d)$  is a yes-instance for MS2CE then
14          return yes // decidable in polynomial time (Lemma 30)
15 return no

```

For each $t \in \{1, \dots, \tau\}$, using Cai's algorithm [8], we can compute in $2^{\mathcal{O}(k)} \cdot |G_t|^{\mathcal{O}(1)}$ time a minimum set $X_t \subseteq V$ such that $G_t - X_t$ is a co-cluster. Let (T^+, T^-) be a partition of $\{1, \dots, \tau\}$ such that $t \in T^+$ if and only if $G_t - X_t$ is connected (see Observation 28). For $t \in T^+$, let $V_t := V(G_t - X_t)$, and for $t \in T^-$, let $V_t := \{v \in V(G_t - X_t) \mid \deg_{G_t}(v) > 0\}$ be the vertices in $G_t - X_t$ incident to at least one edge in G_t . We then iterate over all the at most 2^k possible partial 2-colorings of (X_1, \dots, X_τ) . For every layer $t \in T^+$ there are only two possible 2-colorings of $G_t - X_t$. We iterate over all the at most 2^τ possible 2-colorings of these layers. For every $t \in T^-$, if there is an uncolored vertex v with a neighbor w colored $i \in \{1, 2\}$, then color v with color $3 - i$. Note that this colors all vertices in V_t . Let $\tilde{f}_1, \dots, \tilde{f}_\tau$ be the resulting partial coloring. The important thing to note is that for every $t \in \{1, \dots, \tau\}$ and every edge in E_t both its endpoints are colored by \tilde{f}_t . If one of $\tilde{f}_1, \dots, \tilde{f}_\tau$ is not proper, we reject the coloring, otherwise we proceed as follows.

Construct the instance $\tilde{\mathcal{I}} = (\mathcal{G}, (\tilde{f}_t)_{t=1}^\tau, d)$ of MULTISTAGE 2-COLORING EXTENSION. Since every edge has two colored endpoints, applying Reduction Rule 1 exhaustively results in an instance $\tilde{\mathcal{I}}' = (\mathcal{G}', (\tilde{f}_t)_{t=1}^\tau, d)$ of MULTISTAGE 2-COLORING EXTENSION where \mathcal{G}' contains no edge. Hence, due to Lemma 30, we can solve $\tilde{\mathcal{I}}'$ in polynomial-time. Thus, the overall running time is in $\sum_{t=1}^\tau 2^{\mathcal{O}(k)} \cdot |G_t|^{\mathcal{O}(1)} + 2^{k+\tau} |\mathcal{G}|^{\mathcal{O}(1)}$.

Clearly, if $\tilde{\mathcal{I}}'$ is a *yes*-instance in one choice, then \mathcal{I} is a *yes*-instance of MS2C. That the opposite direction is correct too is also not hard to see. Note that every solution f_1, \dots, f_τ induces a proper partial coloring $\tilde{f}_1, \dots, \tilde{f}_\tau$, where \tilde{f}_t is induced on $V_t \cup X_t$ for every $t \in \{1, \dots, \tau\}$, that we will eventually check. Moreover, the resulting input to MS2CE is clearly a *yes*-instance: f_1, \dots, f_τ is a solution to $(\mathcal{G}, (\tilde{f}_t)_{t=1}^\tau, d)$. \square

Proposition 31. MULTISTAGE 2-COLORING is NP-hard even for constant values of (i) dco_Σ , (ii) fes_Σ , and (iii) Δ_Σ .

Proof. (i) First, note that if all connected components of a static graph G are complete bipartite, then G is a co-graph. Secondly, adding edges to every layer of a temporal graph to make every connected component in every layer complete bipartite does not change the solution to MS2C. Hence, we can apply this modification to the output of Construction 3 in order to generate instances in which every layer is a co-graph and $\tau = 3$.

(ii) Every layer in the temporal graph \mathcal{G} generated by Construction 3 is acyclic. Hence, $\text{fes}_\Sigma(\mathcal{G}) = \tau = 3$.

(iii) Follows from Propositions 15 and 20 and the fact that Δ is monotonically increasing. \square

Our final result on structural parameters concerns bw_Σ , that is, bandwidth with the sum parameterization. We first briefly note the following:

Observation 32. *Let G be an undirected graph. If every connected component in G contains at most k vertices, then $\text{bw}(G) \leq k - 1$.*

We will use this observation to show that MULTISTAGE 2-COLORING is para-NP-hard when parameterized by bw_Σ .

Proposition 33. *MULTISTAGE 2-COLORING is NP-hard even for a constant value of bw_Σ .*

Proof. EDGE BIPARTIZATION is NP-complete, even when restricted to graphs with maximum degree 3 [40]. First, note that, in the first layer of the temporal graph \mathcal{G} output by Construction 2, connected components consist of a vertex v_i as well u_i^e for each edge $e \in E$ incident to v_i . If we assume that G has maximum degree three, it follows that each such connected component contains at most four vertices. Hence, $\text{bw}(\mathcal{G}_1) \leq 3$ by Observation 32. In the second layer, connected components cannot contain more than two vertices and, hence, $\text{bw}(\mathcal{G}_2) \leq 1$ by Observation 32. In all, it follows that $\text{bw}_\Sigma(\mathcal{G}) \leq 4$. \square

5 Global budget

The problem we have considered so far is the multistage version of 2-COLORING with a *local* budget. The solution may only be changed by a certain amount between any two consecutive stages. Heeger et al. [22] started the parameterized research of multistage graph problems on a *global* budget where there is no restriction on the number of changes between any two consecutive layers, but instead a restriction on the total number of changes made throughout the lifetime of the instance. All graph problems studied by Heeger et al. are NP-hard even for constant values of the global budget parameter. By contrast, we will show that a global budget version of MULTISTAGE 2-COLORING is fixed-parameter tractable with respect to the budget. Formally, the global budget version of MULTISTAGE 2-COLORING is:

Problem 7. MULTISTAGE 2-COLORING ON A GLOBAL BUDGET (MS2CGB)

Input: A temporal graph $\mathcal{G} = (V, (E_t)_{t=1}^\tau)$ and an integer $D \in \mathbb{N}_0$.

Question: Are there $f_1, \dots, f_\tau: V \rightarrow \{1, 2\}$ such that f_t is a 2-coloring of (V, E_t) for every $t \in \{1, \dots, \tau\}$ and $\sum_{t=1}^{\tau-1} \delta(f_t, f_{t+1}) \leq D$?

We start by pointing out that MS2CGB, like the local budget version, is NP-hard. This follows from Theorem 7, since there is no distinction between a local and a global budget if $\tau = 2$.

Observation 34. MULTISTAGE 2-COLORING ON A GLOBAL BUDGET is NP-hard.

In order to show that MULTISTAGE 2-COLORING ON A GLOBAL BUDGET is fixed-parameter tractable, we will prove the existence of a parameter-preserving transformation to the ALMOST 2-SAT problem, which is defined by:

Problem 8. ALMOST 2-SAT (A2SAT)

Input: A Boolean formula φ in 2-CNF and an integer k .

Question: Is there a set of at most k clauses whose removal from φ makes the formula satisfiable?

Razgon and O’Sullivan [33] prove that A2SAT is fixed-parameter tractable when parameterized by k , but the fastest presently known algorithm runs in $\mathcal{O}^*(2.3146^k)$ and is due to Lokshitanov et al. [29]. Kratsch and Wahlström [27] show that this problem admits a randomized polynomial kernel.

Proposition 35. MULTISTAGE 2-COLORING ON A GLOBAL BUDGET *parameterized by D admits a parameter-preserving transformation to ALMOST 2-SAT parameterized by k .*

Proof. Let (\mathcal{G}, D) with $\mathcal{G} = (V, (E_t)_{t=1}^\tau)$ be an instance of MS2CGB. Let $k := D$ and define a Boolean formula φ in the following manner. We use the variables x_t^v for $v \in V$ and $t \in \{1, \dots, \tau\}$. Intuitively, the variable x_t^v represents that the vertex v is colored with 1 at time step t if this variable is set to true and colored with 2 if it is set to false. For every edge $\{u, v\} \in E_t$, we add $D + 1$ copies of the clauses $(x_t^u \vee x_t^v)$ and $(\neg x_t^u \vee \neg x_t^v)$ to φ . These clauses express that the edge $\{u, v\}$ should not be monochromatic. Let $\varphi_t := \bigwedge_{\{u, v\} \in E_t} \bigwedge_{i=1}^{D+1} (x_t^u \vee x_t^v) \wedge (\neg x_t^u \vee \neg x_t^v)$ for every $t \in \{1, \dots, \tau\}$. Additionally, for every $t \in \{1, \dots, \tau - 1\}$ and $v \in V$ we add the two clauses $(\neg x_t^v \vee x_{t+1}^v)$ and $(x_t^v \vee \neg x_{t+1}^v)$. These clauses express that the color of v should not change between layers t and $t + 1$. Let $\varphi_t^+ := \bigwedge_{v \in V} (\neg x_t^v \vee x_{t+1}^v) \wedge (x_t^v \vee \neg x_{t+1}^v)$ for every $t \in \{1, \dots, \tau - 1\}$. Clearly, $\varphi := \varphi_\tau \wedge \bigwedge_{t \in \{1, \dots, \tau-1\}} (\varphi_t \wedge \varphi_t^+)$ can be computed in polynomial time from (\mathcal{G}, d) . We claim that (\mathcal{G}, D) admits a multistage 2-coloring with a global budget of at most D if and only if there is a size-at-most- k subset of the clauses of φ whose removal makes the formula satisfiable.

(\Rightarrow) Suppose that the temporal graph \mathcal{G} admits a multistage 2-coloring $f_1, \dots, f_\tau: V \rightarrow \{1, 2\}$ such that $\sum_{t=1}^\tau \delta(f_t, f_{t+1}) \leq D$. We start by giving a truth assignment of the variables of φ . Let:

$$\alpha(x_t^v) := \begin{cases} \top, & \text{if } f_t(v) = 1 \\ \perp, & \text{if } f_t(v) = 2. \end{cases}$$

Observe that because the colorings f_1, \dots, f_τ are proper, φ_t is satisfied for every $t \in \{1, \dots, \tau\}$. We continue by giving a set C of clauses that are to be removed from φ . If $f_t(v) = 1$, but $f_{t+1}(v) = 2$, then we add the clause $(\neg x_t^v \vee x_{t+1}^v)$ to C . Conversely, if $f_t(v) = 2$, but $f_{t+1}(v) = 1$, then we add the clause $(x_t^v \vee \neg x_{t+1}^v)$. Note that $|C| = \sum_{t=1}^\tau |\{v \in V \mid f_t(v) \neq f_{t+1}(v)\}| \leq D = k$. Hence, the assignment α also satisfies all clauses in φ_t^+ that are not in C , for every $t \in \{1, \dots, \tau - 1\}$. It follows that α satisfies φ .

(\Leftarrow) Suppose that C is a set of at most k clauses from φ and α is a truth assignment that satisfies all clauses in φ that are not in C . We derive a multistage coloring of G by setting:

$$f_t(v) := \begin{cases} 1, & \text{if } \alpha(x_t^v) = \top \\ 2, & \text{if } \alpha(x_t^v) = \perp. \end{cases}$$

First, note that C cannot contain all clauses representing an edge, since $|C| \leq k = D$. Hence, for every $t \in \{1, \dots, \tau\}$, since φ_t is satisfied, f_t is a proper coloring of (V, E_t) . We must show that there are at most D changes in the coloring. Suppose that the vertex v changes colors between layers t and $t + 1$. If $f_t(v) = 1$ and $f_{t+1}(v) = 2$, then α does not satisfy the clause $(\neg x_t^v \vee x_{t+1}^v)$, so this clause must be in C . Similarly, if $f_t(v) = 2$ and $f_{t+1}(v) = 1$, then the clause $(x_t^v \vee \neg x_{t+1}^v)$ must be in C . Since $|C| \leq k$, this implies that there can be at most $k = D$ such color changes. \square

This directly implies the following:

Corollary 36. MULTISTAGE 2-COLORING ON A GLOBAL BUDGET *parameterized by D is fixed-parameter tractable and admits a randomized polynomial kernel.*

We briefly note that the approach described here for MS2C can also be used to reduce a global budget version of the more general MULTISTAGE 2-SAT to ALMOST 2-SAT, proving the following:

Observation 37. MULTISTAGE 2-SAT ON A GLOBAL BUDGET *parameterized by the total number of allowed changes is fixed-parameter tractable and admits a randomized polynomial kernel.*

References

- [1] Shorouq Al-Eidi, Yuanzhu Chen, Omar Darwishand, and Ali M. S. Alfosoool. Time-ordered bipartite graph for spatio-temporal social network analysis. In *Proceedings of the 2020 International Conference on Computing, Networking and Communications (ICNC)*, pages 833–838, 2020. doi:10.1109/ICNC47757.2020.9049668. [p. 1.]

- [2] Evripidis Bampis, Bruno Escoffier, and Alexander V. Kononov. LP-based algorithms for multistage minimization problems. In *Proceedings of the 18th International Workshop on Approximation and Online Algorithms (WAOA)*, pages 1–15, 2020. doi:10.1007/978-3-030-80879-2_1. [p. 2.]
- [3] Evripidis Bampis, Bruno Escoffier, Michael Lampis, and Vangelis Th. Paschos. Multistage matchings. In *Proceedings of the 16th Scandinavian Symposium and Workshops on Algorithm Theory (SWAT)*, pages 7:1–7:13, 2018. doi:10.4230/LIPIcs.SWAT.2018.7. [p. 2.]
- [4] Evripidis Bampis, Bruno Escoffier, and Alexandre Teiller. Multistage knapsack. In *Proceedings of the 44th International Symposium on Mathematical Foundations of Computer Science (MFCS)*, pages 22:1–22:14, 2019. doi:10.4230/LIPIcs.MFCS.2019.22. [p. 2.]
- [5] Hans L. Bodlaender, Rodney G. Downey, Michael R. Fellows, and Danny Hermelin. On problems without polynomial kernels. *Journal of Computer and System Sciences*, 75(8):423–434, 2009. doi:10.1016/j.jcss.2009.04.001. [p. 11.]
- [6] Hans L. Bodlaender, Bart M. P. Jansen, and Stefan Kratsch. Kernelization lower bounds by cross-composition. *SIAM Journal on Discrete Mathematics*, 28(1):277–305, 2014. doi:10.1137/120880240. [p. 11.]
- [7] Robert Bredebeck, Till Fluschnik, and Andrzej Kaczmarczyk. Multistage committee election, 2020. arXiv:2005.02300. [p. 2.]
- [8] Leizhen Cai. Fixed-parameter tractability of graph modification problems for hereditary properties. *Information Processing Letters*, 58(4):171–176, 1996. doi:10.1016/0020-0190(96)00050-6. [pp. 20 and 22.]
- [9] Markus Chimani, Niklas Troost, and Tilo Wiedera. Approximating multistage matching problems. In *Proceedings of the 32nd International Workshop on Combinatorial Algorithms (IWOCA)*, pages 558–570, 2021. doi:10.1007/978-3-030-79987-8_39. [p. 2.]
- [10] Marek Cygan, Fedor V. Fomin, Lukasz Kowalik, Daniel Lokshtanov, Dániel Marx, Marcin Pilipczuk, Michal Pilipczuk, and Saket Saurabh. *Parameterized Algorithms*. Springer, 2015. doi:10.1007/978-3-319-21275-3. [p. 2.]
- [11] Reinhard Diestel. *Graph Theory*. Springer, 5th edition, 2017. doi:10.1007/978-3-662-53622-3. [p. 2.]
- [12] Andrew Drucker. New limits to classical and quantum instance compression. *SIAM Journal on Computing*, 44(5):1443–1479, 2015. doi:10.1137/130927115. [p. 11.]
- [13] Michael Fellows, Daniel Lokshtanov, Neeldhara Misra, Matthias Mnich, Frances Rosamond, and Saket Saurabh. The complexity ecology of parameters: An illustration using bounded max leaf number. *Theory of Computing Systems*, 45(4):822–848, 2009. doi:10.1007/s00224-009-9167-9. [p. 11.]
- [14] Michael R. Fellows, Danny Hermelin, Frances A. Rosamond, and Stéphane Vialette. On the parameterized complexity of multiple-interval graph problems. *Theoretical Computer Science*, 410(1):53–61, 2009. doi:10.1016/j.tcs.2008.09.065. [p. 16.]
- [15] Michael R. Fellows, Bart M.P. Jansen, and Frances Rosamond. Towards fully multivariate algorithmics: Parameter ecology and the deconstruction of computational complexity. *European Journal of Combinatorics*, 34(3):541–566, 2013. doi:10.1016/j.ejc.2012.04.008. [p. 11.]
- [16] Till Fluschnik. A multistage view on 2-satisfiability. In *Proceedings of the 12th International Conference on Algorithms and Complexity (CIAC)*, pages 231–244, 2021. doi:10.1007/978-3-030-75242-2_16. [pp. 2, 3, and 10.]
- [17] Till Fluschnik, Hendrik Molter, Rolf Niedermeier, Malte Renken, and Philipp Zschoche. As time goes by: Reflections on treewidth for temporal graphs. In Fedor V. Fomin, Stefan Kratsch, and Erik Jan van Leeuwen, editors, *Treewidth, Kernels, and Algorithms: Essays Dedicated to Hans L. Bodlaender on the Occasion of His 60th Birthday*, pages 49–77. Springer International Publishing, Cham, 2020. doi:10.1007/978-3-030-42071-0_6. [p. 11.]
- [18] Till Fluschnik, Hendrik Molter, Rolf Niedermeier, Malte Renken, and Philipp Zschoche. Temporal graph classes: A view through temporal separators. *Theoretical Computer Science*, 806:197–218, 2020. doi:10.1016/j.tcs.2019.03.031. [p. 1.]
- [19] Till Fluschnik, Rolf Niedermeier, Valentin Rohm, and Philipp Zschoche. Multistage vertex cover. In *Proceedings of the 14th International Symposium on Parameterized and Exact Computation (IPEC)*, pages 14:1–14:14, 2019. doi:10.4230/LIPIcs.IPEC.2019.14. [p. 2.]

- [20] Till Fluschnik, Rolf Niedermeier, Carsten Schubert, and Philipp Zschoche. Multistage s - t path: Confronting similarity with dissimilarity in temporal graphs. In *Proceedings of the 31st International Symposium on Algorithms and Computation (ISAAC)*, pages 43:1–43:16, 2020. doi:10.4230/LIPIcs.ISAAC.2020.43. [pp. 2 and 11.]
- [21] Anupam Gupta, Kunal Talwar, and Udi Wieder. Changing bases: Multistage optimization for matroids and matchings. In *Proceedings of the 41st International Colloquium on Automata, Languages, and Programming (ICALP)*, pages 563–575, 2014. doi:10.1007/978-3-662-43948-7_47. [p. 2.]
- [22] Klaus Heeger, Anne-Sophie Himmel, Frank Kammer, Rolf Niedermeier, Malte Renken, and Andrej Sajenko. Multistage graph problems on a global budget. *Theoretical Computer Science*, 868:46–64, 2021. doi:10.1016/j.tcs.2021.04.002. [pp. 2 and 23.]
- [23] W. A. Horn. Some simple scheduling algorithms. *Naval Research Logistics Quarterly*, 21(1):177–185, 1974. doi:10.1002/nav.3800210113. [p. 21.]
- [24] Bart M. P. Jansen. *The Power of Data Reduction: Kernels for Fundamental Graph Problems*. PhD thesis, Utrecht University, 2013. URL: <http://dspace.library.uu.nl/handle/1874/276438>. [p. 11.]
- [25] Leon Kellerhals, Malte Renken, and Philipp Zschoche. Parameterized algorithms for diverse multistage problems. In *Proceedings of the 29th Annual European Symposium on Algorithms (ESA)*, pages 55:1–55:17, 2021. doi:10.4230/LIPIcs.ESA.2021.55. [p. 2.]
- [26] Ton Kloks. *Treewidth: Computations and Approximations*. Springer, Berlin, Heidelberg, 1994. doi:10.1007/BFb0045375. [p. 15.]
- [27] Stefan Kratsch and Magnus Wahlström. Representative sets and irrelevant vertices: New tools for kernelization. *Journal of the ACM*, 67(3), June 2020. doi:10.1145/3390887. [p. 23.]
- [28] Matthieu Latapy, Clémence Magnien, and Tiphaine Viard. Weighted, bipartite, or directed stream graphs for the modeling of temporal networks. In Petter Holme and Jari Saramäki, editors, *Temporal Network Theory*, pages 49–64. Springer International Publishing, Cham, 2019. doi:10.1007/978-3-030-23495-9_3. [p. 1.]
- [29] Daniel Lokshantov, N. S. Narayanaswamy, Venkatesh Raman, M. S. Ramanujan, and Saket Saurabh. Faster parameterized algorithms using linear programming. *ACM Transactions on Algorithms*, 11(2):1–31, 2014. doi:10.1145/2566616. [p. 23.]
- [30] Hendrik Molter. *Classic Graph Problems Made Temporal: A Parameterized Complexity Analysis*. PhD thesis, Technische Universität Berlin, 2020. doi:10.14279/depositonce-10551. [p. 11.]
- [31] Karolina Okrasa and Paweł Rzażewski. Subexponential algorithms for variants of the homomorphism problem in string graphs. *Journal of Computer and System Sciences*, 109:126–144, 2020. doi:10.1016/j.jcss.2019.12.004. [p. 7.]
- [32] Krzysztof Pietrzak. On the parameterized complexity of the fixed alphabet shortest common super-sequence and longest common subsequence problems. *Journal of Computer and System Sciences*, 67(4):757–771, 2003. doi:10.1016/S0022-0000(03)00078-3. [p. 16.]
- [33] Igor Razgon and Barry O’Sullivan. Almost 2-SAT is fixed-parameter tractable. *Journal of Computer and System Sciences*, 75(8):435–450, 2009. doi:10.1016/j.jcss.2009.04.002. [p. 23.]
- [34] Róbert Sasák. Comparing 17 graph parameters. Master’s thesis, University of Bergen, 2010. URL: <https://bora.uib.no/bora-xmlui/handle/1956/4329>. [p. 11.]
- [35] Thomas J. Schaefer. The complexity of satisfiability problems. In *Proceedings of the 10th Annual ACM Symposium on Theory of Computing (STOC)*, page 216–226, 1978. doi:10.1145/800133.804350. [p. 4.]
- [36] Johannes Schröder. Comparing graph parameters. Bachelor’s thesis, Technische Universität Berlin, 2019. URL: <http://fpt.akt.tu-berlin.de/publications/theses/BA-Schröder.pdf>. [p. 11.]
- [37] Manuel Sorge and Mathias Weller. The graph parameter hierarchy. Unpublished manuscript, 2019. URL: <https://manyu.pro/assets/parameter-hierarchy.pdf>. [pp. 3, 11, and 13.]
- [38] Martin Vatshelle. *New Width Parameters of Graphs*. PhD thesis, University of Bergen, 2012. URL: <https://www.ii.uib.no/~martinv/Papers/MartinThesis.pdf>. [p. 11.]
- [39] Tsunghan Wu, Sheau-Harn Yu, Wanjiun Liao, and Cheng-Shang Chang. Temporal bipartite projection and link prediction for online social networks. In *Proceedings of the 2014 IEEE International Conference on Big Data (Big Data)*, pages 52–59, 2014. doi:10.1109/BigData.2014.7004444. [p. 1.]
- [40] Mihalis Yannakakis. Node- and edge-deletion NP-complete problems. In *Proceedings of the 10th Annual ACM Symposium on Theory of Computing (STOC)*, page 253–264, 1978. doi:10.1145/800133.804355. [pp. 6 and 23.]

6 Parameter zoo

If \mathcal{C} is a class of static graphs and $G = (V, E)$ a static graph, then $X \subseteq V$ is a \mathcal{C} -modulator in G if $G - X \in \mathcal{C}$.

Let $G = (V, E)$ be a static graph.

Bandwidth (bw): Let S_n denote the set of all permutations of $\{1, \dots, n\}$ and assume that $V = \{v_1, \dots, v_n\}$. The *bandwidth* of G is $\text{bw}(G) := \min_{\pi \in S_n} \max_{\{v_i, v_j\} \in E} |\pi(i) - \pi(j)|$.

Cliquewidth (clw): Let $k \in \mathbb{N}$. A k -expression, which evaluates to a graph with vertex labels in $\{1, \dots, k\}$, is defined inductively by: (i) if $i \in \{1, \dots, k\}$, then $\ell(i)$ is a k -expression which evaluates to the graph with a single vertex that is labeled i , (ii) if x_1 and x_2 are k -expressions, then $x_1 \oplus x_2$ is a k -expression which evaluates to the disjoint union of the evaluations of x_1 and x_2 , (iii) if x is a k -expression and $i, j \in \{1, \dots, k\}$, $i \neq j$, then $\eta_{i,j}(x)$ is a k -expression which evaluates to the graph obtained by adding an edge between every pair of vertices $\{u, v\}$ such that u is labeled i and v is labeled j , and (iv) if x is a k -expression and $i, j \in \{1, \dots, k\}$, then $\rho_{i \rightarrow j}$ is a k -expression which evaluates to the graph obtained from the evaluation of x by changing all the labels of vertices labeled i to j . The *cliquewidth* $\text{clw}(G)$ of G is the minimum integer k such that there is a k -expression that evaluates to G .

Degeneracy (dgn): Let $\delta(H)$ denote the minimum degree of a graph H . The *degeneracy* of G is $\text{dgn}(G) = \max_{V' \subseteq V} \delta(G[V'])$.

Distance to bipartite (dbi): The parameter $\text{dbi}(G)$ is the size of a minimum \mathcal{C} -modulator if \mathcal{C} is the set of all bipartite graphs.

Distance to clique (dcl): A graph $H = (V', E')$ is *complete* if $E' = \binom{V'}{2}$. The parameter $\text{dcl}(G)$ is the size of a minimum \mathcal{C} -modulator if \mathcal{C} is the set of all complete graphs.

Distance to co-cluster (dcc): A graph $H = (V', E')$ is a *co-cluster* if $V' = V_1 \cup \dots \cup V_k$ for some $k \in \mathbb{N}$ and $E' = \{\{u, v\} \mid u \in V_i, v \in V_j, i \neq j\}$. The parameter $\text{dcc}(G)$ is the size of a minimum \mathcal{C} -modulator if \mathcal{C} is the set of all co-clusters.

Distance to co-graph (dco): A graph is a *co-graph* if it does not contain an induced P_4 . The parameter $\text{dco}(G)$ is the size of a minimum \mathcal{C} -modulator if \mathcal{C} is the set of all co-graphs.

Domination number (dom): A vertex set $X \subseteq V$ dominates G if every vertex in $V \setminus X$ has a neighbor in X . The parameter $\text{dom}(G)$ is the size of a minimum dominating set in G .

Feedback edge number (fes): A set of edges $X \subseteq E$ is a feedback edge set if $G - X$ is acyclic. The parameter $\text{fes}(G)$ is the size of a minimum feedback edge set.

Feedback vertex number (fvs): The parameter $\text{fvs}(G)$ is the size of a minimum \mathcal{C} -modulator if \mathcal{C} is the set of all acyclic graphs.

Independence number (is): A vertex set $X \subseteq V$ is *independent* if $G[X]$ is edgeless. The parameter $\text{is}(G)$ is the size of a maximum independent set in G .

Maximum degree (Δ): The parameter $\Delta(G)$ is the maximum degree of G .

Maximum diameter of a connected component (cdi): The vertex set $X \subseteq V$ is a *connected component* if $G[X]$ is connected and there is no edge $\{u, v\} \in E$ with $u \in X$ and $v \in V \setminus X$. The *distance* between two vertices is the length of a shortest path between them. The *diameter* of a connected graph is the maximum distance between any two vertices. The parameter $\text{cdi}(G)$ is the maximum diameter of a connected component in G .

Number of connected components (ncc): The parameter $\text{ncc}(G)$ is the number of connected components in G .

Treewidth (tw): A *tree decomposition* of G is a pair $(\mathcal{X}, \mathcal{T})$ where $\mathcal{X} \subseteq 2^V$ and \mathcal{T} is a tree with node set \mathcal{X} such that (i) $\bigcup_{X \in \mathcal{X}} X = V$, (ii) for $\{u, v\} \in E$ there is an $X \in \mathcal{X}$ such that $u, v \in X$, and (iii) for every $v \in V$ the node set $\{X \in \mathcal{X} \mid v \in X\}$ induces a subtree of \mathcal{T} . The *width* of $(\mathcal{X}, \mathcal{T})$ is $\max_{X \in \mathcal{X}} |X| - 1$. The *treewidth* $\text{tw}(G)$ of G is the minimum width of a tree decomposition of G .

Vertex cover number (vc): The parameter $\text{vc}(G)$ is the size of a minimum \mathcal{C} -modulator if \mathcal{C} is the set of all edgeless graphs.