

Folding transformations for q -Painlevé equations

M. Bershtein ^{*1,2,3} and A. Shchechkin ^{†2,3}

¹Landau Institute for Theoretical Physics, Chernogolovka, Russia

²Skolkovo Institute of Science and Technology, Moscow, Russia

³National Research University Higher School of Economics, Moscow, Russia

Abstract

Folding transformation of the Painlevé equations is an algebraic (of degree greater than 1) transformation between solutions of different equations. In 2005 Tsuda, Okamoto and Sakai classified folding transformations of differential Painlevé equations. These transformations are in correspondence with automorphisms of affine Dynkin diagrams.

We give a complete classification of folding transformations of the q -difference Painlevé equations, these transformations are in correspondence with certain subdiagrams of the affine Dynkin diagrams (possibly with automorphism). The method is based on Sakai's approach to Painlevé equations through rational surfaces.

Contents

1	Introduction	3
2	Classification of folding transformations	9
2.1	Main problems	9
2.2	Stabilizer	11
2.3	Reduction to type A	13
2.4	Selection rules	14
2.5	Answers	19
2.6	Invariant lattices and normalizers	20
3	Geometric realization	24
3.1	Picard lattice	24
3.2	Quotient	25
3.3	Nodal curves and symmetries on image	31
3.4	Answers	34
4	Folding transformation: lattices, normalizers and components	36
4.1	$E_8^{(1)}/A_0^{(1)}$	36
4.2	$E_7^{(1)}/A_1^{(1)}$	38
4.3	$E_6^{(1)}/A_2^{(1)}$	42
4.4	$D_5^{(1)}/A_3^{(1)}$	44
4.5	$A_4^{(1)}/A_4^{(1)}$	47
4.6	$E_3^{(1)}/A_5^{(1)}$	47
4.7	$E_2^{(1)}/A_6^{(1)}$	48
4.8	$A_1^{(1)}/A_7^{(1)'}$	49

*mbersht@gmail.com

†A.Shchechkin@skoltech.ru

5	Geometric realization: answers	50
5.1	$E_8^{(1)}/A_0^{(1)}$	50
5.1.1	$3A_2$	50
5.1.2	$4A_1$	52
5.1.3	$A_1 + 2A_3$	53
5.2	$E_7^{(1)}/A_1^{(1)}$ surface	54
5.2.1	π	54
5.2.2	$3A_1$	55
5.2.3	$4A_1$	57
5.2.4	$3A_2$	58
5.2.5	$2A_3$	59
5.2.6	$\pi \times 5A_1$	59
5.3	$E_6^{(1)}/A_2^{(1)}$ surface	61
5.3.1	π	61
5.3.2	$2A_2$	63
5.3.3	$4A_1$	64
5.4	$D_5^{(1)}/A_3^{(1)}$ surface	66
5.4.1	π^2	66
5.4.2	$2A_1$	67
5.4.3	π	69
5.4.4	$A_3 + A_1$	70
5.4.5	$\pi^2 \times 3A_1$	72
5.4.6	$4A_1$	73
5.5	$E_3^{(1)}/A_5^{(1)}$ surface	75
5.5.1	π^3	76
5.5.2	A_1	77
5.5.3	π^2	79
5.5.4	A_2	80
5.6	$E_2^{(1)}/A_6^{(1)}$ surface	82
5.7	$E_1^{(1)}/A_7^{(1)}$ surface	83
5.7.1	π^2	83
5.7.2	σ	84
6	Further questions	86
6.1	Continuous limit	86
6.2	Relation to known foldings of q -Painlevé equations	86
A	Foldings, leaving no dynamics	88

1 Introduction

The paper is devoted to the classification of folding transformations between solutions of q -difference Painlevé equations. We first explain the problem and illustrate it by a simple instructive example.

q -Painlevé equations. The q -difference Painlevé equations are systems of two difference equations on two functions which we denote by F, G . The celebrated Sakai's classification [Sak01] assigns to each q -difference Painlevé equation two affine root systems. These systems are called the symmetry and the surface root systems, and are denoted by Φ_{sym}^a and Φ_{surf}^a respectively. The list of all pairs, together with arrows of degenerations is given in the Fig. 1.

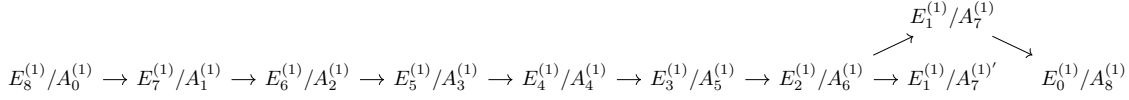

Figure 1: Symmetry/surface classification scheme for q -difference Painlevé equations

Here we use the notation $E_5^{(1)} = D_5^{(1)}$, $E_4^{(1)} = A_4^{(1)}$, $E_3^{(1)} = (A_2 + A_1)^{(1)}$, $E_2^{(1)} = (A_1 + A_1)^{(1)}$, $E_1^{(1)} = A_1^{(1)}$.

The symmetry group of a Painlevé equation is an extended affine Weyl group W^{ae} of the root system Φ_{sym}^a , translations in W^{ae} generate q -difference dynamics. The F, G are then coordinates on (some chart of) the surface $\mathcal{X}_{\vec{a}}$ called the space of initial conditions [Sak01]. This surface depends on set of parameters a_0, \dots, a_r which are called multiplicative root variables; here $r + 1$ is the rank of Φ_{sym}^a . The Weyl group acts on a_j as

$$s_i(a_j) = a_j a_i^{-C_{ij}}, \quad \pi(a_i) = a_{\pi(i)}, \quad (1.1)$$

where s_0, \dots, s_r are simple reflections, C is a Cartan matrix of Φ_{sym}^a and π is an external automorphism.

Example 1.1. The dynamics of the q -Painlevé equation is usually denoted by an underline and an overline, $\dots \mapsto \underline{X} \mapsto X \mapsto \overline{X} \mapsto \dots$. The standard q -Painlevé equation of the symmetry/surface type $D_5^{(1)}/A_3^{(1)}$ together with symmetry type Dynkin diagram and transformation of root variables are given below

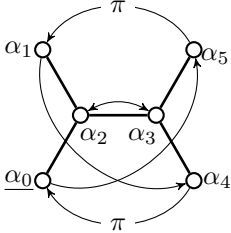

$$\begin{aligned} F\underline{F} &= a_1^{-1} \frac{(G - a_3^{-1})(G - a_5^{-1}a_3^{-1})}{(G - 1)(G - a_4)}, & \overline{a_{0,1,4,5}} &= a_{0,1,4,5}, \\ G\underline{G} &= a_4 \frac{(F - a_2)(F - a_0a_2)}{(F - 1)(F - a_1^{-1})}, & \overline{a_2} &= qa_2, \overline{a_3} = q^{-1}a_3, \\ & & q &= a_0a_1a_2^2a_3^2a_4a_5. \end{aligned} \quad (1.2) \quad (1.3)$$

This equation is a q -analog of the Painlevé VI equation. Here a_2 can be considered as a time, a_3 could be replaced by q , while a_0, a_1, a_4, a_5 are the four parameters of the equation.

The symmetry group is $W_{D_5}^{ae}$, it is generated by the simple reflections s_0, \dots, s_5 and an order 4 external automorphism π which permutes the s_i (arrows on above Dynkin diagram). The variables a_i are multiplicative root variables and the action of $W_{D_5}^{ae}$ on them is given by (1.1). The action of this group on the coordinates F, G is given by

coord.	s_0	s_1	s_2	s_3	s_4	s_5	π
F	F	a_1F	$a_2^{-1}F$	$F \frac{G-1}{G-a_3^{-1}}$	F	F	$1/G$
G	G	G	$G \frac{F-1}{F-a_2}$	a_3G	$a_4^{-1}G$	G	F/a_2

Foldings of Painlevé equations. A folding transformation [TOS05] is an algebraic map between solutions of Painlevé equations which goes through the quotient of the space of initial conditions. In other words, there is a certain \vec{a} , subgroup $H \in \text{Aut}(\mathcal{X}_{\vec{a}})$ and birational map between the quotient $\mathcal{X}_{\vec{a}}/H$ and space of initial conditions of another Painlevé equation $\mathcal{Y}_{\vec{a}}$. Such H should then be a subgroup of W^{ae} commuting with certain Painlevé dynamics, we call it folding subgroup.

Example 1.2 (Continuation of Example 1.1). Consider an element $w = s_0 s_1 s_4 s_5$ of order 2. It acts as

$$w: a_{0,1,4,5} \mapsto a_{0,1,4,5}^{-1}, \quad a_2 \mapsto a_2 a_0 a_1, \quad a_3 \mapsto a_3 a_4 a_5, \quad F \mapsto a_1 F, \quad G \mapsto a_4^{-1} G. \quad (1.4)$$

It is easy to see that w commutes with the q -Painlevé dynamics (1.2).

If $a_0 = a_1 = a_4 = a_5 = -1$, then w preserves the multiplicative root variables. Equations (1.2) become

$$F \underline{F} = -\frac{G^2 - q^{-1} a_2^2}{G^2 - 1}, \quad G \overline{G} = -\frac{F^2 - a_2^2}{F^2 - 1}, \quad (1.5)$$

where we used that $q = a_2^2 a_3^2$ in this case. Two equations in (1.5) now look almost the same and this leads to the possibility of creating a half-step (or “extracting a root”) of this dynamics. We denote this square root by dashed over-(under-) line and define it by

$$\ddot{a}_2 = q^{1/2} a_2 = a_2^2 a_3, \quad \ddot{G} = F, \quad \ddot{F} = \overline{G}. \quad (1.6)$$

Then equations (1.5) can be rewritten as

$$\ddot{F} \underline{F} = -\frac{F^2 - a_2^2}{F^2 - 1}, \quad \ddot{G} = F. \quad (1.7)$$

Let us introduce coordinates $F = F^2$, $G = FG$, which are invariant under w and give a map of degree 2 from $\mathcal{X}_{\vec{a}}$. Then from (1.7) we have

$$\ddot{G} G = -\frac{F(F - a_2^2)}{F - 1}, \quad F \underline{F} = G^2, \quad (1.8)$$

which is a q -Painlevé equation with symmetry/surface type $A_1^{(1)}/A_7^{(1)'}$ (or parameterless q -Painlevé III) with $\mathbf{a}_1 = a_2^2, \mathbf{a}_0 = a_3^2$.

Motivation. Folding transformations lead to algebraic relations between solutions of Painlevé equations. For example, one has a relation between special solutions. The points fixed under the action of H on the surface $\mathcal{X}_{\vec{a}}$ correspond to certain algebraic solutions of the Painlevé equations. On the other hand, in the quotient space $\mathcal{X}_{\vec{a}}/H$ these fixed points become singularities which, after the resolution, give exceptional divisors. Such divisors correspond to Riccati solutions, so the folding transformation relates the equation having an algebraic solution to that having Riccati solution. This was the original observation in [TOS05].

On the other hand, there was huge progress in the last 10 years in the Painlevé theory in relation to the formulas for generic solutions. Namely, it was proposed in [GIL12], [GIL13] that Painlevé equations can be solved in terms of certain special functions that appeared in mathematical physics. These functions themselves have two definitions: conformal blocks in 2d conformal field theory [BPZ84] and partition functions in 4d $\mathcal{N} = 2$ supersymmetric gauge theory [Nek03]. The equivalence between these two definitions is famous AGT correspondence [AGT10]. Later the formulas for generic solutions were extended to the case of q -difference Painlevé equations for $E_r^{(1)}$, $r \leq 4$ symmetry [BS17], [JNS17], [BGT19], [MN19].

Therefore, folding transformations lead to nontrivial algebraic relations between partition functions. And the folding transformation discussed in Example 1.2 indeed has such meaning. The corresponding relation is (roughly speaking) a combination of the identity found in the conformal field theory [Pog09],[FLNO09],[HJS10] and bilinear relations from the gauge theory [NY05a],[NY05b]. This was (again, roughly speaking) observed in [BS19], [Shc20], and our original motivation was to find more folding transformations in order to find new relations for partition functions. For the $E_6^{(1)}, E_7^{(1)}, E_8^{(1)}$ we do not have formulas for generic solutions, so the folding transformation gives particular family of solutions.

The classification of folding transformations is a problem also interesting in itself. From the first glance, the task seems to be wild, there are many vectors \vec{a} for which the stabilizer $W_{\vec{a}}^{ae}$ is nontrivial, this stabilizer could act on the surface of initial conditions $\mathcal{X}_{\vec{a}}$. But there is a huge restriction — namely, for given \vec{a} the subgroup of stabilizer $(W_{\vec{a}}^{ae})_{\vec{a}}$ generated by reflections acts trivially on the surface $\mathcal{X}_{\vec{a}}$ (with some exceptions for small Φ_{sym}^a , namely for the cases $E_1^{(1)}, E_2^{(1)}, E_3^{(1)}$). It was shown in [TOS05], using this observation, that all folding transformations of *differential* Painlevé equations come from the subgroups of

external automorphisms $\widehat{\Omega} \subset W^{ae}$. More geometrically, $\widehat{\Omega}$ is a subgroup of W^{ae} preserving fundamental alcove. It is well known that $\widehat{\Omega} \simeq P/Q$, where P and Q are weight and root lattices for the finite root system Φ_{sym} .

Recall that differential Painlevé equations correspond to the additive cases in Sakai's classification [Sak01], contrary to q -difference equations, which correspond to the multiplicative cases. In a multiplicative case situation becomes richer, it appears that nontrivial folding transformations could come from the product of reflections from W^a , and even from the finite Weyl group W . This is similar to the known fact in the theory of Lie groups that the centralizer of a semisimple element of the adjoint group can be non-connected, contrary to simply connected case, or Lie algebra case (see e.g. [Hum95]). And the group of connected components can be identified with a subgroup of the group Ω , where Ω is the subgroup of W which maps fundamental alcove to a parallel one. It is easy to see that the groups Ω and $\widehat{\Omega}$ are isomorphic.

Remarkably, it appears that any folding subgroup H can be embedded as

$$H \subset \widehat{\Omega} \times \prod_j \Omega_{\Phi_j}, \quad (1.9)$$

where a reducible root system $\sqcup_j \Phi_j$ corresponds to a subdiagram $I \subset \Delta^a$ in the affine Dynkin diagram of Φ^a . Only special subdiagrams and special subgroups of (1.9) give (essentially different) foldings. We proceed now to the more precise statement.

Main result. It follows from formula (1.9) that any folding subgroup H is solvable. So it is convenient to classify first the cyclic folding subgroups and then to construct general folding subgroups from the cyclic ones.

Clearly it is sufficient to classify folding subgroups in $H \subset W^{ae}$ up to conjugacy. Moreover, since the map from $W^{ae} \rightarrow \text{Aut} \mathcal{X}_{\bar{a}}$ can have a kernel, it is sufficient to classify the images of H in $\text{Aut} \mathcal{X}_{\bar{a}}$.

Theorem 1. *a) There are 24 nonequivalent cyclic folding subgroups. They are given in Table 1.*

b) There are also 9 nonequivalent non-cyclic folding subgroups. They are given in Table 2.

Let us explain the notation used in the tables. For each folding subgroup, we draw nodes of the corresponding subset in black. We label folding transformation via types of the root system generated by simple roots corresponding to I . If H contains (at least as a factor) an external automorphism $\pi \in \widehat{\Omega}$, we also write its action on the diagram and add $\pi \times$ in the notation of the folding transformation. In particular, if the folding subgroup is a subgroup of $\widehat{\Omega}$, then we draw all vertices in white and denote the corresponding folding transformation by π .

For each folding subgroup, we draw an arrow whose source is the symmetry of the initial Painlevé equation and whose target is the Painlevé equation after the folding. We write the degree of the transformation above the arrow.

In Table 2 we also write the isomorphism class of the group H . Note that contrary to differential foldings, in this case the group H can be non-commutative.

Example 1.3. The folding transformation used in the Example 1.2 in this notation corresponds to the subdiagram $4A_1 \subset D_5^{(1)}$. The corresponding folding subgroup is generated by $w = s_0 s_1 s_4 s_5 \in \Omega_{A_1}^4$.

Remark 1.1. The diagrams represented in Table 1 are specified by the element $\pi \in \widehat{\Omega}$ and the coloring which satisfies the following combinatorial properties. Let I denote subgraph of Δ^a with black vertices, $\{\Delta_j\}$ be the set of connected components of I , and n_j be a number of vertices in Δ_j . Then:

- Each Δ_j is a Dynkin diagram of type A . Coloring is invariant with respect to π , if some Δ_j is π -invariant as a set, then π acts trivially on it.
- Number of π orbits on the set of vertices $\Delta^a \setminus I$ is at least 2.
- In each π -orbit choose one component Δ_j , called distinguished. Number the vertices of each distinguished component successively from 1 to n_j . Then there is a choice of integer numbers m_j , $0 < m_j \leq n_j$, $\text{gcd}(m_j, n_j + 1) = 1$, for each distinguished component such that, for any white vertex c ,

$$\sum_{b \in I_D \cap N(c)} \frac{i_b m_{j(b)}}{n_{j(b)} + 1} \in \mathbb{Z}, \quad (1.10)$$

$E_8^{(1)}$	$3A_2 : E_8^{(1)} \xrightarrow{3} E_6^{(1)}$ 	$4A_1 : E_8^{(1)} \xrightarrow{2} E_7^{(1)}$ 	$A_1 + 2A_3 : E_8^{(1)} \xrightarrow{4} D_5^{(1)}$
$E_7^{(1)}$	$\pi : E_7^{(1)} \xrightarrow{2} E_8^{(1)}$ 	$3A_1 : E_7^{(1)} \xrightarrow{2} E_8^{(1)}$ 	$4A_1 : E_7^{(1)} \xrightarrow{2} D_5^{(1)}$
$E_6^{(1)}$	$3A_2 : E_7^{(1)} \xrightarrow{3} E_3^{(1)}$ 	$2A_3 : E_7^{(1)} \xrightarrow{4} E_7^{(1)}$ 	$\pi \times 5A_1 : E_7^{(1)} \xrightarrow{4} E_7^{(1)}$
$E_6^{(1)}$	$\pi : E_6^{(1)} \xrightarrow{3} E_8^{(1)}$ 	$2A_2 : E_6^{(1)} \xrightarrow{3} E_8^{(1)}$ 	$4A_1 : E_6^{(1)} \xrightarrow{2} E_3^{(1)}$
$D_5^{(1)}$	$\pi^2 : D_5^{(1)} \xrightarrow{2} E_7^{(1)}$ 	$2A_1 : D_5^{(1)} \xrightarrow{2} E_7^{(1)}$ 	$\pi : D_5^{(1)} \xrightarrow{4} E_8^{(1)}$
$D_5^{(1)}$	$A_1 + A_3 : D_5^{(1)} \xrightarrow{4} E_8^{(1)}$ 	$\pi^2 \times 3A_1 : D_5^{(1)} \xrightarrow{4} E_8^{(1)}$ 	$4A_1 : D_5^{(1)} \xrightarrow{2} A_1^{(1)}$
$E_3^{(1)}$	$\pi^3 : E_3^{(1)} \xrightarrow{2} E_6^{(1)}$ 	$A_1 : E_3^{(1)} \xrightarrow{2} E_6^{(1)}$ 	$\pi^2 : E_3^{(1)} \xrightarrow{3} E_7^{(1)}$
$A_1^{(1)}$	$A_2 : E_3^{(1)} \xrightarrow{3} E_7^{(1)}$ 	$\pi^2 : A_1^{(1)} \xrightarrow{2} D_5^{(1)}$ 	$\sigma : A_1^{(1)} \xrightarrow{2} D_5^{(1)}$

Table 1: Cyclic folding subgroups

$E_7^{(1)}$	$C_2 \times C_4$ $E_7^{(1)} \rightarrow E_8^{(1)}$		$C_2 \times C_4$ $E_7^{(1)} \rightarrow E_8^{(1)}$	
	$C_2 \times C_2$ $E_7^{(1)} \rightarrow E_7^{(1)}$		$C_2 \times 4A_1$ $E_7^{(1)} \rightarrow E_7^{(1)}$	
$D_5^{(1)}$	$C_2 \times C_2 \times C_2$ $D_5^{(1)} \rightarrow E_7^{(1)}$		$C_2 \times C_2$ $D_5^{(1)} \rightarrow D_5^{(1)}$	
	$C_2 \times C_2$ $D_5^{(1)} \rightarrow D_5^{(1)}$		$C_2 \times C_2$ $D_5^{(1)} \rightarrow E_8^{(1)}$	
$A_1^{(1)}$	$C_2 \times C_2$ $A_1^{(1)} \rightarrow E_7^{(1)}$		π^2, σ	

Table 2: Non-cyclic folding subgroups

where the sum runs over the set of black vertices belonging to the set of distinguished components I_D and adjacent to c , $j(b)$ is such that $b \in \Delta_{j(b)}$, and i_b is the number of b in the component $\Delta_{j(b)}$.

In the main text we present more details about folding transformations given in tables 1,2. In particular, we present the corresponding subgroups $H \subset W^{ae}$, give explicit formulas for the coordinate transformation $F = F(F, G)$, $G = G(F, G)$, and compute the automorphism group of the image.

Content of the paper. The main text of the paper consists of two parts: the first one is devoted to the algebra and combinatorics of the affine Weyl group (Secs. 2, 4) and the second one is devoted to the geometry of rational surfaces (Secs. 3, 5). In each of the two parts, we first explain the results and give some examples, and then we give some tables with the explicit data.

Section 2 is devoted to the classification. Theorem 2 reduces the problem to the subgroups of 1.9. In Section 2.4 we obtain selection rules as in Remark 1.1, and in Section 2.5 we give the results.

In Section 2.6 we discuss the normalizer subgroup $N = N(H, W^{ae}) \subset W^{ae}$ of H . The group N is important since it acts after the folding. In particular, it should include the Painlevé dynamics. Here we restrict ourselves to the case of cyclic H and denote its generator by w . Roughly speaking the answer is the following. Let $Q_{\text{fold sym}}^a$ be the sublattice in Q_{sym}^a invariant under w . Then it appears that $Q_{\text{fold sym}}^a$ is the lattice for the affine root system $\Phi_{\text{fold sym}}^a$ and the group N on the image is a finite extension of the affine Weyl group $W_{\text{fold sym}}^a$. Details on the computation of N in each case are given in Sec. 4.

As we saw in Example 1.2, for special values of the parameters it may be possible to extract a root of the dynamics. This phenomenon is called a projective reduction of the Painlevé equation [KNT11], [KN13]. Projective reductions quite often appear in examples of folding transformations, we also discuss this Sec. 2.6.

In the geometrical part, we find the type of a Painlevé equation after the folding¹ and compute explicit formulas for the coordinates $F = F(F, G)$, $G = G(F, G)$. To do this we have to take the quotient $\mathcal{X}_{\bar{a}}/H$, resolve its singularities, and then (probably after some blowdown) identify the result with the space $\mathcal{Y}_{\bar{a}}$ of initial conditions of the resulting Painlevé equation. This scheme is described in Sec. 3 and details for

¹It is natural to believe that resulting dynamics should also be of a discrete Painlevé type. Indeed by Castelnuovo theorem (see e.g. [Bea96, Cor. V.5]) the quotient $\mathcal{X}_{\bar{a}}/H$ is rational surface. Moreover, the standard Painlevé detectors [GR04]: singularity confinement and algebraic entropy and are also preserved after the folding.

each example are given in Sec. 5. For the convenience of the reader, note that tables with the main results are given in Sec. 3.4. In Sec. 3.3 (again, with details in Sec. 5) we compute the symmetry group from the geometry of $\mathcal{Y}_{\vec{a}}$ and observe that it is in complete agreement with the computation of N mentioned above.

Finally, in Section 6 we shortly discuss two questions that are natural after completion of the classification. The first question is the continuous limit. Unfortunately, we do not have a complete answer, so we will limit ourselves to one example. The second question is a comparison of our classification with previously known examples. There are 4 folding transformations of q -difference equations in [RGT00] (see also [RNGT09]), we found them in our classification. The fifth example appeared in [BS19].

Notation. Here we list some notation and abbreviations which we used through the main text. Of course this not the full list, but rather a list necessary to avoid confusion.

- C_n : the cyclic group of order n ,
- ζ_n : some primitive root of 1 of order n ,
- $i = \sqrt{-1}$, $\zeta = \zeta_3$,
- $s_{i_1 \dots i_k} = s_{i_1} \cdot \dots \cdot s_{i_k}$, where $s_{i_1} \dots s_{i_k}$ are simple reflections.
- t_λ are translations in affine Weyl group, corresponding to weight $\lambda \in P$.
- $\alpha_{i_1 \dots i_k} = \alpha_{i_1} + \dots + \alpha_{i_k}$, where α_{i_j} are simple roots.
- $\omega_i, \omega_{\alpha_i}$: fundamental weight, corresponding to the simple root α_i .
- F, G, a_i, q, E_i : coordinates, root variables, imaginary root variable, exceptional divisors on the surface from which folding transformation acts.
- $F, G, \mathfrak{a}_i, \mathfrak{q}, \mathcal{E}_i$: coordinates, root variables, imaginary root variable, exceptional divisors on the surface obtained after folding transformation.
- $E_{i_1 \dots i_k} = E_{i_1} + \dots + E_{i_k}$, $H_{FG} = H_F + H_G$.

Acknowledgements. We are grateful to Oleg Lisovyy who drew our attention to folding transformations, Konstantin Shramov for explanations on the intersection theory and Pavlo Gavrylenko for many very useful discussions.

We are especially grateful to Anton Dzhamay, who participated in the early stage of this project. Our understanding of Sakai's approach is due to him, he also suggested that nodal curves and projective reduction play an important role in the study of folding transformations.

M.B. was partially supported by the HSE University Basic Research Program.

2 Classification of folding transformations

2.1 Main problems

Sakai's geometric approach. Celebrated Sakai's classification [Sak01] relates q -Painlevé equations to the families of rational surfaces \mathcal{X} . These surfaces are blowups of $\mathbb{P}^1 \times \mathbb{P}^1$ in 8 points (or, equivalently, \mathbb{P}^2 in 9 points). We will usually denote coordinates on $\mathbb{P}^1 \times \mathbb{P}^1$ by F and G .

Each family is parametrized by a collection of root variables $\vec{a} = (a_0, \dots, a_r) \in \mathcal{A} \subset (\mathbb{C}^*)^{r+1}$ ², which correspond to the set $\{\alpha_0, \dots, \alpha_r\} = \Delta^a$ of simple roots of certain affine root system Φ^a . The positions of 8 blowup points are given in terms of \vec{a} . Symmetries of the family \mathcal{X} are given by affine extended Weyl group W^{ae} of root system Φ^a , thus type of this system is called symmetry type³. All these Φ^a are of E -type: $\Phi^a = E_r^{(1)}$, $r = 1 \dots 8$, see Fig. 1 above.

Group W^{ae} is a semidirect product $\widehat{\Omega} \ltimes W^a$ of affine Coxeter group W^a and group of external automorphisms $\widehat{\Omega}$. Hence W^{ae} is generated by simple reflections s_i , $i = 0, \dots, r$ and permutations of simple roots π . Action of w on root variables is multiplicative, namely

$$s_i(a_j) = a_j a_i^{-C_{ij}}, \quad s_i \in W^a, \quad \pi(a_i) = a_{\pi(i)}, \quad \pi \in \widehat{\Omega}, \quad (2.1)$$

where C_{ij} is Cartan matrix of Φ^a .

Group W^{ae} acts between different members of the family \mathcal{X} , nontrivially acting on $\mathcal{X}_{\vec{a}}$

$$W^{ae} \ni w : \mathcal{X}_{\vec{a}} \rightarrow \mathcal{X}_{w(\vec{a})}, \quad (F, G) \in \mathcal{X}_{\vec{a}} \mapsto (w(F), w(G)) \in \mathcal{X}_{w(\vec{a})}. \quad (2.2)$$

Explicit formulas for the action are given in Section 5. More details about Sakai's approach can be found in review [KNY17], we usually follow *loc. cit.* in notations and conventions.

Folding: definition. We see that generally, the symmetry changes \vec{a} . However, under restrictions on parameters \vec{a} symmetry can act as an automorphism of corresponding $\mathcal{X}_{\vec{a}}$ and such automorphism can be nontrivial. This phenomenon is what we call folding

Definition 2.1. *Folding transformation* of surface is an element $w \in W^{ae}$ and family $\mathcal{A}_w \subset \mathcal{A}$ of root variable tuples such that for any (generic) $\vec{a} \in \mathcal{A}_w$ we have

$$w(\vec{a}) = (\vec{a}), \quad w((F, G)) \neq (F, G). \quad (2.3)$$

Folding subgroup is a subgroup $H \subset W^{ae}$ and family \mathcal{A}_H of root variable tuples such that for any (generic) $\vec{a} \in \mathcal{A}_H$ we have an embedding $H \rightarrow \text{Aut}(\mathcal{X}_{\vec{a}})$.

Without loss of generality, we can take \mathcal{A}_w (\mathcal{A}_H) to be an irreducible component of the invariant subset \mathcal{A}^w (\mathcal{A}^H). We will see below that for given w there is often only one component \mathcal{A}_w which gives nontrivial folding transformation. If there are several such components, then they give folding transformations, equivalent under a certain symmetry. Hence we will label folding transformations by group element $w \in W^{ae}$.

Informally we can say that the folding subgroup is a subgroup in which any nontrivial element is folding transformation. Individual folding transformations correspond to the cyclic folding subgroups H . As already mentioned in the Introduction we concentrate first on these cyclic groups and then construct all folding subgroups from cyclic ones.

For the folding subgroup, we can take the quotient $\mathcal{X}_{\vec{a}}/H$. The normalizer subgroup N of H in W^{ae} acts on the family \mathcal{A}_H . Therefore it is natural to ask for the birational model Y of the quotient $\mathcal{X}_{\vec{a}}/H$ and map from N to the corresponding affine Weyl group. If \mathcal{X} corresponds to root system Φ^a and \mathcal{Y} corresponds to root system Φ'^a we say that we get folding transformation from symmetry type Φ^a to symmetry type Φ'^a .

The first key point in the classification of folding transformations is the following lemma and corollary.

Lemma 2.1. *For $a_i = 1$ we have $s_i(F, G) = (F, G)$.*

²For $E_2^{(1)}$ there is dependence on square roots of these variables.

³For the symmetry/surface type $E_1^{(1)}/A_7^{(1)}$ the symmetry group is slightly bigger and for $E_2^{(1)}/A_6^{(1)}$ — smaller, these cases will require more care below.

Proof. One can just check the statement of the lemma case-by-case, using formulas for action of simple reflections from Section 5 or [KNY17] \square

Remark 2.1. According to formulas from Section 5 the simple reflections s_0 for $E_7^{(1)}/A_1^{(1)}$ and s_1 for $E_8^{(1)}/A_0^{(1)}$ naively violate the statement of the lemma. However, this is not the case, because value 1 for root variables a_0 for $E_7^{(1)}/A_1^{(1)}$ and a_1 for $E_8^{(1)}/A_0^{(1)}$ is excluded from the family \mathcal{X} , since it leads to another geometry, see defining equations (5.11) for $E_7^{(1)}/A_1^{(1)}$ case and (5.1) for $E_8^{(1)}/A_0^{(1)}$ case.

There is also a geometric proof of the Lemma 2.1, see Section 3.1.

Corollary 2.2. *Let root α belong to component of Φ^a different from $A_1^{(1)}$, let s_α be the corresponding reflection. If $s_\alpha(\vec{a}) = \vec{a}$ then $s_\alpha((F, G)) = (F, G)$.*

In other words the condition of the lemma holds if Φ^a is different from $E_1^{(1)}$, $E_2^{(1)}$ and $E_3^{(1)}$.

Proof of the Corollary. Since any roots is conjugated to simple one it is sufficient to consider case $\alpha = \alpha_i$. It follows from the assumptions of the corollary that there exists simple root α_j such that $C_{ij} = -1$. Hence $s_i(a_j) = a_j$ implies $a_i = 1$ and it remains to use Lemma 2.1. \square

Folding on equations. q -Painlevé equations correspond to translations in affine Weyl group. Recall that affine Weyl groups have a structure of semidirect product

$$W^a = Q \rtimes W, \quad W^{ae} = P \rtimes W. \quad (2.4)$$

Here W is (finite) Weyl group corresponding to (finite) root system Φ , Q is a root lattice of Φ and P is a weight lattice of Φ . We denote by $\bar{w} \in W$ the finite part of $w \in W^{a(e)}$. We denote fundamental weight corresponding to simple root α_i by ω_i .

For any $\lambda \in P$ let t_λ be the corresponding element of W^{ae} . Its action on root variables is given by $t_\lambda a_i = q^{(\lambda, \alpha_i)} a_i$. Here q corresponds to imaginary root $\delta \in \Phi^a$, namely

$$\delta = \sum_{i=0}^r \mathbf{m}_i \alpha_i, \quad q = \prod_{i=0}^r a_i^{\mathbf{m}_i}. \quad (2.5)$$

Coefficients \mathbf{m}_i of δ decomposition into sum of simple roots α_i we call marks of α_i .

The action of translation t_λ on coordinates F, G is very nontrivial. The q -Painlevé equation is an equation on the section of the bundle $\mathcal{X} \rightarrow \mathcal{A}$ equivariant under the action of t_λ . Namely, q -Painlevé equations are equations of the form

$$t_\lambda(F(\vec{a}), G(\vec{a})) = (F(t_\lambda(\vec{a})), G(t_\lambda(\vec{a}))) \quad (2.6)$$

on functions $(F(\vec{a}), G(\vec{a}))$ (which actually take values in surface $\mathcal{X}_{\vec{a}}$). In a sense, the Painlevé equation is defined by the family of surfaces and chosen translation t_λ .

Remark 2.2. There is a slight extension of this construction. Namely, for certain values of root variables \vec{a} , there is certain $w \in W^{ae}$, $w^k \in P$ which act as a translation by $q^{1/k}$ for certain $k \in \mathbb{Z}_{>0}$. Such phenomenon is called projective reduction, see e.g. [KNT11], [KN13]. Projective reductions quite often appear in the study of the folding transformations, see end of Sec. 2.6 below.

In order to have *folding transformation (or folding subgroup) of q -difference Painlevé equation* we need translation t_λ which will act on the quotient $\mathcal{X}_{\vec{a}}/H$. Hence t_λ belongs to the normalizer subgroup N . We will call folding transformation (w, \mathcal{A}_w) *true folding* if there is translation in N and the family \mathcal{A}_w contains points with arbitrary q . Similarly we define *true folding subgroup*.

The true folding condition requires that family \mathcal{A}_w (correspondingly \mathcal{A}_H) is at least two dimensional since one parameter is q , and another parameter is shifted by translation. The normalizer subgroup N could contain several linear independent translations, for this case one folding transformation (or folding subgroup) gives transformation for several q -Painlevé equations.

Below we give a list of all up to conjugations in W^{ae} possible cyclic true folding subgroups. To be more precise we classify the images of the folding subgroups in the automorphism group of $\mathcal{X}_{\vec{a}}$, this is important

since as we saw in Lemma 2.1 the map from W^{ae} to automorphism group can have a kernel. Our approach is based on the combinatorics of the affine Weyl group, the only geometric input is Lemma 2.1. Then, in Section 5 we will see that all transformations from the list found by such approach give non-equivalent true folding transformations.

2.2 Stabilizer

Additive case. Let Φ be a finite simply laced irreducible root system, $\Delta = \{\alpha_1, \dots, \alpha_r\}$ set of its simple roots, W_Φ be the corresponding Weyl group. Let V_Φ be a real vector space with coordinates x_1, \dots, x_l with action of group W_Φ by the formula $s_i(x_j) = x_j - C_{ij}x_j$. In more invariant terms V_Φ is a space dual to the real vector space generated by $\alpha_1, \dots, \alpha_r$.

There is a standard action of the extended affine Weyl group W_Φ^{ae} on V_Φ , namely for $\lambda \in P$ translations t_λ act as $x_i \mapsto x_i + (\lambda, \alpha_i)$. Subgroup $W_\Phi^a \subset W_\Phi^{ae}$ is generated by reflections. The reflection hyperplane for s_0 is given by the equation $\sum_{i=1}^r \mathbf{m}_i x_i = 1$, where marks \mathbf{m}_i are defined by the expansion of the highest root $\theta = \sum_{i=1}^r \mathbf{m}_i \alpha_i$.

Remark 2.3. In the standard convention $\alpha_1, \dots, \alpha_r$ are roots of finite root system and $\alpha_0 = -\theta + \delta$ is additional ‘‘affine’’ root. Here as usual δ is an imaginary root and θ is highest root. Hence $\sum_{i=0}^r \mathbf{m}_i \alpha_i = \delta$, where $\mathbf{m}_0 = 1$ in agreement with formula (2.5).

In the paper, we follow conventions of [KNY17] in the numbering of simple roots in Φ^a . This convention in two cases disagrees with one above, namely for $E_7^{(1)}$ affine root is α_7 and for $E_8^{(1)}$ affine root is α_8 . All statements in this section will be given in the invariant form, so this discrepancy will not lead to confusion.

The (closed) *fundamental alcove* $\text{Alc} \subset V_\Phi$ is the set bounded by the hyperplanes of simple reflections in W^a . In coordinates Alc is defined by the equations $x_i \geq 0$, $1 \leq i \leq r$ and $\sum_{i=1}^r \mathbf{m}_i x_i \leq 1$. Below we will identify facets of the fundamental alcove with the set Δ^a of simple roots of the affine root system. The fundamental alcove is the fundamental domain for the action of W^a on V_Φ , see e.g. [Hum90, Th. 4.8]. Let $\widehat{\Omega} \subset W^{ae}$ denotes subgroup which preserves Alc . Clearly we have decomposition $W^{ae} \simeq \widehat{\Omega} \times W^a$. Hence $\widehat{\Omega} \simeq P/Q$. Elements of the group $\widehat{\Omega}$ permutes facets of Alc , i.e. perform permutation of the set of $\alpha_0, \dots, \alpha_r$, this permutation is automorphism of affine Dynkin diagram.

The following lemma is standard.

Lemma 2.3. *Let $\vec{x} \in \text{Alc}$, $I \subset \Delta^a$ denotes the set of facets containing \vec{x} and W_I° denotes subgroup of W^a generated by s_i , $i \in I$. Then the stabilizer of \vec{x} in W^{ae} has the form $W_{\vec{x}}^{ae} = \widehat{\Omega}_{\vec{x}} \times W_I^\circ$, where $\widehat{\Omega}_{\vec{x}}$ is stabilizer of \vec{x} in $\widehat{\Omega}$.*

Proof. It follows from [Hum90, proof of Th. 4.8] that stabilizer of \vec{x} in W^a is W_I° . If $\pi w(\vec{x}) = \vec{x}$ for $\pi \in \widehat{\Omega}$, $w \in W^a$ then $w(\vec{x}) \in \text{Alc}$ hence $w(\vec{x}) = \vec{x}$ (see [Hum90, proof of Th. 4.8]). \square

We will need an analog of this statement for the reducible root system $\Phi = \sqcup_{j=1}^l \Phi_j$. Here and below in such occasions we assume roots systems Φ_j are irreducible, and use notations like $\Delta_j^a, W_j^{ae}, \text{Alc}_j$ for the corresponding set of affine simple roots, affine Weyl group, and fundamental alcove. Let Aut_Φ be a group of external automorphisms of Φ . Any element $\sigma \in \text{Aut}_\Phi$ acts on simple roots Δ_j as permutation or moves them to roots Δ'_j of isomorphic component. The fundamental alcove Alc_Φ is a product $\prod \text{Alc}_j$, the set of facets of Alc_Φ is a union $\sqcup \Delta_j^a$. We can extend finite and affine Weyl groups of Φ by Aut_Φ

$$\widetilde{W}_\Phi = \text{Aut}_\Phi \times \prod_{j=1}^l W_j, \quad \widetilde{W}_\Phi^{ae} = \text{Aut}_\Phi \times \prod_{j=1}^l W_j^{ae}. \quad (2.7)$$

Lemma 2.4. *Let $\vec{x} \in \text{Alc}_\Phi$, and I, W_I° are as in Lemma 2.3. Then the stabilizer of \vec{x} in \widetilde{W}_Φ^{ae} has the form $\widetilde{W}_{\vec{x}}^{ae} = (\text{Aut}_\Phi \times \prod \widehat{\Omega}_j)_{\vec{x}} \times W_I^\circ$.*

The proof of this lemma is the same as proof of Lemma 2.3, with replacement of $\widehat{\Omega}$ to $\text{Aut}_\Phi \times \prod \widehat{\Omega}_j$.

Let $\Omega \in W$ denotes subgroup which maps fundamental alcove Alc into parallel one. It is easy to see that any element $\pi \in \widehat{\Omega}$ has unique decomposition $\pi = t_{-\omega_\pi} \bar{\pi}$, where $\bar{\pi} \in \Omega$. Hence the groups $\widehat{\Omega}$ and Ω are isomorphic. For reducible system $\Phi = \sqcup_{j=1}^l \Phi_j$ we denote $\widetilde{\Omega}_\Phi = \text{Aut}_\Phi \times \prod \Omega_j$, this is subgroup of \widetilde{W}_Φ which maps alcove Alc into parallel one.

Corollary 2.5. *Let $\Phi = \sqcup_{j=1}^l \Phi_j$ and $\vec{x} \in \text{Alc}$, then the group $\{w \in \widetilde{W}_\Phi | w\vec{x} - \vec{x} \in P\}$ has the form $\widetilde{\Omega}_{(\vec{x})} \times W_I^\circ$ where I, W_I° are as in Lemma 2.3 and $\widetilde{\Omega}_{(\vec{x})}$ is the subgroup of $\widetilde{\Omega}$.*

Proof. The condition $w\vec{x} - \vec{x} \in P$ is equivalent to existence of $\lambda \in P$ such that $t_\lambda w$ belong to the stabilizer of \vec{x} in \widetilde{W}^{ae} . Hence the statement follows from Lemma 2.4. \square

The logic here is similar to [Hum95, Sec. 2.10]. Note that $\widetilde{\Omega}_{(\vec{x})}$ is not stabilizer of \vec{x} in $\widetilde{\Omega}$ but rather finite part of stabilizer in $\text{Aut}_\Phi \times \prod_{j=1}^l \widehat{\Omega}_j$.

Multiplicative case. Recall now that our parameters $\vec{a} = (a_0, \dots, a_r)$ are multiplicative root variables. For any root $\alpha = \sum_{i=0}^r k_i \alpha_i$ we assign root variable $\prod_{i=0}^r a_i^{k_i}$.

Theorem 2. *Let $|q| \neq 1$, $\vec{a} \in \mathcal{A}$. Then there exist $I \subset \Delta^a$ and $g \in W^{ae}$ such that for stabilizer of $\vec{a}'' = g(\vec{a})$ we have*

$$W_{\vec{a}''}^{ae} = \Omega_{[\vec{a}]} \times \prod_{j=1}^l W_j^\circ. \quad (2.8)$$

Here Φ_j , $j = 1, \dots, l$ are finite root systems corresponding to connected components of the subgraph whose vertex set is I in the graph of affine Dynkin diagram Φ^a , W_j° is group generated by reflections by roots of Φ_j such that corresponding multiplicative root variables equal to 1. The $\Omega_{[\vec{a}]}$ is a certain subgroup in $\widehat{\Omega}_I \times \prod_{j=1}^l \Omega_{\Phi_j}$, where $\widehat{\Omega}_I$ is a subgroup of $\widehat{\Omega}$ preserving I .

Through the paper, we assume that q is generic so the condition $|q| \neq 1$ holds. It is easy to see that if Theorem 2 holds for generic q then it holds for any q which is not a root of unity.

Proof. There is a map from $\mathcal{A} \rightarrow V_\Phi$ given by the formula $x_i = (\text{Re log } a_i) / (\text{Re log } q)$, $i = 1, \dots, r$. This map is equivariant with respect to the action of W^{ae} . Indeed, it is easy to check for reflections in W and for translation in P .

Now fix $\vec{a} \in \mathcal{A}$, let $\vec{x} \in V_\Phi$ denotes its image. Due to equivariance we have inclusion of stabilizers $W_{\vec{a}''}^{ae} \subset W_{\vec{x}}^{ae}$. There is $g' \in W^a$ such that $\vec{x}' = g'(\vec{x}) \in \text{Alc}$, let $\vec{a}'' = g'(\vec{a})$. As in Lemma 2.3 we introduce I and we have

$$W_{\vec{x}'}^{ae} = \widehat{\Omega}_{\vec{x}'} \times W_I^\circ = \widehat{\Omega}_{\vec{x}'} \times \prod_{j=1}^l W_{\Phi_j}. \quad (2.9)$$

Since I cannot coincide with Δ^a the root systems Φ_j are of finite type. Clearly $\widehat{\Omega}_{\vec{x}'} \subset \widehat{\Omega}_I$.

It follows from definition of I that $|a_i'| = 1$ iff $\alpha_i \in I$. Denote $a_i' = \exp(2\pi i y_i)$ for real y_i . One can consider collection y_i as an element of $V_{\sqcup \Phi_j} = \bigoplus_{j=1}^l V_{\Phi_j}$, note that \vec{y} is defined up to the integer shift $\vec{y} \mapsto \vec{y} + \lambda$ where $\lambda \in \bigoplus_{j=1}^l P_j$. Then there is $g'' \in \prod_{j=1}^l W_{\Phi_j}$ and $\lambda \in \bigoplus_{j=1}^l Q_j$ such that $\vec{y}'' = g''(\vec{y}) + \lambda$ belongs to the product of fundamental alcoves $\prod_j \text{Alc}_j$. If some $w \in W_{\vec{x}'}^{ae}$ preserves all a_i' for $\alpha_i \in I$, then $w(\vec{y}'') - \vec{y}'' \in P_{\sqcup \Phi_j}$.

The group $\widehat{\Omega}_{\vec{x}'}$ acts on $\sqcup \Phi_j$ as a subgroup of $\text{Aut}_{\sqcup \Phi_j}$. Hence by Corollary 2.5, the stabilizer of set of all a_i'' for $\alpha_i \in I$ has the form

$$\left(\widehat{\Omega}_{\vec{x}'} \times \prod_{j=1}^l \Omega_{\Phi_j} \right)_{(\vec{y}'')} \times W^\circ \quad (2.10)$$

where W° is generated by reflections through hyperplanes containing \vec{y}'' .

Condition that hyperplane contains \vec{y}'' is equivalent to the condition that corresponding multiplicative root variable is equal to 1. Hence the defined above group W° preserves the whole \vec{a}'' . Therefore we get the formula (2.8), where $\Omega_{[\vec{a}]}$ is stabilizer of \vec{a}'' in $\left(\widehat{\Omega}_{\vec{x}'} \times \prod_{j=1}^l \Omega_{\Phi_j} \right)_{(\vec{y}'')}$. \square

Due to Lemma 2.1 subgroup W° acts trivially on $\mathcal{X}_{\vec{a}}$. Hence, the folding transformations (and folding subgroups) could come only from the group $\widehat{\Omega} \times \prod \Omega_{\Phi_j}$.⁴

⁴It is not true to say that any folding subgroup can be conjugated to the subgroup of $\widehat{\Omega} \times \prod \Omega_{\Phi_j}$. But this is true up to factors from W° , i.e. image of any folding subgroup to the automorphism group of $\mathcal{X}_{\vec{a}}$ can be conjugated to the image of subgroup in $\widehat{\Omega} \times \prod \Omega_{\Phi_j}$.

2.3 Reduction to type A

If one of the systems Φ_j is of A -type, say A_n then the group Ω is cyclic group of order $n+1$, $\Omega_{A_n} \simeq C_{n+1}$. The generator of this cyclic group is $\bar{\pi}_{n+1} = s_n s_{n-1} \dots s_2 s_1$, where we used standard consecutive numbering of the simple roots.

It appears that it is sufficient to consider the case that all root systems Φ_j are of type A .

Lemma 2.6. *For finite irreducible simply laced root system Φ the group $\Omega_\Phi \in W_\Phi$ can be conjugated into the subgroup of $\prod_{j=1}^l \Omega_{\Phi'_j}$, where Φ'_j are A -type roots systems corresponding to connected components Δ'_j in Dynkin diagram Δ .*

Proof. We will use the following numbering of roots in root diagrams of D_n, E_6, E_7

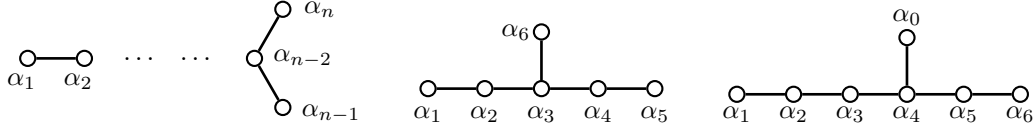

For $\Phi = E_8$ the group Ω is trivial and there is nothing to prove. For E_6 and E_7 we have the formulas

$$E_6 : \Omega = \{e, s_{123543263} s_{1245} s_{123543263}^{-1}, s_{123543263} s_{2154} s_{123543263}^{-1}\} \simeq C_3 \quad (2.11)$$

$$E_7 : \Omega = \{e, s_{123405645342} s_{031} s_{123405645342}^{-1}\} \simeq C_2 \quad (2.12)$$

For the D -type recall that Weyl group W_{D_n} is isomorphic to the group of linear transformations of the vector space with basis $\epsilon_1, \dots, \epsilon_n$ which permutes basis vectors and change signs of even number of them, simple roots are expressed in terms of such basis as $\alpha_i = \epsilon_i - \epsilon_{i+1}, i = 1 \dots n-1, \alpha_n = \epsilon_{n-1} + \epsilon_n$. Each element of W_{D_n} can be decomposed into product of cycles (i_1, \dots, i_k) , each of them is either positive or negative. Here cycle of length k is said to be positive if its k -th power is identity and negative if its k -th power is minus identity. See e.g. [Car72, Sec. 7] for details. Two elements $w_1, w_2 \in W_{D_n}$ are conjugated if they have the same cyclic type (including signs) except the case of all cycles are even and positive, in this case there are two conjugacy classes, see [Car72, Prop 25].

Let $n = 2k + 1$. The group $\Omega_{D_{2k+1}}$ is isomorphic to C_4 and generated by the element

$$w = \begin{pmatrix} \epsilon_1 & \epsilon_2 & \epsilon_3 & \dots & \epsilon_{k+1} & \dots & \epsilon_{2k} & \epsilon_{2k+1} \\ \epsilon_{2k+1} & -\epsilon_{2k} & -\epsilon_{2k-1} & \dots & -\epsilon_{k+1} & \dots & -\epsilon_2 & -\epsilon_1 \end{pmatrix}. \quad (2.13)$$

We have $w = g^{-1} w' g$, where

$$w' = \begin{pmatrix} \epsilon_1 & \epsilon_2 & \dots & \epsilon_{2k-3} & \epsilon_{2k-2} & \epsilon_{2k-1} & \epsilon_{2k} & \epsilon_{2k+1} \\ \epsilon_2 & \epsilon_1 & \dots & \epsilon_{2k-2} & \epsilon_{2k-3} & -\epsilon_{2k+1} & -\epsilon_{2k} & \epsilon_{2k-1} \end{pmatrix}, \quad (2.14)$$

$$g = \begin{pmatrix} \epsilon_1 & \epsilon_2 & \epsilon_3 & \dots & \epsilon_k & \epsilon_{k+1} & \epsilon_{k+2} & \dots & \epsilon_{2k-1} & \epsilon_{2k} & \epsilon_{2k+1} \\ \epsilon_{2k-1} & \epsilon_1 & \epsilon_3 & \dots & \epsilon_{2k-3} & (-1)^k \epsilon_{2k} & -\epsilon_{2k-2} & \dots & -\epsilon_4 & -\epsilon_2 & -\epsilon_{2k+1} \end{pmatrix} \quad (2.15)$$

Note that $w' = s_{13\dots 2k-3} s_{2k} s_{2k-1} s_{2k+1} \in \prod \Omega_{\Phi'_j}$ for the subset $I' = \{1, 3, \dots, 2k-3, 2k-1, 2k, 2k+1\}$. The corresponding root system is $(k-1)A_1 + A_3$.

Let $n = 2k$. The group $\Omega_{D_{2k}}$ is isomorphic to $C_2 \times C_2$ and has three nontrivial elements w_1, w_2^+, w_2^-

$$w_1 = \begin{pmatrix} \epsilon_1 & \epsilon_2 & \dots & \epsilon_{2k-1} & \epsilon_{2k} \\ -\epsilon_1 & \epsilon_2 & \dots & \epsilon_{2k-1} & -\epsilon_{2k} \end{pmatrix}, \quad w_2^\pm = \begin{pmatrix} \epsilon_1 & \epsilon_2 & \dots & \epsilon_{2k-1} & \epsilon_{2k} \\ \pm \epsilon_{2k} & -\epsilon_{2k-1} & \dots & -\epsilon_2 & \pm \epsilon_1 \end{pmatrix}. \quad (2.16)$$

Let us define g, w'_1, w'_2 by the formulas

$$w'_1 = \begin{pmatrix} \epsilon_1 & \dots & \epsilon_{2k-2} & \epsilon_{2k-1} & \epsilon_{2k} \\ \epsilon_1 & \dots & \epsilon_{2k-2} & -\epsilon_{2k-1} & -\epsilon_{2k} \end{pmatrix}, \quad w'_2 = \begin{pmatrix} \epsilon_1 & \epsilon_2 & \dots & \epsilon_{2k-3} & \epsilon_{2k-2} & \epsilon_{2k-1} & \epsilon_{2k} \\ \epsilon_2 & \epsilon_1 & \dots & \epsilon_{2k-2} & \epsilon_{2k-3} & \epsilon_{2k} & \epsilon_{2k-1} \end{pmatrix}, \quad (2.17)$$

$$g = \begin{pmatrix} \epsilon_1 & \epsilon_2 & \dots & \epsilon_{k-1} & \epsilon_k & \dots & \epsilon_{2k-2} & \epsilon_{2k-1} & \epsilon_{2k} \\ \epsilon_{2k-1} & \epsilon_{2k-3} & \dots & \epsilon_1 & -\epsilon_2 & \dots & -\epsilon_{2k-4} & -\epsilon_{2k-2} & (-1)^k \epsilon_{2k} \end{pmatrix}, \quad (2.18)$$

Then we have $w_1 = g^{-1} w'_1 g$, and $w_2^+ = g^{-1} w'_2 g$ for even k , $w_2^- = g^{-1} w'_2 g$ for odd k . Note that $w'_1 = s_{2k-1} s_{2k}$ and $w'_2 = s_{13\dots 2k-1}$. So $w'_1, w'_2 \in \prod \Omega_{\Phi'_j}$ for the subset $I' = \{1, 3, \dots, 2k-3, 2k-1, 2k\}$, the corresponding root system is $(k+1)A_1$. \square

As was shown in previous subsection all folding subgroups come from subgroups of the groups of the form $\widehat{\Omega}_I \times \prod_{j=1}^l \Omega_{\Phi_j}$ corresponding to certain $I \subset \Delta^a$. For any Φ_j which is of type D_n, E_6, E_7 we can pick $g_j \in W_j$ as in proof of Lemma 2.6. The following Lemma says that the choice of g_j is actually canonical

Lemma 2.7. *Let Φ be of type D_n, E_6, E_7 , $g \in W_\Phi$ as in proof of Lemma 2.6. Let $\sigma \in \text{Aut}_\Phi$. Then $\sigma g = g\sigma$.*

Proof. For $\Phi = D_n$, $n > 4$ the only automorphism of Dynkin is given by $\sigma = \begin{pmatrix} \epsilon_1 & \epsilon_2 & \cdots & \epsilon_{n-1} & \epsilon_n \\ \epsilon_1 & \epsilon_2 & \cdots & \epsilon_{n-1} & -\epsilon_n \end{pmatrix}$, and clearly commutes with g . For E_7 there is no automorphisms of Δ . It remains to check cases D_4 and E_6 , this is a direct computation. \square

Due to lemma the element $g = \prod g_j$ commutes with the group $\widehat{\Omega}_I$. Then using g we conjugate the group $\widehat{\Omega}_I \times \prod_{j=1}^l \Omega_{\Phi_j}$ to $\widehat{\Omega}_I \times \prod_{j=1}^{l'} \Omega_{\Phi'_j}$, where subset $I' \subset I$ such that all corresponding root systems Φ'_j are of A type.

Therefore all folding subgroups come from from subgroups of the groups of the form $\widehat{\Omega} \times \prod_{j'=1}^{l'} \Omega_{\Phi'_{j'}}$ where all $\Phi'_{j'}$ are of A type.

2.4 Selection rules

We will see that to find distinct (true) folding transformations, it is sufficient to consider rather special subsets $I = \sqcup I_j$ and special elements of the group $\widehat{\Omega} \times \prod \Omega_{\Phi_j}$, $\Phi_j = A_{n_j}$. More precisely, corresponding selection rules will follow from the invariant set condition. Note that such selection rules are only *necessary*. As we mentioned before in order to show that all folding candidates will give us foldings and these foldings are not equivalent we will use geometry in Sections 3, 5.

It is instructive to consider at first two extreme cases.

Case 1. Let $w = \pi \in \widehat{\Omega}$. In this case, we only have to check that the invariant set \mathcal{A}_w is at least two dimensional (true folding condition). This condition means that the number of orbits of π on the set Δ^a (vertices of the affine Dynkin diagram) should be at least 2. We list folding candidates satisfying this condition in Section 2.5. We list folding candidates with one orbit in Appendix A.

Case 2. Let $w \in \prod_{j=1}^l \Omega_{\Phi_j}$. Recall that any element of Ω_{A_n} has the form $\bar{\pi}_{n+1}^k$, $0 \leq k \leq n$, where $\bar{\pi}_{n+1} = s_n s_{n-1} \cdots s_2 s_1$.

Lemma 2.8. *For A_n let $\gcd(k, n+1) = d$ and $m = (n+1)/d - 1$. Then $\bar{\pi}_{n+1}^k$ is conjugated to $\prod_{j=1}^d \bar{\pi}_{m+1}^{(j)}$, where $\bar{\pi}_{m+1}^{(j)} = s_{(j-1)(m+1)+m} \cdots s_{(j-1)(m+1)+1}$.*

In other words, $\bar{\pi}_{m+1}^{(j)}$ is a standard generator of Ω_{A_m} , where A_m has simple roots $\alpha_{(j-1)(m+1)+i}$, $i = 1 \dots m$. We can also say, that after removing simple roots α_i with $m+1|i$, the Dynkin diagram of A_n breaks up into d subdiagrams A_m .

Proof. Under isomorphism $W(A_n) = S_{n+1}$ both $\bar{\pi}_{n+1}^k$ and $\prod_{j=1}^d \bar{\pi}_{m+1}^{(j)}$ are products of d cycles of length $m+1$. It remains to note that conjugacy classes in S_{n+1} are labeled by the cyclic types. \square

It follows from the lemma that it is sufficient to consider elements of the form $w = \prod_{j=1}^l \bar{\pi}_{n_i+1}^{(j)}$ for standard generators $\bar{\pi}_{n_i+1}^{(j)}$ of $\Phi_j = A_{n_j}$. The choice of $\bar{\pi}_{n_i+1}$ depends on the orientation of Dynkin diagram of Φ_j , but up to conjugacy, we can pick any orientation.

Below we will visualize the set I as a coloring of affine Dynkin diagram, namely vertices corresponding to $\alpha_i \in I$ we color in black and other vertices we color in white. Let us now find condition on the invariant subset \mathcal{A}_w .

For the root system A_n we have in terms of the root variables

$$\begin{aligned} s_n s_{n-1} \cdots s_2 s_1 (a_1, a_2, a_3, \dots, a_n) &= s_n s_{n-1} \cdots s_2 (a_1^{-1}, a_1 a_2, a_3, \dots, a_n) \\ &= s_n s_{n-1} \cdots s_3 (a_2, (a_1 a_2)^{-1}, a_1 a_2 a_3, a_4, \dots, a_n) = \cdots = (a_2, a_3, \dots, a_n, (a_1 \cdots a_n)^{-1}). \end{aligned} \quad (2.19)$$

Hence w -invariance condition on black vertices b give

$$b \in \Phi_j : a_b = \exp\left(2\pi i \frac{m_j}{n_j + 1}\right) \quad (2.20)$$

for some $0 \leq m_j \leq n_j$. Moreover if $\gcd(m_j, n_j + 1) = d > 1$ then the reflections $\frac{n_j+1}{d}i, i = 1 \dots d - 1$ act trivially and corresponding roots can be excluded from I . So we can assume coprimeness of m_j and $n_j + 1$.

Action of w will multiply white vertex $c \in \Delta^a \setminus I$ root variable by root variables of adjacent ($\in N(c)$) and black ($\in I$) vertices. Namely, we have

$$w(a_c) = a_c \prod_{b \in I \cap N(c)} \exp\left(2\pi i \frac{i_b m_b}{n_b + 1}\right), \quad (2.21)$$

where $n_b = n_j, m_b = m_j$ for $\Phi_j \ni b$ and $i_b \in 1 \dots n_b$ is the number of vertex b in Φ_j in the numbering used in the definition of $\bar{\pi}$. The w -invariance condition (on white vertices) reads that product in r.h.s. of above formula equals 1.

We summarize discussion above as a set of selection rules on the coloring of affine Dynkin diagram:

- Each connected component of I is Dynkin diagram of A type: $I = \sqcup \Delta_j$ where Δ_j corresponds to root system $\Phi_j = A_{n_j}$.
- Number vertices of each Δ_j successively from 1 to n_j , starting from either end. Then for all Δ_j exist integer number $m_j, 0 < m_j \leq n_j, \gcd(m_j, n_j + 1) = 1$, such that for any white vertex c

$$\sum_{b \in I \cap N(c)} \frac{i_b m_{j(b)}}{n_{j(b)} + 1} \in \mathbb{Z}, \quad (2.22)$$

where the sum runs over the set of black vertices adjacent to $c, j(b)$ is number of A -component of b i.e. $b \in \Delta_{j(b)}$, and i_b is number of b in $\Delta_{j(b)}$.

- There are at least two white vertices: $|\Delta^a \setminus I| \geq 2$.

The last item is necessary to have at least two dimensional \mathcal{A}_w , namely to have a true folding.

It is sufficient to classify colorings up to the action of the group $\widehat{\Omega}$ because such action corresponds to conjugation of w . We give a complete list of colorings that satisfy the above selection rules in Section 2.5. Additionally, in Appendix A we give complete list of colorings with $|\Delta^a \setminus I| = 1$.

Group element will be given by $w = \prod_{j=1}^l \bar{\pi}^{(j)}$, where $\bar{\pi}^{(j)} \in \Omega_j$. The order of w is least common multiple of $n_j + 1$. The values m_j determine connected component \mathcal{A}_w of the invariant set \mathcal{A}^w by (2.20). We will see below that for given w there are either one such component or several (usually two) components related by the action of normalizer $N(\langle w \rangle, W^{ae})$. So it is sufficient to consider only one component.

Example 2.1. Let us consider case $\Phi^a = E_7^{(1)}$. In this example we consider four subsets $I \subset \Delta^a$, they are given in Fig. 2.

First consider $I = 3A_1$, it is given on the upper left diagram of Fig. 2. Here there is no choice for m_j, i_b namely $m_j = 1$ and $i_b = 1$. Summands from (2.22) are denoted on the figure as blue fractions. For all white nodes, we compute sums (2.22), they are written in green. All of them are integer, so the selection rule is satisfied and we have folding transformation $w = s_0 s_1 s_3$.

Consider $I = A_1 + A_3$ as on upper right diagram of Fig. 2. We choose here $m_j = 1$ for both components A_3 and again write summands near black nodes and sums near black ones. One of the sums is not an integer (it is written in red) so the selection rule fails. It is easy to see that if we set $m_j = 3$ for A_3 component then the selection rule also fails.

Consider now $I = 2A_3$, the corresponding diagrams are in the bottom of Fig. 2. In the left diagram we choose $m_j = 1$ for left A_3 and $m_j = 3$ in right A_3 and failed. However, in the right diagram, taking both $m_j = 1$ we succeed and obtain folding $w = s_{321} s_{765}$. The corresponding irreducible component in \mathcal{A}_w is defined by $a_1 = a_2 = a_3 = a_5 = a_6 = a_7 = i$. Another component could be obtained by taking both $m_j = 3$, in this case we obtain $-i$ on black vertices. These components are related by normalizer.

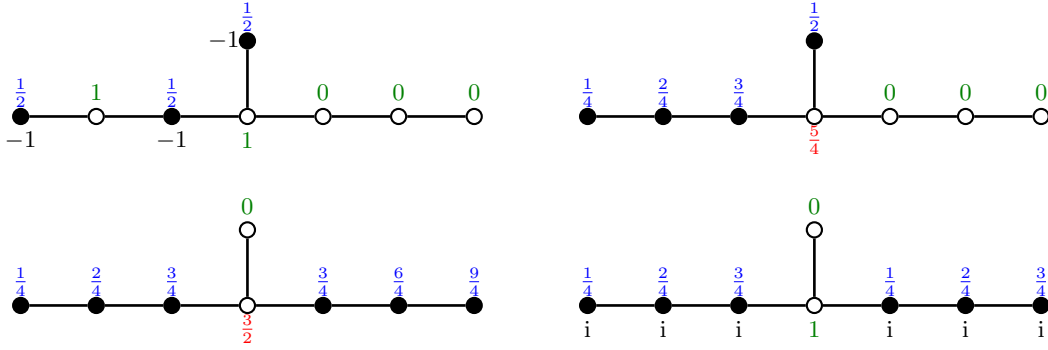

Figure 2: Example of different $E_7^{(1)}$ colorings

Case 3. Finally, let us consider intermediate case $w = \pi \cdot \prod_{j=1}^l \bar{\pi}_{n_j+1}^{k_j}$, where $\pi \neq e \in \widehat{\Omega}_I$. Recall the π acts on the set of connected components of I , i.e. in the set of Δ_j , as permutation.

Let π has order d . Each Δ_j is either invariant under the action of π or belongs to the orbit of the size d . Indeed, since possible values of d for $\Phi = E_n^{(1)}$ are 2, 3, 4, 5, 6 the only cases to exclude is $d = 4$ and orbit of size 2 and $d = 6$ and orbits of sizes 2 and 3. This can possibly happen only for $\Phi^a = D_5^{(1)}, E_3^{(1)}$, but still does not happen.

If component Δ_j is invariant then π either acts on it trivially or by σ which reversing order. In first case we can apply Lemma 2.8 and (possibly reducing Δ_j) we can assume that corresponding element of Ω_{Φ_j} is $\bar{\pi}_{n_j+1}$. Otherwise we use

Lemma 2.9. *Element $w = \sigma \bar{\pi}_{n+1}^k \in C_2 \times W_{A_n}$ can be conjugated by the elements of W_{A_n} to $\sigma s_{(n+1)/2}$ for odd n and k or to σ otherwise.*

Proof. Using relation $\bar{\pi}_{n+1}\sigma = \sigma\bar{\pi}_{n+1}^{-1}$ we can conjugate w to σ for even k and to $\sigma\bar{\pi}_{n+1}$ for odd k . Now using $s_{n+1-i}\sigma = \sigma s_i$ we conjugate $\sigma\bar{\pi}_{n+1}$ to σ or to $\sigma s_{(n+1)/2}$ depending on parity of n . \square

Hence we can consider that π acts trivially on any invariant component Δ_j .

Let us pick on component Δ_j for each orbit of π . We call such component distinguished and denote set of such components by D . By $I_D = \sqcup_{j \in D} \Delta_j$ we denote the set of corresponding nodes.

Lemma 2.10. *Element w can be conjugated by element from $W_{\sqcup \Phi_j}$ to the form*

$$w = \pi \prod_{j \in D} \bar{\pi}_{n_j+1}^{(j)} \quad (2.23)$$

Proof. It is sufficient to consider one π -orbit of length d . Denote corresponding components by $\Delta_0, \Delta_1, \dots, \Delta_{d-1}$, assuming that distinguished component is Δ_0 and $\pi(i) = i + 1 \pmod{d}$. Let factor of w corresponding to this orbit be $\pi \cdot \prod_i (\bar{\pi}^{(i)})^{k_i}$. Conjugating w by the elements $\pi^{(i)}$ successively for $i = d - 1 \dots 1$, we vanish all k_i except probably $i = 0$. Now for any $g \in W_{\Phi_0}$ we can conjugate w by the product $\prod_{i=0}^{d-1} \pi^i(g)$, this is equivalent to conjugation of the Δ_0 component of w by g . Then, using Lemma 2.8, we reduce to the case $k_0 = 1$. \square

Let us now find the condition on the invariant subset \mathcal{A}_w . As in previous case, for the black vertices we have

$$b \in \Delta_j : a_b = \exp\left(2\pi i \frac{m_j}{n_j + 1}\right) \quad (2.24)$$

with $\gcd(m_j, n_j + 1) = 1$ and numbers m_j are π invariant $m_j = m_{\pi(j)}$. The white vertex root variables transform under w as follows

$$w(a_{\pi(c)}) = a_c \prod_{b \in I_D \cap N(c)} \exp\left(2\pi i \frac{i_b m_j(b)}{n_j(b) + 1}\right), \quad (2.25)$$

where i_b as before is the number of vertex b in component $j(b)$. The w -invariance condition (on white vertices) reads that product in r.h.s. of the above formula equals 1.

We summarize the discussion above as a set of selection rules on the coloring of the affine Dynkin diagram with automorphism $\pi \neq e \in \widehat{\Omega}_\Phi$. As before $\{\Delta_j\}$ is a set of connected components of I , by n_j we denote number of vertices in Δ_j

- Coloring is invariant with respect to π .
- Each Δ_j is Dynkin diagram of type A .
- If some Δ_j is π -invariant as a set then π acts trivially on it ($\forall b \in \Delta_j, \pi j = j : \pi b = b$).
- In each π -orbit choose one distinguished component Δ_j . Number vertices of each distinguished component Δ_j successively from 1 to n_j , starting from either end. Then there is a choice of numbers $m_j, 0 < m_j \leq n_j, \gcd(m_j, n_j + 1) = 1$ for each distinguished component, such that for any white vertex c

$$\sum_{b \in I_D \cap N(c)} \frac{i_b m_{j(b)}}{n_{j(b)} + 1} \in \mathbb{Z}, \quad (2.26)$$

where the sum runs over the set of black vertices from distinguished components adjacent to c , $j(b)$ is such that $b \in \Delta_{j(b)}$, and i_b is number of b in component $\Delta_{j(b)}$.

- Number of π -orbits on the set of vertices $\Delta^a \setminus I$ is at least 2.

The last item is necessary to have at least two-dimensional \mathcal{A}_w , namely to have a true folding. Clearly these selection rules are generalization of selection rules in case 2. The general formula for the folding transformation is

$$w = \pi \prod_{j \in D} \bar{\pi}^{(j)}, \quad \pi \in \widehat{\Omega}_\Phi, \quad \bar{\pi}^{(j)} \in \Omega_{\Phi_j = A_{n_j}} \quad (2.27)$$

We will list colorings that satisfy selection rules in Section 2.5. It appears that there are only 2 true folding transformations of case 3: one for $E_7^{(1)}$ and one for $D_5^{(1)}$. There exist more case 3 folding transformations, if we drop the true folding selection rule (take one white orbit), they are listed in Appendix A. We have the same comment about m_j as for case 2.

Non-cyclic groups. It remains to classify folding groups H which are not cyclic. As was shown above any such H is a subgroup of group of the form $\widehat{\Omega} \times \prod_{j'=1}^l \Omega_{\Phi_{j'}}$ where all $\Phi_{j'}$ are of A type. Any nontrivial element of the H should generate a cyclic folding subgroup, and such elements were classified above up to conjugation. For any such element w we find list of subsets $I \in \Delta^a$ such that there exists element $\tilde{w} \in \widehat{\Omega} \times \prod_{j'=1}^l \Omega_{\Phi_{j'}}$ conjugated to w . In order to do this we reverse simplification performed in Lemmas 2.8, 2.9 and 2.10. Note that condition (2.20) should hold for any connected component of I , and we can keep the assumption $\gcd(m_j, n_j + 1) = 1$.

Then we check which of such \tilde{w} can be combined into one group. The list of not cyclic folding subgroups is given in Section 2.5. Here we just consider the most nontrivial example.

Example 2.2. We have 6 folding transformations for $E_7^{(1)}$. For each of them we list conjugated elements in form $\widehat{\Omega} \times \prod_{j'=1}^l \Omega_{\Phi_{j'}}$. We restrict ourselves to the case that $|\Delta^a \setminus I| \geq 2$, since otherwise we do not have dynamics. Similarly in the last case we assumed that number of π orbits on $\Delta^a \setminus I$ is at least 2. By $[i, i+1, \dots, j]$ we denote connected component with nodes $i, i+1, \dots, j$.

- $s_{12}^{1,2} s_{40}^{1,2} s_{67}^{1,2} I = \{[1, 2], [4, 0], [6, 7]\};$
- $s_{123}^{1,3} s_{567}^{1,3} I = \{[1, 2, 3], [5, 6, 7]\};$
- $\pi s_0 s_1 s_3, \pi s_0 s_1 s_5, \pi s_0 s_3 s_7, \pi s_0 s_5 s_7, \pi \times I = \pi \times \{0, 1, 3, 5, 7\};$
- $s_1 s_3 s_5 s_7, I = \{1, 3, 5, 7\}; s_{123}^2 s_5 s_7, I = \{[1, 2, 3], 5, 7\}; s_1 s_{345}^2 s_7, I = \{1, [3, 4, 5], 7\};$
 $s_1 s_3 s_{567}^2, I = \{1, 3, [5, 6, 7]\}; s_{12345}^3 s_7, I = \{[1, 2, 3, 4, 5], 7\}; s_{123}^2 s_{567}^2, I = \{[1, 2, 3], [5, 6, 7]\};$
 $s_1 s_{34567}^3, I = \{1, [3, 4, 5, 6, 7]\};$

- $s_0 s_1 s_3$, $I = \{0, 1, 3\}$; $s_0 s_5 s_7$, $I = \{0, 5, 7\}$; $s_0 s_{123}^2 s_0$, $I = \{0, [1, 2, 3]\}$;
 $s_1 s_{340}^2$, $I = \{1, [3, 4, 0]\}$; $s_{045}^2 s_7$, $I = \{[0, 4, 5], 7\}$; $s_0 s_{567}^2$, $I = \{0, [5, 6, 7]\}$;
 s_{12340}^3 , $I = \{[1, 2, 3, 4, 0]\}$; s_{04567}^3 , $I = \{[0, 4, 5, 6, 7]\}$;
- π , $\pi \times I = \pi$; $\pi s_{04}^{1,2}$, $\pi \times I = \pi \times \{[4, 0]\}$; πs_{17} , $\pi \times I = \pi \times \{1, 7\}$;
 πs_{26} , $\pi \times I = \pi \times \{2, 6\}$; πs_{35} , $\pi \times I = \pi \times \{3, 5\}$; πs_{345}^2 , $\pi \times I = \pi \times \{[3, 4, 5]\}$;
 $\pi s_{17} s_{35}$, $\pi \times I = \pi \times \{1, 3, 5, 7\}$; $\pi s_{1267}^{1,2}$, $\pi \times I = \pi \times \{[1, 2], [6, 7]\}$;
 $\pi s_{2356}^{1,2}$, $\pi \times I = \pi \times \{[2, 3], [5, 6]\}$; $\pi s_{04}^{1,2} s_{17}$, $\pi \times I = \pi \times \{1, 7, [4, 0]\}$;
 $\pi s_{04}^{1,2} s_{26}$, $\pi \times I = \pi \times \{2, 6, [4, 0]\}$; $\pi s_{23456}^{2,4}$, $\pi \times I = \pi \times \{[2, 3, 4, 5, 6]\}$;
 $\pi s_{345}^2 s_{17}$, $\pi \times I = \pi \times \{1, [3, 4, 5], 7\}$; $\pi s_{123567}^{1,2,3}$, $\pi \times I = \pi \times \{[1, 2, 3], [5, 6, 7]\}$;

We see that possible choices for noncyclic groups are

$\pi \times \{0, 1, 3, 5, 7\}$	$\{0, 1, 3, 5, 7\}$	$\pi \times \{1, 3, 5, 7\}$	$\pi \times \{1, [3, 4, 5], 7\}$	$\pi \times \{[1, 2, 3], [5, 6, 7]\}$
$C_2 \times C_4$	$C_2 \times C_2$	$C_2 \times C_2$	$C_2 \times C_2$	$C_2 \times C_4$

Note that the groups in the third and fourth columns are conjugated.

2.5 Answers

Sym./surf.	Diagram	Name	Order	w	\mathcal{A}_w	Sec.
$E_8^{(1)}/A_0^{(1)}$		$3A_2$	3	$s_{21}s_{54}s_{87}$	$(\zeta, \zeta, \zeta), (\zeta^{-1}, \zeta^{-1}, \zeta^{-1})$	4.1
		$4A_1$	2	$s_0s_4s_6s_8$	$(-1, -1, -1, -1)$	
		A_1+2A_3	4	$s_1s_{430}s_{876}$ $w^2 = s_{37}(s_0s_4s_6s_8)s_{73}$	$(-1, i, i), (-1, -i, -i)$	
$E_7^{(1)}/A_1^{(1)}$		π	2	π	$(a_1=a_7, a_2=a_6, a_3=a_5)$	4.2
		$3A_1$	2	$s_0s_1s_3$	$(-1, -1, -1)$	
		$4A_1$		$s_1s_3s_5s_7$	$(-1, -1, -1, -1)$	
		$3A_2$	3	$s_{12}s_{40}s_{76}$	$(\zeta, \zeta, \zeta), (\zeta^{-1}, \zeta^{-1}, \zeta^{-1})$	
		$2A_3$	4	$s_{321}s_{765}$ $w^2 = s_{26}(s_1s_3s_5s_7)s_{62}$	$(i, i), (-i, -i)$	
		$\pi \times 5A_1$		$\pi s_0s_1s_3$ $w^2 = s_1s_3s_5s_7$	$(-1, -1, -1, -1, -1; a_2=a_6)$	
$E_6^{(1)}/A_2^{(1)}$		π	3	π	$(a_0=a_1=a_5, a_2=a_4=a_6)$	4.3
		$2A_2$		$s_{12}s_{45}$	$(\zeta, \zeta), (\zeta^{-1}, \zeta^{-1})$	
		$4A_1$	2	$s_0s_1s_3s_5$	$(-1, -1, -1, -1)$	
$D_5^{(1)}/A_3^{(1)}$		π^2	2	π^2	$(a_0=a_1, a_4=a_5)$	4.4
		$2A_1$		s_4s_5	$(-1, -1)$	
		π	4	π $w^2 = \pi^2$	$(a_0=a_1=a_4=a_5, a_2=a_3)$	
		A_1+A_3		s_1s_{534} $w^2 = s_3(s_4s_5)s_3$	$(-1, i), (-1, -i)$	
		$\pi^2 \times 3A_1$	2	$\pi^2 s_2 s_4$ $w^2 = s_4 s_5$	$(-1, -1, -1; a_0 = -a_1)$	
		$4A_1$		$s_0s_1s_4s_5$	$(-1, -1, -1, -1)$	
$E_3^{(1)}/A_5^{(1)}$		π^3	2	π^3	$(a_3=a_4)$	4.6
		A_1		s_4	(-1)	
		π^2	3	π^2	$(a_0=a_1=a_2)$	
		A_2		s_{12}	$(\zeta), (\zeta^{-1})$	
$A_1^{(1)}/A_7^{(1)'}$		π^2	2	π^2	-	4.8
		σ		σ	-	

In the paper we *name* folding transformations by element of $\widehat{\Omega}$ and components of I , like $\pi \times A_{n_1} + \dots + A_{n_l}$. In this naming we will drop $e \in \widehat{\Omega}$ and write \times instead of \ltimes , when all components of I are π -invariant.

In the next table, we present non-cyclic folding subgroups. For each group, we write formulas for its generators. In the column ‘‘Group’’ we also note nontrivial embeddings between different non-cyclic folding subgroups.

Sym./surf.	Diagram	Name	Group	\mathcal{A}_w
$E_7^{(1)}/A_1^{(1)}$		$\pi \times 5A_1$	$\text{Dih}_4^{(1)} = \underbrace{C_2}_{\pi} \times \underbrace{C_4}_{\pi s_0 s_1 s_3}$	$(-1, -1, -1, -1, -1; a_2 = a_6)$
		$\pi \times 2A_3$	$\text{Dih}_4^{(2)} = \underbrace{C_2}_{\pi} \times \underbrace{C_4}_{s_3 s_2 s_1 s_7 s_5}$	$(i, i), (-i, -i)$
		$\pi \times 4A_1$	$\underbrace{C_2}_{\pi} \times \underbrace{C_2}_{s_1 s_3 s_5 s_7} \subset \text{Dih}_4^{(1,2)}$	$(-1, -1, -1, -1; a_2 = a_6)$
		$5A_1$	$\underbrace{C_2}_{s_0 s_1 s_3} \times \underbrace{C_2}_{s_1 s_3 s_5 s_7} \subset \text{Dih}_4^{(1)}$	$(-1, -1, -1, -1, -1)$
$D_5^{(1)}/A_3^{(1)}$		$\pi^2 \times 4A_1$	$\underbrace{C_2}_{\pi^2} \times \underbrace{C_2}_{s_0 s_1 s_4 s_5} \times \underbrace{C_2}_{s_4 s_5}$	$(-1, -1, -1, -1)$
		$4A_1$	$\underbrace{C_2}_{s_0 s_1 s_4 s_5} \times \underbrace{C_2}_{s_4 s_5} \subset C_2^3$	$(-1, -1, -1, -1)$
		$\pi^2 \times 4A_1$	$\underbrace{C_2}_{\pi^2} \times \underbrace{C_2}_{s_0 s_1 s_4 s_5} \subset C_2^3$	$(-1, -1, -1, -1)$
		$\pi^2 \times 2A_1$	$\underbrace{C_2}_{\pi^2} \times \underbrace{C_2}_{s_4 s_5} \subset C_2^3$	$(-1, -1; a_0 = a_1)$
$E_1^{(1)}/A_7^{(1)}$		$\pi^2 \times \sigma$	$\underbrace{C_2}_{\pi^2} \times \underbrace{C_2}_{\sigma}$	-

2.6 Invariant lattices and normalizers

Invariant and orthogonal lattices. For given $w \in W^{ae}$ of finite order n introduce two sublattices of Q^a :

1. Invariant sublattice $Q^{a,w} = \text{Ker}_{Q^a}(w - 1)$.
2. Orthogonal sublattice $Q^{a,\perp w} = \text{Ker}_{Q^a} \sum_{i=0}^{n-1} w^i$.

Lemma 2.11. *Sublattices $Q^{a,w}, Q^{a,\perp w}$ have following properties*

1. Lattices $Q^{a,w}$ and $Q^{a,\perp w}$ are orthogonal, union of their bases is a basis in $Q^a \otimes_{\mathbb{Z}} \mathbb{Q}$, i.e. $Q^{a,w} \oplus Q^{a,\perp w}$ is a sublattice of full rank in Q^a .
2. Invariant sublattice of $w = t_\lambda \bar{w} \in P \rtimes W$ depends only on finite part $\bar{w} \in W$: $Q^{a,w} = Q^{a,\bar{w}}$.
3. Imaginary root belongs to invariant sublattice: $\delta \in Q^{a,w}, \delta \notin Q^{a,\perp w}$.

Proof. 1. Let us consider complexification $Q^a \otimes_{\mathbb{Z}} \mathbb{C} = \mathbb{C}^{r+1}$. If w has order n , eigenvalues of its natural action on this space will be n -th roots of unity. Note that the dimension of space of solutions of

the equation $w(\sum_j c_j \alpha_j) = \sum_j c_j \alpha_j$ is the same for the base fields \mathbb{Q} and \mathbb{C} . Hence the eigenspace of w with eigenvalue 1 is complexification $Q^{a,w} \otimes_{\mathbb{Z}} \mathbb{C}$ of $Q^{a,w}$. Similarly, looking to the equation $(\sum_{i=0}^{n-1} w^i) \sum_j c_j \alpha_j = 0$ we see that span of eigenspaces with eigenvalues $\neq 1$ is a complexification $Q^{a,\perp,w} \otimes_{\mathbb{Z}} \mathbb{C}$ of $Q^{a,\perp,w}$.

2. Because $w = t_\lambda \bar{w}$ has finite order, then $\lambda \in \text{Ker}_P \sum_{i=0}^{n-1} w^i \subset Q^{a,\perp w} \otimes_{\mathbb{Z}} \mathbb{Q}$. So λ is orthogonal to $Q^{a,w}$, which give us the statement.
3. This follows from $W^{ae}(\delta) = \delta$. □

These sublattices we will use for the calculation of the normalizer of folding transformations. Below we present some simplifications for calculation of such sublattices:

1. Due to the Lemma 2.6 finitization \bar{w} of folding group elements of case 1 is conjugated to folding group element of case 2. A similar statement holds also for the case 3. Hence, their invariant sublattices $Q^{a,w}$ are related by action of group elements, which are used for above conjugation.
2. For case 2 direct calculation gives $Q^{a,\perp w} = \langle \{\alpha_i \in I\} \rangle$.
3. For case 1 direct calculation gives $Q^{a,\perp w} = \langle \{\alpha_i - \pi(\alpha_i)\} \rangle$
4. For case 3 direct calculation gives $Q^{a,\perp w} = \langle \{\alpha_i - \pi(\alpha_i), i \in \Delta^a \setminus I\} \rangle \oplus \langle \{\alpha_i \in I\} \rangle$.

Normalizer and components. Normalizer of the cyclic group $\langle w \rangle$ is a semidirect product of group N_{flip} , changing its primitive generator and centralizer C :

$$N(\langle w \rangle, W^{ae}) = N_{flip} \times C(w, W^{ae}), \quad (2.28)$$

$N_{flip} \subset C_2$ for w of order 2, 3, 4, 6 and C_4 for w of order 5. We write \subset , because we cannot guarantee that all elements of N_{flip} are realized in W^{ae} . Indeed, for $w \in \widehat{\Omega}$ we cannot change primitive generator of outer automorphism group.

Normalizer acts on A^w and it appears that centralizer preserves folding irreducible components \mathcal{A}_w and N_{flip} permutes them. Note that for true folding, if $t_\lambda \in N$, then it immediately belongs to centralizer C .

Proposition 2.1. *Assume that $Q^{a,w}$ and $Q^{a,\perp w}$ are generated by root subsystems $\Phi^{a,w}$, $\Phi^{a,\perp w}$ of Φ^a . Then*

$$C(w, W^{ae}) \subset \text{Aut} \times (W_{\Phi^{a,w}}^a \times W_{\Phi^{a,\perp w}}^a) \quad (2.29)$$

where $\text{Aut} \subset \text{Aut}(\Phi^{a,w}) \times \text{Aut}(\Phi^{a,\perp w})$ denotes subgroup of all automorphisms of both lattices, that is realized in W^{ae} .

Proof. Sublattices $Q^{a,w}$ and $Q^{a,\perp w}$ are defined by w . Hence centralizer $C(w, W^{ae})$ should preserve sublattices $Q^{a,w}$ and $Q^{a,\perp w}$, as well as corresponding root systems $\Phi^{a,w}$ and $\Phi^{a,\perp w}$. □

Subgroup Aut of elements that can be realized in W^{ae} is usually much smaller than $\text{Aut}(\Phi^{a,w}) \times \text{Aut}(\Phi^{a,\perp w})$.

By definition of the invariant sublattice $W_{\Phi^{a,w}}^a$ commutes with w . We can decompose $\text{Aut} = \text{Aut}^\parallel \times \text{Aut}^\perp$, where Aut^\parallel acts effectively on the $\Phi^{a,w}$, $\text{Aut}^\perp \subset \text{Aut}(\Phi^{a,\perp w})$. If Aut^\parallel commutes with w , then

$$C(w, W^{ae}) = \text{Aut}^\parallel \times (W_{\Phi^{a,w}}^a \times (\text{Aut}^\perp \times W_{\Phi^{a,\perp w}}^a)^w), \quad (2.30)$$

where we take w -centralizer of last multiplier.

Remark 2.4. Sometimes in cases 1 and 3 sublattice $Q^{a,\perp w}$ is not generated by any root system. Namely, this happens for foldings $\pi \times 5A_1 \subset E_7^{(1)}$, $\pi \subset E_6^{(1)}$ and $\pi \subset D_5^{(1)}$. But it appears that in such cases we can find $\widetilde{Q}^{a,\perp w}$ of finite index in $Q^{a,\perp w}$ which corresponds to some root system and invariant under the action of normalizer $N(w, W^{ae})$. So the analog of the formula (2.29) holds.

Example 2.3. Let us consider folding $2A_3$ for $\Phi^a = E_7^{(1)}$ (second folding from Example 2.1) given by formula $w = s_{321}s_{765}$. We have, that $\Phi^{a,\perp w} = 2A_3$ generated by $\alpha_1, \alpha_2, \alpha_3$ and $\alpha_5, \alpha_6, \alpha_7$. $Q^{a,w}$ obviously contain α_0 , so together with δ we have $\Phi^{a,w} = A_1^{(1)}$.

We choose generator $s_1s_3s_5s_7$ for N_{flip} , such generator permutes irreducible components $a_{1,2,3,5,6,7} = i$ and $a_{1,2,3,5,6,7} = -i$.

Group Aut could be obtained by direct calculations. They give, that $\text{Aut}^\perp = C_2$, generated by π . Another multiplier $\text{Aut}^\parallel = C_2$, which generator is defined up to Aut^\perp , we take $\pi s \pi s^{-1}$, where $s = s_{4354}s_{2132}$. Aut^\perp and Aut^\parallel commutes. Sublattices and automorphisms are pictured on Fig. 3 ⁵.

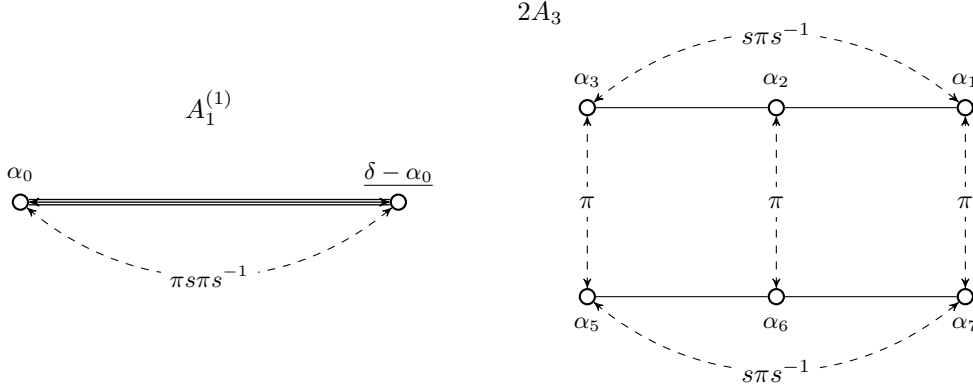

Figure 3: Root systems $\Phi^{a,w}$, $\Phi^{a,\perp w}$ and their automorphisms

We can check, that Aut^\parallel commutes with w , so due to (2.30), we have

$$C(w, W_{E_7}^{ae}) = \underbrace{C_2}_{\pi s \pi s^{-1}} \times (W^a \times \underbrace{C_2}_{\pi s_1 s_3 s_5 s_7} \times \underbrace{C_4^2}_{\Omega_{A_3}^2}) \simeq (\underbrace{C_2}_{\pi s_1 s_3 s_5 s_7} \times W_{A_1}^{ae}) \times C_4^2, \quad (2.31)$$

where we already calculated centralizer $(\text{Aut}^\perp \times W_{\Phi^{a,\perp w}})^w$.

Remark 2.5. Situation, presented in the Proposition 2.1 occurs only for about half cases of our folding classification. In other cases one of $Q^{a,w}$, $Q^{a,\perp w}$ (or $\widetilde{Q^{a,\perp w}}$) is generated by long root subsystem with roots of length $|\alpha|^2 = 2k$ for integer $k > 1$. In this case we usually can find elements in W^{ae} which acts as reflections in this long root system. But such an element could act by automorphisms on the other, $|\alpha|^2 = 2$ lattice, so direct product in the formula (2.29) becomes semidirect.

Note that symmetry on the image of folding transformation is smaller then $C(w, W^{ae})$, because some of the elements of the centralizer (for example w itself) act trivially on the image. In Sec. 3.3 we find the symmetry group on the image in each case by similar considerations. Also we explain, how to identify elements of centralizer with symmetries, using explicit formulas for coordinates $F = F(F, G)$, $G = G(F, G)$ found in Sec. 5. Now we only state that very often $W_{Q^{a,\perp w}}^w$ acts trivially on the image of the folding transformation.

Projective reduction. As was already mentioned in Remark 2.2 for special values of parameters there could exist group element $t^{1/n} \in W^{ae}$, such that

$$(t^{1/n})^n \in P, \quad t^{1/n} a_i = a_i q^{k_i/n}, \quad k_i \in \mathbb{Z} \quad (2.32)$$

Example 2.4. We had already example of projective reduction in the Introduction (Example 1.2). The dynamics of the q -Painlevé equation acts on root variables as (1.3), hence it is a translation $t_{\omega_2 - \omega_3}$, recall that $\omega_i \in P$ denotes i -th fundamental weight. It is easy to see that

$$t_{\omega_2 - \omega_3} = \pi^2 s_{3453} s_{2012} = (\pi s_{2012})^2 \quad (2.33)$$

⁵Here for simplicity we pictured action on orthogonal root subsystem of $s \pi s^{-1}$ instead of $\pi s \pi s^{-1}$.

Let us denote $t_{\omega_2-\omega_3}^{1/2} \equiv \pi s_{2012}$. This element acts as

$$t_{\omega_2-\omega_3}^{1/2}(a_0, a_1, a_2, a_3, a_4, a_5) = (a_5, a_4, a_2 a_{0123}, a_3 a_{0123}^{-1}, a_1, a_0) \quad (2.34)$$

For example, if $a_0 = a_5, a_4 = a_1$, this become a projective reduction and $q = a_{0123}^2$. In the Example 1.2 we have $a_{0,1,4,5} = -1$ so the projective reduction condition is satisfied. This is dashed dashed dynamics as in (1.6), (1.7).

To obtain a projective reduction for a special value of \vec{a} it is necessary, that some root of q is a Laurent monomial in free root variables.

For the folding invariant subset projective reduction should act as a translation on the invariant lattice root system $\Phi^{a,w}$. This transformation could act on orthogonal lattice $Q^{a,\perp w}$ as a nontrivial element of finite order.

Example 2.5 (Continuation of the Example 2.3). For the folding transformation $2A_3 \subset E_7^{(1)}$ we have $q = a_0^2 a_4^4 = (a_0 a_4^2)^2$, so we can expect for projective reduction as a square root of elementary translation. The elementary translation in invariant lattice is given by $\alpha_0 = 2\omega_0 - \omega_4$. In terms of symmetry lattice $\Phi^{a,w}$ this is translation by simple root, but one can expect existence of the translation by fundamental weight.

According to the formula (2.31) the elementary translation in $W_{A_1}^{ae}$ is $s_0 s \pi s^{-1} \pi$, where $s = s_{4354} s_{2132}$. And we have relation

$$t_{\omega_4-2\omega_0} = (s_0 s \pi s^{-1} \pi)^2 = (t_{\omega_4-2\omega_0}^{1/2})^2 \quad (2.35)$$

This square root $s_0 s \pi s^{-1} \pi$ is not a translation since it acts on orthogonal root system $\Phi^{a,w}$ as a nontrivial automorphism of order to 2, see Fig. 3). Hence $s_0 s \pi s^{-1} \pi$ is projective reduction.

Remark 2.6. For any Φ^a and $n > 1$ we can consider the following coloring. It is defined by the set $\Delta^a \setminus I$ of *white* nodes which is $\Delta^a \setminus I = \{i \in \Delta^a \mid \mathbf{m}_i \bmod n = 0\}$ where \mathbf{m}_i are marks in affine Dynkin diagram, see formula (2.5). If we set root variables corresponding to black nodes to be root of 1 (according to the case 2 condition (2.20)) then q becomes the n power of free root variables (possibly with some additional root of unity).

It is interesting, that if all connected components of I is Dynkin diagram of A -type then such coloring correspond to folding transformation. Such constriction gives 7 folding transformations: $3A_2, 4A_1, A_1 + 2A_3 \subset E_8^{(1)}$, $4A_1, 3A_2 \subset E_7^{(1)}$, $4A_1 \subset E_6^{(1)}$, $4A_1 \subset D_5^{(1)}$ (see Section 2.5). It also gives some folding transformations without dynamics (see Appendix A). Let us present the proof of this fact without case-by-case considerations.

The root marks for simply laced Dynkin diagram satisfy relation

$$\forall j \in \Delta^a : \sum_{i \in N(j)} \mathbf{m}_i = 2\mathbf{m}_j \quad (2.36)$$

which follow from orthogonality of α_j and δ . Therefore for any white node c we have

$$\sum_{b \in I \cap N(c)} \frac{\mathbf{m}_b}{n} \in \mathbb{Z}. \quad (2.37)$$

Let us number vertices on each connected component Δ_j from 1 to n_j . We also number corresponding border (white) points by 0 and $n_j + 1$, if the there is no border (white) point, we consider corresponding mark to be equal zero. Due to relation (2.36) for each connected component Δ_j difference $\mathbf{m}_k - \mathbf{m}_{k-1} \bmod n$ does not depend on k . We have

$$(\mathbf{m}_k - \mathbf{m}_{k-1})(n_j + 1) = 0 \pmod n, \quad (\mathbf{m}_k - \mathbf{m}_{k-1})l \neq 0 \pmod n, \quad \text{for } l \leq n_j. \quad (2.38)$$

Hence there exist $0 < m_j \leq n_j$, $\gcd(m_j, n_j + 1) = 1$ such that $\frac{m_j}{n_j + 1} = \frac{\mathbf{m}_k - \mathbf{m}_{k-1}}{n} \pmod 1$. For such choice of m_j and any vertex k in Δ_j we have $\frac{k m_j}{n_j + 1} = \frac{\mathbf{m}_k}{n} \pmod 1$. Hence the selection rule (2.22) is satisfied.

3 Geometric realization

3.1 Picard lattice

In the previous section, we classified all possible folding transformations and folding subgroups. Now for each folding, we will find to which Painlevé equation it maps. We will also show that folding transformations found are nontrivial and pairwise non-conjugate. In this section, we explain the methods, illustrate them with certain examples and give the table with answers. More details are given in Section 5.

Let us fix Painlevé family \mathcal{X} . Recall that any surface $\mathcal{X}_{\vec{a}}$ is blowup of $\mathbb{P}^1 \times \mathbb{P}^1$ in 8 points. We denote by $H_F, H_G, E_1, \dots, E_8$ standard generators of the Picard group of $\mathcal{X}_{\vec{a}}$, here E_i is an exceptional divisor corresponding to i -th blowup, H_F and H_G are given by equations $F = \text{const}$ and $G = \text{const}$ correspondingly, for generic constants.

Let K denotes canonical divisor of $\mathcal{X}_{\vec{a}}$. The anti-canonical divisor can be represented by unique curve D , in case of q -difference equation this curve is a closed chain of \mathbb{P}^1 -s, namely $(-K) = \delta_0 + \delta_1 + \dots + \delta_n$. Each δ_i has self-intersection $\delta_i^2 = -2$ and pairwise intersections are $\delta_i \cdot \delta_j = 1$ if $|i - j| = 1$ or $|i - j| = n$ and zero otherwise. Hence δ_i generate lattice of the type $A_n^{(1)}$ in the Picard group, this is so called *surface lattice* Φ_{surf}^a . The orthogonal complement to the surface lattice is called *symmetry lattice* $\Phi_{\text{sym}}^a = \Phi^a$. The (affine extended) Weyl group of Φ^a is the symmetry group of the family \mathcal{X} which we used in the previous section. The Sakai's families are labeled by their symmetry/surface types.

Example 3.1. Take any numbers $a_0, \dots, a_7 \in \mathbb{C}^*$, $a_0 \neq 1$, let $\mathcal{X}_{\vec{a}}$ be a blowup of $\mathbb{P}^1 \times \mathbb{P}^1$ at 8 points with coordinates as in the Fig. 4.

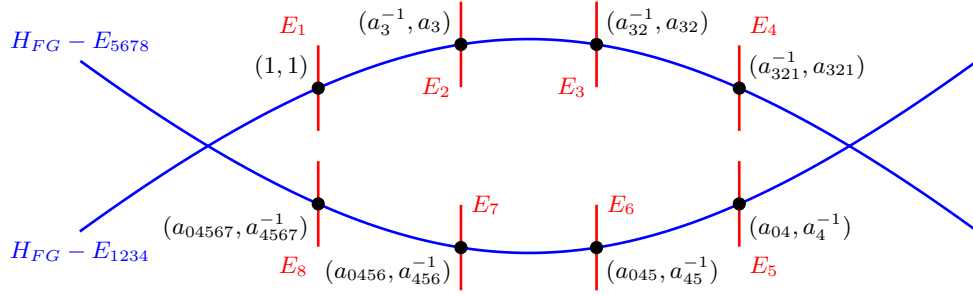

Figure 4: Blowup scheme for $E_7^{(1)}/A_1^{(1)}$

These points belong to two curves of degree $(1, 1)$ on $\mathbb{P}^1 \times \mathbb{P}^1$ given by equations $FG = 1$ and $FG = a_0$. Therefore the meromorphic form $\frac{dF \wedge dG}{(FG - 1)(FG - a_0)}$ has no zeroes on $\mathcal{X}_{\vec{a}}$ and only poles on the preimages of these curves. Hence $(-K)$ consists of two components

$$\delta_0 = H_{FG} - E_{1234}, \quad \delta_1 = H_{FG} - E_{5678}, \quad (3.1)$$

which generate surface lattice. Its type is $A_1^{(1)}$. We see that if $a_0 = 1$, then $-K$ degenerate, that's why this value is removed. The symmetry lattice is generated by classes

$$\alpha_0 = H_F - H_G, \quad \alpha_1 = E_3 - E_4, \quad \alpha_2 = E_2 - E_3, \quad \alpha_4 = E_1 - E_2, \quad (3.2)$$

$$\alpha_5 = H_G - E_{15}, \quad \alpha_6 = E_5 - E_6, \quad \alpha_7 = E_6 - E_7, \quad \alpha_7 = E_7 - E_8. \quad (3.3)$$

The intersection pairing between these roots is (opposite to) intersection pairing in root lattice $E_7^{(1)}$.

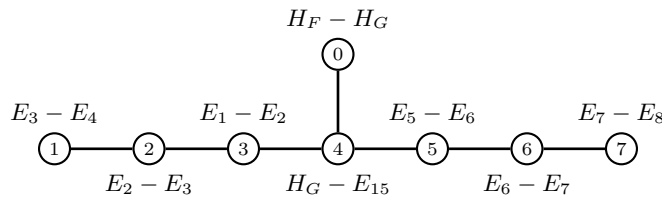

Hence we get symmetry/surface type $E_7^{(1)}/A_1^{(1)}$.

Remark 3.1. Here and below in figures we draw rational curves with self-intersection (-1) in red and rational curves with self-intersection (-2) in blue. Generally we will distinguish curves with different self-intersections by different colors according to the Table 3

The parameters a_i used there are multiplicative root variables. They can be defined using period map $\chi: \text{Pic}(\mathcal{X}_{\vec{a}}) \rightarrow \mathbb{C}^*$, see [Sak01, Sec. 5] ⁶. Then $a_i = \chi(\alpha_i)$, where $\alpha_0, \dots, \alpha_r$ are simple roots in the symmetry system Φ^a .

Usually the classes of roots in Φ^a are not effective, there are no curves representing such classes. But for some special values of root variables some of these classes might become effective. Recall [Sak01, Sec. 3] that a smooth rational curve with self-intersection (-2) is called a *nodal curve*. According to this definition all components $\delta_0, \dots, \delta_n$ of $(-K)$ are nodal curves, but we will mostly interest in nodal curves in symmetry lattice Φ^a , the set of such curves will be denoted as Δ^{nod} .

Self-intersection	Line
≥ 0	
-1	
-2	
-3	
-4	
-6	
-8	
non-specified	

Table 3: Self-intersections in Figures

Proposition 3.1 ([Sak01, Prop. 22]). *Denote by W^{nod} the subgroup of W_{Φ^a} generated by the reflections with respect to $\alpha \in \Delta^{\text{nod}}$. Then $\chi(\alpha) = 1$ if and only if $\alpha \in W^{\text{nod}} \cdot \Delta^{\text{nod}}$.*

Let $\alpha \in Q^a$ be a root (i.e. $\alpha^2 = -2$), $\chi(\alpha)$ be a corresponding root variable and $s_\alpha: X_{\vec{a}} \rightarrow X_{s_\alpha(\vec{a})}$ corresponding reflection. For generic values of parameters we have $\chi(s_\alpha(\alpha)) = \chi(\alpha)^{-1}$. Now assume that α is a nodal curve $\alpha \in \Delta^{\text{nod}}$, hence $\chi(\alpha) = 1$ and assume that other root variables are generic. We have $\chi(s_\alpha(\alpha)) = 1$, hence $s_\alpha(\alpha) = n\alpha$ for $n \in \mathbb{Z}$, hence $s_\alpha(\alpha) = \alpha$ since $(-\alpha)$ could not be effective. Moreover, for any $\beta \in Q^a$ we have $\beta \cdot \alpha = s_\alpha(\beta) \cdot \alpha$ and $\chi(s_\alpha(\beta)) = \chi(\beta)$, hence $s_\alpha(\beta) = \beta$. Since s_α acts trivially on Picard lattice it should be a trivial transformation of $\mathcal{X}_{\vec{a}}$. Clearly, the same property holds for divisors in $\alpha \in W^{\text{nod}} \cdot \Delta^{\text{nod}}$, in other words for any divisor with $\chi(\alpha) = 1$ the corresponding reflection should be trivial transformation of $\mathcal{X}_{\vec{a}}$. This can be considered as a geometric proof of Lemma 2.1.

For any two nodal curves $\alpha, \beta \in \Delta_{\text{nod}}$ we have either $\alpha \cdot \beta = 0$ or $\alpha \cdot \beta = 1$ since otherwise $(\alpha + \beta)^2 \geq 0$ and non proportional to δ and this is forbidden in Q^a . Therefore elements of Δ_{nod} are simple roots for some finite root system which we denote by Φ_{nod} . We denote by Q_{nod} the sublattice in Q^a generated by Φ_{nod} and $\overline{Q}_{\text{nod}} = (Q_{\text{nod}} \otimes_{\mathbb{Z}} \mathbb{Q}) \cap Q^a$. In general the lattices Q_{nod} and $\overline{Q}_{\text{nod}}$ are different, but Q_{nod} is a sublattice of finite index in $\overline{Q}_{\text{nod}}$. Usually the lattice $\overline{Q}_{\text{nod}}$ is generated by some root system, we denote this root system by $\overline{\Phi}_{\text{nod}}$.

3.2 Quotient

Surface. Let $w \in W^{ae}$ be a true folding transformation. Recall that it means there exists \vec{a} such that $w(\vec{a}) = \vec{a}$, but w acts on $X = \mathcal{X}_{\vec{a}}$ nontrivially and there exists translation $t_\lambda \in W^{ae}$ which commutes with w . Hence t_λ acts on the quotient $Y' = X/\langle w \rangle$, where $\langle w \rangle$ is a group generated by w . This action of t_λ is a new Painlevé dynamics, dynamics after folding transformation. But in general Y' is not a rational surface corresponding to the Painlevé equation, one have to first resolve singularities $\tilde{Y} \rightarrow Y'$ and then (possibly) perform additional blowdown $\tilde{Y} \rightarrow Y$.

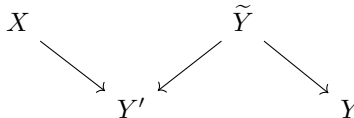

Let us discuss these steps in more detail. The singularities of Y' are images of points of $p \in X$ which are stabilized by nontrivial subgroups in $\langle w \rangle$, denote generator of this subgroup by w^\sharp . The order of w can be 2, 3, 4 (this follows from classification performed in Section 2), then $w^\sharp = w$ or $w^\sharp = w^2$ if order of

⁶Note that in multiplicative case (on which we restrict in this paper) the image of the period map χ is $\mathbb{C} \text{ mod } \mathbb{Z}$. So we applied $\exp(2\pi i \cdot)$ to χ in loc. cit

w is 4. There exist some coordinates in the neighborhood of p such that w^\sharp acts as $F \mapsto F\zeta_m, G \mapsto G\zeta_m^d$, where ζ_m is some primitive root of unity of order m , m is the order of w^\sharp , and $0 < d < m$.

The minimal resolution of such singularities can be constructed using toric geometry as in [Ful93, Sec 2.6]. After the resolution, we get an exceptional divisor which is the sequence of \mathbb{P}^1 with negative self-intersection. In the table below we give the structure of the exceptional divisor and intersection pairing on the components of the exceptional divisor. We restrict to the case $m \leq 4$ needed in the paper. We also give formulas for the coordinates in the neighborhood of the exceptional divisor. The last column stands for the contribution in self-intersection and will be explained below.

Order	Action	Exceptional divisor	Intersection	$-d/m$
2	$F \mapsto \zeta_2 F, G \mapsto \zeta_2 G$	$(F^2, G/F) \text{ --- } (F/G, G^2)$	A_1	$-1/2$
3	$F \mapsto \zeta_3 F, G \mapsto \zeta_3 G$	$(F^3, G/F) \text{ --- } (F/G, G^3)$	(-3)	$-1/3$
3	$F \mapsto \zeta_3 F, G \mapsto \zeta_3^{-1} G$	$(F^3, G/F^2) \text{ --- } (F/G^2, G^3)$ $(F^2/G, G^2/F)$	A_2	$-2/3$
4	$F \mapsto \zeta_4 F, G \mapsto \zeta_4 G$	$(F^4, G/F) \text{ --- } (F/G, G^4)$	(-4)	$-1/4$
4	$F \mapsto \zeta_4 F, G \mapsto \zeta_4^{-1} G$	$(F^4, G/F^3) \text{ --- } (F/G^3, G^4)$ $(F^3/G, F^2/G^2) \text{ --- } (G^2/F^2, G^3/F)$	A_3	$-3/4$
4	$F \mapsto -F, G \mapsto \zeta_4 G$	$(F^2, G^2/F) \text{ --- } (F/G^2, G^4)$	A_1	$-1/2$

Table 4: Singularities

It appears that in some cases the resolution \tilde{Y} is not minimal, i.e. differs from representative of Painlevé family by additional blowup. In such case effective divisor $(-K)$ contains (-1) curves. After blowdown of these curves, we get the surface Y on which new Painlevé dynamics acts.

Example 3.2 (Continuation of Example 3.1). Consider folding transformation $2A_3 \subset E_7$ from the table in Section 2.5. According to this table the corresponding root variables should satisfy (for one of two irreducible components, see Remark 3.3)

$$a_1 = a_2 = a_3 = a_5 = a_6 = a_7 = i. \quad (3.4)$$

The action of the w is given by

$$w = s_{321765} : F \mapsto -iF, G \mapsto iG \quad (3.5)$$

where we used realization of the Weyl group given in Section 5.2. The order of w is 4. There are 4 fixed points in X , we list them in the Table 5. The meaning of the last column will be explained later, after identification with standard geometry.

sing. pt.	action	except. div.	Image
$(0, 0)$	$F \mapsto -iF, G \mapsto iG$	A_3	$\mathcal{E}_5 - \mathcal{E}_6, \mathcal{E}_6 - \mathcal{E}_7, \mathcal{E}_7 - \mathcal{E}_8$
$(0, \infty)$	$F \mapsto -iF, G^{-1} \mapsto -iG^{-1}$	(-4)	$\mathcal{H}_G - \mathcal{E}_{1234}$
$(\infty, 0)$	$F^{-1} \mapsto iF^{-1}, G \mapsto iG$	(-4)	$\mathcal{H}_G - \mathcal{E}_{5678}$
(∞, ∞)	$F^{-1} \mapsto iF^{-1}, G^{-1} \mapsto -iG^{-1}$	A_3	$\mathcal{E}_1 - \mathcal{E}_2, \mathcal{E}_2 - \mathcal{E}_3, \mathcal{E}_3 - \mathcal{E}_4$

Table 5: Singular points for the folding $2A_3 \subset E_7$

Now we proceed to geometry. It is easy to see that w permutes exceptional divisors E_1, E_2, E_3, E_4 and also E_5, E_6, E_7, E_8 hence in the Y' they will go to two (-1) curves.

Consider curves $FG = 1, FG = a_0$ which are components of the $(-K)$. Curves of the form $FG = const$ form a pencil with intersection 2 between each two curves. In the image of this pencil in \tilde{Y} such intersections

become 0, since we made resolution at points $(0, \infty)$ and $(\infty, 0)$. Hence, the images of curves $FG = \text{const}$ have self-intersection 0, for generic const . Therefore, the images of curves $FG = 1$, $FG = a_0$ have self-intersection -1 due to one additional blowup mentioned above.

It appears that images in \tilde{Y} of coordinate lines $F = 0$, $F = \infty$, $G = 0$, $G = \infty$ are also -1 divisors. This (and also previous) self-intersection could be calculated, using standard intersection theory results, which we review below, see formula (3.6).

The first two pictures in Fig. 5 represent X and \tilde{Y} . Here and below we draw fixed point $p \in X$ by black circles.

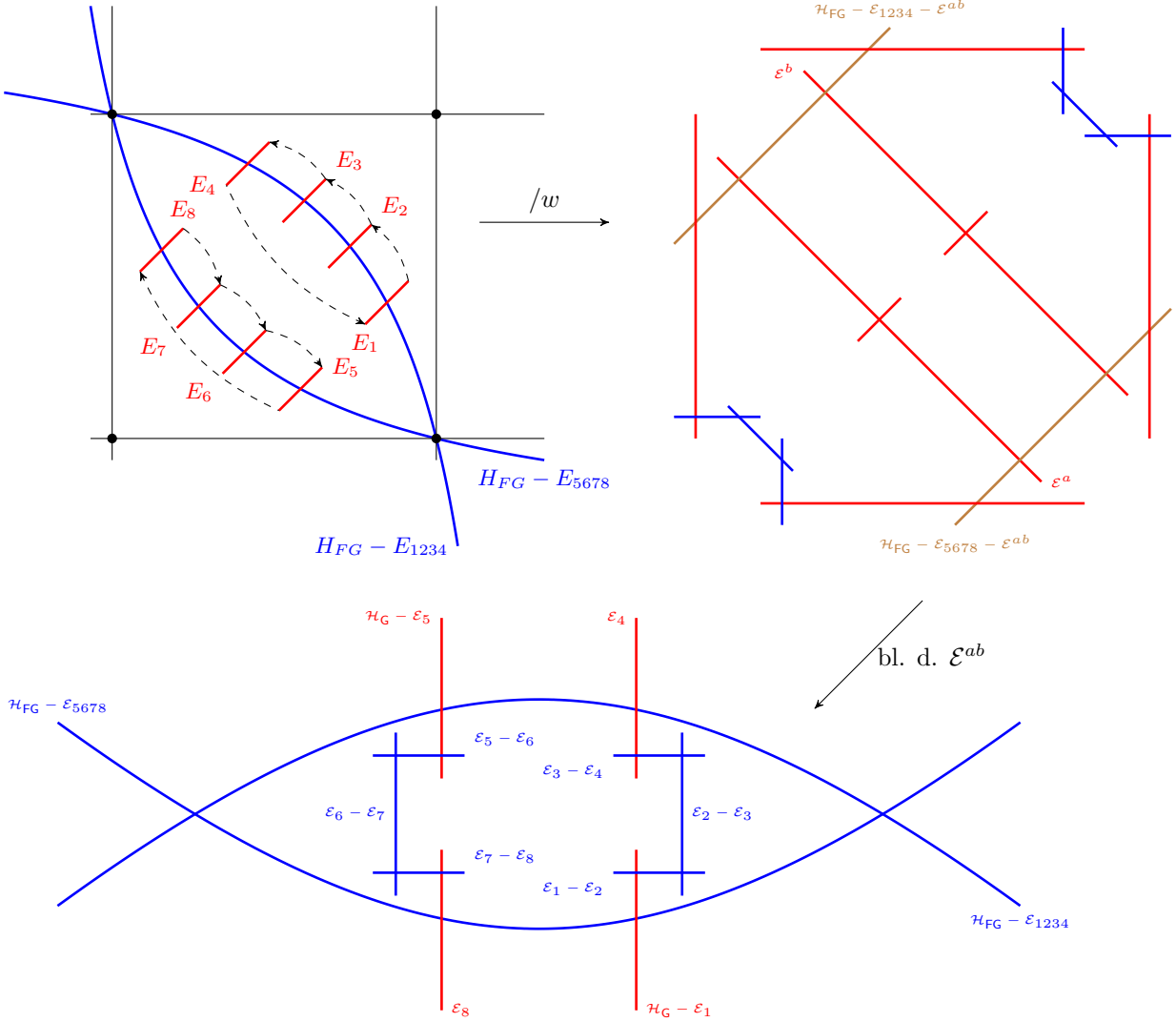

Figure 5: Geometry for the folding $2A_3 \subset E_7^{(1)}$

We see that anticanonical divisor on \tilde{Y} consists of 4 components which are (-4) , (-1) , (-4) , (-1) curves. The map $\tilde{Y} \rightarrow Y$ is blow down of these two (-1) curves. The picture for Y is the third picture on Fig. 5. On the surface Y the anticanonical divisor consists of two (-2) curves and has zero self-intersection, this is A_1 surface type. Hence we have folding transformation from $E_7^{(1)}/A_1^{(1)}$ q -Painlevé equation to itself.

Intersections and Standard geometry. We have constructed above the birational map $\psi: X \dashrightarrow Y$, such that $\psi(w(p)) = \psi(p)$ for any $p \in X$. Now we have to identify Y with $\mathcal{Y}_{\bar{a}}$ which is the member of some Painlevé family \mathcal{Y} .

The surface $\mathcal{Y}_{\tilde{\mathfrak{a}}}$ is defined through its blowup structure, namely choice of points $p_1, \dots, p_8 \in \mathbb{P}^1 \times \mathbb{P}^1$. The configuration of these points could be quite degenerate, including many infinitely near points. We follow [KNY17] in the description of blowup structure on Painlevé family and call the structure from loc. cit. a standard geometry. We recall necessary details in Section 5.

The choice of standard geometry leads to choice of the basis $\mathcal{E}_1, \dots, \mathcal{E}_8, \mathcal{H}_F, \mathcal{H}_G$, here F, G are some coordinates on Y , choice of them is part of the choice of standard geometry. The standard geometry is not unique. In order to have formulas for F, G simple it is natural to have $\mathcal{E}_1, \dots, \mathcal{E}_8, \mathcal{H}_F, \mathcal{H}_G$ as images of some natural divisors in X .

Let us recall basic statements of intersection theory which we will use below. Let $\psi': X \rightarrow Y'$ denotes the quotient map. This is a finite map of degree m , where m is order of w . Let C be a curve on X and D' be a curve on Y' such that we have relation in Picard group $[C] = (\psi')^*([D']) \Rightarrow \psi'_*([C]) = m[D']$. Due to push-pull formula (see e.g. [EH16]) we have relation on self-intersection $(D', D') = (C, C)/m$. Note that curve C should be w -invariant but not necessarily irreducible or reduced.

Let \tilde{D} denotes the proper transform of D' in \tilde{Y} . The self-intersection of \tilde{D} differs from self-intersection D' by contribution of exceptional divisor in \tilde{Y} . The last contributions are local and can be computed for example using toric description of resolution of singularities in [Ful93, Sec 2.6]. Here we present an answer, in order to do this we need some notations.

Let $x_i \in C$ be point which goes to singular point of Y' . Assume first for simplicity that x_i is w -invariant and action of w on C has order m . Then for certain primitive m -th root of unity ζ_m and integer d_i , $0 < d_i < m$ the w acts in vicinity of the point p with eigenvalue ζ_m in tangent to C direction and $\zeta_m^{d_i}$ in normal direction. Using these notations the contribution of the point x_i is $-d_i/m$.

In general x_i could be not invariant under the action. By w_i denote a power of w which preserves x_i . As was explained above w_i is either w or w^2 . Denote by m_i the order of w_i on C in vicinity of the point x_i . The number m_i could be smaller than the order of w_i , we denote $\text{ord}(w_i) = m_i m_i^\perp$. Then for certain primitive m_i -th root of unity ζ_{m_i} and integer d_i , $0 < d_i < m_i$ the w acts in vicinity of the point x_i with eigenvalue ζ_{m_i} in tangent to C direction and $(\zeta_{m_i}^{d_i/m_i^\perp})$ in normal direction. Using these notations the contribution of the point x_i is $-d_i/m_i$. Putting all this together we get the formula for self-intersection.

$$\tilde{D} \cdot \tilde{D} = \frac{1}{m} C \cdot C - \sum_{x_i} \frac{d_i}{m_i}. \quad (3.6)$$

We present these local contributions in the last column of Table 4.

Example 3.3 (Continuation of Examples 3.1, 3.2). Let C be one of the coordinate lines $F = 0$, It has self-intersection 0 and goes through two singular points, one of the is A_3 singularity and another one corresponds to (-4) curve. Hence the self-intersection of \tilde{D} is (-1) .

Let C be one of the curves $FG = 1$ or $FG = a_0$. The corresponding divisors on X are $H_{FG} - E_{1234}$ and $H_{FG} - E_{5678}$, so C has self-intersection (-2) . It goes through two singular points, each of them is A_3 singularity. Hence the self-intersection of \tilde{D} is (-1) .

In Table 6 we list w -invariant curves which are drawn in the figure. For each curve, we specify fixed points through which it goes and the corresponding tangent direction. As we computed above the images of these curves are (-1) curves, hence they are drawn red in Fig. 5.

Curve	$(0, 0)$	$(0, \infty)$	$(\infty, 0)$	(∞, ∞)	Image
$F = 0$	$dF = 0$	$dF = 0$	-	-	$\mathcal{H}_G - \mathcal{E}_5$
$F = \infty$	-	-	$dF^{-1} = 0$	$dF^{-1} = 0$	$\mathcal{H}_G - \mathcal{E}_1$
$G = 0$	$dG = 0$	-	$dG = 0$	-	\mathcal{E}_8
$G = \infty$	-	$dG^{-1} = 0$	-	$dG^{-1} = 0$	\mathcal{E}_4
$FG = 1$	-	$dF = dG^{-1}$	$dF^{-1} = dG$	-	$(\infty, 0)$
$FG = a_0$	-	$dF = a_0 dG^{-1}$	$dF^{-1} = a_0^{-1} dG$	-	$(0, \infty)$

Table 6: Invariant curves for the folding $2A_3 \subset E_7$

Now we can identify the standard geometry on Y . According to standard geometry components of the anticanonical divisor should be $\mathcal{H}_{FG} - \mathcal{E}_{1234}$ and $\mathcal{H}_{FG} - \mathcal{E}_{5678}$. We pick image of $G = 0$ to be \mathcal{E}_4 , image

$G = \infty$ to be \mathcal{E}_8 . Other exceptional divisors are reducible, this is because of many nodal curves in the Y , in the Fig. 5 we add names of these curves. We also add names of the components of an anticanonical divisor on \tilde{Y} . In the last columns of the Tables 5, 6 we write image in terms of the standard geometry on Y .

Remark 3.2. In order to describe standard geometry on Y we use certain simple w -invariant curves on X . The most typical example is the following. Let C be a rational curve with self-intersection by k . Assume that w acts on C as $z \mapsto \zeta_n z$, where z is some coordinate on C . In this case the formula (3.6) can be reproduced by the following elementary calculation.

Let us choose local coordinates (z, v_0) near $0 \in C$ and (z^{-1}, v_∞) near $\infty \in C$. We can assume that $v_\infty = v_0 z^{-k}$ since $C^2 = k$. Assume now that w acts on these coordinates as

$$w: z \mapsto \zeta_n z, v_0 \mapsto \zeta_n^{d_0} v_0, v_\infty \mapsto \zeta_n^{-d_\infty} v_\infty. \quad (3.7)$$

After the quotient C becomes rational curve with coordinate z^n . And after the resolution local coordinates near the images of fixed points are $(z^n, v_0 z^{-d_0})$ and $(z^{-n}, v_\infty z^{d_\infty})$. Since

$$v_\infty z^{d_\infty} = v_0 z^{-d_0} (z^n)^{-\frac{k-d_0-d_\infty}{n}} \quad (3.8)$$

the self intersection of \tilde{D} is $\frac{k-d_0-d_\infty}{n}$. This is consistent with formula (3.6).

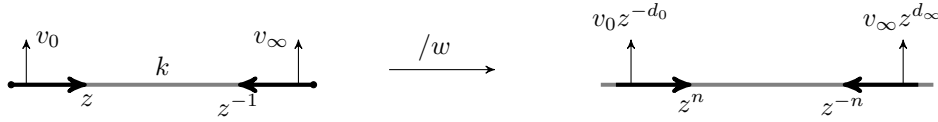

Let us mention another typical case. Let C^\sharp be rational curve with self-intersection k and assume that w acts on C^\sharp trivially. Then there is no singular points on D' , hence $\tilde{D} = D'$. But $(\psi')^*([D']) = n[C^\sharp] = [C]$. Hence $(\tilde{D})^2 = C^2/n = nk$.

Remark 3.3. One can take another irreducible component, namely instead of (3.4) we can set

$$a'_1 = a'_2 = a'_3 = a'_5 = a'_6 = a'_7 = -i. \quad (3.9)$$

But looking to the blowup scheme in Fig. 4 we see that surfaces $\mathcal{X}_{\bar{a}}$ and $\mathcal{X}_{\bar{a}'}$ are naturally isomorphic if $a'_0 = a_0$ and $a'_4 = a_4$. Moreover, this isomorphism intertwines orbits of the group $\langle w \rangle$ generated by w . So the geometry of the quotients $\mathcal{X}_{\bar{a}}/\langle w \rangle$ and $\mathcal{X}_{\bar{a}'}/\langle w \rangle$ coincide.

This can be stated more algebraically. Namely there is an element $n_{flip} = s_{1357}$ which belong to normalizer of $\langle w \rangle$, namely $n_{flip} w n_{flip}^{-1} = w^3$. The isomorphism between $\mathcal{X}_{\bar{a}}$ and $\mathcal{X}_{\bar{a}'}$ is given by $w n_{flip} \in W^{ae}$.

And this is always the case, if we have two different irreducible folding components in \mathcal{A}^w then there exists element n_{flip} in the normalizer of H which permutes these components. See the last column in tables in Sec. 4. So the folding transformation does not depend on an irreducible component in \mathcal{A}^w .

Coordinates and parameters. The next goal is to write down the map $\psi: X \dashrightarrow Y$ in coordinates. In other words we want to write down formulas

$$F = F(F, G), \quad G = G(F, G). \quad (3.10)$$

This is necessary for the study of explicit relation between solutions of the q -Painlevé equations. And also this provides some double check of the geometric answer obtained above.

It is convenient to find first the formulas for the pencils of the curves $F = \text{const}$ and $G = \text{const}$. Curves from such pencils should be w -invariant and from the geometry, we can compute their degrees and properties which determines the pencils. The structure of the pencil determines formulas for F, G up to Möbius transformation, as automorphisms of $\mathbb{P}^1 \times \mathbb{P}^1$ on the image.

We find multiplicative root variables parameters \mathbf{a}_i on Y using formulas for coordinates F, G . They always are products of some powers of the initial multiplicative root variables a_i .

Example 3.4 (Continuation of Examples 3.1, 3.2, 3.3). Consider first pencils of curves $F = \text{const}$ and $G = \text{const}$ on X . We claim that

$$\psi_*(H_F) = \mathcal{H}_F + 5\mathcal{H}_G - \mathcal{E}_{12345678}, \quad \psi_*(H_G) = \mathcal{H}_F + \mathcal{H}_G. \quad (3.11)$$

Indeed, it follows from the geometry (see image columns in Tables 5, 6) that

$$\psi_*(H_F) \cdot \mathcal{E}_4 = \psi_*(H_F) \cdot \mathcal{E}_8 = 1, \quad \psi_*(H_F) \cdot (\mathcal{H}_G - \mathcal{E}_1) = \psi_*(H_F) \cdot (\mathcal{H}_G - \mathcal{E}_5) = 0 \quad (3.12)$$

$$\psi_*(H_F) \cdot (\mathcal{E}_1 - \mathcal{E}_2) = \psi_*(H_F) \cdot (\mathcal{E}_2 - \mathcal{E}_3) = \psi_*(H_F) \cdot (\mathcal{E}_3 - \mathcal{E}_4) = 0 \quad (3.13)$$

$$\psi_*(H_F) \cdot (\mathcal{E}_5 - \mathcal{E}_6) = \psi_*(H_F) \cdot (\mathcal{E}_6 - \mathcal{E}_7) = \psi_*(H_F) \cdot (\mathcal{E}_7 - \mathcal{E}_8) = 0, \quad (3.14)$$

$$\psi_*(H_F) \cdot (\mathcal{H}_F + \mathcal{H}_G - \mathcal{E}_{1234}) = \psi_*(H_F) \cdot (\mathcal{H}_F + \mathcal{H}_G - \mathcal{E}_{5678}) = 2. \quad (3.15)$$

From this intersections we get the formula (3.11) for $\psi_*(H_F)$. As a double-check note that by push-pull formula the self-intersection of $\psi'_*(H_F)$ is zero and after blowdown of \mathcal{E}^{ab} (see Fig. 5) the self-intersection of $\psi_*(H_F)$ will be 2, this is consistent with formula (3.11).

Similarly we have

$$\psi_*(H_G) \cdot (\mathcal{H}_G - \mathcal{E}_1) = \psi_*(H_G) \cdot (\mathcal{H}_G - \mathcal{E}_5) = 1, \quad \psi_*(H_G) \cdot \mathcal{E}_4 = \psi_*(H_G) \cdot \mathcal{E}_8 = 0, \quad (3.16)$$

$$\psi_*(H_G) \cdot (\mathcal{E}_1 - \mathcal{E}_2) = \psi_*(H_G) \cdot (\mathcal{E}_2 - \mathcal{E}_3) = \psi_*(H_G) \cdot (\mathcal{E}_3 - \mathcal{E}_4) = 0 \quad (3.17)$$

$$\psi_*(H_G) \cdot (\mathcal{E}_5 - \mathcal{E}_6) = \psi_*(H_G) \cdot (\mathcal{E}_6 - \mathcal{E}_7) = \psi_*(H_G) \cdot (\mathcal{E}_7 - \mathcal{E}_8) = 0, \quad (3.18)$$

$$\psi_*(H_G) \cdot (\mathcal{H}_F + \mathcal{H}_G - \mathcal{E}_{1234}) = \psi_*(H_G) \cdot (\mathcal{H}_F + \mathcal{H}_G - \mathcal{E}_{5678}) = 2. \quad (3.19)$$

This leads to the formula (3.11) for $\psi_*(H_G)$. As a double-check, we can compute that self-intersection of $\psi_*(H_G)$ is 2, this is consistent with formula (3.11).

Now return to the curves given by $F = \text{const}$ and $G = \text{const}$ in X . From the formula (3.11) we know intersections of $\psi_*(H_F), \psi_*(H_G)$ with \mathcal{H}_F and \mathcal{H}_G . Using this we conclude that $F = \text{const}$ should be $(1, 5)$ curve and $G = \text{const}$ should be $(1, 1)$ curve. We claim that

$$\psi^*(\mathcal{H}_F) = H_F + 5H_G - E_{12345678}, \quad \psi^*(\mathcal{H}_G) = H_F + H_G \quad (3.20)$$

Indeed, on the surface Y curves $G = \text{const}$ intersect each component of $-K_Y$ in one point. Therefore curves $G = \text{const}$ on X intersect hyperbolas $FG = 1$ and $FG = a_0$ in two points $(0, \infty)$ and $(\infty, 0)$, hence do not contain exceptional divisors, so we get formula (3.20) for $\psi^*(\mathcal{H}_G)$. Similarly, the curves $F = \text{const}$ on X intersect hyperbolas $FG = 1$ and $FG = a_0$ in two points $(0, \infty)$ and $(\infty, 0)$, but since they are $(1, 5)$ curves they should contain exceptional divisors. Due to w -invariance the only choice is given by the formula (3.20).

The formulas (3.20) can be also deduced (or checked) computing self-intersection. Namely, note that the curves $F = \text{const}$ and $G = \text{const}$ on X goes through two singular points with $d_i = 1$ and in the image have self-intersection 0. Therefore on X such curves have self-intersection 2 (using (3.6)). This and w -invariance give formulas (3.20).

Now we can write formula for the pencils $F = \text{const}$ and $G = \text{const}$. The first one consist of $(1, 1)$ curves which are w -invariant and go through $(0, \infty)$ and $(\infty, 0)$. This determines the 1-parameter family

$$c_1FG - c_2 = 0, \quad (3.21)$$

where c_1, c_2 are complex constants. The second pencil consist of $(1, 5)$ curves which go through $(0, \infty)$ and $(\infty, 0)$ and intersect all exceptional divisors E_1, \dots, E_8 . This determines the 1-parameter family

$$c_1(FG - a_0)(G^4 - 1) - c_2(FG - 1)(G^4 - a_4^{-4}) = 0, \quad (3.22)$$

where c_1, c_2 are complex constants (recall that root variables are subject of (3.4)).

The final formulas for F and G are ratios of two equations from the families above. They are determined by the properties that curves $FG - 1, FG - a_0, G = \infty$ go to $(\infty, 0), (0, \infty)$ and $(1, 1)$ correspondingly. We get formulas (3.23).

It remain to find root variables on the image. Since on the image we have effective divisors $\mathcal{E}_1 - \mathcal{E}_2, \mathcal{E}_2 - \mathcal{E}_3, \mathcal{E}_3 - \mathcal{E}_4$ the blowup points p_1, p_2, p_3, p_4 on the image are infinitely near points. Hence $\mathbf{a}_1 = \mathbf{a}_2 =$

$\mathfrak{a}_3 = 1$. Similarly $\mathfrak{a}_5 = \mathfrak{a}_6 = \mathfrak{a}_7 = 1$. Since curve $G = 0$ goes to \mathcal{E}_8 we see from formulas (3.23) that $p_8 = (a_0 a_4^4, a_0^{-1})$. Hence $\mathfrak{a}_0 = a_4^4$ and $\mathfrak{a}_4 = a_0$. We put these root variables in the diagram below.

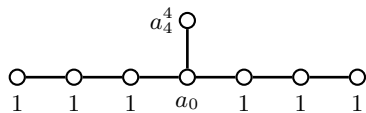

$$\begin{aligned} F &= \frac{FG - a_0}{FG - 1} \frac{G^4 - 1}{G^4 - a_4^{-4}}, \\ G &= \frac{FG - 1}{FG - a_0}. \end{aligned} \quad (3.23)$$

Finally, after defining geometry on the image for all foldings transformations, we should check, that foldings with the same order and the same symmetry/surface type both in the image and in the preimage are not equivalent. Such groups of foldings appear iff their finitizations \bar{w} are conjugated (see Remark 3.6). It appears that these groups have also the same nodal root subsystem Φ_{nod} . But $\bar{\Phi}_{\text{nod}}$ appear to be different for them, so we take $\bar{\Phi}_{\text{nod}}$ as distinguishing invariant.

3.3 Nodal curves and symmetries on image

Symmetries on the image from nodal root systems. Let us define *special symmetry lattice* — root sublattice in root lattice Φ^a , orthogonal to the nodal curves Δ_{nod} : $Q^{\text{sym}} = (\alpha \in Q^a | (\alpha, \Delta_{\text{nod}}) = 0)$.

Assume that Q^{sym} is generated by certain (affine) root subsystem Φ^{sym} . Then we can calculate symmetries of our special subfamily $Y_{\bar{\mathfrak{a}}}$ analogously to Prop. 2.1. Indeed, our special configuration is defined by Δ_{nod} , so we should take only those elements from W^{ae} in the image Y , that preserve Δ_{nod} , as well as its orthogonal special symmetry lattice Φ^{sym} . So we have

$$\text{Sym}(Y_{\bar{\mathfrak{a}}}) = \text{Aut} \times W_{\Phi^{\text{sym}}} = (\text{Aut}^{\text{sym}} \times W_{\Phi^{\text{sym}}}) \times \text{Aut}^{\text{nod}}, \quad (3.24)$$

where $\text{Aut} = \text{Aut}^{\text{sym}} \times \text{Aut}^{\text{nod}}$ for automorphism subgroups $\text{Aut}^{\text{nod}} \subset \text{Aut}(\Delta_{\text{nod}})$ and $\text{Aut}^{\text{sym}} \subset \text{Aut}(\Phi^{\perp, \text{nod}}) \times \text{Aut}(\Delta_{\text{nod}})$, the latter acts effectively on Φ^{sym} . Note that automorphisms $\text{Aut}(\Delta_{\text{nod}})$ is only permutations. As in the algebraic case, this is subgroups, that are realized in symmetry group W^{ae} of subfamily $Y_{\bar{\mathfrak{a}}}$.

Remark 3.4. There are some peculiarities about sublattice Q^{sym} . Namely, for $E_3^{(1)}$ and $E_1^{(1)}$ cases there sublattices could be realized only by long root system $\Phi^{\perp, \text{nod}}|_{|\alpha|^2=2n}$, where n is the order of folding. Then we should find reflections by hands and they could act on Δ_{nod} . Even more problems we occur for folding transformations π^3 and π^2 for $E_3^{(1)}$. In this case elementary long root system simple reflections cannot be realized in W^{ae} , that's why it is convenient to take instead of Q^{sym} its sublattice with imaginary root 2δ and 3δ respectively. Cf. Remark 2.4 from the preimage side.

Remark 3.5. In the special configuration $\bar{\mathfrak{a}}$ in the image we can also have projective reduction and it could be found in the same way, as in the preimage. I.e., \mathfrak{q} should be some full power of root variables \mathfrak{a} and projective reduction should be translation in the special symmetry root subsystem Φ^{sym} and non-trivial permutation of Δ^{nod} .

Example 3.5 (Continuation of Examples 3.1 - 3.4). On the Fig. 5 we see 6 nodal curves, which form two A_3 root systems, consisting from $\alpha_3 = \mathcal{E}_1 - \mathcal{E}_2$, $\alpha_2 = \mathcal{E}_2 - \mathcal{E}_3$, $\alpha_1 = \mathcal{E}_3 - \mathcal{E}_4$ and $\alpha_5 = \mathcal{E}_5 - \mathcal{E}_6$, $\alpha_6 = \mathcal{E}_6 - \mathcal{E}_7$, $\alpha_7 = \mathcal{E}_7 - \mathcal{E}_8$. Root variables \mathfrak{a}_0 and \mathfrak{a}_4 are free, so, according to Prop. 3.1 there are no other irreducible nodal curves. Extended nodal root subsystem equals to the nodal root subsystem $\bar{\Phi}_{\text{nod}} = \Phi_{\text{nod}} = 2A_3$.

It is easy to see that $\Phi^{\text{sym}} = A_1^{(1)}$, generated by α_0 and δ . Special symmetry and nodal root subsystems as well as its automorphisms are represented by left and right pictures on Fig. 6. Calculation gives, that Aut^{nod} , Aut^{sym} are commuting C_2 , generated by π and $\pi s \pi s^{-1}$ for $s = s_{4354} s_{2132}$ respectively⁷. So symmetry on the image will be $C_2 \times W_{A_1}^{ae}$, this is written at the right side of Fig. 6.

We have $\mathfrak{q} = 2.5_0^2 2.5_4^4 = (2.5_0 2.5_4^2)^2$ and the elementary translation in special symmetry lattice is given by $\alpha_0 = 2\omega_0 - \omega_4$ so one can expect existence of the translation by fundamental weight. We have projective reduction $t_{2\omega_0 - \omega_4}^{1/2}$:

$$t_{2\omega_0 - \omega_4}^{1/2} = s^{-1} \pi s \pi s_0, \quad (3.25)$$

⁷On the Fig. 6 we pictured action on nodal root subsystem of $s \pi s^{-1}$ instead of s for simplicity.

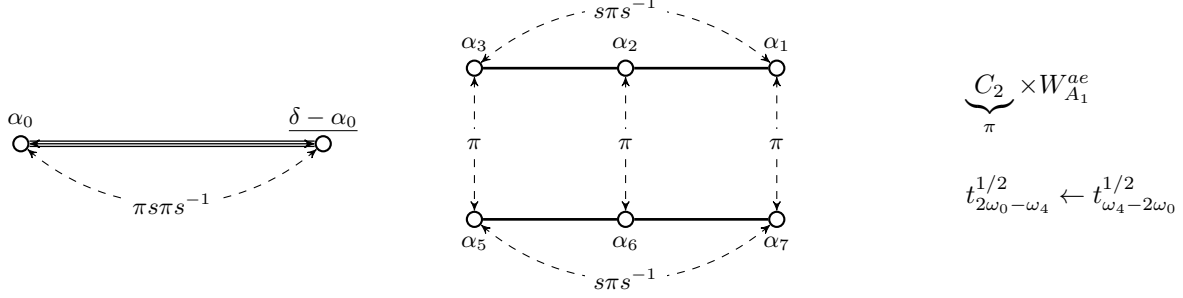

Figure 6: Special symmetry and nodal root subsystems for the image of $2A_3 \subset E_7^{(1)}$

which non-trivially permute nodal curves. We see that it corresponds to the projective reduction $t_{\omega_4 - 2\omega_0}^{1/2}$ in the preimage due to $\mathbf{a}_0 = \mathbf{a}_4^4, \mathbf{a}_4 = a_0$ and $\mathbf{q} = q^2$. We will talk systematically about correspondence in the image and preimage in the coming paragraph. Such correspondence is also written on the right side of Fig. 6.

Note that configuration of root variables in the preimage and in the image are similar: $a_{1,2,3,5,6,7} = i$ vs. $\mathbf{a}_{1,2,3,5,6,7} = 1$, that is why Fig. 3 and 6 coincide (cf. Remark 3.7).

Relation to centralizer in the preimage. Finally, let us connect symmetries $\text{Sym}(Y_{\bar{\alpha}})$ in the image and centralizer $C(w, W^{ae})$ in the preimage for folding transformation w of order n . We have map $\psi_* = C(w, W^{ae}) \mapsto \text{Sym}(Y_{\bar{\alpha}})$, which is not injective, because at least folding subgroup $\langle w \rangle$ becomes trivial. It appears, that in several cases it is even not surjective, see below. Connection between centralizer and symmetry in the image is done by such steps:

1. Let $\alpha \in \Phi^{\text{sym}}$ be a root. Then we have $|\psi_*^{-1}(\alpha)|^2 = n|\alpha|^2$, due to push-pull formula. So we take in the preimage “long” root subsystem $\Phi_{long}^{a,w} \subset Q^{a,w}$ with $|\alpha|^2 = 2n$ (or $|\alpha|^2 = 2ln$, where $2l$ is a length of special symmetry root subsystem in the image) instead of $\Phi^{a,w}$. Type of this long root subsystem should coincide with special symmetry root subsystem in the image. We choose simple roots of this long root subsystem in a way that root variables of $\Phi_{long}^{a,w}$ equal to the corresponding root variables of Φ^{sym} in the image ⁸.
2. Then we isomorphically rewrite $C(w, W)$ in the form of (2.30), but for long $\Phi_{long}^{a,w}$. A common situation is that reflections in short invariant root subsystem become outer automorphisms of long invariant root subsystem and vice versa. Groups of automorphisms Aut^{\parallel} and Aut^{sym} also should become the same.
3. Check, what elements of $(\text{Aut}^{\perp} \times W_{\Phi^{a,\perp w}})^w$ act non-trivially on the image (their image belongs to Aut^{nod}). That could be done using explicit coordinates $(F(F, G), G(F, G))$.
4. If there are additional symmetries $\text{Sym}(Y_{\bar{\alpha}})$, which do not come from $C(w, W)$, then they act trivially on initial coordinates and root variables. From the point of view of coordinates, this means that formulas for $F(F, G), G(F, G)$ contain fractional powers of root variables (or(and) roots of unity) and such symmetries occur from their branching (or Galois group). Such symmetries belong to Aut^{nod} , so they permute nodal curves and corresponding fixed points in the preimage.
5. Finally, we can check the correspondence ψ_* explicitly. Namely, for $w \in \text{Aut}^{\parallel} \times W_{\Phi^{a,w}}^a$ and $\mathbf{w} = \psi_*(w) \in \text{Aut}^{\text{sym}} \times W_{\Phi^{\perp, \text{nod}}}$ we should have

$$\mathbf{w}(\vec{\alpha})(\vec{a}) = \vec{\alpha}(w(\vec{a})), \quad \mathbf{w}(F, G)(\vec{a}, F, G) = (F, G)(w(\vec{a}), w(F), w(G)). \quad (3.26)$$

Automorphism group Aut^{sym} is defined up to Aut^{nod} , the latter formula fix this freedom. We also should relate nontrivial $(\text{Aut}^{\perp} \times W_{\Phi^{a,\perp w}})^w$ to the subgroup of Aut^{nod} in similar manner.

In fact this is non-trivial double-check both for calculation of $C(w, W)$ and $\text{Sym}(Y_{2,3})$.

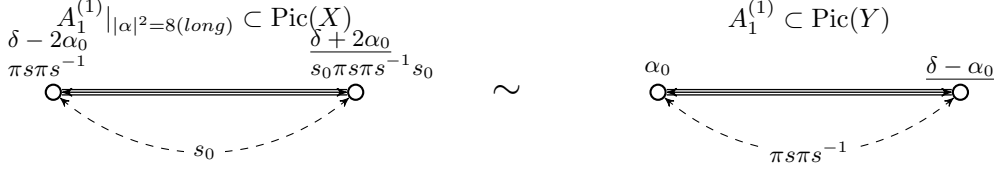

Figure 7: Relation between symmetries in image and preimage

Example 3.6 (Continuation of Examples 3.1 - 3.5). Here we compare symmetry from Fig. 6 with centralizer (2.31):

1. We should take root subsystem in $Q^{a,w}$ with roots $|\alpha|^2 = 8$, so $Q_{long}^{a,w} \subset 2\alpha_0, \delta$. To match root variables $\mathbf{a}_0 = a_4^4$ and $\chi(\delta - \alpha_0) = a_{04}^4$ in the image, we should take simple roots $\delta - 2\alpha_0, \delta + 2\alpha_0$, see Fig. 7. Note that imaginary root become 2δ instead of δ .
2. $W_{\Phi^{a,w}}^{ae} \simeq W_{\Phi_{long}^{a,w}}^{ae}$, s_0 becomes outer automorphism, $\pi s \pi s^{-1}$ becomes reflection.
3. $\Omega_{A_3}^2$ act trivially on the image, $\pi s_1 s_3 s_5 s_7$ — non-trivially.
4. We have no such additional symmetries.
5. Changing root variables symmetry generators in image and preimage correspond to each other by superimposition of left and right pictures of Fig. 7:

$$\psi_*(\pi s \pi s^{-1}) = s_0, \quad \psi_*(s_0) = \pi s \pi s^{-1}. \quad (3.27)$$

Also we have $\psi_*(\pi s_1 s_3 s_5 s_7) = \pi$.

Generator π is folding in the image and provide further extension of folding group C_4 to $C_2 \times C_4 = \text{Dih}_4^{(2)}$

⁸For a few cases, up to exponentiation to a common power.

3.4 Answers

Sym./surf.	Diagram	Name	Order	Goes to	$\overline{\Phi}_{\text{nod}}$	Symmetry	Sect.
$E_8^{(1)}/A_0^{(1)}$		$3A_2$	3	$E_6^{(1)}/A_2^{(1)}$	$2A_2$	$C_2 \times W_{A_2}^a$	5.1.1
		$4A_1$	2	$E_7^{(1)}/A_1^{(1)}$	$3A_1$	$S_3 \times W_{D_4}^a$	5.1.2
		$A_1 + 2A_3$	4	$D_5^{(1)}/A_3^{(1)}$	$A_3 + A_1$	$W_{A_1}^a$	5.1.3
$E_7^{(1)}/A_1^{(1)}$		π	2	$E_8^{(1)}/A_0^{(1)}$	D_4	$S_3 \times (C_2^2 \times W_{D_4}^a)$	5.2.1
		$3A_1$			$4A_1$	$S_4 \times W_{D_4}^a$	5.2.2
		$4A_1$	2	$D_5^{(1)}/A_3^{(1)}$	$2A_1$	$C_2^2 \times W_{A_3}^a$	5.2.3
		$3A_2$	3	$E_3^{(1)}/A_5^{(1)}$	A_2	$W_{A_1}^{ae}$	5.2.4
		$2A_3$	4	$E_7^{(1)}/A_1^{(1)}$	$2A_3$	$C_2 \times W_{A_1}^{ae}$	5.2.5
		$\pi \times 5A_1$			D_6	$C_2^2 \times W_{A_1}^a$	5.2.6
$E_6^{(1)}/A_2^{(1)}$		π	3	$E_8^{(1)}/A_0^{(1)}$	E_6	$C_2 \times (S_3 \times W_{A_2}^a)$	5.3.1
		$2A_2$			$3A_2$	$S_3 \times W_{A_2}^a$	5.3.2
		$4A_1$	2	$E_3^{(1)}/A_5^{(1)}$	A_1	$W_{A_2}^{ae}$	5.3.3
$D_5^{(1)}/A_3^{(1)}$		π^2	2	$E_7^{(1)}/A_1^{(1)}$	D_4	$S_3 \times (C_2^2 \times (C_2 \times W_{3A_1}^a))$	5.4.1
		$2A_1$			$4A_1$	$(S_3 \times C_2^3) \times W_{3A_1}^a$	5.4.2
		π	4	$E_8^{(1)}/A_0^{(1)}$	E_7	$C_2^2 \times W_{A_1}^a$	5.4.3
		$A_1 + A_3$			$2A_3 + A_1$	$W_{A_1}^{ae}$	5.4.4
		$\pi^2 \times 3A_1$	2	$A_1^{(1)}/A_7^{(1)'} $	$D_6 + A_1$	$C_2^2 \times W_{A_1}^a$	5.4.5
		$4A_1$			0	$C_2 \times (C_4 \times W_{A_1}^a)$	5.4.6
$E_3^{(1)}/A_5^{(1)}$		π^3	2	$E_6^{(1)}/A_2^{(1)}$	D_4	$C_2^2 \times W_{A_2}^{ae} (2\delta)$	5.5.1
		A_1			$4A_1$	$W_{A_2}^{ae}$	5.5.2
		π^2	3	$E_7^{(1)}/A_1^{(1)}$	E_6	$S_3 \times W_{A_1}^{ae}, (3\delta)$	5.5.3
		A_2			$3A_2$	$W_{A_1}^{ae}$	5.5.4
$A_1^{(1)}/A_7^{(1)'} $		π^2	2	$D_5^{(1)}/A_3^{(1)}$	D_4	$C_2^2 \times W_{A_1}^a$	5.7.1
		σ			$4A_1$	$C_4 \times W_{A_1}^a$	5.7.2

Detailed calculations are given in Section 5. Using calculations for cyclic foldings, we can calculate data for non-cyclic groups

Sym./surf.	Diagram	Name	Group	Goes to	$\overline{\Phi}_{\text{nod}}$
$E_7^{(1)}/A_1^{(1)}$		$\pi \times 5A_1$	$\text{Dih}_4^{(1)}$	$E_8^{(1)}/A_0^{(1)}$	$D_5 + 2A_1$
		$\pi \times 2A_3$	$\text{Dih}_4^{(2)}$	$E_8^{(1)}/A_0^{(1)}$	$D_4 + A_3$
		$\pi \times 4A_1$	$C_2^2 \subset \text{Dih}_4^{(1,2)}$	$E_7^{(1)}/A_1^{(1)}$	$D_4 + A_1$
		$5A_1$	$C_2^2 \subset \text{Dih}_4^{(1)}$	$E_7^{(1)}/A_1^{(1)}$	$A_3 + 2A_1$
$D_5^{(1)}/A_3^{(1)}$		$\pi^2 \times 4A_1$	C_2^3	$E_7^{(1)}/A_1^{(1)}$	$D_4 + 2A_1$
		$4A_1$	$C_2^2 \subset C_2^3$	$D_5^{(1)}/A_3^{(1)}$	$4A_1$
		$\pi^2 \times 4A_1$	$C_2^2 \subset C_2^3$	$D_5^{(1)}/A_3^{(1)}$	D_4
		$\pi^2 \times 2A_1$	$C_2^2 \subset C_2^3$	$E_8^{(1)}/A_0^{(1)}$	$D_4 + 2A_1$
$E_1^{(1)}/A_7^{(1)}$		$\pi^2 \times \sigma$	C_2^2	$E_7^{(1)}$	$D_4 + 2A_1$

Remark 3.6. It is remarkable, that folding transformations with conjugated finitizations \bar{w} always go to the same symmetry/surface type. We spotted that from answers above case by case, however, we have no explanation of this phenomenon.

Remark 3.7. We have a lots of pairs foldings transformations w_1, w_2 going in “opposite direction”:

$$\begin{aligned} w_1 : E_{m_1}^{(1)} \xrightarrow{n} E_{m_2}^{(1)} : \mathcal{A}_{w_1}(\zeta_n) &\mapsto \mathcal{A}_{w_2}(1) \\ w_2 : E_{m_2}^{(1)} \xrightarrow{n} E_{m_1}^{(1)} : \mathcal{A}_{w_2}(\zeta_n) &\mapsto \mathcal{A}_{w_1}(1). \end{aligned} \quad (3.28)$$

Here $\mathcal{A}_{w_{1,2}}(\zeta_n)$ denotes irreducible component of the folding invariant subset. In particular $\mathcal{A}_{w_{1,2}}(1)$ is component on which corresponding folding acts trivially.

In particular in folding transformation in Example 3.5 is opposite to itself.

4 Folding transformation: lattices, normalizers and components

4.1 $E_8^{(1)}/A_0^{(1)}$

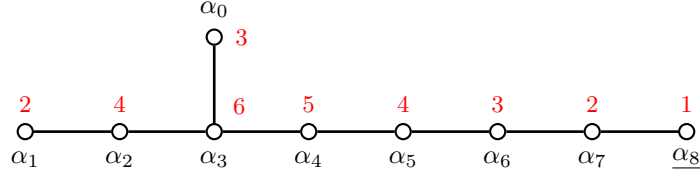

Figure 8: Root numbering and marks for $E_8^{(1)}$ Dynkin diagram

For $E_8^{(1)}$ we have only case 2 foldings: of order 3, of order 4, and (conjugated to) its square of order 2. We start from folding of order 3 on which we explain our notations.

Folding	$Q^{a,w}$	$Q^{a,\perp w}$	$C(w)$	A^w, N_{flip}
<p>$w = s_{215487}$</p>	<p>$A_2^{(1)}$</p> <p>$\underline{\alpha_{012233435363728}}$</p> <p>$(A_2^{(1)}) _{ \alpha ^2=6}$</p> <p>$\alpha_{12233425}$</p> <p>$s_{324}s_{135}s_{423}$</p> <p>$\underline{\alpha_{45263728}}$ $\alpha_{0312233425}$</p> <p>$s_{675}s_{468}s_{576}$ $s_{0324}s_{135}s_{4230}$</p> <p>$t_{\omega_1, A_2 + \omega_2}^{A_2} \sim t_{\omega_3 - 2\omega_6}^{1/3}$</p>	<p>$3A_2$</p> <p>$s_{675}s_{468}s_{576}$</p> <p>$s_{324}s_{135}s_{423}$</p>	<p>$S_3 \times (W_{A_2}^a \times \underbrace{C_3^3}_{triv})$</p> <p>$\simeq C_2 \times (W_{A_2}^a \times \underbrace{C_3^3}_{triv})$</p> <p>$\downarrow$</p> <p>$C_2 \times W_{A_2}^a$</p> <p>$t_{\omega_3 - 2\omega_6}^{1/3} \rightarrow t_{\omega_4 - 2\omega_5}$</p> <p>(5.4)</p>	<p>s_{147}</p>

- By dashed arrows we denote the action of Aut. By underline we denote our choice of the affine root.
- In the second column for roots of length $|\alpha|^2 = 6$, under the decomposition of given root in terms of simple ones we write corresponding element from W^{ae} , which realizes reflection in such root. At the bottom of this column, we write projective reduction occurs and corresponding translation in Weyl group of $\Phi^{a,w}|_{|\alpha|^2=6}$.
- In the fourth column we write two centralizers with respect to short and long (l) $\Phi^{a,w}$, write image of centralizer after folding matching elements, which go to trivial in the image. We also write the

image of projective reduction after folding. Note that the image of the centralizer is found from the coordinates, found in Section 5.

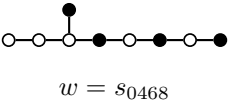
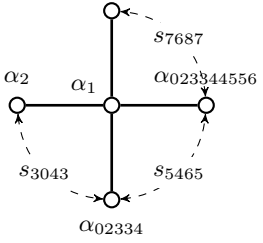
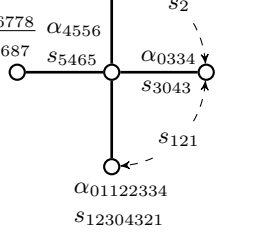
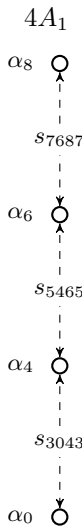
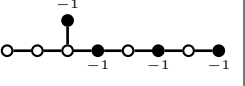
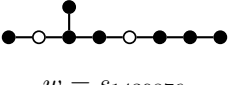
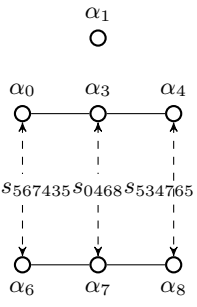
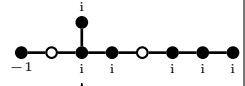
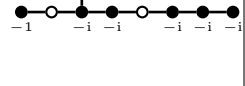
Folding	$Q^{a,w}$	$Q^{a,\perp w}$	$C(w)$	\mathcal{A}^w, N_{flip}
 <p>$w = s_{0468}$</p>	<p>$D_4^{(1)}$</p> <p>$\alpha_{0233445566778}$</p>  <p>$(D_4^{(1)}) _{ \alpha ^2=4}$</p> <p>$\alpha_{022334}$ s_{230432}</p>  <p>$\alpha_{01122334}$ $s_{12304321}$</p> <p>$t_{\omega_{\alpha_{022334}} + \omega_{\alpha_{0324}} + \omega_{\alpha_{0122334}} - \omega_{\alpha_{4526}}} \sim t_{\omega_3 - \omega_{57}}^{1/2}$ $t_{\omega_{\alpha_{4556}}} \sim t_{\omega_5 - 2\omega_7}^{1/2}$</p>	<p>$4A_1$</p>  <p>α_8 s_{7687} α_6 s_{5465} α_4 s_{3043} α_0</p>	<p>$S_4 \times (W_{D_4}^a \times \underbrace{C_2^4}_{triv})$ $\simeq S_3 \times (W_{D_4}^a \times \underbrace{C_2^4}_{triv})$</p> <p>$\downarrow$</p> <p>$S_3 \times W_{D_4}^a$</p> <p>$t_{\omega_3 - \omega_{57}}^{1/2} \rightarrow t_{\omega_3 - \omega_{12}}$ $t_{\omega_5 - 2\omega_7}^{1/2} \rightarrow t_{\omega_2 - 2\omega_1}$</p> <p>(5.7)</p>	 <p>-1</p>
 <p>$w = s_{1430876}$</p>	<p>$A_1^{(1)}$</p> <p>$\alpha_{0122334} \quad \delta - \alpha_{0122334}$</p> <p>$s_{567435} s_{0468} s_{534765}$</p> <p>$(A_1^{(1)}) _{ \alpha ^2=8}$</p> <p>$2\alpha_{0122334}$ $s_{\alpha_{0122334}}$</p> <p>$\delta - 2\alpha_{0122334}$ $s_{567435} s_{0468} s_{534765}$</p> <p>$t_{\omega_{2\alpha_{0122334}}} \sim t_{\omega_2 - \omega_5}^{1/2}$</p>	<p>$A_1 + 2A_3$</p>  <p>α_1 α_0 α_3 α_4 $s_{567435} s_{0468} s_{534765}$ α_6 α_7 α_8</p>	<p>$C_2 \times (W_{A_1}^a \times \underbrace{(C_2 \times C_4^2)}_{triv})$ $\simeq W_{A_1}^a \times \underbrace{(C_2 \times C_4^2)}_{triv}$</p> <p>$\downarrow$</p> <p>$W_{A_1}^a$</p> <p>$t_{\omega_2 - \omega_5}^{1/2} \rightarrow t_{\omega_2 - \omega_0}$</p> <p>(5.10)</p>	 <p>i</p> <p>s_{0468}</p> <p>$-i$</p>  <p>-1 $-i$ $-i$ $-i$ $-i$ $-i$</p>

4.2 $E_7^{(1)}/A_1^{(1)}$

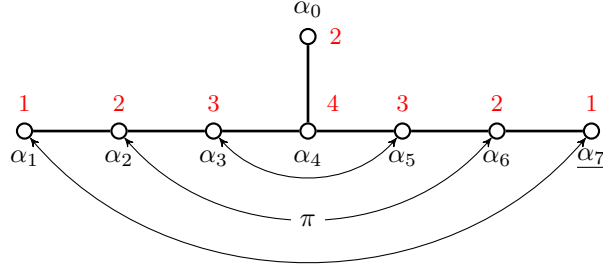

Figure 9: Root numbering and marks for $E_7^{(1)}$ Dynkin diagram

Affine Weyl group $W(E_7^{(1)})$ (and corresponding Dynkin diagram) has outer automorphism of order 2^9 . For $E_7^{(1)}$ we have 6 foldings:

- Two foldings of order 2, of case 1 and 2, which have common (up to conjugation) \bar{w} .
- Two foldings of order 4, of case 2 and 3, which have common (up to conjugation) \bar{w} .
- Folding of order 2, of case 2, which is (up to conjugation) square of both foldings of order 4.
- Folding of order 3, of case 2.



Several new notations and peculiarities appear here in comparison with $E_8^{(1)}$ case.

- Here appear foldings which have conjugated finitization \bar{w} . This is reflected in the first column, where we wrote decomposition of w into translational and finite parts and write conjugation of \bar{w} explicitly. Due to Lemma 2.11 invariant lattices $Q^{a,w}$ are of the same type.
- We denote by $w_0(S_n)$ longest element of Weyl group S_n
- In the \mathcal{A}_w arrow with “=” means, that corresponding root variables equal (we write one “=” for several arrows for simplicity)
- In case $3A_2$ we have no short invariant lattice, we immediately obtain long lattice. For the next cases, one finds more such examples.
- In case $\pi \times 5A_1$ we have $Q^{a,\perp w}$ generated by $\alpha_0, \alpha_1, \alpha_3, \alpha_5, \alpha_7$ and $\alpha_2 - \alpha_6$. This sublattice is not generated by any root subsystem, this is inconvenient, so instead we take its sublattice of index 2, taking doubled generator $2(\alpha_2 - \alpha_6)$. Such sublattice already have root subsystem description, we denote it $\widetilde{Q^{a,\perp w}}$.

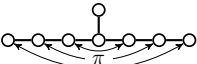
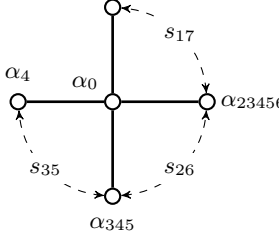
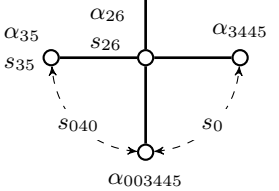
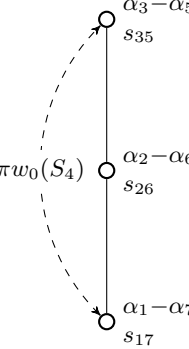
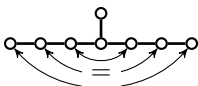
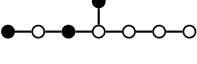
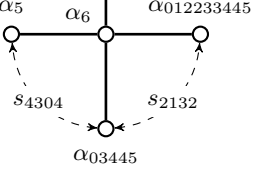
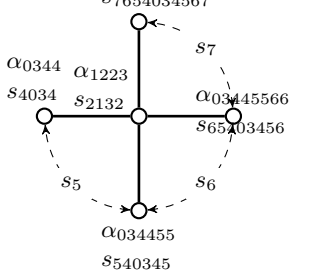
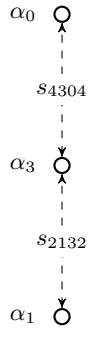
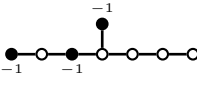
⁹It is absent in [KNY17].

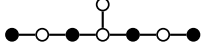
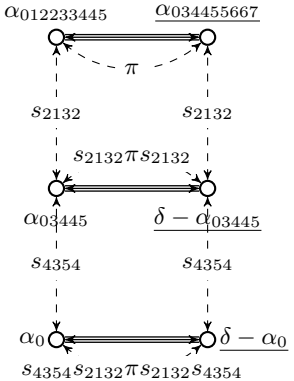
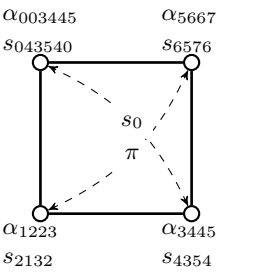
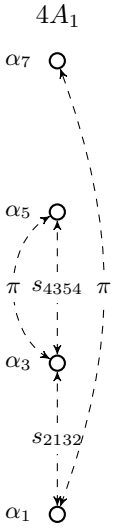
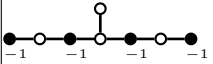
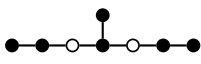
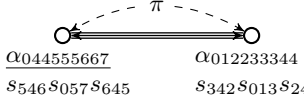
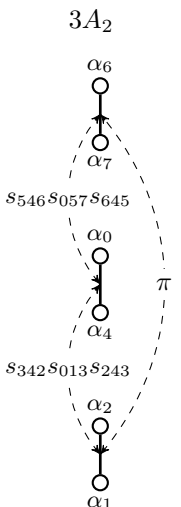
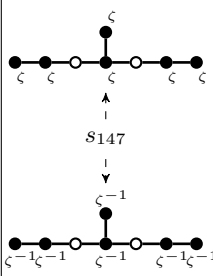
Folding	$Q^{a,w}$	$Q^{a,\perp w}$	$C(w)$	\mathcal{A}^w
 <p> $w = \pi = t_{\omega_1} \bar{\pi}$ $\bar{\pi} = s s_{013} s^{-1}$, $s = s_{123405645342}$ </p>	<p>$D_4^{(1)}$</p> <p>$\underline{\alpha_{1234567}}$</p>  <p>$(D_4^{(1)}) _{ \alpha ^2=4}$</p> <p>$\underline{\alpha_{17}}$ s_{17}</p>  <p> $t_{\omega_{\alpha_{35}}} + \omega_{\alpha_{3445}} + \omega_{\alpha_{003445}} - \omega_{\alpha_{26}}$ $\sim t_{\omega_{35} - \omega_{126}}^{1/2}$ $t_{\omega_{\alpha_{26}}} \sim t_{\omega_{26} - 2\omega_1}^{1/2}$ </p>	<p>$(A_3)_{ \alpha ^2=4}$</p> 	<p> $(S_4 \times W_{D_4}^a) \times \underbrace{C_2}_{triv}$ $\simeq (S_3 \times W_{D_4}^a) \times \underbrace{C_2}_{triv}$ \downarrow $S_3 \times (C_2^2 \times W_{D_4}^a)$ $t_{\omega_{35} - \omega_{126}}^{1/2} \rightarrow t_{\omega_6 - \omega_7}$ $t_{\omega_{26} - 2\omega_1}^{1/2} \rightarrow t_{\omega_7}$ (5.14) </p>	
 <p> $w = s_{013} = \bar{w}$ </p>	<p>$D_4^{(1)}$</p> <p>$\underline{\alpha_7}$</p>  <p>$(D_4^{(1)}) _{ \alpha ^2=4}$</p> <p>$\underline{\alpha_{0344556677}}$ $s_{7654034567}$</p> 	<p>$3A_1$</p> 	<p> $S_3 \times (W_{D_4}^a \times \underbrace{C_2^3}_{triv})$ $\simeq S_4 \times (W_{D_4}^a \times \underbrace{C_2^3}_{triv})$ \downarrow $S_4 \times W_{D_4}^a$ no proj. red. in the preimage (5.17) </p>	

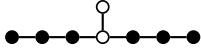
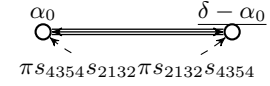
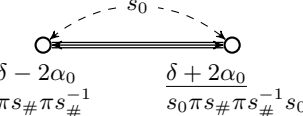
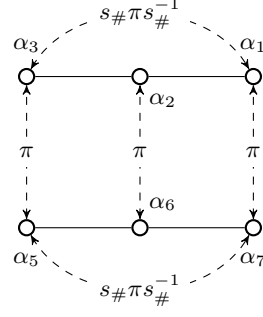
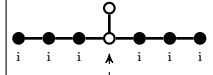
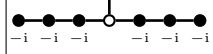
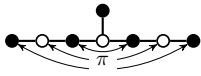
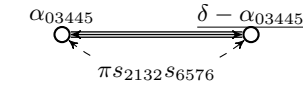
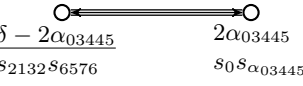
Folding	$Q^{a,w}$	$Q^{a,\perp w}$	$C(w)$	\mathcal{A}^w, N_{flip}
 <p>$w = s_1 s_3 s_5 s_7$</p>	<p>$(3A_1)^{(1)}$</p>  <p>$(A_3^{(1)})_{ \alpha ^2=4}$</p>  <p> $t_{\omega_{\alpha_{1223}} - \omega_{\alpha_{5667}}} \sim t_{\omega_2 - \omega_6}^{1/2}$ $t_{\omega_{\alpha_{3445}} - \omega_{\alpha_{003445}}} \sim t_{\omega_4 - 2\omega_0}^{1/2}$ </p>	<p>$4A_1$</p> 	<p> $(S_3 \times C_2^3) \times (W_{3A_1}^a \times \underbrace{C_2^4}_{triv})$ \simeq $(C_2^2 \times W_{A_3}^a) \times \underbrace{C_2^4}_{triv}$ \downarrow $C_2^2 \times W_{A_3}^a$ $t_{\omega_2 - \omega_6}^{1/2} \rightarrow t_{\omega_3 - \omega_2}$ $t_{\omega_4 - 2\omega_0}^{1/2} \rightarrow t_{\omega_4 - \omega_5}$ (5.20) </p>	
 <p>$w = s_{12} s_{40} s_{76}$</p>	<p>$A_1^{(1)}_{ \alpha ^2=6}$</p>  <p> $t_{\omega_{\alpha_{012233344}}} \sim t_{\omega_3 - \omega_5}^{1/3}$ </p>	<p>$3A_2$</p> 	<p> $W_{A_1}^{ae} \times \underbrace{C_3^3}_{triv}$ \downarrow $W_{A_1}^{ae}$ $t_{\omega_3 - \omega_5}^{1/3} \rightarrow t_{\omega_4}$ (5.23) </p>	

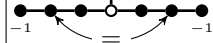
Folding	$Q_{E_7^{(1)}}^{a,w}$	$Q^{a,\perp w}$	$C(w)$	\mathcal{A}^w, N_{flip}
 <p> $w = s_{321}s_{765}$ $= t_{\omega_6}\bar{w}$ $\bar{w} = s_{321}s_{\theta 65}$ </p>	<p>$A_1^{(1)}$</p>  <p> $\pi s_{4354}s_{2132}\pi s_{2132}s_{4354}$ </p> <p>$A_1^{(1)} _{ \alpha ^2=8}$</p>  <p> $\pi s_{\#}\pi s_{\#}^{-1}$ $s_0\pi s_{\#}\pi s_{\#}^{-1}s_0$ </p> <p> $t_{\delta-2\alpha_0} \sim t_{\omega_4-2\omega_0}^{1/2}$ </p>	<p>$2A_3$</p>  <p> $s_{\#}\pi s_{\#}^{-1}$ </p> <p> π </p> <p> $s_{\#}\pi s_{\#}^{-1}$ </p>	<p> $(C_2 \times W_{A_1}^{ae}) \times C_4^2$ $\pi s_1 s_3 s_5 s_7$ $triv$ </p> <p> $\simeq (C_2 \times W_{A_1}^{ae}) \times C_4^2$ $triv$ </p> <p> \downarrow </p> <p> $C_2 \times W_{A_1}^{ae}$ $t_{\omega_4-2\omega_0}^{1/2} \rightarrow t_{-\omega_4+2\omega_0}^{1/2}$ </p> <p>Fig. 6</p>	 <p> s_{1357} </p> 
 <p> $w = \pi s_0 s_1 s_3$ $= t_{\omega_1}\bar{w}$ $t_{\omega_4-\omega_3} s w s^{-1}$ $= s_{321}s_{765}$ $s = s_{430456745230423}$ </p>	<p>$A_1^{(1)}$</p>  <p> $\pi s_{2132}s_{6576}$ </p> <p>$A_1^{(1)} _{ \alpha ^2=8}$</p>  <p> $\frac{\delta - 2\alpha_{03445}}{s_{2132}s_{6576}}$ $\frac{2\alpha_{03445}}{s_0 s_{\alpha_{03445}}}$ </p> <p> $t_{2\omega_2\alpha_{03445}} \sim t_{\omega_4-\omega_{26}}^{1/2}$ </p>	<p>$\widetilde{Q^{a,\perp w}} =$</p> <p>$(A_1)_{ \alpha ^2=8} + 5A_1$</p> <p>$\alpha_0$</p>  <p> α_1 α_7 α_3 α_5 </p> <p> $\pi s_{2132}s_{6576}$ </p> <p> $\alpha_{1223} - \alpha_{5667}$ π </p>	<p> $C_2^2 \times (W_{A_1} \times C_2^5)$ $\pi s_0, \pi$ $triv$ </p> <p> $\simeq (C_2^2 \times W_{A_1}) \times C_2^4$ $\pi s_0, \pi$ $triv$ </p> <p> \downarrow </p> <p> $C_2^2 \times W_{A_1}$ $\pi s_0, \pi$ </p> <p> $t_{\omega_4-\omega_{26}}^{1/2} \rightarrow t_{\omega_6}$ </p> <p>(5.27)</p>	 <p> -1 </p> 

4.3 $E_6^{(1)}/A_2^{(1)}$

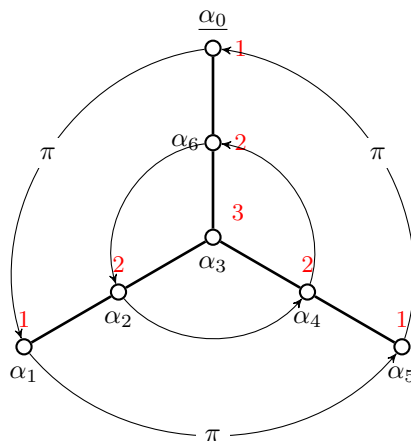

Figure 10: Root numbering and marks for $E_6^{(1)}$ Dynkin diagram

Affine Weyl group $W(E_6^{(1)})$ (and corresponding Dynkin diagram) has outer automorphism of order 3. Diagram has also outer automorphism of order 2 (vertical reflection), which is absent in $W(E_6^{(1)})$.

For $E_6^{(1)}$ we have 3 foldings:

- Two foldings of order 3, of case 1 and 2, which have common (up to conjugation) \bar{w} .
- Folding of order 2, of case 2.

For folding π we have two peculiarities:

- First, to obtain root subsystem realization, we take index 3 sublattice $\widetilde{Q^{a,\perp w}}$ of $Q^{a,\perp w}$ defined as follows. $Q^{a,\perp w}$ are defined as $(\alpha = x_0\alpha_0 + x_1\alpha_1 + x_5\alpha_5 + y_2\alpha_2 + y_4\alpha_4 + y_6\alpha_6 \in Q \mid \sum x_i = 0, \sum y_i = 0)$. Then $\widetilde{Q^{a,\perp w}}$ are defined as $(\alpha \in Q^{a,\perp w} \mid x_1 + x_2 - x_4 - x_5 = 0 \pmod{3})$.
- After we find convenient sublattice $\widetilde{Q^{a,\perp w}} = 2A_2$, we discover, that its simple reflections cannot be realized inside W^{ae} , from $W_{A_2^2}$ we can realize only $\Omega_{A_2^2}^2$. This realization is written at the table.

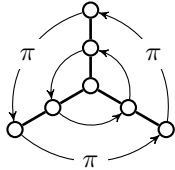
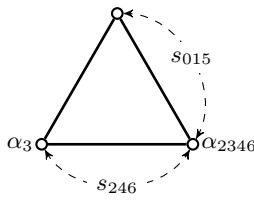
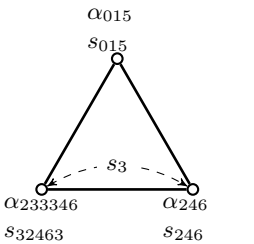
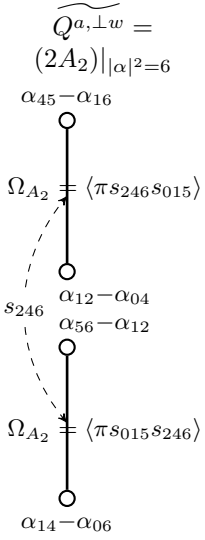
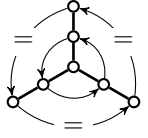
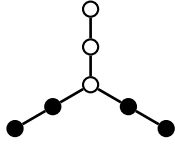
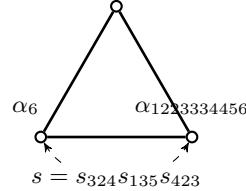
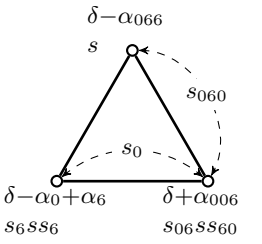
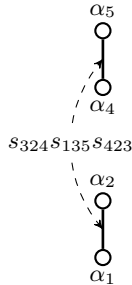
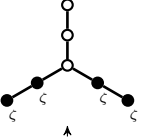
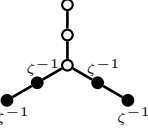
Folding	$Q^{a,w}$	$Q^{a,\perp w}$	$C(w)$	A^w, N_{flip}
 <p> $\pi = t_{\omega_5} \bar{\pi}$ $\bar{\pi} = s s_{1245} s^{-1}$, $s = s_{123543263}$ </p>	<p>$A_2^{(1)}$</p> <p>$\underline{\alpha_{0123456}}$</p>  <p>$(A_2^{(1)}) _{ \alpha ^2=6}$</p>  <p>$t_{\omega_{\alpha_{2346}}} \sim t_{\omega_{246-2\omega_{15}}}^{1/3}$</p>	<p>$\widetilde{Q^{a,\perp w}} = (2A_2) _{ \alpha ^2=6}$</p> 	<p>$W_{A_2}^{ae} \times \underbrace{C_3}_{triv}$</p> <p>$\simeq (C_2 \times W_{A_2}^a) \times \underbrace{C_3}_{triv}$</p> <p>$\downarrow$</p> <p>$C_2 \times W_{A_2}^a$</p> <p>$t_{\omega_{246-2\omega_{15}}}^{1/3} \rightarrow t_{\omega_7}$</p> <p>(5.32)</p>	
 <p>$w = s_{1245}$</p>	<p>$A_2^{(1)}$</p> <p>$\underline{\alpha_0}$</p>  <p>$(A_2^{(1)}) _{ \alpha ^2=6}$</p>  <p>$s_6 s_8 s_6$ $s_06 s_8 s_60$</p>	<p>$2A_2$</p> 	<p>$C_2 \times (W_{A_2}^a \times \underbrace{C_2^2}_{triv})$</p> <p>$\simeq (S_3 \times W_{A_2}^a) \times \underbrace{C_2^2}_{triv}$</p> <p>$\downarrow$</p> <p>$S_3 \times W_{A_2}^a$</p> <p>no proj. red. in the preimage</p> <p>(5.36)</p>	 <p>\uparrow s_{15} \downarrow</p> 

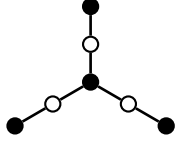
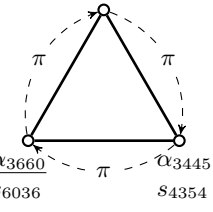
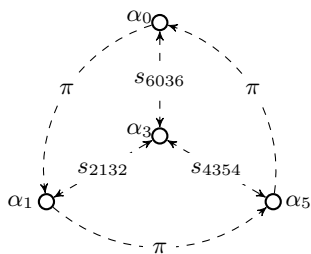
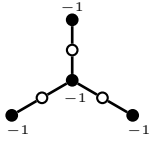
Folding	$Q^{a,w}$	$Q^{a,\perp w}$	$C(w)$	\mathcal{A}^w
 <p>$w = s_{0135}$</p>	<p>$(A_2^{(1)})_{ \alpha ^2=4}$</p>  <p>$t_{\omega_{\alpha_{1223}} - \omega_{\alpha_{3445}}} \sim t_{\omega_2 - \omega_4}^{1/2}$ $t_{\omega_{\alpha_{3445}}} \sim t_{\omega_4 - \omega_6}^{1/2}$</p>	<p>$4A_1$</p> 	<p>$W_{A_2}^{ae} \times \underbrace{C_2^4}_{triv}$</p> <p>$\downarrow$</p> <p>$W_{A_2}^{ae}$</p> <p>$t_{\omega_2 - \omega_4}^{1/2} \rightarrow t_{-\omega_2}$ $t_{\omega_4 - \omega_6}^{1/2} \rightarrow t_{\omega_2 - \omega_1}$</p> <p>(5.40)</p>	

4.4 $D_5^{(1)}/A_3^{(1)}$

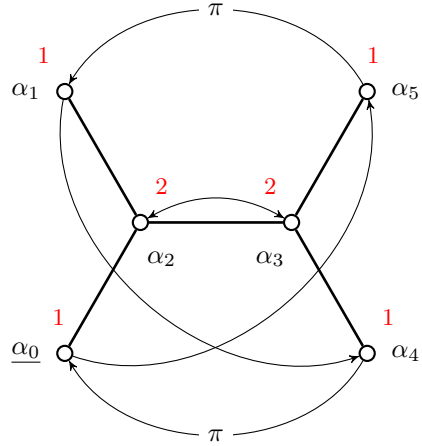
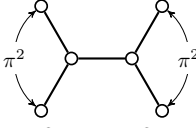
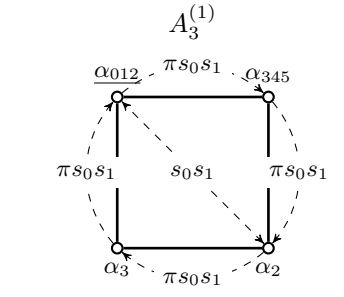
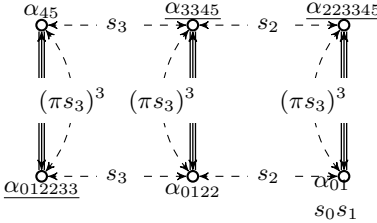
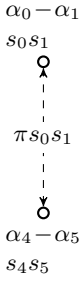
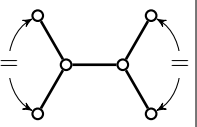
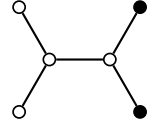
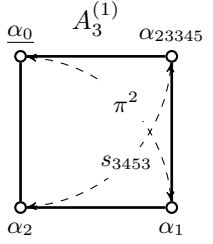
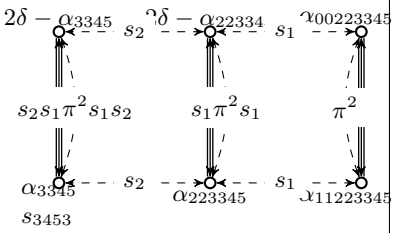
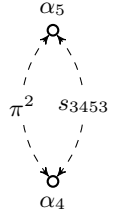
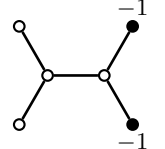

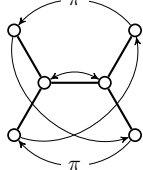
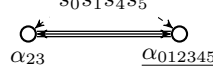
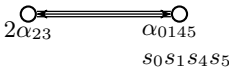
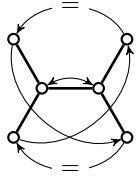
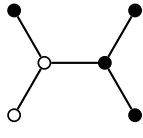
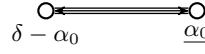
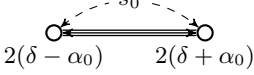
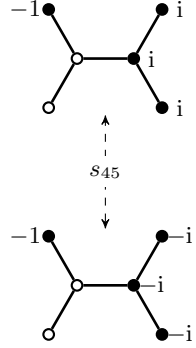
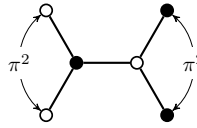

Figure 11: Root numbering and marks for $D_5^{(1)}$ Dynkin diagram

Affine Weyl group $W(D_5^{(1)})$ (and corresponding Dynkin diagram) has outer automorphism of order 4. Diagram has also outer automorphism of order 2 (transposition of α_0 and α_1), which is absent in $W(D_5^{(1)})$. For $D_5^{(1)}$ we have 6 foldings:

- Three foldings of order 4, of case 1, 2 and 3, which have common (up to conjugation) \bar{w} .
- Two foldings of order 2, of case 1, which is square of case 1 folding of order 4, and of case 2, which is (up to conjugation) square of both other foldings of order 4. \bar{w} .
- Another folding of order 2, of case 2.

Folding	$Q^{a,w}$	$Q^{a,\perp w}$	$C(w)$	A^w
 <p> $\pi^2 = t_{\omega_1} \bar{\pi}^2$ $\bar{\pi}^2 = s_{123} s_4 s_5 s_{123}^{-1}$ </p>	<p style="text-align: center;">$A_3^{(1)}$</p>  <p style="text-align: center;">$((3A_1)^{(1)}) _{ \alpha ^2=4}$</p>  <p style="text-align: center;">$t_{\omega_{\alpha_{45}}} \sim t_{\omega_{45-\omega_1}}^{1/2}$</p>	<p style="text-align: center;">$(2A_1) _{ \alpha ^2=4}$</p>  <p style="text-align: center;">π^2 is central -1.</p>	<p style="text-align: center;">$C_2 \times W_{A_3}^{ae} \times \underbrace{C_2}_{triv}$</p> <p style="text-align: center;">$\simeq ((S_3 \times C_2^3) \times W_{3A_1}^a) \times \underbrace{C_2}_{triv}$</p> <p style="text-align: center;">\downarrow</p> <p style="text-align: center;">$(S_3 \times C_2^3) \times W_{3A_1}^a$</p> <p style="text-align: center;">$t_{\omega_{45-\omega_1}}^{1/2} \rightarrow t_{\omega_1}$</p> <p style="text-align: center;">(5.43)</p>	
 <p> $w = \bar{w} = s_4 s_5$ </p>	<p style="text-align: center;">$A_3^{(1)}$</p>  <p style="text-align: center;">$((3A_1)^{(1)}) _{ \alpha ^2=4}$</p> 	<p style="text-align: center;">$2A_1$</p> 	<p style="text-align: center;">$C_2^2 \times (W_{A_3}^a \times \underbrace{C_2^2}_{triv})$</p> <p style="text-align: center;">$\simeq ((S_3 \times C_2^3) \times W_{3A_1}^a) \times \underbrace{C_2^2}_{triv}$</p> <p style="text-align: center;">\downarrow</p> <p style="text-align: center;">$(S_3 \times C_2^3) \times W_{3A_1}^a$</p> <p style="text-align: center;">no proj. red. in the preimage</p> <p style="text-align: center;">(5.46)</p>	

For folding π of order 4 we have the same problems, as for case 1 folding in $E_6^{(1)}$. Namely, $Q^{a,\perp w}$ is generated by $\alpha_0 - \alpha_4, \alpha_5 - \alpha_0, \alpha_1 - \alpha_5$ and $\alpha_2 - \alpha_3$. We take index 2 sublattice $\widetilde{Q^{a,\perp w}}$, doubling latter generator. In obtained $(A_1)_{|\alpha|^2=16} + A_3|_{|\alpha|^2=4}$ we can realize only few group elements, see below.

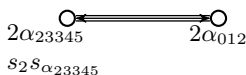
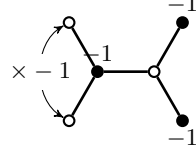
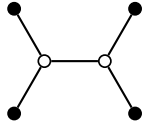
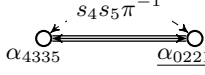
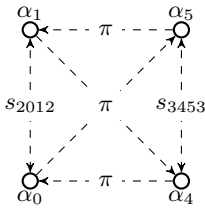
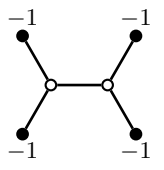
Folding	$Q^{a,w}$	$Q^{a,\perp w}$	$C(w)$	A^w, N_{flip}
 <p> $w = \pi = t_{\omega_4} \bar{\pi}$ $\bar{\pi} = s s_{1534} s^{-1}$ $s = s_{54312}$ </p>	<p>$A_1^{(1)}$</p>  <p>$(A_1^{(1)})_{ \alpha ^2=8}$</p>  <p> $t_{2\omega_{2\alpha_{23}}} \sim t_{\omega_{23}-\omega_{145}}^{1/2}$ </p>	<p> $\widetilde{Q^{a,\perp w}} = (A_1)_{ \alpha ^2=16} + (A_3)_{ \alpha ^2=4}$ $\alpha_{0122} - \alpha_{3345}$ $\pi \quad \circ$ $\alpha_0 - \alpha_4 \quad \alpha_5 - \alpha_0 \quad \alpha_1 - \alpha_5$ $\circ \quad \circ \quad \circ$ $\Omega_{A_3} = \langle \pi \rangle$ $Z(A_3^e) = \langle s_0 s_1 s_4 s_5 \rangle$ </p>	<p> $W_{A_1}^{ae} \times \underbrace{C_4}_{triv}$ $\simeq W_{A_1}^a \times \underbrace{C_4}_{triv}$ \downarrow $W_{A_1}^a$ $t_{\omega_{23}-\omega_{0145}}^{1/2} \rightarrow t_{\omega_7}$ </p> <p>(5.49)</p>	
 <p> $w = s_1 s_5 s_3 s_4$ </p>	<p>$A_1^{(1)}$</p>  <p>$(A_1^{(1)})_{ \alpha ^2=8}$</p> 	<p>$A_1 + A_3$</p> <p>α_1</p> <p>\circ</p> <p>$\alpha_5 \quad \alpha_3 \quad \alpha_4$</p> <p>$\circ \quad \circ \quad \circ$</p>	<p> $W_{A_1}^a \times C_2 \times C_4$ $\simeq W_{A_1}^{ae} \times \underbrace{C_2 \times C_4}_{triv}$ \downarrow $W_{A_1}^{ae}$ no proj. red. in the preimage </p> <p>(5.53)</p>	
 <p> $w = \pi^2 s_2 s_4$ $\bar{w} = s_{123} s_1 s_5 s_3 s_{123}^{-1}$ </p>	<p>$A_1^{(1)}$</p>  <p>$(A_1^{(1)})_{ \alpha ^2=8}$</p> 	<p>$(A_1)_{ \alpha ^2=4} + 3A_1$</p> <p>$\alpha_2$</p> <p>$\circ$</p> <p>$\alpha_4 \quad \pi^2 \quad \alpha_5$</p> <p>$\circ \quad \circ$</p> <p>$\alpha_0 - \alpha_1$</p> <p>$\pi^2$</p>	<p> $W_{A_1}^a \times ((\underbrace{C_2 \times C_4}_{triv}) \times \underbrace{C_2}_{s_2})$ \downarrow $C_2 \times W_{A_1}^a$ no proj. red. </p> <p>(5.56)</p>	
 <p> $w = s_0 s_1 s_4 s_5$ </p>	<p>$A_1^{(1)}_{ \alpha ^2=4}$</p>  <p> $s_4 s_5 s_3 s_4 s_3 \quad s_0 s_1 s_2 s_0$ $t_{\omega_{\alpha_{4335}}} \sim t_{\omega_3 - \omega_2}^{1/2}$ </p>	<p>$4A_1$</p> 	<p> $C_4 \times (W_{A_1}^a \times (\underbrace{C_2 \times C_2^3}_{s_4 s_5 \quad triv}))$ \downarrow $(C_4 \times W_{A_1}^a) \times C_2$ $t_{\omega_3 - \omega_2}^{1/2} \rightarrow t_{\omega_1}$ </p> <p>(5.59)</p>	

4.5 $A_4^{(1)}/A_4^{(1)}$

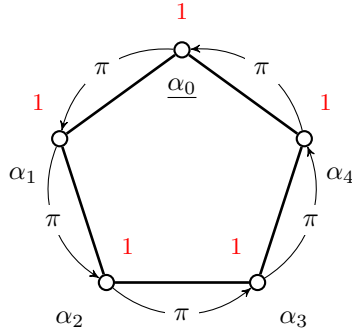

Figure 12: Root numbering and marks for $E_3^{(1)}$ Dynkin diagram

No true folding transformation.

4.6 $E_3^{(1)}/A_5^{(1)}$

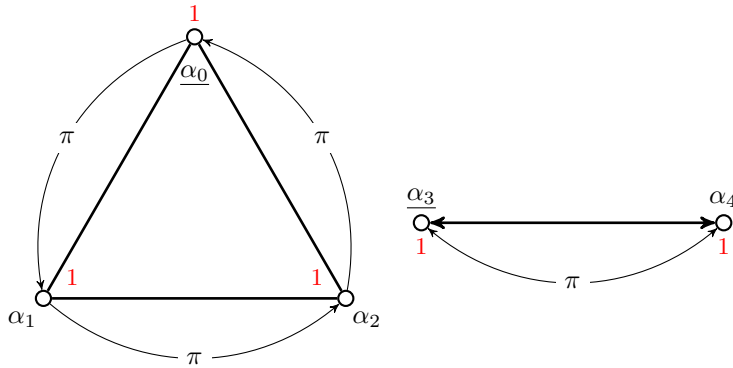
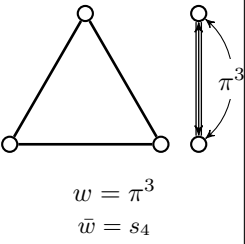
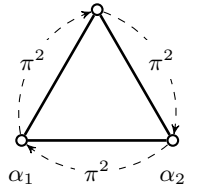

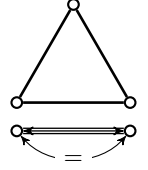
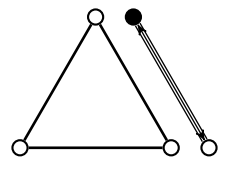
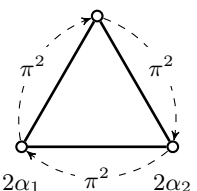

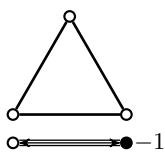
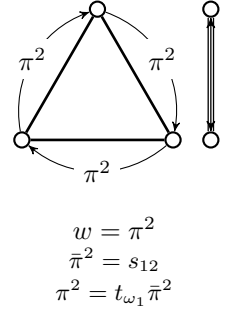
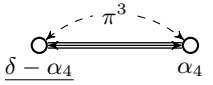
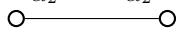
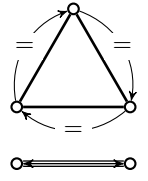
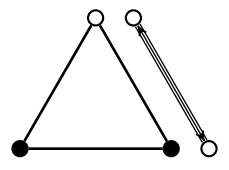
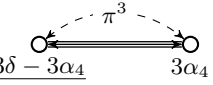

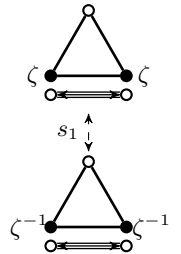

Figure 13: Root numbering and marks for $E_3^{(1)}$ Dynkin diagram

Affine Weyl group $W(E_3^{(1)})$ (and corresponding Dynkin diagram) has outer automorphism of order 6. Diagram has also outer automorphism of order 2 (vertical reflection), which is absent in $W(E_3^{(1)})$. For $E_3^{(1)}$ we have 4 foldings:

- Two foldings of order 2, of case 1 and 2, which have common (up to conjugation) \bar{w} .
- Two foldings of order 3, of case 1 and 2, which have common (up to conjugation) \bar{w} .

Folding	$Q^{a,w}$	$Q^{a,\perp w}$	$C(w)$	\mathcal{A}^w, N_{flip}
 <p>$w = \pi^3$ $\bar{w} = s_4$</p>	<p>$A_2^{(1)}$</p>  <p>$(A_2^{(1)})_{ \alpha ^2=8}$</p>	<p>$(A_1)_{ \alpha ^2=8}$</p> <p>$\alpha_3 - \alpha_4$</p> <p>π^3</p> 	<p>$W_{A_2}^{ae} \times \underbrace{C_2}_{triv}$</p> <p>$\downarrow$</p> <p>$W_{A_2}^{ae}$</p> <p>no proj. red. in the preimage</p> <p>(5.63)</p>	
 <p>$w = s_4$</p>	<p>$2\alpha_0$</p>  <p>$(A_2^{(1)})_{ \alpha ^2=8}$</p>	<p>A_1</p> <p>α_4</p> 	<p>$W_{A_2}^{ae} \times \underbrace{C_2}_{triv}$</p> <p>$\downarrow$</p> <p>$W_{A_2}^{ae}$</p> <p>no proj. red. in the preimage</p> <p>(5.66)</p>	
 <p>$w = \pi^2$ $\bar{\pi}^2 = s_{12}$ $\pi^2 = t_{\omega_1} \bar{\pi}^2$</p>	<p>$A_1^{(1)}$</p>  <p>$(A_1^{(1)})_{ \alpha ^2=18}$</p>	<p>$(A_2)_{ \alpha ^2=6}$</p> <p>$\alpha_0 - \alpha_2$</p> <p>$\alpha_2 - \alpha_1$</p>  <p>$\Omega_{A_2} = \langle \pi^2 \rangle$</p>	<p>$W_{A_1}^{ae} \times \underbrace{C_3}_{triv}$</p> <p>$\downarrow$</p> <p>$W_{A_1}^{ae}$</p> <p>no proj. red. in the preimage</p> <p>(5.70)</p>	
 <p>$w = s_{12}$</p>		<p>A_2</p> <p>α_1</p> <p>α_2</p> 	<p>$W_{A_1}^{ae} \times \underbrace{C_3}_{triv}$</p> <p>$\downarrow$</p> <p>$W_{A_1}^{ae}$</p> <p>no proj. red. in the preimage</p> <p>(5.73)</p>	

4.7 $E_2^{(1)}/A_6^{(1)}$

It appears the symmetry lattice Q^a in this case is larger than $(A_1 + A_1)^{(1)}$. Namely, if we denote by α_1 and α_2 simple roots for this 2 summands, then first $\alpha_2^2 = -8$ and second $(\alpha_1 - \alpha_2)/2 \in Q^a$. Due to this reason



Figure 14: Root numbering and marks for $E_2^{(1)}$ Dynkin diagram

symmetry group is smaller, it is generated by π and s_1 , where π acts on first summand as automorphism and on second summand as translation. See Fig. 14. Geometrically, this corresponds to the fact that the surface \mathcal{X} for $E_2^{(1)}/A_6^{(1)}$ depends on square roots of root variables, namely on $b = (a_1/a_2)^{1/2}$. See section 5.6 below.

The only possibility for the folding transformation is simple reflection, say s_1 with $a_1 = -1$. But since $s_1(b) = ba_1^{-1}$ this is not the case. Therefore we have no folding transformations in this case.

4.8 $A_1^{(1)}/A_7^{(1)'}$

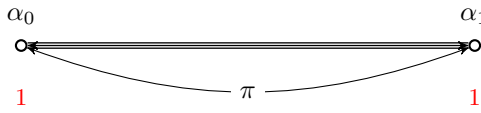

Figure 15: Root numbering and marks for $E_1^{(1)}$ Dynkin diagram

Affine Weyl group $W(E_1^{(1)})$ has outer automorphism π of order 2, which in q -Painlevé symmetry is extended to C_4 (π^2 become $\neq 1$). There is also q -Painlevé (gauge) symmetry σ of order 2¹⁰. These extensions act trivially on root variables, but nontrivially on coordinates, see Subsection 5.7

For $E_1^{(1)}$ we have 2 foldings of order 2, given by π^2 and σ .

Folding	$Q^{a,w}$	$Q^{a,\perp w}$	$C(w)$	\mathcal{A}^w
 $w = \pi^2$		-	$(\underbrace{C_4}_{sq.=triv} \times W_{A_1}^a) \times C_2 \simeq \dots$ \downarrow $W_{A_1}^a \times C_2$ no proj. red. in the preim. (5.76)	
 $w = \sigma$		-	$(C_4 \times W_{A_1}^a) \times \underbrace{C_2}_{triv}$ \downarrow $C_4 \times W_{A_1}^a$ no proj. red. in the preim. (5.79)	

¹⁰It is absent in [KNY17]

5 Geometric realization: answers

5.1 $E_8^{(1)}/A_0^{(1)}$

Action on coordinates $F = f/\nu_1$, $G = g/\nu_1$ (where f, g — notations of [KNY17]):

coord.	s_0	s_1	s_2	s_3	s_4	s_5	s_6	s_7	s_8
F	$a_0 F$	G	$\frac{(a_1-1)((a_{12}-1)(a_2-1)+a_0FG)-a_1(1+a_0)(a_2(F-G)-(a_1^{-1}F-G))}{a_0((F-G)-a_{12}(a_1^{-1}F-G))-a_2(a_1-1)(1+a_0)}$	F	F	F	F	F	F
G	$a_0 G$	F	$a_2^{-1} G$	G	G	G	G	G	G

Anticanonical divisor is represented by curve

$$a_0 a_2^{-1} (F - G)(a_1^{-1} F - G) = 2 - a_1 - a_1^{-1}. \quad (5.1)$$

Root data and point configuration:

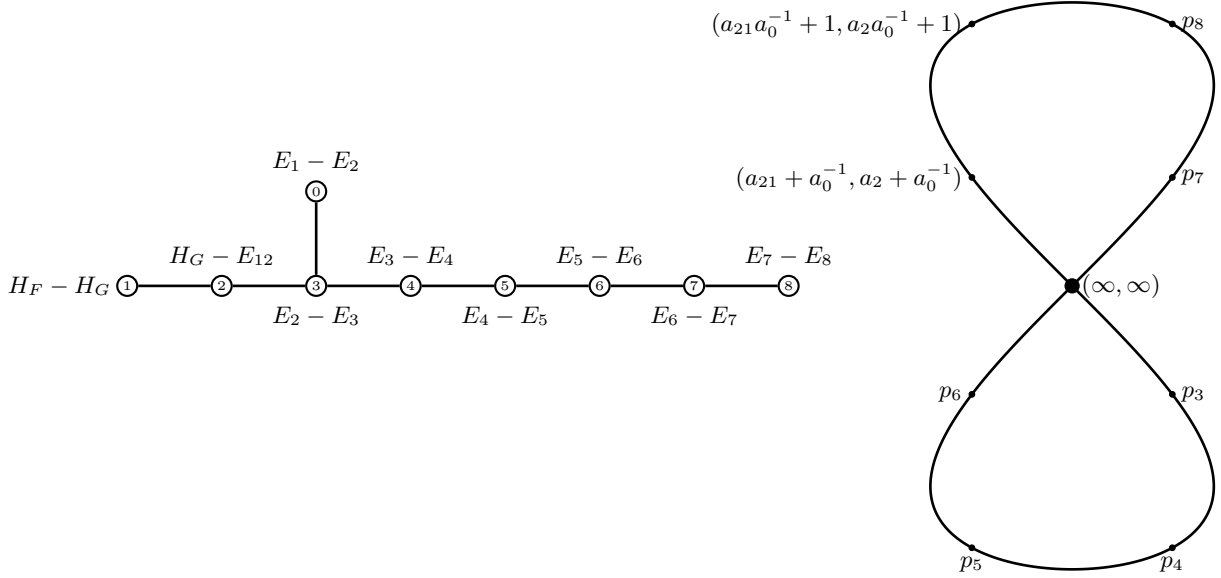

where $p_i = (a_{3\dots i} a_{21} + a_{3\dots i}^{-1} a_0^{-1}, a_{3\dots i} a_2 + a_{3\dots i}^{-1} a_0^{-1})$, $i = 3 \dots 8$ and (∞, ∞) is self-intersection point.

5.1.1 $3A_2$

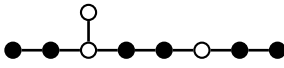

$$w = s_{21} s_{54} s_{87} : \quad \begin{aligned} F &\mapsto -\zeta \frac{3 + \zeta(1 + a_0)(\zeta^{-1}F + \zeta G) + a_0 FG}{1 + a_0 + a_0(\zeta^{-1}F + \zeta G)} \\ G &\mapsto \zeta F \end{aligned} \quad (5.2)$$

Under w we have 3 fixed points:

sing. pt.	action	except. div.	Image
(∞, ∞)	$\begin{pmatrix} 0 & \zeta \\ -\zeta^{-1} & -1 \end{pmatrix}$	A_2	$\mathcal{H}_F - \mathcal{E}_{56}, \mathcal{H}_G - \mathcal{E}_{78}$
$(-\zeta, -\zeta^{-1})$	$\begin{pmatrix} 0 & \zeta^{-1} \\ -\zeta & -1 \end{pmatrix}$	A_2	$\mathcal{H}_F - \mathcal{E}_{28}, \mathcal{H}_G - \mathcal{E}_{16}$
$(-\zeta a_0^{-1}, -\zeta^{-1} a_0^{-1})$	$\begin{pmatrix} 0 & \zeta^{-1} \\ -\zeta & -1 \end{pmatrix}$	A_2	$\mathcal{H}_F - \mathcal{E}_{17}, \mathcal{H}_G - \mathcal{E}_{25}$

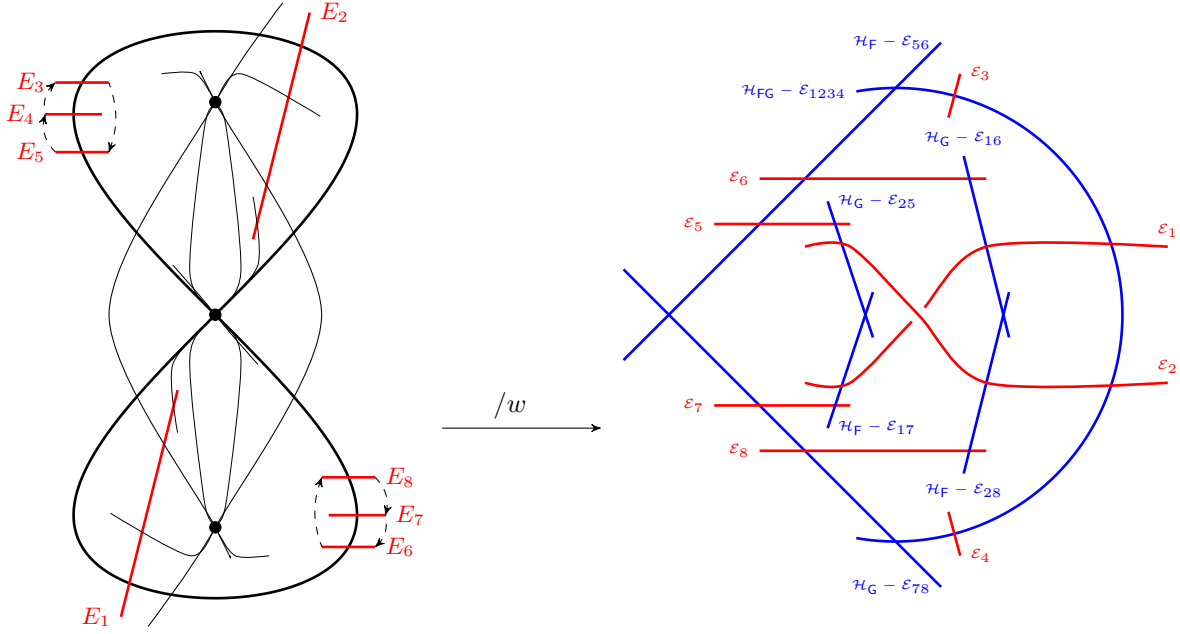

Preimages of (-1) curves

Curve	$(-\zeta, -\zeta^{-1})$	$(-\zeta a_0^{-1}, -\zeta^{-1} a_0^{-1})$	(∞, ∞)	Image
$\zeta(F - G) = 1 - \zeta^{-1}$	$dF \sim dG$	-	$dF^{-1} \sim dG^{-1}$	\mathcal{E}_8
$a_0 \zeta(F - G) = 1 - \zeta^{-1}$	-	$dF \sim dG$	$dF^{-1} \sim dG^{-1}$	\mathcal{E}_7
$-\zeta^{-1}F + G = 1 - \zeta^{-1}$	$dF \sim \zeta dG$	-	$dF^{-1} \sim \zeta^{-1} dG^{-1}$	\mathcal{E}_6
$-a_0 \zeta^{-1}F + a_0 G = 1 - \zeta^{-1}$	-	$dF \sim \zeta dG$	$dF^{-1} \sim \zeta^{-1} dG^{-1}$	\mathcal{E}_5
$(a_0 - \zeta)F - (a_0 - \zeta^{-1})G = (\zeta^{-1} - \zeta)(a_0 FG + 1)$	$dF \sim \zeta dG$	$dF \sim dG$	-	\mathcal{E}_1
$(1 - \zeta a_0)F - (1 - \zeta^{-1} a_0)G = (\zeta^{-1} - \zeta)(a_0 FG + 1)$	$dF \sim dG$	$dF \sim \zeta dG$	-	\mathcal{E}_2

Under factorization we obtain already minimal surface $E_6^{(1)}/A_2^{(1)}$ with parameters and coordinates

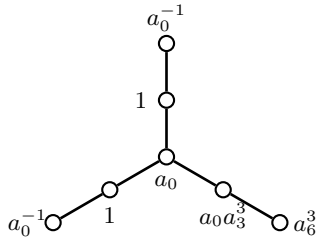

$$\begin{aligned}
 F &= \frac{3\zeta a_0^{-1} - (F - \zeta G)^2 + (1 - \zeta)(1 + a_0^{-1})(F - \zeta G)}{3\zeta^{-1}(F + \zeta G) + \zeta(1 + a_0)(F - G)^2 + (\zeta^{-1} - 1)a_0 FG(F - G)} \\
 G &= a_0 \frac{3\zeta a_0^{-1} - \zeta(F - G)^2 + (1 - \zeta^{-1})(1 + a_0^{-1})(F - G)}{3\zeta(F + G) + (1 + a_0)(F - \zeta G)^2 + (\zeta - 1)a_0 FG(F - \zeta G)}
 \end{aligned} \quad (5.3)$$

Symmetry lattice is $A_2^{(1)}$, nodal curves and lattice is $\bar{\Phi}_{\text{nod}} = \Phi_{\text{nod}} = 2A_2$, symmetry group is as follows:

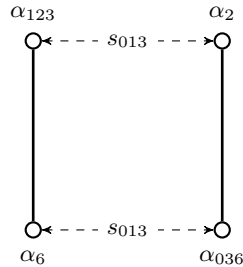
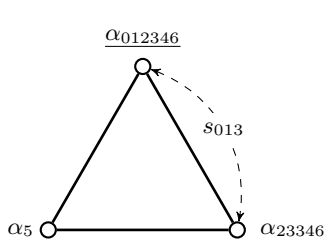

$$C_2 \times W_{A_2}^a \quad (5.4)$$

No projective reduction in the image.

5.1.2 $4A_1$

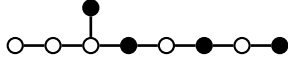

$$w = s_{0468} : \begin{aligned} F &\mapsto -F \\ G &\mapsto -G \end{aligned} \quad (5.5)$$

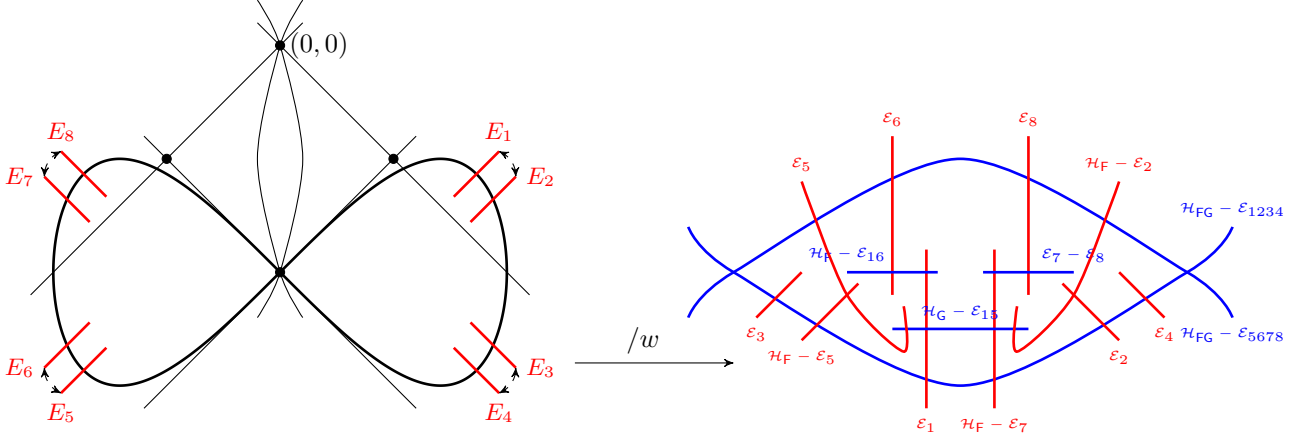

Under w we have 4 fixed points:

sing. pt.	action	except. div.	Image
$(0, 0)$	$-\text{Id}_{2 \times 2}$	A_1	$\mathcal{H}_G - \mathcal{E}_{15}$
$(0, \infty)$	$(F, G^{-1}) : -\text{Id}_{2 \times 2}$	A_1	$\mathcal{H}_F - \mathcal{E}_{16}$
$(\infty, 0)$	$(F^{-1}, G) : -\text{Id}_{2 \times 2}$	A_1	$\mathcal{E}_7 - \mathcal{E}_8$
(∞, ∞)	$(F^{-1}, G^{-1}) : -\text{Id}_{2 \times 2}$	A_1	$\mathcal{H}_{FG} - \mathcal{E}_{5678}$

Preimages of (-1) curves:

Curve	$(0, 0)$	$(0, \infty)$	$(\infty, 0)$	(∞, ∞)	Image
$F = 0$	$dF = 0$	$dF = 0$	-	-	\mathcal{E}_1
$F = \infty$	-	-	$dF^{-1} = 0$	$dF^{-1} = 0$	\mathcal{E}_8
$G = 0$	$dG = 0$	-	$dG = 0$	-	$\mathcal{H}_F - \mathcal{E}_7$
$G = \infty$	-	$dG^{-1} = 0$	-	$dG^{-1} = 0$	\mathcal{E}_6
$F = \frac{a_{12}-1}{a_2-1}G$	$dF = \frac{a_{12}-1}{a_2-1}dG$	-	-	$dG^{-1} = \frac{a_{12}-1}{a_2-1}dF^{-1}$	\mathcal{E}_5
$F = \frac{a_{1233}-1}{a_{233}-1}G$	$dF = \frac{a_{1233}-1}{a_{233}-1}dG$	-	-	$dG^{-1} = \frac{a_{1233}-1}{a_{233}-1}dF^{-1}$	$\mathcal{H}_F - \mathcal{E}_2$

Under factorization we obtain already minimal surface $E_7^{(1)}/A_1^{(1)}$ with parameters and coordinates

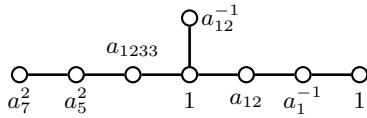

$$\begin{aligned} F &= \frac{G - a_1^{-1}F}{G - F} \\ G &= \frac{(a_{12} - 1)(a_1 - 1) + a_2^{-1}F(G - F)}{(a_{12} - 1)(a_1 - 1) + a_1F(G - a_1^{-1}F)} \end{aligned} \quad (5.6)$$

Symmetry lattice is $D_5^{(1)}$, nodal curves and lattice is $\bar{\Phi}_{\text{nod}} = \Phi_{\text{nod}} = 3A_1$, symmetry group is as follows:

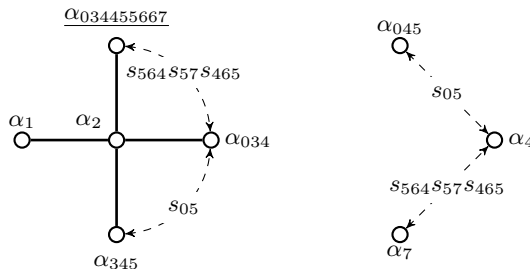

$$S_3 \times W_{D_4}^a \quad (5.7)$$

No projective reduction in the image.

5.1.3 $A_1 + 2A_3$

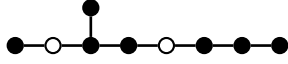

$$w = s_{1430876} : \begin{aligned} F &\mapsto iG \\ G &\mapsto iF \end{aligned} \quad (5.8)$$

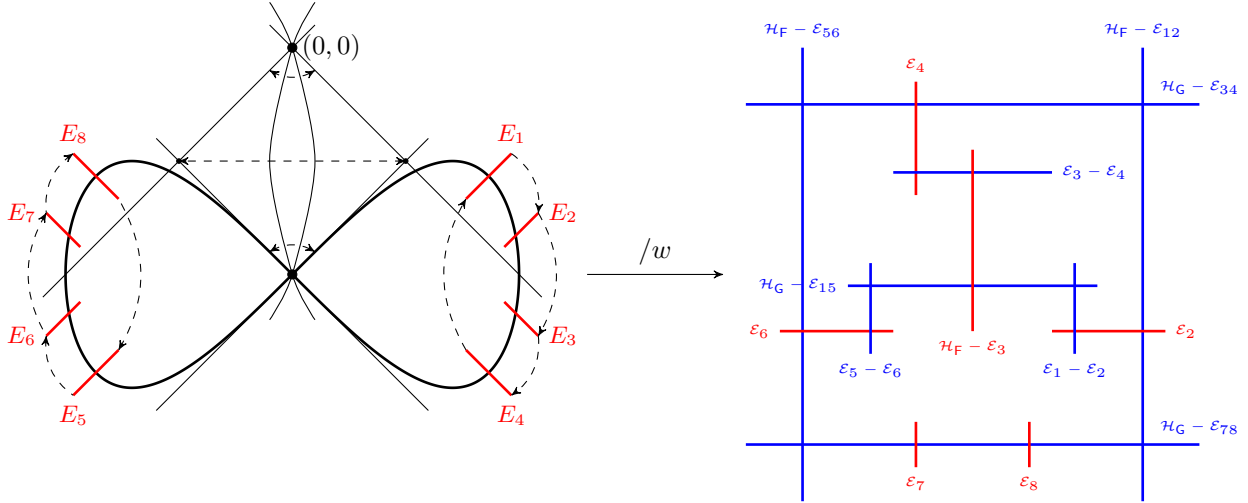

We have 2 fixed points under w and 2 fixed points under w^2 (small circles)

sing. pt.	action	except. div.	Image
$(0, 0)$	$\begin{pmatrix} 0 & i \\ i & 0 \end{pmatrix}$	A_3	$\mathcal{E}_5 - \mathcal{E}_6, \mathcal{H}_G - \mathcal{E}_{15}, \mathcal{E}_1 - \mathcal{E}_2$
(∞, ∞)	$\begin{pmatrix} 0 & -i \\ -i & 0 \end{pmatrix}$	A_3	$\mathcal{H}_F - \mathcal{E}_{56}, \mathcal{H}_G - \mathcal{E}_{34}, \mathcal{H}_F - \mathcal{E}_{12}$
$(0, \infty)$	$w^2 : (F, G^{-1}) : -\text{Id}_{2 \times 2}$	A_1	$\mathcal{E}_3 - \mathcal{E}_4$
$(\infty, 0)$	$w^2 : (F^{-1}, G) : -\text{Id}_{2 \times 2}$	A_1	

Preimages of (-1) curves:

Curve	$(0, 0)$	$(0, \infty)$	$(\infty, 0)$	(∞, ∞)	Image
$F = 0 \sqcup G = 0$	$dF = 0 \sqcup dG = 0$	$dF = 0$	$dG = 0$	-	$\mathcal{H}_F - \mathcal{E}_3$
$F = \infty \sqcup G = \infty$	-	$dG^{-1} = 0$	$dF^{-1} = 0$	$dF^{-1} = 0 \sqcup dG^{-1} = 0$	\mathcal{E}_4
$F = G$	$dF = dG$	-	-	$dF^{-1} = dG^{-1}$	\mathcal{E}_6
$F = -G$	$dF = -dG$	-	-	$dF^{-1} = -dG^{-1}$	\mathcal{E}_2

Under factorization we obtain already minimal surface $D_5^{(1)}/A_3^{(1)}$ with parameters and coordinates

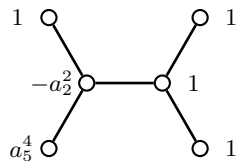

$$\begin{aligned} F &= \left(\frac{F-G}{F+G} \right)^2 \\ G &= 1 - \frac{F^2 - G^2}{4ia_2} \end{aligned} \quad (5.9)$$

Symmetry lattice is $A_1^{(1)}$, nodal curves and lattice is $\bar{\Phi}_{\text{nod}} = \Phi_{\text{nod}} = A_1 + A_3$, symmetry group is as follows:

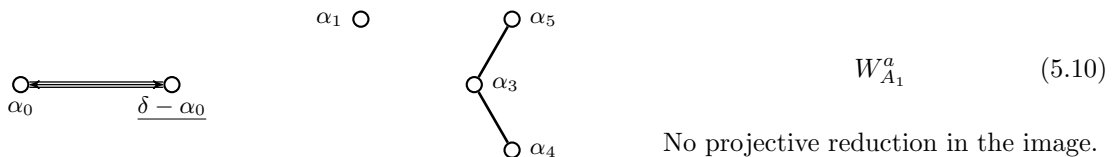

5.2 $E_7^{(1)}/A_1^{(1)}$ surface

Action on coordinates $F = f\nu_1^{-1}, G = g\nu_1$ (where f, g — notations of [KNY17]):

coord.	s_0	s_1	s_2	s_3	s_4	s_5	s_6	s_7	π
F	$1/G$	F	F	$a_3^{-1}F$	$a_4^{-1} \frac{(a_0 a_4 - 1)FG + (1 - a_0)F + a_0(1 - a_4)}{(1 - a_4^{-1})FG + (a_0 - 1)G + a_4^{-1} - a_0}$	F	F	F	$a_0 a_4 / F$
G	$1/F$	G	G	$a_3 G$	$a_4 G$	G	G	G	a_4^{-1} / G

Anticanonical divisor has two components, represented by:

$$FG = 1, \quad FG = a_0 \quad (5.11)$$

Root data and point configuration:

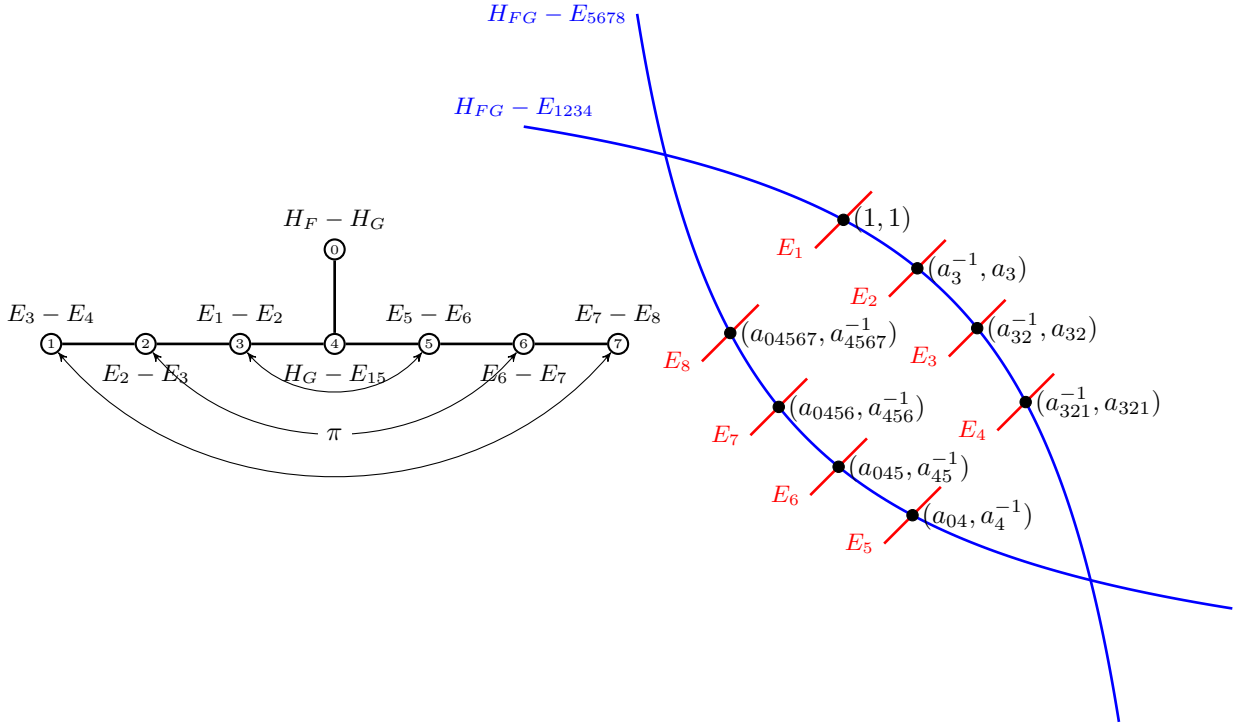

5.2.1 π

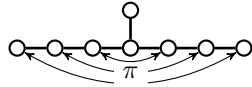

$$w = \pi : \begin{aligned} F &\mapsto a_{04}/F \\ G &\mapsto a_4^{-1}/G \end{aligned} \quad (5.12)$$

Under w we have 4 fixed points:

sing. pt.	action	except. div.	Image
$(a_{04}^{1/2}, a_4^{-1/2})$	$-\text{Id}_{2 \times 2}$	A_1	$\mathcal{H}_G - \mathcal{E}_{12}$
$(-a_{04}^{1/2}, a_4^{-1/2})$	$-\text{Id}_{2 \times 2}$	A_1	$\mathcal{H}_F - \mathcal{E}_{13}$
$(a_{04}^{1/2}, -a_4^{-1/2})$	$-\text{Id}_{2 \times 2}$	A_1	$\mathcal{H}_F - \mathcal{E}_{24}$
$(-a_{04}^{1/2}, -a_4^{-1/2})$	$-\text{Id}_{2 \times 2}$	A_1	$\mathcal{H}_G - \mathcal{E}_{34}$

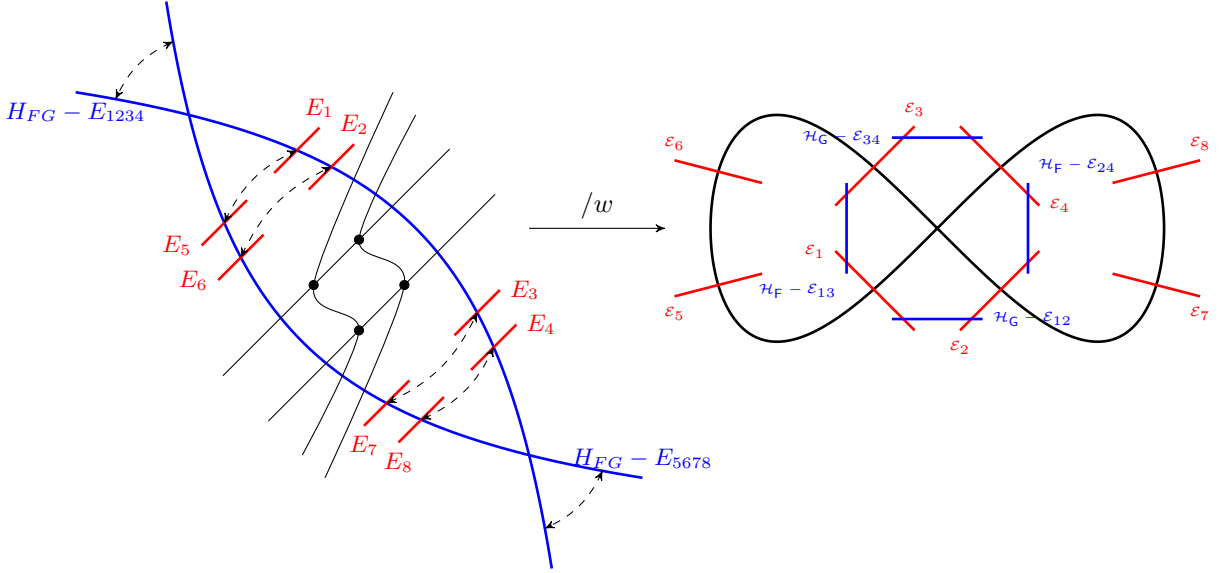

Preimages of (-1) curves:

Curve	$(a_{04}^{1/2}, a_4^{-1/2})$	$(-a_{04}^{1/2}, a_4^{-1/2})$	$(a_{04}^{1/2}, -a_4^{-1/2})$	$(-a_{04}^{1/2}, -a_4^{-1/2})$	Image
$F = a_{04}^{1/2}$	$dF = 0$	-	$dF = 0$	-	\mathcal{E}_2
$F = -a_{04}^{1/2}$	-	$dF = 0$	-	$dF = 0$	\mathcal{E}_3
$G = a_4^{-1/2}$	$dG = 0$	-	$dG = 0$	-	\mathcal{E}_1
$G = -a_4^{-1/2}$	-	$dG = 0$	-	$dG = 0$	\mathcal{E}_4

Under factorization we obtain already minimal surface $E_8^{(1)}/A_0^{(1)}$ with parameters and coordinates

$$\begin{aligned}
 F &= \frac{1 - a_0^{1/2}}{a_4^{1/2}} \frac{F - a_0^{1/2} a_4 G}{FG - a_0^{1/2}} \\
 G &= \frac{1 + a_0^{1/2}}{a_4^{1/2}} \frac{F + a_0^{1/2} a_4 G}{FG + a_0^{1/2}}
 \end{aligned}
 \tag{5.13}$$

Symmetry lattice is $D_5^{(1)}$, nodal curves and lattice is $\Phi_{\text{nod}} = 4A_1$, $\bar{\Phi}_{\text{nod}} = D_4$, $\bar{\Phi}_{\text{nod}}/\Phi_{\text{nod}}$ is generated by $\mathcal{E}_4 - \mathcal{E}_2 = -\alpha_{12}$, $\chi(-\alpha_{12}) = -1$, symmetry group is as follows:

$$S_3 \times (C_2^2 \times W_{D_4}^a) \simeq S_4 \times W_{D_4}^a \tag{5.14}$$

No projective reduction in the image.

where $s = s_{45342103} s_{02} s_{45342103}^{-1}$. Here we obtain additional $C_2^2 = \text{Aut}^{\text{nod}}$, generated by s_{13} and s_{430434} , which changes root branches of $a_0^{1/2}$ and $a_4^{1/2}$ respectively.

5.2.2 $3A_1$

$$w = s_{013} : \begin{aligned}
 F &\mapsto -1/G \\
 G &\mapsto -1/F
 \end{aligned}
 \tag{5.15}$$

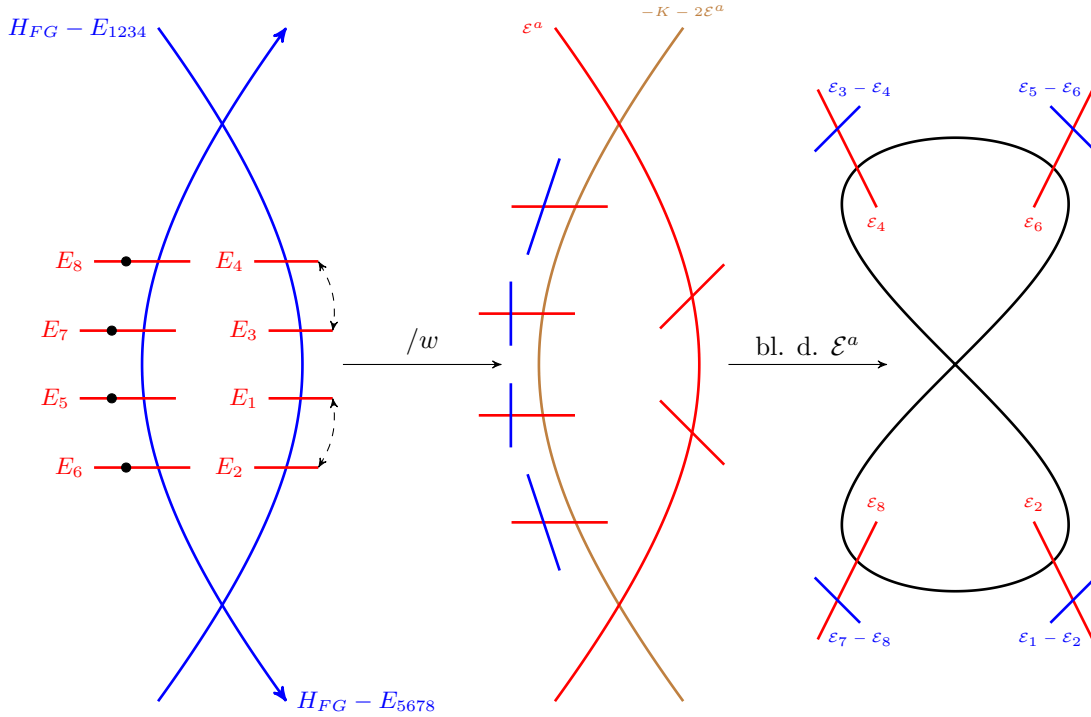

Under w we have non-singular pointwise invariant curve $FG = -1$ and 4 fixed points on blowups on this curve:

sing. pt.	action	except. div.	Image
$\left(\frac{F+a_4}{G-a_4^{-1}} = -a_4^2, G = a_4^{-1}\right)$	$-\text{Id}_{2 \times 2}$	A_1	$\mathcal{E}_1 - \mathcal{E}_2$
$\left(\frac{F+a_{45}}{G-a_{45}^{-1}} = -a_{45}^2, G = a_{45}^{-1}\right)$	$-\text{Id}_{2 \times 2}$	A_1	$\mathcal{E}_3 - \mathcal{E}_4$
$\left(\frac{F+a_{456}}{G-a_{456}^{-1}} = -a_{456}^2, G = a_{456}^{-1}\right)$	$-\text{Id}_{2 \times 2}$	A_1	$\mathcal{E}_5 - \mathcal{E}_6$
$\left(\frac{F+a_{4567}}{G-a_{4567}^{-1}} = -a_{4567}^2, G = a_{4567}^{-1}\right)$	$-\text{Id}_{2 \times 2}$	A_1	$\mathcal{E}_7 - \mathcal{E}_8$

Under factorization we obtain non-minimal surface. Blowing down (-1) curve \mathcal{E}^a we obtain surface $E_8^{(1)}/A_0^{(1)}$ with parameters and coordinates

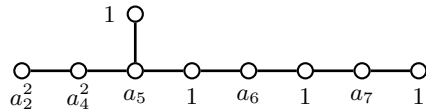

$$\begin{aligned} F &= 2a_4 \frac{a_2^2 F - G}{FG - 1} \\ G &= 2a_4 \frac{F - G}{FG - 1} \end{aligned} \quad (5.16)$$

Symmetry lattice is $D_5^{(1)}$, nodal curves and lattice is $\overline{\Phi}_{\text{nod}} = \Phi_{\text{nod}} = 4A_1$, symmetry group is as follows

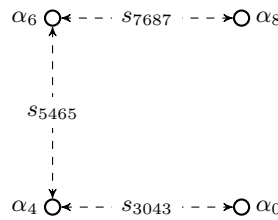
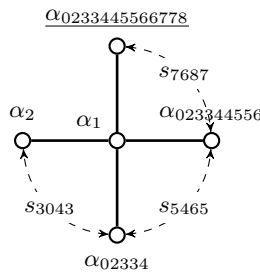

$$\begin{aligned} S_4 \times W_{D_4}^a & \quad (5.17) \\ t_{\omega_3 - \omega_{57}}^{1/2} & \leftarrow t_{\omega_5 - \omega_6} \\ t_{\omega_5 - 2\omega_7}^{1/2} & \leftarrow t_{\omega_6} \end{aligned}$$

5.2.3 $4A_1$

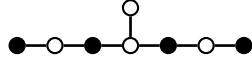

$$w = s_1 s_3 s_5 s_7 : \begin{aligned} F &\mapsto -F \\ G &\mapsto -G \end{aligned} \quad (5.18)$$

Under w we have 4 fixed points:

sing. pt.	action	except. div.	Image
$(0, 0)$	$-\text{Id}_{2 \times 2}$	A_1	$\mathcal{E}_7 - \mathcal{E}_8$
$(0, \infty)$	$(F, G^{-1}) : -\text{Id}_{2 \times 2}$	A_1	$\mathcal{H}_G - \mathcal{E}_{34}$
$(\infty, 0)$	$(F^{-1}, G) : -\text{Id}_{2 \times 2}$	A_1	$\mathcal{H}_G - \mathcal{E}_{78}$
(∞, ∞)	$(F^{-1}, G^{-1}) : -\text{Id}_{2 \times 2}$	A_1	$\mathcal{E}_3 - \mathcal{E}_4$

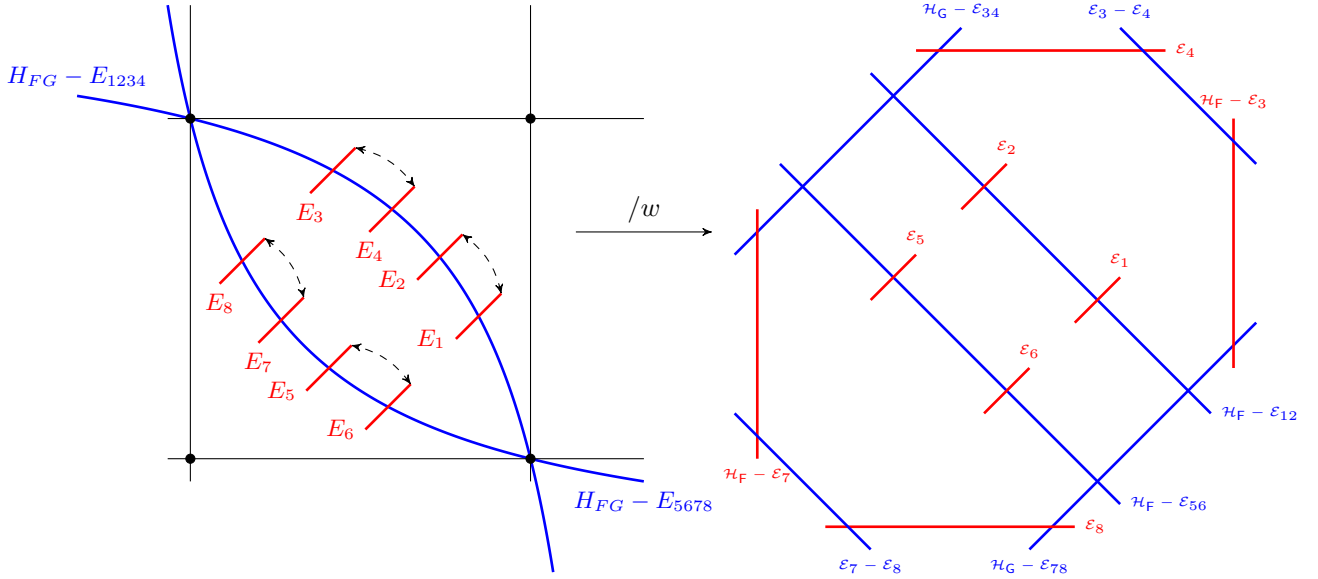

Preimages of (-1) curves:

Curve	$(0, 0)$	$(0, \infty)$	$(\infty, 0)$	(∞, ∞)	Image
$F = 0$	$dF = 0$	$dF = 0$	-	-	$\mathcal{H}_F - \mathcal{E}_7$
$F = \infty$	-	-	$dF^{-1} = 0$	$dF^{-1} = 0$	$\mathcal{H}_F - \mathcal{E}_3$
$G = 0$	$dG = 0$	-	$dG = 0$	-	\mathcal{E}_8
$G = \infty$	-	$dG^{-1} = 0$	-	$dG^{-1} = 0$	\mathcal{E}_4

Under factorization we obtain already minimal surface $D_5^{(1)}/A_3^{(1)}$ with parameters and coordinates

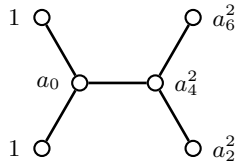

$$\begin{aligned} F &= \frac{FG - a_0}{FG - 1} \\ G &= G^2. \end{aligned} \quad (5.19)$$

Symmetry lattice is $A_3^{(1)}$, nodal curves and lattice is $\bar{\Phi}_{\text{nod}} = \Phi_{\text{nod}} = 2A_1$, symmetry group is as follows:

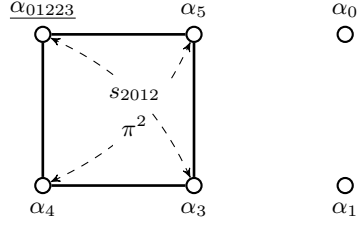

$$C_2^2 \times W_{A_3}^a \quad (5.20)$$

No projective reduction in the image.

5.2.4 $3A_2$

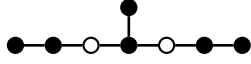

$$w = s_{12}s_{40}s_{76} : \begin{aligned} F &\mapsto -\frac{\zeta + F + \zeta^{-1}FG}{1 + \zeta^{-1}G + \zeta FG} \\ G &\mapsto \zeta^{-1}/F. \end{aligned} \quad (5.21)$$

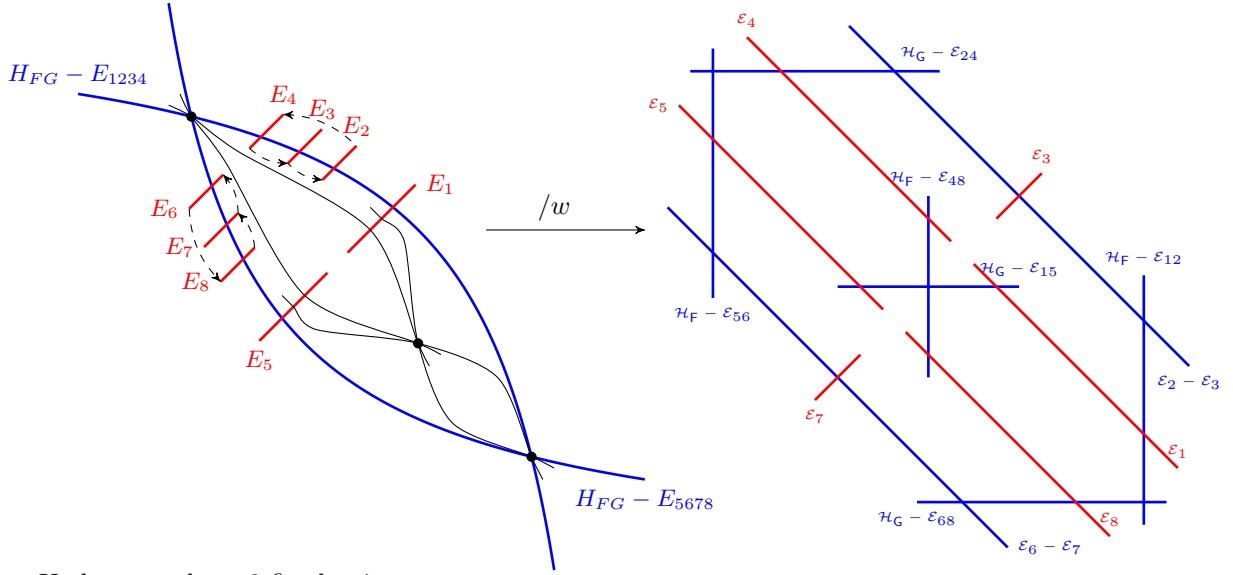

Under w we have 3 fixed points:

sing. pt.	action	except. div.	Image
$(-\zeta, -\zeta)$	$\begin{pmatrix} -1 & 1 \\ -1 & 0 \end{pmatrix}$	A_2	$\mathcal{H}_F - \mathcal{E}_{48}, \mathcal{H}_G - \mathcal{E}_{15}$
$(0, \infty)$	$(F, G^{-1}) : \begin{pmatrix} -1 & -\zeta^{-1} \\ \zeta & 0 \end{pmatrix}$	A_2	$\mathcal{H}_F - \mathcal{E}_{56}, \mathcal{H}_G - \mathcal{E}_{24}$
$(\infty, 0)$	$(F^{-1}, G) : \begin{pmatrix} -1 & -\zeta \\ \zeta^{-1} & 0 \end{pmatrix}$	A_2	$\mathcal{H}_F - \mathcal{E}_{12}, \mathcal{H}_G - \mathcal{E}_{68}$

Preimages of (-1) curves:

Curve	$(-\zeta, -\zeta)$	$(0, \infty)$	$(\infty, 0)$	Image
$1 + (\zeta^{-1} - \zeta)F = FG$	$dF \sim -\zeta^{-1}dG$	$dG^{-1} \sim dF$	-	\mathcal{E}_5
$\zeta^{-1} - (\zeta^{-1} - \zeta)F = \zeta FG$	$dF \sim -\zeta dG$	$dG^{-1} \sim \zeta^{-1}dF$	-	\mathcal{E}_4
$1 + (\zeta^{-1} - \zeta)G = FG$	$dF \sim -\zeta dG$	-	$dF^{-1} \sim dG$	\mathcal{E}_8
$\zeta^{-1} - (\zeta^{-1} - \zeta)G = \zeta FG$	$dF \sim -\zeta^{-1}dG$	-	$dF^{-1} \sim \zeta^{-1}dG$	\mathcal{E}_1

Under factorization we obtain already minimal surface $E_3^{(1)}/A_5^{(1)}$ (in variant (b)) with parameters and coordinates

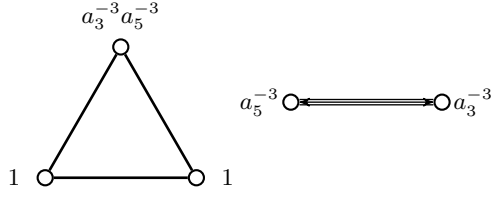

$$\begin{aligned}
 F &= \frac{\zeta^{-1} - \zeta}{3} \frac{FG - 1}{FG - \zeta} \frac{(\zeta^{-1} - 1)(FG - 1) - 3\zeta F}{\zeta + (1 - \zeta)G - FG} \\
 G &= \frac{\zeta^{-1} - \zeta}{3} \frac{FG - 1}{FG - \zeta} \frac{(\zeta^{-1} - 1)(FG - 1) - 3\zeta G}{\zeta + (1 - \zeta)F - FG}
 \end{aligned} \tag{5.22}$$

Symmetry lattice is $A_1^{(1)}$, nodal curves and lattice is $\bar{\Phi}_{\text{nod}} = \Phi_{\text{nod}} = A_2$, symmetry group is as follows:

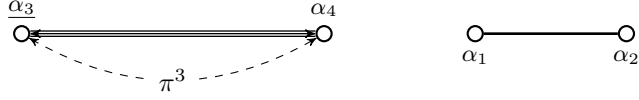

$$W_{A_1}^{ae} \tag{5.23}$$

No projective reduction in the image.

5.2.5 $2A_3$

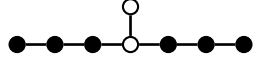

$$\begin{aligned}
 w = s_{321}s_{765} : \quad & F \mapsto -iF \\
 & G \mapsto iG
 \end{aligned} \tag{5.24}$$

See Sec. 3

5.2.6 $\pi \times 5A_1$

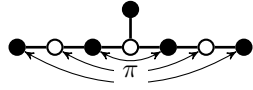

$$\begin{aligned}
 w = \pi s_0 s_1 s_3 : \quad & F \mapsto a_4 G \\
 & G \mapsto -a_4^{-1} F
 \end{aligned} \tag{5.25}$$

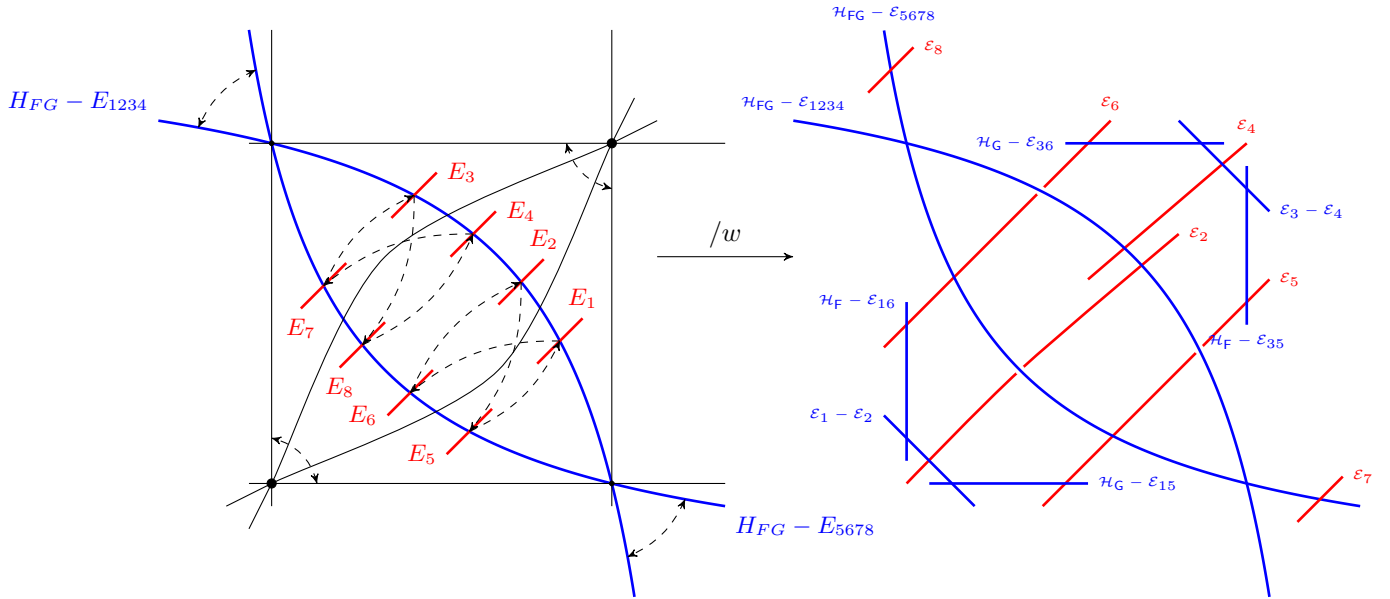

We have 2 fixed points under w and 2 fixed points under w^2 (small circles on the picture)

sing. pt.	action	except. div.	Image
$(0, 0)$	$\begin{pmatrix} 0 & a_4 \\ -a_4^{-1} & 0 \end{pmatrix}$	A_3	$\mathcal{H}_F - \mathcal{E}_{16}, \mathcal{E}_1 - \mathcal{E}_2, \mathcal{H}_G - \mathcal{E}_{15}$
(∞, ∞)	$\begin{pmatrix} 0 & a_4^{-1} \\ -a_4 & 0 \end{pmatrix}$	A_3	$\mathcal{H}_F - \mathcal{E}_{35}, \mathcal{E}_3 - \mathcal{E}_4, \mathcal{H}_G - \mathcal{E}_{36}$
$(0, \infty)$	$w^2 : -\text{Id}_{2 \times 2}$	A_1	$\mathcal{H}_{FG} - \mathcal{E}_{1234}$
$(\infty, 0)$	$w^2 : -\text{Id}_{2 \times 2}$	A_1	

Preimages of (-1) curves:

Curve	$(0, 0)$	$(0, \infty)$	$(\infty, 0)$	(∞, ∞)	Image
$F = 0 \sqcup G = 0$	$dF = 0 \sqcup dG = 0$	$dF = 0$	$dG = 0$	-	\mathcal{E}_2
$F = \infty \sqcup G = \infty$	-	$dG^{-1} = 0$	$dF^{-1} = 0$	$dF^{-1} = 0 \sqcup dG^{-1} = 0$	\mathcal{E}_4
$F = ia_4 G$	$dF = ia_4 dG$	-	-	$dG^{-1} = ia_4 dF^{-1}$	\mathcal{E}_5
$F = -ia_4 G$	$dF = -ia_4 dG$	-	-	$dG^{-1} = -ia_4 dF^{-1}$	\mathcal{E}_6

Under factorization we obtain already minimal surface $E_7^{(1)}/A_1^{(1)}$ with parameters and coordinates

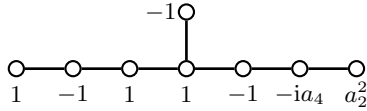

$$\begin{aligned} F &= \frac{(F - ia_4 G) - FG(F + ia_4 G)}{(F - ia_4 G) + FG(F + ia_4 G)} \\ G &= \frac{(F + ia_4 G) + FG(F - ia_4 G)}{(F + ia_4 G) - FG(F - ia_4 G)} \end{aligned} \quad (5.26)$$

Symmetry lattice is $A_1^{(1)}$, nodal curves and lattice is $\Phi_{\text{nod}} = 2A_3$, $\bar{\Phi}_{\text{nod}} = D_6$, $\bar{\Phi}_{\text{nod}}/\Phi_{\text{nod}}$ is generated by $-\mathcal{H}_{FG} + \mathcal{E}_{2456} = -\alpha_{01233445}$, $\chi(-\alpha_{01233445}) = -1$, symmetry group is as follows:

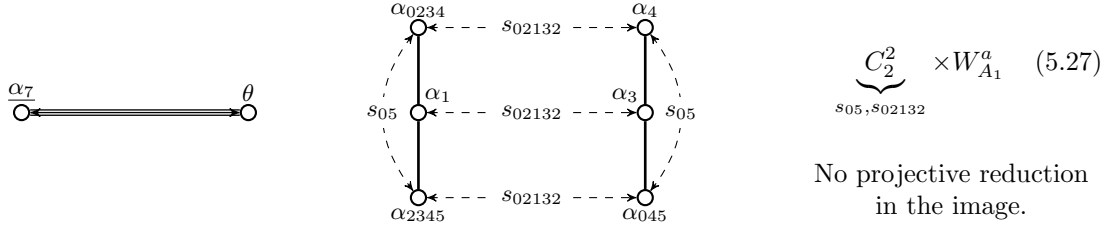

No projective reduction
in the image.

where $\text{Aut}^{\text{nod}} = C_2^2$ come from nontrivial action of $W_{\Phi^{a, \pm w}}$.

5.3 $E_6^{(1)}/A_2^{(1)}$ surface

Action on coordinates $F = f\nu_1^{-1}, G = g\nu_1$ (where f, g — notations of [KNY17]):

coord.	s_0	s_1	s_2	s_3	s_4	s_5	s_6	π
F	F	F	$F \frac{G-1}{(1-a_2)FG+a_2G-1}$	a_3F	F	F	$a_6^{-1}F$	$\frac{FG-1}{(1+a_3)FG-a_3F-G}$
G	G	G	a_2G	$a_3^{-1}G$	G	G	$a_6G \frac{F-1}{F+(a_6-1)FG-a_6}$	a_3F

Root data and point configuration:

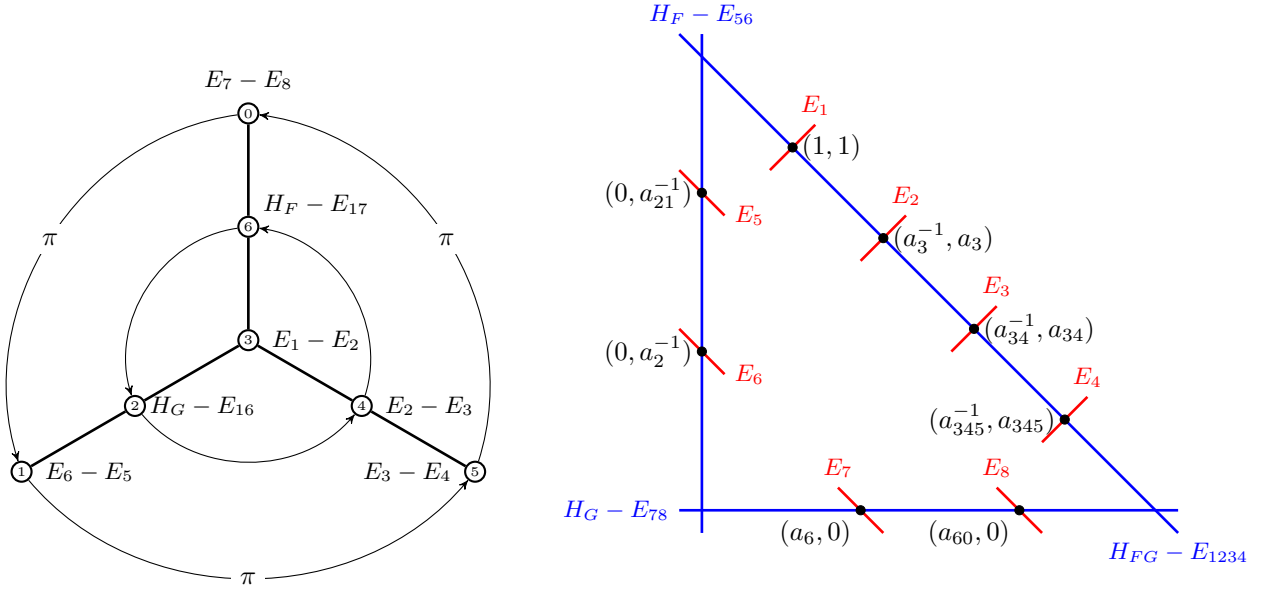

5.3.1 π

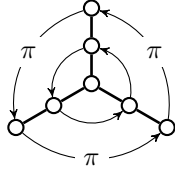

$$w = \pi : \begin{aligned} F &\mapsto \frac{FG-1}{FG(1+a_3)-a_3F-G} \\ G &\mapsto a_3F \end{aligned} \quad (5.28)$$

Under w we have 3 fixed points:

sing. pt.	action	except. div.	Image
$(F = \frac{1-\zeta a_3^{1/3}-\zeta^{-1}a_3^{-1/3}}{1+a_3}, G = a_3F)$	$\begin{pmatrix} -1 & -a_3^{-1} \\ a_3 & 0 \end{pmatrix}$	A_2	$\mathcal{H}_F - \mathcal{E}_{13}, \mathcal{H}_G - \mathcal{E}_{46}$
$(F = \frac{1-\zeta^{-1}a_3^{1/3}-\zeta a_3^{-1/3}}{1+a_3}, G = a_3F)$	$\begin{pmatrix} -1 & -a_3^{-1} \\ a_3 & 0 \end{pmatrix}$	A_2	$\mathcal{H}_F - \mathcal{E}_{26}, \mathcal{H}_G - \mathcal{E}_{35}$
$(F = \frac{1-a_3^{1/3}-a_3^{-1/3}}{1+a_3}, G = a_3F)$	$\begin{pmatrix} -1 & -a_3^{-1} \\ a_3 & 0 \end{pmatrix}$	A_2	$\mathcal{H}_F - \mathcal{E}_{45}, \mathcal{H}_G - \mathcal{E}_{12}$

Let us introduce curves

$$\text{crv}_1(a_3^{1/3}) = (a_3^{2/3}F+G-a_3^{1/3}) - (1-a_3^{1/3}+a_3^{2/3})FG, \quad (5.29)$$

$$\text{crv}_2(a_3^{1/3}) = (a_3F+a_3^{-1/3}G-a_3^{1/3}) - (1-a_3^{1/3}+a_3^{2/3})FG \quad (5.30)$$

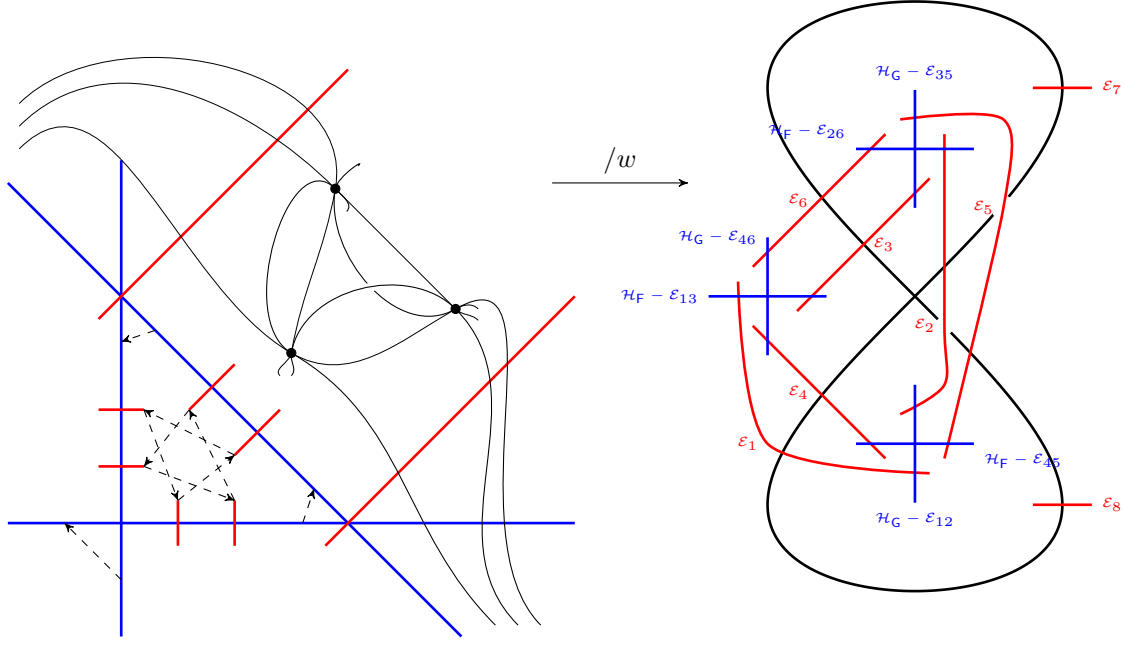

Preimages of (-1) curves:

Curve	sing. pt. 1	sing. pt. 2	sing. pt. 3	Image
$\text{crv}_1(a_3^{1/3}) = 0$	$dF = \zeta a_3^{-1} dG$	$dF = \zeta^{-1} a_3^{-1} dG$	-	\mathcal{E}_6
$\text{crv}_1(\zeta^{-1} a_3^{1/3}) = 0$	$dF = \zeta^{-1} a_3^{-1} dG$	-	$dF = \zeta a_3^{-1} dG$	\mathcal{E}_1
$\text{crv}_1(\zeta a_3^{1/3}) = 0$	-	$dF = \zeta a_3^{-1} dG$	$dF = \zeta^{-1} a_3^{-1} dG$	\mathcal{E}_5
$\text{crv}_2(a_3^{1/3}) = 0$	$dF = \zeta^{-1} a_3^{-1} dG$	$dF = \zeta a_3^{-1} dG$	-	\mathcal{E}_3
$\text{crv}_2(\zeta^{-1} a_3^{1/3}) = 0$	$dF = \zeta a_3^{-1} dG$	-	$dF = \zeta^{-1} a_3^{-1} dG$	\mathcal{E}_4
$\text{crv}_2(\zeta a_3^{1/3}) = 0$	-	$dF = \zeta^{-1} a_3^{-1} dG$	$dF = \zeta a_3^{-1} dG$	\mathcal{E}_2

We already obtain minimal $E_8^{(1)}/A_0^{(1)}$ with parameters and coordinates

$$\begin{array}{c}
 \begin{array}{cccccccc}
 & & a_3^{-1/3} & & & & & \\
 & & | & & & & & \\
 \circ & \circ & \circ & \circ & \circ & \circ & \circ & \circ \\
 \zeta & 1 & \zeta^{-1} & \zeta^{-1} & \zeta & \zeta & a_3^{1/3} & a_0
 \end{array} \\
 \begin{array}{l}
 F = a_3^{-1/3} \frac{\zeta a_3 + (a_3 F - \zeta G)^2 - (1 + a_3)(a_3 F + \zeta^{-1} G) F G}{a_3 F + \zeta G + (\zeta^{-1} - 1)(a_3 F - \zeta^{-1} G) F G - \zeta^{-1}(1 + a_3) F^2 G^2} \\
 G = \zeta^{-1} a_3^{-1/3} \frac{\zeta^{-1} a_3 + (a_3 F - \zeta^{-1} G)^2 - (1 + a_3)(a_3 F + \zeta G) F G}{a_3 F + \zeta^{-1} G + (\zeta - 1)(a_3 F - \zeta G) F G - \zeta(1 + a_3) F^2 G^2}
 \end{array}
 \end{array} \quad (5.31)$$

Symmetry lattice is $A_2^{(1)}$, nodal curves and lattice is $\Phi_{\text{nod}} = 3A_2$, $\bar{\Phi}_{\text{nod}} = E_6$, $\bar{\Phi}_{\text{nod}}/\Phi_{\text{nod}}$ is generated by $-\mathcal{H}_{FGG} + \mathcal{E}_{123456} = -\alpha_0^2 12^3 3^4 4^3 5^2 6$, $\chi(-\alpha_0^2 12^3 3^4 4^3 5^2 6) = \zeta^{-1}$, symmetry group is as follows:

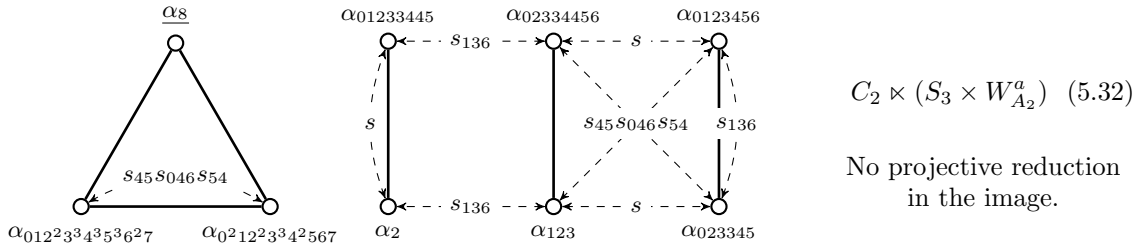

$$C_2 \times (S_3 \times W_{A_2}^a) \quad (5.32)$$

No projective reduction in the image.

where $s = s_{0304}s_{135}s_{4030}$ generate Galois group, $s_{136}s$ changes branch of root $a_3^{1/3}$, they generate additional group $S_3 = \text{Aut}^{\text{nod}}$, corresponding to permutation of the fixed points in the preimage.

5.3.2 $2A_2$

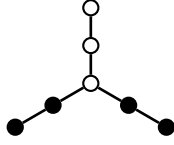

$$w = s_{12}s_{45} : \begin{aligned} F &\mapsto \frac{F(1-G)}{1-\zeta G + (\zeta-1)FG} \\ G &\mapsto \zeta G \end{aligned} \quad (5.33)$$

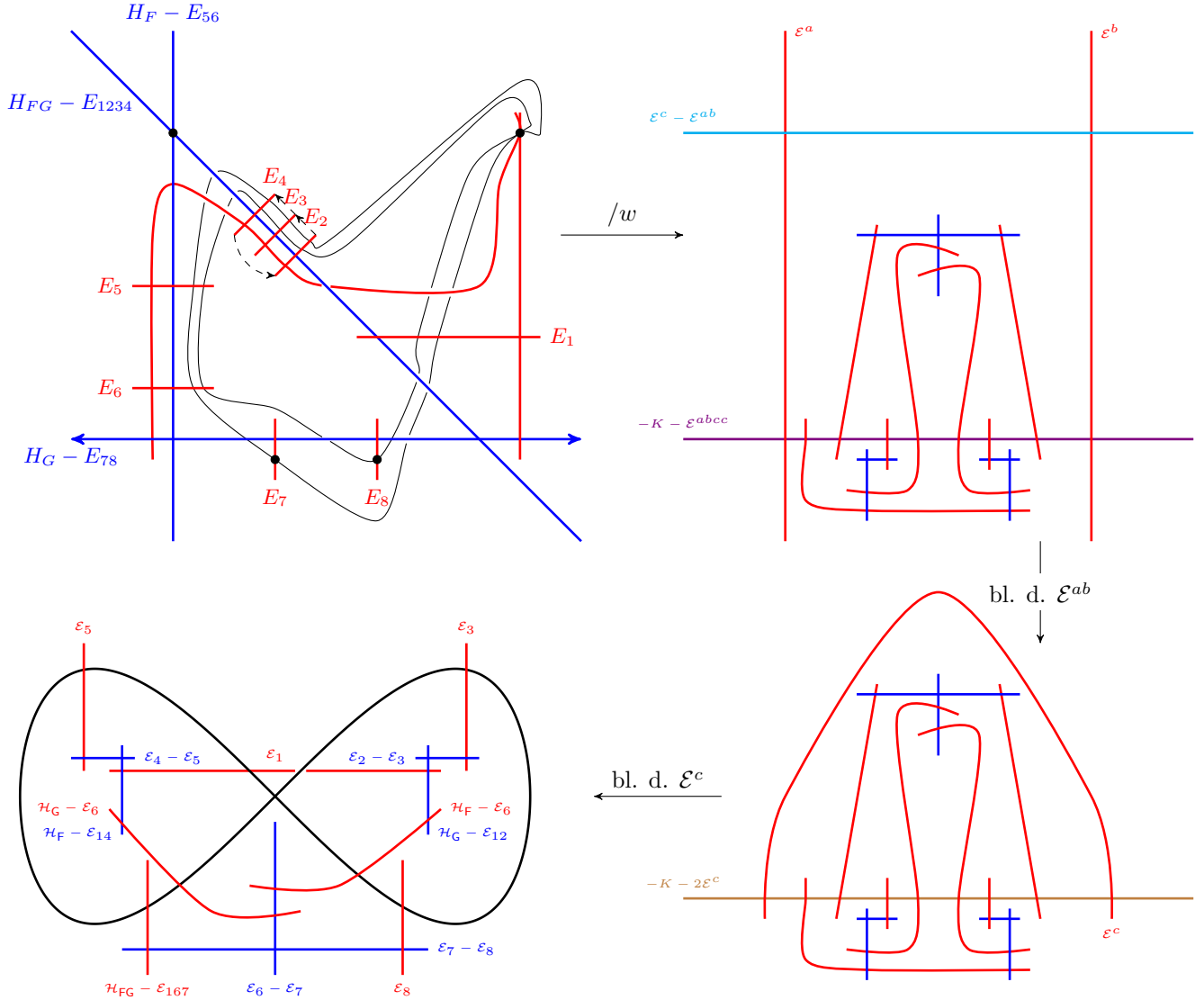

Under w we have pointwise invariant curve $G = 0$ and 4 fixed singular points on blowups on this curve:

sing. pt.	action	except. div.	Image
$((F - a_6)/G = -a_6(a_6 - 1), G = 0)$	$\begin{pmatrix} \zeta^{-1} & * \\ 0 & \zeta \end{pmatrix}$	A_2	$\mathcal{E}_2 - \mathcal{E}_3, \mathcal{H}_G - \mathcal{E}_{12}$
$((F - a_{06})/G = -a_{06}(a_{06} - 1), G = 0)$	$\begin{pmatrix} \zeta^{-1} & * \\ 0 & \zeta \end{pmatrix}$	A_2	$\mathcal{E}_4 - \mathcal{E}_5, \mathcal{H}_F - \mathcal{E}_{14}$
$(0, \infty)$	$(F, G^{-1}) : \begin{pmatrix} \zeta^{-1} & 0 \\ 0 & \zeta^{-1} \end{pmatrix}$	(-3)	$\mathcal{E}^c - \mathcal{E}^a - \mathcal{E}^b \mapsto p$
$(1, \infty)$	$(F - 1, G^{-1}) : \begin{pmatrix} \zeta & 0 \\ 0 & \zeta^{-1} \end{pmatrix}$	A_2	$\mathcal{E}_6 - \mathcal{E}_7, \mathcal{E}_7 - \mathcal{E}_8$

Preimages of (-1) curves:

Curve	sing. pt. 1	sing. pt. 2	$(1, \infty)$	Image
$F = 1$	-	-	$dF = 0$	\mathcal{E}_8
$G(1+G)(1-F) = a_3^3 F - 1$	-	-	$dF = 0$	$\mathcal{H}_{FG} - \mathcal{E}_{167}$
$\text{crv}(a_6) = 0$	$d\frac{F-a_6}{G} = a_6(a_6-1)^2 dG$	-	$dG^{-1} = 0$	$\mathcal{H}_F - \mathcal{E}_6$
$\text{crv}(a_{06}) = 0$	-	$d\frac{F-a_{06}}{G} = a_{06}(a_{06}-1)^2 dG$	$dG^{-1} = 0$	$\mathcal{H}_G - \mathcal{E}_6$
(*) $F = 1 + \frac{1}{qa_{06}}$	$d\frac{F-a_6}{G} = a_6(a_6-1)^2 dG$	$d\frac{F-a_{06}}{G} = a_{06}(a_{06}-1)^2 dG$	-	\mathcal{E}_1

where $\text{crv}(a_6) = G(G+1)(F-1)^2 + (a_3^3 - a_6^{-1})(a_6-1)F^2G + (F-a_6)(a_3^3F - a_6^{-1}) = 0$. Last curve is complicated $(3, 2)$ curve, which is not drawn in the preimage (*), for its explicit formula see (5.34).

Under factorization we obtain non-minimal surface. Blowing down (-1) curves $\mathcal{E}^a, \mathcal{E}^b$ and then (-1) curve \mathcal{E}^c , we obtain surface $E_8^{(1)}/A_0^{(1)}$ with parameters and coordinates

$$F = a_{06}^{-1}HF + \frac{1}{qHF} + \frac{(H-1)^3}{qHF(1-a_6^{-1}HF)} \quad (5.34)$$

$$G = a_6^{-1}HF + \frac{1}{qHF} + \frac{(H-1)^3}{qHF(1-a_{06}^{-1}HF)}$$

where

$$H = \frac{G-1}{FG-1}, \quad q = a_0 a_6^2 a_3^3 \quad (5.35)$$

Symmetry lattice is $A_2^{(1)}$, nodal curves and lattice is $\bar{\Phi}_{\text{nod}} = \Phi_{\text{nod}} = 3A_2$, symmetry group is as follows:

$$S_3 \times W_{A_2}^a \quad (5.36)$$

$$t_{\omega_0+2\omega_1-2\omega_4+\omega_6}^{1/3} \leftarrow t_{\omega_6}$$

5.3.3 $4A_1$

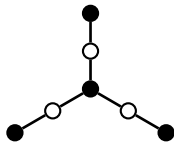

$$w = s_0 s_1 s_3 s_5 : \begin{aligned} F &\mapsto -F \\ G &\mapsto -G \end{aligned} \quad (5.37)$$

Under w we have 4 fixed points:

sing. pt.	action	except. div.	Image
$(0, 0)$	$-\text{Id}_{2 \times 2}$	A_1	$\mathcal{H}_F - \mathcal{E}_{12}$
$(0, \infty)$	$(F, G^{-1}) : -\text{Id}_{2 \times 2}$	A_1	$\mathcal{H}_G - \mathcal{E}_{24}$
$(\infty, 0)$	$(F^{-1}, G) : -\text{Id}_{2 \times 2}$	A_1	$\mathcal{H}_G - \mathcal{E}_{17}$
(∞, ∞)	$(F^{-1}, G^{-1}) : -\text{Id}_{2 \times 2}$	A_1	$\mathcal{H}_F - \mathcal{E}_{47}$

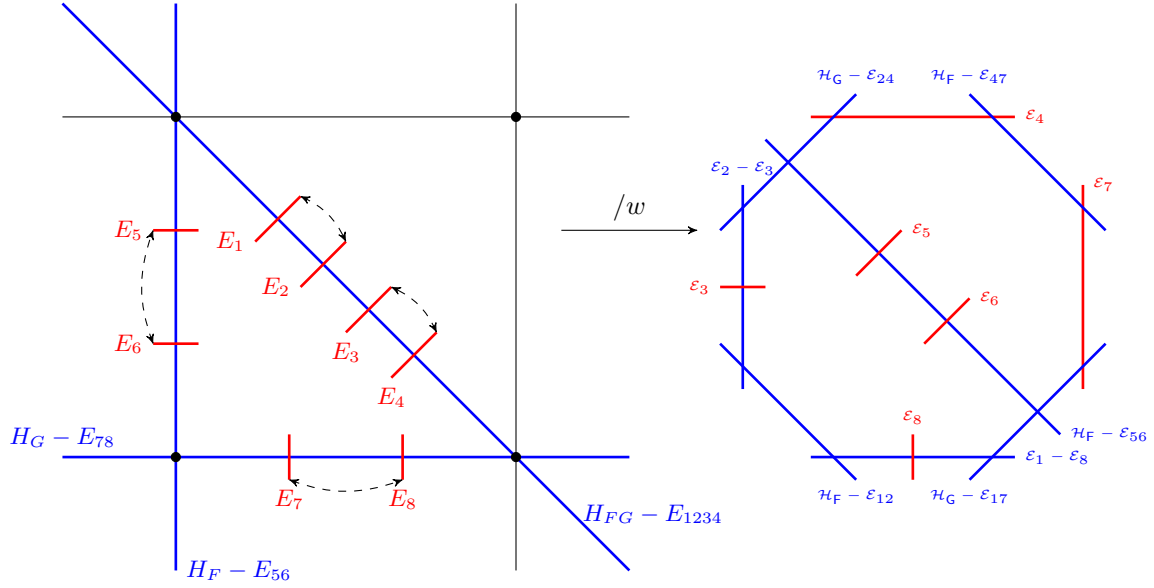

Preimages of (-1) curves:

Curve	$(0, 0)$	$(0, \infty)$	$(\infty, 0)$	(∞, ∞)	Image
$F = \infty$	-	-	$dF^{-1} = 0$	$dF^{-1} = 0$	\mathcal{E}_7
$G = \infty$	-	$dG^{-1} = 0$	-	$dG^{-1} = 0$	\mathcal{E}_4

Under factorization we obtain already minimal surface $E_3^{(1)}/A_5^{(1)}$ in variant (a) with parameters and coordinates (in variant a) and variant b))

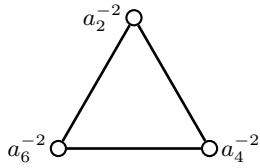

$$\begin{aligned} F &= 1 - \frac{1}{FG} \\ G &= a_6^2 G/F \end{aligned} \quad (5.38)$$

$$\begin{aligned} F &= \frac{G - F^{-1}}{G - F} \\ G &= G/F \end{aligned} \quad (5.39)$$

Symmetry lattice is $A_2^{(1)}$, nodal curves and lattice is $\bar{\Phi}_{\text{nod}} = \Phi_{\text{nod}} = A_1$, symmetry group is as follows:

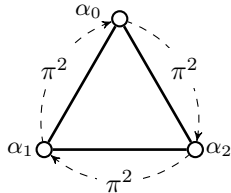

$$W_{A_2}^{ae} \quad (5.40)$$

No projective reduction in the image.

5.4 $D_5^{(1)}/A_3^{(1)}$ surface

Action on coordinates $F = f/\nu_3, G = g\nu_1$ (where f, g — notations of [KNY17]):

coord.	s_0	s_1	s_2	s_3	s_4	s_5	π
F	F	$a_1 F$	$a_2^{-1} F$	$F \frac{G^{-1}}{G - a_3^{-1}}$	F	F	$1/G$
G	G	G	$G \frac{F-1}{F-a_2}$	$a_3 G$	$a_4^{-1} G$	G	F/a_2

Root data and point configuration:

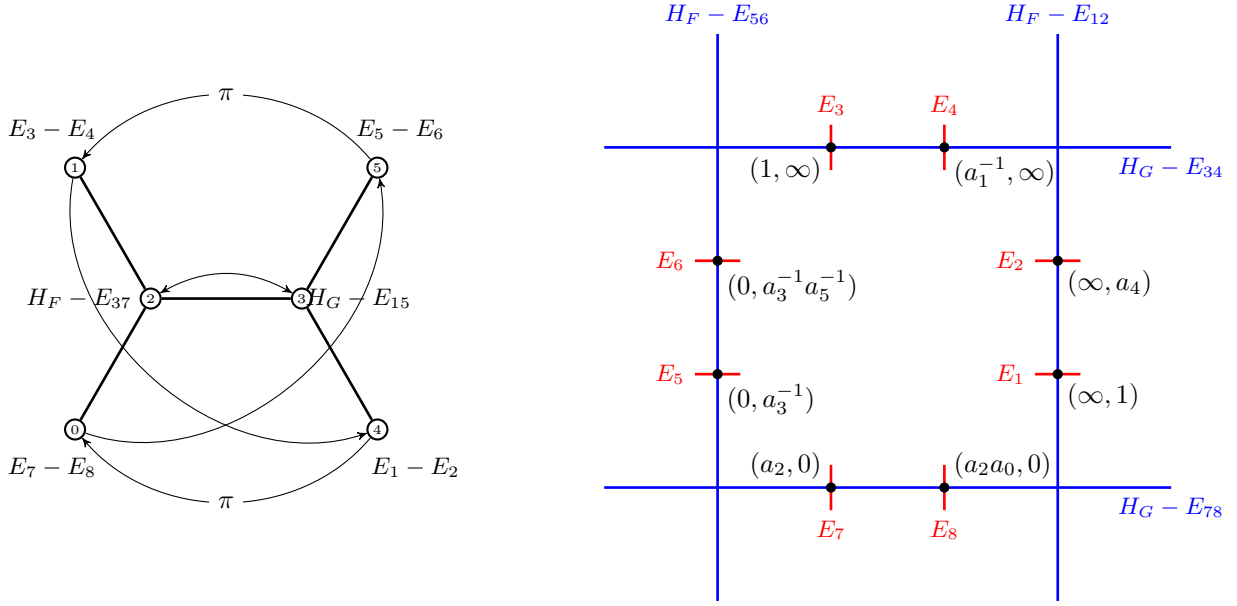

5.4.1 π^2

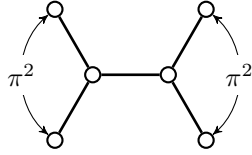

$$w = \pi^2 : \begin{aligned} F &\mapsto a_2/F \\ G &\mapsto a_3^{-1}/G \end{aligned} \quad (5.41)$$

Under w we have 4 fixed points:

sing. pt.	action	except. div.	Image
$(a_2^{1/2}, a_3^{-1/2})$	$-\text{Id}_{2 \times 2}$	A_1	$\mathcal{H}_G - \mathcal{E}_{26}$
$(-a_2^{1/2}, a_3^{-1/2})$	$-\text{Id}_{2 \times 2}$	A_1	$\mathcal{H}_F - \mathcal{E}_{25}$
$(a_2^{1/2}, -a_3^{-1/2})$	$-\text{Id}_{2 \times 2}$	A_1	$\mathcal{H}_F - \mathcal{E}_{16}$
$(-a_2^{1/2}, -a_3^{-1/2})$	$-\text{Id}_{2 \times 2}$	A_1	$\mathcal{H}_G - \mathcal{E}_{15}$

Preimages of (-1) curves:

Curve	$(a_2^{1/2}, a_3^{-1/2})$	$(-a_2^{1/2}, a_3^{-1/2})$	$(a_2^{1/2}, -a_3^{-1/2})$	$(-a_2^{1/2}, -a_3^{-1/2})$	Image
$F = a_2^{1/2}$	$dF = 0$	-	$dF = 0$	-	\mathcal{E}_6
$F = -a_2^{1/2}$	-	$dF = 0$	-	$dF = 0$	\mathcal{E}_5
$G = a_3^{-1/2}$	$dG = 0$	$dG = 0$	-	-	\mathcal{E}_2
$G = -a_3^{-1/2}$	-	-	$dG = 0$	$dG = 0$	\mathcal{E}_1

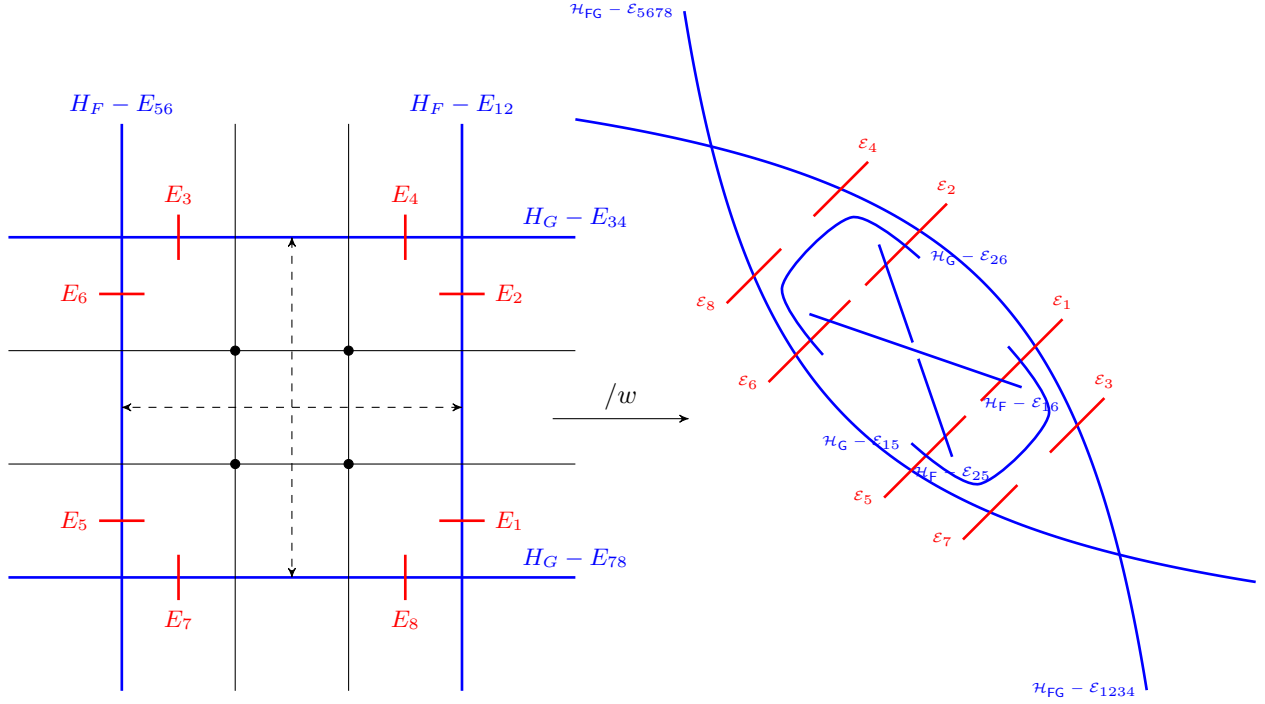

Under factorization we obtain already minimal surface $E_7^{(1)}/A_1^{(1)}$ with parameters and coordinates

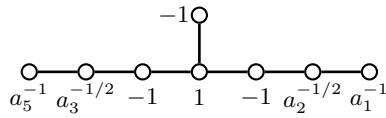

$$\begin{aligned}
 F &= -\frac{a_2^{-1/2} a_3^{1/2} FG - 1}{a_2^{-1/2} F - a_3^{1/2} G} \\
 G &= -\frac{a_2^{-1/2} F + a_3^{1/2} G}{a_2^{-1/2} a_3^{1/2} FG + 1}
 \end{aligned} \tag{5.42}$$

Symmetry lattice is $(3A_1)^{(1)}$, nodal curves and lattice is $\Phi_{\text{nod}} = 4A_1$, $\bar{\Phi}_{\text{nod}} = D_4$, $\bar{\Phi}_{\text{nod}}/\Phi_{\text{nod}}$ is generated by $-\mathcal{H}_{FG} + \mathcal{E}_{1256} = -\alpha_{03445}$, $\chi(-\alpha_{03445}) = -1$, symmetry group is as follows:

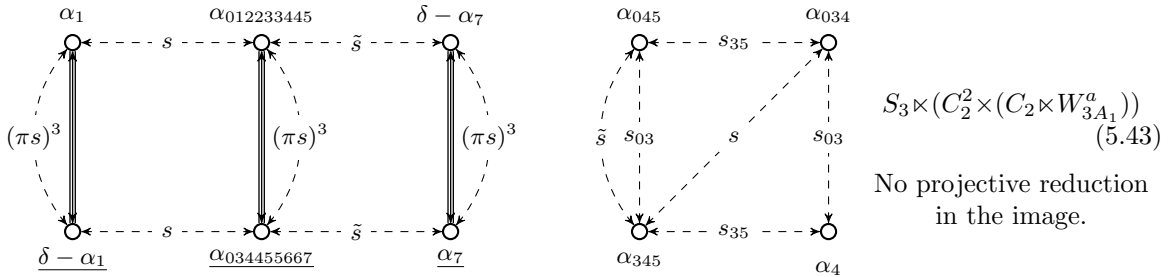

where $s = s_{234}s_{05}s_{432}$, $\tilde{s} = s_{654}s_{03}s_{456} = \pi s \pi$. Here we obtain additional $C_2^2 = \text{Aut}^{\text{nod}}$, generated by s_{05} and s_{03} , which changes root branches of $a_2^{1/2}$ and $a_3^{1/2}$ respectively.

5.4.2 $2A_1$

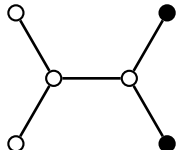

$$\begin{aligned}
 w = s_4 s_5 : \quad & F \mapsto F \\
 & G \mapsto -G
 \end{aligned} \tag{5.44}$$

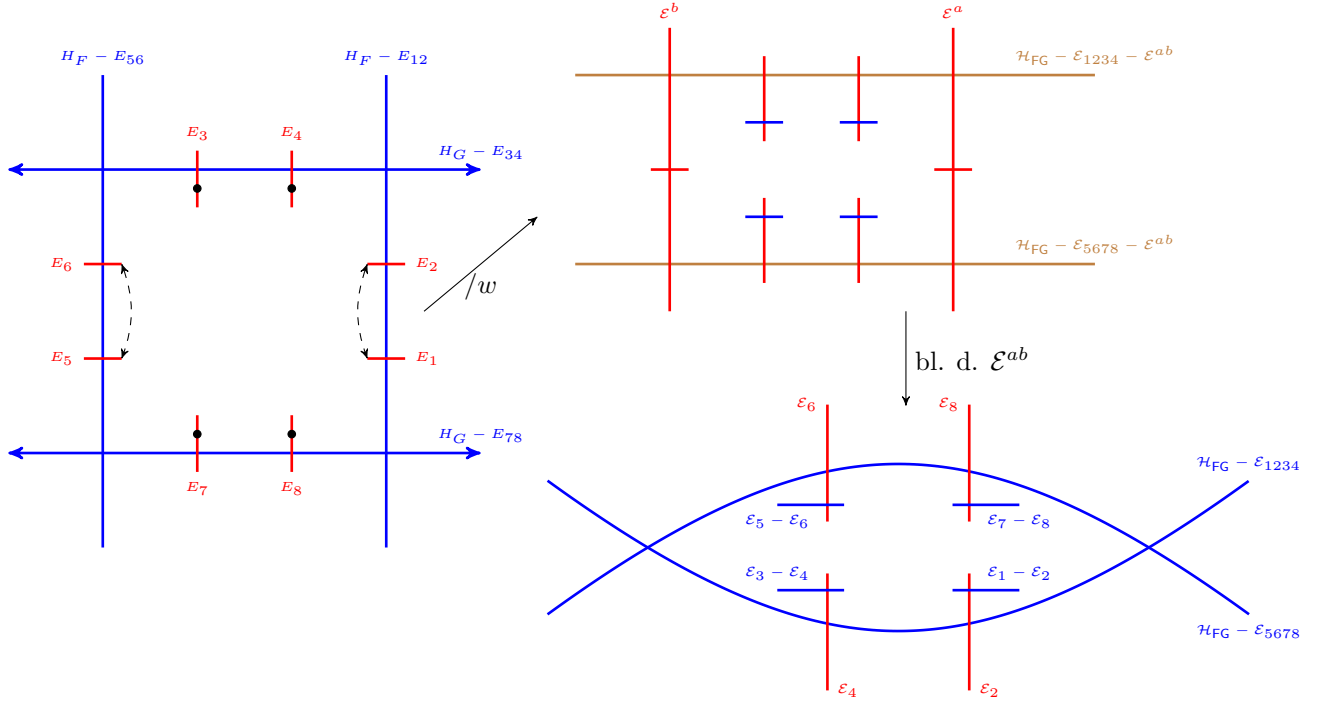

Under w we have non-singular pointwise invariant curves $G = 0, G = \infty$ and 4 fixed points on blowups on these curves:

sing. pt.	action	except. div.	Image
$((F - a_2)/G = 0, G = 0)$	$-\text{Id}_{2 \times 2}$	A_1	$\mathcal{E}_5 - \mathcal{E}_6$
$((F - a_2 a_0)/G = 0, G = 0)$	$-\text{Id}_{2 \times 2}$	A_1	$\mathcal{E}_7 - \mathcal{E}_8$
$((F - 1)/G^{-1} = 0, G^{-1} = 0)$	$-\text{Id}_{2 \times 2}$	A_1	$\mathcal{E}_1 - \mathcal{E}_2$
$((F - a_1^{-1})/G^{-1} = 0, G^{-1} = 0)$	$-\text{Id}_{2 \times 2}$	A_1	$\mathcal{E}_3 - \mathcal{E}_4$

Under factorization we obtain non-minimal surface. Blowing down (-1) curves $\mathcal{E}^a, \mathcal{E}^b$ we obtain surface $E_7^{(1)}/A_1^{(1)}$ with parameters and coordinates

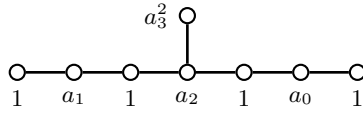

$$F = F \frac{G^2 - 1}{G^2 - a_3^{-2}} \quad (5.45)$$

$$G = 1/F$$

Symmetry lattice is $(3A_1)^{(1)}$, nodal curves and lattice is $\bar{\Phi}_{\text{nod}} = \Phi_{\text{nod}} = 4A_1$, symmetry group is as follows:

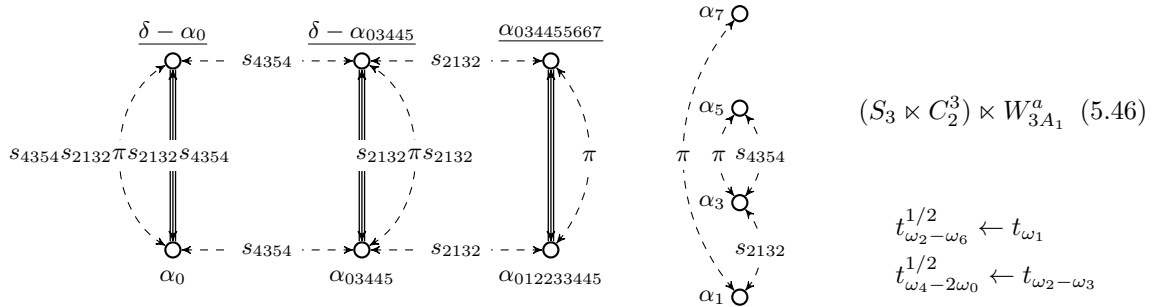

5.4.3 π

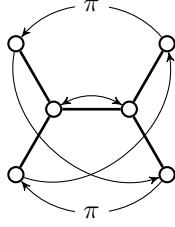

$$w = \pi : \begin{aligned} F &\mapsto 1/G \\ G &\mapsto F/a_2 \end{aligned} \quad (5.47)$$

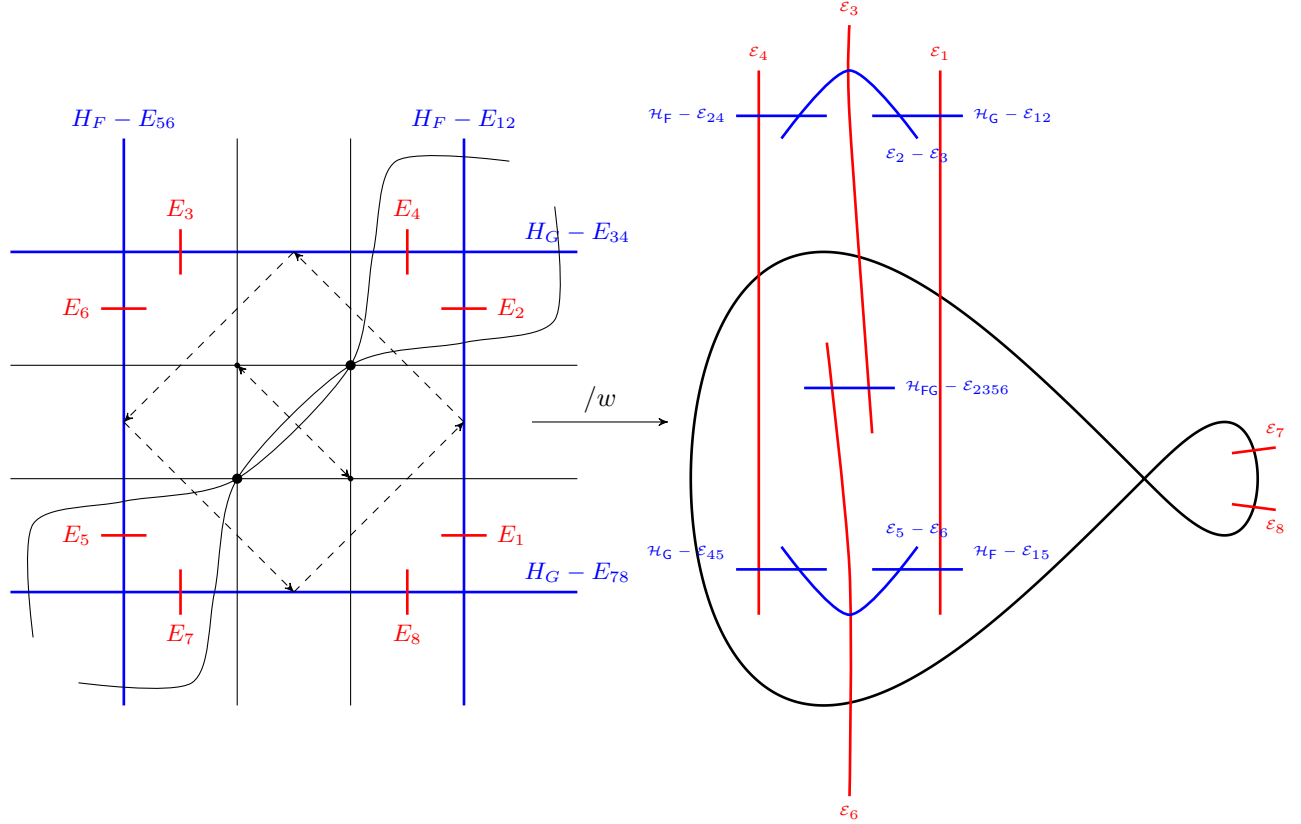

Under w we have 2 fixed points with and 2 additional fixed points under w^2 (small circles).

sing. pt.	action	except. div.	Image
$(a_2^{1/2}, a_2^{-1/2})$	$\begin{pmatrix} 0 & -a_2 \\ a_2^{-1} & 0 \end{pmatrix}$	A_3	$\mathcal{H}_F - \mathcal{E}_{24}, \mathcal{E}_2 - \mathcal{E}_3, \mathcal{H}_G - \mathcal{E}_{12}$
$(-a_2^{1/2}, -a_2^{-1/2})$	$\begin{pmatrix} 0 & -a_2 \\ a_2^{-1} & 0 \end{pmatrix}$	A_3	$\mathcal{H}_F - \mathcal{E}_{15}, \mathcal{E}_5 - \mathcal{E}_6, \mathcal{H}_G - \mathcal{E}_{45}$
$(a_2^{1/2}, -a_2^{-1/2})$	$w^2 : -\text{Id}_{2 \times 2}$	A_1	$\mathcal{H}_{FG} - \mathcal{E}_{2356}$
$(-a_2^{1/2}, a_2^{-1/2})$	$w^2 : -\text{Id}_{2 \times 2}$	A_1	

Preimages of (-1) curves:

Curve	$(a_2^{1/2}, a_2^{-1/2})$	$(-a_2^{1/2}, a_2^{-1/2})$	$(a_2^{1/2}, -a_2^{-1/2})$	$(-a_2^{1/2}, -a_2^{-1/2})$	Image
$F = a_2^{1/2} \sqcup G = a_2^{-1/2}$	$dF=0 \sqcup dG=0$	$dG = 0$	$dF = 0$	-	\mathcal{E}_3
$F = -a_2^{1/2} \sqcup G = -a_2^{-1/2}$	-	$dF = 0$	$dG = 0$	$dF=0 \sqcup dG=0$	\mathcal{E}_6
$FG-1 = i(a_2^{-1/2}F - a_2^{1/2}G)$	$dF = ia_2dG$	-	-	$dF = -ia_2dG$	\mathcal{E}_1
$FG-1 = -i(a_2^{-1/2}F - a_2^{1/2}G)$	$dF = -ia_2dG$	-	-	$dF = ia_2dG$	\mathcal{E}_4

Under factorization we obtain already minimal surface $E_8^{(1)}/A_0^{(1)}$ with parameters and coordinates

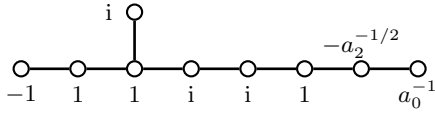

$$\begin{aligned} F &= ia_2^{-1/2} \frac{F^2 - a_2^2 G^2 + ia_2(F^2 G^2 - 1)}{a_2 G(i + FG) - F(1 + iFG)} \\ G &= ia_2^{-1/2} \frac{F^2 - a_2^2 G^2 - ia_2(F^2 G^2 - 1)}{a_2 G(-i + FG) - F(1 - iFG)} \end{aligned} \quad (5.48)$$

Symmetry lattice is $A_1^{(1)}$, nodal curves and lattice is $\Phi_{\text{nod}} = A_1 + 2A_3$, $\bar{\Phi}_{\text{nod}} = E_7$, $\bar{\Phi}_{\text{nod}}/\Phi_{\text{nod}}$ is generated by $-\mathcal{H}_{FGG} + \mathcal{E}_{123456} = -\alpha_{00122233334444556}$, $\chi(-\alpha_{00122233334444556}) = -i$, symmetry group is as follows:

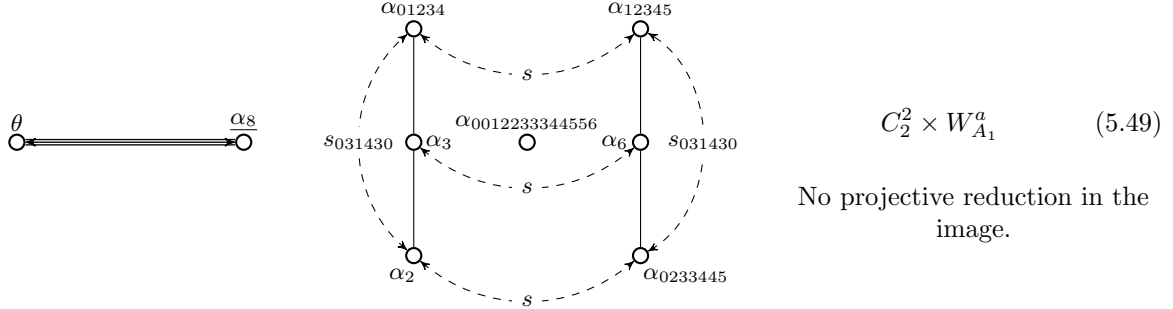

where $s = s_{453}s_{046}s_{354}$ changes branch of root $a_2^{1/2}$, s_{031430} generate Galois group, together they generate additional group $C_2^2 = \text{Aut}^{\text{nod}}$, corresponding to permutation of fixed points and invariant curves in the preimage.

5.4.4 $A_3 + A_1$

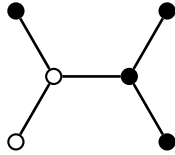

$$w = s_1 s_{534} : \begin{aligned} F &\mapsto -F \frac{G-i}{G+i} \\ G &\mapsto iG \end{aligned} \quad (5.50)$$

Under w we have non-singular pointwise invariant curves $G = 0$, 2 fixed points on blowups on this curve and another 2 fixed points; under w^2 we have additionally pointwise invariant curve $G = \infty$ and 2 fixed points on blowups on this curve:

sing. pt.	action	except. div.	Image
$(0, \infty)$	$\text{diag}(-1, i)$	A_1	$\mathcal{E}^c - \mathcal{E}^a \mapsto p$
(∞, ∞)	$\text{diag}(-1, i)$	A_1	$\mathcal{E}^d - \mathcal{E}^b \mapsto p$
$((F - a_2)/G = (1 - i)a_2, G = 0)$	$\begin{pmatrix} i & -2a_2 \\ 0 & -i \end{pmatrix}$	A_3	$\mathcal{H}_G - \mathcal{E}_{12}, \mathcal{E}_2 - \mathcal{E}_3, \mathcal{E}_3 - \mathcal{E}_4$
$((F - a_{02})/G = (1 - i)a_{02}, G = 0)$	$\begin{pmatrix} i & -2a_{02} \\ 0 & -i \end{pmatrix}$	A_3	$\mathcal{H}_G - \mathcal{E}_{56}, \mathcal{E}_6 - \mathcal{E}_7, \mathcal{E}_7 - \mathcal{E}_8$
$((F - 1)/G^{-1} = 1 + i, G = \infty)$	$w^2 : -\text{Id}_{2 \times 2}$	A_1	$\mathcal{H}_F - \mathcal{E}_{15}$
$((F + 1)/G^{-1} = -(1 + i), G = \infty)$	$w^2 : -\text{Id}_{2 \times 2}$	A_1	

Preimages of (-1) curves:

Curve	sing. pt. 3	sing. pt. 4	sing. pt. 5	sing. pt. 6	Image
$H_1 - H_2 = 1 - a_0 q^{-1}$	$d \frac{F - a_2}{G} = -ia_2 dG$	-	$d \frac{F - 1}{G - i} = i(a_2 + 2 - a_2^{-1})$	$d \frac{F + 1}{G - i} = i(a_2 - 2 - a_2^{-1})$	\mathcal{E}_1
$H_1 - H_2 = (a_0 - q^{-1})$	-	$d \frac{F - a_{02}}{G} = -ia_{02} dG$	$d \frac{F - 1}{G - i} = i(a_{02} + 2 - a_{02}^{-1})$	$d \frac{F + 1}{G - i} = i(a_{02} - 2 - a_{02}^{-1})$	\mathcal{E}_5

where

$$H_1 = -ia_2^{-1} F(G - 1)(G - i), \quad H_2 = -ia_2^{-1} F^{-1}(G + 1)(G + i), \quad q = a_0 a_2^2. \quad (5.51)$$

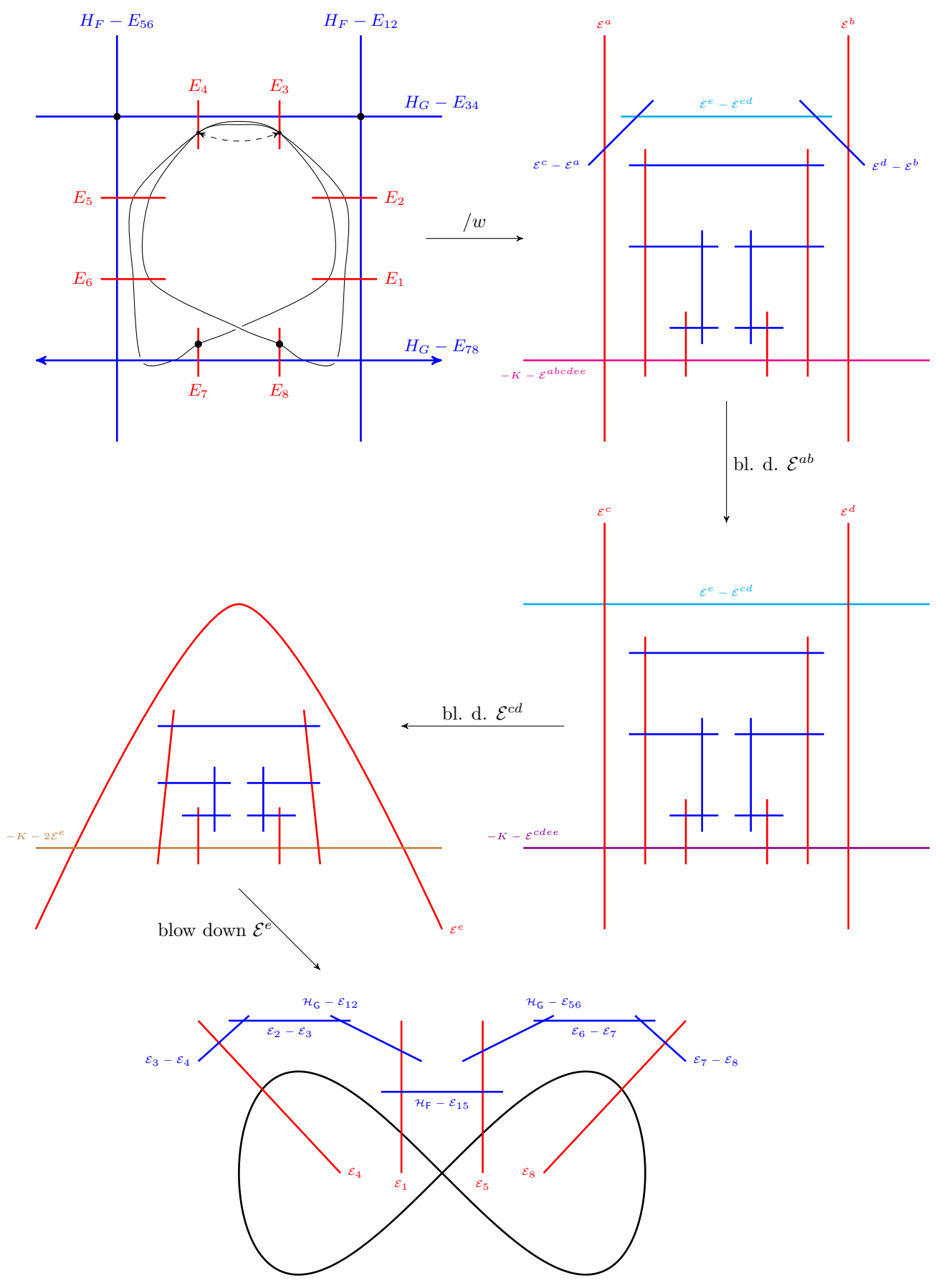

Under factorization we obtain non-minimal surface. Blowing down (-1) curves $\mathcal{E}^a, \mathcal{E}^b$, then (-1) curves $\mathcal{E}^c, \mathcal{E}^d$ and then (-1) curve \mathcal{E}^e , we obtain surface $E_8^{(1)}/A_0^{(1)}$ with parameters and coordinates

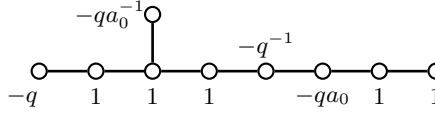

$$\begin{aligned}
 F &= -qH_1 - H_2 + (1+q)^2 \frac{H_1 H_2 - a_2^{-2}}{H_1 + qH_2 - 1 - a_0} \\
 G &= H_1 - H_2
 \end{aligned}
 \tag{5.52}$$

Symmetry lattice is $A_1^{(1)}$, nodal curves and lattice is $\bar{\Phi}_{\text{nod}} = \Phi_{\text{nod}} = A_1 + 2A_3$, symmetry group is as follows:

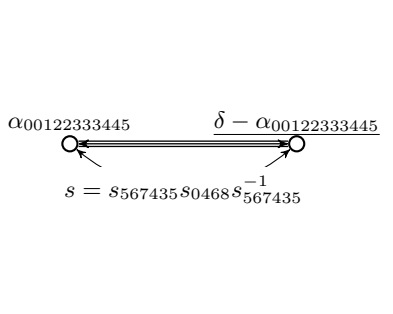

$$\begin{aligned}
 & W_{A_1}^{ae} \\
 & t_{\omega_0 - \omega_6}^{1/2} \leftarrow t_{\omega_2}
 \end{aligned}
 \tag{5.53}$$

5.4.5 $\pi^2 \times 3A_1$

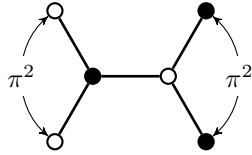

$$\begin{aligned}
 w &= \pi^2 s_2 s_4 : \\
 F &\mapsto 1/F \\
 G &\mapsto -a_3^{-1} G^{-1} \frac{F+1}{F-1}
 \end{aligned}
 \tag{5.54}$$

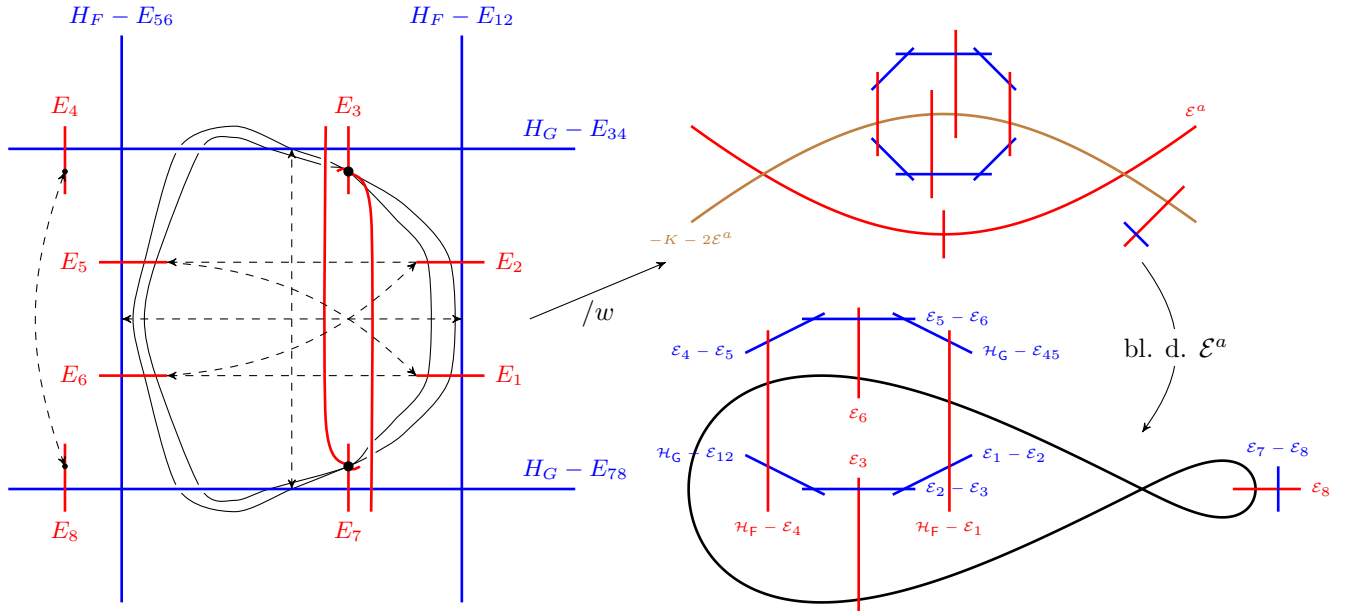

Under w we have 2 fixed points; under w^2 we have additionally pointwise invariant curves $G = 0, \infty$ and one additional fixed point on blowups on each of these curves

sing. pt.	action	except. div.	Image
$((F + 1)/G = 0, G = 0)$	$\begin{pmatrix} 0 & -2a_3 \\ (2a_3)^{-1} & 0 \end{pmatrix}$	A_3	$\mathcal{E}_4 - \mathcal{E}_5, \mathcal{E}_5 - \mathcal{E}_6, \mathcal{H}_G - \mathcal{E}_{45}$
$((F - 1)/G^{-1} = 0, G = \infty)$	$\begin{pmatrix} 0 & 2/a_3 \\ -a_3/2 & 0 \end{pmatrix}$	A_3	$\mathcal{E}_1 - \mathcal{E}_2, \mathcal{E}_2 - \mathcal{E}_3, \mathcal{H}_G - \mathcal{E}_{12}$
$((F - a_1)/G = 0, G = 0)$	$w^2 : -\text{Id}_{2 \times 2}$	A_1	$\mathcal{E}_7 - \mathcal{E}_8$
$((F - a_1^{-1})/G^{-1} = 0, G = \infty)$	$w^2 : -\text{Id}_{2 \times 2}$	A_1	

Preimages of (-1) curves:

Curve	sing. pt. 1	sing. pt. 2	Image
$(F^2 - 1)(G^2 - 1) = (1 - ia_3)(F - 1)G^2 + (1 - ia_3^{-1})(F + 1)$	$d \frac{F+1}{G} = 2ia_3 dG$	$d \frac{F-1}{G^{-1}} = 2ia_3^{-1} dG$	$\mathcal{H}_F - \mathcal{E}_4$
$(F^2 - 1)(G^2 - 1) = (1 + ia_3)(F - 1)G^2 + (1 + ia_3^{-1})(F + 1)$	$d \frac{F+1}{G} = -2ia_3 dG$	$d \frac{F-1}{G^{-1}} = -2ia_3^{-1} dG$	$\mathcal{H}_F - \mathcal{E}_1$
$E_8^{(-1,0)} \sqcup F = -1$	$d \frac{F+1}{G} = 0 \sqcup dG = 0$	-	\mathcal{E}_6
$E_3^{(1,\infty)} \sqcup F = 1$	-	$d \frac{F-1}{G^{-1}} = 0 \sqcup dG^{-1} = 0$	\mathcal{E}_3

Under factorization we obtain non-minimal surface. Blowing down (-1) curve \mathcal{E}^a we obtain surface $E_8^{(1)}/A_0^{(1)}$ with parameters and coordinates

$$F = \frac{(F - 1)(F + ia_3 F^{-1})G^2 - (F + 1)(F - ia_3^{-1} F^{-1})}{(F - 1)G^2 + ia_3^{-1}(F + 1)}$$

$$G = F + F^{-1}$$

(5.55)

Symmetry lattice is $A_1^{(1)}$, nodal curves and lattice is $\Phi_{\text{nod}} = A_1 + 2A_3$, $\bar{\Phi}_{\text{nod}} = D_6 + A_1$, $\bar{\Phi}_{\text{nod}}/\Phi_{\text{nod}}$ is generated by $-\mathcal{H}_G + \mathcal{E}_{36} = -\alpha_{0233456}$, $\chi(-\alpha_{0233456}) = -1$, symmetry group is as follows:

$C_2^2 \times W_{A_1}^a$ (5.56)

No projective reduction in the image.

where $s = s_{435}s_{246}s_{534}$. Here we obtain additional $C_2 = \text{Aut}^{\text{nod}}$, which is Galois group generated by s_{430234} .

5.4.6 $4A_1$

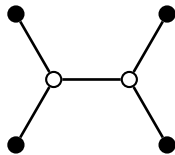

$$w = s_0 s_1 s_4 s_5 : \begin{matrix} F \mapsto -F \\ G \mapsto -G \end{matrix} \quad (5.57)$$

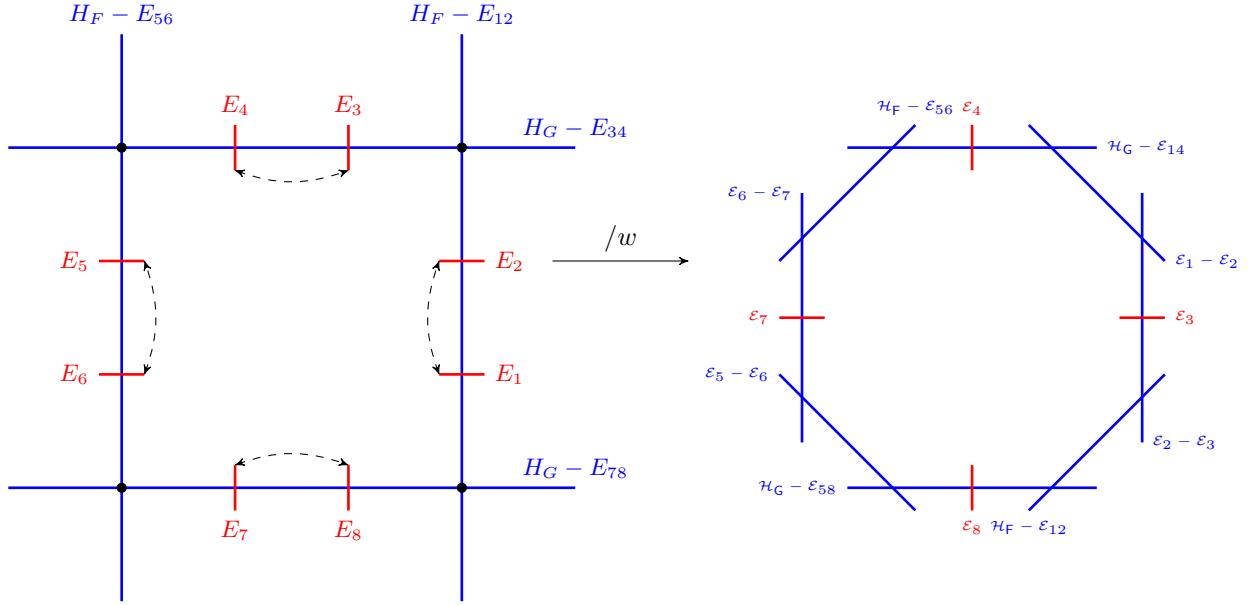

Under w we have 4 fixed points:

sing. pt.	action	except. div.	Image
$(0, 0)$	$-\text{Id}_{2 \times 2}$	A_1	$\mathcal{E}_5 - \mathcal{E}_6$
$(0, \infty)$	$-\text{Id}_{2 \times 2}$	A_1	$\mathcal{H}_F - \mathcal{E}_{56}$
$(\infty, 0)$	$-\text{Id}_{2 \times 2}$	A_1	$\mathcal{H}_F - \mathcal{E}_{12}$
(∞, ∞)	$-\text{Id}_{2 \times 2}$	A_1	$\mathcal{E}_1 - \mathcal{E}_2$

Under factorization we obtain already minimal surface $A_1^{(1)}/A_7^{(1)'}$ with parameters and coordinates

$$a_3^2 \longleftrightarrow a_2^2 \quad \begin{aligned} F &= F^2 \\ G &= FG \end{aligned} \quad (5.58)$$

Symmetry lattice is $A_1^{(1)}$, nodal curves and lattice is $\bar{\Phi}_{\text{nod}} = \Phi_{\text{nod}} = \emptyset$, symmetry group is as follows:

$$\begin{array}{ccc} \pi & & \\ \alpha_0 \longleftrightarrow \alpha_1 & \emptyset & (C_4 \times W_{A_1}^a) \times C_2 \end{array} \quad (5.59)$$

No projective reduction in the image.

5.5 $E_3^{(1)}/A_5^{(1)}$ surface

We have two standard realizations of $E_3^{(1)}/A_5^{(1)}$ surface, we will relate to them as a) and b), following [KNY17], preferring realization b).

Action on coordinates $F = f/\nu_4$, $G = g\nu_1$ in realization b) (where f, g — notations of [KNY17]):

coord.	s_0	s_1	s_2	s_3	s_4	π
F	$a_0 F \frac{F+a_4 a_0^{-1} G}{F+a_4 G}$	$a_1^{-1} F$	$F \frac{G-1}{G-a_2^{-1}}$	$a_0 a_1 a_2 a_4^{-1} F \frac{a_4 a_0^{-1} G + F - a_1}{a_1 a_2 G + F - a_1}$	$F \frac{F-G(F-1)}{F-a_4 G(F-1)}$	$a_2 G$
G	$G \frac{F+a_4 a_0^{-1} G}{F+a_4 G}$	$G \frac{F-1}{F-a_1}$	$a_2 G$	$G \frac{a_4 a_0^{-1} G + F - a_4 a_0^{-1} a_2^{-1}}{a_1 a_2 G + F - a_1}$	$a_4 G \frac{F-G(F-1)}{F-G(F-a_4)}$	$-a_4 a_0^{-1} G/F$

Root data and point configuration (in variant a) $F = f/\nu_4$, $G = g\nu_1\nu_8/\nu_7$):

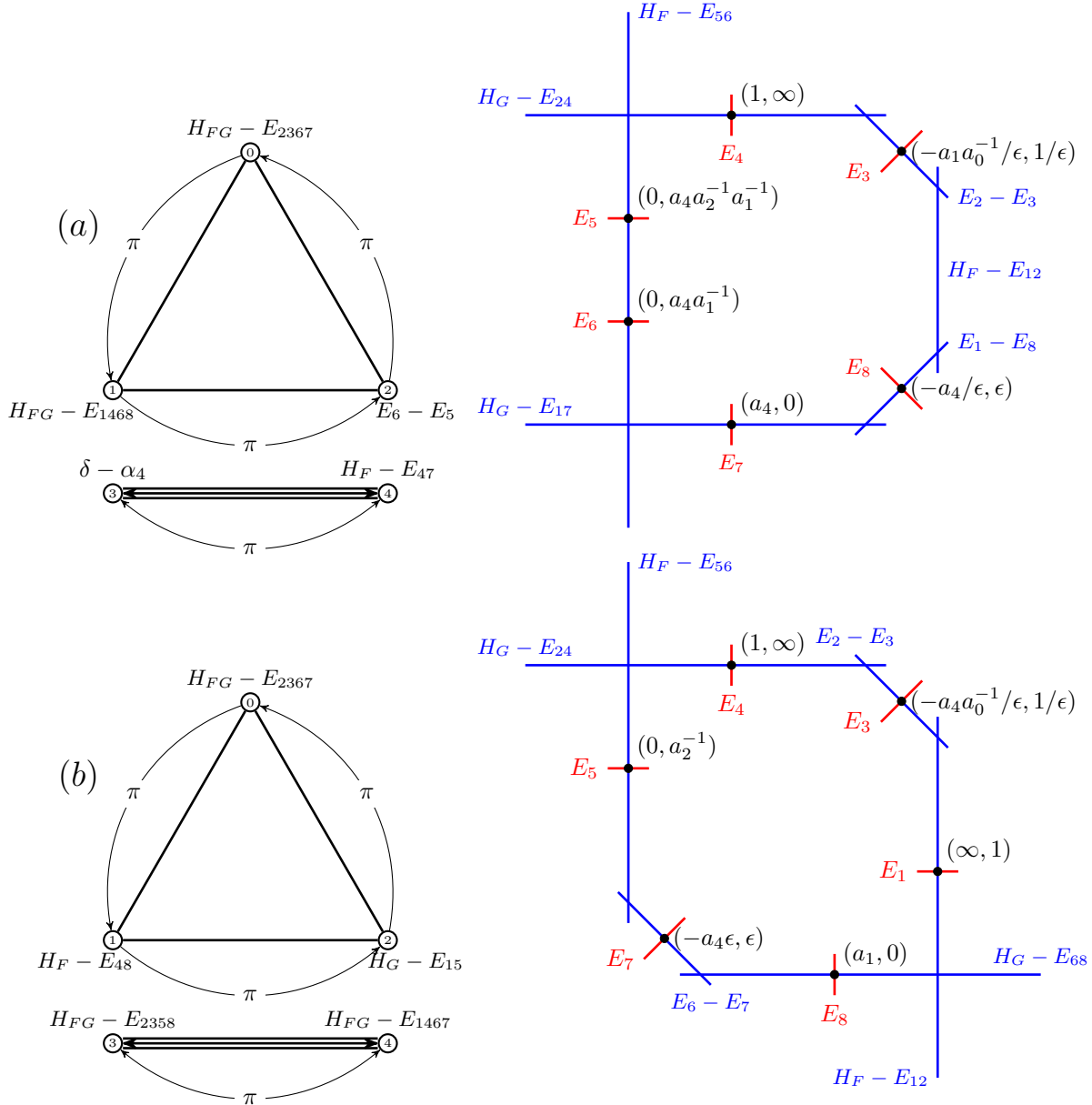

Transformation between realizations a) and b) is given by reflection $s_{H_2-E_{16}}$. Corresponding transformation of coordinates is as follows:

$$F_b = F_a \frac{G_a}{G_a - a_4 a_1^{-1}}, \quad G_b = a_1 a_4^{-1} G_a. \quad (5.60)$$

5.5.1 π^3

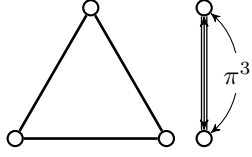

$$w = \pi^3 : \begin{aligned} F &\mapsto a_1/F \\ G &\mapsto a_2^{-1}/G \end{aligned} \quad (5.61)$$

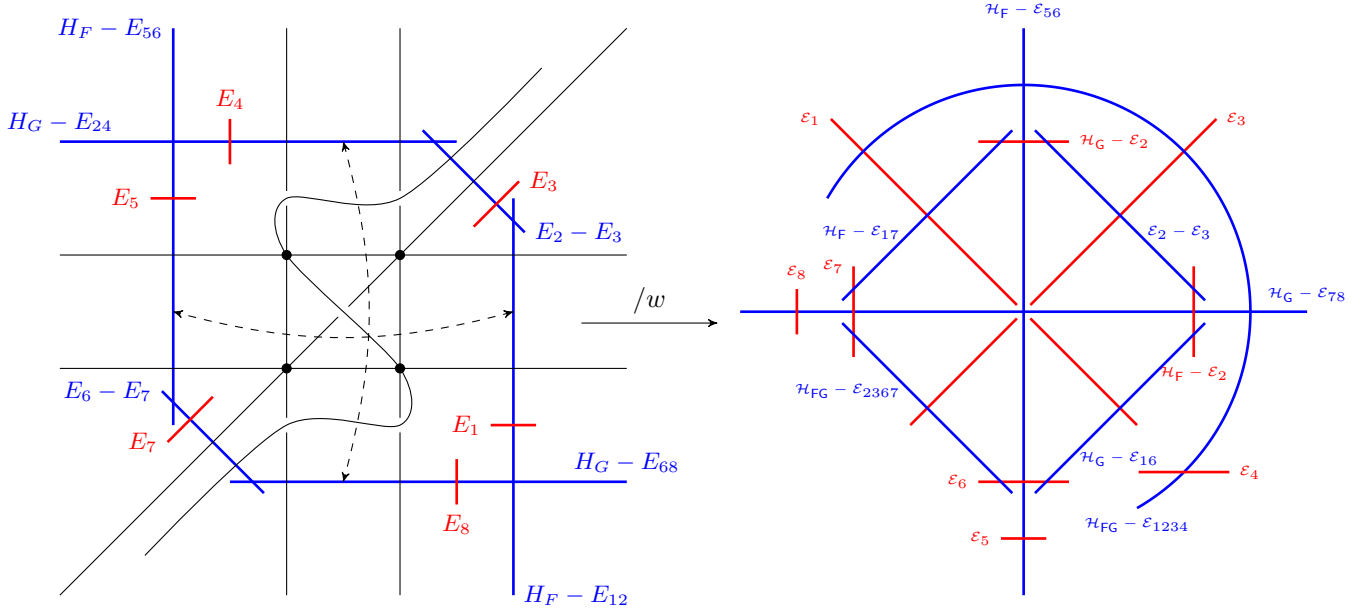

Under w we have 4 fixed points:

sing. pt.	action	except. div.	Image
$(a_1^{1/2}, a_2^{-1/2})$	$-\text{Id}_{2 \times 2}$	A_1	$\mathcal{H}_{FG} - \mathcal{E}_{2367}$
$(-a_1^{1/2}, a_2^{-1/2})$	$-\text{Id}_{2 \times 2}$	A_1	$\mathcal{H}_G - \mathcal{E}_{16}$
$(a_1^{1/2}, -a_2^{-1/2})$	$-\text{Id}_{2 \times 2}$	A_1	$\mathcal{H}_F - \mathcal{E}_{17}$
$(-a_1^{1/2}, -a_2^{-1/2})$	$-\text{Id}_{2 \times 2}$	A_1	$\mathcal{E}_2 - \mathcal{E}_3$

Preimages of (-1) curves:

Curve	$(a_1^{1/2}, a_2^{-1/2})$	$(-a_1^{1/2}, a_2^{-1/2})$	$(a_1^{1/2}, -a_2^{-1/2})$	$(-a_1^{1/2}, -a_2^{-1/2})$	Image
$F = a_1^{1/2}$	$dF = 0$	-	$dF = 0$	-	\mathcal{E}_7
$F = -a_1^{1/2}$	-	$dF = 0$	-	$dF = 0$	$\mathcal{H}_F - \mathcal{E}_2$
$G = a_2^{-1/2}$	$dG = 0$	$dG = 0$	-	-	\mathcal{E}_6
$G = -a_2^{-1/2}$	-	-	$dG = 0$	$dG = 0$	$\mathcal{H}_G - \mathcal{E}_2$
$F = -a_{12}^{1/2} G$	-	$dF = -a_{12}^{1/2} dG$	$dF = -a_{12}^{1/2} dG$	-	\mathcal{E}_1
$F = a_{12}^{1/2} G$	$dF = a_{12}^{1/2} dG$	-	-	$dF = a_{12}^{1/2} dG$	\mathcal{E}_3

After factorization we already obtain surface $E_6^{(1)}/A_2^{(1)}$ with parameters and coordinates

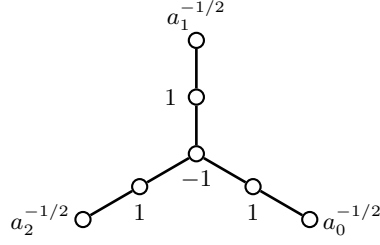

$$\begin{aligned}
 F &= a_1^{-1/2} F \frac{a_2^{1/2} G - 1}{a_2^{1/2} G - a_1^{-1} F^2} \\
 G &= a_2^{1/2} G \frac{a_1^{-1/2} F - 1}{a_1^{-1/2} F - a_2 G^2}
 \end{aligned} \tag{5.62}$$

Symmetry lattice is $(A_2^{(1)})_{|\alpha|^2=4}$, nodal curves and lattice is $\Phi_{\text{nod}} = 4A_1$, $\bar{\Phi}_{\text{nod}} = D_4$, $\bar{\Phi}_{\text{nod}}/\Phi_{\text{nod}}$ is generated by $\mathcal{E}_1 - \mathcal{E}_2 = \alpha_3$, $\chi(\alpha_3) = -1$, symmetry group is as follows:

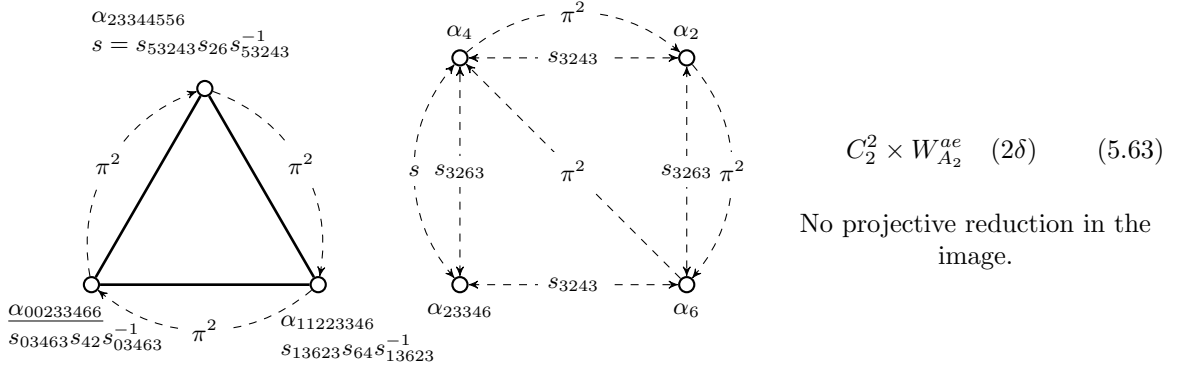

Here we obtain additional $C_2^2 = \text{Aut}^{\text{nod}}$, generated by s_{3243} and $s_{3643} = s_{3243}s_{3263}$, which changes root branches of $a_2^{1/2}$ and $a_1^{1/2}$ respectively.

5.5.2 A_1

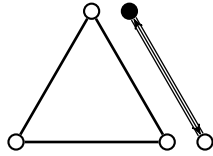

$$\begin{aligned}
 w = s_4 : \\
 F &\mapsto -F \frac{G(F-1) - F}{G(F-1) + F} \\
 G &\mapsto -G \frac{F(G-1) - G}{F(G-1) + G}
 \end{aligned} \tag{5.64}$$

Under w we have 4 fixed points:

sing. pt.	action	except. div.	Image
$(1, 1)$	$-\text{Id}_{2 \times 2}$	A_1	$\mathcal{E}_1 - \mathcal{E}_2$
$(F = 0, (G - a_2^{-1})/F = a_2^{-1} - 1)$	$-\text{Id}_{2 \times 2}$	A_1	$\mathcal{E}_6 - \mathcal{E}_5$
$((F - a_1)/G = a_1 - 1, G = 0)$	$-\text{Id}_{2 \times 2}$	A_1	$\mathcal{E}_3 - \mathcal{E}_4$
$((F/G - a_0)/G = a_0(a_0 - 1), G = 0)$	$\begin{pmatrix} -1 & * \\ 0 & -1 \end{pmatrix}$	A_1	$\mathcal{E}_7 - \mathcal{E}_8$

Invariant curves

Curve	$(1, 1)$	others	Image
$F = 1$	$dF = 0$	-	\mathcal{E}_2
$G = 1$	$dG = 0$	-	$\mathcal{H}_G - \mathcal{E}_1$

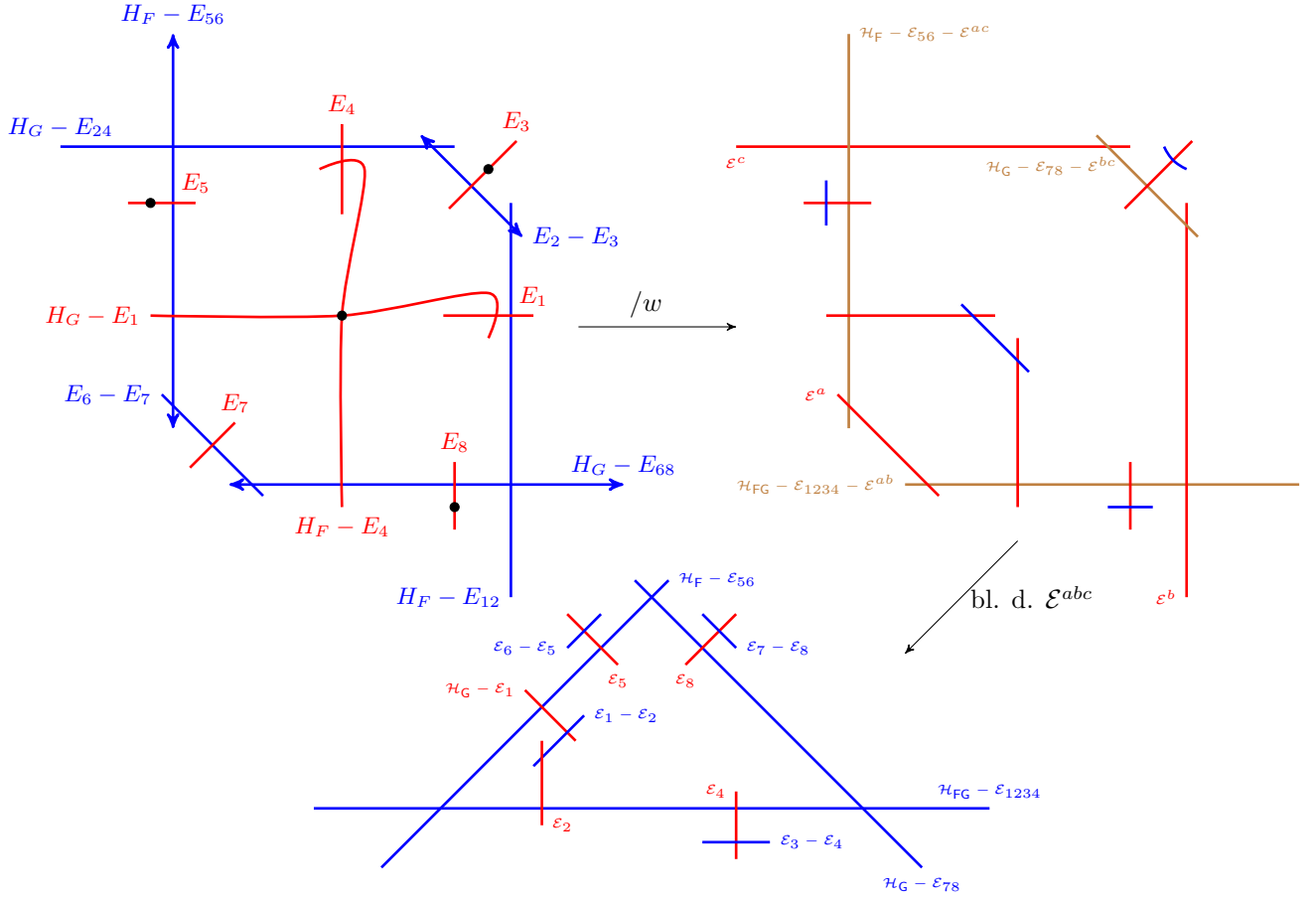

Under factorization we obtain non-minimal surface. Blowing down (-1) curves $\mathcal{E}^a, \mathcal{E}^b, \mathcal{E}^c$ we obtain surface $E_6^{(1)}/A_2^{(1)}$ with parameters and coordinates

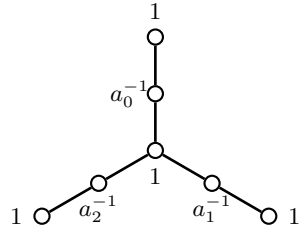

$$\begin{aligned}
 F &= \frac{F^2}{F + FG - G} \\
 G &= \frac{1}{F - FG + G}
 \end{aligned}
 \tag{5.65}$$

Symmetry lattice is $(A_2^{(1)})_{|\alpha|^2=4}$, nodal curves and lattice is $\bar{\Phi}_{\text{nod}} = \Phi_{\text{nod}} = 4A_1$, symmetry group is as follows:

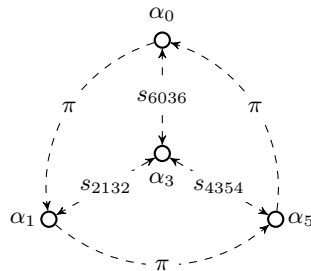
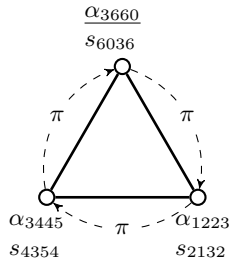

$$W_{A_2}^{ae} \tag{5.66}$$

$$\begin{aligned}
 t_{\omega_2 - \omega_4}^{1/2} &\leftarrow t_{\omega_2 - \omega_1} \\
 t_{\omega_4 - \omega_6}^{1/2} &\leftarrow t_{\omega_1}
 \end{aligned}
 \tag{5.67}$$

5.5.3 π^2

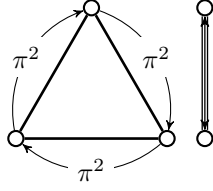

$$w = \pi^2 : \begin{aligned} F &\mapsto -a_4 G / F \\ G &\mapsto 1 / F \end{aligned} \quad (5.68)$$

Under w we have 3 fixed points:

sing. pt.	action	except. div.	Image
$(-a_4^{1/3}, -a_4^{-1/3})$	$\begin{pmatrix} 0 & -a_4^{2/3} \\ a_4^{-2/3} & -1 \end{pmatrix}$	A_2	$\mathcal{H}_F - \mathcal{E}_{35}, \mathcal{H}_G - \mathcal{E}_{26}$
$(-\zeta a_4^{1/3}, -\zeta^{-1} a_4^{-1/3})$	$\begin{pmatrix} 0 & -\zeta^{-1} a_4^{2/3} \\ \zeta a_4^{-2/3} & -1 \end{pmatrix}$	A_2	$\mathcal{H}_F - \mathcal{E}_{37}, \mathcal{H}_G - \mathcal{E}_{15}$
$(-\zeta^{-1} a_4^{1/3}, -\zeta a_4^{-1/3})$	$\begin{pmatrix} 0 & -\zeta a_4^{2/3} \\ \zeta^{-1} a_4^{-2/3} & -1 \end{pmatrix}$	A_2	$\mathcal{H}_F - \mathcal{E}_{16}, \mathcal{H}_G - \mathcal{E}_{27}$

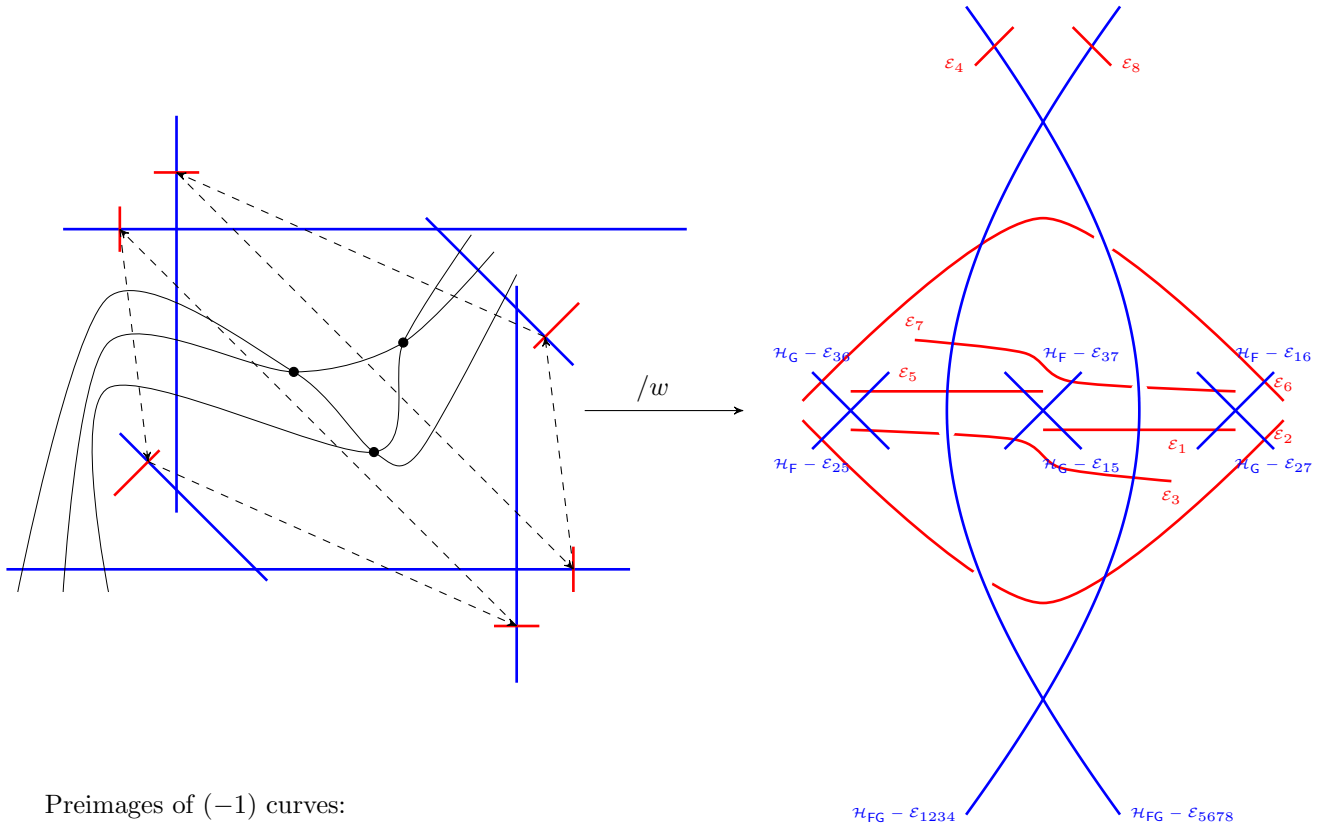

Preimages of (-1) curves:

Curve	$(-a_4^{1/3}, -a_4^{-1/3})$	$(-\zeta a_4^{1/3}, -\zeta^{-1} a_4^{-1/3})$	$(-\zeta^{-1} a_4^{1/3}, -\zeta a_4^{-1/3})$	Image
$a_4^{-1/3} F + a_4^{1/3} G = 1$	-	$dF \sim -a_4^{2/3} dG$	$dF \sim -a_4^{2/3} dG$	\mathcal{E}_1
$\zeta^{-1} a_4^{-1/3} F + \zeta a_4^{1/3} G + 1 = 1$	$dF \sim -\zeta^{-1} a_4^{2/3} dG$	-	$dF \sim -\zeta^{-1} a_4^{2/3} dG$	\mathcal{E}_2
$\zeta a_4^{-1/3} F + \zeta^{-1} a_4^{1/3} G = 1$	$dF \sim -\zeta a_4^{2/3} dG$	$dF \sim -\zeta a_4^{2/3} dG$	-	\mathcal{E}_3
$(*) a_4^{-1/3} F + a_4^{1/3} G = FG$	-	$dF \sim -\zeta a_4^{2/3} dG$	$dF \sim -\zeta^{-1} a_4^{2/3} dG$	\mathcal{E}_7
$(*) \zeta^{-1} a_4^{-1/3} F + \zeta a_4^{1/3} G = FG$	$dF \sim -\zeta a_4^{2/3} dG$	-	$dF \sim -a_4^{2/3} dG$	\mathcal{E}_6
$(*) \zeta a_4^{-1/3} F + \zeta^{-1} a_4^{1/3} G = FG$	$dF \sim -\zeta^{-1} a_4^{2/3} dG$	$dF \sim -a_4^{2/3} dG$	-	\mathcal{E}_5

Last three curves are not drawn (*) in the preimage, to prevent picture overload.
After factorization we obtain surface $E_7^{(1)}/A_1^{(1)}$ with parameters and coordinates

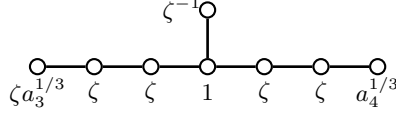

$$\begin{aligned} F &= \frac{a_4^{2/3}G^2 - \zeta^{-1}a_4^{-1/3}F^2G - \zeta a_4^{-1/3}F}{a_4^{1/3}G + \zeta^{-1}a_4^{1/3}FG^2 - \zeta a_4^{-2/3}F^2} \\ G &= \frac{a_4^{1/3}G + \zeta a_4^{1/3}FG^2 - \zeta^{-1}a_4^{-2/3}F^2}{a_4^{2/3}G^2 - \zeta a_4^{-1/3}F^2G - \zeta^{-1}a_4^{-1/3}F} \end{aligned} \quad (5.69)$$

Symmetry lattice is $A_1^{(1)}|_{|\alpha|^2=6}$, nodal curves and lattice is $\Phi_{\text{nod}} = 3A_2$, $\bar{\Phi}_{\text{nod}} = E_6$, $\bar{\Phi}_{\text{nod}}/\Phi_{\text{nod}}$ is generated by $-\mathcal{H}_{FGG} + \mathcal{E}_{123567} = -\alpha_{0233444556}$, $\chi(-\alpha_{0233444556}) = \zeta$, symmetry group is as follows:

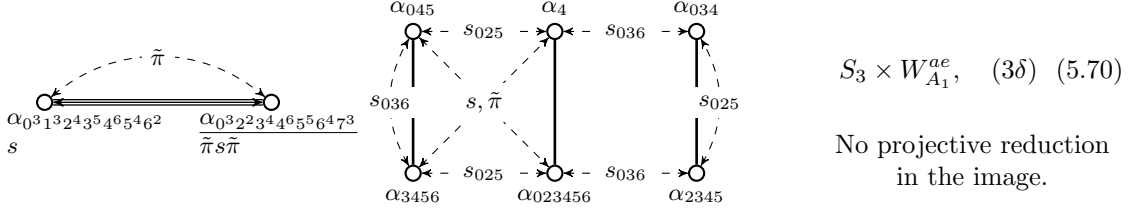

where $s = s_{12345604521324}s_{013}s_{12345604521324}^{-1}$, $\tilde{\pi} = s_{32}\pi s_{23}$. Here we obtain additional $S_3 = \text{Aut}^{\text{nod}}$, corresponding to the permutation of the fixed points in the preimage. It is generated by Galois generator s_{025} and $s_{025}s_{036}$, which changes branches of $a_4^{1/3}$.

5.5.4 A_2

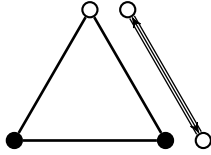

$$w = s_{12} : \begin{aligned} F &\mapsto \zeta F \frac{G-1}{G-\zeta^{-1}} \\ G &\mapsto \zeta G \frac{FG-F-G+\zeta^{-1}}{FG-F-\zeta^{-1}G+\zeta} \end{aligned} \quad (5.71)$$

Under w we have 5 fixed points:

sing. pt.	action	except. div.	Image
$(-\zeta^{-1}, -\zeta)$	$\begin{pmatrix} 1 & \zeta^{-1}-1 \\ 1-\zeta & -2 \end{pmatrix}$	A_2	$\mathcal{E}_1 - \mathcal{E}_2, \mathcal{H}_G - \mathcal{E}_{15}$
$(0, \infty)$	$\text{diag}(\zeta, \zeta)$	(-3)	$\mathcal{E}^e - \mathcal{E}^{ab} \rightarrow p$
$(\infty, 0)$	$\text{diag}(\zeta, \zeta)$	(-3)	$\mathcal{E}^f - \mathcal{E}^{cd} \rightarrow p$
$(F=0, \frac{G/F+a_4^{-1}}{F} = \zeta a_4^{-2} + \zeta^{-1}a_4^{-1})$	$\begin{pmatrix} \zeta^{-1} & 0 \\ * & \zeta \end{pmatrix}$	A_2	$\mathcal{E}_3 - \mathcal{E}_4, \mathcal{H}_F - \mathcal{E}_{35}$
$(F^{-1}=0, \frac{G^{-1}/F^{-1}+a_0^{-1}a_4}{F^{-1}} = a_4a_0^{-1}(1+a_4a_0^{-1}))$	$\begin{pmatrix} \zeta^{-1} & 0 \\ * & \zeta \end{pmatrix}$	A_2	$\mathcal{E}_6 - \mathcal{E}_7, \mathcal{E}_7 - \mathcal{E}_8$

Preimages of (-1) curves:

Curve	sing. pt. 4	sing. pt. 5	$(-\zeta^{-1}, -\zeta)$	Image
$F+G=FG$	-	-	$dF \sim -\zeta^{-1}dG$	\mathcal{E}_2
(*) $F+\zeta^{-1}G=\zeta$	-	-	$dF \sim -\zeta^{-1}dG$	$\mathcal{H}_F - \mathcal{E}_1$
$F^2(G-1) + \zeta^{-1}a_4(F-1)G^2 = -\zeta(F+a_4G)$	$F \sim -a_4G$	-	$dF \sim dG$	\mathcal{E}_5
(*) $F^2(G-1) + a_4a_0^{-1}(F-1)G^2 = -\zeta F - a_4a_0^{-1}\zeta^{-1}G$	-	$F^{-1} \sim -a_0a_4^{-1}G^{-1}$	$dF \sim dG$	$\mathcal{H}_F - \mathcal{E}_6$

Second and fourth curves are not drawn (*) in the preimage, to prevent picture overload.

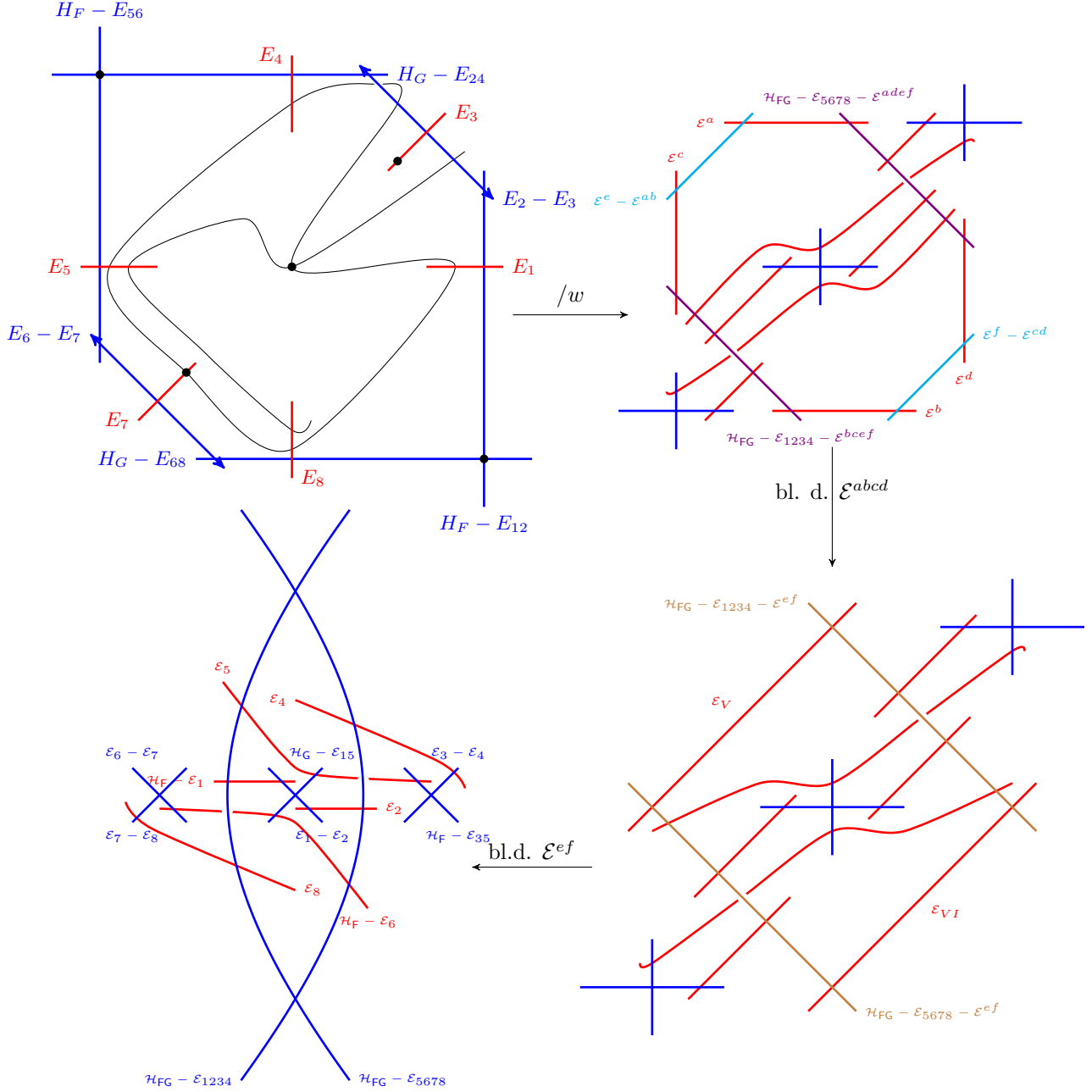

Under factorization we obtain non-minimal surface. Blowing down (-1) curves $\mathcal{E}^a, \mathcal{E}^b, \mathcal{E}^c, \mathcal{E}^d, \mathcal{E}^e, \mathcal{E}^f$ we obtain surface $E_7^{(1)}/A_1^{(1)}$ with parameters and coordinates

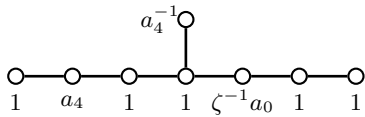

$$\begin{aligned}
 F &= -\zeta^{-1}G/F \frac{\zeta^{-1} + G(F-1)}{\zeta + F(G-1)} \\
 G &= -\frac{\zeta F^2}{a_4 G^2} \frac{\zeta a_4 G/F + \zeta + G(G+\zeta^{-1}) - F(G-1)^2}{\zeta^{-1} a_4^{-1} F/G + \zeta^{-1} + F(F+\zeta) - G(F-1)^2}
 \end{aligned} \tag{5.72}$$

Symmetry lattice is $A_1^{(1)}|_{|\alpha|^2=6}$, nodal curves and lattice is $\bar{\Phi}_{\text{nod}} = \Phi_{\text{nod}} = 3A_2$, symmetry group is as follows:

5.6 $E_2^{(1)}/A_6^{(1)}$ surface

Action on coordinates $F = f/\nu_4$, $G = g\nu_1$ (where f, g — notations of [KNY17] and variable $b = (a_1/a_2)^{1/2}$ in realization b):

coord.	s_0	s_1	π
F	$a_0^2 F \frac{(-F+FG+bG^2)^2}{(-F+FG+a_0bG^2)(-F+a_0FG+a_0bG^2)}$	$a_1^{-1} F$	$\frac{F}{G(F+bG)}$
G	$a_0 G \frac{-F+FG+bG^2}{-F+FG+a_0bG^2}$	$G \frac{F-1}{F-a_1}$	$-b^{-1} F/G$
b	$a_0 b$	$a_1^{-1} b$	b/a_1

Root data and point configuration in realization b):

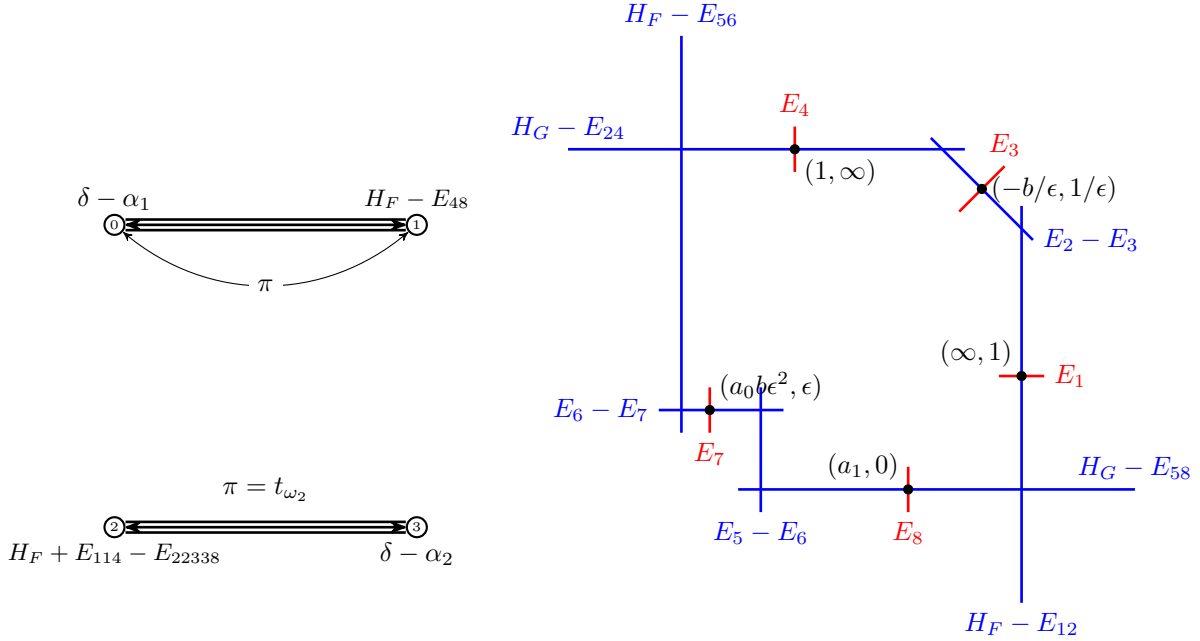

As already mentioned, geometry depends on variable b . It is period map of divisor $\frac{1}{2}(\alpha_1 - \alpha_2) = E_{23} - E_{14}$.

5.7 $E_1^{(1)}/A_7^{(1)}$ surface

Action on coordinates $F = f/\nu_4$, $G = g(\nu_1\nu_2\nu_3/\nu_4)^{1/2}$ (where f, g — notations of [KNY17]):

coord.	s_0	s_1	π	σ
F	$a_0^2 F \left(\frac{F-G^2}{F-a_0 G^2} \right)^2$	$a_1^{-1} F$	$a_0 G^2 / F$	F
G	$a_0^{3/2} G \frac{F-G^2}{F-a_0 G^2}$	$a_1^{-1/2} G \frac{F-1}{F-a_1}$	$-a_0^{1/2} G / F$	$-G$

Root data and point configuration:

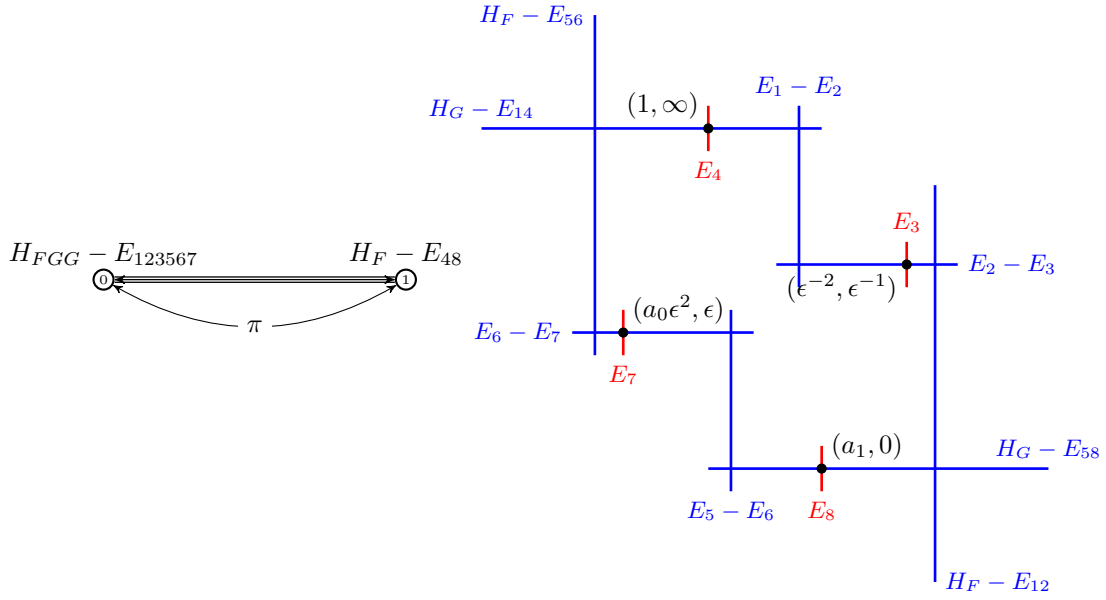

5.7.1 π^2

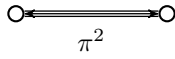

$$w = \pi^2 : \begin{aligned} F &\mapsto a_1/F \\ G &\mapsto (a_1/a_0)^{1/2}/G \end{aligned} \quad (5.74)$$

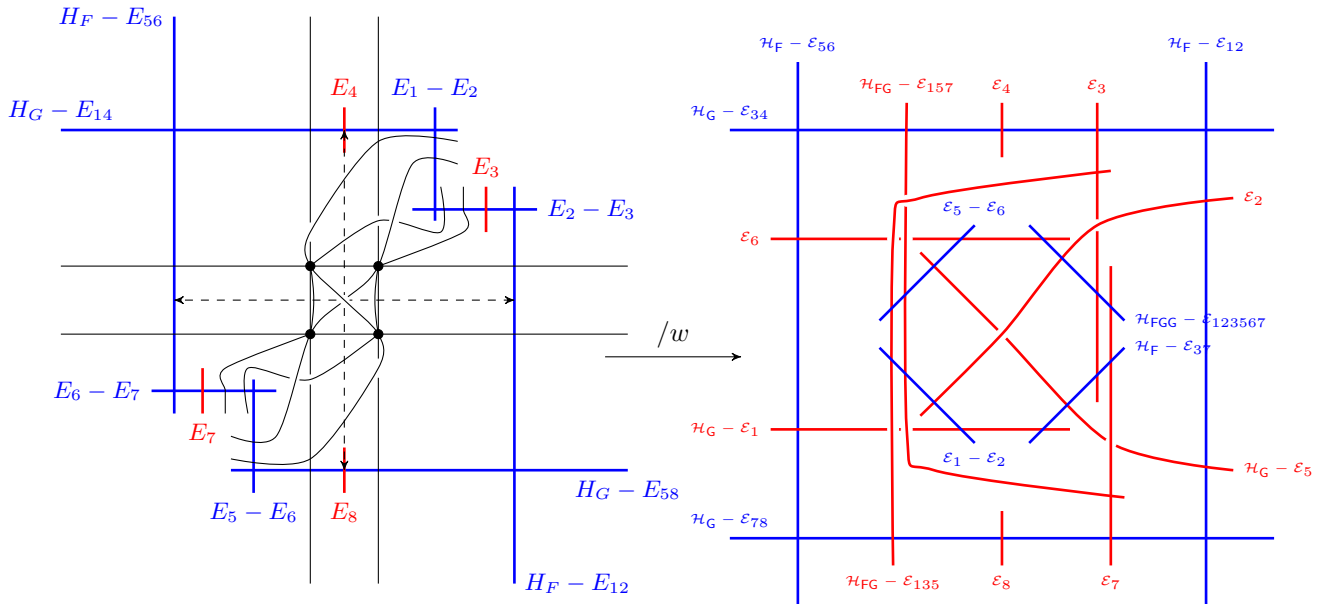

Under w we have 4 fixed points:

sing. pt.	action	except. div.	Image
$(a_1^{1/2}, (a_1/a_0)^{1/4})$	$-\text{Id}_{2 \times 2}$	A_1	$\mathcal{E}_1 - \mathcal{E}_2$
$(-a_1^{1/2}, (a_1/a_0)^{1/4})$	$-\text{Id}_{2 \times 2}$	A_1	$\mathcal{H}_f - \mathcal{E}_{37}$
$(a_1^{1/2}, -(a_1/a_0)^{1/4})$	$-\text{Id}_{2 \times 2}$	A_1	$\mathcal{E}_5 - \mathcal{E}_6$
$(-a_1^{1/2}, -(a_1/a_0)^{1/4})$	$-\text{Id}_{2 \times 2}$	A_1	$\mathcal{H}_{\text{FGG}} - \mathcal{E}_{123567}$

Preimages of (-1) curves:

Curve	$(a_1^{1/2}, (a_1/a_0)^{1/4})$	$(-a_1^{1/2}, (a_1/a_0)^{1/4})$	$(a_1^{1/2}, -(a_1/a_0)^{1/4})$	$(-a_1^{1/2}, -(a_1/a_0)^{1/4})$	Image
$F = a_1^{1/2}$	$dF = 0$	-	$dF = 0$	-	$\mathcal{H}_{\text{FG}} - \mathcal{E}_{135}$
$F = -a_1^{1/2}$	-	$dF = 0$	-	$dF = 0$	\mathcal{E}_7
$G = (a_1/a_0)^{1/4}$	$dG = 0$	$dG = 0$	-	-	$\mathcal{H}_G - \mathcal{E}_1$
$G = -(a_1/a_0)^{1/4}$	-	-	$dG = 0$	$dG = 0$	\mathcal{E}_6
$F = -a_0^{1/4}G$	-	$dF = -a_0^{1/4}dG$	$dF = -a_0^{1/4}dG$	-	$\mathcal{H}_G - \mathcal{E}_5$
$F = a_0^{1/4}G$	$dF = a_0^{1/4}dG$	-	-	$dF = a_0^{1/4}dG$	\mathcal{E}_2
$F = a_0^{1/2}G^2$	$dF = 2a_0^{1/4}dG$	-	$dF = -2a_0^{1/4}dG$	-	\mathcal{E}_3
$F = -a_0^{1/2}G^2$	-	$dF = -2a_0^{1/4}dG$	-	$dF = 2a_0^{1/4}dG$	$\mathcal{H}_{\text{FG}} - \mathcal{E}_{157}$

After factorization we obtain surface $D_5^{(1)}/A_3^{(1)}$ with parameters and coordinates

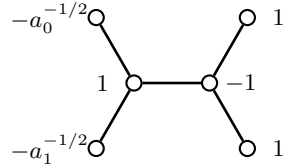

$$\begin{aligned}
 F &= -a_1^{-1/2} F \frac{(1 + a_1^{-1/4} a_0^{1/4} G)^2}{(a_1^{-1/2} F - a_1^{-1/4} a_0^{1/4} G)^2} \\
 G &= a_1^{-1/4} a_0^{1/4} G \frac{1 + a_1^{-1/2} F}{a_1^{-1/2} F + a_1^{-1/2} a_0^{1/2} G^2}
 \end{aligned} \tag{5.75}$$

Symmetry lattice is $A_1^{(1)}|_{|\alpha|^2=4}$, nodal curves and lattice is $\Phi_{\text{nod}} = 4A_1$, $\overline{\Phi}_{\text{nod}} = D_4$, $\overline{\Phi}_{\text{nod}}/\Phi_{\text{nod}}$ is generated by $-\mathcal{H}_{\text{FG}} + \mathcal{E}_{2367} = -\alpha_{2345}$, $\chi(-\alpha_{2345}) = -1$, symmetry group is as follows:

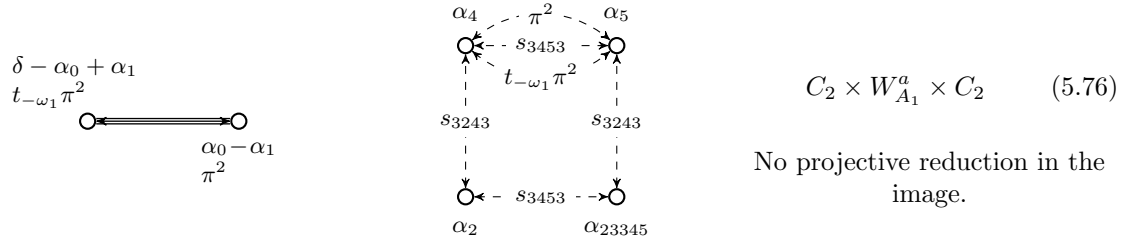

Here we obtain additional $C_2 = \text{Aut}^{\text{nod}}$, generated by s_{3243} , which changes root branch of $a_1^{1/2}$.

Branch of $a_1^{1/2} a_0^{-1/2}$ is defined by the folding action, and changing branch of $(a_1^{1/2} a_0^{-1/2})^{1/2}$ could be done by s_{3453} , which is image of σ .

5.7.2 σ

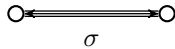

$$w = \sigma : \begin{aligned} F &\mapsto F \\ G &\mapsto -G \end{aligned} \tag{5.77}$$

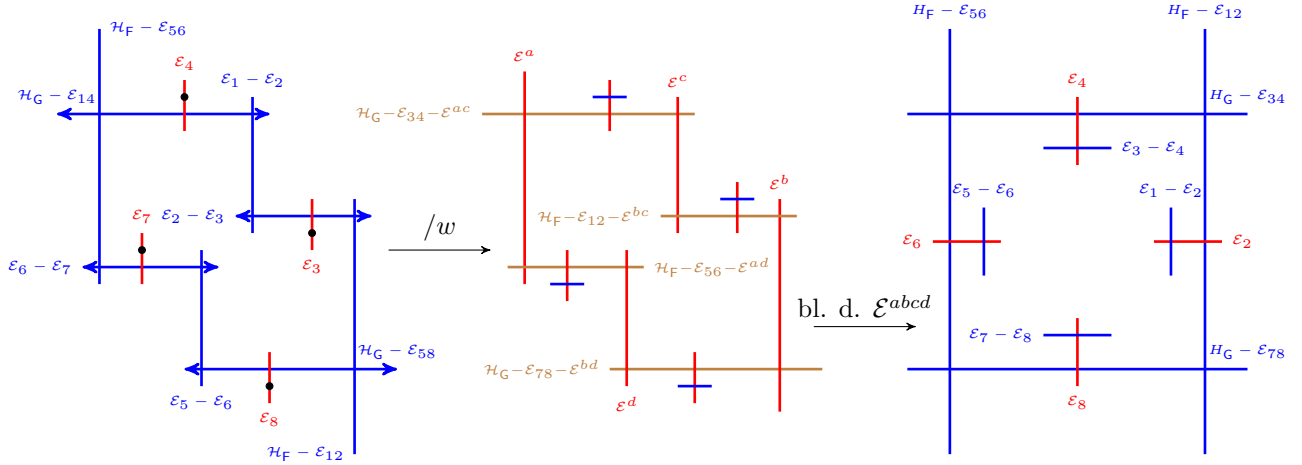

Under w we have non-singular pointwise invariant curves $G = 0, G = \infty, (G = 0, F \sim G^2), (G = \infty, F^{-1} \sim G^{-2})$ and 4 fixed points on blowups on these curves:

sing. pt.	action	except. div.	Image
$((F - a_1)/G = 0, G = 0)$	$\begin{pmatrix} -1 & 0 \\ 0 & -1 \end{pmatrix}$	A_1	$\mathcal{E}_7 - \mathcal{E}_8$
$((F - 1)/G^{-1} = 0, G^{-1} = 0)$	$\begin{pmatrix} -1 & 0 \\ 0 & -1 \end{pmatrix}$	A_1	$\mathcal{E}_3 - \mathcal{E}_4$
$((F/G^2 - a_0)/G = 0, G = 0)$	$\begin{pmatrix} -1 & 0 \\ 0 & -1 \end{pmatrix}$	A_1	$\mathcal{E}_5 - \mathcal{E}_6$
$((F^{-1}/G^{-2} - 1)/G^{-1} = 0, G^{-1} = 0)$	$\begin{pmatrix} -1 & 0 \\ 0 & -1 \end{pmatrix}$	A_1	$\mathcal{E}_1 - \mathcal{E}_2$

Under factorization we obtain non-minimal surface. Blowing down (-1) curves $\mathcal{E}^a, \mathcal{E}^b, \mathcal{E}^c, \mathcal{E}^d$ we obtain surface $D_5^{(1)}/A_3^{(1)}$ with parameters and coordinates

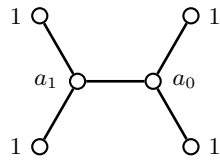

$$\begin{aligned} F &= F \\ G &= G^2/F \end{aligned} \quad (5.78)$$

Symmetry lattice is $A_1^{(1)}|_{|\alpha|^2=4}$, nodal curves and lattice is $\bar{\Phi}_{\text{nod}} = \Phi_{\text{nod}} = 4A_1$, symmetry group is as follows:

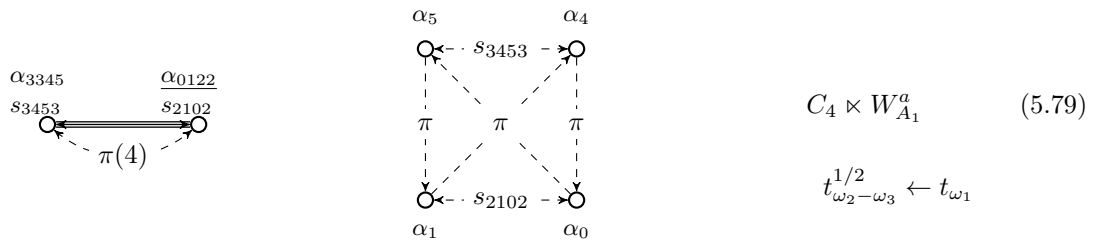

$$C_4 \times W_{A_1}^a \quad (5.79)$$

$$t_{\omega_2 - \omega_3}^{1/2} \leftarrow t_{\omega_1}$$

6 Further questions

6.1 Continuous limit

It is interesting to study the continuous limits of the folding transformations obtained here. These limits should be compared with the classification of differential Painlevé equation foldings [TOS05]. This is not straightforward since there are various limits from q -Painlevé equations to differential Painlevé ones (especially when parameters of q -equations are special).

For example, let us consider folding transformation discussed in Example 1.2. This is folding from $D_5^{(1)}/A_3^{(1)}$ to $A_1^{(1)}/A_7^{(1)'}$, which have standard degenerations to $D_4^{(1)}/D_4^{(1)}$ and $A_0^{(1)}/D_8^{(1)}$ correspondingly. Thus, naively one could expect that continuous limit corresponds to the folding between Painlevé VI and Painlevé III($D_8^{(1)}$) equations. But, according to [TOS05] (see Fig. 1 in loc. cit.) there is no such folding.

In the Introduction we obtained, that for the invariant set $a_0 = a_1 = a_4 = a_5 = -1$ of given folding $w = s_0 s_1 s_4 s_5$ standard Painlevé $D_5^{(1)}/A_3^{(1)}$ dynamics could be rewritten as “half-shift” equation on single function F ((1.7)):

$$F(qz)F(q^{-1}z) = -\frac{F(z)^2 - z}{F(z)^2 - 1}, \quad (6.1)$$

where we denoted $z = a_2^2$. From the other hand, from Painlevé $A_1^{(1)}/A_7^{(1)'}$ equation (1.8), we obtain

$$F(qz)F(q^{-1}z) = \left(\frac{F - z}{F - 1}\right)^2. \quad (6.2)$$

Let us make standard limit, rescaling

$$z \mapsto \hbar^4 z, \quad F \mapsto \hbar F \Rightarrow F \mapsto \hbar^2 F, \quad \text{where } \hbar = \log q \quad (6.3)$$

and tending $\hbar \rightarrow -0$. Namely, after such limit from (6.2) we obtain

$$F'' = \frac{F'^2}{F} - \frac{F'}{z} + \frac{2F^2}{z^2} - \frac{2}{z}, \quad (6.4)$$

which is Painlevé III($D_8^{(1)}$) equation. This limit of (6.1) will be

$$F'' = \frac{F'^2}{F} - \frac{F'}{z} + \frac{F^3}{z^2} - \frac{1}{zF} \quad (6.5)$$

Under substitution $z = t^2/16$, $F \mapsto F/2$ we obtain

$$\ddot{F} = \frac{\dot{F}^2}{F} - \frac{\dot{F}}{t} + \frac{F^3}{t^2} - \frac{1}{F}, \quad (6.6)$$

which is Painlevé III ($D_6^{(1)}$) equation with $\theta_* = 0$, $\theta_* = 1/2$. Finally, we have that after the limit folding $w = s_0 s_1 s_4 s_5 : D_5^{(1)}/A_3^{(1)} \rightarrow A_1^{(1)}/A_7^{(1)'}$ goes to the folding 5.2 from [TOS05] from $A_2^{(1)}/D_6^{(1)}$ to $A_0^{(1)}/D_8^{(1)}$ with $F = F^2/4$, $z = t^2/16$.

6.2 Relation to known foldings of q -Painlevé equations

Few foldings of q -Painlevé equations were found in the paper [RGT00]. The constructions in loc. cit. were based on two possibilities: either right side of equation becomes perfect square or depend in some variable x through its square x^2 . The relation between formulas in [RGT00] and classification, obtained in this paper is the following [RGT00]. Here we present the relation of these results to the classification of folding transformation, obtained in our paper:

1. Section 3.1 of loc. cit. in perfect square case corresponds to $2A_1 : D_5^{(1)}/A_3^{(1)} \rightarrow E_7^{(1)}/A_1^{(1)}$.
2. Section 3.1 of loc. cit. in square dependence case corresponds to $4A_1 : E_7^{(1)}/A_1^{(1)} \rightarrow D_5^{(1)}/A_3^{(1)}$.

3. Section 3.3 of loc. cit. in perfect square case corresponds to $A_1 : E_3^{(1)}/A_5^{(1)} \rightarrow E_6^{(1)}/A_2^{(1)}$.

4. Section 3.3 of loc. cit. in square dependence case corresponds to $4A_1 : E_6^{(1)}/A_2^{(1)} \rightarrow E_3^{(1)}/A_5^{(1)}$.

Note that foldings from perfect square cases and square dependence cases form pairs of opposite foldings, see Remark 3.7.

A Foldings, leaving no dynamics

Sym./surf.	Diagram	Name	Order	w	A_w, N_{flip}
$E_8^{(1)}/A_0^{(1)}$		$A_1 + A_2 + A_5$	6	$w = s_0 s_{12} s_8 s_{7654}$ $w^2 = s_{576} (s_{21} s_{54} s_{87}) s_{675}$ $w^3 = s_{675} (s_0 s_4 s_6 s_8) s_{576}$	$(-1, \zeta, \zeta_6), (-1, \zeta^{-1}, \zeta_6^{-1})$
		$2A_4$	5	$s_0 s_{321} s_5 s_{678}$	$(\zeta_5^i, \zeta_5^{3i}), i = 1, 2, 3, 4$
$E_7^{(1)}/A_1^{(1)}$		$A_1 + 2A_3$	4	$s_0 s_7 s_{65} s_{123}$ $w^2 = s_{26} (s_1 s_3 s_5 s_7) s_{62}$	$(-1, i, i), (-1, -i, -i)$
		$A_2 + A_5$	6	$s_0 s_{4321} s_8 s_7$ $w^2 = s_{423} (s_{04} s_{21} s_7 s_6) s_{324}$ $w^3 = s_{324} s_0 s_1 s_3 s_4 s_{23}$	$(\zeta_6, \zeta), (\zeta_6^{-1}, \zeta^{-1})$
		$\pi \times 3A_2$		$\pi s_{12} s_{04}$ $w^2 = s_{12} s_{40} s_7 s_6$ $w^3 = s_{67} \pi s_7 s_6$	$(\zeta, \zeta, a_5 = \zeta a_3) (\zeta^{-1}, \zeta^{-1}, a_3 = \zeta a_5)$
$E_6^{(1)}/A_2^{(1)}$		$3A_2$	3	$s_0 s_6 s_{12} s_5 s_4$	$(\zeta, \zeta, \zeta), (\zeta^{-1}, \zeta^{-1}, \zeta^{-1})$
		$A_1 + A_5$	6	$s_0 s_{12345}$ $w^2 = s_{243} (s_{12} s_{45}) s_{342}$ $w^3 = s_{342} (s_0 s_1 s_3 s_5) s_{243}$	$(-1, \zeta_6) (-1, \zeta_6^{-1})$
		$\pi \times 4A_1$		$\pi s_1 s_3$ $w^2 = s_5 (\pi^2) s_5$ $w^3 = s_0 s_1 s_3 s_5$	$(-1, -1, -1, -1; a_4 = a_2 = -a_6)$
$A_4^{(1)}/A_4^{(1)}$		π	5	π	$(a_0 = a_1 = a_2 = a_3 = a_4)$
		A_4		s_{1234}	$(\zeta_5^i), i = 1, 2, 3, 4$
$E_3^{(1)}/A_5^{(1)}$		π	6	π $w^2 = \pi^2$ $w^3 = \pi^3$	$(a_0 = a_1 = a_2, a_3 = a_4)$
		$A_2 + A_1$		$s_{21} s_4$ $w^2 = s_{12}$ $w^3 = s_4$	$(\zeta, -1), (\zeta^{-1}, -1)$
		$\pi^3 \times A_2$		$\pi^3 s_1 s_2$ $w^2 = s_2 s_1$ $w^3 = \pi^3$	$(\zeta; a_3 = a_4), (\zeta^{-1}; a_3 = a_4)$
		$\pi^2 \times A_1$		$\pi^2 s_4$ $w^2 = \pi^4$ $w^3 = s_4$	$(-1; a_0 = a_1 = a_2)$
$E_1^{(1)}/A_7^{(1)}$		π	4	π	$(a_0 = a_1)$
		A_1	2	s_1	(-1)
		$\pi^2 \times A_1$		$\pi^2 s_1$	(-1)

Sym./surf.	Diagram	Name	Group	\mathcal{A}_w
$E_7^{(1)}/A_1^{(1)}$		$\pi \times (A_1 + A_3)$	$\underbrace{C_2}_{\pi} \times (\underbrace{C_2}_{s_0 s_1^2 s_2 s_3} \times \underbrace{C_4}_{s_0 s_1 s_2 s_3 s_4 s_5 s_6 s_7})$	$(-1, i, i), (-1, -i, -i)$
$E_7^{(1)}/A_1^{(1)}$		$\pi \times (A_1 + A_3)$	$\underbrace{C_2}_{\pi} \times \underbrace{C_4}_{s_0 s_1 s_2 s_3 s_4 s_5 s_6 s_7} \subset C_2 \times (C_2 \times C_4)$	$(-1, i, i), (-1, -i, -i)$
$E_6^{(1)}/A_2^{(1)}$		$\pi \times 3A_2$	$\underbrace{C_3}_{\pi} \times (\underbrace{C_3}_{s_{12} s_{45}} \times \underbrace{C_3}_{s_{06} s_{45}})$	$(\zeta, \zeta, \zeta), (\zeta^{-1}, \zeta^{-1}, \zeta^{-1})$
		$\pi \times 3A_2$	$\underbrace{C_3}_{\pi} \times \underbrace{C_3}_{s_{06} s_{12} s_{54}} \subset C_3 \times C_3^2$	$(\zeta, \zeta, \zeta), (\zeta^{-1}, \zeta^{-1}, \zeta^{-1})$
		$3A_2$	$\underbrace{C_3}_{s_{12} s_{45}} \times \underbrace{C_3}_{s_{06} s_{12} s_{54}} \subset C_3^3$	$(\zeta, \zeta, \zeta), (\zeta^{-1}, \zeta^{-1}, \zeta^{-1})$
$D_5^{(1)}/A_3^{(1)}$		$\pi \times 4A_1$	$\underbrace{C_4}_{\pi} \times (\underbrace{C_2}_{s_0 s_1} \times \underbrace{C_2}_{s_4 s_5})$	$(-1, -1, -1, -1; a_2 = a_3)$
		$\pi^2 \times (2A_1 + A_3)$	$\underbrace{C_2}_{\pi^2} \times (\underbrace{C_2}_{s_0 s_1} \times \underbrace{C_4}_{s_1 s_5 s_3 s_4})$	$(-1, -1, i), (-1, -1, -i)$
		$\pi \times 4A_1$	$\underbrace{C_4}_{\pi} \times \underbrace{C_2}_{s_0 s_1 s_4 s_5} \subset C_4 \times C_2^2$	$(-1, -1, -1, -1; a_2 = a_3)$
		$2A_1 + A_3$	$\underbrace{C_2}_{s_0 s_1} \times \underbrace{C_4}_{s_1 s_5 s_3 s_4} \subset C_2 \times (C_2 \times C_4)$	$(-1, -1, i), (-1, -1, -i)$
$E_1^{(1)}/A_7^{(1)}$		$\pi^2 \times A_1$	$\underbrace{C_2}_{\pi^2} \times \underbrace{C_2}_{s_1} \times \underbrace{C_2}_{\sigma}$	(-1)
		$\pi \times \sigma$	$\underbrace{C_4}_{\pi} \times \underbrace{C_2}_{\sigma}$	$(a_0 = a_1)$
		$\pi^2 \times A_1$	$\underbrace{C_2}_{\pi^2} \times \underbrace{C_2}_{s_1}$	(-1)
		$\sigma \times A_1$	$\underbrace{C_2}_{s_1} \times \underbrace{C_2}_{\sigma}$	(-1)

References

- [AGT10] Luis F. Alday, Davide Gaiotto, and Yuji Tachikawa. Liouville correlation functions from four-dimensional gauge theories. *Lett. Math. Phys.*, 91(2):167–197, 2010. [arXiv:0906.3219].
- [Bea96] Arnaud Beauville. *Complex algebraic surfaces*, volume 34 of *London Mathematical Society Student Texts*. Cambridge University Press, Cambridge, second edition, 1996. Translated from the 1978 French original by R. Barlow, with assistance from N. I. Shepherd-Barron and M. Reid.
- [BGT19] Giulio Bonelli, Alba Grassi, and Alessandro Tanzini. Quantum curves and q -deformed Painlevé equations. *Lett. Math. Phys.*, 109(9):1961–2001, 2019. [arXiv:1710.11603].
- [BPZ84] A. A. Belavin, A. M. Polyakov, and A. B. Zamolodchikov. Infinite conformal symmetry in two-dimensional quantum field theory. *Nuclear Phys. B*, 241(2):333–380, 1984.
- [BS17] M A Bershtein and A I Shchekkin. Q -deformed Painlevé tau function and q -deformed conformal blocks. *Journal of Physics A: Mathematical and Theoretical*, 50(8):085202, Jan 2017. [arXiv:1608.02566].
- [BS19] M. Bershtein and A. Shchekkin. Painlevé equations from Nakajima-Yoshioka blowup relations. *Lett. Math. Phys.*, 109(11):2359–2402, 2019. [arXiv:1811.04050].
- [Car72] R. W. Carter. Conjugacy classes in the Weyl group. *Compositio Math.*, 25:1–59, 1972.
- [EH16] David Eisenbud and Joe Harris. *3264 and all that—a second course in algebraic geometry*. Cambridge University Press, Cambridge, 2016.
- [FLNO09] Vladimir A. Fateev, Alexey V. Litvinov, André Neveu, and Enrico Onofri. A differential equation for a four-point correlation function in Liouville field theory and elliptic four-point conformal blocks. *J. Phys. A*, 42(30):304011, 29, 2009. [arXiv:0902.1331].
- [Ful93] William Fulton. *Introduction to toric varieties*, volume 131 of *Annals of Mathematics Studies*. Princeton University Press, Princeton, NJ, 1993. The William H. Roever Lectures in Geometry.
- [GIL12] O. Gamayun, N. Iorgov, and O. Lisovyy. Conformal field theory of Painlevé vi. *Journal of High Energy Physics*, 2012(10), Oct 2012. [arXiv:1207.0787].
- [GIL13] O Gamayun, N Iorgov, and O Lisovyy. How instanton combinatorics solves Painlevé vi, v and iiis. *Journal of Physics A: Mathematical and Theoretical*, 46(33):335203, Jul 2013. [arXiv:1302.1832].
- [GR04] B. Grammaticos and A. Ramani. Discrete Painlevé equations: a review. In *Discrete integrable systems*, volume 644 of *Lecture Notes in Phys.*, pages 245–321. Springer, Berlin, 2004.
- [HJS10] Leszek Hadasz, Zbigniew Jaskólski, and Paulina Suchanek. Recursive representation of the torus 1-point conformal block. *J. High Energy Phys.*, (1):063, 13, 2010. [arXiv:0911.2353].
- [Hum90] James E. Humphreys. *Reflection groups and Coxeter groups*, volume 29 of *Cambridge Studies in Advanced Mathematics*. Cambridge University Press, Cambridge, 1990.
- [Hum95] James E. Humphreys. *Conjugacy classes in semisimple algebraic groups*, volume 43 of *Mathematical Surveys and Monographs*. American Mathematical Society, Providence, RI, 1995.
- [JNS17] M. Jimbo, H. Nagoya, and H. Sakai. Cft approach to the q -Painlevé vi equation. *J. Integrab. Syst.*, 2(1):1, 2017. [arXiv:1706.01940].
- [KN13] Kenji Kajiwara and Nobutaka Nakazono. Hypergeometric solutions to the symmetric q -Painlevé equations. *International Mathematics Research Notices*, 2015(4):1101–1140, 11 2013. [arXiv:1304.0858].

- [KNT11] Kenji Kajiwara, Nobutaka Nakazono, and Teruhisa Tsuda. Projective reduction of the discrete Painlevé system of type $(A_2 + A_1)^{(1)}$. *Int. Math. Res. Not. IMRN*, (4):930–966, 2011. [[arXiv:0910.4439](#)].
- [KNY17] Kenji Kajiwara, Masatoshi Noumi, and Yasuhiko Yamada. Geometric aspects of Painlevé equations. *Journal of Physics A: Mathematical and Theoretical*, 50(7):073001, Jan 2017. [[arXiv:1509.08186](#)].
- [MN19] Yuya Matsuhira and Hajime Nagoya. Combinatorial expressions for the Tau functions of q-Painlevé v and iii equations. *Symmetry, Integrability and Geometry: Methods and Applications*, Sep 2019. [[arXiv:1811.03285](#)].
- [Nek03] Nikita A. Nekrasov. Seiberg-Witten prepotential from instanton counting. *Adv. Theor. Math. Phys.*, 7(5):831–864, 2003. [[arXiv:hep-th/0206161](#)].
- [NY05a] Hiraku Nakajima and Kōta Yoshioka. Instanton counting on blowup. I. 4-dimensional pure gauge theory. *Invent. Math.*, 162(2):313–355, 2005. [[arXiv:math/0306198](#)].
- [NY05b] Hiraku Nakajima and Kōta Yoshioka. Instanton counting on blowup. II. K -theoretic partition function. *Transform. Groups*, 10(3-4):489–519, 2005. [[arXiv:math/0505553](#)].
- [Pog09] Rubik Poghosian. Recursion relations in CFT and $N = 2$ SYM theory. *J. High Energy Phys.*, (12):038, 14, 2009. [[arXiv:0909.3412](#)].
- [RGT00] A Ramani, B Grammaticos, and T Tamizhmani. Quadratic relations in continuous and discrete Painlevé equations. *Journal of Physics A: Mathematical and General*, 33(15):3033–3044, apr 2000.
- [RNGT09] A Ramani, H Nagoya, B Grammaticos, and T Tamizhmani. Folding transformations for quantum Painlevé equations. *Journal of Physics A: Mathematical and Theoretical*, 42(9):095211, feb 2009.
- [Sak01] Hidetaka Sakai. Rational surfaces associated with affine root systems and geometry of the Painlevé equations. *Comm. Math. Phys.*, 220(1):165–229, 2001.
- [Shc20] Anton Shchekhin. *Painlevé equations and representation theory*. PhD thesis, HSE University, 2020. [[HSE Link](#)].
- [TOS05] Teruhisa Tsuda, Kazuo Okamoto, and Hidetaka Sakai. Folding transformations of the Painlevé equations. *Math. Ann.*, 331(4):713–738, 2005.