

# Precise URL Phishing Detection Using Neural Networks

Aman Rangapur, Dr. Ajith Jubilson  
VIT-AP University, Andhra Pradesh.

## 1. Abstract

*With the development of the Internet, ways of obtaining important data such as passwords and logins or sensitive personal data have increased. One of the ways to extract such information is page impersonation, also called phishing. Such websites do not provide service but collect sensitive details from the user. Here, we present you with ways to detect such malicious URLs with state of art accuracy with neural networks. Different from previous works, where web content, URL or traffic statistics are examined, we analyse only the URL text, making it faster and which detects zero-day attacks. The network is optimised and can be used even on small devices such as Ras-Pi without a change in performance.*

*Keywords: malicious URLs, phishing, neural networks, sensitive data.*

## 2. Introduction

Phishing is a cyber-attack that can be defined as a method of identity theft that is often carried out by a fraudulent website or email requesting the user to give credentials or personal information like credit cards or online way of transaction which appears to be from a reputable source or brand and it is one of the major problems faced by the world-leading to many financial losses. To make secure browsing we need strong detection mechanisms. In the past decades, phishing defensive mechanisms have used three approaches which are Blacklist/whitelist, Heuristic approach, visual similarity. The visual similarities were further divided into models like DOM(document object model), visual features, CSS features, pixel-based features, image layout-based

approach, etc. But these techniques had limitations to overcome these vulnerabilities. The cybersecurity experts developed toolbar virtualization techniques such as Netcraft, Ebay\_Guard, McAfee site advisor, etc. These approaches were not precise every time and there was a high probability of phishing. To counter this machine learning was used as a tool to make strong phishing detection algorithms that can reduce phishing attacks to a greater extent.

Machine learning is a field within computer science that differs from traditional computing. In traditional computing, algorithms follow the set of rules and get executed whereas Machine Learning algorithms allow computers to train on data and use statistical analysis to output the value. In addition to this, neural networks and genetic algorithms make the code very efficient. Neural networks are a means of doing machine learning in which a computer learns to perform some task by analyzing training data; it's a process that mimics the way the human brain operates. Neural network generates the best possible result without any need of redesigning the output criteria. Whereas genetic algorithms stimulate the process as in natural systems for evolution. The GAs run a random search to solve optimization problems. The GA uses techniques that use the previously used information to direct their search towards optimization.

The motivation of this research is to improve the detection accuracy and using these techniques or a combination of any two makes the detection very efficient which can lead to higher levels of accuracy and here we will use supervised machine learning algorithms like GRU, KNN,

LSTM with and without GA to show the difference in their accuracy.

### 3. Existing approaches

Phishing attacks have been studied repeatedly, but most of them were not perfect. Despite getting solutions and accuracy, it required complicated calculations, which made it difficult to use and took a lot of time to detect. The easiest way of protection is by blacklisting phishing URL addresses, which is later analyzed by a browser, antivirus system, or firewall [1-2]. The blacklist has to be created by merging many sources of phishing addresses. Likewise, it is possible to curate a whitelist of safe websites. A system white-listing authorized websites is created in [3]. A lot of people claim that white lists are safer than black lists as they are smaller and more accurate than black lists. The system achieved 86.02% accuracy in [4] the white list created from websites visited by the user. Preventing an attack, in this case, is very simple and effective as long as the address is on the blacklist. The address has to be identified and added to this list. Another drawback is the need to search the list of suspicious addresses whenever we refer to a new URL.

The majority of the proposed machine learning systems are based on engineering features. One of the most used anti-phishing systems is CANTINA [5] which uses the most repeated words on the page to check the page in a search engine. The system uses the term frequency-inverse document frequency weighting scheme to compute word frequency on the page, The 5 terms with the highest scores constitute the page descriptor used to query the search engine. If the domain name is within the top N search results, then the web page is authorized. The updated version, CANTINA+ [6] used additional 15 attributes extracted from the page HTML. This system was a huge breakthrough at the time. The drawback of these

two solutions is the use of a search engine to find out whether the address certainly matches the desired page causing additional network load. Additionally, the attacker could promote the phishing website in the search engine to make it seem legitimate.

Authors have [7] achieved 97.71% accuracy using a modified MLP with a novel learning scheme; they used 30 features from a publicly available URL dataset. All the above-mentioned URL-based works used hand-crafted features. The idea is similar to the proposed in the current paper only that the URL is examined without depending on other web page features, such as HTML, and external databases. The above papers used statistics regarding the URL (extracted features), whereas in [8] the URL text is directly examined by recurrent neural networks (RNN) which coincides with our approach. RNNs are suitable to model, inter alia, temporal phenomena, [8] they are used to analyze URL characters consecutively. The authors used an updated version of RNNs called Long Term Short Term Memory (LSTM). They obtained 98.76% accuracy, and in the approach presented in this paper, we use similar data. We also examine the URL text, but with convolutional neural networks with embeddings and one-hot encoding. Our intention is to obtain most of the details from the text analysis.

### 4. Web Phishing Attack

The constant development of web services and e-commerce platforms have encouraged many phishers and criminals to develop new ways to exploit and deceive novice users to send their financial information [9–12]. Even though forums, Internet relay chat, black hat search engine optimisation, key-loggers, screen captures, trojan and instant messaging are additional ways used by phishers to take the user's information, by sending emails to the targeted users by the phishers is the most

popular way of initiate web phishing attack [16, 17–25].

In a web phishing attack using email, the phisher deceives web users by developing a fake website to steal the financial and personal information of the users. Web phishing attacks can be achieved in many ways [11, 12, 14]. Initially, the phisher makes a phishing website, which looks like the original website in its appearance. Eventually, many emails containing hyperlinks to the phishing website are continually sent to users by the phisher, which requests validating or updating credentials and financial information in order to deceive the victims. In the 3rd stage, the target victims are redirected to the phishing website when the hyperlinks are clicked. If the information is entered by victims through the phishing website then the phisher can fully control the financial information of the victim. As a result, many financial and identity thefts can be executed after web successful phishing attacks [11, 12, 14]. Fig. 1 shows the life cycle of a web phishing attack.

Spear phishing is a dangerous variant of email-based phishing attacks with a directed focus. It is a phishing method that uses email to target specific individuals or organisations in order to steal important information for malicious purposes. The phishers send emails requesting important information related to the company, which looks like emails sent by a colleague or manager of the company [15].

To overcome web phishing attacks, the blacklist-based and intelligent heuristics-based approaches are 2 popular ways suggested in the literature and developed to make people aware of phishing websites. In this approach, many URLs of phishing websites are collected based on reported phishing sources and then saved into a database. The blacklist-based approach

differentiates the phishing website by examining if the website requested by the user is in the phishing websites database or not. Next is the intelligent heuristics-based approach, intelligent machine learning classifiers are trained based on some phishing and legitimate websites with influential website features as training data, and then used to successfully detect the newly developed phishing websites [9–14].

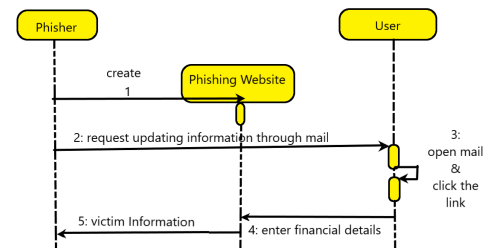

*Fig. 1: Life cycle of a web phishing attack.*

## 5. Methodology

In this paper, we had used different techniques to achieve maximum accuracy for phishing detection. A few of them are LSTM, GRU, GRU and KNN with Genetic Algorithms. We made a dataset by collecting phishing and normal links. Fed 80% into training and the remaining amount to testing and the results are shown in section 6.

**Long Short-Term Memory**[26] was introduced to address the long-term dependency problem. In LSTM we have a hidden state which an LSTM block would output and an internal cell state which maintains the information across a temporal context, the cell stores the long term information and the LSTM can erase, write and read information from that cell based on whatever a context defines. On step  $t$ , there is a hidden state  $h_t$  and a cell state  $C_t$ . The selection of the particular information erased or written or read is controlled by three corresponding gates each for erasing, writing and reading respectively.

On each timestamp, these gates could assume values:

- 1, which is called “open”. It allows all the information to pass through.
- 0, which is called “closed”. It does not allow any information to pass through.
- In between 0-1 which has information lying between the mentioned value.

These gate values are dynamic and are learnt and computed based on the input at a particular time step and the hidden state that comes from the previous time step. An RNN has a general form of a chain repeating module if we take vanilla RNN which is a single layer with tanh activation.

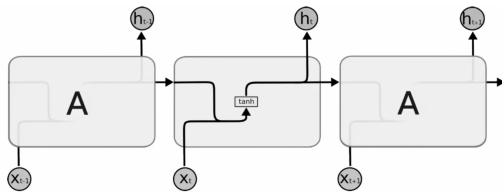

**Fig. 2: Vanilla RNN architecture.**

In Fig. 2, an input  $x_{t-1}$  at  $t-1$ ,  $x_t$  at time  $t$  and  $x_{t+1}$  at  $t+1$ . And it is a single neural network which has a tanh activation function and the input at a particular time step  $h_t$  as well as  $h_{t-1}$  (output of the previous RNN block) which is provided as input and tanh is applied that gives us  $h_t$  and it is given as output as well as given input for the next RNN block at the next time step. LSTM has a similar structure, it is a chain of repeating modules where we apply the same block at every time step. Here, the structure of each block contains four different layers which interact with each other and these are not sequential layers, unlike the above RNN.

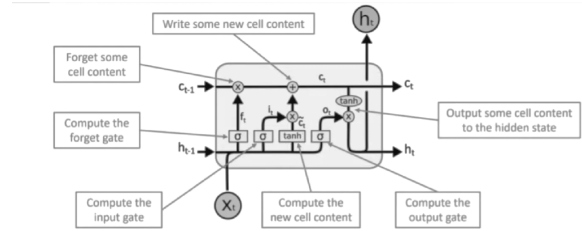

**Fig. 3: LSTM architecture.**

There are four different blocks in Fig. 3. They are:

1. Forget gate which decides to forget some cell content coming from the previous state.
2. Input gate along with tanh activation function decides how much of the input must be written and also adds that new cell content at the end.
3. Output gate decides how much of the cell state ( $C_t$ ) should be exposed as the hidden state ( $h_t$ ).

The sigmoid function is used in these three blocks because the output should lie between 0-1. Cell state ( $C_t$ ) has the ability to remove and add information to the cell state which is regulated by gates. The following points show the working of LSTM.

1. Forget gate layer uses a sigmoid function to decide the information to be thrown away from the cell state.

$$f_t = \sigma(W_f \cdot [h_{t-1}, x_t] + b_f)$$

2. Now, decide the information to be stored in the cell state. Input gate layer (sigmoid function) decides the values to be updated and the tanh function creates the new vector value which is added to the state.

$$i_t = \sigma(W_i \cdot [h_{t-1}, x_t] + b_i)$$

$$C_t = \tanh(W_c \cdot [h_{t-1}, x_t] + b_c)$$

3. We need to update the old cell state into the new cell. Multiply the old cell with the cell which contains information that we want to forget and sum it with the dot product of the result from the previous step.

$$C_t = f_t * C_{t-1} + i_t * C_t$$

4. A filtered version of output is formed in the cell state; run the sigmoid layer to decide the part of the cell states for output. Apply tanh activator to the cell state and multiply it with the output of the sigmoid gate where the value lies between 0-1.

$$o_t = \sigma(W_o \cdot [h_{t-1}, x_t] + b_o)$$

$$h_t = o_t * \tanh(C_t)$$

**Gated Recurrent Unit**[27] was proposed as an alternative to LSTM which is simpler, it combines forget and input gates into a single update gate as well as it merges the cell state and hidden state.

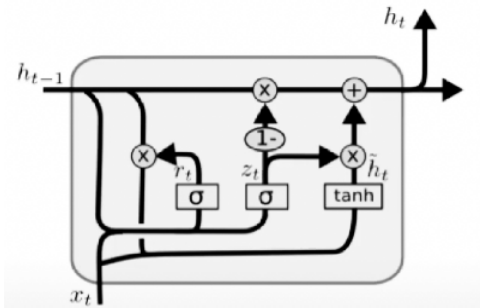

**Fig. 4:** GRU architecture.

Update gate controls what parts of the hidden state are updated and preserved respectively.

$$z_t = \sigma(W_z \cdot [h_{t-1}, x_t])$$

Reset gate controls which parts of the previous hidden state are used to compute the fresh subject.

$$r_t = \sigma(W_r \cdot [h_{t-1}, x_t])$$

New hidden state(reset gate) content selects useful parts of the previous hidden state. It uses the current input to compute new hidden content.

$$h_t = \tanh(W \cdot [r_t * h_{t-1}, x_t])$$

The hidden state(update gate) simultaneously controls what is kept from the previous hidden state, and what is updated to new hidden state content.

$$h_t = (1 - z_t) * h_{t-1} + z_t * h_t$$

If reset gate is set to all 1's and update gate to all 0's then in reset gate  $h_t$  will be  $\tanh(W * [h_{t-1}, X_t])$  and in update gate,  $h_t$  becomes  $h_{t-1}$  respectively. Input and forget gates of LSTM are coupled by an update gate in GRU; reset gate in GRU is applied directly to the previous hidden state.

**K Nearest Neighbours** are what that stands for KNN is one of the simplest supervised machine learning algorithms mostly used for classification so if we want to know whether it is a dog or it's not a dog or is it a cat or not a cat, it classifies a data point based on how its neighbours are classified. KNN stores all available cases and classifies new cases based on a similarity measure. k is a parameter that refers to the number of nearest neighbours to include in the majority of the voting process and so if we add a new glass of wine red or white we want to know what the neighbours are in this case. Let's assume k equals five and the data point is classified by the majority of votes from its five nearest neighbours here and based on this the unknown point would be classified, choosing the

right value of  $k$  is a process called parameter tuning and is important for better accuracy and we will get drastic changes if we play around with values of  $k$ . In terms of KNN, the value of  $k$  you choose, if it is too low, the bias is based on the noisy region and it's gonna pick those data points which are very near and you will get the answer and if your  $K$  is too big then it's gonna take forever to process so you're gonna run into processing issues or resource issues, the other options for choosing  $K$  is to use the square root of  $n$ , for the total number of values you have got, take the square the root of it and in most of the cases, it's an even number. You can add or subtract one from the even value of  $k$  which you got and check if the accuracy is increasing or decreasing.

#### Working of KNN:

1. Prepare the dataset and split it into training and testing.
2. Choose the value of  $k$  as we discussed above.
3. Calculate the Euclidean distance between the test dataset and each row of the training dataset.
4. Sort them in ascending order based on the distance value.
5. It will choose the top  $k$  rows from the above values.
6. It will assign a class to the test data point based on the most frequent class of these values.

#### Genetic Algorithm:

A genetic algorithm is a very powerful non-traditional optimization technique that mimics the process of evolution. The evolutionary technique is the process of evolution and development of algorithms where we rely on mathematical computation. There are several evolutionary optimization techniques, the most important among them is the genetic algorithm(GA). A Genetic Algorithm is

basically a search algorithm that is based on the survival of the fittest concept, the Darwinian theory. Only the fittest will survive and reproduce and procreate, and successive generations will become better and better compared to previous generations.

A population of  $2n$  to  $4n$  trial solution is used, where  $n$  is the number of variables. So, if it is two-variable problem, we basically use a 4 to 8 solution; you start with 4 to 8 the solution, each solution is represented by a string of binary variables, corresponding to chromosomes in genetics. So, for each solution, we need to represent it has 0's and 1's; the string length can be large enough to achieve any desired fitness of approximation, that is even decimal can be taken care of. And thus, any desired accuracy can be achieved after applying recombination operators (Selection, crossover and mutation) repeatedly to preserve a good portion of the strings. The below figure shows the steps involved in GA.

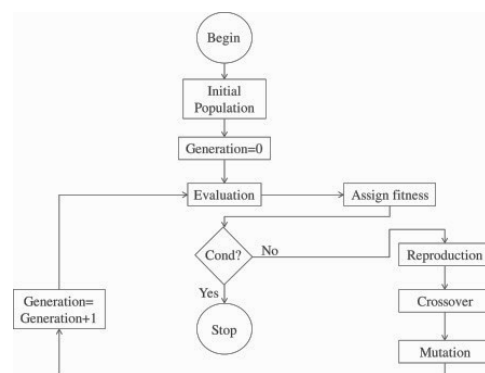

**Fig. 5:** Process in Genetic Algorithm.

#### Working of Genetic Algorithm:

1. Split the dataset into testing and training, choose  $k$  number of samples

from the training dataset for generating initial values of data.

2. Calculate the fitness value which is the distance between the samples of training data in each chromosome.
3. Choose the chromosome which has the highest fitness value and assign it with some variable(G).

For  $i=1$  to  $n$ :

Perform reproduction

Apply the crossover operation.

Archive mutation and get the

new values(v2).

Calculate the local

maximum(L).

if( $G < L$ ):

$G=L$ ;

$v1 = v2$ ;

4. The chromosome which obtains the highest fitness value(G) has the optimum K-neighbours and the labels corresponding to it are the results.

## 6. Results

The maximum accuracy we achieved was 97.1% using GRU with a Genetic Algorithm approach followed by GRU, Random Forest, DNN, KNN with Genetic Algorithm. Table. 1 represents the results obtained using different models.

| Method              | Accuracy |
|---------------------|----------|
| Logistic Regression | 92.1%    |
| KNN                 | 62.9%    |
| Decision Tree       | 87.8%    |
| Random Forest       | 92.4%    |
| SVM                 | 51.2%    |
| DNN                 | 96%      |
| LSTM                | 90.2%    |

|        |       |
|--------|-------|
| GRU    | 96.3% |
| GRU-GA | 97.1% |
| KNN-GA | 94.9% |

**Table. 1:** Accuracy using different methods.

In the proposed paper, the model was trained with Tanh activation function with a dropout ratio of 0.25 for 2 layers using the cross-entropy function for 20 epochs. Table. 2 shows the parameters used for DNN training. Fig. 6-9 shows the results obtained in the form of graphs.

| Parameter             | Value         |
|-----------------------|---------------|
| Activation Function   | Tanh          |
| Hidden dropout ratio  | 0.25          |
| No. of layers         | 2             |
| Loss function         | Cross entropy |
| No. of maximum epochs | 20            |

**Table. 2:** Parameters used while training..

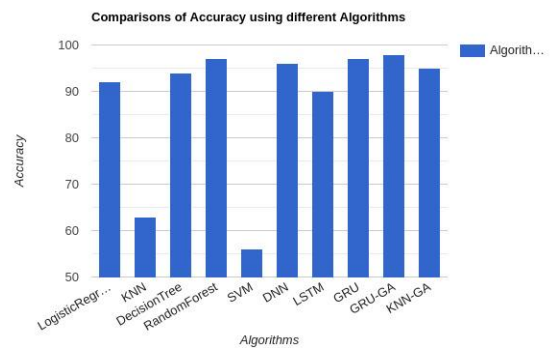

**Fig. 6:** Comparison of Accuracy using different Algorithms

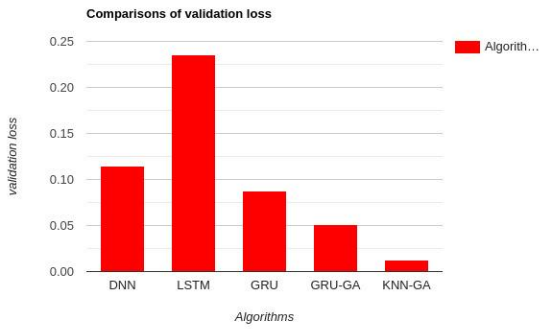

**Fig. 7:** Comparison of validation loss.

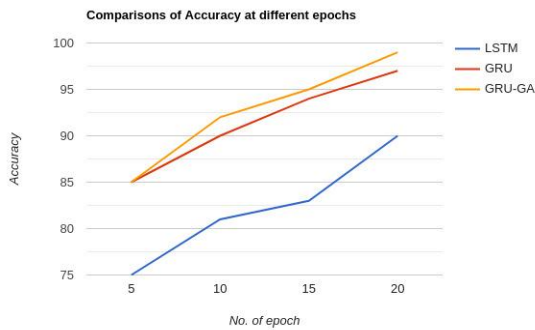

**Fig. 8:** Comparison of Accuracy at different epochs.

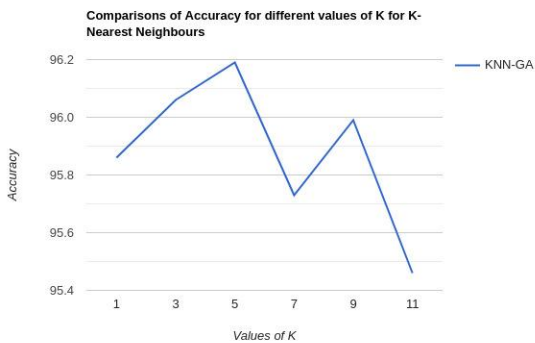

**Fig. 9:** Comparison of Accuracy for different values of K for K-Nearest Neighbours

## 9. Reference

1. Lakshmi, V.S., Vijaya, M.S.: 'Efficient prediction of phishing websites using supervised learning algorithms', *Proc. Eng.*, 2012, 30, pp. 798–805
2. James, J., Sandhya, L., Thomas, C.: 'Detection of phishing URLs using machine learning techniques'. *Int. Conf. on Control*

## 7. Acknowledgements

I would like to thank **Dr Ajith Jubilson** for providing continuous support, giving reviews, and feedback regarding the paper.

## 8. Conclusion

This study recommended various approaches for the prediction of phishing websites based on RNN with GA-based feature selection and weighting. In phishing site prediction, the most influential features and optimal weights of website features were chosen using GA to be used for increasing prediction of the phishing websites. Correspondingly, the website features selected and weighted by GA were used to train the RNN in order to make better predictions of the phishing websites. The experimental results demonstrated that the proposed phishing websites prediction approaches based on RNN with GA-based feature selection and weighting contributed to increasing the classification performance using fewer features. Additionally, the proposed method approaches produced the highest classification accuracy of phishing websites among all other classifiers with all the feature selection methods used in this study. Thus, the proposed method approaches based on RNNs with GA-based feature selection and weighting can be used as alternative solutions to successfully predict phishing websites in order to contribute to providing more confidence for customers of online commerce and business.

*Communication and Computing (ICCC), Thiruvananthapuram, India, 2013, pp. 304–309*

3. Al-diabat, M.: 'Detection and prediction of phishing websites using classification mining techniques', *Int. J. Comput. Appl.*, 2016, 147, (5), pp. 5–11
4. Hodzic, A., Kevric, J., Karadag, A.: 'Comparison of machine learning



- techniques in phishing website classification*', 2016
5. Mohammad, R.M., Thabtah, F., McCluskey, L.: 'An assessment of features related to phishing websites using an automated technique'. *Int. Conf. for Internet Technology and Secured Transactions*, London, UK, 2012, pp. 492–497
  6. Qabajeh, I., Thabtah, F.: 'An experimental study for assessing email classification attributes using feature selection methods'. *3rd Int. Conf. on Advanced Computer Science Applications and Technologies (ACSAT)*, Amman, Jordan, 2014, pp. 125–132
  7. Yong, K.S.C., Tiong, W.K., Chiew, K.L., et al.: 'A new hybrid ensemble feature selection framework for machine learning-based phishing detection system', *Inf. Sci.*, 2019, 484, pp. 153–166
  8. Tahir, M.A.U.H., Asghar, S., Zafar, A., et al.: 'A hybrid model to detect phishing-sites using supervised learning algorithms'. *Int. Conf. on Computational Science and Computational Intelligence (CSCI)*, Las Vegas, NV, USA, 2016, pp. 1126–1133
  9. Mohammad, R.M., Thabtah, F., McCluskey, L.: 'Predicting phishing websites based on self-structuring neural networks', *Neural Comput. Appl.*, 2014, 25, (2), pp. 443–458
  10. He, M., Horng, S.J., Fan, P., et al.: 'An efficient phishing webpage detector', *Expert Syst. Appl.*, 2011, 38, (10), pp. 12018–12027
  11. Mohammad, R.M., Thabtah, F., McCluskey, L.: 'Tutorial and critical analysis of phishing websites methods', *Comput. Sci. Rev.*, 2015, 17, pp. 1–24
  12. Abdelhamid, N., Ayesah, A., Thabtah, F.: 'Phishing detection based associative classification data mining', *Expert Syst. Appl.*, 2014, 41, (13), pp. 5948–5959
  13. Nguyen, H.H., Nguyen, D.T.: 'Machine learning-based phishing web sites detection', in 'AETA 2015: recent advances in electrical engineering and related sciences (Springer International Publishing, New York, USA, 2016), pp. 123–131
  14. Ali, W.: 'Phishing website detection based on supervised machine learning with wrapper features selection', *Int. J. Adv. Comput. Sci. Appl.*, 2017, 8, (9), pp. 72–78
  15. Rao, R.S., Pais, A.R.: 'Detection of phishing websites using an efficient feature-based machine learning framework', *Neural Comput. Appl.*, 2018, pp. 1–23, DOI: 10.1007/s00521-017-3305-0
  16. Wu, J., Guo, S., Huang, H., et al.: 'Information and communications technologies for sustainable development goals: state-of-the-art, needs and perspectives', *IEEE Commun. Surv. Tutorials*, 2018, 20, (3), pp. 2389–2406
  17. Atat, R., Liu, L., Chen, H., et al.: 'Enabling cyber-physical communication in 5G cellular networks: challenges, spatial spectrum sensing, and cybersecurity', *IET Cyber-Phys. Syst., Theory Appl.*, 2017, 2, (1), pp. 49–54
  18. Atat, R., Liu, L., Wu, J., et al.: 'Big data meet cyber-physical systems: a panoramic survey', *IEEE. Access.*, 2018, 6, pp. 73603–73636
  19. Zhou, B., Li, J., Wu, J., et al.: 'Machine-learning-based online distributed denial-of-service attack detection using spark streaming'. *IEEE Int. Conf. on Communications (ICC)*, Kansas City, MO, 2018, pp. 1–6
  20. Wu, D., Li, J., Das, S.K., et al.: 'A novel distributed denial-of-service attack detection scheme for software defined networking environments'. *2018 IEEE Int. Conf. on Communications (ICC)*, Kansas City, MO, 2018, pp. 1–6
  21. Wu, J., Guo, S., Huang, H., et al.: 'Information and communications technologies for sustainable development goals: state-of-the-art, needs and perspectives', *IEEE Commun. Surv. Tutorials*, 2018, 20, (3), pp. 2389–2406
  22. Wu, J., Guo, S., Li, J., et al.: 'Big data meet green challenges: big data toward green applications', *IEEE Syst. J.*, 2016, 10, (3), pp. 888–900
  23. Wen, H., Tang, J., Wu, J., et al.: 'A cross-layer secure communication model based on discrete fractional Fourier

- transform (DFRFT)*, *IEEE Trans. Emerging Top. Comput.*, 2015, 3, (1), pp. 119–126
24. Liao, X., Yu, Y., Li, B., et al.: 'A new payload partition strategy in color image steganography', *IEEE Trans. Circuits Syst. Video Technol.*, 2019, pp. 1–14, DOI: 10.1109/TCSVT.2019.2896270
25. Liao, X., Guo, S., Yin, J.: 'New cubic reference table based image steganography', *Multimedia Tools Appl.*, 2018, 77, (8), pp. 10033–10050
26. Hasim Sak, Andrew Senior, Françoise Beaufays, Long Short-Term Memory Recurrent Neural Network Architectures for Large Scale Acoustic Modeling
27. Rahul Dey and Fathi M. Salem, Gate-Variants of Gated Recurrent Unit (GRU) Neural Networks, Department of Electrical and Computer Engineering, Michigan State University