

Identifiability of local and global features of phylogenetic networks from average distances

Jingcheng Xu^{1*} and Cécile Ané^{1,2}

^{1*}Department of Statistics, University of Wisconsin - Madison, Madison, 53706, WI, United States.

²Department of Botany, University of Wisconsin - Madison, Madison, 53706, WI, United States.

Abstract

Phylogenetic networks extend phylogenetic trees to model non-vertical inheritance, by which a lineage inherits material from multiple parents. The computational complexity of estimating phylogenetic networks from genome-wide data with likelihood-based methods limits the size of networks that can be handled. Methods based on pairwise distances could offer faster alternatives. We study here the information that average pairwise distances contain on the underlying phylogenetic network, by characterizing local and global features that can or cannot be identified. For general networks, we clarify that the root and edge lengths adjacent to reticulations are not identifiable, and then focus on the class of zipped-up semidirected networks. We provide a criterion to swap subgraphs locally, such as 3-cycles, resulting in indistinguishable networks. We propose the “distance split tree”, which can be constructed from pairwise distances, and prove that it is a refinement of the network’s tree of blobs, capturing the tree-like features of the network. For level-1 networks, this distance split tree is equal to the tree of blobs refined to separate polytomies from blobs, and we prove that the mixed representation of the network is identifiable. The information loss is localized around 4-cycles, for which the placement of the reticulation is unidentifiable. The mixed representation combines split edges for 4-cycles, regular tree and hybrid edges from the semidirected network, and edge parameters that encode all information identifiable from average pairwise distances.

Keywords: semidirected network, species network, tree of blobs, distance split tree, neighbor joining, neighbor-net

1 Introduction

Phylogenetic trees represent the past history of a set of organisms and are central to the field of evolutionary biology. Phylogenetic networks offer a convenient framework to extend phylogenetic trees, in which extra edges explicitly represent the various biological processes by which an ancestral organism or population inherits genetic material from several parents. With the advent of genome-wide data that can be collected across many organisms, there is robust evidence for hybridization and gene flow in many groups, and rooted phylogenetic networks are now widely used [1, 2].

Inferring phylogenetic networks is hard, however. Computing times are prohibitive with more than a handful of taxa for likelihood-based approaches, such as full likelihood or Bayesian methods in PhyloNet or SnappNet [3–5]. Methods based on pairwise distances have the potential to be much faster [6]. For inferring phylogenetic trees, Neighbor-Joining and other distance-based methods [7, 8] are orders of magnitude faster than likelihood-based methods and can handle data with many more taxa, even if their speed might be at the cost of accuracy [but see 9].

We study here the information carried by average pairwise distances about the underlying phylogenetic network. In other words, we ask whether phylogenetic networks are identifiable and what can be known about the network, theoretically, from distances between pairs of taxa, averaged across the trees displayed in the network. Trees and their branch lengths are identifiable from distances [10]. Trees form the simplest class of networks. How much sparseness must be imposed on networks to maintain identifiability?

Much previous work has focused on using shortest distances [11, 12], sets or multisets of distances [13–15] or the logdet distance [16]. Average distances were used for network inference but without theoretical guarantees [17]. Willson studied the identifiability of parameters from average distances when the network topology is known [18]. Other previous work has focused on the full identifiability of the network, thereby imposing strong constraints, such as a single reticulation [19, 20]. To obtain general results, we focus on the identifiability (or lack thereof) of local features and of global features, without necessarily asking for the full identifiability of the network. We also study the identifiability of branch lengths and inheritance values, often understudied in previous work.

We highlight here some of our results. Notably, we show that the root of the network is not generally identifiable from average distances. This is well-known for trees but has not been clarified by prior work on networks, which assumed data available at the root or a known outgroup [15, 19] or the network being ultrametric [e.g. 11, 14, 16, 21], or equal edge lengths (without any degree-2 nodes except perhaps for the root) [e.g. 13]. Therefore, we focus our study on semidirected networks, in which the root is suppressed and edges are undirected except for hybrid edges [3].

Without any restriction on the network complexity, we prove that we may swap a local subgraph with another without altering average distances,

provided that the swapped subgraphs have the same pairwise inheritance and distance matrices at their boundary. We apply this swap result to subgraphs with a small boundary, showing that degree-2 blobs, degree-3 blobs and 3-cycles are not identifiable; and showing that level-2 networks are not identifiable from average distances, not even generically. This result provides a simple explanation for the reticulate exceptions that are permitted in a network whose average distances fit on a tree in [20]. We anticipate that the application of our swap lemma will lead to other applications, using larger subgraphs, finding local structures that prevent the identifiability of the network from average distances.

For the global structure of the network, we prove that a refinement of the network’s tree of blobs is identifiable (under mild assumptions) which we call the “distance split tree”. Informally, any cycle in the network is condensed into a single node of the tree of blobs, which encodes the tree-like parts of the network. While the tree of blobs provides limited knowledge about the network, it could be leveraged to develop divide-and-conquer approaches. Namely, once a blob is identified from the tree of blobs using average distances, accurate estimation methods could be applied to a subset of taxa that cover a given blob, that may be computationally feasible on the subsample. Combining different types of methods to estimate different features of the networks (such as the global tree of blobs and small subnetworks) may lead to efficient strategies for accurate and computationally efficient network estimation methods.

Beyond the topology, we prove that only one composite parameter can be identified from average distances, out of the lengths of all the parent edges and the child edge adjacent to a hybrid node. This means that average distances lose extra “degrees of freedom” compared to information from displayed trees, for example, because “sliding” a reticulation along two parent edges affects edge lengths in displayed trees [22] and affects distance sets [14], but does not affect average distances. We show that the “zipped up” version of a network, in which all hybrid edges have length 0, does not depend on the order in which reticulations are zipped up. Prior work has already constrained hybrid edges to have length 0, but arguing that this assumption is biologically motivated [19]. The zipped up network can be thought of as a canonical version to be inferred by estimation methods. Such methods will need to communicate to users that hybrid edge lengths are not *assumed* to be 0 —because many biological scenarios can lead to positive lengths on hybrid edges, but are instead *constrained* to be 0 (or solely influenced by a prior distribution) because they lack identifiability from average distances. Future work could consider interactive visualizations that allow users to zip and slide each reticulation, to explore the full equivalence class of networks represented by their zipped-up version.

Finally, we study level-1 networks, in which distinct cycles don’t share nodes and each blob is a single cycle. The topology of level-1 networks has been shown to be identifiable (up to some aspects of small cycles) from quartet concordance factors [23], logdet distances [16] or some Markov models [24]. We show here that, if internal tree edges have positive lengths (which can be

achieved by creating potential polytomies), level-1 networks are identifiable from average distances, except for local features around small cycles. Namely, neither the direction of hybrid edges within 4-cycles, nor the parameters (length and inheritance) of edges in and adjacent to 4-cycles are identifiable. We introduce the “mixed representation” of a level-1 network in which 4-cycles are represented by split subgraphs, whose parallel edges are split edges, with identical edge lengths and no inheritance values. These mixed networks formalize the class of network topologies used in [23, 25] and in [16]. We show that the mixed representation of a level-1 network is identifiable from average distances, including its edge parameters. Here again, future work on interactive visualizations could let users re-assign a hybrid node within a 4-cycle, to help explore the class of phylogenetic networks with a given mixed representation.

We conjecture that the tree of blobs is identifiable from many other data types, such as distance sets (multiple distances for each pair of taxa), the logdet distance and other distances. It would be interesting to characterize the general properties that a distance function needs to satisfy, for the distance split tree derived from this distance to identify a relevant refinement of the network’s tree of blobs. Given the complexity of inferring phylogenetic networks, we hope that our study of global and local features of the network will spur the development of new divide-and-conquer approaches.

Notations, main results and implications are presented in section 2. The proofs and more formal definitions are presented in section 3 for non-identifiable features, section 4 for the identifiability of the tree of blobs, section 5 for the study of sunlets, and section 6 for level-1 networks. More technical proofs are in the appendix.

2 Notation and main results

2.1 Phylogenetic networks

We use standard definitions for graphs and phylogenetic networks as in [26], with slight modifications, and notations mostly following [23].

Definition 1 (rooted network) *A topological rooted phylogenetic network* (“rooted network” for short) on taxon set X is a tuple (N^+, f) . N^+ is a rooted directed acyclic graph with vertices $V = \{r\} \sqcup V_L \sqcup V_H \sqcup V_T$ and $f : X \rightarrow V_L$ a labelling function, where

- $r = \rho(N^+)$ is the root, the unique vertex in N^+ with in-degree 0;
- V_L are the leaves (or “tips”), the vertices with out-degree 0. We also require that leaves all have in-degree 1;
- V_T are the tree nodes, the vertices with in-degree 1 that are not leaves;
- V_H are the hybrid nodes, the vertices with in-degree larger than 1;
- f is a bijection between X and V_L .

An edge (a, b) is a *tree edge* if its child b is a tree node or a leaf node, and a *hybrid edge* otherwise. We denote the set of tree edges by E_T , and the set of hybrid edges by

E_H . We will also write ab for the edge (a, b) when no confusion is likely. A *polytomy* is a non-root node of degree 4 or higher, or the root r if r is of degree 3 or higher. An *internal edge* is an edge that is not incident to a leaf. A *partner edge* of a hybrid edge e is a hybrid edge $\tilde{e} \neq e$ having the same child as e .

Definition 1 differs from [26] in that we allow for degree-2 nodes in a network, and also require the leaves to have in-degree exactly 1. The reason for this requirement is technical: when a leaf is incident to a pendant edge, it forms a standalone “blob”, which is defined later. When no confusion is likely, we refer to the rooted network (N^+, f) as N^+ . Note that parallel edges are allowed.

For two nodes a, b in a rooted network N^+ , we write $a \leq b$ and say that a is *above* b if there is a directed path from a to b . We write $a < b$ if $a \leq b$ and $a \neq b$. For a set of nodes W in a rooted network N^+ , let D be the set of nodes that lie on all paths from the root to the elements of W . The greatest element of D (i.e. the node $s \in D$ such that $s \geq t$ for all $t \in D$) is called the *lowest stable ancestor* of W , or $\text{LSA}(W)$ [26, p.263].

As in the case with phylogenetic trees, we can unroot a rooted phylogenetic network to obtain a *semidirected phylogenetic network*, or “semidirected network” for short (see Fig. 1).

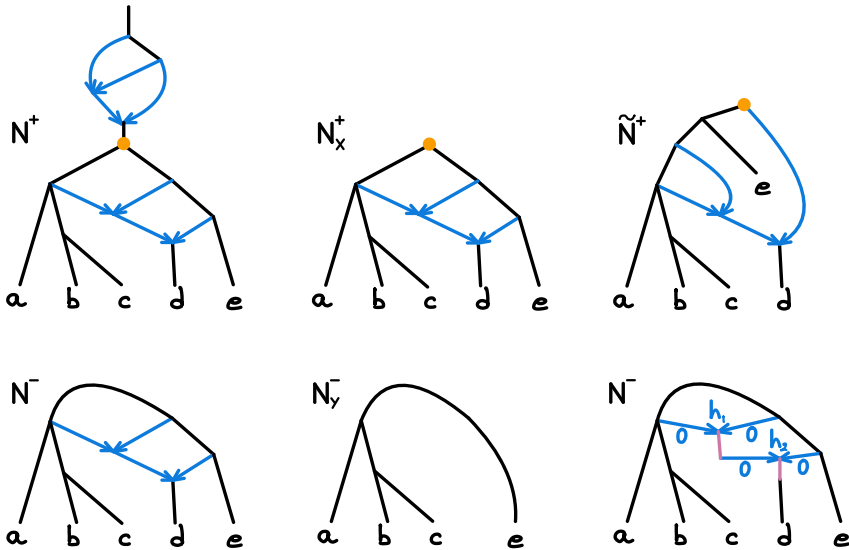

Fig. 1: Example rooted network N^+ on $X = \{a, b, c, d, e\}$; LSA network N_x^+ ; semidirected network N^- , subnetwork N_y^- on $Y = \{a, b, c, e\}$; network \tilde{N}^+ obtained by rerooting N^- (on one of the hybrid edges); and a display of N^- illustrating the modification of edge lengths to zip-up N^- . Hybrid edges are in blue with arrows. Lowest common ancestor nodes are large (orange) dots.

Definition 2 (semidirected network) A *semidirected graph* $G^- = (V, E)$ is a tuple where V is the set of nodes, and $E = E_D \sqcup E_U$ with a set E_D of *directed edges* and a set E_U of *undirected edges*. E_D consists of ordered pairs (a, b) where $a, b \in V$. In contrast, E_U consists of unordered pairs $\{a, b\}$, such that if $\{a, b\} \in E_U$, then $(a, b) \notin E_D$, i.e. an edge cannot be both directed and undirected.

Let (N^+, f) be a rooted network on X . The *topological semidirected phylogenetic network induced from* (N^+, f) is a tuple (N^-, f) , where N^- is the semidirected graph obtained by:

1. removing all the edges and nodes above $\text{LSA}(X)$;
2. undirecting all tree edges $e \in E_T$, but keeping the direction of hybrid edges;
3. suppressing $s = \text{LSA}(X)$ if it has degree 2: if s is incident to two tree edges, then remove s and replace the two edges with a single tree edge; if s is incident to one tree edge and one hybrid edge, then remove s , and replace the two edges by a hybrid edge with the same direction as the original hybrid edge. (Note that s may not be incident to two hybrid edges if it has degree 2 by Lemma 1 in [23]).

For a semidirected graph M^- with vertex set V and labelling function $g : X \rightarrow V$, (M^-, g) is a *topological semidirected phylogenetic network* if it is the semidirected network induced from some rooted network.

Remark An alternate definition may consider skipping step 1, that is, retain nodes and edges above the lowest stable ancestor, for a more general class of semi-directed networks. We consider step 1 because the subgraph above the LSA is not identifiable from pairwise distances. Other authors make assumptions that are similar to performing step 1, such as assuming the network is “proper” (every cut-edge and cut-vertex induces a non-trivial split of X [27, 28], or “recoverable”, i.e. $\text{LSA}(N) = \rho(N)$ [29])

For a semidirected network N^- induced from N^+ , the sets V_L , V_H and V_T are still well defined: $V_L(N^-) = V_L(N^+)$ is the set of nodes with degree 1, thanks to our requirement that leaves must be of degree 1 in a rooted network, and because a root of degree-1 would be above the $\text{LSA}(X)$ in the rooted network. Hybrid nodes $V_H(N^-) = V_H(N^+)$ remain well-defined in a semidirected network, because hybrid edges are directed and point to hybrid nodes. $V_T(N^-)$ is the set of all the other nodes, and may include the original root. The notion of child (node or edge) is also well defined for hybrid nodes in semidirected networks. Indeed, the child edges of a hybrid node are all the incident tree edges and outgoing hybrid edges. Consequently, the notion of *tree-child* network [26] also carries over.

For a rooted network N^+ on X , the *LSA network* N_X^+ of N is the rooted network obtained from N^+ by removing everything above $\text{LSA}(X)$ in N [23]. If N has the property that $\rho(N) = \text{LSA}(X)$, then we call N an *LSA network*. One immediate consequence of these definitions is that the semidirected network induced from N^+ and N_X^+ are the same. Furthermore, every semidirected network can be induced from an LSA network.

The *unrooted* graph $U(N)$ induced from a directed or semidirected graph N is the undirected graph obtained from N by undirecting all edges in N .

Because rooted networks are DAGs, there cannot be directed cycles in rooted or semidirected networks. A *cycle* in a rooted or semidirected network N is defined to be a subgraph C of N , such that $U(C)$ is a cycle.

One may also consider *rerooting* a semidirected network N^- : either at a node or on an edge [30]. Specifically, *rerooting at node s* refers to designating a node s in N^- as root and directing all undirected (tree) edges away from s , if this leads to a valid rooted network. *Rerooting on edge uv* refers to adding a new node s , replacing uv by two edges us and sv , and finally rerooting at node s . It follows from Definition 2 for semidirected network N^- that there exists either a node u or an edge e such that rerooting at u or rerooting on e gives an LSA network N which induces N^- : we can reroot at $\text{LSA}(X)$ if it is not suppressed, or otherwise reroot at the edge e where $\text{LSA}(X)$ is suppressed. Note that while there is always a rerooting of N^- that gives a rooted LSA network, not all rerootings give an LSA network.

Because this work focuses on semidirected networks, in the later sections for notational convenience we will usually denote a semidirected network without the superscript, i.e. N instead of N^- , and use N^+ for an LSA network that induces N , which is obtained from rerooting at a node or on an edge.

A rooted network is *binary* if its root has degree 2 and all the other nodes, except for leaves, have degree 3. A semidirected network is *binary* if all its nodes, except for leaves, have degree 3. The semidirected network induced by a binary rooted network N^+ is binary. On topological phylogenetic networks, we can further assign edge lengths and hybridization parameters, also called inheritance probabilities, to obtain *metric phylogenetic networks*.

Definition 3 (metric) A metric on a rooted or semidirected network N is a pair of functions (ℓ, γ) , with $\ell : E \rightarrow \mathbb{R}_{\geq 0}$ assigning lengths to edges, and $\gamma : E_H \rightarrow (0, 1)$ assigning hybridization parameters to hybrid edges. The hybridization parameter $\gamma(e)$ for a hybrid edge e represents the proportion of genetic material that the child inherits through the edge. As a result, we require that for a hybrid node v , $\sum_{e \in E_H(v)} \gamma(e) = 1$, where $E_H(v)$ denotes the set of incoming hybrid edges for v . We define $\gamma(e) = 1$ for any tree edge e , to extend the function $\gamma : E \rightarrow [0, 1]$ to all edges of N . A rooted/semidirected network with a metric is called a *metric rooted/semidirected network*.

In a metric semidirected network, when a node is suppressed (see step 3 in Def. 2), the length of the new edge is the sum of the original two edges. The hybridization parameter is unchanged for hybrid edges.

Two metric and/or semidirected networks are isomorphic if the (semi)directed graphs are isomorphic with an isomorphism that preserves the labelling and the metric. We regard isomorphic networks as identical, as we only identify networks and their properties up to isomorphism.

Definition 4 (blob, level, tree of blobs) A *blob* B in a rooted or semidirected network (N, f) is a subgraph of N such that $U(B)$ is a 2-edge-connected component of $U(N)$.

A blob is *trivial* if it has a single node. The *edge-level* (or simply *level*) of a blob B is the number of edges in B one needs to remove in order to obtain a tree (i.e. $|E_B| - |V_B| + 1$, where E_B, V_B are the edge set and node set of the blob B). The *level* of a network is the maximum level of all its blobs. The *tree of blobs* $BT(N)$ of a network N is an undirected graph where each vertex is a blob of N , and where two vertices B_1 and B_2 are adjacent if there is an edge b_1b_2 or b_2b_1 in N such that $b_1 \in B_1$ and $b_2 \in B_2$. The *degree of a blob* is the degree of the corresponding vertex in the tree of blobs.

Remark If N^+ is an LSA network and N^- is induced from it, then N^+ and N^- have the same blobs and the same tree of blobs, because they have the same undirected graphs.

Recall that a graph is *2-edge-connected* if the removal of one edge does not disconnect the graph. A *2-edge-connected component* is a maximal 2-edge-connected subgraph. Our definition of level follows [30] and is nonstandard in using 2-edge-connected components rather than biconnected components. A graph is *biconnected* if the removal of one vertex does not disconnect the graph. A *biconnected component* of a graph, or *block*, is a maximal biconnected subgraph. Any block of 3 or more nodes is 2-edge-connected, so each non-trivial block maps to a single blob and each blob may be formed by one or more block(s). Therefore, the traditional level based on biconnected components is lower than or equal to the level used here. However, the two definitions agree on binary networks. For binary networks, the level of a blob B is the same as the number of hybrid nodes in B [30]. If hybrid nodes may have more than two parents, the level of a blob could be greater than its number of hybrid nodes.

The “tree of blobs” was first defined by [31], using blocks and after modifying the network with edges to separate overlapping blocks. It is easy to verify that non-trivial blocks and blobs are identical after these modifications. Despite the similar name and construction, the tree of blobs is different from the “blob tree” defined in [32].

Unlike blocks, blobs partition the nodes in N and provide a convenient mapping of edges from the tree of blobs to the network, as we will show later. Fig. 2 (left) shows a non-binary network with one blob of level 2, but with two level-1 blocks. There are 3 ways to refine this network into a binary network, one of which is of level 1 with 2 blobs (Fig. 2 right), and the other two are of level 2 with a single non-trivial blob (and block). Fig. 3 shows a level-1 network with 3 blobs (left) and its tree of blobs (top right). Note that both networks on the top row have the same block-cut tree (derived from blocks and cut nodes, see [33]) after suppressing its degree-2 nodes, and both networks at the bottom have a block-cut tree reduced to a star, after suppressing degree-2 nodes.

2.2 Average distances

Definition 5 (up-down path, rooted network, from [11]) In a rooted network N^+ , an *up-down path* between two nodes u and v is a sequence of distinct nodes $u =$

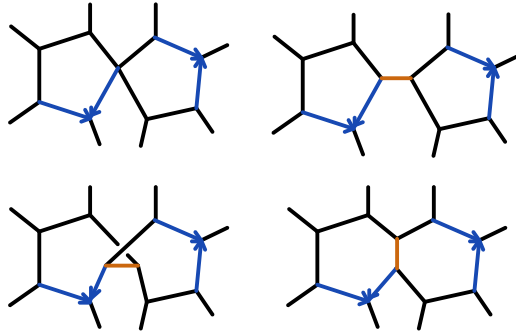

Fig. 2: Example networks and their levels. Top left: network N with 1 blob but 2 biconnected components. Hybrid edges are shown in blue with arrows. Top right: one possible resolution of N , with identical average distances if the added edge (orange, cut edge) is assigned length 0. It has 2 blobs and is of level 1. Bottom: the other 2 resolutions of N , with identical average distances if the added edge (orange) is assigned length 0. Both have 1 blob and are of level 2.

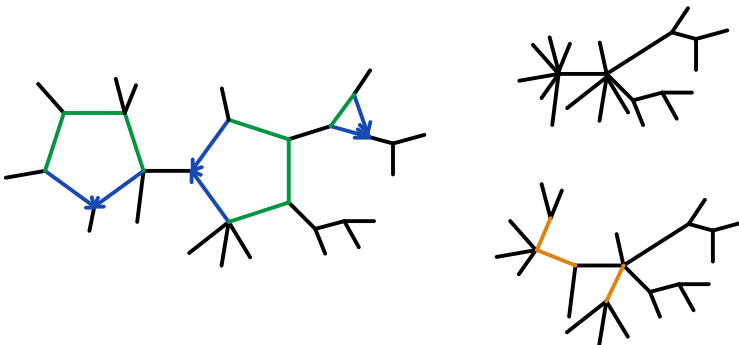

Fig. 3: Example tree of blobs. Left: level-1 network N , with leaf labels omitted to avoid clutter. Hybrid edges are shown in blue; cut edges in black. The two 5-cycles are identifiable provided that their tree (green) edges have positive length (e.g. Corollary 13). Top right: tree of blobs T for N . One of its degree-3 nodes corresponds to a degree-3 blob in N , undetectable from average distances. Bottom right: distance split tree reconstructed from average distances. It is a refinement of T (and is N 's block-cut tree after suppressing degree-2 nodes). The extra edges (orange) correspond to polytomies in N .

$u_1 u_2 \dots u_n = v$ with a special node $s = u_i$ such that $u_i \dots u_2 u_1$ and $u_i \dots u_{n-1} u_n$ are directed paths in N^+ .

If $u_1 u_2 \dots u_n$ is an up-down path, we may write $u \leftarrow s \rightarrow v$ or $u \leftrightarrow v$ as a shorthand. Particularly, a directed path between u and v is also an up-down path, and we will simply write $u \rightarrow v$ or $u \leftarrow v$, depending on the direction

of the path. Note that the up-down paths $u_1u_2 \dots u_n$ and $u_nu_{n-1} \dots u_1$ are considered to be the same. Formally, we can define up-down paths as the equivalence classes of these sequence of nodes, with reversal of the sequence being an equivalence relation.

It is not obvious whether the notion of up-down paths is still valid in semidirected networks: given an up-down path $p = u_0u_1 \dots u_n$ in a rooted network N^+ , is it possible to tell if p is an up-down path by looking at the induced semidirected network N^- alone? It turns out the answer is yes: the notion of an up-down path only has to do with the semidirected structure of a network. An alternative definition that also applies to the semidirected networks is the following:

Definition 6 (up-down path, semidirected network) Let N be a rooted or semidirected network. An *up-down path* is a path of distinct nodes with no v-structure. More formally, $u_0u_1 \dots u_n$ is an *up-down path* if the u_i 's are distinct; for each i , either u_iu_{i+1} or $u_{i+1}u_i$ is an edge in N (for a tree edge uv in semidirected network N , both uv and vu are valid edges in N); and there is no segment $u_{i-1}u_iu_{i+1}$ such that u_i is a hybrid node and $u_{i-1}u_i$ and $u_{i+1}u_i$ are hybrid (directed) edges in N . An up-down path with no hybrid nodes is a *tree path*.

This following equivalence is proved in appendix A.1.

Proposition 1 Let N^+ be a rooted network with induced semidirected network N^- . p is an up-down path in N^+ according to Definition 5 if and only if it is an up-down path according to Definition 6.

Given a metric (ℓ, γ) on a network N and a up-down path p , we can define the path length $\ell(p) = \sum_{e \in p} \ell(e)$ where e ranges over the edges in path p . We also define the path probability $\gamma(p) = \prod_{e \in p} \gamma(e)$ as the product of all the hybridization parameters of the component edges. Here we use the convention of $\gamma(e) = 1$ when e is a tree edge. $\gamma(p)$ is the probability of path p being present in a random tree extracted from N , where tree “extraction” proceeds as follows: at a hybrid node h , we pick one of h 's parent hybrid edge according to the edges' hybridization parameters, and delete all other parent edges of h . If we do this independently for all hybrid nodes, then the result is a random tree T with the same nodes as N . In T , there is a unique path between u and v , which equals p with probability exactly $\gamma(p)$.

In the special case that there is a tree path p between nodes u and v in N , then we immediately have $\gamma(p) = 1$. In fact, p must be the unique up-down path between u, v : because p does not contain any hybrid nodes, p is the unique path between u, v on any displayed tree T .

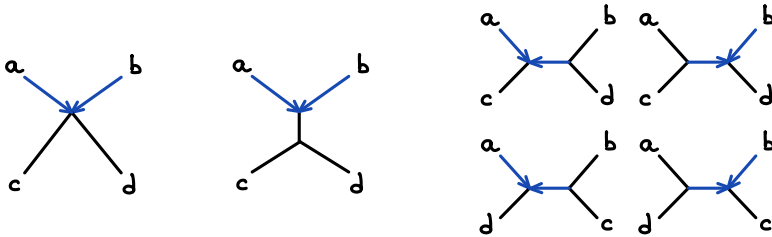

Fig. 4: A polytomy below a hybrid node (left) can be resolved by adding a new edge of length 0. The only resolution with identical up-down path lengths and average distances is by adding a new tree edge (middle). Contracting the horizontal hybrid edge in any network on the right to match the topology on the left would affect up-down paths and average distances.

Definition 7 (average distance) Let N be a rooted or semidirected network. The *average distance* between two nodes u and v in N is defined as

$$d(u, v) = \sum_{p \in P_{uv}} \gamma(p) \ell(p)$$

where P_{uv} denotes the set of up-down paths between u and v . Equivalently, this is the expected distance between u and v on a random tree T extracted from N (described above). As a result, d satisfies the triangle inequality. We may write d_N to emphasize the dependence on N .

The same definition was used for rooted networks by [18]. By considering our extended definition of up-down paths, our definition clarifies that average distances are well-defined on semidirected networks.

Remark In a network N , contracting a tree edge of length 0 creates a network \tilde{N} that has a polytomy, but whose up-down paths are in bijection with those of N and such that N and \tilde{N} have identical average distances. Consequently, a polytomy at a tree node of degree 4 has 3 distinct resolutions with identical average distances. This is not true for hybrid edges of length 0: hybrid edges may not be contracted without modifying the set of up-down paths. Moreover, if there is a polytomy at a hybrid node with 2 incoming hybrid edges and 2 other (outgoing) edges (Fig. 4 left) then there is a single resolution of this polytomy with identical set of up-down paths and identical pairwise distances: with the addition of a tree edge (Fig. 4 center). The resolutions shown in Fig. 4 (right) are not equivalent: there exist up-down paths $a \rightarrow c$, $a \rightarrow d$, $b \rightarrow c$ and $b \rightarrow d$ in the network on the left, but each network on the right is missing one of these paths.

Definition 8 (subnetwork, from [23]) Let N^- be a semidirected network on X , and $Y \subset X$. Then the induced network N_Y^- on Y is obtained by taking the union of all up-down paths in N^- between pairs of tips in Y .

If N^+ is a rooted version of N^- , then it is possible to reroot N_Y^- at $\text{LSA}(Y)$ in N^+ , which belongs in N_Y^- as shown in [23]. N_Y^- naturally inherits the metric from N^- : the distance between any pair of taxa $x, y \in Y$ is the same in N_Y^- and in N^- because the up-down paths between x, y are preserved, together with the edge lengths and hybridization parameters on these paths.

2.3 Main results

Since distances are defined on up-down paths, and up-down paths are identical on a rooted network and its induced semidirected network, it follows from Proposition 1 that average distances are independent of the root location on a rooted network, so that the root is not identifiable from average distances:

Proposition 2 *If rooted networks N_1^+ and N_2^+ induce the same semidirected network N^- , then pairwise distances on N_1^+ and N_2^+ are identical.*

What may be identifiable from average distances, at best, is the semidirected network N^- induced from N^+ , unless further assumptions are made.

Several papers have considered average distances on networks before, with different assumptions on the networks. [19] worked with binary networks and assumed the knowledge of the root, that is, the root was one of the labelled leaves and pairwise distance data was given between the root and the other leaves. [20] also worked with binary networks and assumed that hybrid edges have length 0, along with other assumptions.

The remainder of the work focuses on the following problem: Given the average distances between tips, what can we identify about the semidirected network: what topological structures, and what continuous parameters?

2.3.1 Non-identifiable features

We first cover negative results, on features that are not identifiable from average distances. The simplest such feature is the “hybrid zipper” (Fig. 5). We will show that a network is not distinguishable from its zipped-up version defined below.

Definition 9 (zipped-up network) In a network, a hybrid node is *zipped up* if all its parent edges have length 0. A network is *zipped up* if all its hybrid nodes are zipped up. If a hybrid node h is not zipped up in a network N , the version of N zipped up at h is the network obtained by modifying the edges adjacent to h as follows (we refer to this operation as a *zipping-up*):

1. If h has $k \geq 2$ children c_1, \dots, c_k and is not zipped up, add a tree node w and insert a tree edge hw of length 0 as unique child edge of h , then delete each edge hc_i and replace by wc_i with identical length (see Fig. 5).
2. Set the length of the unique child edge hw of h to

$$l_h = \ell(hw) + \sum_{u \text{ parent of } h} \gamma(uh)\ell(uh) \quad (1)$$

then set the length of all its parent hybrid edges to 0.

The *zipped-up version* of a network N is the network obtained by zipping-up N at all its unzipped hybrid nodes repeatedly.

In appendix A.2, we prove that the zipped-up version is unique. Note that a hybrid node may need to be zipped multiple times before the network is fully zipped up. In network N^- from Fig. 1 (bottom right) for example, h_2 may need to be zipped-up twice if it is considered before h_1 .



Fig. 5: Zipping up: network transformation of branch lengths, setting hybrid edge lengths to 0. The new length l_h is given in (1). In case of a polytomy below the hybrid node (right), a new tree edge of length 0 needs to be added before zipping up.

Proposition 3 (hybrid zip-up) *Let N be a semidirected network, h be a hybrid node in N with parents u_1, \dots, u_n . If h has more than one child, then step 1 in Definition 9 does not affect average distances. If h has one child w , then the average distances between the tips depend on $\ell(u_1h), \dots, \ell(u_nh), \ell(hw)$ only through l_h given by (1). Therefore, zipping up N at h does not change average distances.*

The proof is in section 3.1. This unidentifiability problem was mentioned in [22], where it is referred to as “unzipping”, as well as in [19]. It is important to note that because we use average distances instead of displayed trees in [22], we have an extra degree of freedom: As in unzipping, we can subtract an equal amount ϵ in lengths from both uh and vh , and add ϵ to hw . This leaves the average distances unchanged. What is new with average distances is that we can also “slide” the hybrid node along the v-structure, that is: subtract $(1-\gamma)\epsilon$ from uh and add $\gamma\epsilon$ to vh . This has no impact on the average distances either.

Because of the extra degree of freedom, instead of “fully unzipping” each reticulation as in [22] and working with networks where outgoing edges from hybrid nodes have length 0, we shall restrict our attention to *zipped-up* networks, which are networks where all the hybrid edges have length 0 (defined rigorously below). This requirement is also present in [18] and [19], but the non-identifiability underlying this requirement was not clarified. The requirement was motivated by the fact that hybridizing populations must be contemporary with each other. However, hybrid edges of positive length appear naturally when hybridizations involve “ghost” populations that went extinct or with no

sampled descendants, or when two populations fuse, such as if their habitat becomes less fragmented [34].

Proposition 4 (shrinking blobs of degree 2 or 3) *Let B be a blob of degree 2 or 3 in a semidirected network N . Then N' , the network obtained by shrinking B (i.e. identifying the nodes in ∂B and deleting the other nodes in B) and modifying the lengths of the cut edges adjacent to B , induces the same pairwise distances.*

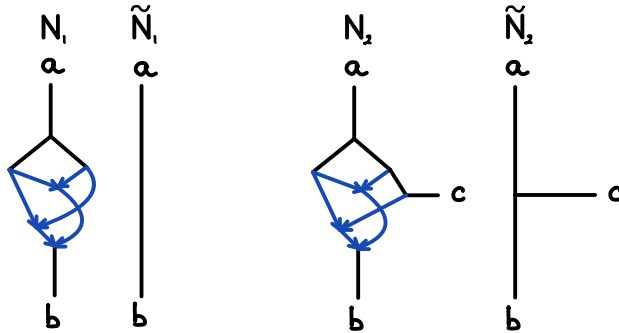

Fig. 6: Any blob of degree 2 (left) or 3 (right) can be shrunk while preserving average distances.

Section 3.2 presents a more general Lemma 15 to swap a subgraph with another within a semidirected network while keeping the average distances, from which Proposition 4 follows as a corollary. Proposition 4 is used in many proofs when considering subnetworks. If a blob reduces to a degree-2 or degree-3 blobs after subsampling leaves, then it can be ignored, up to the lengths assigned to the edges replacing the blob. A consequence of Proposition 4 is that we require networks to not have degree-2 or degree-3 blobs in many of our results. Equivalently, this requirement can be interpreted as considering networks after these blobs have been shrunk and edge lengths modified appropriately. Parallel edges may form a degree-2 blob. Even if they are part of a larger blob, they can be swapped with a single tree edge:

Proposition 5 (merging parallel edges) *In a network N , let h be a hybrid node such that all its parent edges e_1, \dots, e_n are incident to the same nodes, v and h . Consider the network N' obtained by replacing e_1, \dots, e_n by a single tree edge $e = (vh)$ of length $\sum_i \gamma(e_i)\ell(e_i)$. Then $d_N = d_{N'}$.*

This proposition, proved in section 3.2, gives a rationale for a traditional assumption that rooted phylogenetic networks do not have parallel edges [26], despite the biological realism of parallel edges. First, parallel edges can arise

from extinction or unsampled taxa: hybridization between distant species would appear as a pair of parallel edges if all the descendants of the two parental species are extinct or not sampled. Second, a species may split into 2 populations and then merge back into a single population due to evolving geographic barriers, such as glaciations. Therefore, we allowed for parallel edges in our network definition. Also, parallel edges may be identifiable from models and data other than average distances [34].

Similarly, 3-cycles are not identifiable: any 3-cycle (which may be part of a larger blob) can be shrunk to a single node with the loss of one reticulation, without affecting average distances (Fig. 7).

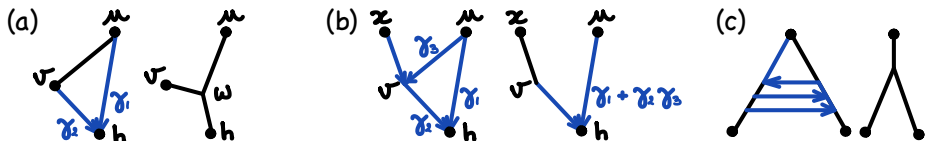

Fig. 7: Any 3-cycle can be swapped while preserving average distances. (a) A 3-cycle with a single reticulation (left) can be swapped by a subgraph without reticulation (right). (b) A 3-cycle with 2 reticulations (left) can be swapped by a single reticulation (right). See Proposition 6 for edge length adjustments. (c) A ladder of reticulations between sister lineages (left) can be eliminated (right) by repeated swaps.

Proposition 6 Let N be a semidirected network on X , h a hybrid node in N with exactly two parents u and v . Let $\gamma_1 = \gamma(uh)$ and $\gamma_2 = \gamma(vh) = 1 - \gamma_1$.

1. If uv is a tree edge (Fig. 7a), then let N' be the semidirected graph obtained by shrinking the 3-cycle u, v, h as follows: remove edges uh , vh , and uv ; add tree node w ; add tree edges uw , vw , and wh with lengths

$$\ell(uw) = \gamma_2 \ell(uv), \quad \ell(vw) = \gamma_1 \ell(uv), \quad \ell(wh) = \gamma_1 \ell(uh) + \gamma_2 \ell(vh).$$

2. If uv is a hybrid edge (Fig. 7b) and if v has exactly two parents u and x that are not adjacent, then let $\gamma_3 = \gamma(uv)$ and let N' be the semidirected graph obtained by shrinking the 3-cycle as follows: remove uv ; make the other parent edge of v a tree edge; and set

$$\begin{aligned} \gamma(uh) &= \gamma_1 + \gamma_2 \gamma_3; & \gamma(vh) &= \gamma_2 (1 - \gamma_3) \\ \ell(uh) &= (\gamma_2 \gamma_3 (\ell(uv) + \ell(vh)) + \gamma_1 \ell(uh)) / (\gamma_2 \gamma_3 + \gamma_1). \end{aligned}$$

Then N' is a semidirected network on X with one fewer reticulation than N , and N' induces the same average distances as N on X . We may also suppress the degree-2 nodes in N' , which does not affect pairwise distances.

Proposition 6 also follows from the swap lemma and is proved in section 3.2. Note that in case 2, if u and x are adjacent, then we may first shrink the 3-cycle xvu before proceeding and shrinking uvh , possibly recursively (Fig. 7c). The

lack of identifiability of 3-cycles and blobs of degree 2 or 3 explains the special cases found by [20] when characterizing networks whose average distances fit on a tree. For some classes, these networks must be trees except for some local non-tree-like structures. Namely, the class of “primitive 1-hybridization” networks was defined to allow for a short cycle near the root. When the root is suppressed, this cycle becomes a 3-cycle. Also, distances from “HGT networks” may fit a tree despite a series of gene exchange between sister species (Fig. 7c), which form a degree-3 blob. Our general characterization explains why these local structures are invisible from average distances, found by [20].

The hybrid zippers and 3-cycles are not the end of identifiability problems. Here we give an example of a level-2 network that is not identifiable (with generic parameters), showing that in general, it is not possible to identify the topology of a network with average distances, even when requiring no degree-2 or 3 blobs and zipped-up reticulations. As a result, with average distances, we can only aim to identify networks given restrictions, or identify only certain features of networks.

Theorem 7 *Let $k \geq 2$. Consider the space \mathcal{S} of zipped-up binary semidirected networks of level at most k on $n \geq 4$ taxa, with no 2- or 3-cycles. Networks in \mathcal{S} are not generically identifiable from average pairwise distances, in the sense that there exists network topologies $N_1 \neq N_2$ in \mathcal{S} and sets of parameters Ω_1 and Ω_2 with positive Lebesgue measure satisfying the following: for any $(\ell_1, \gamma_1) \in \Omega_1$, there exists $(\ell_2, \gamma_2) \in \Omega_2$ such that the average distances defined by (N_1, ℓ_1, γ_1) and (N_2, ℓ_2, γ_2) are identical.*

The proof is presented in section 5.1. In short, the main idea is to find examples on 4 taxa, and then embed these examples in larger networks for any n . Fig. 8 provides examples of topologies that can serve the role of N_1 and N_2 in Theorem 7 for $n = 4$. The network on the left is of level 1, showing that level-2 networks are not distinguishable from level-1 networks in general. Also, the network on the right is tree-child, implying that Theorem 7 also holds for the smaller class of tree-child networks of level at most k (zipped and without any 2- or 3-cycles), thus providing a stronger statement.

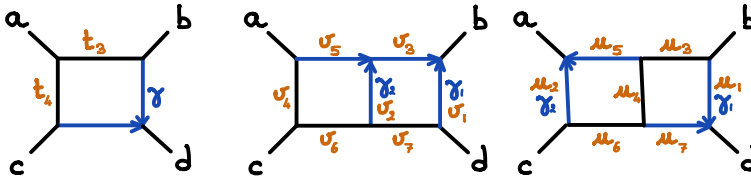

Fig. 8: Semidirected networks with identical average distances on a parameter set of positive Lebesgue measure. The network on the right is tree-child.

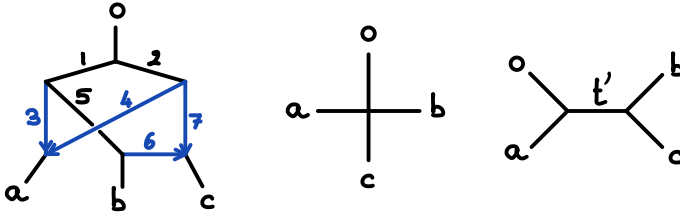

Fig. 9: Example of a binary network N of level 2 (left) whose tree of blobs is a star (middle). The distance split tree T is also a star for generic parameters. But if $\gamma_3 = t_2/(t_1 + t_2)$ and γ_7 is small, then T is a strict refinement of the tree of blobs (right). In this case, N and T have identical average distances.

2.3.2 Identifiable features

Now we move on to positive results, i.e. what we can identify of a network from average distances, subject to certain constraints.

Theorem 8 (identifying the tree of blobs) *For a semidirected network N with no degree-2 blob and no internal cut edge of length 0, a refinement of the tree of blobs can be constructed from pairwise average distances, and which we call the distance split tree.*

Theorem 8 is proved in section 4. The distance split tree is defined rigorously in section 4, Definition 12. Its construction is based on average distances alone.

Next, we provide examples showing that the tree of blobs cannot be reconstructed without further assumptions, and that the restriction of reconstructing a *refinement* is necessary. A refinement of tree T is a tree T' such that we can obtain T by contracting edges of T' .

Example 1 Consider the network N in Fig. 9 (left). Let t_i and γ_i denote edge i 's length and hybridization parameter. N is a binary network of level 2. Its tree of blobs is a star (Fig. 9 center). Its average distances are equal to those obtained from a tree (Fig. 9 right) for specific parameter values, namely when $\gamma_3 = t_2/(t_1 + t_2)$ and γ_7 is small enough, and the same topology is obtained by the distance split tree from Theorem 8. In this case, the distance split tree is a strict refinement of the tree of blobs $\text{BT}(N)$, but is an exact and parsimonious explanation of the distances. We also note that under generic parameters, the distance split tree is equal to the star tree of blobs (see section 4 for the proofs).

Example 2 Consider the networks N_1 and N_2 in Fig. 10. N_1 is not binary. It has one blob, made of two biconnected components, and its tree of blobs is a star. N_2 is a binary resolution of N_1 with two blobs: one for each block of N_1 . Since the extra cut-edge in N_2 has length 0, N_1 and N_2 have the same average distances and the same distance split tree T (Fig. 10 right). T is a strict refinement of N_1 's tree of blobs, but

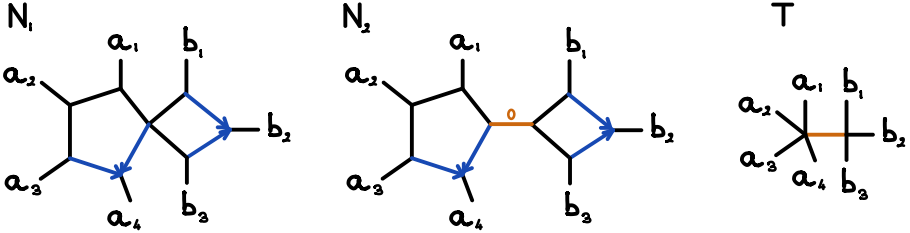

Fig. 10: Left: example of a non-binary level-2 network N_1 . Middle: N_2 is one possible resolution of N_1 . N_2 is of level 1, with an extra cut edge of length 0 (in orange). Right: tree of blobs T of N_2 . If, for example, $\ell(e) = 1$ for all edges in N_1 and $\gamma(e) = 0.5$ for all hybrid edges, then the distance split tree for N_1 is T , which is a strict refinement of N_1 's tree of blobs (a star). Note that the other resolutions of N_1 have a star as their tree of blobs.

it is the tree of blobs of N_2 : it recovers the separate blocks with the extra cut edge. In this case again, the distance split tree represents a true feature of the network.

These examples and our results on non-binary level-1 networks (below) lead us to state the following conjecture.

Conjecture 9 (distance split tree as tree of blobs of equivalent network) Let N be a metric semidirected network on taxon set X , d_N its average distances on X , and let T be the distance split tree reconstructed from d_N . Then there exists a semidirected N' of level equal or less than that of N with $d_{N'} = d_N$ and such that T is the tree of blobs of N' .

In Theorem 10 below (proved in section 4), we add assumptions to identify the tree of blobs exactly. When we limit the network to be of level 1, we characterize the distance split tree exactly: it is the tree of blobs refined by extra edges to partially resolve polytomies adjacent to blobs.

Theorem 10 Let N be a level-1 network with internal tree edges of positive length and with no degree-2 blob. Then the distance split tree of N is the tree of blobs of N^R , where N^R is the network obtained as follows. For each non-trivial blob B in N and each node u in B , let $\{a_1u, \dots, a_ku\}$ be the set of edges of u that are not in B . If $k \geq 2$, then refine the polytomy at u by creating a new node u' , adding tree edge uu' of length 0; and disconnecting each a_i from u and connecting it to u' . That is, for each $i = 1, \dots, k$, remove a_iu and create tree edge a_iu' .

Remark The assumption that internal tree edges have positive length is a weak requirement, because a tree edge of length 0 can be contracted to create a polytomy.

In the proof, we show that N^R is indeed a valid semidirected network, with identical average distances as N . The distance split tree from N^R is in fact the block-cut tree of N (see “block-cutpoint trees” [35, p.36]), after suppressing its degree-2 nodes. For example, the network in Fig. 3 (left) has a distance split tree with 2 extra edges (in orange, bottom right) compared to its tree of blobs (top right). If we further assume that the network is binary, then $N = N^R$ and the distance split tree equals the tree of blobs:

Corollary 11 *For a binary level-1 semidirected network with internal tree edges of positive length and no degree-2 blob, the tree of blobs can be constructed from average distances.*

In a binary level-1 network, each blob is a cycle and we can isolate a blob by sampling an appropriate subset of tips. On this subset, the induced subnetwork, after removing degree-2 blobs, is a “sunlet” [36], that is, a semidirected network with a single cycle and a single pendant edge attached to each node in the cycle. In section 5, we tackle the identifiability of sunlets. Some of these results are special cases of those in [19] (with a simpler proof strategy). One exception is the case of 4-sunlets, which is excluded by the assumptions in [19]: In general, the 4-sunlet and its metric (ℓ, γ) are not identifiable, but the unrooted 4-sunlet is a structure that can be detected in the tree of blobs.

In section 5, we can characterize all the 4-sunlets (and their parameters) that give rise to a given average distance matrix. Ideally one would choose a “canonical” 4-sunlet as the representative of all these distance-equivalent sunlets. However, we did not find a single sensible choice for such canonical 4-sunlet. Consequently we opt to use a separate split-network type of representation for these 4-sunlets.

Section 6 introduces *mixed networks*, in which some parts are semidirected and 4-cycles are undirected. In short, a mixed network encodes the reticulation node and edges in k -cycles for $k \geq 5$, and the unrooted topology in 4-cycles, without identification of the exact placement of the hybrid node in a 4-cycle. In section 6, we define this representation rigorously and combine results from sections 4 and 5 to prove the following main result.

Theorem 12 (identifiability of mixed network representation for level-1 networks) *Let N_1 and N_2 be level-1 semidirected networks on X with no 2 or 3-cycles or degree-2 nodes, and with internal tree edges of positive lengths. Let N_i^* be the mixed network representation of N_i after zipping up its reticulations for $i = 1, 2$. Then $d_{N_1} = d_{N_2}$ implies that $N_1^* = N_2^*$.*

Note that for a network N satisfying the conditions above and its mixed network representation N^* , N and N^* have the same unrooted topology, except that polytomies adjacent to 4-cycles in N may be partially resolved in N^* .

If we consider the space of level-1 networks with no 4-cycles, we obtain the following result as a special case.

Corollary 13 (identifiability of zipped-up version of level-1 networks) *Let N_1 and N_2 be zipped-up level-1 semidirected networks on X with tree edges of positive lengths, without any 2, 3 or 4-cycles, and without degree-2 nodes. If $d_{N_1} = d_{N_2}$ then $N_1 = N_2$.*

2.4 Biological relevance

In practice, average distances between pairs of taxa need to be estimated from data. [16] studied the identifiability of the network topology using the log-det distance, for level-1 networks and under a coalescent model. Future work could study identifiability of the network and its parameters under various models and for various methods to estimate evolutionary distances, such as the average coalescence time between pairs of taxa [37], average internode distance [38], or the f_2 statistic when many genomes are available from each species [39].

The most frequent reticulations are expected between incipient species, or sister species that just split from each other and have yet to achieve reproductive isolation. Our work shows that these most frequent reticulations are not identifiable from average distances. Only the less frequent events between more distant species can be detected using average distances.

Our work also shows a strong effect of taxon sampling, as observed with real data [40, 41]. Dense taxon sampling is critical to avoid blobs of degree 2 or 3. For example, if a hybridization forms a cycle of degree 5 in a full level-1 network, then it is necessary to sample at least one taxon from across each of the 5 cut edges adjacent to the cycle, for the reticulation to be identifiable from average distances. Conversely, it may be useful to reduce taxon sampling strategically. Reducing the degree of some blobs to be 3 or less in the subnetwork could be a strategy to obtain a more resolved tree of blobs on the reduced taxon set. When the true network is of level greater than 1, different taxon subsamples may lead to different trees of blobs, and to the detection of different reticulation events by methods that assume a level-1 network. While this sensitivity to taxon sampling may be disconcerting, subsampling can decrease the level and bring strength to methods that require low-level networks like SNaQ [3] and NANUQ [25].

Pairwise distances are not unique in causing some features to lack identifiability. From quartet concordance factors for example, some 3-cycles cannot be identified, and the hybrid node position is not always identifiable in a 4-cycle [23, 42, 43]. Software for network inference should provide information on the class of equivalent networks with identical optimal likelihood, e.g. list the multiple ways to place the reticulation in a 4-cycle. Bayesian approaches could report on sets of networks that cannot be distinguished from the data, and whose relative posterior probabilities are solely influenced by the prior. Interactive visualization tools could facilitate the exploration of networks with equivalent scores, so practitioners could avoid interpretations that hinge on a

strict subset of these networks. If software is misleadingly presenting a single network as being optimal without presenting the whole class of networks with equivalent fit, then undue confidence could be placed on some interpretation.

3 Proofs related to non-identifiable features

3.1 Hybrid zip-up

To prove Proposition 3, we first need the following definition and proposition.

Definition 10 (displayed tree) Let N be a directed or semidirected network. For hybrid node h , let $E_H(h)$ be its parent hybrid edges. Let T be the graph obtained by keeping one hybrid edge $e \in E_H(h)$ and deleting the remaining edges in $E_H(h)$, for each hybrid node h in N . Then T is a tree, and is called a *displayed tree*. The distribution on displayed trees generated by N is the distribution obtained by keeping $e \in E_H(h)$ with probability $\gamma(e)$, independently across h .

Note that T is a tree because it is a DAG (considering N as rooted), all the nodes are still reachable from the root, and all nodes have in-degree at most 1.

Proposition 14 Let N be a (directed or semidirected) network. For two nodes u and v and tree T , let $q_{uv}(T)$ be the unique path between u and v in T . Then, for a given up-down path p between u and v in N ,

$$\mathbb{P}(q_{uv}(T) = p) = \gamma(p)$$

where the probability is taken over a random tree T displayed in N . As a result,

$$d(u, v) = \mathbb{E}\ell(q_{uv}(T))$$

where $d(u, v)$ is the distance between u, v , and $\ell(q)$ is the length of path q .

Proof Since rooting a semidirected network does not change the process of generating displayed trees, nor up-down paths in the network, it suffices to consider the case when N is a directed network. Let p be an up-down path in N . Let $E = \{e_1, \dots, e_n\}$ be the set of hybrid edges in p , and let $H = \{h_1, \dots, h_n\}$ where h_i is the child of e_i . All the h_i 's are distinct hybrid nodes because the up-down path p may not go through partner hybrid edges (no v-structure). It suffices to show that $p = q_{uv}(T)$ if and only if for each $h_i \in H$, e_i is kept.

The ‘‘only if’’ part is evident since e_i has to be in T for p to be in T . Now consider a displayed tree S where for all $h_i \in H$, e_i is kept. Because all of the edges of p are in S , p is a path between u and v in S ; and since S is a tree, p is the unique path between u and v in S . \square

Proof of Proposition 3 (hybrid zip-up) If h has more than one child, then step 1 in Definition 9 does not modify the set of up-down paths, other than inserting hw to the paths containing $u_i h, h c_j$ for some parent u_i and child c_j of h . Since the length of hw is set to 0, step 1 does not change the length of up-down paths, nor average

distances. If h has a single child w , we first assume that h is the only hybrid node in N . Let $a_i = \ell(u_i h)$ and $\gamma_i = \gamma(u_i h)$ for $i = 1, \dots, n$ and let $t = \ell(hw)$. Let x, y be two tips of N . There are two cases:

1. If some up-down path p between x, y does not contain h , then p must be the unique up-down path between x and y . This is because p is a path on the n displayed trees of N . Consequently the distance between x and y does not depend on a_1, \dots, a_n or t , and the statement is vacuously true.
2. If all up-down paths between x, y contain h , then there are exactly n up-down paths q_i , with q_i containing the edge $u_i h$. In this case the average distance is

$$d(x, y) = \sum_{i=1}^n \gamma_i (a_i + l_i + t) = l_h + \sum_{i=1}^n \gamma_i l_i,$$

where $l_i = \sum_{e \in q_i, e \notin \{u_i h, \dots, u_n h, hw\}} \ell(e)$ does not depend on (a_1, \dots, a_n, t) .

For the general case, we use Proposition 14. Let T be a random displayed tree in N and $D_{xy} = D_{xy}(T)$ be the distance between x and y in T (a random quantity). Let R be the set of hybrid edges kept in T at all hybrid nodes except for h . By conditioning on R , we reduce the problem to a network with a single reticulation: $\mathbb{E}[D_{xy} \mid R]$ is the average distance on a (random) network with a single reticulation at h . By the above argument, $\mathbb{E}[D_{xy} \mid R]$ only depend on (a_1, \dots, a_n, t) through l_h . Taking expectation again gives the result. \square

3.2 Swap lemma and related results

In this section we present a general swap lemma and apply it to prove the non-identifiability of specific features. We first introduce some necessary definitions and notations.

Let A be a subgraph of a semidirected network N on X . A is *hybrid closed* if for any hybrid edge in A , all of its partner edges are in A . We use ∂A to denote the *boundary* of A in N , defined as the set of nodes in A that are either leaves, or are incident to an edge not in A . For two nodes $a, b \in \partial A$, we define

$$\gamma_A(a, b) = \sum_{p: a \leftrightarrow b \text{ in } A} \gamma(p),$$

where p ranges over the set of up-down paths from a to b that lie entirely in A . Then we define the *conditional distance in A* as

$$d(a, b \mid A) = \begin{cases} \frac{1}{\gamma_A(a, b)} \sum_{p: a \leftrightarrow b \text{ in } A} \gamma(p) \ell(p) & \text{if } \gamma_A(a, b) > 0 \\ 0 & \text{if } \gamma_A(a, b) = 0 \end{cases}$$

where in the sum p again ranges over up-down paths between a, b that lie in A . The following lemma says that average distances are unchanged if we swap A with another subgraph of identical boundary, provided that γ_A and $d(\cdot, \cdot \mid A)$ are preserved on ∂A .

Lemma 15 (subgraph swap) *Let N_1 and N_2 be metric semidirected networks on the same leaf set X , with node sets $V(N_i) = V_{A_i} \sqcup V_B$ and edge set $E(N_i) = E_{A_i} \sqcup E_B$ for $i = 1, 2$, such that A_1 and A_2 are hybrid-closed subgraphs with identical boundary in N_1 and N_2 respectively: $\partial A_1 = \partial A_2$, denoted as ∂A . If $\gamma_{A_1}(a, b) = \gamma_{A_2}(a, b)$ and $d_{N_1}(a, b \mid A_1) = d_{N_2}(a, b \mid A_2)$ for every $a, b \in \partial A$, then $d_{N_1} = d_{N_2}$ on X .*

Proof Given an up-down path p and two nodes a, b on the path, we write $a \xleftrightarrow{p} b$ for the segment of p between a, b , which is an up-down path as well.

We first prove the lemma when there are no hybrid edges in E_B . For now we consider the distances in N_1 . To simplify notations, we shall write $N = N_1$ and $A = A_1$. Let $x, y \in X$ be two tips, and p an up-down path between them. Then p can be subdivided into segments that consists of consecutive edges in E_B , and segments of consecutive edges in E_A , the set of edges in A . Traversing p from x to y , let the j th segment in E_A be $a_j \xleftrightarrow{p} a'_j$, where $a_j, a'_j \in \partial A$. Note $a_1 = x$ and $a'_k = y$ are possible for some k , if x or y is in A . Given a $2k$ -tuple $\mathbf{a} = (a_1, a'_1, \dots, a_k, a'_k) \in \partial A^{2k}$, let $\mathcal{P}_k(\mathbf{a})$ denote the set of up-down paths p between x and y with exactly k segments in A , and such that segment j enters and exits A at a_j, a'_j : $a_j \xleftrightarrow{p} a'_j$. The set of up-down paths between x and y can then be written as

$$\bigsqcup_{k \geq 0} \bigsqcup_{\mathbf{a} \in \partial A^{2k}} \mathcal{P}_k(\mathbf{a}).$$

Consequently, we have

$$d(x, y) = \sum_{k \geq 0} \sum_{\mathbf{a} \in \partial A^{2k}} \sum_{p \in \mathcal{P}_k(\mathbf{a})} \gamma(p) \ell(p) \quad (2)$$

For a given $\mathbf{a} \in \partial A^{2k}$ and $p \in \mathcal{P}_k(\mathbf{a})$, consider the segments in E_B , which are the segments $a'_j \xleftrightarrow{p} a_{j+1}$, $j = 1, \dots, k-1$ and possibly also $x \xleftrightarrow{p} a_1$ or $a'_k \xleftrightarrow{p} y$ when x or y is in V_B . These segments are uniquely determined by k and \mathbf{a} because we assumed no hybrid edges in E_B . There are no undirected cycles in the subgraph formed by nodes $V_B \cup \partial A$ and edges E_B , so for a given $a'_j, a_{j+1} \in \partial A$, there is either no path or a single (tree) path $a'_j \leftrightarrow a_{j+1}$ in E_B . Let $E_B(k, \mathbf{a})$ be the set of edges $e \in E_B$ such that $e \in p$ for any (and every) $p \in \mathcal{P}_k(\mathbf{a})$.

The segments of an up-down paths must be up-down paths. Conversely, the concatenation of contiguous up-down paths alternating from E_A and E_B is still an up-down path, because E_B contains tree edges only. Therefore, if $E_B(k, \mathbf{a})$ is non-empty or not needed ($k = 1$ and $x, y \in \partial A$), then $\mathcal{P}_k(\mathbf{a})$ is non-empty and there is a bijection between $\mathcal{P}_k(\mathbf{a})$ and $\prod_{j=1}^k \mathcal{P}_1((a_j, a'_j))$: each $p \in \mathcal{P}_k(\mathbf{a})$ is mapped to the segments in E_A , with interleaving segments $E_B(k, \mathbf{a})$. Consequently, if $\mathcal{P}_k(\mathbf{a})$ is not empty then we have

$$\begin{aligned} \sum_{p \in \mathcal{P}_k(\mathbf{a})} \gamma(p) &= \sum_{p \in \mathcal{P}_k(\mathbf{a})} \prod_{i=1}^k \gamma(a_i \xleftrightarrow{p} a'_i) = \sum_{p_1 \in \mathcal{P}(a_1, a'_1)} \cdots \sum_{p_k \in \mathcal{P}(a_k, a'_k)} \prod_{i=1}^k \gamma(p_i) \\ &= \prod_{i=1}^k \gamma_A(a_i, a'_i). \end{aligned}$$

For the first summation in (2), we may then write

$$\begin{aligned}
 \sum_{p \in \mathcal{P}_k(\mathbf{a})} \gamma(p) \ell(p) &= \sum_{p \in \mathcal{P}_k(\mathbf{a})} \left(\prod_{i=1}^k \gamma(a_i \xrightarrow{p} a'_i) \right) \left(\sum_{e \in E_B(k, \mathbf{a})} \ell(e) + \sum_{i=1}^k \ell(a_i \xrightarrow{p} a'_i) \right) \\
 &= \prod_{i=1}^k \gamma_A(a_i, a'_i) \left(\sum_{e \in E_B(k, \mathbf{a})} \ell(e) \right) + \\
 &\quad \sum_{p \in \mathcal{P}_k(\mathbf{a})} \sum_{i=1}^k \left(\prod_{j \neq i} \gamma(a_j \xrightarrow{p} a'_j) \right) \gamma(a_i \xrightarrow{p} a'_i) \ell(a_i \xrightarrow{p} a'_i) \\
 &= \prod_{i=1}^k \gamma_A(a_i, a'_i) \left(\sum_{e \in E_B(k, \mathbf{a})} \ell(e) \right) + \sum_{i=1}^k d(a_i, a'_i | A) \prod_{i=1}^k \gamma_A(a_i, a'_i) \\
 &= \prod_{i=1}^k \gamma_A(a_i, a'_i) \left(\sum_{e \in E_B(k, \mathbf{a})} \ell(e) + \sum_{i=1}^k d(a_i, a'_i | A) \right). \tag{3}
 \end{aligned}$$

From (3), it follows that as long as $d(\cdot, \cdot | A)$ and γ_A remain the same on ∂A , then $d(x, y)$ does not change.

The general case follows by first conditioning on a choice of hybrid edges in E_B (which must be hybrid closed because A_1 is) and then using Proposition 14. \square

Proof of Proposition 4 The non-identifiability of blobs of degree 2 or 3 follows as an immediate corollary of Lemma 15: If A is a blob of degree 2 or 3, then ∂A has 2 or 3 nodes, and $\gamma_A \equiv 1$ (Fig. 6). Since any metric on a set of 2 or 3 elements can be represented by a tree metric, we may replace A by one tree edge or by three tree edges, to match $d(\cdot, \cdot | A)$ exactly. Specifically, using Fig. 6, on the left the degree-2 blob can be swapped by a single edge (a, b) in \tilde{N}_1 of length set to $d_{N_1}(a, b)$. On the right, a degree-3 blob can be swapped by a single tree node. Edge lengths in \tilde{N}_2 are determined by the average distances between a, b, c in N_2 . For example, the length of the edge to a is $(d_{N_2}(a, b) + d_{N_2}(a, c) - d_{N_2}(b, c))/2 \geq 0$. \square

Proof of Proposition 5 The subgraph A_1 induced by $\{v, h\}$ contains the parallel edges e_1, \dots, e_n exactly, has $\partial A_1 = \{v, h\}$ and is hybrid closed because all parent edges of h are assumed to be parallel. A_2 is the subgraph on $\partial A_2 = \{v, h\}$ with a single tree edge $e = (vh)$. Trivially, $\gamma_{A_1}(v, h) = 1 = \gamma_{A_2}(v, h)$, and the length of e was defined to ensure that $d_N(v, h | A_1) = d_{N'}(v, h | A_2)$. \square

Proof of Proposition 6 We consider here a subgraph that contains a triangle, and swap it with a simpler subgraph in which the triangle is shrunk. First note that N' is a valid semidirected network, because the swapping operation can be made on a rooted network to obtain a valid rooted network (with the same root). In case 1 we apply Lemma 15 to swap the subgraph A_1 induced by $\{u, v, h\}$ on the left of Fig. 7(a), with A_2 induced by $\{u, v, h, w\}$ on the right. A_1 is hybrid closed in N and A_2 is hybrid closed in N' ; $\partial A = \partial A_1 = \partial A_2 = \{u, v, h\}$ and $\gamma_{A_1} \equiv \gamma_{A_2} \equiv 1$ on ∂A . The branch lengths in Proposition 6 ensure that $d_N(\cdot, \cdot | A_1) \equiv d_{N'}(\cdot, \cdot | A_2)$ on ∂A .

In case 2, let x be the parent node of v other than u . We apply Lemma 15 to swap A_1 with A_2 in Fig. 7(b), with $V(A_1) = V(A_2) = \{u, v, h, x\}$. A_1 and A_2 are hybrid closed in N and in N' , both with boundary $\partial A = \{x, u, h\}$. In N and N' , we have $\gamma_A(x, u) = 0$, $\gamma_A(x, h) = \gamma_2(1 - \gamma_3)$ and $\gamma_A(u, h) = \gamma_1 + \gamma_2\gamma_3$. The branch lengths in Proposition 6 ensure that $d_N(\cdot, \cdot | A_1) \equiv d_{N'}(\cdot, \cdot | A_2)$ on ∂A . \square

4 Identifying the tree of blobs

In this section, we prove Theorems 8 and 10. The key arguments are as follows. First, edges in the tree of blobs $BT(N)$ define the same splits of leaves as cut-edges in N . Second, pairwise distances satisfy the “4-point condition” for any set of four taxa that spans one of these cut-edge splits. These terms and statements are made rigorous below.

Proposition 16 *For a semidirected network N , there is a bijection between the edges of $BT(N)$ and the cut edges of N , and a bijection between the leaves of $BT(N)$ and the tips of N .*

The proof is in appendix A.3 since it is simply technical. Recall that a *split* $A | B$ of a set X is a partition of X into two disjoint nonempty subsets A and B . For a phylogenetic X -tree T and an edge e of T , the split $\sigma(e)$ induced by e is the partition on X induced from the two connected components of T when e is removed. We denote the set of edge-induced splits of a phylogenetic X -tree by $\Sigma(T)$. Two splits $A | B$ and $C | D$ of X are *compatible* if at least one of $A \cap C$, $A \cap D$, $B \cap C$, and $B \cap D$ is empty. By the Splits-Equivalence theorem [10], all the splits in $\Sigma(T)$ are compatible. Furthermore, two sets of splits Σ_1 and Σ_2 are *pairwise compatible* if for all $\sigma_1 \in \Sigma_1, \sigma_2 \in \Sigma_2$, σ_1 and σ_2 are compatible. A single split σ and a set of splits Σ are pairwise compatible if $\{\sigma\}$ and Σ are pairwise compatible.

If N has no degree-2 blob, then its tree of blobs T can be viewed as a phylogenetic X -tree. Different cut-edges in N , and therefore different edges in T , correspond to different splits $A | B$ in X .

Definition 11 (4-point condition) Given a metric d on X , the tuple (x, y, u, v) of leaves in X satisfies the *4-point condition* if

$$d(x, y) + d(u, v) \leq d(x, u) + d(y, v) = d(x, v) + d(y, u). \quad (4)$$

Because (4) is the same if we switch x, y or u, v , we can define the above condition as the 4-point condition on the quartet $xy | uv$ (short for $\{x, y\} | \{u, v\}$). We also say the 4-point condition is satisfied for $\{x, y, u, v\}$ if it holds for some permutation of (x, y, u, v) . We say that $xy | uv$ satisfies the 4-point condition *strictly* if the inequality in (4) is strict.

A split $A | B$ on X is said to satisfy the 4-point condition (strictly) if for any $x, y \in A$ and $u, v \in B$, the 4-point condition on $xy | uv$ is satisfied (strictly).

On a tree, the 4-point condition is satisfied for any choice of four nodes. In the example below, the 4-point condition is not satisfied.

Example 3 (4-point condition on a 4-cycle) Let N be the leftmost network in Figure 8 with $t_3 > 0$ and $t_4 > 0$. A quick calculation shows that $d(a, d) + d(b, c) - d(a, c) - d(b, d) = 2\gamma t_3 > 0$ and $d(a, d) + d(b, c) - d(a, b) - d(c, d) = 2(1 - \gamma)t_4 > 0$. Therefore the 4-point condition is not satisfied on the tips $\{a, b, c, d\}$.

Lemma 17 *Let N be a semidirected network and T its tree of blobs. All splits $\sigma \in \Sigma(T)$ satisfy the 4-point condition for d_N , and $\sigma(e)$ satisfies the 4-point condition strictly if $\ell(e) > 0$. Furthermore, if all internal cut-edges in N have positive length, then any split σ' on X that satisfies the 4-point condition is pairwise compatible with $\Sigma(T)$.*

Proof As in the previous discussion, we identify edge e in T with the corresponding cut edge in N .

Let $\sigma = \sigma(e) = A \mid B$. Take $a, b \in A$, $u, v \in B$. Since e is a cut edge in N , removing e results in two connected components, such that a, b are in the same component and u, v are in the other. Let c, w be the vertices of edge e , with c in the same connected component as a, b , and w in the same one as u, v .

Let $D(p, q)$ be the random up-path length between nodes p and q , that is, the length of the up-down path between p and q induced by a randomly sampled displayed tree. Since all up-down paths from a to u must contain e , we have

$$D(a, u) = D(a, c) + \ell(e) + D(w, u).$$

Taking expectations,

$$d(a, u) = d(a, c) + \ell(e) + d(w, u).$$

Similar equations hold for the pairs (a, v) , (b, u) , and (b, v) , from which we get

$$\begin{aligned} d(a, b) + d(u, v) &\leq d(a, c) + d(b, c) + d(w, u) + d(w, v) \\ &= d(a, u) + d(b, v) - 2\ell(e) = d(a, v) + d(b, u) - 2\ell(e). \end{aligned}$$

Hence $A \mid B$ satisfies the 4-point condition, strictly if $\ell(e) > 0$.

To prove the second claim, assume that there exists a split $\sigma' = U \mid V$ satisfying the 4-point condition, but that is not compatible with a split $\sigma = A \mid B$ induced by some edge e in T . Since σ is nontrivial, e is an internal edge and $\ell(e) > 0$. Then we can find a, b, u, v such that $a, b \in A$, $u, v \in B$, and $a, u \in U$, $b, v \in V$. Consequently the 4-point condition holds both on $ab \mid uv$ and $au \mid bv$. It then follows that the three sums $d(a, b) + d(u, v)$, $d(a, u) + d(b, v)$ and $d(a, v) + d(b, u)$ are all equal. Then the 4-point condition on $ab \mid uv$ cannot be strict, implying $\ell(e) = 0$: a contradiction. \square

Definition 12 (distance split tree) Let d be a metric on X . Let $\Sigma(d)$ be the set of splits on X that satisfy the 4-point condition, and $\Sigma'(d)$ the set of splits in $\Sigma(d)$ that are pairwise compatible with $\Sigma(d)$. Note that by construction, $\Sigma'(d)$ is pairwise compatible. The *distance split tree* is defined as the X -tree $\tau(d)$ that induces $\Sigma'(d)$.

By the splits-equivalence theorem, $\tau(d)$ exists and is unique. Also, $\tau(d_T) = T$ if T is a tree [10].

Proof of Theorem 8 Let N be a semidirected network on X satisfying the requirements in Theorem 8 and $d = d_N$. For a tree T , let Σ_T the set of splits induced by T . Using the notations in Definition 12, we have

$$\Sigma_{\text{BT}(N)} \subset \Sigma_{\tau(d)} = \Sigma'(d) \subset \Sigma(d).$$

Because $\Sigma_{\text{BT}(N)} \subset \Sigma_{\tau(d)}$, $\tau(d)$ is a refinement of $\text{BT}(N)$. \square

Proof of Example 1 For the network N in Fig. 9 (left), we prove here that the distance split tree $\tau(d_N)$ is a star for generic parameters, and is the tree $oa \mid bc$ when $\gamma_3 = t_2/(t_1 + t_2)$ for γ_7 small enough. It is easy to write the expressions

$$\begin{aligned} S_a &= d(o, a) + d(b, c) = S_0 + \gamma_6 u + \gamma_7(2(\gamma_3 t_1 + \gamma_4 t_2) + v) \\ S_b &= d(o, b) + d(a, c) = S_0 + \gamma_6(u + 2(\gamma_4 t_1 + t_5)) + \gamma_7(2\gamma_3 t_1 + v) \\ S_c &= d(o, c) + d(a, b) = S_0 + \gamma_6(u + 2(\gamma_4 t_1 + t_5)) + \gamma_7(2\gamma_4 t_2 + v) \end{aligned}$$

where S_0 is the sum of the external edge lengths after zipping-up the network, $u = \gamma_3 t_1 + \gamma_4 t_2$ and $v = \gamma_3 t_2 + \gamma_4 t_1 + t_5$. Consequently,

$$\begin{aligned} S_b = S_c &\iff \gamma_3 = t_2/(t_1 + t_2) \\ S_a = S_b &\iff \gamma_6 = \gamma_4 t_2 / (\gamma_4(t_1 + t_2) + t_5) \\ S_a = S_c &\iff \gamma_6 = \gamma_3 t_1 / (t_1 + t_5). \end{aligned}$$

Therefore, except on a subspace of Lebesgue measure 0, the pairwise sums S_a , S_b and S_c take distinct values, all non-trivial splits violate the 4-point condition, and the distance split tree is a star. Furthermore, we see that

$$S_a < S_b = S_c \iff \gamma_3 = t_2/(t_1 + t_2) \text{ and } 1 - \gamma_7 = \gamma_6 > \frac{t_1 t_2}{(t_1 + t_2)(t_1 + t_5)}$$

in which case $oa \mid bc$ is the only non-trivial split satisfying the 4-point condition, and forms the distance split tree. \square

Turning to the proof of Theorem 10, we introduce a few more definitions. We first define network refinements that preserve up-down paths and distances (Fig. 11). They are defined for networks of any level and at any polytomy, so they are more general than the refinements described in Theorem 10.

Definition 13 (network refinements) Let N be a semidirected network on X , u a non-binary node (i.e. of degree 4 or more) in N , and let $E(u)$ be the set of edges adjacent to u . Let $\{E_1, E_2\}$ be a partition of $E(u)$ such that $|E_1|, |E_2| \geq 2$ and all the incoming hybrid edges (into u), if any, are in E_1 . Then the network N' obtained by the following steps is called a *refinement of N at u by $E_1 \mid E_2$* :

1. Add a new node u' , and add a tree edge uu' of length 0;
2. replace each edge $uv \in E_2$ by a new edge $u'v$.

Further, if B is a blob and u is a node in B , let $E_B(u)$ denote the set of edges in B incident to u . If E_1 contains $E_B(u)$, then we call the resulting refinement a *blob-preserving refinement at u* . If $E_1 = E_B(u)$ and $E_2 = E(u) \setminus E_B(u)$ then we call the refinement the *canonical refinement at u* .

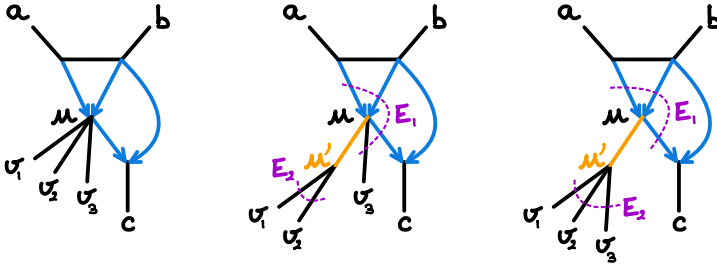

Fig. 11: Left: network with a non-binary node u . Middle and right: refinements at u for two choices of $E_1 \mid E_2$. In both, E_1 contains the 3 hybrid edges incident to u and E_2 contains the edges incident to v_1 and v_2 . The edge incident to v_3 is either in E_1 (middle) or in E_2 (right). The canonical refinement at u is the rightmost network.

Since leaves must have degree one and refinements are defined at non-binary nodes, u cannot be a leaf. Also, if either E_1 or E_2 has only one edge, then u or u' would become of degree 2, rendering the refinement uninteresting. It is easy to see that N' is still a valid semidirected network, since for any rooted network N^+ that induces N , one can keep the root and direct the new edges consistently to get a rooted network $N^{+'}$ that induces N' . Namely, if u is a hybrid node, then uu' is directed towards u' . Otherwise, we can direct uu' depending on whether the single parent of u is in E_1 or in E_2 . In both cases, uu' is a tree edge.

A blob-preserving refinement does not change the non-trivial blobs, but adds a new trivial blob $\{u'\}$: suppose B is a non-trivial blob in N , then $E_2 \subseteq E(u) \setminus E_B(u)$ contains cut edges only. Therefore, the new tree edge uu' is also a cut edge. The following lemma is a result of this property.

Lemma 18 *Let B be a blob in a metric semidirected network N on X , b the corresponding node in the tree of blobs T of N , and let u be a non-binary node in B . If N' is a refinement of N at u , then the pairwise distance on X is the same on N' and N . Furthermore, if N' is a blob-preserving refinement at u by the edge bipartition $E_1 \mid E_2$, then $BT(N')$ is a refinement of T at b by $\widetilde{E}_1 \mid \widetilde{E}_2$, where $\widetilde{E}_2 = E_2$ (which are cut-edges and appear in T) and $\widetilde{E}_1 = E(b) \setminus \widetilde{E}_2$.*

Proof For the first claim, it suffices to show that for any tips $x, y \in X$, there is a bijection between the sets of up-down paths $x \longleftrightarrow y$ in N and in N' that preserves the lengths and hybridization parameters. Assume the refinement is by $E_1 \mid E_2$. Let p be an up-down path between x and y in N . Consider the following map f . If p does not include u , or if p includes u but the two edges incident to u in p are both in E_1 , then p is also an up-down path in N' , and we let $f(p) = p$. If p includes u and the two edges incident to u in p are both in E_2 , then we may change u to u' in p to obtain up-down path p' in N' and set $f(p) = p'$. Finally, if p includes u with one incident edge in E_1 and one in E_2 , then we may assume, without loss of generality,

that $p = x \dots aub \dots y$ with $au \in E_1$ and $bu \in E_2$. Then let $p' = x \dots auu'b \dots y$. Since uu' is a tree edge, p' has no v-structure and is an up-down path in N' . We set $f(p) = p'$. It is easy to see that f is injective, that $\gamma(f(p)) = \gamma(p)$, and $\ell(f(p)) = \ell(p)$. As a result, the up-down paths in the image of f have hybridization parameters that sum up to one, so f is surjective as well.

For the second claim, let u' be the new node introduced in the refinement. As previously noted, E_2 contains cut edges only, so we are only deleting and adding cut edges during a blob-preserving refinement. Hence all the operations correspond to the operations on the tree of blobs T . Consequently we can get $BT(N')$ from T by adding a node b' corresponding to the trivial blob $B' = \{u'\}$ in N' , cut edge bb' corresponding to uu' , and replace edges bc with $b'c$ for each cut edge $uv \in E_2$, where c corresponds to the blob containing v . This is the refinement of T at b by $E_1 \mid \widetilde{E_2}$. \square

We now introduce definitions for splits that resolve a polytomy in the tree of blobs without affecting the blob itself in the network. Later, we prove that the distance split tree resolves the tree of blobs with splits of this kind.

Definition 14 (split along a blob; sibling groups) Let N be a semidirected network on X , T its tree of blobs, and B a blob of N with corresponding node b in T . When b is removed, suppose T is disconnected into k connected components, with taxa Y_1, \dots, Y_k in each. We call $\{Y_i; i \leq k\}$ the *partition induced by B* . If a split σ on X has a set that is the union of two or more Y_i 's, then σ is *along the partition induced by B* , or *along B* . Let e_i be the cut edge in T (or N) adjacent to B whose removal disconnects Y_i from B . If e_i and e_j share a node $u \in B$ then Y_i and Y_j are called *sibling sets of B at u* . For a node $u \in B$, the *sibling group at u* is the union of all sibling sets of B at u .

The following is a restatement of Lemma 3.1.7 in [10], using our definitions.

Lemma 19 Let T be a phylogenetic X -tree, and T' a refinement of T . Then every split $\sigma \in \Sigma(T') \setminus \Sigma(T)$ is along some node u of T .

Next, we characterize the set of splits Σ_D that satisfy the 4-point condition on N .

Lemma 20 Let N be a level-1 network on X with no degree-2 blobs, and with internal tree edges of positive lengths. Let B be a blob of N of degree 4 or more. If B is trivial, then any split along B satisfies the 4-point condition. If B is nontrivial, then a split along B satisfies the 4-point condition if and only if it is of the form $S \mid \bar{S}$ where S is a union of sibling sets of B . Furthermore, a split σ along B is in $\Sigma(T')$, T' being the distance split tree, if and only if B is a nontrivial blob and σ is of the form $S \mid \bar{S}$ where S is a sibling group of B .

Proof If $B = \{u\}$ is trivial, then for any split σ along B we can find the corresponding refinement N^R at u with the extra edge inducing σ in the tree of blobs. Since N^R has the same pairwise distances, $\sigma \in \Sigma(\text{BT}(N^R))$ satisfies the 4-point condition by lemma 17. Furthermore, we claim that for any split σ along B , there is another split σ' along B that is incompatible with σ . This would imply that $\sigma \notin \Sigma(T')$. To show the claim, let $\{Y_i; i \leq d\}$ be the partition induced by B , with $d = \deg(B) \geq 4$. Let σ be of the form $\cup_{i \in I_1} Y_i \mid \cup_{i \in I_2} Y_i$, where $\{I_1, I_2\}$ is a bipartition of $\{1, \dots, d\}$. Now we may choose $\sigma' = \cup_{i \in I'_1} Y_i \mid \cup_{i \in I'_2} Y_i$ where $\{I'_1, I'_2\}$ is a bipartition of $\{1, \dots, d\}$ incompatible with $\{I_1, I_2\}$: such that $I_i \cap I'_j$ are all non-empty. Then σ' is along B and incompatible with σ .

If B is nontrivial, first consider $\sigma = S \mid \bar{S}$ where S is a union of sibling sets of B , that is, S contains the leaves corresponding to a set E of cut edges adjacent to some node $u \in B$. Then, in the blob-preserving refinement of N^R at u by $E(u) \setminus E \mid E$, the extra cut edge induces σ . Hence $\sigma \in \Sigma(N^R)$ satisfies the 4-point condition. Conversely, consider a non-trivial split $\sigma = A \mid \bar{A}$ where both A and \bar{A} intersect at least two of the sibling groups of B . Let Y_1, \dots, Y_d be the sibling groups such that Y_1 is the sibling group at B 's hybrid node. Since $d = \deg(B) \geq 4$, it is easy to see that we can find distinct $\{i_1, \dots, i_4\}$, $x_1, x_2 \in A$ and $x_3, x_4 \in \bar{A}$ such that $1 \in \{i_1, \dots, i_4\}$, and $x_j \in Y_{i_j}$. Then the subnetwork $\tilde{N} = N_{\{x_1 x_2 x_3 x_4\}}$ is equivalent to the leftmost network in Figure 8 with positive branch lengths for both tree edges in the cycle. By Example 3, the 4-point condition is not met for $x_1 x_2 \mid x_3 x_4$, which finishes the proof of the claim.

Finally, consider a split $\sigma = S \mid \bar{S}$ along B that satisfies the 4-point condition, but where S is a proper subset of the sibling group at some node $u \in B$. Then u must be adjacent to $k \geq 3$ cut edges, and S must be the union of l sibling sets at u , with $2 \leq l < k$. Then similarly to the case when B is trivial, we can find a nonempty union of sibling sets S' , such that $\sigma' = S' \mid \bar{S}'$ is incompatible with σ . Since σ' satisfies the 4-point condition, $\sigma \notin \Sigma(T')$. \square

Proof of Theorem 10 Note that the procedure described to obtain N^R is a series of canonical refinements. So by Lemma 18, N^R is a valid semidirected network with average distances identical to those in N .

Let $T = \text{BT}(N)$ and T' the distance split tree of N . By Lemma 19, any split $\sigma \in \Sigma(T') \setminus \Sigma(T)$ is along some blob B of N . By Lemma 20, there is no such extra split σ when B is trivial. If B is nontrivial, the extra splits must be of the form $S \mid \bar{S}$ where S is a sibling group at some node u . Such a split corresponds to the split introduced in the canonical refinement at u .

Finally, since N^R can be obtained from a series of canonical refinements, by Lemma 18, the tree of blobs of N^R can also be obtained from the series of corresponding refinements, which introduces exactly all the extra splits described above. As a result, $\text{BT}(N^R) = T'$. \square

5 Identifying sunlets

A k -sunlet is a semidirected network with a single k -cycle and reticulation, and for each node on the cycle, one or more pendant edge(s) (adjacent to a leaf). The sunlet is binary if k equals the number of leaves, n . This section considers the problem of identifying the branch lengths and hybridization parameters

in a sunlet from the average distances between the n tips. We assume that we know the network is a k -sunlet, but k is unknown and the ordering of the tips around the cycle is unknown. In other words, we consider the problem of identifying the exact network topology given that it is a sunlet.

A *circular ordering* of the leaves $X = \{x_1, \dots, x_k\}$ is, informally, the order of the leaves when placed around an undirected cycle. Formally, it is the class of an ordering $(x_{i_1}, \dots, x_{i_k})$ up to the equivalence relations $(u_1, \dots, u_k) \sim (u_k, \dots, u_1)$ and $(u_1, u_2, \dots, u_k) \sim (u_2, \dots, u_k, u_1)$.

5.1 4-sunlets

First we consider the problem of identifying the lengths and hybridization parameter in a binary 4-sunlet, assuming the labelled semidirected topology is known (Fig. 12 left). Specifically, we assume that we know h is of hybrid origin, a and b are its half-sisters and g is opposite of the hybrid node.

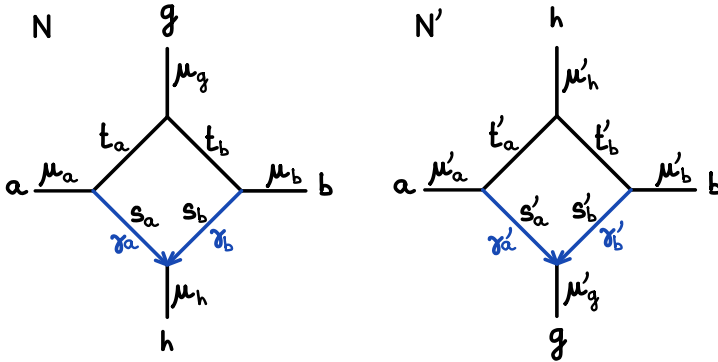

Fig. 12: 4-sunlets with the same undirected topology. Left: h is of hybrid origin. Right: g is of hybrid origin. By Theorem 22, parameters can be chosen such that both networks have the same average distances between leaves.

In this case, we have 6 average distances, but 9 parameters. Zipping up the 4-sunlet removes 2 degrees of freedom, but one free parameter still remains. Specifically, we have

$$\begin{aligned}
 d_{ga} &= (\mu_a + t_a) + \mu_g \\
 d_{gb} &= (\mu_b + t_b) + \mu_g \\
 d_{ab} &= (\mu_a + t_a) + (\mu_b + t_b) \\
 d_{ah} &= (\mu_h + s_a \gamma_a + s_b \gamma_b) + \gamma_b (t_a + t_b) + \mu_a \\
 d_{bh} &= (\mu_h + s_a \gamma_a + s_b \gamma_b) + \gamma_a (t_a + t_b) + \mu_b \\
 d_{gh} &= (\mu_h + s_a \gamma_a + s_b \gamma_b) + \gamma_a t_a + \gamma_b t_b + \mu_g
 \end{aligned} \tag{5}$$

Theorem 21 *Let d be a metric on four tips $\{a, b, g, h\}$. The 4-sunlet N with circular ordering (a, g, b, h) and in which h is of hybrid origin (left of Fig. 12) has average distances d for some set of parameters such that $t_a > 0$ and $t_b > 0$ if and only if*

$$d_{gh} + d_{ab} > \max\{d_{ah} + d_{bg}, d_{bh} + d_{ag}\} \quad (6)$$

and

$$\frac{d_{gh} + d_{ab} - d_{ah} - d_{bg}}{d_{ab} + d_{ag} - d_{bg}} + \frac{d_{gh} + d_{ab} - d_{bh} - d_{ag}}{d_{ab} + d_{bg} - d_{ag}} \leq 1. \quad (7)$$

In this case, we can identify μ_g and the following composite parameters:

$$\begin{aligned} \mu_g &= \frac{1}{2}(d_{ag} + d_{bg} - d_{ab}) \\ \mu_a + t_a &= \frac{1}{2}(d_{ab} + d_{ag} - d_{bg}) \\ \mu_b + t_b &= \frac{1}{2}(d_{ab} + d_{bg} - d_{ag}) \\ l_h := \mu_h + s_a\gamma_a + s_b\gamma_b &= \frac{1}{2}(d_{ah} + d_{bh} - d_{ab}) \\ \gamma_a t_a &= \frac{1}{2}(d_{gh} + d_{ab} - d_{ah} - d_{bg}) \\ \gamma_b t_b &= \frac{1}{2}(d_{gh} + d_{ab} - d_{bh} - d_{ag}). \end{aligned} \quad (8)$$

However, γ , t_a , t_b , μ_a , μ_b are not identifiable. In particular, γ_a can take any value in the following interval:

$$\left[\frac{d_{gh} + d_{ab} - d_{ah} - d_{bg}}{d_{ab} + d_{ag} - d_{bg}}, 1 - \frac{d_{gh} + d_{ab} - d_{bh} - d_{ag}}{d_{ab} + d_{bg} - d_{ag}} \right].$$

Furthermore, (6) is an equality if and only if one of the tree edges in the cycle has zero length: $t_a = 0$ or $t_b = 0$.

The proof below uses basic algebra. Condition (7) ensures that (8) can be solved to give non-negative μ_a and μ_b , and (6) ensures that $\gamma_a t_a > 0$ and $\gamma_b t_b > 0$. If (6) is an equality, then the 4-point condition is satisfied and d is a tree metric. $\gamma_a = 0$ or 1 lead to a tree metric, but hybrid edges are required to have $\gamma > 0$ by definition. Setting t_a or t_b to 0 also leads to a tree metric. Contracting the corresponding edge creates an unidentifiable degree-3 blob.

Proof of Theorem 21 It is easy to check with basic algebra that (8) is equivalent to (5). Therefore, we simply need to show that additionally imposing (6) and (7) is equivalent to requiring edge lengths be non-negative, $t_a, t_b > 0$ and hybridization parameters be in $(0, 1)$. Suppose that d comes from the 4-sunlet N . Condition (6) is equivalent to $d_{gh} + d_{ab} - d_{ah} - d_{bg} = 2\gamma_a t_a \geq 0$ and $d_{gh} + d_{ab} - d_{bh} - d_{ag} = 2\gamma_b t_b \geq 0$. For condition (7), we have

$$\frac{d_{gh} + d_{ab} - d_{ah} - d_{bg}}{d_{ab} + d_{ag} - d_{bg}} + \frac{d_{gh} + d_{ab} - d_{bh} - d_{ag}}{d_{ab} + d_{bg} - d_{ag}} = \frac{\gamma_a t_a}{\mu_a + t_a} + \frac{\gamma_b t_b}{\mu_b + t_b} \leq 1.$$

Conversely, suppose that a metric d on $\{a, g, b, h\}$ satisfies (6) and (7). Then there exists $\tilde{\gamma}$ such that

$$0 < \frac{d_{gh} + d_{ab} - d_{ah} - d_{bg}}{d_{ab} + d_{ag} - d_{bg}} \leq \tilde{\gamma} \leq 1 - \frac{d_{gh} + d_{ab} - d_{bh} - d_{ag}}{d_{ab} + d_{bg} - d_{ag}} < 1.$$

Then we can set $\gamma_a = 1 - \gamma_b = \tilde{\gamma}$ in (8) to solve for t_a first, getting $t_a > 0$ from (6). Then solving for μ_a , we get

$$\mu_a = \frac{1}{2} \left((d_{ab} + d_{ag} - d_{bg}) - (d_{gh} + d_{ab} - d_{ah} - d_{bg}) / \tilde{\gamma} \right) \geq 0$$

because of our condition on $\tilde{\gamma}$. Similarly, solving for t_b and μ_b gives $t_b > 0$ and $\mu_b \geq 0$. \square

When the sunlet topology is unknown, we need to identify the circular ordering of the tips around the cycle, and which of a, b, g or h is of hybrid origin. Suppose the tips are labelled by x, y, z, w , then by Theorem 21, the opposing pairs $\{x, y\}$ and $\{z, w\}$ correspond to the largest sum among $d_{xy} + d_{zw}$, $d_{xz} + d_{yw}$ and $d_{xw} + d_{yz}$.

Identifying the opposing pairs $\{a, b\}$ and $\{g, h\}$ is enough to identify the undirected graph of the 4-sunlet. However, identifying which tip is of hybrid origin is impossible, as we show below.

Theorem 22 *Let N be the 4-sunlet with circular ordering (a, g, b, h) in which h is of hybrid origin (Fig. 12, left). Let N' be the 4-sunlet with the same circular ordering, but in which g is of hybrid origin (Fig. 12, right). For any parameters (ℓ, γ) on N , there exist parameters (ℓ', γ') on N' such that N and N' have the same average distances.*

Proof We apply Theorem 21 to N' and the distance d obtained from N . We need to check that (6) and (7) are met. Condition (6) is met because it is symmetric in g and h . Condition (7) is not symmetric however. To fit d on N' , (7) can be written as (after permuting g and h):

$$\frac{d_{gh} + d_{ab} - d_{ag} - d_{bh}}{d_{ab} + d_{ah} - d_{bh}} + \frac{d_{gh} + d_{ab} - d_{bg} - d_{ah}}{d_{ab} + d_{bh} - d_{ah}} \leq 1.$$

Applying (8) to N from which d is obtained, we can rewrite the left-hand side as:

$$\begin{aligned} & \frac{\gamma_b t_b}{(\mu_a + t_a) - \gamma_a t_a + \gamma_b t_b} + \frac{\gamma_a t_a}{(\mu_b + t_b) - \gamma_b t_b + \gamma_a t_a} = \\ & \frac{\gamma_b t_b}{\mu_a + \gamma_b(t_a + t_b)} + \frac{\gamma_a t_a}{\mu_b + \gamma_a(t_a + t_b)} \leq \frac{\gamma_b t_b}{\gamma_b(t_a + t_b)} + \frac{\gamma_a t_a}{\gamma_a(t_a + t_b)} = 1. \end{aligned}$$

Hence (7) is met on N' , and parameters can be set to match the average distances from N . \square

Depending on the parameters in the 4-sunlet, it may be possible to switch g with a and h with b as well, if condition (7) holds for the network in which a (or b) is of hybrid origin. Namely, this is possible if μ_h and μ_g are large enough to satisfy

$$\frac{\gamma_a t_a}{\mu_g + \gamma_a t_a} + \frac{\gamma_b t_b}{\mu_h + s_a \gamma_a + s_b \gamma_b + \gamma_b t_b} \leq 1.$$

Usually we do not have external information about which tip is of hybrid origin, and even if we do, by Theorem 21 we can only identify μ_g , the length of the branch “across” from the hybrid node. It is therefore not possible to

identify the individual edge lengths. More generally, we can combine the swap lemma and Theorem 21 to prove that almost any hybrid-closed subgraph with 4 boundary nodes can be swapped with a 4-cycle without affecting distances.

Proposition 23 (swap a subgraph with a 4-sunlet) *In a network N , let A be a hybrid-closed connected subgraph with 4 boundary nodes such that $\gamma_A \equiv 1$ and each node $u \in \partial A$ has degree 1 in A . Let $t(u)$ denote the length of the edge incident to u in A . Then there exists $\eta \geq 0$ (which depends on $A \setminus \partial A$) such that the following holds: If $t(u) \geq \eta$ for each $u \in \partial A$, then we can swap A with a tree or with a 4-sunlet A' on leaf set ∂A to obtain a valid semidirected network N' with $d_{N'} = d_N$.*

Proof To simplify notations, let d denote $d(\cdot, \cdot | A)$. If d satisfies the 4-point condition, then there is a unique 4-taxon tree A' on ∂A such that $d_{A'} = d$ on ∂A (and $\gamma_{A'} \equiv 1$). Swapping A with A' leads to a valid semidirected network topology N' because any valid root position in N remains valid in N' . N' remains acyclic because $\gamma_A \equiv 1$ and A is hybrid-closed: when edges are directed away from the root, A must have exactly one “entry” boundary node, whose incident edge in A is outgoing. Therefore, an undirected path between two nodes in ∂A made of edges not in A must have a v-structure, and then N' cannot contain directed cycles. Finally, we can apply Lemma 15 to prove the claim with $\eta = 0$.

If d does not satisfy the 4-point condition, then A must contain at least one hybrid edge. We may label the nodes in ∂A as $\{h, a, g, b\}$ such that (6) holds for d and h is below some hybrid edge in A . Let A' be a 4-sunlet on leaf set ∂A with h below the hybrid node and circular ordering (h, a, g, b) . Swapping A with A' leads to a valid semidirected network topology N' because any valid root position in N is not below h , and is again valid in N' . We also have $\gamma_{A'} = \gamma_A \equiv 1$. We now want to assign edge parameters in A' such that $d_{A'} = d$ on ∂A . By Theorem 21, this is possible provided that (7) holds for d . Modifying $t(u)$ for $u \in \partial A$ does not modify the numerator of either term in (7). Let aa_0 and b_0b be the edges in A incident to a and b respectively. Then the denominators in (7) can be expressed as $2t(a) + d_{a_0b_0} + d_{a_0g} - d_{b_0g}$ and $2t(b) + d_{a_0b_0} + d_{b_0g} - d_{a_0g}$. Therefore (7) holds if $t(a) > \eta$ and $t(b) > \eta$ where η is the maximum of $d_{gh} + d_{a_0b_0} - d_{a_0h} - d_{b_0g} - (d_{a_0b_0} + d_{a_0g} - d_{b_0g})/2$ and $d_{gh} + d_{a_0b_0} - d_{b_0h} - d_{a_0g} - (d_{a_0b_0} + d_{b_0g} - d_{a_0g})/2$. This concludes the proof by Lemma 15. \square

We can now prove Theorem 7 on networks of level up to k , $k \geq 2$.

Proof of Theorem 7 It suffices to consider $k = 2$. Consider the networks in Fig. 8, say A_1 on the left and A_2 on the right. Let $n \geq 4$. If $n = 4$, set $N_1 = A_1$ and $N_2 = A_2$. If $n \geq 5$, we can form networks N_i ($i = 1, 2$) with n taxa by replacing the leaves a, b, c and/or d in A_i by subtrees with enough taxa. Given any values for the parameters labelled in Fig. 8 for A_2 such that $u_4 > 0$, d_{A_2} satisfies (6) with the same ordering as d_{A_1} . By Proposition 23 and its proof, we can swap A_2 with A_1 provided that the edges incident to b and c are long enough in A_2 . It follows that $d_{N_1} = d_{N_2}$ for parameters in subsets of positive Lebesgue measure. \square

Definition 15 (canonical 4-sunlet split network) Consider a 4-sunlet whose undirected topology has circular ordering (a, g, b, h) (e.g. Fig. 13 right) and with cycle

tree edges of positive lengths. The underlying undirected graph (e.g. Fig. 13 left) can be considered as a *split network*, in which each pair of parallel edges identifies a single split and a single split weight (edge length), with *canonical* edge lengths defined as follows.

$$\begin{aligned}
 \hat{\mu}_g &= \frac{1}{2}(d_{ga} + d_{gb} - d_{ab}) & \hat{\mu}_a &= \frac{1}{2}(d_{ag} + d_{ah} - d_{gh}) \\
 \hat{\mu}_h &= \frac{1}{2}(d_{ha} + d_{hb} - d_{ab}) & \hat{\mu}_b &= \frac{1}{2}(d_{bg} + d_{bh} - d_{gh}) \\
 \hat{t}_{hb|ga} &= \frac{1}{2}(d_{gh} + d_{ab} - d_{ga} - d_{hb}) & \hat{t}_{ha|gb} &= \frac{1}{2}(d_{gh} + d_{ba} - d_{gb} - d_{ha}).
 \end{aligned} \tag{9}$$

Distances on this canonical split network, calculated between any two tips as the length of the shortest path between them [44], are identical to the average distances on the original semi-directed 4-sunlet.

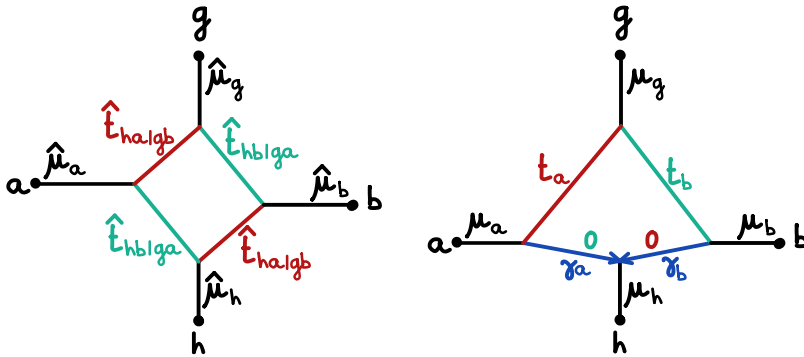

Fig. 13: Left: split network, with canonical edge lengths from Definition 15. A pair of parallel edges represent the same split and thus share the same length ($\hat{t}_{hb|ga}$ or $\hat{t}_{ha|gb}$ here). The distance between two nodes is defined as the length of the shortest path between them. Right: example zipped-up 4-sunlet represented by the split network on the left, in which h is of hybrid origin. Distances (using up-down paths) are identical to distances on the split network and satisfy (10).

This split network provides a unique representation of what can be identified from pairwise distances: undirected topology and identifiable composite parameters. Ideally, we would have liked a semi-directed representation, but since the location of the hybrid node is not identifiable, this was not an option.

Theorem 24 (identifiability of 4-sunlet split network) *Let N and N_0 be binary 4-sunlets with identical leaf set and internal tree edges of positive lengths. If N and N_0 have identical average distances, then the canonical 4-sunlet split networks of N and N_0 are identical.*

Proof The positivity of cycle tree edge lengths ensures that

$$d_{ab} + d_{gh} > \max\{d_{ag} + d_{bh}, d_{ah} + d_{bg}\}$$

is satisfied strictly, so N and N_0 must have the same circular ordering. Finally, the definition of canonical edge lengths from average distances in (9) is symmetric with respect to the hybrid node: canonical lengths depend on the circular ordering only. \square

There is a tight correspondence between edge lengths in the semi-directed network and edge lengths in the split network, provided that the placement of the hybrid node is known. For example, if h is of hybrid origin and if the network is zipped up as in Fig. 13 (right), then by Theorem 21 we have that:

$$\begin{aligned} \hat{\mu}_g &= \mu_g, & \hat{\mu}_a &= \mu_a + \gamma_b t_a, & \hat{t}_{ha|gb} &= \gamma_a t_a, \\ \hat{\mu}_h &= \mu_h, & \hat{\mu}_b &= \mu_b + \gamma_a t_b, & \hat{t}_{hb|ga} &= \gamma_b t_b. \end{aligned} \quad (10)$$

By (10) we have that $\hat{\mu}_s \geq \mu_s$ for each cut edge. In fact, $\hat{\mu}_s = \mu_s$ is a correct length estimate for the zipped-up child edge of the hybrid node and for the cut edge opposite to the hybrid node. For the other cut edges, $\hat{\mu}_s$ is an overestimate of μ_s . For example, for the network in Fig. 13 (right) where h is the hybrid node, then $\hat{\mu}_a = \mu_a + \gamma_b t_a \geq \mu_a$. We do not know which cut edge length is correctly represented, however. Similarly, $\hat{t}_{hb|ga}$ and $\hat{t}_{ha|gb}$ are underestimates of the length of *tree* edges in the cycle, although we do not know which edges in the cycle are tree or hybrid edges.

If a 4-sunlet has a polytomy, its canonical split network can be defined (and Theorem 24 can be applied) after resolving the polytomy with an extra edge of length 0. As Fig. 14 shows, networks with polytomies adjacent to a 4-cycle may have the same average distances as networks without polytomies.

5.2 k -sunlet for $k \geq 5$

With 5 or more nodes in the cycle, we can identify the topology, branch lengths, and hybridization parameters of the zipped-up version of the sunlet.

Theorem 25 (*k*-sunlet identifiability, $k \geq 5$) *Let N and N_0 be semidirected networks with identical leaf set $\{u_0, \dots, u_{n-1}\}$ and internal tree edges having positive lengths, such that N is a k -sunlet and N_0 is a k_0 -sunlet with $k_0 \geq 5$. If N and N_0 have identical average distances, then the zipped-up versions of N and N_0 are identical.*

Proof We first we show that N and N_0 must have the same topology, and then the same branch lengths and hybridization parameter. In N_0 , let the hybrid node be v_0 , and let the other internal nodes be v_1, \dots, v_{k-1} such that v_{i-1} and v_i are neighbors (as in Fig. 15). Let C_i be the set of leaves adjacent to v_i in N_0 . If there are no polytomies, then each C_i is reduced to a single leaf u_i .

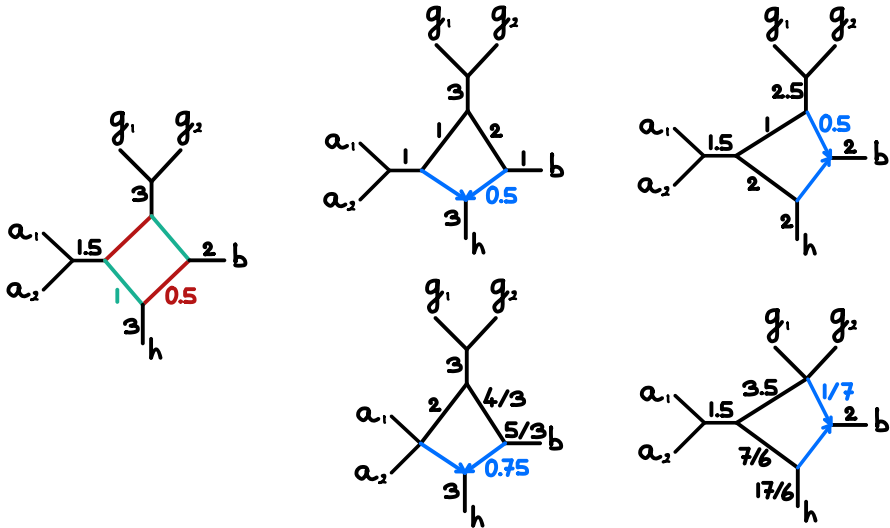

Fig. 14: Canonical split network representation (left) of 4 zipped-up semidirected networks with identical average distances, in which h (middle) or b (right) is of hybrid origin. Two networks (bottom) have a polytomy adjacent to the 4-cycle. In the split network, pairs of parallel edges of identical color represent a single split and share the same length (split weight). Hybrid edges (arrows) have length 0 and inheritance γ shown in blue for one of them. Numbers in black indicate edge lengths. The split network shows the 6 composite parameters identifiable from distances, pertaining to the 4-cycle. Zipped-up semidirected networks have 7 associated parameters.

By Lemma 20, each non-trivial split in the distance split tree of N is of the form $C \mid \bar{C}$, where C is a set of all the sister leaves that are adjacent to the same cycle node in N , and $\bar{C} = X \setminus C$. The same holds for N_0 .

Since N and N_0 have identical pairwise distances, they have the same distance split tree, and consequently identical sets of sister leaves (polytomies). In particular, we must have that $k = k_0$. So without loss of generality, we choose a single representative leaf from each C_i for the remainder of the proof. In other words, we may assume that both N and N_0 have no polytomies and $k = n$ (as in Fig. 16).

Identifying the circular ordering of leaves.

First, we claim that the leaf of hybrid origin u_0 is the only leaf u such that:

$$\forall x, y, z, \{u, x, y, z\} \text{ does not satisfy the 4-point condition.} \quad (11)$$

Indeed, if $u = u_0$, then $\{u, x, y, z\}$ induces in N_0 a 4-sunlet in which both tree edges in the cycle have positive length, so $\{u, x, y, z\}$ does not satisfy the 4-point condition by Theorem 21. If $u = u_i$ for $i > 0$, then we can choose 3 other leaves u_j, u_k, u_l different from u_0 , because $k_0 \geq 5$. The induced subnetwork is then a tree, so the 4-point condition holds, such that u_i does not satisfy (11) for $i \geq 0$. Therefore, the leaf of hybrid origin must be the same in N as in N_0 : u_0 .

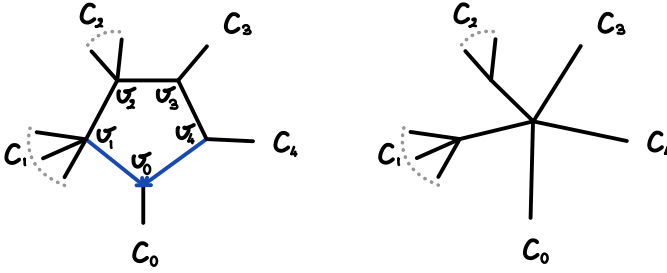

Fig. 15: Left: 5-sunlet N on 8 taxa. Its tree of blobs is a star. C_i is the sibling group at v_i ($i = 0, \dots, 4$). Right: distance split tree constructed from d_N . It is a refinement of the tree of blobs, but identifies the polytomies in the sunlet.

Next, we consider the subnetwork of N_0 induced by the leaves other than u_0 . (For sake of brevity, in what follows in this subsection, all the subnetworks have degree-2 nodes suppressed.) This subnetwork has no reticulation, it is binary and its internal branch lengths are positive, so it is equal to its tree of blobs and its distance split tree. Therefore, the subnetwork of N induced by the leaves other than u_0 has the same tree topology. This tree must be a caterpillar (Fig. 16, middle) with two cherries: $\{u_1, u_2\}$ and $\{u_{k-2}, u_{k-1}\}$ and internal nodes that correspond to v_2, \dots, v_{k-2} . Its topology determines the ordering of the other leaves. In other words, the ordering of u_3, \dots, u_{k-3} must be identical in N and in N_0 . We can also match the internal nodes v_3, \dots, v_{k-3} in N_0 to internal nodes in N . What remains to be identified is which of $\{u_1, u_2\}$ and which of $\{u_{k-2}, u_{k-1}\}$ is adjacent to either parent of the hybrid node in N . For this, consider the subnetworks from N and N_0 induced by $\{u_2, u_1, u_0, u_{k-1}\}$. By (6) in Theorem 21, the average distances on $\{u_0, u_1, u_2, u_{k-1}\}$ determine the circular ordering of these 4 taxa, such that u_1 must be adjacent to a hybrid parent in N , as it is in N_0 . Similarly, the average distances on $\{u_0, u_1, u_{k-2}, u_{k-1}\}$ determine the circular ordering of these 4 taxa such that u_{k-1} must be adjacent to a hybrid parent in N , like in N_0 . This finishes the proof that the circular ordering of leaves is identical in N and in N_0 .

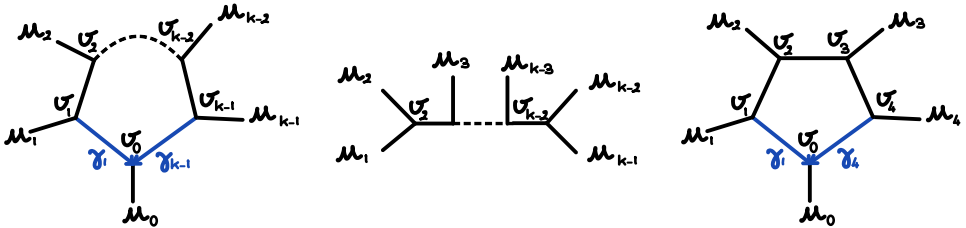

Fig. 16: Left: binary k -sunlet. Middle: after excluding u_0 , the subnetwork is a tree. Right: subnetwork on $\{u_0, u_1, u_2, u_{k-2}, u_{k-1}\}$, a sunlet with $k = 5$.

Identifying branch lengths and hybridization parameters.

By considering distances between u_1, \dots, u_{k-1} , we can determine the lengths of all the edges of the caterpillar tree $N_{\{u_1, \dots, u_{k-1}\}}$ (Fig. 16, middle). In particular, we get that the following edges have the same length in N as in N_0 : $v_i v_{i+1}$ for $2 \leq i \leq k-3$ and $v_i u_i$ for $2 \leq i \leq k-2$. The parameters that remain to be identified are in the subnetwork induced by $\{u_0, u_1, u_2, u_{k-2}, u_{k-1}\}$. Therefore, we may assume that $k = 5$, as we do below (Fig. 16, right).

For brevity in this paragraph, for an edge uv we also write its length as uv . From the tree induced by $\{u_1, \dots, u_4\}$, we have the lengths $u_2 v_2, u_3 v_3, v_2 v_3, v_3 v_4 + u_4 v_4$, and $u_1 v_1 + v_1 v_2$. From the subnetwork induced by $\{u_0, u_1, u_2, u_4\}$, by Theorem 21 we can identify $l_h = \gamma_1 \cdot v_1 v_0 + \gamma_4 \cdot v_4 v_0 + u_0 v_0$, which is the length of $v_0 u_0$ after unzipping. We can also identify $\gamma_1 \cdot v_2 v_1$ and $\gamma_4 (v_2 v_3 + v_3 v_4)$. From the subnetwork on $\{u_0, u_1, u_3, u_4\}$, we also get $\gamma_1 (v_1 v_2 + v_2 v_3)$. Hence we can identify γ_1 as $(\gamma_1 (v_1 v_2 + v_2 v_3) - \gamma_1 \cdot v_1 v_2) / v_2 v_3$ from pairwise distances. All other parameters in the unzipped version of N are also identifiable, using: $v_1 v_2 = \gamma_1 \cdot v_1 v_2 / \gamma_1$, $\gamma_4 = 1 - \gamma_1$, $v_3 v_4 = (\gamma_4 (v_2 v_3 + v_3 v_4)) / \gamma_4 - v_2 v_3$, and as a result $u_1 v_1$ and $u_4 v_4$. \square

6 Identifying level-1 networks

While a degree-3 blob is not detectable, a 4-cycle in a level-1 network corresponds to a polytomy in the tree of blobs. Its hybrid node and its zipped-up version is unidentifiable, but the canonical split network of a 4-sunlet is identifiable, by Theorem 24. To prove Theorem 12, we first define mixed networks formally.

6.1 Mixed network representation

In the mixed representation of a semi-directed level-1 network, the cycles of size 5 or greater are unchanged. The 4-cycles, which are only partially identifiable, are replaced by split networks, extending the split network representation of 4-sunlets from section 5.1 with canonical edge lengths given by (9).

Definition 16 (mixed network) A *mixed network* is a semidirected graph where undirected edges are partitioned into two sets: tree edges E_T and split edges E_S ; and where E_S is itself partitioned into a set of classes. When the graph is embedded in a Euclidean space, split edges within the same class are represented as parallel segments. A *metric* (ℓ, γ) on a mixed network M is such that $\ell : E \rightarrow \mathbb{R}_{\geq 0}$ assigns the same length to all edges in the same class of split edges; and $\gamma : E \rightarrow [0, 1]$ assigns $\gamma(e) = 1$ if e is undirected and $\gamma(e) \in (0, 1)$ if e is directed.

Definition 17 (mixed network representation of a level-1 network) Let N be a level-1 semidirected network with no 2- or 3-cycles. The *mixed network representation* N^* of N is the mixed network obtained as follows:

1. In each 4-cycle, the subgraph on the left of Fig. 17 is excised and replaced with that on the right.
2. Suppress any degree-2 node.

In N^* , 4-cycles consist of split edges and are called *split blobs*.

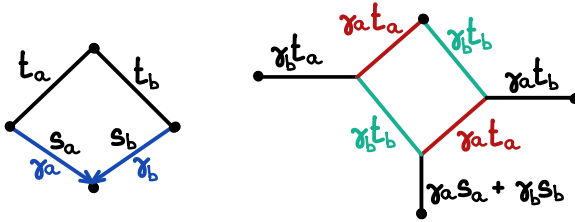

Fig. 17: Mixed network: representation of a 4-cycle in a semidirected network N (left) to form a split blob (right). Edges in the cycle are converted to undirected split edges with $\gamma = 1$, categorized in the two classes depicted by colors. Adjacent tree edges are added. If N is zipped up, then $s_a = s_b = 0$ and the lower tree edge (adjacent to the hybrid node in N) is not needed.

In a mixed network M , a *mixed up-down path* between two nodes a, b is a path $p = u_0 u_1 \dots u_n$ between $u_0 = a$ and $u_n = b$ in $U(M)$ such that:

1. p has no v-structure, that is, no segment $u_{i-1} u_i u_{i+1}$ such that $(u_{i-1} u_i)$ and $(u_{i+1} u_i)$ are directed edges in M ;
2. if a segment $u_i \dots u_j$ consists solely of split edges, then the segment is a shortest path between u_i and u_j in $U(M)$.

Given a metric (ℓ, γ) on M , the length of p is $\ell(p) = \sum_{e \in p} \ell(e)$, and the probability of p is $\gamma(p) = \prod_{e \in p} \gamma(e)$. A *split segment* is a path that consists solely of split edges. Two split segments S_1, S_2 are *equivalent* if they have the same endpoints and $\ell(S_1) = \ell(S_2)$. Note that a split segment S must have $\gamma(S) = 1$. Two mixed up-down paths p and q are *equivalent* if one can obtain q from p by replacing some split segments of p by equivalent split segments.

Definition 18 (average distance in a mixed network) The *average distance* between two nodes u, v in a mixed network M is the weighted average length of mixed up-down paths, up to equivalence, between u and v :

$$d_M(u, v) = \sum_{p \in P_{uv}} \gamma(p) \ell(p)$$

where P_{uv} is a set of mixed up-down paths between u and v , containing exactly one representative from each equivalence class. This distance is well-defined because equivalent paths have the same lengths and probabilities.

Importantly, average distances are preserved by the mixed representation of a level-1 network:

Theorem 26 *Let N be a level-1 semidirected network on taxon set X , and N^* the mixed network representation of N . Then for any $x, y \in X$,*

$$d_N(x, y) = d_{N^*}(x, y).$$

The proof, in appendix A.4, first shows that average distances in mixed networks can be interpreted as the expected shortest path length over “displayed split networks”.

6.2 Identifying the mixed representation of level-1 networks

We now have the tools to prove Theorem 12.

Proof of Theorem 12 For $i = 1, 2$, let N_i be a zipped-up level-1 semidirected network on X with internal tree edges of positive lengths, and N_i^R the refinement described in Theorem 10. Also let N_i^{R*} be the mixed representation of N_i^R , and N_i^* the mixed representation of N_i . Assume that $d_{N_1} = d_{N_2} = d$. By Theorem 10, N_1^R and N_2^R have the same tree of blobs T , so their blobs and cut edges are in bijection.

Let b be a node of degree $k \geq 4$ in T , and $\{e_1, \dots, e_k\}$ be the cut edges incident to b in T . Let B_i be the corresponding cycle in N_i^R ($i = 1, 2$), of length $k \geq 4$. Removing e_j disconnects T into two components. We select a leaf x_j from the component that does not contain b and use distances on $\{x_1, \dots, x_k\}$. If $k \geq 5$, B_1 and B_2 have the same topology and edge parameters by Theorem 25. If $k = 4$, the split cycle representing B_1 (in N_1^{R*}) and B_2 (in N_2^{R*}) have the same topology and canonical length of split edges, by Theorem 24. So N_1^{R*} and N_2^{R*} have the same topology (referred below as N^{R*}) and same parameters for edges within a blob.

Next, we need to prove that cut edges have the same length in N_1^{R*} and N_2^{R*} . These edges are also cut edges in N_i^R ($i = 1, 2$) and T . Let $e = uv$ be a cut edge and $B(u), B(v)$ the blobs that u and v belong to. We can select leaves as follows. If $B(u) = \{u\}$ (resp. $B(v) = \{v\}$) is an internal tree node that is not in any cycle, let e_1 and e_2 (resp. e_3 and e_4) be the two cut edges incident to u (resp. v) besides e . If u (resp. v) is part of a cycle, let e_1 and e_2 (resp. e_3 and e_4) be the cut edges incident to the two nodes adjacent to u (resp. v) in that cycle. We then choose a leaf x_j , $j = 1, 2$ (resp. $j = 3, 4$) in the connected component disjoint from $B(u)$ (resp. $B(v)$) when e_j is removed from T (see Fig. 18). Finally, if u (resp. v) is a leaf, we set $x_1 = x_2 = u$ (resp. $x_3 = x_4 = v$). Note that $\{x_1, x_2, x_3, x_4\}$ contains at least 3 distinct leaves because N^{R*} has no degree-2 blob. If u and v do not have an outgoing hybrid edge in N^{R*} , then the length of e must be the same in N_1^{R*} and N_2^{R*} and equal to

$$\ell(e) = t := \frac{1}{2} (d(x_1, x_3) + d(x_2, x_4) - d(x_1, x_2) - d(x_3, x_4))$$

because N_i^{R*} is unzipped and because this equality holds on a tree and for external edges of canonical degree-4 split sunlets. If u (resp. v) has an outgoing edge in N^{R*} , then $B(u)$ (resp. $B(v)$) is a k -cycle with $k \geq 5$, u (resp. v) is adjacent to its hybrid node, and $B(u)$ (resp. $B(v)$) is reduced to a 3-cycle in the subnetwork induced by $\{x_1, \dots, x_4\}$. By Proposition 6, shrinking this 3-cycle makes u (resp. v) of degree 2, incident to e and to a new edge of length t_u (resp. t_v). This new edge length is known because parameters are known for all cycle edges in $B(u)$ (resp. $B(v)$). We can then identify $\ell(e)$ by subtracting t_u (and/or t_v) from t .

At this point we have that $N_1^{R^*} = N_2^{R^*}$. By contracting the tree edges of length 0 we get that $N_1^* = N_2^*$. This finishes the proof of Theorem 12. \square

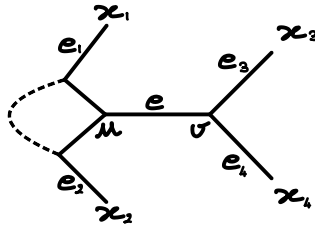

Fig. 18: Taxon sampling to cover a cut edge $e = uv$. In this example, the blob containing v is $\{v\}$ and the blob containing u is non-trivial. The subnetwork on $\{x_1, x_2, x_3, x_4\}$ includes e and both u and v as degree-3 nodes.

Acknowledgments. We are grateful to Sebastien Roch for insightful discussions on this work and John Fogg for detailed feedback. We thank 3 reviewers, whose comments greatly improved the paper. This work was supported in part by the National Science Foundation, (DMS 1902892 and DMS 2023239) and by a H. I. Romnes faculty fellowship (to C.A.) provided by the University of Wisconsin-Madison Office of the Vice Chancellor for Research and Graduate Education with funding from the Wisconsin Alumni Research Foundation.

Appendix A Proofs of technical results

A.1 Up-down paths and average distances

Proof of Proposition 1 Proposition 1 states the equivalence of up-down-path Definition 5 from [11], and Definition 6 for rooted networks. Let N^+ be a rooted network, and let $p = u_0 \dots u_n$ in N^+ satisfy Definition 5. Then clearly there is no v-structure in p , that is, there is no segment $u_{i-1}u_iu_{i+1}$ such that $u_{i-1}u_i$ and $u_{i+1}u_i$ are both edges in N^+ , and p satisfies Definition 6. Next, let $p = u_0 \dots u_n$ satisfy Definition 6. There are two cases:

- If u_0u_1 is an edge in N^+ , then since the direction cannot reverse during the path, we have that for all i , u_iu_{i+1} is an edge in N^+ , and p satisfies Definition 5.
- If u_1u_0 is an edge in N^+ , then we can look for the smallest index j such that u_ju_{j+1} is an edge in N^+ . If there is none, then p is a directed path from u_n to u_0 . If there is such j , then by the same argument as before, for all $i \geq j$, u_iu_{i+1} is an edge in N^+ . Either way, p satisfies Definition 5. \square

A.2 Proof that the zipped-up network is unique

In this section we prove that a metric semidirected network N has a unique zipped-up version N^* where all the hybrid edges have length 0, that can be obtained from N by a series of “zipping operations”.

First we shall restrict ourselves to networks with all hybrid nodes having a single child edge (i.e. tree edge or outgoing hybrid edge). For a network that does not satisfy the requirement, we can apply step 1 of Definition 9 (shown in Fig. 5) and work with the resulting network instead. By Proposition 3, such modifications do not change the distances between existing nodes.

Definition 19 Let N be a metric semidirected network in which hybrid nodes have a single child edge. Let h be a hybrid node, t be the length of its child edge and $a_i, i = 1, \dots, n$ be the lengths of its n incoming hybrid edges. A *zipping operation* at h is a modification of t, a_1, \dots, a_n such that t and all a_i remain non-negative, and $t + \sum_{i=1}^n \gamma_i a_i$ stays constant. Two networks are *zipping-equivalent* if one can be obtained from the other through a series of zipping operations.

The *hybrid funnel* $F(h)$ based at a hybrid node h is the maximal connected subgraph that consists of directed paths into h made of hybrid edges only, plus h 's child edge (see Fig. A1). The *height* of a hybrid funnel is the number of edges on its longest path ending at h .

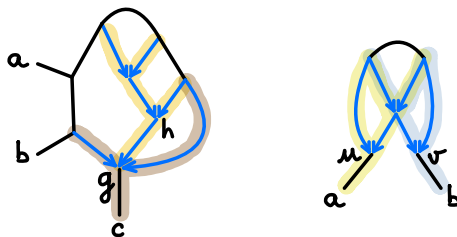

Fig. A1: Left: the hybrid funnel $F(h)$, highlighted in orange, is not maximal. $F(g)$ is maximal. It contains $F(h)$ and all highlighted edges. Right: $F(u)$ and $F(v)$ are both maximal (highlighted in yellow and blue respectively). They are not disjoint, as may occur when a hybrid node has more than one child. Zipping operations are performed after refining the network so that all hybrid nodes have a unique child.

Lemma 27 *In a network in which hybrid nodes have a single child, distinct maximal hybrid funnels have disjoint edge sets.*

Proof First, for a maximal hybrid funnel, the child of its base h must be a tree edge, because if it is a hybrid edge, we can get a larger hybrid funnel at its child node. Let

A and B be different maximal hybrid funnels. Then their bases u and v (respectively) must be distinct: $u \neq v$. If A and B have the same tree edge, then u and v must be incident by their common child edge, and after rooting the network, u or v would have three incoming edges but no outgoing edges, which is impossible. Therefore, A and B cannot share a tree edge.

Suppose A, B share a hybrid edge ab . Then there is a path from b to u consisting of hybrid edges only. The same holds for v . Because each hybrid node has a unique child edge, one of the two paths must be contained in the other. Consequently u or v has a hybrid edge as a child edge, which is a contradiction. \square

Lemma 28 *Let A be a maximal hybrid funnel in a metric semidirected network N . Then zipping operations in N do not change*

$$L(h) = t_h + \sum_{p \in P(h)} \gamma(p)\ell(p) \quad (\text{A1})$$

where h is the base of the funnel, t_h is the length of its child edge and $P(h)$ is the set of maximal directed paths in A that end at h .

Proof First, a zipping operation at a node outside of a maximal hybrid funnel $F(h)$ does not modify any of the edges of the funnel, and so does not change $L(h)$. To finish the proof, we show the following claim: for any hybrid node h , zipping operations at nodes in the funnel $F(h)$ (which may not be maximal) do not change $L(h)$.

To show this claim, we use induction on the height of $F(h)$. When the height is 1, the claim reduces to Proposition 3. Suppose the claim is true for heights up to k , and $F(h)$ is of height $k+1$. Let u_1, \dots, u_n be the parent nodes of h . We may assume that u_i is a hybrid node for $i \leq m$ and a tree node for $i > m$, for some $m \leq n$. Then $F(u_i), i = 1, \dots, m$ are of height $\leq k$. Note that

$$L(h) = t_h + \sum_{i=1}^m \gamma_i L(u_i) + \sum_{i=m+1}^n \gamma_i t_i$$

where $\gamma_i = \gamma(u_i h)$ and $t_i = \ell(u_i h)$. Let u be a hybrid node in $F(h)$. If $u \neq h$, then u must be in some $F(u_j)$, and a zipping operation at u does not affect $L(h)$ because t_h and all $L(u_i)$ stay unchanged (by induction). To consider a zipping operation at $u = h$, we rewrite

$$L(h) = t_h + \sum_{i=1}^n \gamma_i t_i + \sum_{i=1}^m \gamma_i (L(u_i) - t_i).$$

The last sum is a function of edges in the hybrid funnels at u_1, \dots, u_m , and is hence unchanged by the zipping operation at h . The term $t_h + \sum_{i=1}^n \gamma_i t_i$ is constant by Proposition 3, which completes the proof. \square

Theorem 29 *The zipped-up version of a network, as defined in Definition 9, exists and is unique.*

Proof Let N be a metric semidirected network. First we show that it is possible to obtain a zipped-up version of N . Consider a topological ordering of the nodes in N based on some (arbitrary) rooting of N . This is an ordering from the root to the leaves, such that u is listed before v whenever there exists a directed edge uv . Perform zipping-up operations as in Definition 9 according to this ordering (restricted to hybrid nodes). We claim that the resulting network N^* is zipped-up. Indeed, by virtue of the topological ordering, zipping operations at either parent of a hybrid node h must be performed before zipping up h , so the length of h 's parent edges remain 0 after being set to 0, and N^* is zipped-up.

To show that the zipped-up version of N is unique, we consider a zipped-up version N' and show that N' and N^* are identical. We consider two cases. If all hybrid nodes of N have unique child edges, then N' , N^* and N have the same topology and the same lengths for edges outside of any funnel. N' and N^* have hybrid edges of length 0. To show uniqueness, it suffices to show that they have identical lengths for tree child edges below hybrid nodes. Let h be a hybrid node with a tree child edge. Then the funnel $F(h)$ is maximal. By Lemma 28, $L(h)$ is identical in N' and in N^* (and in N), because N' and N^* are both zipping-equivalent to N . For N' and N^* , all the paths have length 0 in the last sum of (A1), such that the length t_h of the child edge must equal $L(h)$ and therefore be identical in N' and N^* ; and $N' = N^*$.

Now we consider the case when some hybrid nodes in N have two or more children. For a network M , let \widetilde{M} denote the network obtained by performing step 1 of Def. 9 below every hybrid node with multiple children, even those not zipped-up. Then a zipped-up version N' of N may have a different topology than \widetilde{N} . Step 1 of Def. 9 was performed in N' only at nodes that were not zipped-up, so the edges in \widetilde{N} missing from N' are below hybrid nodes that are zipped-up in N' . Conversely, the edges introduced in N' during zipping-up have positive lengths from (1) in step 2. Now let N'_1 and N'_2 be two zipped-up versions of N . Then \widetilde{N}'_i is a zipped-up version of \widetilde{N} , for $i = 1, 2$ (zipping up at the same series of hybrid nodes as to get N'_i from N). By the previous case, $\widetilde{N}'_1 = \widetilde{N}'_2$. Since the positivity of edges in \widetilde{N}'_i determines which tree edges have been introduced in N'_i , N'_1 and N'_2 have the same topology, and then the same metric. \square

A.3 Mapping the tree of blobs on the network

Proof of Proposition 16 Let $T = \text{BT}(N)$. For a node u in N , write $B(u)$ for the blob that contains u . For the first bijection: let g be the map from cut edges of N to the edges of T such that $g(uv)$ is the edge $(B(u), B(v))$ in T . It is injective because if two edges e_1 and e_2 get mapped to the same edge $(B(u), B(v))$ in T , then one could find a cycle in $U(N)$ that contains both e_1 and e_2 , contradicting that they are cut edges. It is surjective because for an edge e that connects two 2-edge-connected components U and V , the removal of e must disconnect U and V : Otherwise U and V would be the same 2-edge-connected component. Therefore e must be a cut edge, and we have $g(e) = (U, V)$.

For the second bijection: recall that we require all tips of a rooted network to have in-degree 1, so the same holds for the tips of a semidirected network N . The blob that contains a tip x is therefore a trivial blob, $\{x\}$. Let $f : V_L(N) \rightarrow V(T)$ be the map such that $f(x)$ is the trivial blob $\{x\}$. Clearly f is injective. We only need to show that these trivial blobs are all the leaves of T , i.e. we did not introduce new leaves in T that do not correspond to tips of N . Suppose that there is a leaf

blob B in T that is not of the form $\{x\}$ for some tip x in N . B may not contain any leaf x , because $\{x\}$ is a blob itself, so we would have $B = \{x\}$, a contradiction. Let N^+ be a rooted LSA network that induces N , obtained from rerooting N at a node. Let $e = (u, v)$ be the cut edge incident to B in N^+ . Then we must have that $u \in B$, because otherwise $v \in B$ and B would contain any descendant leaf of e (found by following any directed path starting at e until we reach a node of out-degree 0). Consequently, the root $\rho(N^+)$ must be in B (a leaf in T), for otherwise the edge e would be directed the other way. Now any path from the root to a leaf must go through (u, v) . Therefore v lies on every path from the root to any leaf. Since $v \neq \rho(N^+)$, N^+ is not an LSA network, a contradiction. \square

A.4 Proof that mixed representations preserve distances

To prove Theorem 26, we extend Definition 10.

Definition 20 (displayed split network) Let N^* be the mixed network representation of a level-1 semidirected network N . For hybrid node $h \in N^*$, let $E_H(h)$ be its parent hybrid edges. Let G be the graph obtained by keeping one hybrid edge $e \in E_H(h)$ and deleting the remaining edge(s) in $E_H(h)$, for each hybrid node $h \in N^*$. Then G is a split network [26, p.240] and is called a *displayed split network*. The distribution on displayed split networks generated by N^* is the distribution obtained by keeping $e \in E_H(h)$ with probability $\gamma(e)$, independently across h .

Note that G is a split network because it has no directed (hybrid) edges; its topology is of level 1; and its blobs are degree-4 cycles, each with 2 pairs of split edges.

Proposition 30 Let N^* be the mixed network representation of a level-1 semidirected network N . For two nodes u, v and split network G , let $Q_{uv}(G)$ be the set of paths between u and v in G that have shortest length. Then each equivalence class of mixed up-down paths between u and v in N^* is equal to $Q_{uv}(G)$ for some split network G displayed in N^* . Furthermore, for a given mixed up-down path p between u and v in N^* ,

$$\mathbb{P}(p \in Q_{uv}(G)) = \gamma(p)$$

where G is a random split network displayed in N^* . Consequently,

$$d_{N^*}(u, v) = \mathbb{E}\ell(Q_{uv}(G)) \tag{A2}$$

where the expectation is taken over a random displayed split network G in N^* .

Proof For the first claim, note that any shortest path between u and v in G is a mixed up-down path. We only need to show that all shortest paths between u and v in G are equivalent. Let q and q' be two of them. Note that any tree edge or hybrid edge from N^* that was retained in G is a cut edge in G . Since N is of level 1, each blob of G corresponds to a split blob (4-cycle) from N^* . Since the unique path from u to v in the tree of blobs of G contains the paths in $Q_{uv}(G)$, we get that q and q' must pass through the same tree edges, hybrid edges and split blobs; and in the same

order. They may differ in the edges that they contain from each split blob. Any such difference corresponds to replacing one split segment by an equivalent split segment (of shortest length). Therefore q and q' are equivalent.

For the second claim, let p be a mixed up-down path from u to v in N^* . It suffices to show that $p \in Q_{uv}(G)$ if and only if all the hybrid edges present in p are kept in G . The “only if” part is trivial. For the “if” part, assume that the hybrid edges from p are retained in G , such that p is in G . We want to show that it is of shortest length. Let $q \in Q_{uv}(G)$. Both p and q go from u to v , so by the same argument as above, p and q must pass through the same tree edges, hybrid edges, and split blobs; and in the same order. Since p is a mixed up-down path, its split segments must be of shortest length. Therefore p must traverse each split blob through a split segment of length no larger than that of q . Consequently $p \in Q_{uv}(G)$. \square

Proof of Theorem 26 By induction, it suffices to show that in a mixed network, replacing a single 4-cycle by its corresponding split cycle does not change the average distances. Let M be a mixed network on taxon set X with one or more semidirected 4-cycles, and let M' be the mixed network obtained from M by replacing one 4-sunlet subgraph C in M by the corresponding split subgraph C' . Since $U(M) = U(M')$, M and M' have the same tree of blobs T and C and C' correspond to the same node b in T . Let $x, y \in X$ be two tips of M and p be the path from x to y in T .

If p does not go through b , then the sets of mixed up-down paths between x, y are identical in M and in M' (they do not intersect C or C' respectively), therefore $d_M(x, y) = d_{M'}(x, y)$.

If instead p goes through b , then all mixed up-down paths from x to y in M (resp. M') intersect C (resp. C'), and they must all go through the same cut edges e_1 and e_2 adjacent to C (resp. C'). Let u and v be the nodes in C adjacent to e_1 and e_2 . We can identify u and v with nodes in C' if we omit step 2 in Def. 17. We can do so without loss of generality because the suppression of degree-2 nodes does not affect distances. Then, all mixed up-down paths in M (resp. M') from x to y go from x to u along edges that do not belong in C (resp. C'), then from u to v within C (resp. C'), and then from v to y through edges not in C (resp. C'). The same applies to each split network displayed in M (resp. M'). Since, in addition, d_G is defined as the length of the shortest path on a split network, the following holds when the graph G is any split network displayed in M or M' :

$$d_G(x, y) = d_G(x, u) + d_G(u, v) + d_G(v, y). \quad (\text{A3})$$

By (A2) in Proposition 30, (A3) also holds when $G = M$ and $G = M'$. Because M' differs from M only in C , which is replaced by C' , we have $d_M(x, u) = d_{M'}(x, u)$ and $d_M(v, y) = d_{M'}(v, y)$. We also have $d_M(u, v) = d_{M'}(u, v)$ because C' is the mixed representation of the 4-sunlet C . Therefore $d_M(x, y) = d_{M'}(x, y)$. \square

References

- [1] Folk, R.A., Soltis, P.S., Soltis, D.E., Guralnick, R.: New prospects in the detection and comparative analysis of hybridization in the tree of life. *American Journal of Botany* **105**(3), 364–375 (2018). <https://doi.org/10.1002/ajb2.1018>

- [2] Blair, C., Ané, C.: Phylogenetic trees and networks can serve as powerful and complementary approaches for analysis of genomic data. *Systematic Biology* **69**(3), 593–601 (2020). <https://doi.org/10.1093/sysbio/syz056>
- [3] Solís-Lemus, C., Ané, C.: Inferring phylogenetic networks with maximum pseudolikelihood under incomplete lineage sorting. *PLOS Genetics* **12**(3), 1005896 (2016). <https://doi.org/10.1371/journal.pgen.1005896>
- [4] Cao, Z., Liu, X., Ogilvie, H.A., Yan, Z., Nakhleh, L.: Practical aspects of phylogenetic network analysis using phylonet. *bioRxiv* (2019). <https://doi.org/10.1101/746362>
- [5] Rabier, C.-E., Berry, V., Stoltz, M., Santos, J.D., Wang, W., Glaszmann, J.-C., Pardi, F., Scornavacca, C.: On the inference of complex phylogenetic networks by Markov chain Monte-Carlo. *PLOS Computational Biology* **17**, 1–39 (2021). <https://doi.org/10.1371/journal.pcbi.1008380>
- [6] Bryant, D., Moulton, V.: Neighbor-net: An agglomerative method for the construction of phylogenetic networks. *Molecular Biology and Evolution* **21**(2), 255–265 (2004). <https://doi.org/10.1093/molbev/msh018>
- [7] Saitou, N., Nei, M.: The neighbor-joining method: a new method for reconstructing phylogenetic trees. *Molecular Biology and Evolution* **4**(4), 406–425 (1987). <https://doi.org/10.1093/oxfordjournals.molbev.a040454>
- [8] Desper, R., Gascuel, O.: Theoretical foundation of the balanced minimum evolution method of phylogenetic inference and its relationship to weighted least-squares tree fitting. *Molecular Biology and Evolution* **21**(3), 587–598 (2004). <https://doi.org/10.1093/molbev/msh049>
- [9] Rusinko, J., McPartlon, M.: Species tree estimation using neighbor joining. *Journal of Theoretical Biology* **414**, 5–7 (2017). <https://doi.org/10.1016/j.jtbi.2016.11.005>
- [10] Semple, C., Steel, M.: *Phylogenetics*. Oxford lecture series in mathematics and its applications 24. Oxford University Press, Oxford (2003)
- [11] Bordewich, M., Huber, K.T., Moulton, V., Semple, C.: Recovering normal networks from shortest inter-taxa distance information. *Journal of Mathematical Biology* **77**(3), 571–594 (2018). <https://doi.org/10.1007/s00285-018-1218-x>
- [12] Chang, K.-Y., Cui, Y., Yiu, S.-M., Hon, W.-K.: Reconstructing one-articulated networks with distance matrices. In: Cai, Z., Daescu, O., Li, M. (eds.) *Bioinformatics Research and Applications*, pp. 34–45. Springer, Cham (2017)

- [13] Bordewich, M., Semple, C.: Determining phylogenetic networks from inter-taxa distances. *Journal of Mathematical Biology* **73**(2), 283–303 (2016). <https://doi.org/10.1007/s00285-015-0950-8>
- [14] Bordewich, M., Tokac, N.: An algorithm for reconstructing ultrametric tree-child networks from inter-taxa distances. *Discrete Applied Mathematics* **213**, 47–59 (2016). <https://doi.org/10.1016/j.dam.2016.05.011>
- [15] Bordewich, M., Semple, C., Tokac, N.: Constructing tree-child networks from distance matrices. *Algorithmica* **80**(8), 2240–2259 (2018). <https://doi.org/10.1007/s00453-017-0320-6>
- [16] Allman, E.S., Baños, H., Rhodes, J.A.: Identifiability of species network topologies from genomic sequences using the logDet distance. *Journal of Mathematical Biology* **84**(5), 35 (2022). <https://doi.org/10.1007/s00285-022-01734-2>
- [17] Willems, M., Tahiri, N., Makarenkov, V.: A new efficient algorithm for inferring explicit hybridization networks following the neighbor-joining principle. *Journal of Bioinformatics and Computational Biology* **12**(05), 1450024 (2014). <https://doi.org/10.1142/s0219720014500243>
- [18] Willson, S.J.: Tree-average distances on certain phylogenetic networks have their weights uniquely determined. *Algorithms for Molecular Biology* **7**(1), 13 (2012). <https://doi.org/10.1186/1748-7188-7-13>
- [19] Willson, S.J.: Reconstruction of certain phylogenetic networks from their tree-average distances. *Bulletin of Mathematical Biology* **75**(10), 1840–1878 (2013). <https://doi.org/10.1007/s11538-013-9872-z>
- [20] Francis, A.R., Steel, M.: Tree-like reticulation networks—when do tree-like distances also support reticulate evolution? *Mathematical Biosciences* **259**, 12–19 (2015). <https://doi.org/10.1016/j.mbs.2014.10.008>
- [21] Chan, H.-L., Jansson, J., Lam, T.-W., Yiu, S.-M.: Reconstructing an ultrametric galled phylogenetic network from a distance matrix. In: Jedrzejowicz, J., Szepietowski, A. (eds.) *Mathematical Foundations of Computer Science 2005*, pp. 224–235. Springer, Berlin, Heidelberg (2005)
- [22] Pardi, F., Scornavacca, C.: Reconstructible phylogenetic networks: Do not distinguish the indistinguishable. *PLOS Computational Biology* **11**(4), 1004135 (2015). <https://doi.org/10.1371/journal.pcbi.1004135>
- [23] Baños, H.: Identifying species network features from gene tree quartets under the coalescent model. *Bulletin of Mathematical Biology* **81**(2), 494–534 (2019). <https://doi.org/10.1007/s11538-018-0485-4>

- [24] Gross, E., Iersel, L.v., Janssen, R., Jones, M., Long, C., Murakami, Y.: Distinguishing level-1 phylogenetic networks on the basis of data generated by markov processes. *CoRR* (2020) <https://arxiv.org/abs/2007.08782> [q-bio.PE]
- [25] Allman, E.S., Baños, H., Rhodes, J.A.: NANUQ: a method for inferring species networks from gene trees under the coalescent model. *Algorithms for Molecular Biology* **14**(1) (2019). <https://doi.org/10.1186/s13015-019-0159-2>
- [26] Steel, M.: *Phylogeny: Discrete and Random Processes in Evolution*, p. 302. Society for Industrial and Applied Mathematics, Philadelphia, PA (2016). <https://doi.org/10.1137/1.9781611974485>
- [27] Francis, A., Moulton, V.: Identifiability of tree-child phylogenetic networks under a probabilistic recombination-mutation model of evolution. *Journal of Theoretical Biology* **446**, 160–167 (2018). <https://doi.org/10.1016/j.jtbi.2018.03.011>
- [28] Fischer, M., Herbst, L., Galla, M., Long, Y., Wicke, K.: Unrooted non-binary tree-based phylogenetic networks. *Discrete Applied Mathematics* **294**, 10–30 (2021). <https://doi.org/10.1016/j.dam.2021.01.005>
- [29] Huber, K.T., Iersel, L.V., Moulton, V., Wu, T.: How much information is needed to infer reticulate evolutionary histories? *Systematic Biology* **64**(1), 102–111 (2014). <https://doi.org/10.1093/sysbio/syu076>
- [30] Gambette, P., Berry, V., Paul, C.: Quartets and unrooted phylogenetic networks. *Journal of Bioinformatics and Computational Biology* **10**(04), 1250004 (2012). <https://doi.org/10.1142/S0219720012500047>
- [31] Gusfield, D., Bansal, V., Bafna, V., Song, Y.S.: A decomposition theory for phylogenetic networks and incompatible characters. *Journal of Computational Biology* **14**(10), 1247–1272 (2007). <https://doi.org/10.1089/cmb.2006.0137>
- [32] Murakami, Y., van Iersel, L., Janssen, R., Jones, M., Moulton, V.: Reconstructing tree-child networks from reticulate-edge-deleted subnetworks. *Bulletin of Mathematical Biology* **81**(10), 3823–3863 (2019). <https://doi.org/10.1007/s11538-019-00641-w>
- [33] Diestel, R.: *Graph Theory*, 5th edition edn. Graduate Texts in Mathematics, vol. 173, p. 447. Springer, Heidelberg (2017). <https://doi.org/10.1007/978-3-662-53622-3>
- [34] Degnan, J.H.: Modeling hybridization under the network multispecies coalescent. *Systematic Biology* **67**(5), 786–799 (2018). <https://doi.org/10.1093/sysbio/sy007>

1093/sysbio/syy040

- [35] Harary, F.: Graph Theory. Addison Wesley series in mathematics. Addison-Wesley, Reading, MA (1971)
- [36] Gross, E., Long, C.: Distinguishing phylogenetic networks. *SIAM Journal on Applied Algebra and Geometry* **2**(1), 72–93 (2018). <https://doi.org/10.1137/17m1134238>
- [37] Liu, L., Yu, L., Pearl, D.K., Edwards, S.V.: Estimating species phylogenies using coalescence times among sequences. *Systematic Biology* **58**(5), 468–477 (2009). <https://doi.org/10.1093/sysbio/syp031>
- [38] Liu, L., Yu, L.: Estimating species trees from unrooted gene trees. *Systematic Biology* **60**(5), 661–667 (2011). <https://doi.org/10.1093/sysbio/syr027>
- [39] Peter, B.M.: Admixture, population structure, and F-statistics. *Genetics* **202**(4), 1485–1501 (2016). <https://doi.org/10.1534/genetics.115.183913>
- [40] Conover, J.L., Karimi, N., Stenz, N., Ané, C., Grover, C.E., Skema, C., Tate, J.A., Wolff, K., Logan, S.A., Wendel, J.F., Baum, D.A.: A Malvaceae mystery: A mallow maelstrom of genome multiplications and maybe misleading methods? *Journal of Integrative Plant Biology* **61**(1), 12–31 (2019). <https://doi.org/10.1111/jipb.12746>
- [41] Karimi, N., Grover, C.E., Gallagher, J.P., Wendel, J.F., Ané, C., Baum, D.A.: Reticulate evolution helps explain apparent homoplasy in floral biology and pollination in baobabs (*adansonia*; Bombacoideae; Malvaceae). *Systematic Biology* **69**(3), 462–478 (2020). <https://doi.org/10.1093/sysbio/syz073>
- [42] Solís-Lemus, C., Yang, M., Ané, C.: Inconsistency of species tree methods under gene flow. *Systematic Biology* **65**(5), 843–851 (2016). <https://doi.org/10.1093/sysbio/syw030>
- [43] Solís-Lemus, C., Coen, A., Ané, C.: On the identifiability of phylogenetic networks under a pseudolikelihood model. arXiv (2020). <https://doi.org/10.48550/arxiv.2010.01758>
- [44] Huson, D.H., Rupp, R., Scornavacca, C.: *Phylogenetic Networks: Concepts, Algorithms and Applications*. Cambridge University Press, Cambridge (2010). <https://doi.org/10.1017/CBO9780511974076>