

COVID-19 Detection in Chest X-ray Images Using Swin-Transformer and Transformer in Transformer

1st Juntao Jiang

College of Control Science and Engineering
Zhejiang University
Hangzhou, China
juntaojiang@zju.edu.cn

2nd Shuyi Lin

Khoury College of Computer Sciences
Northeastern University
Boston, United States
lin.shuyi@northeastern.edu

Abstract—The Coronavirus Disease 2019 (COVID-19) has spread globally and caused serious damage. Chest X-ray images are widely used for COVID-19 diagnosis, and the Artificial Intelligence method can increase efficiency and accuracy. In the Challenge of Chest XR COVID-19 detection in Ethics and Explainability for Responsible Data Science (EE-RDS) conference 2021, we proposed a method that combined Swin Transformer and Transformer in Transformer to classify chest X-ray images as three classes: COVID-19, Pneumonia, and Normal (healthy) and achieved 0.9475 accuracies on the test set.

Index Terms—COVID-19, Chest X-ray Images, Swin-Transformer, Transformer in Transformer, Model Ensemble, Image Classification

I. INTRODUCTION

The Coronavirus Disease 2019 (COVID-19), caused by the severe acute respiratory syndrome coronavirus-2 (SARS-CoV-2, 2019-nCoV), has become a global pandemic and brought unprecedented damage seriously worldwide. As Chest X-ray tests typically have a high sensitivity diagnosis of COVID-19 [1], [2], Chest X-ray images can be used for not only following up on the effects of COVID-19 on lung tissue but also for early detection of COVID-19; thus the immediate isolation and treatment for the suspected can be achieved.

Past years witnessed the growing use of AI techniques, especially deep-learning-based methods, in disease detection on chest X-ray images [3]–[6], successfully increasing the accuracy and efficiency for early diagnosis. After the pandemic outbreak, many approaches have also been proposed to detect COVID-19 in chest X-ray images. Shervin Minaee et al. [7] trained four state-of-the-art convolutional networks for COVID-19 detection on a dataset of around 5000 X-ray images and achieved higher than 90 percent of sensitivity and specificity rate. Asif IqbalKhan et al. [8] designed a deep convolutional neural network model based on Xception architecture to classify Normal, Pneumonia-bacterial, Pneumonia-viral, and COVID-19 chest X-ray images. Linda Wang et al. [9] introduced a deep convolutional neural network called COVID-Net to detect COVID-19 cases from chest X-ray images, which is open source and available to the general public. Rachna Jain et al. [10] used Inception net V3, Xception net and ResNeXt to classify. Sanhita Basu et al. [11] gave a new concept called domain extension transfer learning (DETL) with the pre-trained deep convolutional neural network on a

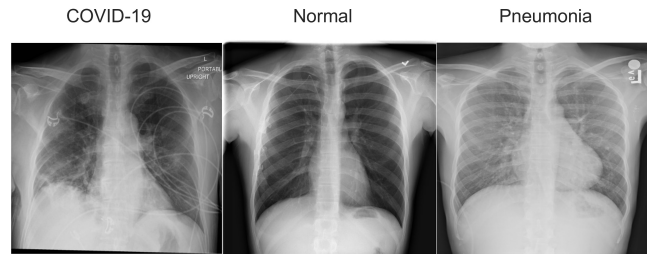

Fig. 1: Example Chest X-ray Images for classes of COVID-19, Normal and Pneumonia

related large chest X-Ray dataset. We can conclude that the fundamental idea for most current methods is based on multi-convolutional neural networks and transfer learning from a large dataset.

Special attention should be paid to the fact that Transformer methods have recently outperformed convolutional neural networks in some datasets of different scenes. Swin Transformer [12] and Transformer in Transformer [13] are successful works in adapting Transformer from language to vision and achieved state-of-the-art in different tasks. Still, we haven't seen a lot of applications in chest X-ray image classification and COVID-19 detection. This paper is a technical report in Chest XR COVID-19 Detection Challenge [14], a part of Ethics and Explainability for Responsible Data Science (EE-RDS) conference. We combine Swin-transformer and Transformer in Transformer to classify chest X-ray images into three classes, COVID-19, Pneumonia, and Normal (healthy), on the dataset offered by the challenge organizers and achieve 0.9475 accuracies on the test set.

II. INTRODUCTION TO THE DATASET AND THE TASK

The dataset of this challenge contains three parts, which are used to train, validate and test, respectively:

- Train = 17,955 chest X-ray images
- validation = 3,430 chest X-ray images
- test = 1,200 chest X-ray images

This dataset has three types of chest X-ray images: COVID-19, Pneumonia, and Normal (healthy). The example of three classes are shown in Figure 1.

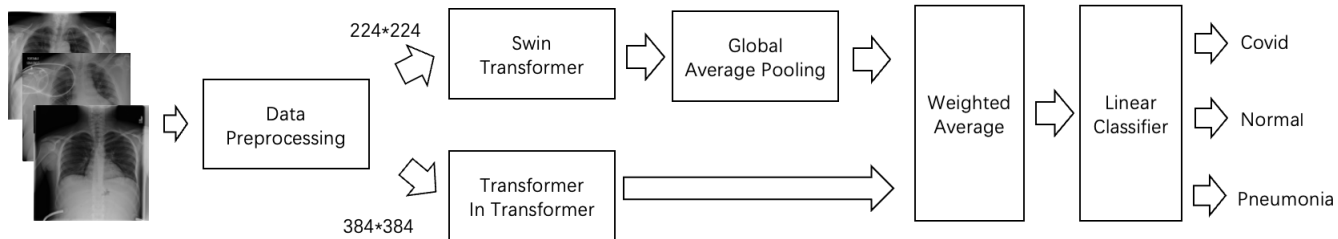

Fig. 2: Workflow for Chest X-ray Images Classification with Swin Transformer and Transformer in Transformer

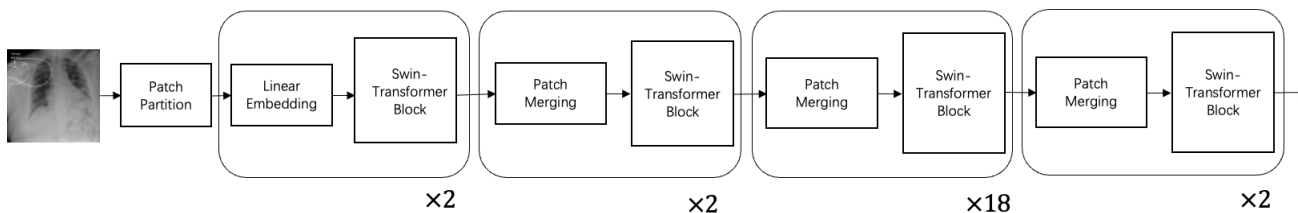

Fig. 3: The architecture of Swin-Transformer (Swin-B)

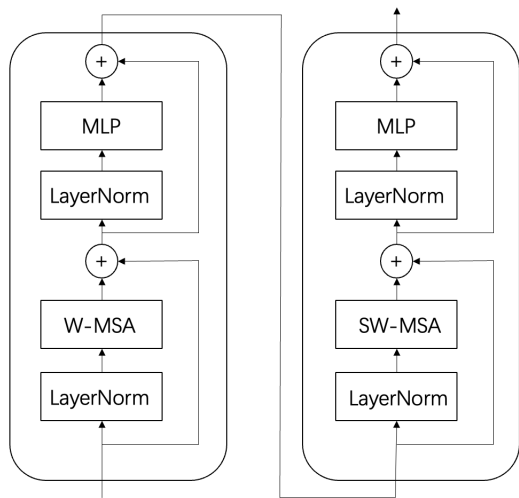

Fig. 4: Two successive Swin Transformer Blocks, where W-MSA and SW-MSA are multi-head self-attention modules with regular and shifted windowing configurations, respectively.

Our task is to design an algorithm to auto-classify chest X-ray images into these three classes.

III. METHODS

The workflow of our classification method is shown in Figure 3. We trained the Swin Transformer and Transformer

in Transformer separately and did results ensemble using weighted average methods.

A. Data Preprocessing

The workflow of our Preprocessing method for training is shown in figure 3, and the workflow of our Preprocessing method for training is shown in figure 4.

Firstly we resized the images to a certain scale ($224*224$ or $384*384$), then applied random flipping, then selected a policy from rotation, translation horizontally or vertically, and then applied random erasing. Finally, we did the normalization. All these changes are applied with a small probability.

Unlike natural images, the overall characteristics of medical images are significant to classify, so we avoid using crop or center crop as data augmentation methods. We only use horizontal flipping, and the rotation or translation augmentation methods are also controlled within a small range.

We did not use preprocessing methods related to brightness or contrast to avoid destroying the difference between the three classes.

B. Models

1) *Swin Transformer*: Swin Transformer [12] constructs hierarchical feature maps to better model objects of different sizes and has linear computational complexity to image size. Swin Transformer has different types according to the models' size and we selected Swin-B for the task. The architecture of Swin-B is shown in Figure 3.

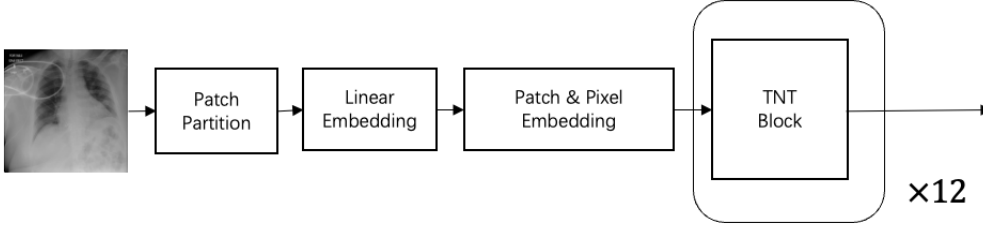

Fig. 5: The architecture of Transformer in Transformer (TNT-S)

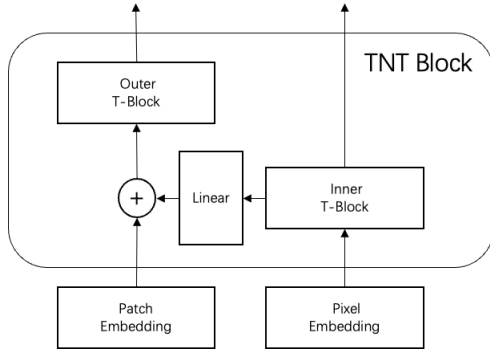

Fig. 6: The architecture of TNT block

As shown in Figure 4, a Swin Transformer block utilizes a shifted window-based Multi-head Self-Attention (SW-MSA) module, followed by a 2-layer MLP with GELU nonlinearity in between. A LayerNorm layer is applied before each MSA module and MLP, and a residual connection is applied.

2) *Transformer in Transformer*: Transformer in Transformer (TNT) [13], which regards the local patches as "visual sentences" and then presents to further divide them into smaller patches as "visual words," and features of both words and sentences will be aggregated to improve the representation ability, thus the patch-level and pixel-level representations can be modeled.

Transformer in Transformer has different types according to the models' size, and we selected the Transformer in Transformer small for the task. The larger models should have better performance, but we failed to try them due to the time limitation. The architecture of Transformer in Transformer small (TNT-S) is shown in Figure 5, which consists of 12 TNT blocks. The architecture of a TNT block is shown in Figure 6.

C. Training Setting

Training settings. Our implementation is based on PyTorch [15], mmclassification [16], and one NVIDIA Tesla-V100 GPU is used for training. Model training is done using the

TABLE I: Results for Image Classification

Models	Weights	Accuracy
Swin Transformer		0.9467
Swin Transformer, TNT	1:1	0.9467
Swin Transformer, TNT	2:1	0.9475

AdamW, and the initial learning rate, batch size, and weight decay are set to 0.001, 64, and 0.05, respectively. For the learning rate scheduler, cosine annealing [17] and warmup [18] are used. We also applied label smoothing in the loss.

In training for Swin Transformer, the input image size is 224*224. For Transformer in Transformer, the input image size is 384*384. The design is due to the limitation of computation power, and also for convenience to use the pre-trained model directly from ImageNet [19].

D. Ensemble

We obtain the probabilities for each class from two models, then calculate the weighted average for these probabilities. Finally, a linear classifier was used to get the final results for classification.

IV. EXPERIMENTS AND RESULTS

We train the two models on the training set and validate them on the validation set. Then we select the best model on the validation set to infer on the test set.

Due to the time limitation, the experiments are not enough for thorough comparison but may still give some information for further research. The experimental results are shown in Table 1.

More specifically, our final results are:

- Accuracy Score: 0.9475,
- Sensitivity Score: 0.9475
- Specificity Score: 0.9509

Our results rank ten on the leaderboard for this challenge.

V. CONCLUSION

In this paper, we applied Swin Transformer and Transformer in Transformer to classify the chest X-ray images in In the Challenge of Chest XR COVID-19 detection. We did a model ensemble by using the weighted average method. We achieved 0.9475 accuracies on the test set and ranked ten on the leaderboard.

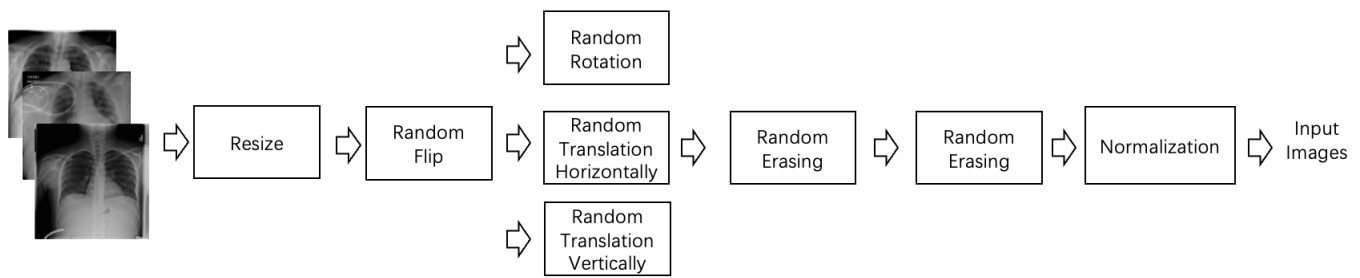

Fig. 7: Data Preprocessing in Training

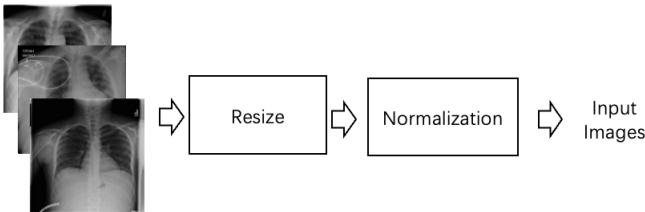

Fig. 8: Data Preprocessing in Testing

REFERENCES

- [1] Heshui Shi, Xiaoyu Han, Nanchuan Jiang, Yukun Cao, Osamah Alwalid, Jin Gu, Yanqing Fan, Chuansheng Zheng, Radiological findings from 81 patients with COVID-19 pneumonia in Wuhan, China: a descriptive study, *The Lancet Infectious Diseases*, 2020, Pages 425-434
- [2] T. Ai, Z. Yang, H. Hou, C. Zhan, C. Chen, W. Lv, Q. Tao, Z. Sun, L. Xia Correlation of chest CT and RT-PCR testing in coronavirus disease 2019 (COVID-19) in China: a report of 1014 cases, *Radiology* (2020), 10.1148/radiol.2020200642
- [3] Y. Dong, Y. Pan, J. Zhang, W. Xu, Learning to read chest X-ray images from 16000+ examples using CNN Proceedings, 2017 IEEE/ACM International Conference on Connected Health: Applications, Systems and Engineering Technologies, IEEE (2017), pp. 51-57
- [4] P. Rajpurkar, J. Irvin, R.L. Ball, K. Zhu, B. Yang, H. Mehta, ..., B.N. Patel, Deep learning for chest radiograph diagnosis: A retrospective comparison of the CheXNeXt algorithm to practicing radiologists, *PLoS Medicine*, 15 (11) (2018)
- [5] V. Chouhan, S.K. Singh, A. Khamparia, D. Gupta, P. Tiwari, C. Moreira, ..., V.H.C. de Albuquerque, A novel transfer learning based approach for pneumonia detection in chest X-ray images, *Applied Sciences*, 10 (2) (2020)
- [6] C. Liu, Y. Cao, M. Alcantara, B. Liu, M. Brunette, J. Peinado, W. Curioso, TX-CNN: Detecting tuberculosis in chest X-ray images using convolutional neural network 2017 IEEE international conference on image processing (ICIP), IEEE (2017), pp. 2314-2318.
- [7] Shervin Minaee, Rahele Kafieh, Milan Sonka, Shakib Yazdani, Ghazaleh Jamalipour Soufi, Deep-COVID: Predicting COVID-19 from chest X-ray images using deep transfer learning, *Medical Image Analysis*, Volume 65, 2020
- [8] Asif Iqbal Khan, Junaid Latief Shah, Mohammad Mudasir Bhat, CoroNet: A deep neural network for detection and diagnosis of COVID-19 from chest x-ray images, *Computer Methods and Programs in Biomedicine*, Volume 196, 2020
- [9] Wang, L., Lin, Z.Q., Wong, A. COVID-Net: a tailored deep convolutional neural network design for detection of COVID-19 cases from chest X-ray images. *Sci Rep* 10, 19549 (2020).
- [10] Jain, R., Gupta, M., Taneja, S. et al, Deep learning based detection and analysis of COVID-19 on chest X-ray images. *Appl Intell* 51, 1690–1700 (2021).
- [11] S. Basu, S. Mitra and N. Saha, Deep Learning for Screening COVID-19 using Chest X-Ray Images, 2020 IEEE Symposium Series on Computational Intelligence (SSCI), 2020, pp. 2521-2527.
- [12] Ze Liu, Yutong Lin, Yue Cao, Han Hu, Yixuan Wei, Zheng Zhang, Stephen Lin, Baining Guo, Swin Transformer: Hierarchical Vision Transformer using Shifted Windows, arXiv:2103.14030
- [13] Kai Han, An Xiao, Enhua Wu, Jianyuan Guo, Chunjing Xu, Yunhe Wang, Transformer in Transformer, arXiv:2103.00112
- [14] Akhloufi, Moulay A. and Chetoui, Mohamed, Chest XR COVID-19 detection, <https://cxr-covid19.grand-challenge.org/>, August, 2021
- [15] Adam Paszke, Sam Gross, Francisco Massa, Adam Lerer, James Bradbury, Gregory Chanan, Trevor Killeen, Zeming Lin, Natalia Gimelshein, Luca Antiga, Alban Desmaison, Andreas Köpf, Edward Yang, Zach DeVito, Martin Raison, Alykhan Tejani, Sasank Chilamkurthy, Benoit Steiner, Lu Fang, Junjie Bai, Soumith Chintala, PyTorch: An Imperative Style, High-Performance Deep Learning Library, NeurIPS 2019
- [16] MMClassification Contributors, OpenMMLab's Image Classification Toolbox and Benchmark, <https://github.com/open-mmlab/mmlclassification>, 2020
- [17] I. Loshchilov and F. Hutter. SGDR: stochastic gradient descent with warm restarts. ICLR, 2017.
- [18] Kaiming He, Xiangyu Zhang, Shaoqing Ren, Jian Sun, Deep Residual Learning for Image Recognition, arXiv:1512.03385
- [19] J. Deng, W. Dong, R. Socher, L. Li, Kai Li and Li Fei-Fei, ImageNet: A large-scale hierarchical image database, 2009 IEEE Conference on Computer Vision and Pattern Recognition, 2009