

Bag-of-Vectors Autoencoders for Unsupervised Conditional Text Generation

Florian Mai

Idiap Research Institute / EPFL
Rue Marconi 19, 1920 Martigny
Switzerland
florian.mai@idiap.ch

James Henderson

Idiap Research Institute
Rue Marconi 19, 1920 Martigny
Switzerland
james.henderson@idiap.ch

Abstract

Text autoencoders are often used for unsupervised conditional text generation by applying mappings in the latent space to change attributes to the desired values. Recently, [Mai et al. \(2020\)](#) proposed Emb2Emb, a method to *learn* these mappings in the embedding space of an autoencoder. However, their method is restricted to autoencoders with a single-vector embedding, which limits how much information can be retained. We address this issue by extending their method to *Bag-of-Vectors Autoencoders* (BoV-AEs), which encode the text into a variable-size bag of vectors that grows with the size of the text, as in attention-based models. This allows to encode and reconstruct much longer texts than standard autoencoders. Analogous to conventional autoencoders, we propose regularization techniques that facilitate learning meaningful operations in the latent space. Finally, we adapt Emb2Emb for a training scheme that learns to map an input bag to an output bag, including a novel loss function and neural architecture. Our empirical evaluations on unsupervised sentiment transfer show that our method performs substantially better than a standard autoencoder.

1 Introduction

In conditional text generation, we would like to produce an output text given an input text. Hence, parallel input-output pairs are required to train a good supervised machine learning model on this type of task. Large-scale pretraining ([Peters et al., 2018](#); [Devlin et al., 2019](#); [Lewis et al., 2020](#)) can alleviate the necessity for training examples to some extent, but even this requires a substantial number of annotations ([Yogatama et al., 2019](#)). This is an expensive process and can introduce unwanted artifacts itself, which are henceforth learned by the model ([Gururangan et al., 2018](#)). For these reasons, there is substantial interest in unsupervised solutions. *Text autoencoders* (AEs) don't require labeled data for training, and are therefore a popular

model for unsupervised approaches to many tasks, such as machine translation ([Artetxe et al., 2018](#)), sentence compression ([Férvy and Phang, 2018](#)) and sentiment transfer ([Shen et al., 2017](#)). The classical text AE ([Bowman et al., 2016](#)) embeds the input text into a single fixed-size vector via the encoder, and then tries to reconstruct the input text from the single vector via the decoder. Single-vector embeddings are very useful, because they allow to perform conditional text generation through simple mappings in the embedding space, e.g. by adding a constant offset vector to change attributes such as sentiment ([Shen et al., 2020](#)). Recently, [Mai et al. \(2020\)](#) proposed Emb2Emb, a method that can *learn* these mappings directly in the embedding space of any pretrained single-vector AE. This is a powerful framework, because the AE can then be pretrained on unlimited amounts of unlabeled data before applying it to any downstream application. This concept, *transfer learning*, is arguably one of the most important drivers of progress in machine learning in the recent decade: These so-called *Foundation Models* ([Bommasani et al., 2021](#)) have revolutionized natural language understanding (e.g. *BERT* ([Devlin et al., 2019](#))) and computer vision (e.g. *DALL-E* ([Ramesh et al., 2021](#))), among others. Since Emb2Emb was designed to work with any pretrained AE, it was an important step towards their *scalability*.

However, as [Bommasani et al. \(2021\)](#) point out, another crucial model property is *expressivity*, the ability to represent the data distribution it is trained on. In this regard, single-vector representations are fundamentally limited; they act as a bottleneck, causing the model to increasingly struggle to encode longer text ([Bahdanau et al., 2015](#)). In this paper, we extend conditional text generation methods from single-vector bottleneck AEs to *Bag-of-Vector Autoencoders* (BoV-AEs), which encode text into a variable-size representation where the number of vectors grows with the length of the text. This

gives BoV-AEs the same kind of representations as attention-based models. But this added expressivity comes with additional challenges: First, it can more easily overfit, leading to a non-smooth embedding space that is difficult to learn in. Secondly, as illustrated in Figure 1, in the single-vector case, an operation Φ in the vector space consists of a simple vector-to-vector mapping, and a single-vector loss. But with BoV-AEs, Φ needs to map a bag of vectors onto another bag of vectors, for which the single-vector mapping and loss are not applicable. In this paper, we demonstrate how such a mapping can be learned in the context of the Emb2Emb framework by making the following novel contributions: (i) We propose a regularization scheme for BoV-AEs, (ii) a neural mapping architecture Φ for Emb2Emb, and (iii) a suitable training loss.

Empirically, we show on two unsupervised sentiment transfer datasets (Shen et al., 2017) of drastically different text lengths that BoV-AEs perform substantially better than standard AEs if the text is too long to be captured by one vector alone. Our ablation studies confirm that our technical contributions are crucial for this success.

In the following section, we review the Emb2Emb framework, before we introduce BoV-AE (Section 3) and its integration within Emb2Emb (Section 4).

2 Background: Emb2Emb

Embedding-to-Embedding (Emb2Emb) (Mai et al., 2020) is a general framework for both supervised and an unsupervised conditional text generation. The core idea is to disentangle the specific task from the transition from the discrete text space to a continuous latent space (*plug and play*), allowing for larger-scale pretraining with unlabeled data.

The workflow of the framework is depicted in Figure 2. First, a text AE $\mathcal{A} = \text{dec} \circ \text{enc}$ is trained to map an input sentence from the discrete text space \mathcal{X} to an embedding space \mathcal{Z} via the encoder $\text{enc} : \mathcal{X} \rightarrow \mathcal{Z}$, and back to \mathcal{X} via a decoder $\text{dec} : \mathcal{Z} \rightarrow \mathcal{X}$, such that $\mathcal{A}(x) = x$, typically trained via negative log-likelihood, $\mathcal{L}_{rec} = \text{NLL}(\mathcal{A}(x), x)$. In contrast to other methods, \mathcal{A} can in principle be any AE, opening the possibility for large-scale AE pretraining with unlabeled data. Second, task-specific training is performed only in the embedding space \mathcal{Z} of the AE. To this end, the encoder is frozen, and a new mapping layer $\Phi : \mathcal{Z} \rightarrow \mathcal{Z}$ is introduced, which is trained to transform the

embedding of the input \mathbf{z}_x into the embedding of the predicted output $\hat{\mathbf{z}}_y$. The concrete loss $\mathcal{L}(\hat{\mathbf{z}}_y)$ depends on the type of task. In the supervised case, the true output is also encoded into space \mathcal{Z} , and the distance between the true embedding and the predicted embedding is minimized. In the unsupervised case, the loss needs to be defined for the specific task at hand. For example, for sentiment transfer, where the goal is to transform a negative review into a positive review while retaining as much of the input as possible, Mai et al. (2020) compose the loss as a combination of two loss terms¹, $\mathcal{L}(\hat{\mathbf{z}}_y) = \mathcal{L}_{sim}(\mathbf{z}_x, \hat{\mathbf{z}}_y) + \lambda_{sty} \mathcal{L}_{sty}(\hat{\mathbf{z}}_y)$. \mathcal{L}_{sty} encourages $\hat{\mathbf{z}}_y$ to be classified as a positive review according to a separately trained sentiment classifier. \mathcal{L}_{sim} encourages the output to be close to the input in embedding space, e.g. via euclidean distance. λ_{sty} is a hyperparameter that controls the importance of changing the sentiment of the predicted output.

A main question in Emb2Emb is how to choose the embedding space \mathcal{Z} . Mai et al. (2020) use a single continuous vector to encode all the information of the input, i.e. $\mathcal{Z} = \mathbb{R}^d$. This choice simplifies the mapping Φ to an MLP and the training loss to vector space distances, which is relatively easy to train. On the other hand, it limits the model in fundamental ways: The representation is *fixed-sized*, i.e., the representation cannot grow in size. Sequence-to-sequence models with a fixed-size bottleneck struggle to encode long text sequences (Bahdanau et al., 2015), which is a key reason why attention-based models are now standard practice in sequence-to-sequence models. Hence, it would be desirable to adapt Emb2Emb in such a way that \mathcal{Z} contains *variable-sized* embeddings instead.

3 Bag-of-Vectors Autoencoder

We propose *Bag-of-Vectors Autoencoders* (BoV-AEs) which facilitate learning mappings in the embedding space. Following the naming convention by Henderson (2020), we refer to a bag of vectors as a (multi)-set of vectors that (i) can grow arbitrarily large, and (ii) where the elements are not ordered (a basic property of sets). A type of BoV representation that is used very commonly is found in Transformer (Vaswani et al., 2017)

¹Their total loss includes an adversarial component that encourages the outputs of the mapping to stay on the latent space manifold. We leave adaptation of this component to the BoV scenario for future work.

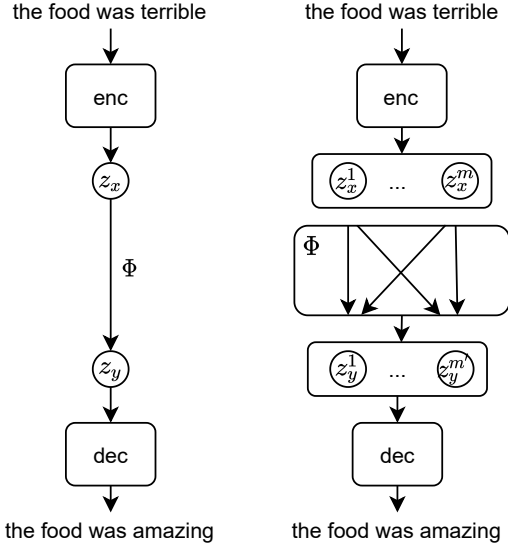

Figure 1: *Left*: In the standard setup, the representation consists of a single vector, requiring a simple vector-to-vector mapping to do operations in the vector space. *Right*: In BoV-AE, the representation consists of a variable-size bag of vectors, requiring a more complex mapping from one bag to another bag.

encoder-decoder models, where there is one vector to represent each token of the input text, and the order of the vectors does not matter when the decoder accesses the output of the encoder. In this work, we also rely on Transformer models as the backbone of our encoders and decoders. However, in principle, any encoder and decoder can be used, as long as the encoder produces a bag as output and the decoder takes a bag as input. Formally, $\mathcal{Z} = (\mathbb{R}^d)^+$, so the encoder produces a bag-of-vectors $\mathbb{X} = \{\mathbf{z}_1, \dots, \mathbf{z}_n\} := \text{enc}(x)$, where n is the number of vectors in the induced input bag.

3.1 Regularization

The fact that we use a BoV-based AE presents a major challenge: AEs have to be regularized to prevent them from learning a simple identity mapping where the input is merely copied to the output, which does not result in a meaningful embedding space. In fixed-size embeddings, this is for example achieved through under-completeness (choosing a latent dimension that is smaller than the input dimension) or through injection of noise, either at the input or in the embedding space. While there exists a lot of research on regularizing fixed-sized AEs, it is not clear how to achieve the same goal in a BoV-AE. Here, regularizing the capacity of each vector is not enough. As long as each vector can

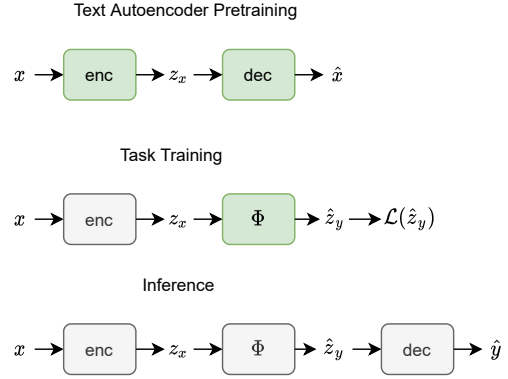

Figure 2: High-level view of the Emb2Emb framework. *Text Autoencoder Pretraining*: An autoencoder is trained on an unlabeled corpus, i.e., the encoder enc transforms an input text x into a continuous embedding \mathbf{z}_x , which is in turn used by the decoder dec to predict a reconstruction \hat{x} of the input sentence. *Task Training*: The encoder is frozen (grey), and a mapping Φ is trained (green) on input embeddings \mathbf{z}_x to output predictions $\hat{\mathbf{z}}_y$ such that it minimize some loss $\mathcal{L}(\hat{\mathbf{z}}_y)$. *Inference*: To obtain textual predictions \hat{y} , the encoder is composed with Φ and the decoder.

store a (constant) positive amount of information, a bag of unlimited size can still store infinite information. However, it is not clear to what extent the size of the bag needs to be restricted. By default, a standard Transformer model produces as many vectors as there are input tokens, but this is likely too many, as it makes copying from the input to the output trivial. Hence, we want the encoder to output fewer vectors. In the following we explain how this is achieved in BoV-AEs.

Ideally, we want the model to decide for itself on a per-example basis which vectors it needs to retain for reconstruction. To this end, we adopt *LODrop*, a differentiable approximation to L0 regularization, which was originally developed by [Zhang et al. \(2021\)](#) for the purpose of speeding up a model through sparsification. The model computes scalar gates $g_i = g(\mathbf{z}_i) \in [0, 1]$ (which can be exactly zero or one) for each encoder output. After the gates are computed, we multiply them with their corresponding vector. Vectors whose gates are near zero (i.e., smaller than some $\epsilon > 0$) are removed from the bag entirely. An additional loss term, $\mathcal{L}_{L_0}(\mathbb{X}) = \lambda_{L_0} \sum_i g_i$ encourages the model to close as many gates as possible, where the hyperparameter λ_{L_0} controls the sparsity rate *implicitly*. However, in initial experiments, we found λ_{L_0} difficult to tune, as it is very sensitive with respect to

other hyperparameters. We instead employ a modified loss that seeks to *explicitly* match a certain target ratio r of open gates. Similar to the *free-bits* objective that is used to prevent the posterior collapse problem in VAEs (Kingma et al., 2016), the objective becomes

$$\mathcal{L}_{L_0}(\mathbb{X}) = \lambda_{L_0} \max(r, \frac{1}{n} \sum_i^n g_i). \quad (1)$$

By setting λ_{L_0} to a large enough value (empirically, $\lambda_{L_0} = 10$), we find that this objective reaches the target ratio r reliably for different r while at the same time reducing the reconstruction loss. This allows to compare different strengths of regularization while reducing the tuning effort substantially.

4 Emb2Emb with BoV-AEs

In the following we describe how to adapt the Emb2Emb model to BoV-AEs, i.e., how to generate an output bag $\hat{\mathbb{X}} = \{\hat{\mathbf{z}}_1, \dots, \hat{\mathbf{z}}_n\}$ given an input bag \mathbb{X} through the mapping $\Phi(\mathbb{X})$, and how to choose the loss function $\mathcal{L}(\hat{\mathbb{X}}, \mathbb{X})$. For example, in the case of style transfer, we want $\hat{\mathbb{X}}$ to be similar to \mathbb{X} .

4.1 Mapping Φ

In contrast to Mai et al. (2020), who use a single-vector embedding and hence Φ can be as simple as an MLP, in our work, Φ must be capable of producing a bag of vectors. The straight-forward choice for Φ is a Transformer decoder that uses cross-attention on the input BoV, and generates vectors autoregressively one at a time, formally $\hat{\mathbf{z}}_t = \text{Transformer}(\mathbf{z}_s, \hat{\mathbf{z}}_1, \dots, \hat{\mathbf{z}}_{t-1}, \mathbb{X})$, $t \geq 1$, where \mathbf{z}_s is the embedding of some starting symbol. Since the resulting sequence of vectors is still interpreted as a bag by the decoder and loss function, the ordering is irrelevant, but generating vectors autoregressively facilitates modelling the correlations between vectors.

Depending on the difficulty of the task, a generic Transformer decoder may be sufficient to learn the mapping, but for more difficult mappings and for larger bags (i.e. longer texts) appropriate inductive biases are needed. Based on the assumption that the output should be close to the input in embedding space, Mai et al. (2020) propose *OffsetNet* for the single vector case, which computes an offset vector to be added to the input. With a similar motivation, we propose a variant of pointer-generator networks (See et al., 2017), which allows the model to choose between copying an input vector and

generating a new one. Instead of just copying, however, our model (Transformer++) allows to compute an offset vector to be added to the copied vector, analogous to (Mai et al., 2020). Formally, at each timestep t ,

$$\hat{\mathbf{z}}_t = (1 - p_{gen})(\mathbf{z}_{copy} + \mathbf{z}_{offset}) + p_{gen}\mathbf{z}'_t, \quad (2)$$

where $\mathbf{z}'_t = \text{Transformer}(\mathbf{z}_s, \dots, \hat{\mathbf{z}}_{t-1}, \mathbb{X})$. Intuitively, by controlling $p_{gen} \in (0, 1)$, the model makes the (soft) decision to either copy a vector from the input and add an offset, or to generate a completely new vector. Here, p_{gen} is a function of \mathbf{z}'_t and the starting symbol which we treat as a context vector, $p_{gen} = \sigma(\mathbf{W}[\mathbf{z}_s; \mathbf{z}'_t])$. Similarly, \mathbf{z}_{offset} is a one-layer MLP with $[\mathbf{z}'_t; \mathbf{z}_{copy}]$ as input. \mathbf{z}_{copy} is determined through an attention function:

$$\mathbf{z}_{copy} = \sum_{i=1}^{|\mathbb{X}|} \alpha_i \mathbf{z}_i, \quad \mathbf{K} = \mathbf{W}_{copy} \mathbf{X}, \quad (3)$$

$$\alpha_i = \text{softmax}(\mathbf{z}'_t \mathbf{K})_i, \quad (\mathbf{X})_i := \mathbf{z}_i \quad (4)$$

where \mathbf{W}_{copy} is a learnable weight matrix. We refer to this model as Transformer++.

4.2 Generating Variable Sized Bags

The output bag is generated in an autoregressive manner. In the unsupervised case, it is not always clear how many vectors the bag should contain. However, due to the unsupervised nature, all information needed for computing the (task-dependent) training loss $\mathcal{L}(\hat{\mathbb{X}}, \mathbb{X})$ are also available at inference time. In this case, we can first generate some fixed maximum number N of vectors autoregressively, and then determine the optimal bag by computing the minimal (inference-time) loss value, $\mathbb{X}^* = \min_{l=1, \dots, N} \mathcal{L}(\hat{\mathbb{X}}_{1:l}, \mathbb{X})$. This can be valuable for tasks where we do not have a good prior on the size of the target bag. During training, we minimize the loss locally at every step. But we don't necessarily care about the loss at very small or big bags, so we might want to weight the steps as $\mathcal{L}^{\text{total}}(\hat{\mathbb{X}}, \mathbb{X}) = \sum_{l=1}^N \mathbf{w}_l \mathcal{L}(\hat{\mathbb{X}}_{1:l}, \mathbb{X})$. Here, $\mathbf{w} \in \mathbb{R}_+^N$ could be any weighting, but it is more beneficial for training to only backpropagate from bag sizes that we expect to be close to the optimal output bag size. For instance, in style transfer, the output typically has about the same length as the input. Hence, for an input size of length n , a useful weighting could be

$$\mathbf{w}_l = \begin{cases} 1 & n - k \leq l \leq n + k \\ 0 & \text{otherwise} \end{cases}, \quad (5)$$

where k is the size of a window around the input bag size.

4.3 Aligning Two Bags of Vectors

As described in Section 2, unsupervised sentiment transfer involves two loss terms, \mathcal{L}_{sty} and \mathcal{L}_{sim} . In order to adapt \mathcal{L}_{sty} from the single vector case to the BoV case, we can simply switch from an MLP classifier to a Transformer-based classifier. For \mathcal{L}_{sim} , however, we need to switch to a loss function that is defined on sets. While there are well-known losses for the single-vector case, in NLP set-level loss functions are not well-studied.

Here, we propose a novel variant of the *Hausdorff* distance. This distance is commonly used in vision applications: as a performance evaluation metric in e.g. medical image segmentation (Taha and Hanbury, 2015; Aydin et al., 2020), or in vision systems as a way to compare images (Huttenlocher et al., 1992; Takács, 1998; Lin et al., 2003; Lu et al., 2001). More recently, variants (different from ours) of the Hausdorff distance have also been used as loss functions to train neural networks (Fan et al., 2017; Ribera et al., 2019; Zhao et al., 2021). In NLP, its use is very rare (Nutanong et al., 2016; Chen, 2019; Kuo et al., 2020). To the best of our knowledge, our paper is the first to present a novel, fully differentiable variant of the Hausdorff distance as a loss for language learning.

The Hausdorff distance is a method for aligning two sets. Given two sets \mathbb{X} and $\hat{\mathbb{X}}$, their Hausdorff distance H is defined as

$$H(\mathbb{X}, \hat{\mathbb{X}}) = \frac{1}{2} \text{align}(\mathbb{X}, \hat{\mathbb{X}}) + \frac{1}{2} \text{align}(\hat{\mathbb{X}}, \mathbb{X}) \quad (6)$$

$$\text{align}(\mathbb{X}, \hat{\mathbb{X}}) = \max_{x \in \mathbb{X}} \min_{y \in \hat{\mathbb{X}}} d(x, y) \quad (7)$$

Intuitively, two sets are close if each point in either set has a counterpart in the other set that is close to it according to some distance metric d . We choose d to be the euclidean distance, but in principle any differentiable distance metric could be used (e.g. cosine distance). However, the vanilla Hausdorff distance is very prone to outliers, and therefore often reduced to the *average Hausdorff distance* (Dubuisson and Jain, 1994), where

$$\text{align}(\mathbb{X}, \hat{\mathbb{X}}) = \frac{1}{|\mathbb{X}|} \sum_{x \in \mathbb{X}} \min_{y \in \hat{\mathbb{X}}} d(x, y). \quad (8)$$

The average Hausdorff function is step-wise smooth and differentiable. Empirically, however, we find step-wise smoothness to be insufficient for

the best training outcome. Therefore, we propose a fully differentiable version of the Hausdorff distance by replacing the min operation with softmax by modelling $\text{align}(\mathbb{X}, \hat{\mathbb{X}}) =$

$$\frac{1}{|\mathbb{X}|} \sum_{x \in \mathbb{X}} \sum_{y \in \hat{\mathbb{X}}} \left(\frac{e^{-d(x, y)}}{\sum_{y' \in \hat{\mathbb{X}}} e^{-d(x, y')}} \cdot d(x, y) \right). \quad (9)$$

This variant is reminiscent of the attention mechanism (Bahdanau et al., 2015) in the sense that a weighted average is computed, which has been very successful at smoothly approximating discrete decisions, e.g., read and write operations in the Differentiable Neural Computer (Graves et al., 2016) among many others.

5 Experiments

Our experiments are designed to test the following two hypotheses. **H1**: If the input text is too long to be encoded into a fixed-size single vector representation, BoV-AE-based Emb2Emb provides a substantial advantage over the fixed-sized model. **H2**: Our technical contributions, namely L0Drop regularization, the training loss, and the mapping architecture, are necessary for BoV-AE’s success.

We evaluate our model on two unsupervised conditional text generation tasks: In Section 5.1, we show that **H1** holds even when the single-vector dimensionality is large ($d=512$). To this end, we create a new sentiment transfer dataset, Yelp-Reviews, whose inputs are relatively long. However, training on this dataset is computationally very demanding². Therefore, we turn to a short-text style transfer dataset to test hypothesis **H2** (Section 5.2).

Additionally, we conducted experiments on abstractive sentence summarization (Rush et al., 2015). These provide evidence of the generality of our method, as well as the utility of the mapping architecture’s copy mechanism. Due to space constraints, these are included in Appendix A.

For each of the experiments in this section, we provide full experimental details in Appendix B.

Evaluation metrics: In sentiment transfer, the goal is to rewrite a negative review as a positive review while keeping as much of the content as possible. Hence, two metrics are important, sentiment transfer ability and content retention. Following common practice (Hu et al., 2017; Shen

²Pretraining a model of this size until convergence took more than a month on a single 24GB GPU.

et al., 2017; Lample et al., 2019), we measure the former with a separately trained style classifier based on DistilBERT (Sanh et al., 2019), and content retention in terms of self-BLEU (Papineni et al., 2002) between the input and the predicted output. To allow comparison via a single score, we aggregate content retention and transfer accuracy (Xu et al., 2018; Krishna et al., 2020), per sentence (Krishna et al., 2020), and compute a single $score = \frac{1}{M} \sum_{i=1}^M ACC(\hat{y}) \cdot BLEU(\hat{y}, x)$ where x is the input sentence, \hat{y} is the predicted sentence, and M is the number of data points. For readability, we multiply all metrics by 100 before reporting.

Autoencoder Pretraining: Since Emb2Emb is plug and play, the autoencoder pretraining can be decoupled from the downstream task, enabling large-scale pretraining on a general purpose corpus. While this would certainly be necessary to reach the best results possible, such an endeavor is very resource-intensive, making it impractical to conduct the kind of controlled experiments needed to support our hypotheses. Moreover, existing pre-trained autoencoders such as BART (Lewis et al., 2020) cannot be used off-the-shelf because they weren’t trained to have a smooth embedding space, for example using LODrop. In Appendix C.2.2, we study the effect of adding an LODrop layer inside BART and finetuning it for a few steps on the target task data. Although this works to some extent, this LODrop layer can be expected to remove information which would be kept if it were trained in full large-scale pretraining, which we don’t have the resources to do.

Therefore, we instead pretrain all autoencoders from scratch directly on the data of the target task. Models named **L0-r** denote LODrop-based BoV-AE models that only differ in the target ratio r used in training. As a control, we always compare to a single vector **fixed**-size AE, which is obtained by averaging the vectors at the last layer of the encoder.

5.1 Yelp-Reviews

Our hypothesis is that AEs with a single vector bottleneck are unable to reliably compress the text when it is too long. Here, we test if this holds true even for a large single-vector model with $d=512$. To this end, we create the dataset *Yelp-Reviews*, which consists of strongly positive and strongly negative English restaurant reviews on Yelp (see Appendix B.4.1 for a detailed description). This

dataset is very similar to Yelp-Sentences introduced by Shen et al. (2017). However, while Yelp-Sentences consists of single sentences of about 10 words on average, Yelp-Reviews consists of entire reviews of 52 words on average. For style transfer, we train a Transformer++ mapping using the loss described in Section 2. To obtain results at varying transfer levels, we train multiple times with varying λ_{sty} , resulting in multiple points for each model in Figure 3 and 6.

Results: The results (full graph shown in Figure 8 in the Appendix) indicate that even large single vector models ($d=512$) are unable to compress the text well; the NLL loss on the validation set of the fixed-size model is ≈ 3.9 . **L0-0.05** is only slightly better than the fixed-size model, whereas **L0-0.1** already reaches a substantially lower reconstruction loss (≈ 2.1). We evaluated the downstream sentiment transfer performance of Transformer++ with **L0-0.1**³ and the fixed-size model, respectively. Figure 3 shows a scatter plot of the results, where results that are further to the top-right corner are better. We see that at a comparable transfer level, the BoV is substantially better at retaining the input content. This supports hypothesis **H1** that variable-size BoV models are particularly beneficial in cases where the text length is too long to be encoded in a single-vector.

5.2 Yelp-Sentences

In order to answer research question **H2**, we perform a large set of controlled experiments over our model’s components. Due to the high computational demand, we turn to the popular Yelp-Sentences sentiment transfer dataset by Shen et al. (2017). Texts in this dataset are ≈ 10 words on average. As these sentences are much easier to reconstruct, we set the embedding size to $d=32$ so that the condition for hypothesis **H1** is still valid. Here, we again train BoV-AEs for a variety of target rates ($r = 0.2, 0.4, 0.6, 0.8$) and then evaluate their reconstruction and style transfer ability in the same fashion as for Yelp-Reviews. Finally, we investigate the impact of the differentiable Hausdorff loss and the window size. For completeness, we provide an analysis of the computational complexity of BoV-AE in Appendix C.2.1.

³We restrict our analysis to L0-0.1 because this dataset has is computationally demanding.

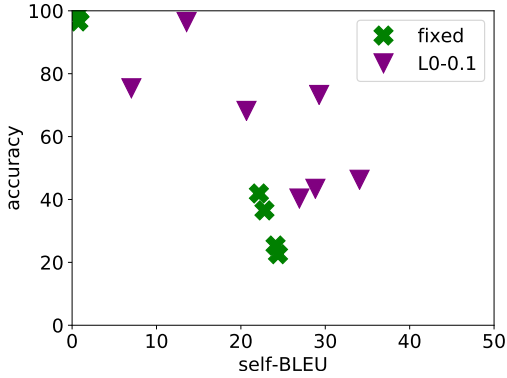

Figure 3: Style transfer on Yelp-Reviews.

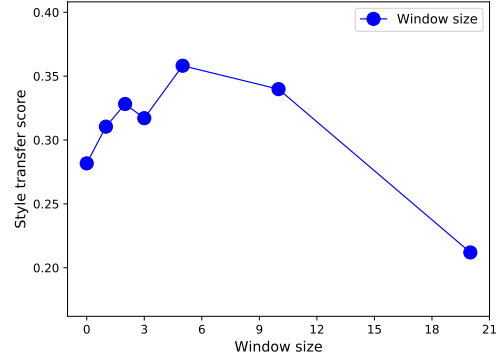

Figure 4: Style transfer score depending on the window size.

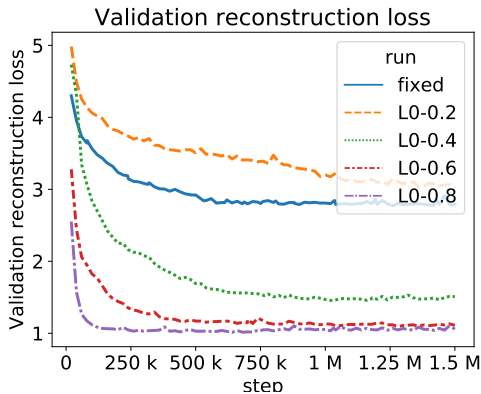

Figure 5: Reconstruction loss on the validation set for different AEs. **fixed**: A single vector obtained by averaging the encoder output vectors. **L0-r**: BoV-AEs with L0Drop target ratio r .

5.2.1 Reconstruction Ability

Figure 5 shows the reconstruction loss on the validation set for the fixed-size model compared to BoV models. The fixed-size AE does not reach satisfactory reconstruction ability, converging at an NLL loss value of about 3. In contrast, BoV models are able to outperform the fixed-size model considerably. As expected, higher target ratios lead to better reconstruction, because the model can use more vectors to store the information. Models with a higher target ratio also reach their optimal loss value more quickly. While **L0-0.6** approaches the best reconstruction value (≈ 1.0) eventually, the model needs more than 1 million training steps to reach it. In contrast, **L0-0.8** needs less than 100k steps to converge, which could indicate that **L0-0.8** learns to copy rather than compress the input, resulting in a bad latent space. **L0-0.4** yields to a higher loss, but is still drastically better than the fixed size model. **L0-0.2** is not enough to outperform the fixed size model. Overall, these results show we have the right settings for evaluating **H1**

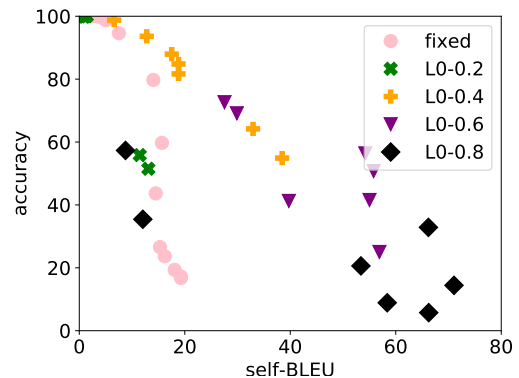

Figure 6: Style transfer performance on Yelp-Sentences of BoV models compared to a fixed-size AE for varying λ_{sty} . Further to the top (style transfer) and right (content retention) is better.

and **H2**, as 10 words is too long to be encoded well into a single vector of $d=32$, whereas a BoV-AE with a high enough target ratio r can fit it well.

5.2.2 Style Transfer Ability

Results are shown in Figure 6. Up to $r=0.6$, they correspond well to the reconstruction ability, in that BoV models with higher target ratios yield higher self-BLEU scores at comparable transfer abilities, outperforming the fixed-size model (**H1**). However, at $r=0.8$, the performance suddenly deteriorates at medium to high transfer levels. This supports the hypothesis that **L0-0.8** lacks smoothness in the embedding space due to insufficient regularization, which in turn complicates downstream training. This is the first piece of evidence that L0Drop is necessary for the success of our model (**H2**).

5.2.3 Ablation on Differentiable Hausdorff

In Section 4.3, we argue that the min operation should be replaced by softmin in order to facilitate backpropagation. Here, we test if the differentiable

version is really necessary, that is, we compare Eq. 8 to Eq. 9. Like above, we train the two variants with different λ_{sty} , and then select the best style transfer score on the validation set. The difference is substantial: Average Hausdorff reaches 14.6, whereas differentiable Hausdorff reaches 24.2. We hypothesize that this discrepancy is due to the difficult nature of the style transfer problem, which requires carefully balancing the two objectives, content retention (via Hausdorff) and style transfer (via the classifier). This is easier when the objective functions are smooth, which is the advantage of differentiable Hausdorff.

5.2.4 Ablation on Window Size

The window size k determines which bag sizes around the input bag size we backpropagate from (cmp. Section 4.2). Here, we investigate its influence on the model’s performance. Since the λ_{sty} hyperparameter is very sensitive to other model hyperparameters, we train with varying λ_{sty} for each fixed window size and report the best style transfer score for each window size. In Figure 4, we plot the style transfer score as a function of the window size. Our results indicate that increasing the window size from zero (score 28.2) is beneficial up to some point ($k=5$, score 35.8), whereas increasing by too much ($k=20$, score 21.2) is detrimental to model performance even compared to a size of zero. We hypothesize that backpropagating bags that are either very small or very large is detrimental because it forces the model to adjust its parameters to optimize unrealistic bags, taking away capacity for fitting realistic bags.

5.2.5 Qualitative Analysis

We hypothesize that standard autoencoders suffer from poor performance with Emb2Emb if the text is too long to be encoded into a single vector (**H1**). BoV-AEs were designed to alleviate this issue. Here, we conduct a qualitative analysis of 10 randomly selected model outputs on Yelp-Sentences. For comparability, we select models with similar levels of style transfer accuracy, namely the fixed size model with a performance of 59% accuracy and 17 points self-BLEU to **L0-0.4** with a performance of 55% accuracy and 38 points self-BLEU. We randomly sample 10 examples and show them in Table 1. By design of the Yelp-Sentences dataset (Shen et al., 2017), the inputs are sentences drawn from negative reviews, whose sentiment are supposed to be changed to

positive. Note that due to how the dataset was constructed, some of the input sentences are already positive (#7) or just neutral (#2).

We observe several trends: **(1)** The fixed-sized model has a difficult time retaining the aspect discussed in the input sentence (#10: staff instead of location, #9: food instead of price), whereas the BoV-AE stays on topic. This is likely a consequence of the fixed-sized model’s inability to encode the input well into a single vector, supporting **H1**. **(2)** The outputs of the fixed-sized models are often completely unusable (#1, #2) or nonsensical (#5, #9, #10), whereas the outputs of the BoV-AE are at least intelligible. **(3)** In absolute terms, the outputs of neither model are reliably grammatical or able to flip the sentiment. This is understandable since no large pretrained language model is used. This would be needed to produce coherent outputs (Brown et al., 2020), which then produces impressive outputs on style transfer (Reif et al., 2021). As we argue in Section 1, our paper contributes to the foundation for large scale pretraining of autoencoder models to be used in Emb2Emb.

6 Related Work

Manipulations in latent space: Besides Emb2Emb, latent space manipulations for textual style transfer are performed either via gradient descent (Wang et al., 2019; Liu et al., 2020) or by adding constant style vectors to the input (Shen et al., 2020; Montero et al., 2021). In computer vision, discovering latent space manipulations for image style transfer has recently become a topic of increased interest, in both supervised (Jahanian et al., 2020; Zhuang et al., 2021) and unsupervised ways (Härkönen et al., 2020; Voynov and Babenko, 2020). While these vision methods are similar to Emb2Emb conceptually, they differ from our work in important ways. First, they focus on the latent space of GANs (Goodfellow et al., 2014), which work well for image generation but are known to struggle with text (Caccia et al., 2020). Secondly, images typically have a fixed size, and consequently their latent representations consist of single vectors. Our work focuses on data of variable size, which may have important insights for modalities other than text, e.g. videos and speech.

Unsupervised conditional text generation: Modern unsupervised conditional text generation approaches are based on either **(a)** language mod-

Table 1: 10 randomly sampled examples from Yelp-Sentences and the outputs from each model.

#	Input sentence	Output of fixed-size model	Output of L0-0.4
1	generally speaking it was nothing worth coming back to .	but there here here and it will enjoy it .	generally remain it was it worth it and always happy !
2	then why did n't they put some in ?	then she , you ta are the in the ?	then ' why n ' t they put some delicious !
3	horrible experience !	horrible !	horrible experience !
4	it was a shame because we were really looking forward to dining there .	it was a a fun , there and we have been to .	it really nice shame because we were really looking forward forward and fantastic !
5	suffice to stay , this is not a great place to stay .	suffice to to not stay to this place is a stay .	suffice is not stay , this is a great place and always great !
6	the chicken was weird .	the chicken was weird .	the chicken was weird .
7	my mom ordered the margarita panini which was pretty good .	my my margarita was ordered which was very good .	my mom ordered the margarita panini which was pretty good .
8	i 'm not willing to take the chance .	i will definitely recommend your time or you .	i ' m not willing to take the great .
9	i would say for the price point that it was uninspired .	i had this place at the food , it 's super .	i would say for the price point that it was delicious .
10	the only pool complaint i have was from the last day of our stay .	the waitress was the the the the time here a last time	the only pool complaint i have was from the day was wonderful !

els (LMs) or **(b)** autoencoders (AEs). **(a)** One type of LM approach explicitly conditions on attributes during pretraining (Keskar et al., 2019), which puts restrictions on the data that can be used for training. Another type adapts pretrained LMs for conditional text generation by learning modifications in the embedding space (Dathathri et al., 2020). These approaches work well because LMs are pretrained with very large amounts of data and compute power, which results in exceptional generative ability (Radford et al., 2019; Brown et al., 2020) that even enables impressive zero-shot style transfer results (Reif et al., 2021). However, in contrast to AEs, LMs are not designed to have a latent space that facilitates learning in it. We therefore argue that AE approaches could perform even better than LMs if they were given equal resources. This motivates our research. **(b)** A very common approach to AE-based unsupervised conditional text generation is to learn a shared latent space for input and output corpora that is agnostic to the attribute of interest (e.g., sentiment transfer (Shen et al., 2017), style transfer (Lample et al., 2019), summarization (Liu et al., 2019), machine translation (Artexxe et al., 2018)). However, in these approaches, the decoder is explicitly conditioned

on the desired attribute that must be available for all data points, complicating pretraining on unlabeled data. To overcome this, Mai et al. (2020) recently proposed Emb2Emb, which disentangles AE pretraining from learning to change the attributes via a simple mapping. Our paper makes an important contribution by improving the expressivity of Emb2Emb through variable-size representations.

7 Conclusion

Our paper addresses a fundamental research question: How do we learn text representations in such a way that conditional text generation can be learned in the latent space (e.g. Emb2Emb)? We propose Bag-of-Vectors Autoencoders to overcome the fundamental bottleneck of single-vector autoencoders: Controlled experiments revealed that, thanks to our technical contributions, BoV-AEs perform substantially better at learning in their embedding space when the text is too long to be encoded into a single vector. This lays the foundation for learning conditional long-text generation models in a framework such as Emb2Emb in an unsupervised manner.

Acknowledgements

Florian Mai was supported by the Swiss National Science Foundation under grant number 200021_178862.

References

- Mikel Artetxe, Gorka Labaka, Eneko Agirre, and Kyunghyun Cho. 2018. Unsupervised neural machine translation. In *International Conference on Learning Representations*.
- Orhun Utku Aydin, Abdel Aziz Taha, Adam Hilbert, Ahmed A Khalil, Ivana Galinovic, Jochen B Fiebach, Dietmar Frey, and Vince Istvan Madai. 2020. On the usage of average hausdorff distance for segmentation performance assessment: Hidden bias when used for ranking. *arXiv preprint arXiv:2009.00215*.
- Dzmitry Bahdanau, Kyunghyun Cho, and Yoshua Bengio. 2015. Neural machine translation by jointly learning to align and translate. In *International Conference on Learning Representations*.
- Steven Bird, Ewan Klein, and Edward Loper. 2009. *Natural language processing with Python: analyzing text with the natural language toolkit*. "O'Reilly Media, Inc."
- Rishi Bommasani, Drew A Hudson, Ehsan Adeli, Russ Altman, Simran Arora, Sydney von Arx, Michael S Bernstein, Jeannette Bohg, Antoine Bosselut, Emma Brunskill, et al. 2021. On the opportunities and risks of foundation models. *arXiv preprint arXiv:2108.07258*.
- Samuel R. Bowman, Luke Vilnis, Oriol Vinyals, Andrew M. Dai, Rafal Józefowicz, and Samy Bengio. 2016. Generating sentences from a continuous space. In *CoNLL*, pages 10–21. ACL.
- Tom B. Brown, Benjamin Mann, Nick Ryder, Melanie Subbiah, Jared Kaplan, Prafulla Dhariwal, Arvind Neelakantan, Pranav Shyam, Girish Sastry, Amanda Askell, Sandhini Agarwal, Ariel Herbert-Voss, Gretchen Krueger, Tom Henighan, Rewon Child, Aditya Ramesh, Daniel M. Ziegler, Jeffrey Wu, Clemens Winter, Christopher Hesse, Mark Chen, Eric Sigler, Mateusz Litwin, Scott Gray, Benjamin Chess, Jack Clark, Christopher Berner, Sam McCandlish, Alec Radford, Ilya Sutskever, and Dario Amodei. 2020. Language models are few-shot learners. In *NeurIPS*.
- Massimo Caccia, Lucas Caccia, William Fedus, Hugo Larochelle, Joelle Pineau, and Laurent Charlin. 2020. Language gaps falling short. In *International Conference on Learning Representations*.
- Xilun Chen. 2019. *Learning Deep Representations for Low-Resource Cross-Lingual Natural Language Processing*. Ph.D. thesis, Cornell University.
- Sumanth Dathathri, Andrea Madotto, Janice Lan, Jane Hung, Eric Frank, Piero Molino, Jason Yosinski, and Rosanne Liu. 2020. Plug and play language models: A simple approach to controlled text generation. In *International Conference on Learning Representations*.

- Jacob Devlin, Ming-Wei Chang, Kenton Lee, and Kristina Toutanova. 2019. BERT: pre-training of deep bidirectional transformers for language understanding. In *NAACL-HLT (1)*, pages 4171–4186. Association for Computational Linguistics.
- Marie-Pierre Dubuisson and Anil K. Jain. 1994. A modified hausdorff distance for object matching. In *ICPR (1)*, pages 566–568. IEEE.
- Haoqiang Fan, Hao Su, and Leonidas J. Guibas. 2017. A point set generation network for 3d object reconstruction from a single image. In *CVPR*, pages 2463–2471. IEEE Computer Society.
- Thibault Févry and Jason Phang. 2018. Unsupervised sentence compression using denoising autoencoders. In *CoNLL*, pages 413–422. Association for Computational Linguistics.
- Ian J. Goodfellow, Jean Pouget-Abadie, Mehdi Mirza, Bing Xu, David Warde-Farley, Sherjil Ozair, Aaron C. Courville, and Yoshua Bengio. 2014. Generative adversarial nets. In *NIPS*, pages 2672–2680.
- David Graff, Junbo Kong, Ke Chen, and Kazuaki Maeda. 2003. English gigaword. *Linguistic Data Consortium, Philadelphia*, 4(1):34.
- Alex Graves, Greg Wayne, Malcolm Reynolds, Tim Harley, Ivo Danihelka, Agnieszka Grabska-Barwińska, Sergio Gómez Colmenarejo, Edward Grefenstette, Tiago Ramalho, John Agapiou, et al. 2016. Hybrid computing using a neural network with dynamic external memory. *Nature*, 538(7626):471–476.
- Suchin Gururangan, Swabha Swayamdipta, Omer Levy, Roy Schwartz, Samuel R. Bowman, and Noah A. Smith. 2018. Annotation artifacts in natural language inference data. In *NAACL-HLT (2)*, pages 107–112. Association for Computational Linguistics.
- Erik Härkönen, Aaron Hertzmann, Jaakko Lehtinen, and Sylvain Paris. 2020. Ganspace: Discovering interpretable GAN controls. In *NeurIPS*.
- James Henderson. 2020. The unstoppable rise of computational linguistics in deep learning. In *ACL*, pages 6294–6306. Association for Computational Linguistics.
- Zhiting Hu, Zichao Yang, Xiaodan Liang, Ruslan Salakhutdinov, and Eric P. Xing. 2017. Toward controlled generation of text. In *ICML*, volume 70 of *Proceedings of Machine Learning Research*, pages 1587–1596. PMLR.
- Daniel P. Huttenlocher, William Rucklidge, and Gregory A. Klanderman. 1992. Comparing images using the hausdorff distance under translation. In *CVPR*, pages 654–656. IEEE.
- Ali Jahanian, Lucy Chai, and Phillip Isola. 2020. On the "steerability" of generative adversarial networks. In *International Conference on Learning Representations*.
- Nitish Shirish Keskar, Bryan McCann, Lav R Varshney, Caiming Xiong, and Richard Socher. 2019. Ctrl: A conditional transformer language model for controllable generation. *arXiv preprint arXiv:1909.05858*.
- Diederik P Kingma and Jimmy Ba. 2015. Adam: A method for stochastic optimization. In *International Conference on Learning Representations*.
- Diederik P. Kingma, Tim Salimans, Rafal Józefowicz, Xi Chen, Ilya Sutskever, and Max Welling. 2016. Improving variational autoencoders with inverse autoregressive flow. In *NIPS*, pages 4736–4744.
- Kalpesh Krishna, John Wieting, and Mohit Iyyer. 2020. Reformulating unsupervised style transfer as paraphrase generation. In *EMNLP (1)*, pages 737–762. Association for Computational Linguistics.
- Yen-Ling Kuo, Boris Katz, and Andrei Barbu. 2020. Compositional networks enable systematic generalization for grounded language understanding. *arXiv preprint arXiv:2008.02742*.
- Garry Kuwanto, Afra Feyza Akyürek, Isidora Chara Tourni, Siyang Li, and Derry Wijaya. 2021. Low-resource machine translation for low-resource languages: Leveraging comparable data, code-switching and compute resources. *arXiv preprint arXiv:2103.13272*.
- Guillaume Lample, Alexis Conneau, Ludovic Denoyer, and Marc’Aurelio Ranzato. 2018. Unsupervised machine translation using monolingual corpora only. In *International Conference on Learning Representations*.
- Guillaume Lample, Sandeep Subramanian, Eric Smith, Ludovic Denoyer, Marc’Aurelio Ranzato, and Y-Lan Boureau. 2019. Multiple-attribute text rewriting. In *International Conference on Learning Representations*.
- Mike Lewis, Yinhan Liu, Naman Goyal, Marjan Ghazvininejad, Abdelrahman Mohamed, Omer Levy, Veselin Stoyanov, and Luke Zettlemoyer. 2020. BART: denoising sequence-to-sequence pre-training for natural language generation, translation, and comprehension. In *ACL*, pages 7871–7880. Association for Computational Linguistics.
- Chin-Yew Lin. 2004. Rouge: A package for automatic evaluation of summaries. In *Text summarization branches out*, pages 74–81.
- Kwan-Ho Lin, Kin-Man Lam, and Wan-Chi Siu. 2003. Spatially eigen-weighted hausdorff distances for human face recognition. *Pattern Recognit.*, 36(8):1827–1834.

- Dayiheng Liu, Jie Fu, Yidan Zhang, Chris Pal, and Jiancheng Lv. 2020. Revision in continuous space: Unsupervised text style transfer without adversarial learning. In *AAAI*, pages 8376–8383. AAAI Press.
- Peter J Liu, Yu-An Chung, and Jie Ren. 2019. Summae: Zero-shot abstractive text summarization using length-agnostic auto-encoders. *arXiv preprint arXiv:1910.00998*.
- Yue Lu, Chew Lim Tan, Weihua Huang, and Liying Fan. 2001. An approach to word image matching based on weighted hausdorff distance. In *ICDAR*, pages 921–925. IEEE Computer Society.
- Florian Mai, Nikolaos Pappas, Ivan Montero, Noah A. Smith, and James Henderson. 2020. Plug and play autoencoders for conditional text generation. In *EMNLP (1)*, pages 6076–6092. Association for Computational Linguistics.
- Joshua Maynez, Shashi Narayan, Bernd Bohnet, and Ryan T. McDonald. 2020. On faithfulness and factuality in abstractive summarization. In *ACL*, pages 1906–1919. Association for Computational Linguistics.
- Ivan Montero, Nikolaos Pappas, and Noah A Smith. 2021. Sentence bottleneck autoencoders from transformer language models. *arXiv preprint arXiv:2109.00055*.
- Sarana Nutanong, Chenyun Yu, Raheem Sarwar, Peter Xu, and Dickson Chow. 2016. A scalable framework for stylometric analysis query processing. In *ICDM*, pages 1125–1130. IEEE Computer Society.
- Kishore Papineni, Salim Roukos, Todd Ward, and Wei-Jing Zhu. 2002. Bleu: a method for automatic evaluation of machine translation. In *ACL*, pages 311–318. ACL.
- Adam Paszke, Sam Gross, Francisco Massa, Adam Lerer, James Bradbury, Gregory Chanan, Trevor Killeen, Zeming Lin, Natalia Gimelshein, Luca Antiga, et al. 2019. Pytorch: An imperative style, high-performance deep learning library. *Advances in neural information processing systems*, 32.
- Matthew E. Peters, Mark Neumann, Mohit Iyyer, Matt Gardner, Christopher Clark, Kenton Lee, and Luke Zettlemoyer. 2018. Deep contextualized word representations. In *NAACL-HLT*, pages 2227–2237. Association for Computational Linguistics.
- Maxime Peyrard. 2019. A simple theoretical model of importance for summarization. In *ACL (1)*, pages 1059–1073. Association for Computational Linguistics.
- Alec Radford, Jeff Wu, Rewon Child, David Luan, Dario Amodei, and Ilya Sutskever. 2019. Language models are unsupervised multitask learners.
- Aditya Ramesh, Mikhail Pavlov, Gabriel Goh, Scott Gray, Chelsea Voss, Alec Radford, Mark Chen, and Ilya Sutskever. 2021. Zero-shot text-to-image generation. In *ICML*, volume 139 of *Proceedings of Machine Learning Research*, pages 8821–8831. PMLR.
- Emily Reif, Daphne Ippolito, Ann Yuan, Andy Coenen, Chris Callison-Burch, and Jason Wei. 2021. A recipe for arbitrary text style transfer with large language models. *arXiv preprint arXiv:2109.03910*.
- Javier Ribera, David Guera, Yuhao Chen, and Edward J. Delp. 2019. Locating objects without bounding boxes. In *CVPR*, pages 6479–6489. Computer Vision Foundation / IEEE.
- Alexander M. Rush, Sumit Chopra, and Jason Weston. 2015. A neural attention model for abstractive sentence summarization. In *EMNLP*, pages 379–389. The Association for Computational Linguistics.
- Victor Sanh, Lysandre Debut, Julien Chaumond, and Thomas Wolf. 2019. DistilBERT, a distilled version of BERT: smaller, faster, cheaper and lighter. *arXiv preprint arXiv:1910.01108*.
- Abigail See, Peter J. Liu, and Christopher D. Manning. 2017. Get to the point: Summarization with pointer-generator networks. In *ACL (1)*, pages 1073–1083. Association for Computational Linguistics.
- Rico Sennrich, Barry Haddow, and Alexandra Birch. 2015. Neural machine translation of rare words with subword units. *arXiv preprint arXiv:1508.07909*.
- Tianxiao Shen, Tao Lei, Regina Barzilay, and Tommi S. Jaakkola. 2017. Style transfer from non-parallel text by cross-alignment. In *NIPS*, pages 6830–6841.
- Tianxiao Shen, Jonas Mueller, Regina Barzilay, and Tommi S. Jaakkola. 2020. Educating text autoencoders: Latent representation guidance via denoising. In *ICML*, volume 119 of *Proceedings of Machine Learning Research*, pages 8719–8729. PMLR.
- Nitish Srivastava, Geoffrey E. Hinton, Alex Krizhevsky, Ilya Sutskever, and Ruslan Salakhutdinov. 2014. Dropout: a simple way to prevent neural networks from overfitting. *J. Mach. Learn. Res.*, 15(1):1929–1958.
- Abdel Aziz Taha and Allan Hanbury. 2015. Metrics for evaluating 3d medical image segmentation: analysis, selection, and tool. *BMC Medical Imaging*, 15:29.
- Barnabás Takács. 1998. Comparing face images using the modified hausdorff distance. *Pattern Recognit.*, 31(12):1873–1881.
- Romal Thoppilan, Daniel De Freitas, Jamie Hall, Noam Shazeer, Apoorv Kulshreshtha, Heng-Tze Cheng, Alicia Jin, Taylor Bos, Leslie Baker, Yu Du, et al. 2022. Lamda: Language models for dialog applications. *arXiv preprint arXiv:2201.08239*.

Ashish Vaswani, Noam Shazeer, Niki Parmar, Jakob Uszkoreit, Llion Jones, Aidan N. Gomez, Lukasz Kaiser, and Illia Polosukhin. 2017. Attention is all you need. In *NIPS*, pages 5998–6008.

Andrey Voynov and Artem Babenko. 2020. Unsupervised discovery of interpretable directions in the GAN latent space. In *ICML*, volume 119 of *Proceedings of Machine Learning Research*, pages 9786–9796. PMLR.

Ke Wang, Hang Hua, and Xiaojun Wan. 2019. Controllable unsupervised text attribute transfer via editing entangled latent representation. In *NeurIPS*, pages 11034–11044.

Thomas Wolf, Lysandre Debut, Victor Sanh, Julien Chaumond, Clement Delangue, Anthony Moi, Pierric Cistac, Tim Rault, Rémi Louf, Morgan Funtowicz, et al. 2019. Huggingface’s transformers: State-of-the-art natural language processing. *arXiv preprint arXiv:1910.03771*.

Jingjing Xu, Xu Sun, Qi Zeng, Xiaodong Zhang, Xuancheng Ren, Houfeng Wang, and Wenjie Li. 2018. Unpaired sentiment-to-sentiment translation: A cycled reinforcement learning approach. In *ACL (1)*, pages 979–988. Association for Computational Linguistics.

Dani Yogatama, Cyprien de Masson d’Autume, Jerome Connor, Tomas Kocisky, Mike Chrzanowski, Lingpeng Kong, Angeliki Lazaridou, Wang Ling, Lei Yu, Chris Dyer, et al. 2019. Learning and evaluating general linguistic intelligence. *arXiv preprint arXiv:1901.11373*.

Biao Zhang, Ivan Titov, and Rico Sennrich. 2021. On sparsifying encoder outputs in sequence-to-sequence models. In *ACL/IJCNLP (Findings)*, volume ACL/IJCNLP 2021 of *Findings of ACL*, pages 2888–2900. Association for Computational Linguistics.

Jianan Zhao, Fengliang Qi, Guangyu Ren, and Lin Xu. 2021. Phd learning: Learning with pompeiu-hausdorff distances for video-based vehicle re-identification. In *CVPR*, pages 2225–2235. Computer Vision Foundation / IEEE.

Peiye Zhuang, Oluwasanmi O Koyejo, and Alex Schwing. 2021. Enjoy your editing: Controllable {gan}s for image editing via latent space navigation. In *International Conference on Learning Representations*.

Ethics Statement

Applications The focus of our study is not any particular application, but concerns fundamental questions in unsupervised conditional text generation in general. Unsupervised applications are useful in scenarios where few annotations exist, which is particularly common in understudied low-resource languages (e.g. unsupervised neural machine translation (Kuwanto et al., 2021)). Of course, oftentimes unsupervised solutions perform worse than supervised ones, requiring extra care during deployment to avoid harm from potential mistakes.

Despite the fundamental nature of our study, we test our model on two concrete problems, **a)** text style transfer and **b)** sentence summarization. **a)** Style transfer has applications that are beneficial to society, such as expressing "complicated" text in simpler terms (*text simplification*) or avoiding potentially offensive language (*detoxification*), both of which are particularly beneficial for traditionally underprivileged groups such as non-native English speakers. However, the same technology can also be used maliciously by simply inverting the style transfer direction. In this paper, we decided to study sentiment transfer of restaurant reviews as a style transfer task. The reasons are primarily practical; deriving both from the Yelp dataset, we can study the effectiveness of our model on two datasets (sentences and full reviews) that are very similar in content but considerably different in length. On one hand, this allows us to demonstrate the effectiveness of our model in a realistic, but computationally demanding setting. On the other hand, we can perform ablations in a less expensive setting. Apart from serving as a test bed for scientific research, sentiment transfer itself has no obvious real-world application. With enough imagination one can construe a scenario where a bad actor hacks into the database of a review platform like Yelp to e.g. manipulate the content of existing reviews. However, we rate this as highly unrealistic due to high opportunity cost, as it is much easier to generate fake reviews with large language models rather than hack into a system and alter existing reviews.

b) Summarization systems can be very valuable for society by enabling people to process information faster. But this depends on the system’s output to be mostly factual, which neural summarization systems struggle with (Maynez et al., 2020). Un-

faithful outputs may convey misinformation, which can potentially harm users.

Deployment While we argue above that sentiment transfer has no useful real-world application, the model can still be deployed for demonstration purposes, or be trained and deployed for other tasks, e.g., sentence simplification. However, we urge not to deploy the models developed in this paper directly without adaptation for several reasons. i) The absolute performance is suboptimal (e.g., no large-scale pretraining) and hence makes many mistakes that a real-world application should avoid to prevent harm. ii) The model can occasionally produce toxic output. Of course, the extent to which this happens strongly depends on the training data. E.g., Yelp restaurant reviews can sometimes contain vulgar language. Any real-world application should hence consider pre- and post-filtering methods. iii) The model might be biased towards certain populations, the extent of which is not the subject of this study. For example, the sentiment transfer models would likely work better for fast food restaurants than restaurants of African cuisine, because the former is more common in the mostly US-centric data that the model is trained on. A real-world application needs to consider the requirements of the target audience.

Similarly, we argue that the sentence summarization model studied in this paper needs further improvements before deployment, some of which we mentioned in the main paper. Large-scale pretraining could also help to mitigate hallucinated facts (Maynez et al., 2020).

Dataset The Yelp-Reviews dataset is a direct derivative of the Yelp Open Dataset⁴. Their license agreement states that any derivative remains the property of Yelp, hence we can not directly release the dataset. However, academic researchers can easily obtain their own license for non-commercial use and recreate the dataset used in this study via the script we provide in the supplementary material. No further data collection was conducted.

We explicitly try to avoid the inclusion of sensitive data (e.g., the name of a Yelp reviewer) for training and evaluation by only using the review text and no attached meta-data.

⁴www.yelp.com/dataset

Limitations

Our study is fundamental in nature; we systematically demonstrate the benefit of Emb2Emb with variable-size representations rather than fixed-sized representations via controlled experiments. We do not aim to maximize the performance on any specific task. This implicates some limitations.

Applications We discourage application engineers to apply our model without modification in production for text style transfer or unsupervised summarization.

First, the state-of-the-art in practically all language-related tasks relies heavily on large-scale pretraining, which requires large amounts of resources. For example, the state-of-the-art in text style transfer by Reif et al. (2021) is built upon a language model with 137B parameters (Thoppilan et al., 2022). Due to this foundation, the model is able to generalize to arbitrary text style transfer tasks in a zero-shot manner, generating far better outputs than our models. The best unsupervised text summarization models also require large language models (Brown et al., 2020). Second, we abstain from task-specific tweaks to our model such as backtranslation for style transfer (Lample et al., 2018).

However, we view both these factors as orthogonal to our contribution. Our model is in principle compatible with large-scale pretraining. In fact, a unique advantage of the Emb2Emb framework is its compatibility with pretrained autoencoders. Mai et al. (2020) showed that the Emb2Emb framework, a state-of-the-art model for text style transfer before pretrained models became ubiquitous, benefits immensely from unlabeled data. Moreover, in Appendix C.2.2, we discuss promising results of an initial study that makes the pretrained autoencoder BART (Lewis et al., 2020) compatible with Emb2Emb by further finetuning it with LODrop regularization. The resulting model produces more fluent and grammatical outputs than the model trained from scratch. This indicates that, given enough compute and data for large-scale pretraining from scratch, Bag-of-Vectors Autoencoders could have the potential to become a *Foundation Model* (Bommasani et al., 2021) like BERT, BART, and GPT-3. Our study paves the way for the application of BoV-AEs for unsupervised tasks by demonstrating how to learn in their latent space.

Hyperparameter sensitivity BoV-AEs are more sensitive with respect to certain hyperparameters than their fixed-sized counterparts. We noticed this in two places. First, when pretraining on unlabeled data, BoVAEs required a more finegrained learning rate than fixed-sized AEs. This is also notable when comparing their learning curves: The curves in Figure 5 are smoother than in Figure 8. Secondly, the tradeoff between content retention and transfer ability is not as easily controllable through the λ_{sty} hyperparameter as in the fixed-sized model. For instance, in Figure 3, the Pareto front of the fixed-sized model is considerably smoother. However, while it can be difficult to train models to their optimum (as is typical in deep learning), BoV-AEs can still drastically outperform the fixed-sized baseline. Nonetheless, for practical purposes it will be important to discover more robust hyperparameterization similar to Equation 1.

Computation time BoV-AEs are more sophisticated than standard fixed-size AEs, and this also comes with higher computational cost. We analyze this in depth in Appendix C.2.1. In summary, especially the mapping is considerably more costly, as it depends on the input length. However, this cost is mitigated through LODrop’s sparsification, and for very long texts, fixed-size AEs are no viable option. Nonetheless, investigating the suitability of efficient Transformer alternatives for our framework will be an important future research avenue.

Reproducibility Statement

We took several precautions to ensure that our work is reproducible.

Datasets Our study is based on two existing datasets, Gigaword sentence summarization, and Yelp-Sentences style transfer. For these two datasets, we provide scripts that preprocess them as in our study. For Yelp-Reviews dataset, we provide a detailed description in appendix B.4.1. Moreover, we provide a script that allows to construct the dataset as a derivative from Yelp data. In order to get access to Yelp data, practitioners have to obtain a license from Yelp that is free of charge. The data may only be used for non-commercial or academic purposes, but this suffices to reproduce our study. The Gigaword corpus is commonly used, and can be downloaded from the Linguistic Dataset Consortium at [https://catalog.](https://catalog.ldc.upenn.edu/LDC2012T21)

[ldc.upenn.edu/LDC2012T21](https://catalog.ldc.upenn.edu/LDC2012T21). For downloading, a membership is mandatory, or otherwise fees apply. However, this commonplace in NLP research institutes.

Code We provide code to reproduce all our experiment in the supplementary materials.

Experiments We provide details on each experiment’s setup in the appendix. However, it’s impractical to report all details that may impact the outcome. Therefore, for each experiment we additionally provide a csv file in the supplementary material. The file contains information on all training parameters, model hyperparameters and results. In combination with the code, this allows to reconstruct almost the exact experimental setup used in our study apart from parameters that are beyond our control, such as the computation environment.

A Sentence Summarization

We perform experiments on unsupervised sentence summarization (Rush et al., 2015) for two main reasons. First, we would like to understand whether our conclusions hold for more tasks than just text style transfer. Second, the sentence summarization dataset consists of texts of medium length, between the length of Yelp-Review and Yelp-Sentences. This length is long enough to showcase the benefit of Transformer++, yet still computationally cheap enough to conduct this expensive ablation study.

A.1 Experimental Setup

In sentence summarization (Rush et al., 2015), the goal is to capture the essence of a sentence in fewer words. We evaluate on the Gigaword corpus (Graff et al., 2003) similar to Rush et al. (2015). This corpus consists of more than 8.5 million training samples, but we use a random subset of 500k to limit the computational cost. Inputs are on average 27 words long, which is medium length compared to the other two datasets in this study. We use moderately sized vectors of $d=128$ and again train different BoV-AEs with target ratios $r = 0.2, 0.4, 0.6, 0.8$. When applying the model to the sentence summarization downstream task, we train using the loss term $\mathcal{L}(\hat{\mathbf{z}}_y) = \mathcal{L}_{sim}(\mathbf{z}_x, \hat{\mathbf{z}}_y) + \lambda_{len}\mathcal{L}_{len}(\hat{\mathbf{z}}_y)$. This loss term is conceptually similar to the loss term used for style transfer, except that \mathcal{L}_{len} denotes the prediction of a model trained to predict the length of

the input text from the text’s latent representation (the shorter the better). We train with varying values of $\lambda_{len} = 0.1, 0.2, 0.5, 1, 2, 5, 10$ and select the best model (ROUGE-L) on the development set. Intuitively, this model learns to retain as much from the input as possible while minimizing the output length. Note that this model of summarization could certainly be improved further, e.g. by accounting for relevancy and informativeness of the output (Peyrard, 2019). However, our goal is not to create the best task-specific model possible, so these considerations are out of scope for this paper.

The input texts in this task are relatively long. Due to the higher number of vectors in a BoV, it may be difficult to learn the mapping, especially for large target ratios r . We experiment with Transformer++ to observe to what extent this can facilitate learning.

As is standard practice in summarization, we evaluate performance on this task with ROUGE-L (Lin, 2004). Note, however, that ROUGE scores can be misleading, because even texts that are as long or even longer than the input text can yield relatively high scores even though they are clearly not summaries. For this reason, we also report the average length of outputs produced by the models as reference.

A.2 Results

Figure 7 shows the development of the reconstruction loss on the validation set over the course of 2 million training steps. Despite the moderately large vector dimensionality, the single-vector bottleneck model achieves only considerably lower reconstruction performance than the BoV models. Again, larger target rates r lead to faster convergence, and all BoV models converge to approximately the same validation loss value (0.9). The only exception is **L0-0.2**, which converges to a higher loss value (1.25), but is still vastly stronger than the fixed size model (3.01).

However, as shown in Table 2, **L0-0.2** performs the best on the downstream task, outperforming the single-vector model by more than 5 ROUGE-L points while simultaneously requiring much fewer output words. BoV models with higher target ratios than $r=0.2$ perform worse. Moreover, the Transformer++ architecture tends to improve results, particularly with target rates $r > 0.2$. The ROUGE-L score itself does not improve for $r=0.2$,

Table 2: Results on Gigaword sentence summarization. Scores represent ROUGE-L with average output words in parentheses. T and T++ denote Transformer and Transformer++, respectively.

Model	T	T++
fixed	13.1 (18.3)	13.2 (17.6)
L0-0.2	19.8 (23.2)	18.3 (10.7)
L0-0.4	8.0 (18.7)	16.4 (12.5)
L0-0.6	6.6 (83.5)	14.7 (51.1)
L0-0.8	9.3 (5.1)	13.2 (48.6)

but note that this comes at the expense of more than doubling the output length. Also note that **L0-0.6** and **L0-0.8** only obtain relatively high scores because they produce long outputs that even exceed the length of the input. In fact, for $r = 0.6, 0.8$ no value of λ_{len} produces outputs that are reasonably good (> 10 ROUGE-L) and short (< 20 BLEU) at the same time.

The above results confirm both our hypotheses: First (**H1**), it is beneficial to use a BoV model over a single-vector model to reduce the compression issues induced by the fixed-size bottleneck. Secondly (**H2**), when using a BoV model, it is imperative to regularize the number of vectors in the bag as a way of smoothing the embedding space, making it easier to learn the mapping for unsupervised text generation tasks. Moreover, if the number of vectors in the bag is large, our Transformer++ architecture can substantially facilitate learning the mapping.

B Experimental Details

Here, we describe the experimental setup used in our experiments. We try to be exhaustive, but the exact training configurations and code will also be given as downloadable source code for reference.

B.1 Implementation

We implemented BoV-AEs and fixed-sized AEs within the codebase. Neural networks are implemented via PyTorch (Paszke et al., 2019). The code is provided with the supplementary material, and will be made available publicly under the MIT license when the paper is published. For each dataset, we train a new BPE tokenizer (Sennrich et al., 2015) via Huggingface tokenizer library (Wolf et al., 2019). We limit the vocabulary to the 30k most frequent tokens. We use NLTK (Bird et al., 2009) for computing sentence-wise BLEU scores and a Python-based reimplementation of

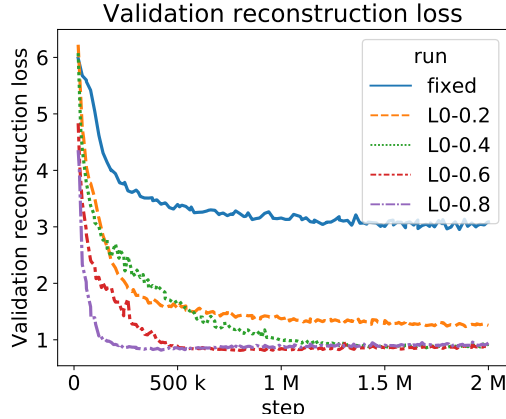

Figure 7: Reconstruction loss on the validation set of Gigaword for different autoencoders. **fixed**: The bag consists of a single vector obtained by averaging the embeddings at the last layer of the Transformer encoder. **L0-r**: BoV-AE with L0Drop target ratio r .

Table 3: Basic statistics for each dataset used in this study. Average number of words refers to input texts and output texts, respectively.

Dataset	avg. #words	#inputs	#outputs
Yelp-Sentences	9.7 / 8.5	177k	267k
Gigaword	27.2 / 8.2	500k	500k
Yelp-Reviews	56.1 / 48.7	500k	500k

ROUGE-1.5.5. for all ROUGE scores⁵. We run our experiments on single GPUs, which are available to us as part of a computation grid. Specific GPU assignment is outside of our control, and the specific GPUs vary between GeForce GTX Titan X and RTX 3090 in power.

We estimate the total computational cost of the experiments reported in this paper to be 7530 GPU hours. The majority of this cost is on autoencoder pretraining, which accounts for 6640h (cmp. 890h for downstream training). Due to the long inputs and relatively large models, pretraining on Yelp-Reviews is by far the most costly (5760h).

Note that a sufficiently large and generic model has to be pretrained only once and could be applied to a wide range of downstream tasks, as is the case for e.g. BERT. In our experiments, we had to pretrain on each corpus separately.

We estimate the computational budget over the whole development stage of this study to be around 25,000 GPU hours.

B.2 Autoencoder Pretraining

All autoencoders consist of standard Transformer encoders and decoders (Vaswani et al., 2017), with 3 encoder and decoder layers, respectively.

The Transformers have 2 heads and the dimensionality is set to the same as the latent vectors (Yelp-Reviews: 512, Yelp-Sentences: 32, Gigaword: 128). The total number of parameters of each model is shown in Table 4. BoV-AEs are marginally larger due to the L0Drop layers. In case of the fixed sized model, the representations at the last layer are averaged. Otherwise we perform L0Drop as described in Section 3. We set $\lambda_{L_0} = 10$ for all BoV models and only vary the target ratio. All models are trained with a dropout (Srivastava et al., 2014) probability of 0.1 and a denoising objective, i.e, tokens have a chance of 10% to be dropped from the sentence. We train the model with the Adam optimizer (Kingma and Ba, 2015) with an initial learning rate of $lr = 0.00005$ (Yelp-Reviews and Gigaword) or $lr = 0.0001$ (Yelp-Sentences) and a batch size of 64. We experimented with other learning rates (0.00005, 0.0005) for the fixed-size model on Yelp-Reviews, but the results did not improve. Models are trained for 2 million steps on Gigaword and Yelp-Reviews and for 1.5 million steps on Yelp-Sentences. We check the validation set performance every 20,000 steps and select the best model according to validation reconstruction performance.

All the above hyperparameters were set once

⁵<https://pypi.org/project/rouge-score/>

and not changed during the development of BoV-AEs, except for the learning rate of Adam. BoV-AE in particular is sensitive to this hyperparameter on the Yelp-Review dataset. We hence conducted a small grid search on $lr \in \{0.0005, 0.0002, 0.0001, 0.00005\}$ for **L0-0.2** to determine the best value reported above. We then used that same learning rate to all other configurations on Yelp-Reviews.

B.3 Downstream Task Training

After the autoencoder pretraining, we train downstream by freezing the parameters of the encoder and decoder. The dimensionality of the one-layer mapping Φ (a Transformer decoder with 4 heads) is set to the same as the latent representation (Yelp-Reviews: 512, Yelp-Sentences: 32, Gigaword: 128). We set the maximum number of output vectors to $N = 250$ on Yelp-Reviews and Gigaword, and $N = 30$ on Yelp-Sentences. The batch size is 64 for Yelp-Sentences and Gigaword and 16 on Yelp-Reviews. We train for 10 epochs on Yelp-Sentences and Gigaword, and for 3 epochs on Yelp-Reviews. The validation performance is evaluated after each epoch.

Losses: In all tasks we have two loss components. For \mathcal{L}_{sim} , we use differentiable Hausdorff unless specified otherwise (in the ablation). \mathcal{L}_{sty} and \mathcal{L}_{len} depend on classifiers / regressors, which we train separately after the autoencoder pretraining as a one-layer Transformer encoder. The embeddings are then averaged and plugged into a one-layer MLP whose hidden size is half of the input size and uses the tanh activation function. These classifiers are trained via Adam ($lr = 0.0001$) for 10 epochs and we evaluate the validation set performance after each. The total loss depends on a window size as described in Equation 5. For performance reasons (multiple computations of the loss), we set $k = 0$ unless specified differently.

B.4 Yelp-Reviews

B.4.1 Dataset

The dataset was obtained from <https://www.yelp.com/dataset> in May 2021. Our goal is to obtain texts long enough such they cannot be reconstructed by a reasonably sized autoencoder with a single-vector bottleneck. We find that to be the case when limiting ourselves to reviews of maximum 100 words. We apply this limit due to the computational complexity of Transformers on long

texts. Otherwise, we stick with similar filtering criteria as Shen et al. (2017): We only consider restaurant businesses. We consider reviews with 1 or 2 stars as negative, and reviews with 5 stars as positive. We don't consider reviews with 3 or 4 stars to avoid including neutral reviews. We subsample 400,000 positive and negative reviews for training, respectively, and use 50,000 for validation and test set each.

In order to demonstrate the usefulness of our model on long texts, we turn to the original Yelp dataset⁶. Our goal is to obtain texts long enough such they cannot be reconstructed by a reasonably sized autoencoder with a single-vector bottleneck. We find that to be the case when limiting ourselves to reviews of maximum 100 words⁷. Otherwise, we stick with similar filtering criteria as Shen et al. (2017): We only consider restaurant businesses. We consider reviews with 1 or 2 stars as negative, and reviews with 5 stars as positive. We don't consider reviews with 3 or 4 stars to avoid including neutral reviews. We subsample 400,000 positive and negative reviews for training, respectively, and use 50,000 for validation and test set each.

B.4.2 Downstream Training

For both the fixed-size model and the BoV model (**L0-0.1**), we choose the best learning rate among $lr = 0.0001$ and $lr = 0.0005$ on the validation set and report test set results. We train with $\mathcal{L}_{sty} \in \{0.1, 0.2, 0.5, 1, 2, 5, 10\}$, resulting in the scatter plot in Figure 3.

B.5 Yelp-Sentences

B.5.1 Dataset

Yelp-Sentences consists of the sentiment transfer dataset created by Shen et al. (2017), who made their data available at <https://github.com/shentianxiao/language-style-transfer/tree/master/data/yelp>. We use their data as is without further preprocessing. Table 3 presents some basic statistics about this dataset.

B.5.2 Downstream Training

We train BoV models with $\lambda_{sty} \in \{1, 2, 5, 10, 20, 50, 100\}$. To make sure that our results are not due to insufficient tuning, for the fixed-sized model, we use the following larger range:

⁶The dataset was obtained from <https://www.yelp.com/dataset> in May 2021.

⁷We apply this limit due to the computational complexity of Transformers on long texts.

	Yelp-Reviews	Yelp-Sentences	Gigaword
Fixed-size AE	14.578m	0.958m	2.758m
BoV-AE	15.1m	0.960m	2.725m

Table 4: Number of parameters of pretrained autoencoders.

{0.01, 0.02, 0.05, 0.1, 0.2, 0.5, 1, 2, 5, 10, 20, 50, 100} only reaches slightly better results after two million training steps. However, the plot shows clearly that **L0-0.05** has not converged, suggesting that **L0-0.05** could reach much better performance if trained for even longer.

B.5.3 Ablations

For the ablations on differentiable Hausdorff distance and the window size, we use the **L0-0.6** model. For each option, we train with $\mathcal{L}_{sty} \in \{0.1, 0.2, 0.5, 1, 2, 5, 10, 20, 40, 60, 80, 100\}$ and report the best value in terms of style transfer score on the validation set.

B.6 Sentence Summarization

B.6.1 Dataset

The dataset is based on the Gigaword corpus (Graff et al., 2003). We largely follow the preprocessing in (Rush et al., 2015), which we obtained from the paper’s GitHub repository at <https://github.com/facebookarchive/NAMAS>. Different from them, we convert all inputs and outputs to lower case and use a smaller split (1 million examples). We provide the scripts for constructing the dataset from a copy of the Gigaword corpus (which can be obtained from the Linguistic Dataset Consortium) together with the rest of our code.

B.6.2 Downstream Training

We train all models with $lr = 0.00005$. For each target ratio r and each of Transformer and Transformer++, we select the best $\lambda_{len} \in \{0.1, 0.2, 0.5, 1, 2, 5, 10\}$ in terms of ROUGE-L on the validation set and report test set results in Table 2.

C Additional Results

C.1 Yelp-Reviews

In Figure 8, we plot the reconstruction ability of the fixed-size model compared to the BoV-AEs on the validation set.

Again, despite a large dimensionality ($d = 512$), the single-vector model achieves substantially lower reconstruction ability than BoV-AE. With respect to the target sparsity rate, we find that $r = 0.1$ is enough to reach dramatically better results than the fixed-size model, whereas $r = 0.05$

C.2 Yelp-Sentences

The window size k determines which bag sizes around the input bag size we backpropagate from (cmp. Section 4.2). Here, we investigate its influence on the model’s performance. Since the λ_{sty} hyperparameter is very sensitive to other model hyperparameters, we train with varying λ_{sty} for each fixed window size and report the best style transfer score for each window size. In Figure 4, we plot the style transfer score as a function of the window size. Our results indicate that increasing the window size from zero (score 28.2) is beneficial up to some point ($k=5$, score 35.8), whereas increasing by too much ($k=20$, score 21.2) is detrimental to model performance even compared to a size of zero. We hypothesize that backpropagating bags that are either very small or very large is detrimental because it forces the model to adjust its parameters to optimize unrealistic bags, taking away capacity for fitting realistic bags.

C.2.1 Computation time

Our experiments have shown that bag-of-vector representations are more powerful than single-vector representations. However, the increased capacity of BoV-AE comes at the expense of higher computation time. The size of the latent representation impacts the computation time in two places: During cross-attention in the decoder and when computing the mapping. Asymptotically, the decoder’s cross-attention mechanism computes $\mathcal{O}(n \cdot |s|)$ dot-products, where n is the number of vectors in the latent representation and $|s|$ is the length of the text sequence s . When computing the mapping, both at training and inference time, we produce a fixed number N of vectors autoregressively, but in most applications, N can reasonably be bound by a linear function of n (e.g., $2n$ in style transfer or $0.5n$ in summarization). The mapping is essentially a Transformer decoder, so both the cross

attention and self attention parts compute $\mathcal{O}(n^2)$ dot-products. Given that $n = 1$ for single-vector AEs and $n = \mathcal{O}(|s|)$ for BoV-AEs with L0Drop, we obtain the asymptotic complexities as shown in Table 5.

To assess the empirical impact, we measure the wallclock time of Emb2Emb’s "Inference" stage (cf. Figure 2). We take separate measurements for encoding, mapping, and decoding, respectively. Since decoding speed depends on the quality of generation (e.g., when the end-of-sequence symbol is generated late due to repetitions), we do the following to enable fairer comparisons. We enforce the same fixed number of decoding steps (10) in all models. The mapping is set to produce as many output vectors as input vectors. We use a batch size of 1, but note that the results would largely extend to larger batch sizes when binned batching is used. The results are shown in Table 6.

Both the encoding and the mapping stages of Emb2Emb are more expensive in BoV models than in the fixed-size model. The difference in the encoding stage can be explained by the overhead through the L0Drop layer, which includes identifying near-zero gates and discarding their respective vectors. The difference in the mapping grows with higher L0Drop target ratios. This is expected since the number of autoregressive steps decreases with the target ratio. Finally, we do not observe any meaningful speed differences between the models at decoding time. This is somewhat surprising, but could be explained by two factors. First, the *self-attention* part of the decoder already has a complexity of $\mathcal{O}(|s|^2)$, which probably dominates the total computation time. Secondly, the computation of the dot-product is easy to parallelize. In summary, we find that BoV models are slower overall, especially in the mapping. However, since our L0Drop implementation prunes near-zero vectors, lower target rates mitigated the additional computation overhead. This is especially evident when comparing training speeds. While **L0-0.8** processes 15 sentences per second, **L0-0.4** processes can process 21 (fixed-size: 42).

C.2.2 Using Pretrained Autoencoders

The Emb2Emb framework is in principle compatible with any autoencoder. This enables us to leverage large-scale pretraining, which has proven to be a very powerful method in NLP recently, e.g. with BERT (Devlin et al., 2019). Due to the extremely high computational cost, training a large

BoV-AE on a large general-purpose corpus is out of scope for this paper. However, given the plug and play nature of Emb2Emb, we can build on top of BART (Lewis et al., 2020), which uses similar resources as BERT, but is trained via a denoising autoencoder objective. We can use this model either as is, or add an L0Drop layer between the encoder and decoder and finetune the model on our target dataset Yelp-Sentences.

For finetuning, we use the same training scheme as for our models, namely a denoising objective where we delete 10% of the input tokens from the input at random. The model is trained through Adam with a learning rate of 0.00005. We use an L0Drop target rate of 0.4. Our experimental results show that, when no L0Drop is used, the BART-based model gets to a validation reconstruction loss of 0.05 after only 5k training steps. This is a strong improvement over our best BoV models trained from scratch, which plateau at a loss of 1.0, demonstrating the power of large scale pretraining. With L0Drop, the model converges at roughly 0.29 after only 100k of finetuning, despite a relatively low target rate of 0.4.

When training on sentiment transfer downstream, we find the same pattern as for the models trained from scratch. If we don’t finetune BART at all or finetune without L0Drop, downstream training is unable to learn to both retain a high self-BLEU score and achieve high transfer accuracy. Whenever the transfer accuracy goes above 50%, self-BLEU goes to very small scores (< 1). However, when L0Drop is used, the model achieves 35 points in self-BLEU at a target accuracy of 61%. This confirms again our hypothesis that L0Drop regularization is needed to make the model work. In quantitative terms, BART with L0Drop is comparable to the BoV model **L0-0.4**, which was trained from scratch and achieves 55% accuracy and 38 points self-BLEU. Qualitatively, however, we observe that the pretrained model generates more fluent text. In Table 7, we show 10 randomly sampled examples of the model trained from scratch versus BART finetuned with L0Drop and a target rate of 0.4. While both models are relatively good at retaining words from the input text, the pretrained model generally produces text that is more grammatical and coherent than the model trained from scratch (see examples #1, #2, #3, #6, #9, #10). This can be attributed to the language model of BART, which was pretrained to generate human-written

Table 5: Asymptotic computation time in the Emb2Emb framework as a function of the latent representation size n and the length of the input text $|s|$, depending on the type of autoencoder.

AE type	Cross-Attention Decoding	Mapping
in general	$\mathcal{O}(n \cdot s)$	$\mathcal{O}(n^2)$
fixed	$\mathcal{O}(s)$	$\mathcal{O}(1)$
BoV-AE	$\mathcal{O}(s ^2)$	$\mathcal{O}(s ^2)$

Table 6: The number of seconds it takes to process 5% of the validation set (1264 samples) with a batch size of 1. Lower is better.

Model	Encoding	Mapping	Decoding
fixed	4.8	2.4	51.7
L0-0.4	7.2	12.6	50.1
L0-0.8	7.3	20.6	50.3

text from a large general-purpose corpus. Yet, the model outputs could clearly be improved further. We hypothesize that finetuning on a very domain-specific target dataset like Yelp-Sentences leads the model to quickly forget knowledge learned during pretraining, a phenomenon often observed with pre-trained language models (Yogatama et al., 2019). In the future, we would like to train a large BoV-AE model with L0Drop on a large general-purpose corpus, so that it can be used out of the box in the Emb2Emb framework for any task.

Table 7: 10 randomly sampled examples from Yelp-Sentences, evaluated on a BoV model trained with an LODrop target rate of 0.4 from scratch versus a model initialized with BART and finetuned with LODrop of 0.4.

#	Input sentence	Output of L0-0.4	Output of BART with LODrop
1	the restroom situation alone is enough for any woman to go crazy .	the restroom situation alone is enough for the woman to always good !	great restroom and that alone is worth it.
2	she would push my moms hands out of the way and just plain rude !	she would gain out my hands out of the way and so wonderful !	wow, they keep the ladies hands out!
3	i hate it when it takes _num_ minutes to get a cup of coffee .	i makes maggie pointing it she mr. r (, and wonderful !	love it when it takes _num_ minutes to get.
4	see update below .	see an frustrating .	see update below.
5	the way they submitted the loan was false which caused the decline on purpose .	the receptionist they always the inspection and she caused the stage is always !	the way they made the sale was very.
6	another bad italian take out story .	another bad italian of take new notch .	great, good italian pizza.
7	if you want a refrigerator , that 'll be _num_ extra .	if for ajo sons picky ' ' ' mien hemmed and huge !	great place, you 'll get a great.
8	get new staff , they were just terrible !	get the new staff , they were always terrible !	great food, great staff!
9	i recently visited while searching for a venue for a commitment ceremony and reception .	i found brake while select for venue for a workout and and wonderful !	wow, i recently visited this location for a wedding.
10	this place is why yelp should allow zero stars .	this place is that yelp who should not great !	this place is great if you love starbucks.

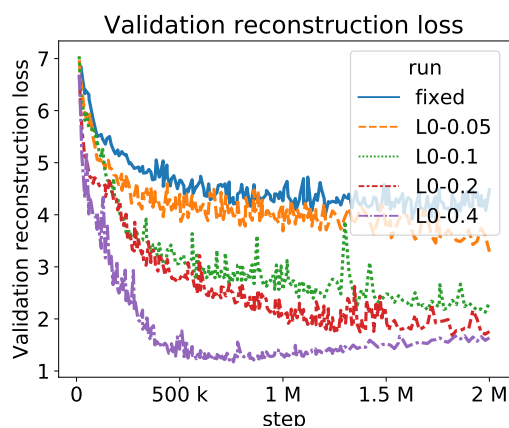

Figure 8: Reconstruction loss on the validation set of Yelp-Reviews for different autoencoders. **fixed**: The bag consists of a single vector obtained by averaging the embeddings at the last layer of the Transformer encoder. **L0-r**: BoV-AE with LODrop target ratio r .