

# Gaussian Broadcast Channels in Heterogeneous Blocklength Constrained Networks

Pin-Hsun Lin<sup>†</sup>, Shih-Chun Lin<sup>‡</sup>, Peng-Wei Chen<sup>‡</sup>, Marcel Mross<sup>†</sup>, and  
Eduard A. Jorswieck<sup>†</sup>

<sup>†</sup>Institute for Communication Technology,

Technische Universität Braunschweig, Germany

<sup>‡</sup>Department of Electrical and Computer Engineering,

National Taiwan University of Science and Technology, Taiwan,

Email: {Lin, Jorswieck}@ifn.ing.tu-bs.de,

sclin2@ntu.edu.tw, M10802280@mail.ntust.edu.tw, m.mross@tu-braunschweig.de

## Abstract

Future wireless access networks will support simultaneously a large number of devices with heterogeneous service requirements. These include data rates, error rates, and latencies. While there exist achievable rate and capacity results for Gaussian broadcast channels in the asymptotic regime, the characterization of second-order achievable rate regions for different blocklength constraints are not available. Therefore, we investigate a two-user Gaussian broadcast channel (GBC) with heterogeneous blocklength constraints, specified according to users' channel output signal to noise ratios (SNRs) under a maximal input power constraint and an average error probability constraint. Unlike the traditional GBC where two users have the same blocklength constraints, here the user with higher output SNR has a shorter blocklength constraint. We show that with sufficiently large output SNR, the stronger user can invoke the technique named *early decoding* (ED) to decode the interference. Then the successive interference cancellation (SIC) can proceed. This leads to an improved achievable rate region compared to the state of the art. To achieve it, we derive an explicit lower bound on the necessary number of received symbols for a successful ED, using an independent and identically distributed Gaussian input. A second-order rate of the weaker user who suffers from an SNR change due to the heterogeneous blocklength constraint, is also derived. We then formulate

Part of the work is presented in ISIT 2021 [1].

arXiv:2109.07767v1 [cs.IT] 16 Sep 2021

the rate region of the considered setting with individual and also sum power constraints and compare to that of the hybrid non-orthogonal multiple access (HNOMA) scheme. Numerical results show that ED has a larger rate region than HNOMA partly when the gain of the better channel is sufficiently larger than the weaker one. Under the considered setting, about 7-dB SNR gain can be achieved. This makes ED with SIC a promising technique for future wireless network.

## I. INTRODUCTION

Ultra-reliable and low-latency communication (URLLC) is one of the target application scenarios in 5G and beyond [2], [3], [4], which has attracted many research efforts. One important branch is finite blocklength analysis [5], which has been extended to different multiuser cases such as the multiple access channel [6], asymmetric broadcast channel [7], Gaussian broadcast channel [8] (GBC), and the channel with state [9]. For 5G, the flexibility for resource allocation was obtained by fine numerology [10]. Within each service class, most studies considered homogeneous blocklength and latency constraints among the users. The latency quality of service under different channel conditions among users are required. Therefore, we consider heterogeneous blocklength among users. However, almost all the analyses of multiuser channels in the finite blocklength regime assume the same blocklength among all the users. In practice, due to different requirements of latency, quality of service, and different channel conditions among users, heterogeneous blocklengths among users should be considered.

The GBC with heterogeneous blocklength constraints is considered in [11], [12]. In [11], hybrid non-orthogonal multiple access (HNOMA) is analyzed, where treating interference as noise (TIN), normal superposition coding (homogeneous blocklength at all users) with successive interference cancellation (SIC), and time-division multiple access (TDMA) are used in this case. In particular, the weaker user's codeword is divided into two shorter codewords, where one of them has the same blocklength as that of the stronger user. Therefore, the normal superposition coding with SIC can be applied. In [12], after TDMA transmission, a user is forced to decode both the intended and interference codewords. Such decoding is similar to decode a common message in a GBC and the rate is limited by the link with the lower output SNR. Aside from the above, one unsolved

but important issue is how to perform the celebrated superposition coding with SIC under this setting. More specifically, for the user with a higher output signal-to-noise ratio (SNR) but shorter blocklength in a two-user GBC, it is unclear whether SIC can be performed or not.

In contrast to [11], [12], we argue that the stronger user with sufficiently large output SNR can still decode the interference to perform SIC based on the partially received symbols. The key is using the early decoding (ED) technique as follows: assume that a code is designed for a channel with a specific output SNR under a specific error probability and blocklength. Via ED, the codewords can be decoded using code symbols less than the blocklength of the original one, i.e., earlier, when being transmitted through a better channel. This concept has been investigated with traditional first-order asymptotic analysis in [13], which tells us that a user who has higher output SNR than the other can decode successfully using fewer received symbols. The concept of ED has already been used in several wireless scenarios, not only to improve the latency performance, but also to increase the throughput of a network. A popular application of ED is in cognitive radio (CR) [14]. In addition to [13], there are further works about ED. In [15] the ED is applied to short message noisy network coding under the same asymptotic assumption as in [13]. In [16], the authors consider the necessary number of symbols for ED for binary input channels via numerical simulations under a finite blocklength assumption.

Our main contributions are as follows:

- We consider a two-user GBC with heterogeneous blocklength constraints and two private messages while the seminal SIC is applied at the stronger receiver, which has not yet been reported in the literature. We consider the case in which the user having higher output SNR is constrained by a shorter (stricter) blocklength constraint,
- We derive a second-order lower bound on the necessary number of received symbols such that ED works, while fulfilling the input power and error probability constraints, to guarantee that the first step of SIC, i.e., decoding the interference, is feasible. In particular, we analyze the dependence testing (DT) bound over a fixed code instead of using Shannon's random coding scheme, to ensure that a specific code can be decoded when being transmitted through two

different channels while fulfilling the aforementioned constraints. The stronger user can avoid using the TIN as [11] by applying the ED to validate SIC. As a result, the stronger user's rate can be improved. We also derive the second-order rate of the weaker user, whose received symbols encounter an SNR change due to the heterogeneous blocklengths.

- Based on the derived second-order rates of the stronger and weaker users in a GBC, we formulate the rate region problems for ED and HNOMA, when considering the error probability and power constraints. In particular, we consider both individual power constraint (IPC) and sum power constraint (SPC), and solve the corresponding programming problems.
- Numerical results show that the ED can significantly reduce latency in the finite blocklength regime. Under the considered setting, more than 10dB SNR gain can be achieved. In addition, ED partly outperforms HNOMA regarding to the sum rate and the rate region, when the stronger user has a channel sufficiently better than the weaker user's. Therefore, a hybrid system combining ED and HNOMA is the best known achievable scheme.

This paper is organized as follows. In Section II we introduce the system model and preliminaries. In Section III we show our main result: the minimum received symbols for a successful ED. In addition, we derive the weaker user's second-order rate, under both IPC and SPC. In Section IV we show the performance improvements numerically. We conclude this paper in Section V.

*Notation:* Upper/lower case normal letters denote random/deterministic variables. Upper case calligraphic letters denote sets. The notation  $a_i^j$  denotes a row vector  $[a_i, a_{i+1}, \dots, a_j]$  while  $a_1^j$  is simplified to  $a^j$ . We denote the inner product of two vectors  $a^j$  and  $b^j$  by  $\langle a^j, b^j \rangle$ . The probability of event  $\mathcal{A}$  is denoted by  $\Pr(\mathcal{A})$ . The expectation and variance are denoted by  $\mathbb{E}[\cdot]$  and  $\text{Var}[\cdot]$ , respectively. We denote the probability density function (PDF) and cumulative distribution function (CDF) of a random variable  $X$  by  $f_X$  and  $F_X$ , respectively. The random variable  $X$  following the distribution with CDF  $F$  is denoted by  $X \sim F$ .  $\text{Unif}(a, b)$  denotes the uniform distribution between  $a \in \mathbb{R}$  and  $b \in \mathbb{R}$ . We use  $X \perp\!\!\!\perp Y$  to denote that  $X$  and  $Y$  are stochastically independent. The logarithms used in the paper are all with respect to base 2. We define  $C(x) \triangleq \frac{1}{2} \log(1+x)$ . Real

additive white Gaussian noise (AWGN) with zero mean and variance  $\sigma^2$  is denoted by  $\mathcal{N}(0, \sigma^2)$ . We denote the indicator function and identity matrix with dimension  $n$  by  $\mathbb{1}$  and  $\mathbf{I}_n$ , respectively. We denote the inverse  $Q$ -function by  $Q^{-1}(\cdot)$  and the big-O and small-o in Landau symbol by  $O(\cdot)$  and  $o(\cdot)$ , respectively.

## II. SYSTEM MODEL AND PRELIMINARIES

### A. System Model

We consider a two-private-message GBC where user  $k \in \{1, 2\}$ , has a blocklength constraint  $n_k \in \mathbb{N}^+$ . We assume  $n_1 \geq n_2$ . The received signal at user  $k$  at time  $i$  is then given as follows:

$$Y_{k,i} = \begin{cases} \sqrt{h_k}(X_{1,i} + X_{2,i}) + Z_{k,i}, & i \in \{1, \dots, n_2\}, \\ \sqrt{h_k}X_{1,i} + Z_{k,i}, & i \in \{n_2 + 1, \dots, n_1\}, \end{cases} \quad (1)$$

where  $Z_{1,i} \sim \mathcal{N}(0, 1)$  and  $Z_{2,i} \sim \mathcal{N}(0, 1)$ ,  $i \in \{1, \dots, n_1\}$ , are independent and identically distributed (i.i.d.) and mutually independent additive white Gaussian noises. Assume that the channel gains are deterministic and known perfectly to the transmitters and the receivers. We consider the scenario  $h_2 \geq h_1$ , which means that the user with a weaker channel is allowed to have a longer blocklength constraint in order to ensure a certain quality of service. The above system model is summarized in Fig. 1. As in [11], [12], the superposition coding is used, while the codewords of the two codes are i.i.d. Gaussian distributed, i.e.,  $X_{k,i} \sim \mathcal{N}(0, P_k)$ ,  $i \in \{1, \dots, n_k\}$ ,  $k = 1, 2$ , and  $\{X_{1,i}\}$  and  $\{X_{2,i}\}$  are mutually independent. Note that a direct use of the conventional SIC may not work in this scenario due to the blocklength constraint. Define two message sets  $\mathcal{M}_k := \{1, \dots, M_k(P_k, n_k, \epsilon_k)\}$ ,  $k = 1, 2$ , where  $P_k$  and  $\epsilon_k$  are the output SNR and target error probability at user  $k$ , respectively. Define the average error probability of each user as  $\epsilon_{n_k} := \frac{1}{M_k} \sum_{m_k=1}^{M_k} \Pr(\hat{m}_k \neq m_k \text{ at user } k | m_k \text{ is sent}) \leq \epsilon_k$ ,  $\hat{m}_k$  is the estimate of  $m_k$ ,  $k = 1, 2$ , and  $M_k$  is the message size of user  $k$ . We consider  $\epsilon_k \leq \frac{1}{2}$ ,  $k = 1, 2$ . In the following, we will use  $M_k(P_k, n_k, \epsilon_k)$  interchangeably with  $M_k$ , as long as it does not incur confusion. We consider the maximal power constraint as follows

$$\|x_k^{n_k}(m_k)\|^2 \leq n_k P_k, \text{ for all } m_k \in \mathcal{M}_k, k = 1, 2. \quad (2)$$

The considered code  $(M_1(P_1, n_1, \varepsilon_1), M_2(P_2, n_2, \varepsilon_2), n_1, n_2)$ ,  $n_1 > n_2$ , consists of two message sets  $\mathcal{M}_1$  and  $\mathcal{M}_2$ , one encoder:  $(m_1, m_2) \in \mathcal{M}_1 \times \mathcal{M}_2 \mapsto x^{n_1}(m_1, m_2)$  and two decoders, where decoder  $k$  assigns an estimate  $\hat{m}_k \in \mathcal{M}_k$  or an error message, to each received sequence  $y_k^{n_k}$ ,  $k = 1, 2$ .

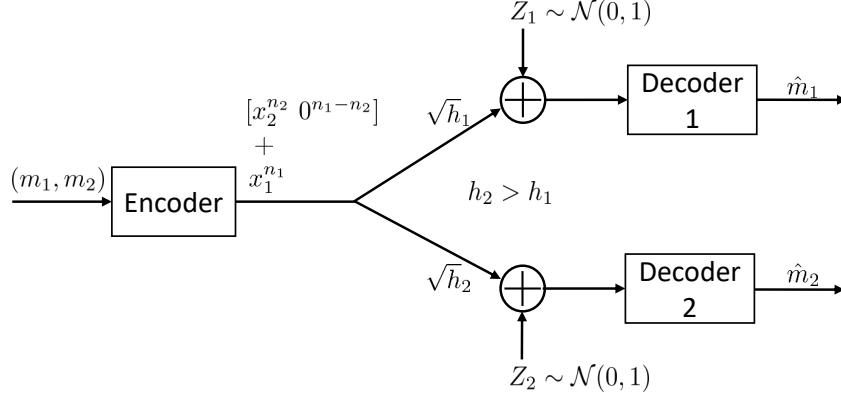

Fig. 1: The considered 2-user GBC with heterogeneous blocklength constraints.

Assume the message tuple  $(m_1, m_2)$  is uniformly selected from  $\mathcal{M}_1 \times \mathcal{M}_2$ . The average error probability of the whole system is defined as

$$P_e^{n_1, n_2} := \frac{1}{M_1 M_2} \sum_{(m_1, m_2) = (1, 1)}^{(M_1, M_2)} \Pr(\hat{m}_1 \neq m_1 \text{ or } \hat{m}_2 \neq m_2 | (m_1, m_2) \text{ is sent}). \quad (3)$$

A rate tuple  $(\frac{\log M_1}{n_1}, \frac{\log M_2}{n_2})$  is achievable, if there exists a sequence of  $(M_1, M_2, n_1, n_2)$  codes such that  $P_e^{n_1, n_2} \leq \varepsilon$ , where  $\varepsilon \in (0, 1)$  is a predefined constant. Denote the sets of codewords of both users fulfilling (2) as  $\mathcal{F}_k^{n_k}$ ,  $k = 1, 2$ , respectively. If not all  $M_k$  codewords belong to  $\mathcal{F}_k^{n_k}$ ,  $k = 1, 2$ , an encoding error is declared.

### B. Preliminaries

When  $n_1 = n_2$ , user 2 can perform the traditional two-step SIC. The first step is decoding user 1's codeword and removing this interference. Next, user 2 decodes his own codeword. However, with  $n_1 > n_2$ , it is not clear that whether the first step of SIC is still feasible. This motivates the ED for this step. We first define a successful ED as follows.

**Definition 1.** A successful early decoding means that the user with higher output SNR (user 2) can decode the weaker user's (user 1's) message from the first  $\tilde{n}_1$  received symbols:  $Y_2(1), Y_2(2), \dots, Y_2(\tilde{n}_1)$ , where  $\tilde{n}_1 \leq n_2 < n_1$ , while the resulting error probability fulfills the desired one.

We revisit the Berry-Esseen theorem [17], which is the core of the second-order rate analysis by Gaussian approximation.

**Theorem 1.** Consider independent random variables  $W_j$ ,  $j = 1, \dots, n$  with  $\mu_j = \mathbb{E}[W_j]$ ,  $\sigma_j^2 = \text{Var}[W_j]$ ,  $t_j = \mathbb{E}[|W_j - \mu_j|^3]$ . Let  $V = \sum_{j=1}^n \sigma_j^2$  and  $T = \sum_{j=1}^n t_j$ . Then

$$\left| \Pr \left( \frac{\sum_{j=1}^n (W_j - \mu_j)}{\sqrt{V}} \leq \lambda \right) - Q(-\lambda) \right| \leq 6 \frac{T}{V^{3/2}}, \quad (4)$$

where  $Q(x) := \frac{1}{\sqrt{2\pi}} \int_x^\infty \exp\left(-\frac{u^2}{2}\right) du$ .

Note that the channel output distribution of (1) is still jointly Gaussian when  $n_2 < n_1$ , if an i.i.d. Gaussian codebook is used. From [5] we know that the second-order achievable rate of a point to point channel by i.i.d. Gaussian input, which is from a special case of our model by nulling  $m_2$  and letting  $h = h_1$ ,  $n = n_1$ ,  $\varepsilon = \varepsilon_1$ , and  $\mathbf{P} = \mathbf{P}_1$ , can be derived from (4) as follows:

$$\mathbf{R} \leq \mathbf{C}(h\bar{\mathbf{P}}) - \sqrt{\frac{V_G(h \cdot \bar{\mathbf{P}})}{n}} Q^{-1}(\varepsilon) + o(n^{-1}), \quad (5)$$

where  $V_G(\bar{\mathbf{P}}) := \log^2 e \cdot \frac{\bar{\mathbf{P}}}{1+\bar{\mathbf{P}}}$  and  $\bar{\mathbf{P}} := \mathbf{P} - \delta$ ,  $\delta > 0$ .

### III. MAIN RESULTS

In this section we introduce our main results: the necessary number of received symbols for a successful ED at the stronger user, followed by the second-order rate at the weaker user under IPC and SPC.

#### A. Early Decoding at The Stronger User (User 2)

In the following, we apply the concept of ED to a two-user GBC with SIC and individual latency constraints at each user. With the ED, user 2 who has a higher output SNR than that of user 1, can perform SIC while fulfilling the stricter latency constraint  $n_2$ . Then his rate is improved compared to the case where the stronger user can only treat interference as noise without using the ED.

Recall the latency constraints at users 1 and 2 by  $n_1$  and  $n_2$ , respectively and we assume  $h_1 \leq h_2$  and  $n_2 \leq n_1$ . We have the following result.

**Theorem 2.** Denote the necessary number of symbols to successfully early decode user 1's signal at user 2 by  $\tilde{n}_1$ . If

$$n_2 \geq \tilde{n}_1 \geq \frac{\log M_1}{C(\tilde{h}_{20}\bar{P}_1) - \log e \cdot \frac{\tilde{h}_{20}\bar{P}_1}{2(1+\tilde{h}_{20}\bar{P}_1)}} + \frac{\log e \sqrt{4\tilde{h}_{20}\bar{P}_1 + 2(\tilde{h}_{20}\bar{P}_1)^2} Q^{-1}(\epsilon_{SIC1})}{2(1 + \tilde{h}_{20}\bar{P}_1)C(\tilde{h}_{20}\bar{P}_1) - \log e \cdot \tilde{h}_{20}\bar{P}_1} \cdot \sqrt{n_1} \quad (6)$$

holds, then user 2's second-order rate is interference free as follows

$$R_{2,ED} \leq C(h_2\bar{P}_2) - \sqrt{\frac{V_G(h_2\bar{P}_2)}{n_2}} Q^{-1}(\epsilon_{SIC2}) + O(n_2^{-1}), \quad (7)$$

where  $\bar{P}_k := P_k - \delta, k = 1, 2, \delta > 0$ ,  $\epsilon_{SIC1}$  and  $\epsilon_{SIC2}$  are the target decoding error probabilities of  $m_1$  and  $m_2$  at user 2, at the 1st and 2nd step of SIC, respectively,  $\tilde{h}_{20} := \frac{h_2}{1+h_2\bar{P}_2}$ , and  $\tilde{h}_{20}\bar{P}_1$  is the equivalent output SNR at user 2 in the first step of SIC. In that case, the ED is successful.

Note that the ED scheme can be naturally applied to a two-user GBC with a common-message and different blocklengths. That is, a common message  $m_1$  is sent, and the signal received at time  $i$  at user  $k$  is  $Y_{k,i} = \sqrt{h_k}X_i + Z_{k,i}, i = 1, \dots, n_k$ , where  $X_i \sim \mathcal{N}(0, \bar{P})$  is the transmitted symbol at time  $i$ . Receiver  $k$  wants to decode  $m_1$  through  $n_k$  received symbols. Then Theorem 2 can be specialized as follows.

**Corollary 1.** An i.i.d. Gaussian channel code satisfying the maximal power constraint under average error probability constraint with a number of common messages  $M_1(h_1\bar{P}, n_1, \epsilon)$ , can be decoded with an average error probability smaller than or equal to  $\epsilon$  for both receivers when  $h_2 > h_1$  and  $n_2 < n_1$ , if  $n_2$  is no smaller than the RHS of (6), where  $\tilde{h}_{20}$  in (6) is replaced by  $h_2$ .

**Remark 1.** We can compare Corollary 1 to the asymptotic case. Denote the feasible lower bound of  $\tilde{n}_1$  derived from Corollary 1 by  $g(n_1)$ . Then we have the following

$$\lim_{n_1 \rightarrow \infty} \frac{\tilde{n}_1}{n} \geq \lim_{n_1 \rightarrow \infty} \frac{g(n_1)}{n_1} = \frac{C(h_1\bar{P})}{C(h_2\bar{P}) - \frac{\log e \cdot h_2\bar{P}}{2(1+h_2\bar{P})}} \quad (8)$$

$$> \frac{C(h_1\bar{P})}{C(h_2\bar{P})}, \quad (9)$$

where (9) is the asymptotic result for the ED [13]. The strict inequality comes from the fact that to obtain (87), we omit the second term on the RHS of (85), which is used to lower bound the term inside the  $Q$ -function during error analysis.



Remark 2. By comparing Corollary 1 and (6) we can find that, the self-interference in superposition coding makes a stringent constraint on  $\tilde{h}_{20}$ , i.e.,  $\tilde{h}_{20}$  cannot be arbitrarily large as  $h_2$  in (1). Hence, a feasible range of  $h_2$  and  $\bar{P}_2$  to have a reasonable latency reduction by ED will be sufficiently large  $h_2$  and sufficiently small  $\bar{P}_2$ , respectively.

Remark 3. Solving  $n_2$  directly from the rates averaged over codebook ensembles as

$$C(h_1\bar{P}) \cdot n_1 - \sqrt{V_G(h_1\bar{P})\sqrt{n_1}}Q^{-1}(\epsilon_{SIC1}) = C(h_2\bar{P}) \cdot n_2 - \sqrt{V_G(h_2\bar{P})\sqrt{n_2}}Q^{-1}(\epsilon_{SIC1}), \quad (10)$$

is not rigorous since we need to guarantee that the same code can be successfully decoded by the normal decoder at the original channel output and also, can be successfully decoded by the ED at the output of the better channel. In addition, it may be possible to use a different way to prove it, e.g., by Feinstein's lemma as used in [5] to derive the  $\kappa\beta$  bound. However, whether this bound can reach to a closed-form solution for  $n_2$  is unknown.

In contrast, without using ED or when (6) is violated, TIN is used. Then user 2's second-order rate becomes

$$R_{2,TIN}(\epsilon_2) \leq C(\tilde{h}_2\bar{P}_2) - \sqrt{\frac{V_G(\tilde{h}_2\bar{P}_2)}{n_2}}Q^{-1}(\epsilon_2) + O(n_2^{-1}), \quad (11)$$

where  $\tilde{h}_2 := \frac{h_2}{1+h_2\bar{P}_1}$  and  $\epsilon_2$  is the target error probability. We will show the improvement of (7) from (11) in the next section.

### B. Second-order Rate of the Weaker User (User 1)

In this section we derive the weaker user's second-order rate. To proceed, recall that user 1 has a channel gain smaller than user 2 and  $n_1 > n_2$ . User 1's  $i$ -th received symbol can be equivalently expressed as  $\tilde{Y}_{1,i} = \sqrt{g_i} \cdot X_{1,i} + Z_{1,i}$ , where

$$g_i = \begin{cases} \frac{h_1}{1+h_1\bar{P}_2}, & i = 1, \dots, n_2 \\ h_1, & i = n_2 + 1, \dots, n_1, \end{cases} \quad (12)$$

where  $Z_1^{n_1} \sim \mathcal{N}(\mathbf{0}, \mathbf{I}_{n_1})$ . In the following, we derive user 1's second-order rate. Define

$$\text{SNR}_{11} := \frac{h_1\bar{P}_1}{1+h_1\bar{P}_2}, \quad \text{SNR}_{21} := \frac{h_2\bar{P}_1}{1+h_2\bar{P}_2}, \quad \text{SNR}_{12} := h_1\bar{P}_1, \quad \text{and} \quad \text{SNR}_{22} := h_2\bar{P}_2 \quad (13)$$

and

$$p := \frac{n_2}{n_1}. \quad (14)$$

The weaker user's second-order rate when ED with individual power constraint is used, is shown as follows.

**Proposition 1.** *Given a target average error probability  $\epsilon_1$ , the maximal individual power constraints  $\bar{P}_1$  and  $\bar{P}_2$ , the blocklengths  $n_1 > n_2$ , and channel gains  $h_2 > h_1$ , while assuming  $p$  is fixed, the second-order achievable rate  $R_{1,ED}$  of user 1 is as follows*

$$R_{1,ED}(\epsilon_1) \leq \bar{C}_1 - \sqrt{\frac{\bar{V}_1}{n_1}} Q^{-1}(\epsilon_1) + O(n_1^{-1}), \quad (15)$$

where

$$\bar{C}_1 := pC(g_1\bar{P}_1) + (1-p)C(h_1\bar{P}_1), \quad (16)$$

$$\bar{V}_1 := \log^2 e \cdot \left\{ p \frac{g_1\bar{P}_1}{1+g_1\bar{P}_1} + (1-p) \frac{h_1\bar{P}_1}{1+h_1\bar{P}_1} \right\}, \quad (17)$$

$$g_1 := \frac{h_1}{1+h_1\bar{P}_2}. \quad (18)$$

The proof is relegated to Appendix III.

### C. Satisfaction of the sum power constraint

Now, we consider the sum power constraint (SPC). The SPC of the heterogenous blocklength constraints is stated as follows

$$\sum_{j=1}^{n_2} (x_{1,j}(m_1) + x_{2,j}(m_2))^2 + \sum_{j=n_2+1}^{n_1} x_{1,j}^2(m_1) \leq n_1 P_T, \quad (19)$$

for all  $m_k \in \mathcal{M}_k$ ,  $k = 1, 2$ .

Because the cross-term in the first term on the LHS of (19) complicates the power allocation, we consider the following sum power constraint instead, for the following derivation and simulation:

$$\sum_{j=1}^{n_2} (x_{1,j}^2 + x_{2,j}^2) + \sum_{j=n_2+1}^{n_1} x_{1,j}^2 \leq n_1 P_T. \quad (20)$$

The validity of considering (20) instead of (19) is derived as follows. We first assume

$$\sum_{j=1}^{n_2} x_{1,j}^2(m_1) \leq n_2 P_{11}, \quad \sum_{j=1}^{n_2} x_{2,j}^2(m_2) \leq n_2 P_2, \quad \sum_{j=n_2+1}^{n_1} x_{1,j}^2(m_1) \leq (n_1 - n_2) P_{12}, \quad (21)$$

for all  $m_k \in \mathcal{M}_k, k = 1, 2$ . Then we can consider the following power constraint instead of (19)

$$n_2(\mathbf{P}_{11} + \mathbf{P}_2) + (n_1 - n_2)\mathbf{P}_{12} \leq n_1\mathbf{P}_T. \quad (22)$$

In short, if (21) and (22) are fulfilled, then the probability that the constraint in (19) is upper bounded by  $e^{-O(n_2)}$ . This statement is proved in the following lemma. Note that without incurring confusion, in the following we neglect the parameterized  $m_1$  and  $m_2$  in codewords to simplify the notation.

**Lemma 1.** *Let  $X_{1,j} \sim \mathcal{N}(0, \bar{\mathbf{P}}_{11}), X_{2,j} \sim \mathcal{N}(0, \bar{\mathbf{P}}_2), \{X_{1,j}\} \perp \{X_{2,j}\}, j = 1, \dots, n_2$  and  $X_{1,j} \sim \mathcal{N}(0, \bar{\mathbf{P}}_{12}), j = n_2 + 1, \dots, n_1$ , where  $\bar{\mathbf{P}}_{11} = \mathbf{P}_{11} - \delta, \bar{\mathbf{P}}_{12} = \mathbf{P}_{12} - \delta$ , and  $\bar{\mathbf{P}}_2 = \mathbf{P}_2 - \delta, \delta > 0$ . Then*

$$\Pr \left( \sum_{j=1}^{n_2} (X_{1,j} + X_{2,j})^2 + \sum_{j=n_2+1}^{n_1} X_{1,j}^2 > n_1\mathbf{P}_T \right) \leq e^{-O(n_2)} \quad (23)$$

and

$$\Pr \left( \sum_{j=1}^{n_2} (X_{1,j}^2 + X_{2,j}^2) + \sum_{j=n_2+1}^{n_1} X_{1,j}^2 > n_1\mathbf{P}_T \right) \leq e^{-O(n_2)}. \quad (24)$$

The proof is relegated to Appendix IV. The main idea is to treat the event  $\sum_{j=1}^{n_2} x_{1,j}x_{2,j} \geq n_2\delta$  as an outage and collect the input violation probability  $\Pr(\sum_{j=1}^{n_2} X_{1,j}X_{2,j} \geq n_2\delta)$  into the big-O term during error analysis. After that, we use the concept of power back-off to ensure that by selecting  $2n_2\delta$  as the power back-off, the total energy that is allocated to  $\sum_{j=1}^{n_1} x_{1,j}^2$  and  $\sum_{j=1}^{n_2} x_{2,j}^2$  will be no larger than  $n_1\mathbf{P}_T - 2n_2\delta$  with probability close to 1.

*Remark 4. Note that as the first step to investigate the ED, we consider i.i.d. Gaussian input instead of the shell input. For performances under the individual power constraint, the derived proof steps for an error probability upper bound which is uniform with respect to the given codewords, are feasible for shell code. In contrast, for performance under the sum power constraint, the sub-exponential property used in Appendix IV may not be valid. Then we may not meet the sum power constraint by simply using (22).*

We extend the analysis in Proposition 1 to the case where (20) is considered, as follows.

**Proposition 2.** *Given a target average error probability  $\epsilon_1$ , the sum power constraint (20), the blocklengths  $n_1 > n_2$ , and channel gains  $h_2 > h_1$ , the achievable rate  $R'_{1,ED}(\epsilon_1)$  of user 1, who uses a single code with blocklength  $n_1$ , is as follows*

$$R'_{1,ED}(\epsilon_1) \leq \max_{\bar{P}_{1,1}, \bar{P}_{1,2}, \bar{P}_2} \bar{C}'_1 - \sqrt{\frac{\bar{V}'_1}{n_1}} Q^{-1}(\epsilon_1) + O(n_1^{-1}) \quad (25)$$

$$\text{s. t. } p\bar{P}_{1,1} + (1-p)\bar{P}_{1,2} \leq P_T - p\bar{P}_2 \quad (26)$$

$$\bar{P}_{1,1} \geq 0, \bar{P}_{1,2} \geq 0, \bar{P}_2 \geq 0, \quad (27)$$

where

$$\bar{C}'_1 := pC(g'_1\bar{P}_{1,1}) + (1-p)C(h_1\bar{P}_{1,2}), \quad (28)$$

$$\bar{V}'_1 := \log^2 e \cdot \left\{ p \frac{g'_1\bar{P}_{1,1}}{1+g'_1\bar{P}_{1,1}} + (1-p) \frac{h_1\bar{P}_{1,2}}{1+h_1\bar{P}_{1,2}} \right\}, \quad (29)$$

$$g'_1 := \frac{h_1}{1+h_1\bar{P}_2}. \quad (30)$$

The proof is relegated in Appendix V.

*Remark 5. The converse for the 2-user GBC in finite blocklengths regime is open [8], not to mention the heterogeneous blocklength scenarios. Note that in asymptotic cases when deriving the outer bound, e.g., by the seminal Sato-type outer bound [18], we need the same marginal property to tighten the capacity of the super-single user channel with cooperative receivers. However, the same marginal property may not be valid in general for finite blocklength regime, because the joint error probability and the individual error probabilities are all non-zero and then we cannot squeeze the joint error probability solely by the individual error probabilities. How to solve this difficulty is our on-going work.*

#### IV. NUMERICAL RESULTS

In this section, we first show the sum rate and rate region formulation of the ED and HNOMA schemes and then show the latency reduction of ED and the sum-rate/rate region comparison through numerical schemes.

### A. Rate Region Formulation

In the following, we consider weighted sum-rate optimization problems for the ED and the HNOMA. Denote the target error probabilities at receivers 1 and 2 by  $\epsilon_1$  and  $\epsilon_2$ , respectively. Denote the rates at receivers 1 and 2 by  $R_1$  and  $R_2$ , respectively. Let the intermediate variables  $\epsilon_{SIC_k}$ ,  $k = 1, 2$ , denote the target error probabilities of decoding user  $k$ 's messages at the  $k$ -th step of SIC at receiver 2, respectively. Let  $\epsilon_1^{ED}$  denote the target error probability of decoding user 1's messages at receiver 1. Let  $\epsilon_{1,j}^{HNOMA}$ ,  $j = 1, 2$  denote the target error probabilities of the sub-blocks 1 and 2, respectively, when HNOMA is used. Note that sub-block 1 and 2 are codewords with blocklengths  $n_2$  and  $n_1 - n_2$ , respectively. Define the weighting  $\omega_1$  and  $0 \leq \omega_1 \leq 1$ . Note that to optimize the sum-rate and rate region, the inequalities in the error probability constraints should be equality, due to the tradeoff between the error probability and the rate in finite blocklength analysis.

We therefore formulate a modified optimization problem as follows:

**P<sub>1</sub><sup>IPC</sup>** (enhanced weighted sum-rate of HNOMA with IPC):

$$\max \quad \omega_1 R_1(\epsilon_{1,1}^{HNOMA}, \epsilon_{1,2}^{HNOMA}) + (1 - \omega_1) R_2(\epsilon_{SIC2}) \quad (31)$$

$$\text{s.t.} \quad 1 - (1 - \epsilon_{1,1}^{HNOMA})(1 - \epsilon_{1,2}^{HNOMA}) \leq \epsilon_1 \quad (32)$$

$$1 - (1 - \epsilon_{SIC1})(1 - \epsilon_{SIC2}) \leq \epsilon_2 \quad (33)$$

$$0 < \epsilon_{SIC1}, \epsilon_{SIC2}, \epsilon_{1,1}^{HNOMA}, \epsilon_{1,2}^{HNOMA} < 1, \quad (34)$$

where

$$R_1(\epsilon_{1,1}^{HNOMA}, \epsilon_{1,2}^{HNOMA}) := p \cdot \min\{R_{11}(\epsilon_{1,1}^{HNOMA}), R(\text{SNR}_{21}, \epsilon_{SIC1}, n_2)\} + (1 - p) R_{12}(\epsilon_{1,2}^{HNOMA}), \quad (35)$$

$$R_{11}(\epsilon_{1,1}^{HNOMA}) := \frac{1}{2} \log(1 + \text{SNR}_{11}) - \sqrt{\frac{V_G(\text{SNR}_{11})}{n_2}} Q^{-1}(\epsilon_{1,1}^{HNOMA}), \quad (36)$$

$$R_{12}(\epsilon_{1,2}^{HNOMA}) := \frac{1}{2} \log(1 + \text{SNR}_{12}) - \sqrt{\frac{V_G(\text{SNR}_{12})}{n_1 - n_2}} Q^{-1}(\epsilon_{1,2}^{HNOMA}). \quad (37)$$

Recall that  $(\text{SNR}_{11}, \text{SNR}_{12})$  and  $p$  are defined in (13) and (14), respectively and  $R$  on the RHS in (35) is defined in (5); the minimum in (35) is to ensure that the first sub-block of the weaker

user can be decoded at the stronger user with an error probability  $\epsilon_{SIC1}$  within blocklength  $n_2$ ;  $R_2$  in (31) is defined as follows:

$$R_2(\epsilon_{SIC2}) := C(\text{SNR}_{22}) - \sqrt{\frac{V_G(\text{SNR}_{22})}{n_2}} Q^{-1}(\epsilon_{SIC2}). \quad (38)$$

On the other hand, when we consider the enhanced weighted sum-rate of HNOMA with SPC, we formulate the following optimization problem:

$\mathbf{P}_1^{\text{SPC}}$  (enhanced weighted sum-rate of HNOMA with SPC):

$$\max \quad \omega_1 R_1(\epsilon_{1,1}^{\text{HNOMA}}, \epsilon_{1,2}^{\text{HNOMA}}) + (1 - \omega_1) R_2(\epsilon_{SIC2}) \quad (39)$$

$$\text{s.t.} \quad \text{SNR}_{11} := \frac{h_1 \bar{P}_{11}}{1 + h_1 \bar{P}_2} \quad (40)$$

$$\text{SNR}_{12} := h_1 \bar{P}_{12} \quad (41)$$

$$\text{SNR}_{21} := \frac{h_2 \bar{P}_{11}}{1 + h_2 \bar{P}_2} \quad (42)$$

$$(26), (27), (32), (33), (34), (35).$$

To optimize the weighted sum-rate of SIC with ED, we formulate the following optimization problem.

$\mathbf{P}_2^{\text{IPC}}$  (weighted sum-rate of ED with IPC):

$$\max \quad \omega_1 R_{1,ED}(\epsilon_1) + (1 - \omega_1) R_{2,ED}(\epsilon_{SIC2}) \quad (43)$$

$$\text{s.t.} \quad 1 - (1 - \epsilon_{SIC1})(1 - \epsilon_{SIC2}) \leq \epsilon_2, \quad 0 < \epsilon_1, \epsilon_2, \epsilon_{SIC1}, \epsilon_{SIC2} < 1 \quad (44)$$

$$n_2 \geq \frac{n_1 R_{1,ED}(\epsilon_1)}{C(\text{SNR}_{21}) - \log e \cdot \frac{\text{SNR}_{21}}{2(1 + \text{SNR}_{21})}} + \frac{\log e \sqrt{4\text{SNR}_{21} + 2\text{SNR}_{21}^2} Q^{-1}(\epsilon_{SIC1})}{2(1 + \text{SNR}_{21})C(\text{SNR}_{21}) - \log e \cdot \text{SNR}_{21}} \cdot \sqrt{n_1}, \quad (45)$$

where  $R_{1,ED}$  is defined in (15) and  $R_{2,ED}$  is defined in (7), which are restated as follows:

$$R_{1,ED}(\epsilon_1) := \bar{C}_1 - \sqrt{\frac{\bar{V}_1}{n_1}} Q^{-1}(\epsilon_1) + O(n_1^{-1}), \quad (46)$$

$$R_{2,ED}(\epsilon_{SIC2}) := C(\text{SNR}_{22}) - \sqrt{\frac{V_G(\text{SNR}_{22})}{n_2}} Q^{-1}(\epsilon_{SIC2}) + O(n_2^{-1}), \quad (47)$$

and  $\bar{C}_1 := pC(g_1 \bar{P}_1) + (1 - p)C(h_1 \bar{P}_1)$ ,  $\bar{V}_1 := \log e^2 \cdot \left\{ p \frac{g_1 \bar{P}_1}{1 + g_1 \bar{P}_1} + (1 - p) \frac{h_1 \bar{P}_1}{1 + h_1 \bar{P}_1} \right\}$ , and  $g_1 := \frac{h_1}{1 + h_1 \bar{P}_2}$ .

Note that (45) plays a similar role to the minimum in (35) of the HNOMA, i.e., (45) ensures the weaker user's signal can be decoded with error probability  $\epsilon_{SIC1}$  within blocklength  $n_2$  and the channel SNR is as  $\text{SNR}_{21}$ . We also consider the ED with SPC as follows:

$\mathbf{P}_2^{\text{SPC}}$  (weighted sum-rate of ED with SPC):

$$\max \quad \omega_1 R'_{1,ED}(\epsilon_1) + (1 - \omega_1) R_{2,ED}(\epsilon_{SIC2}) \quad (48)$$

$$\text{s.t.} \quad (26), (27), (44), (45), \quad (49)$$

where  $R'_1(\epsilon_1^{ED})$  is defined in (25),  $\text{SNR}_{21}$  on the RHS of (45) is replaced by (42) and  $\text{SNR}_{11}$  and  $\text{SNR}_{12}$  are replaced by (40) and (41), respectively.

### B. Latency Reduction

We compare the latency among three cases: first, the derived number of received symbols necessary for a successful ED under finite blocklength analysis. Second, the number of received symbols necessary for a successful ED under asymptotic analysis. Third, decoding the received vector with the same length as the codeword blocklength (complete decoding). We consider the following setting:  $\epsilon_1 = \epsilon_2 = 10^{-6}$ ,  $h_1 = 1$ , and  $P_1 = 8$ ,  $P_2 = 0.2$  for the maximal power constraint. We consider different blocklengths:  $n_1 = 512, 1024, \text{ and } 2048$ . The comparison among the three schemes is shown in Fig. 4. Without ED, the stronger receiver can start to decode only after receiving the complete codewords with blocklength  $n_1$ . When the ED is feasible and activated, we can observe that the improvement of the latency reduction increases with an increasing  $h_2$ . We apply the result from the asymptotic analysis as the latency lower bound, i.e.,  $n_2 = n_1 \cdot \frac{C(h_1 \bar{P}_1)}{C(h_2 \bar{P}_1)}$ , from (9). Note that the gap between the results of the early decodings in asymptotic and finite blocklength analyses is not only from the channel dispersion but also from the bounding error when deriving (6).

Assume that we consider the case in which  $n_2$  is set as the lower bound in (6). Then we compare (7) and (11) in Fig. 5, where the rate gain by using the ED over TIN is apparent. In particular, about 7-dB SNR gain can be achieved by the ED under our setting. Please note that similar comparisons as Fig. 4 and Fig. 5 for GBC with only common messages can be seen in [1].

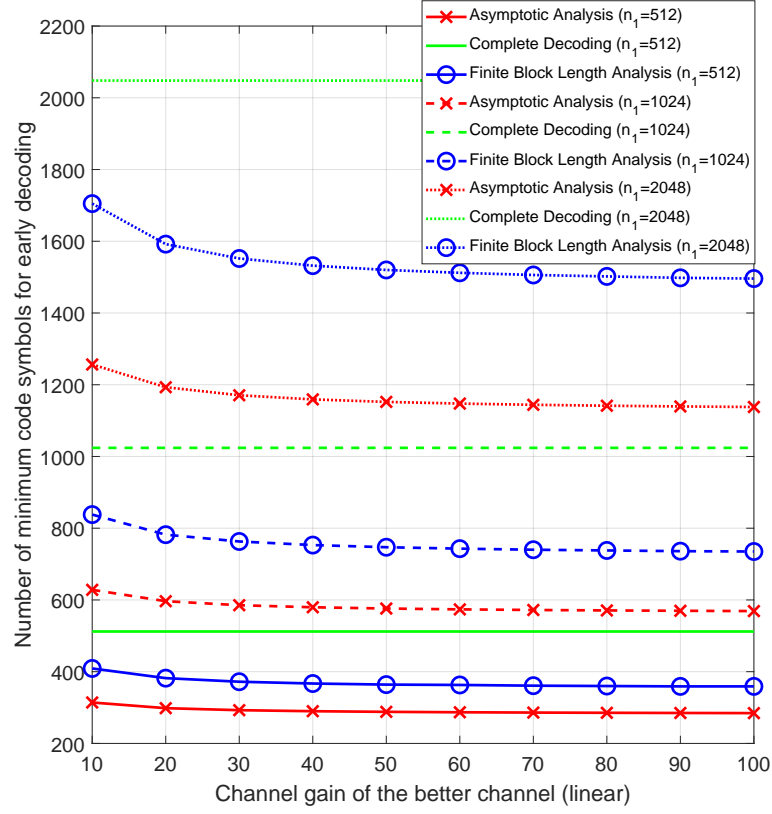

Fig. 2: Under maximal channel input power constraint, the comparison of necessary numbers of received symbols for successfully decoding a message under the constraints of average probability of error: ED with finite blocklength, ED with infinite blocklength, and complete decoding.

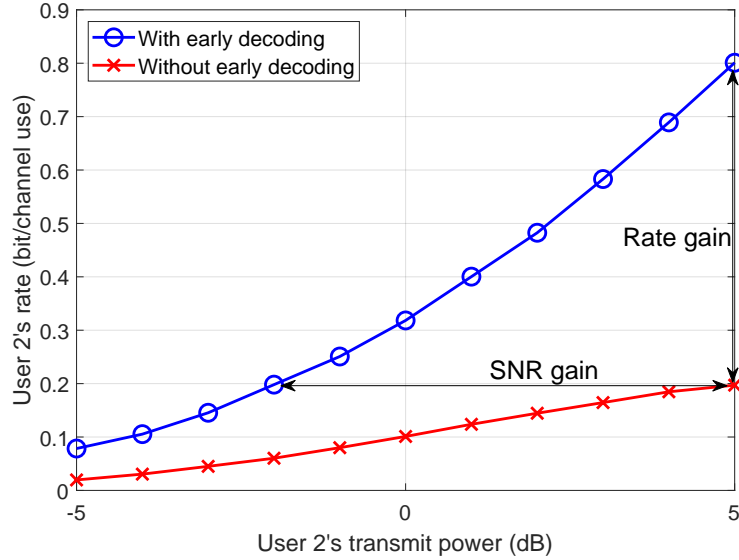

Fig. 3: Comparison of the stronger users' rates with and without ED given a latency constraint.

We also consider the latency reduction for the GBC with pure common messages as follows. We



consider the following setting:  $\varepsilon_1 = 0.001$ ,  $h_1 = 2$ , and  $\bar{P}_1 = 10$  for the maximal power constraint. We consider different blocklengths:  $n_1 = 128, 256, 512$ , and  $1024$ . The comparison among different blocklengths is shown in Fig. 4. Without early decoding, the receiver can start to decode only after receiving  $n_1$  samples. When the early decoding is activated and successful, we can observe that the blocklength reduction improves with a larger  $h_2$ . We use the result from the asymptotic analysis as the blocklength lower bound. Note that the gap between the results of successful early decodings from the first and second order analysis is not only due to the channel dispersion but also from the error introduced by upper bounding the outage probability.

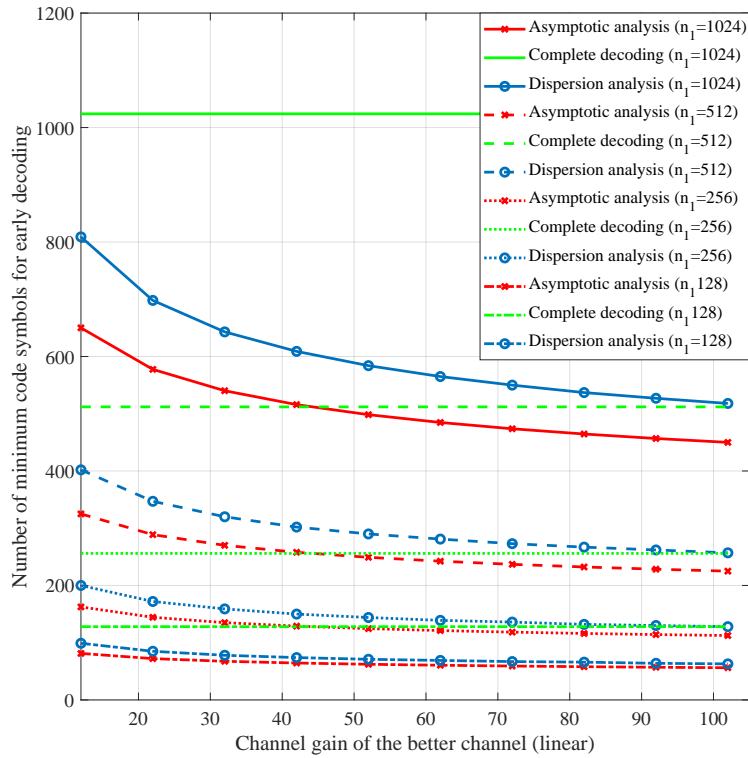

Fig. 4: Under maximal channel input power constraint, the comparison of necessary numbers of code symbols for successfully decoding versus  $h_2$ , under the constraints of average probability of error: successful early decoding with finite blocklength, successful early decoding with infinite blocklength, and traditional decoding.

In Table I we compare  $\tilde{n}_1$ 's under the setting  $h_1 = 2$ ,  $n_1 = 1024$ , and  $\bar{P}_1 = 10$  with different  $\tilde{\varepsilon}_1$ 's and different  $h_2$ 's. We set  $\varepsilon_1 = 0.01$ . We can observe that when  $\tilde{\varepsilon}_1$  decreases,  $\tilde{n}_1$  slightly increases. This phenomenon is consistent to the decoding at the legacy receiver shown in (5). In (5), if  $\tilde{\varepsilon}_1$  increases, to keep the same rate,  $n_1$  should be decreased, which is consistent to the intuition, i.e., we need to trade  $n_1$  for a lower error probability given a fixed rate.

$\tilde{\epsilon}_1 \setminus h_2$	2	22	32	42	52	62
0.1	798	689	636	601	577	558
0.01	811	700	646	611	586	567
0.001	821	709	653	618	593	574
0.0001	829	715	659	624	598	579

TABLE I: Comparison of  $n_2$ 's under different  $\tilde{\epsilon}_1$ 's and  $h_2$ 's.

In the following we show the rate gain at user 2 provided by the successful early decoding, who has a higher output SNR, of the two-user Gaussian broadcast channel, while the blocklength and power constraints are fulfilled, by comparing (7) and (11). We consider the following setting:  $n_1 = 4096$ ,  $n_2 < n_1$  and the value of  $n_2$  will be explained later,  $\epsilon_1 = \epsilon_2 = \tilde{\epsilon}_1 = 0.0001$ ,  $h_1 = 0.1$ ,  $h_2 = 1$ ,  $\bar{P}_1 = 10$  dB under maximal power constraint. From (6) we can find the relation between  $\bar{P}_2$  (dB) and the minimum  $\tilde{n}_1$  for a feasible early decoding as shown in Table II. In particular, we can find that the minimum  $\tilde{n}_1$  for a successful early decoding is an increasing function of  $\bar{P}_2$ , due to the self-interfering in the first phase of SIC, i.e., user 2 treats his own signal as noise. To fulfill the blocklength constraint:  $n_1 = 4096$ ,  $\tilde{n}_1 \leq n_2 < n_1$ , from Table II we know that  $\bar{P}_2 = 6$  dB is infeasible. Assume that we consider the case in which  $n_2 = \min \tilde{n}_1$ , then we can compare (7) and (11) in Fig. 5, where the rate gain by using the early decoding successfully is apparent. In particular, a 10-dB power gain can be achieved when the early decoding is successful.

$\bar{P}_2(dB)$	-5	-4	-3	-2	-1	0
min $\tilde{n}_1$	2190	2262	2350	2460	2597	2767
$\bar{P}_2(dB)$	1	2	3	4	5	6
min $\tilde{n}_1$	2979	3241	3568	3568	3975	4483

TABLE II:  $\bar{P}_2$  (dB) versus the minimum  $\tilde{n}_1$  for a feasible early decoding.

### C. Comparison of Sum Rate/Rate Region

1) *Sum-rate comparison:* In the following, we use two examples to compare the sum-rates ( $\omega_1 = \frac{1}{2}$ ) between the ED in  $\mathbf{P}_2^{\text{IPC}}$  and HNOMA in  $\mathbf{P}_1^{\text{IPC}}$ , under individual power constraints. We

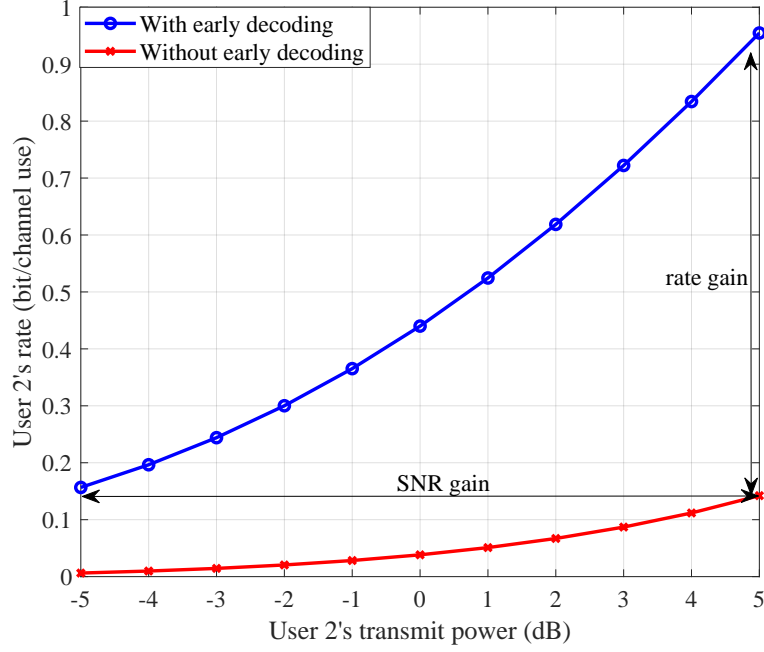

Fig. 5: Comparison of the stronger users' rates with and without early decoding given a blocklength constraint with  $n_1 = 4096$  and  $n_2 = \min \tilde{n}_1$ .

use grid search to find the optimal solution with step sizes  $\epsilon_1/100$  and  $\epsilon_2/100$  in the three problems. We only show the range of  $n_2$  where  $\mathbf{P}_2^{\text{IPC}}$  is feasible. Therefore, the sum rates below a threshold will be zero. We consider the following setting:  $n_1 = 1024$ ,  $h_1 = 1$ ,  $P_1 = 8$ ,  $P_2 = 0.2$ ,  $\epsilon_1 = 10^{-6}$ ,  $\epsilon_2 = 10^{-6}$  under  $h_2 = 10$  and  $20$ . We can see that ED outperforms HNOMA for all  $n_2$  which are feasible to ED, for the individual power constraint, for both  $h_2 = 10$  and  $20$ . In the same figure we can also observe that a larger  $h_2$  will not only enlarge the feasible region of operating the ED but also enhance the sum-rate performance, which is consistent with the intuition. On the other hand, we can also interpret curves in Fig. 6 as latency and sum-rate tradeoff curves. In particular, when we want a lower latency at the stronger user, if feasible, we can use a smaller  $n_2$ . However, due to the error probability constraint, the stronger user's rate will also be reduced, which causes the sum-rate as an increasing function of  $n_2$ .

2) *Rate regions comparison:* We now consider the rate region with SPC by solving  $\mathbf{P}_1^{\text{SPC}}$  and  $\mathbf{P}_2^{\text{SPC}}$  with the following system parameters:  $h_1 = 1$ ,  $h_2 = 50$ ,  $P_T = 10$ ,  $n_1 = 1024$ ,  $n_2 = 840$ ,  $\epsilon_1 = \epsilon_2 = 10^{-5}$  in Fig. 7. We can observe that both ED and HNOMA have their own advantages. As for ED, it can be beneficial when transmitting a codeword with longer blocklength compared to the

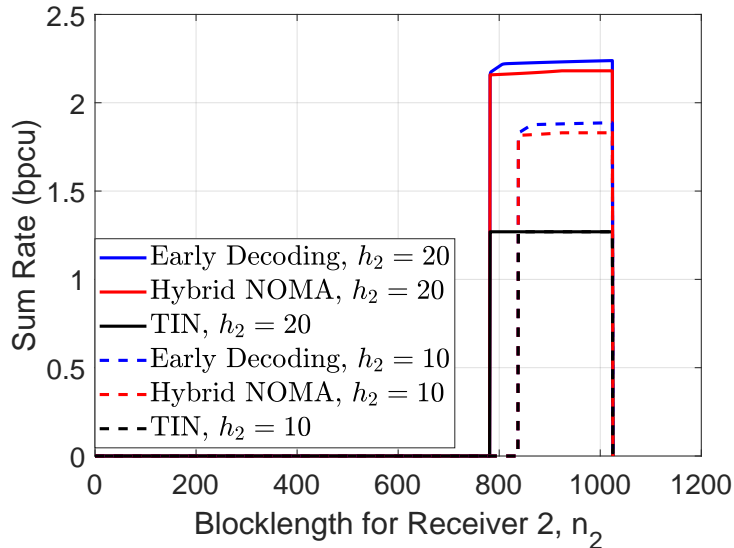

Fig. 6: Comparison of the sum rates between ED and HNOMA under IPC with different  $h_2$ .

HNOMA whose weaker user decodes two shorter codewords. Therefore, when the weighting  $\omega_1$  is larger, ED outperforms HNOMA when  $h_2$  is sufficiently large. On the contrary, by HNOMA, the transmission consists of 2 segments, which brings the flexibility of non-overlapping transmission, and therefore, it can outperform ED when  $h_2$  is smaller. In particular, under such condition, the feasibility constraint (45) is harder to fulfill.

Finally, we present a scheme, which is a combination of ED and HNOMA, namely, ED-HNOMA. This new scheme benefits from both individual schemes, while taking advantage of the transmission with longer blocklength from ED and the flexibility of transmission in the time domain from HNOMA by switching between them according to the channel gains and system setting.

## V. CONCLUSION

We investigate a two-user Gaussian broadcast channel (GBC) with heterogeneous blocklength constraints, under a maximal input power constraint and an average error probability constraint. Unlike the traditional GBC where two users have the same blocklength constraints, the user with higher output SNR considered here has a shorter blocklength constraint. We show that with sufficiently large output SNR, the stronger user can invoke the technique named as early decoding (ED) to decode the interference, followed by the successive interference cancellation (SIC), which

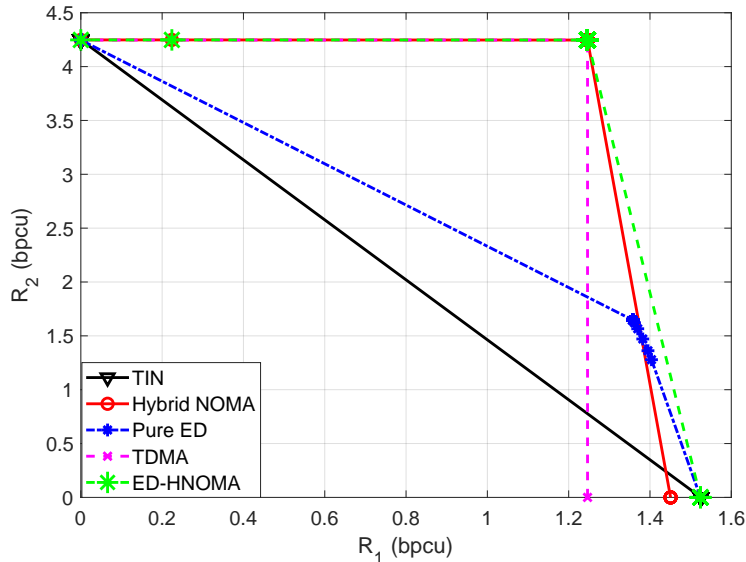

Fig. 7: Rate region:  $h_1 = 1, h_2 = 50, P_T = 10, n_1 = 1024, n_2 = 840$ .

is not yet reported in literature. To achieve this goal, we derive an explicit lower bound on the necessary number of received symbols for successful ED, using an independent and identically distributed Gaussian input. A second-order rate of the weaker user who suffers SNR change due to the heterogeneous blocklength constraint, is also derived. We then formulate the rate regions of ED and HNOMA with individual and also sum power constraints. Numerical results show that ED has a larger sum rate and rate region than HNOMA partly when the channel gain of the better channel is sufficiently larger than that of the weaker one. Then ED with SIC is a promising technique for future broadcast channels with heterogeneous blocklength constraints.

#### APPENDIX I. PROOF OF THEOREM 2

In the following, we derive the necessary number of received symbols, namely,  $n_2$ , for a successful ED under maximal power and average probability of error constraints. In particular, this  $n_2$  guarantees that a specific code with blocklength  $n_1$  designed for the channel with channel gain  $h_1$  can also be decoded with less received symbols  $n_2 < n_1$ , when being received through a better channel with channel gain  $h_2$ , where  $h_2 > h_1$ . To construct a code fulfilling the above conditions, we start from a code  $\mathcal{C}$  with a rate specified as (5). Note that from random coding analysis we know that there must exist a code  $\mathcal{C} = \{x_1^{n_1}(1), x_1^{n_1}(2), \dots, x_1^{n_1}(M_1)\}$  with blocklength  $n_1$  achieving

the rate (5) while fulfilling the input power and error probability constraints, where each codeword is i.i.d. generated according to  $\prod_{k=1}^{n_1} p_{X_1}(x_{1,k})$ ,  $x_{1,k} \in \mathcal{X}_1$ ,  $k = 1, \dots, n_1$ . Note that the selection of the rate  $\frac{\log M_1}{n_1}$  (or equivalently, the *equivalent output SNR*, when  $n_1$  and the target error probability are given) will be derived in Proposition 1. In the following, to simplify the notation without incurring confusion while analyzing the performance of the ED of the weaker user's messages at the stronger user, we will replace  $x_1$  by  $x$  and  $X_1$  by  $X$ .

In the analysis, a threshold decoder (one-side typical decoder) is used, where the threshold for decoding is selected according to [19, Theorem 2]. When conducting the error analysis for the ED, we consider the following error terms modified from the dependence testing bound given the specific code  $\mathcal{C}$  [5, Lemma 19], while decoding the complete codeword

$$\begin{aligned} & \frac{1}{M_1} \sum_{m_1=1}^{M_1} \Pr(\hat{m}_1 \neq m_1 \text{ at user 2} \mid m_1 \text{ is sent, } \mathcal{C} \text{ is used, and use } n_1 \text{ symbols to decode}) \\ & \leq \frac{1}{M_1} \sum_{m=1}^{M_1} \left\{ \mathbb{1}_{x^{n_1}(m) \notin \mathcal{F}_{n_1}} + P_{Y_2^{n_1} | X^{n_1}=x^{n_1}(m)}(i(x^{n_1}(m); Y_2^{n_1}) \leq \log M_1) \right. \\ & \qquad \qquad \qquad \left. + M_1 P_{Y_2^{n_1}}(i(x^{n_1}(m); Y_2^{n_1}) > \log M_1) \right\} \quad (50) \end{aligned}$$

$$\begin{aligned} & \leq \frac{1}{M_1} \sum_{m=1}^{M_1} \left\{ \mathbb{1}_{\|x^{n_1}(m)\|^2 > P_1} + \mathbb{1}_{\|x^{n_1}(m)\|_\infty > n_1^a} + P_{Y_2^{n_1} | X^{n_1}=x^{n_1}(m)}(i(x^{n_1}(m); Y_2^{n_1}) \leq \log M_1) \right. \\ & \qquad \qquad \qquad \left. + M_1 P_{Y_2^{n_1}}(i(x^{n_1}(m); Y_2^{n_1}) > \log M_1) \right\}, \quad (51) \end{aligned}$$

where in (50),  $\mathcal{F}_{n_1}$  is the channel input constraint, including the maximal power constraint (2) and the peak constraint  $\|x^{n_1}(m)\|_\infty \leq n_1^a$ ,  $0 < a < 1$ . Then the first term in (50) (with the normalization with respect to  $M_1$ ) is the probability of input-constraint violation, the second and the third terms are outage and confusion probabilities, respectively, given a specific codeword [5, (75)].

After selecting a deterministic code, we can re-map the messages of all the codewords violating the input constraint to one arbitrary vector which fulfills the power constraint while the decoding region is kept unchanged by this remapping. Under such a setting, the probability of the input

\*The peak constraint is only for the proof purpose, i.e., to ensure the vanishing property of the B-E ratio. Furthermore, with this additional constraint, the derived rate is a lower bound of the achievable rate of the original system.

power constraint being violated is merged into the decoding error probability [5, Theorem 20].

From the concentration inequality in [20, (4.3)], we know that <sup>†</sup>

$$\Pr(\|X^{n_1}\|^2 > n_1 P_1) \leq e^{-\frac{n_1 \delta^2}{4}} \quad (52)$$

and from the proof in Appendix II, we know that

$$\Pr(\|X^{n_1}\|_\infty > n_1^a) \leq e^{-\frac{n_1^{2a}}{2P_1} + \ln(2n_1)}. \quad (53)$$

In the first step of SIC at user 2, the received signal can be expressed as

$$Y_2 := \sqrt{h_2} X_1 + (\sqrt{h_2} X_2 + Z_2) = \sqrt{h_2} X + Z'_2, \quad (54)$$

where  $Z'_2 := \sqrt{h_2} X_2 + Z_2 \sim \mathcal{N}(0, 1 + h_2 P_2)$  and (54) is equivalent to the following

$$\tilde{Y}_2 := \sqrt{g_2} X_1 + \tilde{Z}_2, \quad (55)$$

where  $\tilde{Z}_2 \sim \mathcal{N}(0, 1)$ ,  $\tilde{Z}_2 \perp X$  and we define the equivalent channel of the first step of SIC at the stronger user as

$$g_2 := \frac{h_2}{1 + h_2 P_2}. \quad (56)$$

We can evaluate the error probability of the code  $\mathcal{C}$  under the better channel while being decoded with  $n_2$  received symbols as follows:

$$\begin{aligned} & \frac{1}{M_1} \sum_{m_1=1}^{M_1} \Pr(\hat{m}_1 \neq m_1 \text{ at user 2} \mid m_1 \text{ is sent, } \mathcal{C} \text{ is used, and use } n_2 \text{ symbols to decode}) \\ & \leq \frac{1}{M_1} \sum_{m=1}^{M_1} \left\{ P_{\tilde{Y}_2^{n_2} | X^{n_2} = x^{n_2}(m)}(i(x^{n_2}(m); \tilde{Y}_2^{n_2}) \leq \log M_1) \right. \\ & \quad \left. + M_1 P_{\tilde{Y}_2^{n_2}}(i(x^{n_2}(m); \tilde{Y}_2^{n_2}) > \log M_1) \right\} + e^{-\frac{n_2 \delta^2}{4}} + e^{-\frac{n_1^{2a}}{2P_1} + \ln(2n_1)}, \quad (57) \end{aligned}$$

where  $i(x^{n_2}(m); \tilde{Y}_2^{n_2})$  is the information density.

<sup>†</sup>More specifically, from [20, (4.3)] we know that  $\Pr(W \geq n_k (1 + 2\sqrt{\frac{t}{n_k}} + 2\frac{t}{n_k})) \leq e^{-t}$ , where  $W$  is  $\chi^2$  distributed with degree of freedom  $n_1$ ,  $t > 0$ . Let  $X_{k,i} \sim \mathcal{N}(0, (1-\delta)P_k)$ ,  $k = 1, 2$  and  $i = 1, \dots, n_1$ , which considers the power back-off  $\delta > 0$ . We can rearrange the input violation probability as follows:  $\Pr(\sum_{i=1}^{n_k} X_{k,i}^2 \geq n_k P_k) = \Pr(\sum_{i=1}^{n_k} \frac{X_{k,i}^2}{(1-\delta)P_k} \geq \frac{n_k}{1-\delta}) \stackrel{(a)}{\leq} \Pr(\sum_{i=1}^{n_k} \frac{X_{k,i}^2}{(1-\delta)P_k} \geq n_k(1+\delta)) = \Pr(W \geq n_k(1+\delta))$ , where (a) is by the first order Taylor expansion of  $\frac{1}{1-\delta}$ , while  $\frac{1}{1-\delta} > 1+\delta$ . By letting  $2\sqrt{nt} + 2t = n_k \delta$ , we can solve that  $t = \frac{n_k}{2}(1+\delta - \sqrt{1+2\delta})$ , which can be approximated as  $t = \frac{n_k \delta^2}{4}$  by Taylor expansion when  $\delta$  is close to 0. Therefore, as long as  $\delta = o(\frac{1}{\sqrt{n_k}})$ , the violation probability can be expressed as  $e^{-O(n_2)}$ .

Fix any codeword  $x^{n_2}(m)$ ,  $m \in \{1, \dots, M_1\}$  from  $\mathcal{C}$ , the information density  $i(x^{n_2}(m); \tilde{Y}_2^{n_2})$  can be calculated as follows:

$$i(x^{n_2}(m); \tilde{Y}_2^{n_2}) = \log \frac{(2\pi)^{-n_2/2} e^{-\frac{\|\tilde{Y}_2^{n_2} - \sqrt{g_2} x^{n_2}(m)\|^2}{2}}}{(2\pi(1 + g_2 \mathbf{P}_1))^{-n_2/2} e^{-\frac{\|\tilde{Y}_2^{n_2}\|^2}{2(1+g_2 \mathbf{P}_1)}}} = \sum_{j=1}^{n_2} W_j, \quad (58)$$

where (58) is due to the memoryless channel, and we define

$$W_j := \mathbf{C}(g_2 \mathbf{P}_1) + \frac{\log e \cdot g_2 (x_j^2 - \mathbf{P}_1 \tilde{Z}_j^2)}{2(1 + g_2 \mathbf{P}_1)} + \frac{\log e}{1 + g_2 \mathbf{P}_1} \sqrt{g_2} x_j \tilde{Z}_j. \quad (59)$$

The mean of  $W_j$  conditioned on  $x_j$  is as follows

$$\mathbb{E}_{\tilde{Y}_{2,j}|X_j=x_j}[W_j] = \mathbf{C}(g_2 \mathbf{P}_1) + \frac{\log e \cdot g_2 (x_j^2 - \mathbf{P}_1)}{2(1 + g_2 \mathbf{P}_1)}. \quad (60)$$

Then the centralized information density of the  $j$ -th symbol conditioned on  $x_j$  is as follows:

$$W_j - \mathbb{E}_{\tilde{Y}_{2,j}|X_j=x_j}[W_j] = \frac{\log e}{1 + g_2 \mathbf{P}_1} \left( \sqrt{g_2} x_j \tilde{Z}_{2,j} + g_2 \frac{\mathbf{P}_1}{2} (1 - \tilde{Z}_{2,j}^2) \right). \quad (61)$$

To upper bound both the confusion and outage probabilities, we derive the Berry-Esseen ratio in (4) as follows. First, the absolute centralized third moment of the information density given  $x^n$  can be upper bounded as follows

$$\sum_{j=1}^{n_2} \mathbb{E}_{\tilde{Y}_{2,j}|X_j=x_j} \left[ \left| W_j - \mathbb{E}_{\tilde{Y}_{2,j}|X_j=x_j}[W_j] \right|^3 \right] \quad (62)$$

$$\leq 4 \sum_{j=1}^{n_2} \left( \frac{\log e \cdot \sqrt{g_2}}{1 + g_2 \mathbf{P}_1} \right)^3 \left( \frac{(\sqrt{g_2} \mathbf{P}_1)^3}{8} \mathbb{E}_{\tilde{Y}_{2,j}|X_j=x_j} \left[ |1 - \tilde{Z}_{2,j}^2|^3 \right] + \mathbb{E}_{\tilde{Y}_{2,j}|X_j=x_j} \left[ |\tilde{Z}_{2,j}|^3 \right] |x_j|^3 \right) \quad (63)$$

$$\leq 4 \sum_{j=1}^{n_2} \left( \frac{\log e \cdot \sqrt{g_2}}{1 + g_2 \mathbf{P}_1} \right)^3 \left( \frac{(\sqrt{g_2} \mathbf{P}_1)^3}{8} \mathbb{E}_{\tilde{Y}_{2,j}|X_j=x_j} \left[ |1 - \tilde{Z}_{2,j}^2|^3 \right] + 2|x_j|^3 \right) \quad (64)$$

$$\leq 4 \sum_{j=1}^{n_2} \left( \frac{\log e \cdot \sqrt{g_2}}{1 + g_2 \mathbf{P}_1} \right)^3 \left( \frac{4(\sqrt{g_2} \mathbf{P}_1)^3}{8} \left( 1 + \mathbb{E}_{\tilde{Y}_{2,j}|X_j=x_j} \left[ |\tilde{Z}_{2,j}|^6 \right] \right) + 2|x_j|^3 \right) \quad (65)$$

$$:= 4 \sum_{j=1}^{n_2} \left( \frac{\log e \cdot \sqrt{g_2}}{1 + g_2 \mathbf{P}_1} \right)^3 \left( \frac{(\sqrt{g_2} \mathbf{P}_1)^3}{2} (1 + K_1) + 2|x_j|^3 \right), \quad (66)$$

where (63) uses the following Lemma 2, (64) is due to the fact  $\mathbb{E}[|\tilde{Z}_{2,j}|^3] \leq 2$ , for  $\tilde{Z}_{2,j} \sim \mathcal{N}(0, 1)$ , for all  $j$ , (65) uses Lemma 2 again, and in (66) we define

$$K_1 := \mathbb{E}_{\tilde{Y}_{2,j}|X_j=x_j} \left[ |\tilde{Z}_{2,j}|^6 \right] = \frac{8\Gamma(3.5)}{\sqrt{\pi}} \cdot {}_1F_1(-3; 0.5; 0) = 15, \quad (67)$$

where  ${}_1F_1(\cdot; \cdot; \cdot)$  is the confluent hypergeometric function.



**Lemma 2.** Let  $f_1$  and  $f_2$  be functions whose outputs are real numbers. Then

$$\mathbb{E}[|f_1 + f_2|^3] \leq 4(\mathbb{E}[|f_1|^3] + \mathbb{E}[|f_2|^3]). \quad (68)$$

*Proof.* Since  $f(x) = x^3$  is convex if  $x > 0$  and  $\mathbb{E}[|f_1 + f_2|^3] \leq \mathbb{E}[|f_1| + |f_2|]^3$ , then

$$\left| \frac{1}{2}|f_1| + \frac{1}{2}|f_2| \right|^3 \leq \frac{1}{2}(|f_1|^3 + |f_2|^3). \quad (69)$$

After applying the expectation and multiplying both sides by 8, we complete the proof.  $\square$

The variance of the information density given  $x^{n_2}$  can be lower bounded as follows:

$$\sum_{j=1}^{n_2} \text{Var}_{\tilde{Y}_{2,j}|X_j=x_j} [W_j] = \sum_{j=1}^{n_2} \mathbb{E}_{\tilde{Y}_{2,j}|X_j=x_j} \left[ \left( \frac{\log e}{1 + g_2 \mathbf{P}_1} \left( \sqrt{g_2} x_j \tilde{Z}_{2,j} + g_2 \frac{\mathbf{P}_1}{2} (1 - \tilde{Z}_{2,j}^2) \right) \right)^2 \right] \quad (70)$$

$$= \sum_{j=1}^{n_2} \left( \frac{\log e}{1 + g_2 \mathbf{P}_1} \right)^2 g_2 \left( x_j^2 + g_2 \frac{\mathbf{P}_1^2}{2} \right) \geq n_2 \left( \frac{\log e \cdot g_2 \mathbf{P}_1}{\sqrt{2}(1 + g_2 \mathbf{P}_1)} \right)^2, \quad (71)$$

where (70) is from (61) and in (71), we remove the term related to  $x_j^2$ .

After substituting (66) and (71) into (4), we can upper bound the Berry-Esseen ratio conditioned on  $x^{n_2}$  as follows

$$\frac{T}{V^{3/2}} \leq \frac{4 \sum_{j=1}^{n_2} \left( \frac{\sqrt{g_2}}{1 + g_2 \mathbf{P}_1} \right)^3 (8(\sqrt{g_2} \mathbf{P}_1)^3 + 2|x_j|^3)}{\left( \frac{1}{2} n_2 \left( \frac{\sqrt{g_2} \mathbf{P}_1}{1 + g_2 \mathbf{P}_1} \right)^2 \right)^{\frac{3}{2}}} \quad (72)$$

$$:= \frac{4d_1 \left( 8n_2(\sqrt{g_2} \mathbf{P}_1)^3 + 2 \sum_{j=1}^{n_2} |x_j|^3 \right)}{\left( \frac{1}{2} d_1 n_2 \right)^{\frac{3}{2}}} \quad (73)$$

$$\leq c_0 \cdot n_2^{-\frac{1}{2}} + c_1 \cdot n_2^{a-\frac{1}{2}} := B_0(n_2), \quad (74)$$

where in (73), we define  $d_1 := \left( \frac{\sqrt{g_2}}{1 + g_2 \mathbf{P}_1} \right)^3$ , which is a constant only dependent on  $\mathbf{P}_1$  and channel gains, but independent of  $n_2$ ; in (74), we define  $c_0 := \frac{62\sqrt{2}(\sqrt{g_2} \mathbf{P}_1)^3}{\sqrt{d_1}}$ ,  $c_1 := \frac{128\sqrt{2}\mathbf{P}_1}{\sqrt{d_1} p^{1+a}}$  and the inequality comes from the assumption of peak constraint  $|x_j| \leq n_1^a$ ,  $a < \frac{1}{2}$  to be optimized, with the following upper bounding

$$\sum_{j=1}^{n_2} |x_j|^3 \leq |\max x_j| \sum_{j=1}^{n_2} |x_j|^2 \stackrel{(a)}{\leq} |\max x_j| n_1 \mathbf{P}_1 \stackrel{(b)}{\leq} n_1^{a+1} \mathbf{P}_1 = \left( \frac{n_2}{p} \right)^{a+1} \mathbf{P}_1, \quad (75)$$

where (a) comes from the maximal power constraint (2) and (b) comes from the assumption of peak constraint.

Besides, the confusion probability conditioned on  $x^{n_2}$  can be upper bounded as

$$P_{\tilde{Y}^{n_2}} \left[ \sum_{j=1}^{n_2} W_j > \log \gamma_{n_2} \right] = \mathbb{E}_{\tilde{Y}^{n_2} | X^{n_2} = x^{n_2}} \left[ \exp \left( - \sum_{j=1}^{n_2} W_j \cdot \mathbb{1} \left\{ \frac{\sum_{j=1}^{n_2} W_j}{n_2} > \frac{\log \gamma_{n_2}}{n_2} \right\} \right) \right] \quad (76)$$

$$\stackrel{(a)}{\leq} \frac{2}{\gamma_{n_2}} \left( \frac{\ln 2}{\sqrt{\pi d_1 n_2}} + B_0(n_2) \right) \quad (77)$$

$$:= \frac{B_1(n_2)}{\gamma_{n_2}}, \quad (78)$$

where (76) is from the change of measure [5, (257)], (77) is from [5, Lemma 47] with  $\sum_{j=1}^{n_2} \text{Var}_{\tilde{Y}_j | X_j = x_j} [W_j]$  in (70), which is upper bounded by the same step used in (72). In addition, we use (74) to bound the Berry-Esseen ratio. Note that  $B_1(n_2)$  is a constant depending only on  $h_1$  and  $P_2$  but not on the realization  $x^{n_2}$ . Therefore, the total confusion probability can be simply derived from (78) as

$$M_1 \cdot P_{X^{n_2}} P_{\tilde{Y}_2^{n_2}} \left[ \sum_{j=1}^{n_2} W_j > \log \gamma_{n_2} \right] \leq \frac{M_1 \cdot B_1(n_2)}{\gamma_{n_2}}. \quad (79)$$

Meanwhile, by (4), the outage probability conditioned on  $x^{n_2}$  can be expressed as follows

$$P_{\tilde{Y}_2^{n_2} | X^{n_2} = x^{n_2}} \left[ \sum_{j=1}^{n_2} W_j \leq \log \gamma_{n_2} \right] \leq Q(r_m(n_2)) + B_0(n_2), \quad (80)$$

where

$$r_m(n_2) := \frac{n_2 \mu_m - \log M_1}{n_2 \sigma_m}, \quad (81)$$

where  $\mu_m$  and  $\sigma_m^2$  are defined as the RHS of (60) and the LHS of (71), respectively, and  $B_0(n_2)$  is defined in (74). Note that  $\lambda$  in (4) has the relation  $\lambda = -r_m(n_2)$ .

By selecting  $\gamma_{n_2} = M_1$ , we can then bound the conditional confusion and outage probabilities in (79) and (80) respectively as

$$M_1 \cdot P_{X^{n_2}} P_{\tilde{Y}_2^{n_2}} \left[ \sum_{j=1}^{n_2} W_j > \log \gamma_{n_2} \right] \leq B_1(n_2), \quad (82)$$

$$P_{\tilde{Y}_2^{n_2} | X^{n_2} = x^{n_2}(m)} \left( \sum_{j=1}^{n_2} W_j \leq \log M_1 \right) = Q(r_m(n_2)) + B_0(n_2). \quad (83)$$

Note that we need  $r_m(n_2) > 0$  since we consider the case in which  $\epsilon_{SIC1} < \frac{1}{2}$ . Note also that  $r_m(n_2)$  is a function of  $\|x^{n_2}(m)\|^2$ . To derive an upper bound of (83), we resort to finding a lower bound

of  $r_m(n_2)$  since  $Q$ -function is monotonically decreasing. Furthermore, we aim to find a uniform lower bound of  $r_m(n_2)$ , which will be independent of the given  $x^{n_2}(m)$ , as shown as follows

$$r_m(n_2) = \frac{n_2 \mathbf{C}(g_2 \mathbf{P}_1) + \frac{\log e \cdot g_2}{2(1+g_2 \mathbf{P}_1)} (\|x^{n_2}(m)\|^2 - n_2 \mathbf{P}_1) - \log \mathbf{M}_1}{\frac{\log e}{2(1+g_2 \mathbf{P}_1)} \sqrt{4g_2 \|x^{n_2}(m)\|^2 + 2n_2 g_2^2 \mathbf{P}_1^2}} \quad (84)$$

$$= \frac{2(1+g_2 \mathbf{P}_1)(n_2 \mathbf{C}(g_2 \mathbf{P}_1) - \log \mathbf{M}_1) - \log e \cdot n_2 g_2 \mathbf{P}_1}{\log e \cdot \sqrt{4g_2 \|x^{n_2}(m)\|^2 + 2n_2 g_2^2 \mathbf{P}_1^2}} + \frac{1}{2} \frac{\|x^{n_2}(m)\|^2}{\sqrt{\frac{\|x^{n_2}(m)\|^2}{g_2} + \frac{n_2 \mathbf{P}_1^2}{2}}} \quad (85)$$

$$\geq \frac{2(1+g_2 \mathbf{P}_1)(n_2 \mathbf{C}(g_2 \mathbf{P}_1) - \log \mathbf{M}_1) - \log e \cdot n_2 g_2 \mathbf{P}_1}{\log e \cdot \sqrt{4g_2 \|x^{n_2}(m)\|^2 + 2n_2 g_2^2 \mathbf{P}_1^2}} \quad (86)$$

$$= \frac{[2(1+g_2 \mathbf{P}_1)\mathbf{C}(g_2 \mathbf{P}_1) - \log e \cdot g_2 \mathbf{P}_1]n_2 - 2(1+g_2 \mathbf{P}_1)\log \mathbf{M}_1}{\log e \cdot \sqrt{4g_2 \|x^{n_2}(m)\|^2 + 2n_2 g_2^2 \mathbf{P}_1^2}} \quad (87)$$

$$:= r_{m,1}(n_2), \quad (88)$$

where (84) is from (81), (86) comes from the fact that the second term in (85) is positive.

We further lower bound  $r_{m,1}(n_2)$  by substituting the following upper bound:

$$\|x^{n_2}(m)\|^2 \leq \|x^{n_1}(m)\|^2 \leq n_1 \mathbf{P}_1, \quad (89)$$

into the denominator of (87), while we need to ensure the numerator of (87) is positive, i.e.,

$$n_2 \geq \frac{\log \mathbf{M}_1}{\mathbf{C}(g_2 \mathbf{P}_1) - \log e \cdot \frac{g_2 \mathbf{P}_1}{2(1+g_2 \mathbf{P}_1)}}. \quad (90)$$

We will check the validity of the additional condition (90) at the end of the proof by comparing it to our derived lower bound on  $n_2$ . Then we can lower bound  $r_{m,1}(n_2)$  as follows

$$\begin{aligned} r_{m,1}(n_2) &\geq \frac{[2(1+g_2 \mathbf{P}_1)\mathbf{C}(g_2 \mathbf{P}_1) - \log e \cdot g_2 \mathbf{P}_1]n_2 - 2(1+g_2 \mathbf{P}_1)\log \mathbf{M}_1}{\log e \sqrt{4g_2 n_1 \mathbf{P}_1 + 2n_2 (g_2)^2 \mathbf{P}_1^2}} \\ &\geq \frac{[2(1+g_2 \mathbf{P}_1)\mathbf{C}(g_2 \mathbf{P}_1) - \log e \cdot g_2 \mathbf{P}_1]n_2 - 2(1+g_2 \mathbf{P}_1)\log \mathbf{M}_1}{\log e \sqrt{4g_2 \mathbf{P}_1 + 2(g_2)^2 \mathbf{P}_1^2} \sqrt{n_1}} \end{aligned} \quad (91)$$

for  $m \in [1, \mathbf{M}_1]$ , where (91) is due to  $n_1 \geq n_2$ .

After substituting (82), (83), and (91) into (57), we can derive the following result

$$\begin{aligned} & \frac{1}{M_1} \sum_{m=1}^{M_1} \Pr(\hat{m}_1 \neq m_1 \text{ at user 2} | m_1 \text{ is sent, } \mathcal{C} \text{ is used, and use } n_2 \text{ symbols to decode}) \\ &= \frac{1}{M_1} \sum_{m=1}^{M_1} (Q(r_m(n_2)) + B_0(n_2) + B_1(n_2)) + e^{-\frac{n_2}{2}} + e^{\frac{-n_1^{2a}}{2P_1} + \ln(2n_1)} \end{aligned} \quad (92)$$

$$\leq \left( \frac{1}{M_1} \sum_{m=1}^{M_1} Q(r_{m,1}(n_2)) \right) + B_0(n_2) + B_1(n_2) + e^{-\frac{n_2}{2}} + e^{\frac{-n_1^{2a}}{2P_1} + \ln(2n_1)} \quad (93)$$

$$\leq Q \left( \frac{[2(1+g_2P_1)\mathcal{C}(g_2P_1) - \log e \cdot g_2P_1]n_2 - 2(1+g_2P_1)\log M_1}{\log e \sqrt{4g_2P_1 + 2(g_2)^2P_1^2\sqrt{n_1}}} \right) + c_2 \quad (94)$$

$$\leq \varepsilon_{SIC1}, \quad (95)$$

where (93) is from (87); (94) is by (91) and the fact that  $r_m(n_2)$ ,  $m \in [1, M_1]$  are constant and we define

$$\begin{aligned} c_2 &:= B_0(n_2) + B_1(n_2) + e^{-\frac{n_2}{2}} + e^{\frac{-n_1^{2a}}{2P_1} + \ln(2n_1)} \\ &= \frac{2}{\sqrt{n_2}} \left( \frac{\ln 2}{\sqrt{\pi d_1}} + \frac{3}{2}(c_0 + c_1 \cdot n_2^a) \right) + e^{-\frac{n_2}{2}} + e^{\frac{-n_1^{2a}}{2P_1} + \ln(2n_1)} \end{aligned} \quad (96)$$

$$\leq \frac{2}{\sqrt{n_2}} \left( \frac{\ln 2}{\sqrt{\pi d_1}} + \frac{3}{2}(c_0 + c_1 \cdot n_2^a) \right) + e^{-\frac{n_2}{2}} + e^{\frac{-n_1^{2a}}{2P_1} + \ln(2n_2)} \quad (97)$$

$$= \frac{1}{\sqrt{n_2 d_1}} \left( \frac{2 \ln 2}{\sqrt{\pi}} + 64\sqrt{2} \left( (\sqrt{g_2}P_1)^3 + 2P_1 \cdot n_2^a \right) \right) + e^{-\frac{n_2}{2}} + e^{\frac{-n_1^{2a}}{2P_1} + \ln(2n_2)}, \quad (98)$$

where (96) is from (74) and (78),  $d_1 := \left( \frac{\sqrt{g_2}}{1+g_2P_1} \right)^{3/2}$  and  $g_2 := \frac{h_2}{1+h_2P_2}$ . Note that in (95) we enforce the upper bound of the average error probability to be no larger than the target value  $\varepsilon_{SIC1}$ .

Now we further rearrange (94) and (95) by taking the inverse function of  $Q$ -function as follows

$$\frac{[2(1+g_2P_1)\mathcal{C}(g_2P_1) - \log e \cdot g_2P_1]n_2 - 2(1+g_2P_1)\log M_1}{\log e \sqrt{4g_2P_1 + 2(g_2)^2P_1^2\sqrt{n_1}}} \geq Q^{-1}(\varepsilon_{SIC1} - c_2) \quad (99)$$

$$= Q^{-1}(\varepsilon_{SIC1}) + O(c_2), \quad (100)$$

where (99) is due to the fact that  $Q$ -function is monotonically decreasing and (100) is due to  $Q$ -function being continuous so we can apply the Taylor expansion as [5, (267)]. By simple algebra, we can solve a lower bound of  $n_2$  shown as (6). Now compare (6) and (90), we find that (6) is stricter, which completes the proof.  $\square$

APPENDIX II. PROOF OF  $\Pr(\|X^n\|_\infty > n^a) \leq e^{-\frac{n^{2a}}{2P} + \ln(2n)}$

From [21, (2.9)] we know that any sub-Gaussian random variable with mean  $\mu$  and parameter  $\sigma^2$  satisfies the following concentration inequality

$$\Pr(|X - \mu| \geq t) \leq 2e^{-\frac{t^2}{2\sigma^2}}, \quad (101)$$

for all  $t \in \mathbb{R}$ . In our case, we have  $X \sim \mathcal{N}(0, P)$  and we set  $t = n^a$ . Then

$$\Pr(\cup_{k=1}^n |X_k| > n^a) \stackrel{(a)}{\leq} \sum_{k=1}^n \Pr(|X_k| > n^a) \stackrel{(b)}{\leq} \sum_{k=1}^n 2e^{-\frac{n^{2a}}{2P}} = 2ne^{-\frac{n^{2a}}{2P}} = e^{-\frac{n^{2a}}{2P} + \ln(2n)}, \quad (102)$$

where (a) is from the union bound and (b) is from (101), which completes the proof  $\square$ .

APPENDIX III. PROOF OF PROPOSITION 1

To analyze the weaker user's rate, we modify (57) by considering the channel gain  $g^{n_1}$  as the channel output and in contrast to the analysis in Appendix I, here we use the random coding argument as follows

$$\varepsilon \leq P_{X^{n_1}} P_{\tilde{Y}^{n_1} | G^{n_1} | X^{n_1}} (\tilde{i}(X^{n_1}; \tilde{Y}^{n_1}) \leq \log M) + M \cdot [P_{X^{n_1}} P_{\tilde{Y}^{n_1}} (\tilde{i}(X^{n_1}; \tilde{Y}^{n_1}) \geq \log M)] + P_{X^{n_1}} (X^{n_1} \notin \mathcal{F}_T), \quad (103)$$

where the modified information density  $\tilde{i}(X^{n_1}; \tilde{Y}^{n_1})$  [5] is derived according to the capacity achieving output distribution [22]

$$P_{\tilde{Y}^{n_1}} = \prod_{j=1}^{n_1} P_{\tilde{Y}_j} \sim \mathcal{N}(\mathbf{0}, \mathbf{\Sigma}), \quad (104)$$

where

$$\mathbf{\Sigma} := \begin{pmatrix} \mathbf{I}_{n_2} \cdot [1 + h_1(\mathbf{P}_1 + \mathbf{P}_2)] & \mathbf{0} \\ \mathbf{0} & \mathbf{I}_{n_1 - n_2} \cdot [1 + h_1 \mathbf{P}_1] \end{pmatrix}. \quad (105)$$

Based on (104), we have the following modified information density:

$$\begin{aligned} & \tilde{i}(X^{n_1}; Y^{n_1}) \\ &= \log \left\{ \frac{(2\pi)^{-\frac{n_1}{2}} (1+h_1\mathbf{P}_2)^{-\frac{n_2}{2}} 1^{-\frac{(n_1-n_2)}{2}} \exp\left(\frac{-\sum_{i=1}^{n_2} (Y_{1,i}-\sqrt{h_1}X_{1,i})^2}{2(1+h_1\mathbf{P}_2)}\right) \exp\left(\frac{-\sum_{i=n_2+1}^{n_1} (Y_{1,i}-\sqrt{h_1}X_{1,i})^2}{2}\right)}{(2\pi)^{-\frac{n_1}{2}} (1+h_1(\mathbf{P}_1+\mathbf{P}_2))^{-\frac{n_2}{2}} (1+h_1\mathbf{P}_1)^{-\frac{(n_1-n_2)}{2}} \exp\left(\frac{-\sum_{i=1}^{n_2} Y_{1,i}^2}{2(1+h_1(\mathbf{P}_1+\mathbf{P}_2))}\right) \exp\left(\frac{-\sum_{i=n_2+1}^{n_1} Y_{1,i}^2}{2(1+h_1\mathbf{P}_1)}\right)} \right\} \end{aligned} \quad (106)$$

$$\begin{aligned} &= n_1 \left( p \cdot \log \left( 1 + \frac{h_1\mathbf{P}_1}{1+h_2\mathbf{P}_2} \right) + (1-p) \log(1+h_1\mathbf{P}_1) \right) + \\ & \quad \frac{\log e}{1+h_1(\mathbf{P}_1+\mathbf{P}_2)} \left[ \sum_{i=1}^{n_2} (\sqrt{h_1}X_{1,i} + \tilde{Z}_{1,i})^2 - \frac{1+h_1(\mathbf{P}_1+\mathbf{P}_2)}{1+h_1\mathbf{P}_2} \sum_{i=1}^{n_2} \tilde{Z}_{1,i}^2 \right] + \\ & \quad \frac{\log e}{1+h_1\mathbf{P}_1} \left[ \sum_{i=n_2+1}^{n_1} (\sqrt{h_1}X_{1,i} + \tilde{Z}_{1,i})^2 - (1+h_1\mathbf{P}_1) \sum_{i=n_2+1}^{n_1} \tilde{Z}_{1,i}^2 \right] \end{aligned} \quad (107)$$

$$\begin{aligned} &= n_1 \bar{\mathbf{C}}_1 + \frac{\log e}{2(1+h_1(\mathbf{P}_1+\mathbf{P}_2))} \left[ \sum_{i=1}^{n_2} (\sqrt{h_1}X_{1,i} + \tilde{Z}_{1,i})^2 - (1+g_2\mathbf{P}_1) \sum_{i=1}^{n_2} \tilde{Z}_{1,i}^2 \right] + \\ & \quad \frac{\log e}{2(1+h_1\mathbf{P}_1)} \left[ \sum_{i=n_2+1}^{n_1} (\sqrt{h_1}X_{1,i} + \tilde{Z}_{1,i})^2 - (1+h_1\mathbf{P}_1) \sum_{i=n_2+1}^{n_1} \tilde{Z}_{1,i}^2 \right] \end{aligned} \quad (108)$$

$$\begin{aligned} &= n_1 \bar{\mathbf{C}}_1 + \frac{\log e}{2(1+h_1(\mathbf{P}_1+\mathbf{P}_2))} \left[ \sum_{i=1}^{n_2} (h_1X_{1,i}^2 + 2\sqrt{h_1}X_{1,i}\tilde{Z}_{1,i}) - g_2\mathbf{P}_1 \sum_{i=1}^{n_2} \tilde{Z}_{1,i}^2 \right] + \\ & \quad \frac{\log e}{2(1+h_1\mathbf{P}_1)} \left[ \sum_{i=n_2+1}^{n_1} (h_1X_{1,i}^2 + 2\sqrt{h_1}X_{1,i}\tilde{Z}_{1,i}) - h_1\mathbf{P}_1 \sum_{i=n_2+1}^{n_1} \tilde{Z}_{1,i}^2 \right] \end{aligned} \quad (109)$$

$$\begin{aligned} &= n_1 \bar{\mathbf{C}}_1 + \frac{\log e}{2(1+h_1(\mathbf{P}_1+\mathbf{P}_2))} \left[ h_1 \sum_{i=1}^{n_2} \left( X_{1,i}^2 - \frac{\mathbf{P}_1}{1+h_1\mathbf{P}_2} \tilde{Z}_{1,i}^2 \right) + 2 \langle \sqrt{h_1}X_{1,i}^{n_2}, \tilde{Z}_{1,i}^{n_2} \rangle \right] + \\ & \quad \frac{\log e}{2(1+h_1\mathbf{P}_1)} \left[ h_1 \sum_{i=n_2+1}^{n_1} (X_{1,i}^2 - \mathbf{P}_1 \tilde{Z}_{1,i}^2) + 2 \langle \sqrt{h_1}X_{1,n_2+1}^{n_1}, \tilde{Z}_{1,n_2+1}^{n_1} \rangle \right] \end{aligned} \quad (110)$$

where in (108) we define  $\bar{\mathbf{C}}_1$  and  $g_1$  as in (16) and (18), respectively. In (109) we expand the square of sums. Based on (110) we can derive the variance of the modified information density as follows.

For  $i \in [1, n_2]$ , from (110) we can see that

$$\mathbb{E}[\tilde{i}(X_i; Y_i)] = \mathbf{C} \left( \frac{h_1\mathbf{P}_1}{1+h_1\mathbf{P}_2} \right), \quad (111)$$

and

$$\text{Var}(\tilde{i}(X_i; Y_i)) = \frac{\log^2 e}{4(1+h_1(\mathbf{P}_1+\mathbf{P}_2))^2} \left\{ \mathbb{E} \left[ \left( h_1 \left( X_{1,i}^2 - \frac{\mathbf{P}_1}{1+h_1\mathbf{P}_2} \tilde{Z}_{1,i}^2 \right) + 2\sqrt{h_1} X_{1,i} \tilde{Z}_{1,i} \right)^2 \right] - \left( \left[ h_1 \left( X_{1,i}^2 - \frac{\mathbf{P}_1}{1+h_1\mathbf{P}_2} \tilde{Z}_{1,i}^2 \right) + 2\sqrt{h_1} X_{1,i} \tilde{Z}_{1,i} \right] \right)^2 \right\} \quad (112)$$

$$= \frac{\log^2 e}{4(1+h_1(\mathbf{P}_1+\mathbf{P}_2))^2} \left\{ \mathbb{E} \left[ h_1^2 X_{1,i}^4 + h_1^2 \left( \frac{\mathbf{P}_1}{1+h_1\mathbf{P}_2} \right)^2 \tilde{Z}_{1,i}^4 + 4h_1 X_{1,i}^2 \tilde{Z}_{1,i}^2 - 2h_1^2 \frac{\mathbf{P}_1}{1+h_1\mathbf{P}_2} X_{1,i}^2 \tilde{Z}_{1,i}^2 - 4h_1^{\frac{3}{2}} \frac{\mathbf{P}_1}{1+h_1\mathbf{P}_2} X_{1,i} \tilde{Z}_{1,i}^3 + 2h_1^{\frac{3}{2}} X_{1,i}^3 \tilde{Z}_{1,i} \right] \right\} \quad (113)$$

$$= \frac{\log^2 e}{(1+h_1(\mathbf{P}_1+\mathbf{P}_2))^2} \{ h_1^2 \mathbf{P}_1^2 + h_1 \mathbf{P}_1 (1+h_1\mathbf{P}_2) \} \quad (114)$$

$$= \frac{\log^2 e \cdot h_1 \mathbf{P}_1}{1+h_1(\mathbf{P}_1+\mathbf{P}_2)} \quad (115)$$

where in (114) we use the fact that  $\mathbb{E}[X_{1,i}^2] = \mathbf{P}_1$ ,  $\mathbb{E}[X_{1,i}^3] = 0$ ,  $\mathbb{E}[X_{1,i}^4] = 3\mathbf{P}_1^2$ ,  $\mathbb{E}[\tilde{Z}_{1,i}^2] = 1+h_1\mathbf{P}_2$ ,  $\mathbb{E}[\tilde{Z}_{1,i}^3] = 0$ , and  $\mathbb{E}[\tilde{Z}_{1,i}^4] = 3(1+h_1\mathbf{P}_2)^2$ . On the other hand, if  $i \in [n_2+1, n_1]$ , by setting  $\mathbf{P}_2 = 0$  in (115), we have

$$\mathbb{E}[\tilde{i}(X_i; Y_i)] = \mathbf{C}(h_1\mathbf{P}_1), \quad (116)$$

$$\text{Var}(\tilde{i}(X_i; Y_i)) = \frac{\log^2 e \cdot h_1 \mathbf{P}_1}{1+h_1\mathbf{P}_1}. \quad (117)$$

Then from (115) and (117) we know the dispersion is as follows

$$\bar{\mathbf{V}}_1 = \frac{1}{n_1} \text{Var}(\tilde{i}(X^{n_1}; Y^{n_1})) \quad (118)$$

$$= \frac{1}{n_1} \sum_{i=1}^{n_1} \text{Var}(\tilde{i}(X_i; Y_i)) \quad (119)$$

$$= \log^2 e \cdot \left( p \frac{h_1 \mathbf{P}_1}{1+h_1(\mathbf{P}_1+\mathbf{P}_2)} + (1-p) \frac{h_1 \mathbf{P}_1}{1+h_1\mathbf{P}_1} \right). \quad (120)$$

To show the convergence of the Berry-Esseen ratio of the weaker user, in addition to (120), we need to derive an upper bound of the absolute centralized third moment of the information density, which is shown as follows. We abuse the use of  $W_j$  as the information density of the weaker user at the  $j$ -th symbol. Then from the above we know that

$$W_j - \mu_{W_j} = \begin{cases} \frac{\log e}{2(1+h_1(\mathbf{P}_1+\mathbf{P}_2))} \left( h_1 \left( X_{1,i}^2 - \frac{\mathbf{P}_1}{1+h_1\mathbf{P}_2} \tilde{Z}_{1,i}^2 \right) + 2\sqrt{h_1} X_{1,i} \tilde{Z}_{1,i} \right), & 1 \leq j \leq n_2 \\ \frac{\log e}{2(1+h_1\mathbf{P}_1)} \left( h_1 \left( X_{1,i}^2 - \mathbf{P}_1 \tilde{Z}_{1,i}^2 \right) + 2\sqrt{h_1} X_{1,i} \tilde{Z}_{1,i} \right), & n_2+1 \leq j \leq n_1, \end{cases} \quad (121)$$

and we can bound the absolute centralized third moment of the information density as follows:

$$\begin{aligned}
& \sum_{j=1}^{n_1} \mathbb{E}_{XY} [|W_j - \mu_{W_j}|^3] \leq \\
& \frac{9}{8} \log^3 e \cdot \left\{ \frac{1}{(1+h_1(\mathbf{P}_1+\mathbf{P}_2))^3} \sum_{j=1}^{n_2} \left( \mathbb{E} \left[ \left| h_1 \left( X_{1,j}^2 - \frac{\mathbf{P}_1}{1+h_2\mathbf{P}_2} \tilde{Z}_{1,j}^2 \right) \right|^3 \right] + \mathbb{E} \left[ \left| 2\sqrt{h_1} X_{1,j} \tilde{Z}_{1,j} \right|^3 \right] \right) + \right. \\
& \quad \left. \frac{1}{(1+h_1\mathbf{P}_1)^3} \sum_{j=n_2+1}^{n_1} \left( \mathbb{E} \left[ \left| h_1 (X_{1,j}^2 - \mathbf{P}_1 \tilde{Z}_{1,j}^2) \right|^3 \right] + \mathbb{E} \left[ \left| 2\sqrt{h_1} X_{1,j} \tilde{Z}_{1,j} \right|^3 \right] \right) \right\} \\
& \leq \frac{9}{8} \log^3 e \cdot \left\{ \frac{1}{(1+h_1(\mathbf{P}_1+\mathbf{P}_2))^3} \sum_{j=1}^{n_2} \left( \mathbb{E} \left[ \left| h_1 X_{1,j}^2 \right|^3 \right] + \mathbb{E} \left[ \left| \frac{\mathbf{P}_1}{1+h_2\mathbf{P}_2} \tilde{Z}_{1,j}^2 \right|^3 \right] + \mathbb{E} \left[ \left| 2\sqrt{h_1} X_{1,j} \tilde{Z}_{1,j} \right|^3 \right] \right) \right. \\
& \quad \left. + \frac{1}{(1+h_1\mathbf{P}_1)^3} \sum_{j=n_2+1}^{n_1} \left( 9 \left( \mathbb{E} \left[ \left| h_1 X_{1,j}^2 \right|^3 \right] + \mathbb{E} \left[ \left| \mathbf{P}_1 \tilde{Z}_{1,j}^2 \right|^3 \right] \right) + \mathbb{E} \left[ \left| 2\sqrt{h_1} X_{1,j} \tilde{Z}_{1,j} \right|^3 \right] \right) \right\}. \quad (122)
\end{aligned}$$

We can easily see that each term of the summation in (122) is finite, which can be calculated by the absolute moments of  $X_{1,j}^2$  and  $\tilde{Z}_{1,j}^2$ . Therefore, we can further express (122) as follows:

$$\sum_{j=1}^{n_1} \mathbb{E}_{XY} [|W_j - \mu_{W_j}|^3] \leq a \cdot n_2 + b(n_1 - n_2) \quad (123)$$

$$\leq \begin{cases} a \cdot n_1, & \text{if } a \geq b \\ b \cdot n_1, & \text{else,} \end{cases} \quad (124)$$

where in (123),  $a > 0$  and  $b > 0$ . Then (122) is a linear scale of  $n_1$ . After dividing (122) by  $(\text{Var}(X^{n_1}; \tilde{Y}^{n_1}))^{\frac{3}{2}}$ , which can be easily seen from (120), we can observe that the Berry-Esseen ratio of the weaker user is upper bounded by  $O(n^{\frac{1}{2}})$ . Based on the above derived results, we can follow the same steps in Appendix I to complete the proof.  $\square$

#### APPENDIX IV. PROOF OF $\Pr \left( \sum_{j=1}^{n_2} (X_{1,j} + X_{2,j})^2 + \sum_{j=n_2+1}^{n_1} X_{1,j}^2 > n_1 \mathbf{P}_T \right) \leq e^{-O(n_2)}$

To simplify the expression, we define  $\tilde{X}_{1,j} := X_{1,j}/\sqrt{\bar{\mathbf{P}}_{11}}$ ,  $\tilde{X}_{2,j} := X_{2,j}/\sqrt{\bar{\mathbf{P}}_2}$ , and  $Z_j := \tilde{X}_{1,j}\tilde{X}_{2,j}$  where  $\tilde{X}_1, \tilde{X}_2 \in \mathcal{N}(0,1)$ ,  $\tilde{X}_1 \perp \tilde{X}_2$ ,  $j = 1, \dots, n_2$ . Then

$$\Pr \left( \sum_{j=1}^{n_2} X_{1,j} X_{2,j} \geq n_2 \delta \right) = \Pr \left( \sum_{j=1}^{n_2} Z_j \geq n_2 \cdot t \right), \quad (125)$$

where  $t := \frac{\delta}{\sqrt{\bar{\mathbf{P}}_{11}\bar{\mathbf{P}}_2}}$ . We can derive the moment generating function of  $Z_j$  as follows:

$$\mathbb{E} \left[ e^{\lambda Z_j} \right] = \frac{1}{\sqrt{1-\lambda^2}}. \quad (126)$$



Then by the Chernoff bound, we can derive the following:

$$\Pr \left( \sum_{j=1}^{n_2} Z_j \geq n_2 \cdot t \right) \leq \frac{(1 - \lambda^2)^{\frac{-n_2}{2}}}{e^{\lambda n_2 t}}. \quad (127)$$

By properly selecting an upper bound of the RHS of (127), e.g.,

$$\frac{1}{\sqrt{1 - \lambda^2}} \leq e^{2\lambda^2}, \quad (128)$$

where  $|\lambda| < 0.8$  and the RHS of (128) fulfills the definition of sub-exponential distribution [21, Def. 2.2] with the parameters  $(v, b) = (2, 1/0.8)$  due to  $|\lambda| < \frac{1}{b}$  by definition, which can be proved by simple calculus. Then we can invoke the sub-exponential tail bound [21, (2.20)] to derive (23) as follows:

$$\Pr \left( \sum_{j=1}^{n_2} Z_j \geq n_2 \cdot t \right) \leq e^{\frac{-n_2 t^2}{2v^2}} = e^{\frac{-n_2 \delta^2}{8P_{11}P_2}}. \quad (129)$$

Now we consider the outage of (19) with the definition  $A_{11} := \sum_{j=1}^{n_2} X_{1,j}^2$ ,  $A_2 := \sum_{j=1}^{n_2} X_{2,j}^2$ ,  $C := 2 \sum_{j=1}^{n_2} X_{1,j} X_{2,j}$ , and  $A_{12} := \sum_{j=n_2+1}^{n_1} X_{1,j}^2$  as follows:

$$\begin{aligned} & \Pr \left( \sum_{j=1}^{n_2} (X_{1,j} + X_{2,j})^2 + \sum_{j=n_2+1}^{n_1} X_{1,j}^2 > n_1 P_T \right) \\ &= \Pr (A_{11} + A_2 + C + A_{12} > n_1 P_T) \end{aligned} \quad (130)$$

$$\begin{aligned} &= \Pr (A_{11} + A_2 + C + A_{12} - 2n_2 \delta > n_1 P_T - 2n_2 \delta) \\ &:= \Pr (A_{11} + A_2 + A_{12} + C' > n_1 P_T - 2n_2 \delta) \end{aligned} \quad (131)$$

$$\begin{aligned} &= \Pr (A_{11} + A_2 + A_{12} + C' > n_1 P_T - 2n_2 \delta \cap C' > 0) + \\ & \quad \Pr (A_{11} + A_2 + A_{12} + C' > n_1 P_T - 2n_2 \delta \cap C' \leq 0) \end{aligned} \quad (132)$$

$$\leq \Pr (C' > 0) + \Pr (A_{11} + A_2 + A_{12} + C' > n_1 P_T - 2n_2 \delta \cap C' \leq 0) \quad (133)$$

$$\begin{aligned} &= \Pr (C' > 0) + \\ & \quad \int_{c' \in \text{supp}(C') \text{ and } c' \leq 0} \Pr (A_{11} + A_2 + A_{12} > n_1 P_T - 2n_2 \delta + |c'|) dF_{C'}(c') \end{aligned} \quad (134)$$

where in (131) we define  $C' := C - 2n_2 \delta$ , in (133) less constraints lead to larger probabilities.

Define  $A'_{11} := A_{11} - n_2 P_{11} + \frac{2n_2\delta}{3}$ ,  $A'_{12} := A_{12} - (n_1 - n_2)P_{12} + \frac{2n_2\delta}{3}$ ,  $A'_2 := A_2 - n_2 P_2 + \frac{2n_2\delta}{3}$ . Then we can express the integrand in (134) as follows:

$$\begin{aligned} \Pr(A_{11} + A_2 + A_{12} > n_1 P_T - 2n_2\delta + |c'|) \\ = \Pr(A'_{11} + A'_2 + A'_{12} > n_1 P_T - n_2 P_{11} - n_2 P_2 - (n_1 - n_2)P_{12} + |c'|) \end{aligned} \quad (135)$$

$$\leq \Pr(A'_{11} + A'_2 + A'_{12} > c + |c'|) \quad (136)$$

$$= \Pr(A'_{11} + A'_2 + A'_{12} > 2n_2\delta) \quad (137)$$

$$\leq \Pr(A'_{11} + A'_2 + A'_{12} > 0) \quad (138)$$

$$\leq \Pr(A'_{11} > 0) + \Pr(A'_2 > 0) + \Pr(A'_{12} > 0), \quad (139)$$

where (136) is due to the expansion of (19) followed by the substitution of (21), (137) is due to the fact that  $c' \leq 0$  in the second term in (134), then  $|c'| = -c + 2n_2\delta$ . (138) is because  $\delta > 0$ , (139) is by recursively using steps from (130) to (134) and select the term in the absolute value in (139) as zero in each recursive step, which will maximize the probabilities. From (52) we know that, with a proper power back-off, we can upper bound (139) by  $e^{-O(n_2)}$ . Combine (129) with (134), and (139), we have (23). To derive (24), we can follow the same steps to derive (139) with a slight modification, which completes the proof.  $\square$ .

## APPENDIX V. PROOF OF PROPOSITION 2

After dividing both sides of (22) by  $n_1$ , we can rearrange it as follows

$$pP_{1,1} + (1-p)P_{1,2} \leq P_T - pP_2, \quad (140)$$

while the input violation probability is upper bounded by  $e^{-O(n_2)}$ , when doing the error analysis.

To proceed, we can generalize the expression in (120) from (115) and (117), and (119), to the following form:

$$\bar{V}'_1 = \log^2 e \cdot \left( p \frac{g'_1 P_{1,1}}{1 + g'_1 P_{1,1}} + (1-p) \frac{g'_2 P_{1,2}}{1 + g'_2 P_{1,2}} \right), \quad (141)$$

where  $g'_1 := \frac{h_1}{1+h_1 P_2}$  and  $g'_2 = h_1$  are the equivalent channel gains when the code symbol indices are from 1 to  $n_1$  and from  $n_2 + 1$  to  $n_1$ , respectively. Then we can derive  $\bar{V}'_1$  as (29). Similarly, we can derive  $\bar{C}'$  from (111) as (28), which completes the proof.

## REFERENCES

- [1] P.-H. Lin, S.-C. Lin, and E. A. Jorswieck, “Early decoding for gaussian broadcast channels with heterogeneous blocklength constraints,” *Proc. IEEE Int. Symp. Inf. Theory 2021*.
- [2] 3GPP, “Study on scenarios and requirements for next generation access technologies,” *Technical Report 38.913, Release 14*, Oct. 2016.
- [3] —, “Summary of email discussion on the link level evaluation for LTE URLLC,” *Technical Report, TSG RAN WG1 Meeting No.92, R1—1801385*, Mar. 2018.
- [4] G. Durisi, T. Koch, and P. Popovski, “Toward massive, ultrareliable, and low-latency wireless communication with short packets,” *Proceedings of the IEEE*, vol. 104, no. 9, pp. 1711–1726, 2016.
- [5] Y. Polyanskiy, H. V. Poor, and S. Verdú, “Channel coding rate in the finite blocklength regime,” *IEEE Trans. Inf. Theory*, vol. 56, no. 5, pp. 2307–2359, May 2010.
- [6] E. MolavianJazi and J. N. Laneman, “A second-order achievable rate region for gaussian multi-access channels via a central limit theorem for functions,” *IEEE Transactions on Information Theory*, vol. 61, no. 12, pp. 6719–6733, 2015.
- [7] V. Y. F. Tan and O. Kosut, “On the dispersions of three network information theory problems,” *IEEE Transactions on Information Theory*, vol. 60, no. 2, pp. 881–903, 2014.
- [8] A. Ünsal and J. Gorce, “The dispersion of superposition coding for Gaussian broadcast channels,” in *2017 IEEE Information Theory Workshop (ITW)*, 2017, pp. 414–418.
- [9] J. Scarlett, “On the dispersions of the Gel’fand-Pinsker channel and dirty paper coding,” *IEEE Trans. Inf. Theory*, vol. 61, no. 9, pp. 4569–4586, Sept. 2015.
- [10] P. K. Korrai, E. Lagunas, A. Bandi, S. K. Sharma, and S. Chatzinotas, “Joint power and resource block allocation for mixed-numerology-based 5G downlink under imperfect CSI,” *IEEE Open Journal of the Communications Society*, vol. 1, pp. 1583–1601, 2020.
- [11] Y. Xu, C. Shen, T. Chang, S. Lin, Y. Zhao, and G. Zhu, “Transmission energy minimization for heterogeneous low-latency NOMA downlink,” *IEEE Trans. Wireless Commun.*, vol. 19, no. 2, pp. 1054–1069, 2020.
- [12] D. Tuninetti, B. Smida, N. Devroye, and H. Seferoglu, “Scheduling on the Gaussian broadcast channel with hard deadlines,” in *2018 IEEE International Conference on Communications (ICC)*, 2018, pp. 1–7.
- [13] K. Azarian, H. E. Gamal, and P. Schniter, “On the achievable diversity-multiplexing tradeoff in half-duplex cooperative channels,” *IEEE Trans. Inf. Theory*, vol. 51, no. 12, pp. 4152–4272, Dec. 2005.
- [14] A. Jovicic and P. Viswanath, “Cognitive radio: an information-theoretic perspective,” *IEEE Trans. Inf. Theory*, vol. 55, no. 9, pp. 3945–3958, Sep. 2009.
- [15] J. Hou and G. Kramer, “Short message noisy network coding with a decode-forward option,” *IEEE Transactions on Information Theory*, vol. 62, no. 1, pp. 89–107, 2016.
- [16] C. Sahin, L. Liu, and E. Perrins, “Early decoding for transmission over finite transport blocks,” in *2014 IEEE International Symposium on Information Theory*, 2014, pp. 1558–1562.

- [17] W. Feller, *An Introduction to Probability Theory and Its Applications, Vol. II*, 2nd ed. New York: Wiley, 1971.
- [18] H. Sato, “An outer bound to the capacity region of broadcast channels (corresp.),” *IEEE Transactions on Information Theory*, vol. 24, no. 3, pp. 374–377, 1978.
- [19] E. MolavianJazi, “A unified approach to Gaussian channels with finite blocklength,” *Dissertation*, July 2014.
- [20] B. Laurent and P. Massart, “Adaptive estimation of a quadratic functional by model selection,” *The Annals of Statistics*, vol. 28, no. 5, pp. 1302 – 1338, 2000. [Online]. Available: <https://doi.org/10.1214/aos/1015957395>
- [21] M. Wainwright, *High-Dimensional Statistics: A Non-Asymptotic Viewpoint*, 1st ed. Cambridge university press, 2019.
- [22] A. Collins and Y. Polyanskiy, “Coherent multiple-antenna block-fading channels at finite blocklength,” *IEEE Transactions on Information Theory*, vol. 65, no. 1, pp. 380–405, 2019.