

A KNOT FLOER STABLE HOMOTOPY TYPE

CIPRIAN MANOLESCU AND SUCHARIT SARKAR

ABSTRACT. Given a grid diagram for a knot or link K in S^3 , we construct a spectrum whose homology is the knot Floer homology of K . We conjecture that the homotopy type of the spectrum is an invariant of K . Our construction does not use holomorphic geometry, but rather builds on the combinatorial definition of grid homology. We inductively define models for the moduli spaces of pseudo-holomorphic strips and disk bubbles, and patch them together into a framed flow category. The inductive step relies on the vanishing of an obstruction class that takes values in a complex of positive domains with partitions.

CONTENTS

1. Introduction	1
2. Background	5
3. The complex of positive domains	10
4. The complex of positive domains with partitions	19
5. $\langle n \rangle$ -manifolds	24
6. Stratified spaces	27
7. Local models	32
8. Moduli spaces	38
9. The stratification	45
10. Embeddings and framings	51
11. The embedded framed cobordism group	55
12. Constructing the moduli spaces	60
13. Embedding and framing the permutohedra	68
14. The Cohen-Jones-Segal construction	82
References	88

1. INTRODUCTION

In [6], Cohen, Jones, and Segal proposed the problem of lifting Floer homology to a Floer spectrum or pro-spectrum, in the sense of stable homotopy theory. Since then, stable homotopy refinements of Floer homology have been constructed in Seiberg-Witten theory [19, 12, 36] and symplectic geometry [7, 15, 1]. In a similar vein, there is a lift of Khovanov homology to a stable homotopy type [18, 17].

The purpose of this paper is to construct a stable homotopy refinement of knot Floer homology. Knot Floer homology was developed by Ozsváth-Szabó [28] and Rasmussen [34], and has many

Manolescu was supported by NSF Grant DMS-2003488 and a Simons Investigator Award.

Sarkar was supported by NSF Grant DMS-1905717.

rectangles are domains of index 1, in order to construct the spectrum $\mathcal{X}^+(\mathbb{G})$ we have to consider positive domains of arbitrary index. Indeed, each moduli space $\mathcal{M}([D])$ in the framed flow category is associated to an equivalence class of positive domains D on the grid, where two domains are equivalent if they differ by a periodic domain (a linear combination of vertical and horizontal annuli) which has coefficient zero on all O markings. We only consider domains D that do not cross the specified marking X_n .

1.1. Bubbling. The spaces $\mathcal{M}([D])$ admit compactifications $\overline{\mathcal{M}}([D])$ which correspond to moduli spaces of broken holomorphic strips. Furthermore, each $\overline{\mathcal{M}}([D])$ will be the union of spaces $\overline{\mathcal{M}}_0(D)$ associated to positive domains D in the equivalence class $[D]$, where the different $\overline{\mathcal{M}}_0(D)$ are glued along their common boundaries. These common boundaries correspond to moduli spaces of disk bubbles in symplectic geometry.

We are thus forced to also build models for the moduli spaces of bubbles. This is one of the novel aspects of our construction. Previously, stable homotopy refinements of Floer homologies have mostly been done in the absence of bubbles. (One notable exception is the work of Abouzaid and Blumberg [1], which produces a lift of Hamiltonian Floer homology to Morava K-theory allowing for bubbles.) In general situations where bubbles appear, not even Floer homology is always well-defined, as the differential on the Floer complex may not square to zero.

In the link Floer complex (and, more generally, in Heegaard Floer complexes), bubbles appear but they cancel in pairs, so that the differential does square to zero. In the setting of grid diagrams, bubbles correspond to vertical and horizontal annuli, and the two annuli going through the same O -marking cancel each other out. In our construction of $\mathcal{X}^+(\mathbb{G})$, we implement a higher dimensional analogue of this cancellation: the spaces $\overline{\mathcal{M}}_0(D)$ by themselves are stratified spaces with a complicated structure, but after we glue them together the resulting $\overline{\mathcal{M}}([D])$ is a manifold-with-corners of the kind that is used to define a framed flow category.

To understand the strata in the compactifications $\overline{\mathcal{M}}_0(D)$, we will construct more general spaces $\overline{\mathcal{M}}_{\vec{N}, \vec{\lambda}}(D)$, which are models for the moduli spaces of pseudo-holomorphic strips with disk bubbles attached. The bubble configuration is described by vectors

$$\vec{N} = (N_1, \dots, N_n), \quad \vec{\lambda} = (\lambda_1, \dots, \lambda_n)$$

where N_j are non-negative integers, and λ_j is an ordered partition of N_j . The number N_j counts the bubbles going through the j th O -marking. These bubbles are grouped according to the partition λ_j , with those in the same part appearing at the same height on the boundary of the pseudo-holomorphic strip.

Each $\overline{\mathcal{M}}_{\vec{N}, \vec{\lambda}}(D)$ is a stratified space. The local models for the strata are quite interesting, being based on a stratification of the symmetric product $\text{Sym}^N(\mathbb{C})$ modulo translation by \mathbb{R} . Specifically, we consider the stratification of $\text{Sym}^N(\mathbb{C})/\mathbb{R}$ given by the signs of the imaginary parts of the N complex numbers. For example, when $N = 2$, we will encounter the Whitney umbrella

$$W = \{(a, b, c) \in \mathbb{R}^3 \mid b \geq 0, a^2b = c^2\}.$$

We hope that these models for the moduli spaces of trajectories with bubbles are of independent interest, as they may appear in other settings. However, we warn the reader that the bubble configurations we use in this paper are more limited than the ones usually considered in the Gromov compactification in symplectic geometry. See Remark 8.8 for more details.

1.2. The inductive construction. We now sketch the construction of the spaces $\overline{\mathcal{M}}_{\vec{N}, \vec{\lambda}}(D)$. These will come equipped with suitable embeddings (called *neat*) in Euclidean spaces, and also with normal

framings. Since the spaces $\overline{\mathcal{M}}_{\vec{N}, \vec{\lambda}}(D)$ are not manifolds, it is not immediate what we mean by framings. We will in fact distinguish two different collections of vector fields, the *internal* and *external* framings. More details on these can be found in Section 10.

The construction of the spaces $\overline{\mathcal{M}}_{\vec{N}, \vec{\lambda}}(D)$ goes as follows:

- We first construct them when D is trivial, and all the entries of \vec{N} are 0's and 1's. In this case we define $\overline{\mathcal{M}}_{\vec{N}, \vec{\lambda}}(D)$ to be a permutohedron, and explain how to give it a normal framing;
- We define the rest of the spaces $\overline{\mathcal{M}}_{\vec{N}, \vec{\lambda}}(D)$ inductively on their dimension k . For the base case $k = 0$, we define them to be points, and give them suitable framings;
- For the inductive step, we suppose all spaces up to dimension k have been constructed. To construct a $(k+1)$ -dimensional space $\overline{\mathcal{M}}_{\vec{N}, \vec{\lambda}}(D)$, we start with its (already constructed) boundary $\partial \overline{\mathcal{M}}_{\vec{N}, \vec{\lambda}}(D)$ and smooth it to get a k -dimensional framed manifold $\partial' \overline{\mathcal{M}}_{\vec{N}, \vec{\lambda}}(D)$;
- From here we get an element $[\partial' \overline{\mathcal{M}}_{\vec{N}, \vec{\lambda}}(D)] \in \widehat{\Omega}_{\text{fr}}^k$, where $\widehat{\Omega}_{\text{fr}}^k$ is a slight variant of the usual framed cobordism group Ω_{fr}^k (and, in fact, is isomorphic to Ω_{fr}^k);
- We define a chain complex CDP_* whose generators are “positive domains with partitions,” i.e., triples $(D, \vec{N}, \vec{\lambda})$. We let CDP'_* be the quotient of CDP_* by the subcomplex generated by (D, \vec{N}, λ) where D is a chosen trivial domain, and \vec{N} is made of 0's and 1's. Altogether, the classes $[\partial' \overline{\mathcal{M}}_{\vec{N}, \vec{\lambda}}(D)]$ produce an obstruction class

$$\mathfrak{o}_k \in \text{Hom}(CDP'_{k+1}, \widehat{\Omega}_{\text{fr}}^k);$$

- We show that \mathfrak{o}_k is a cocycle, and that CDP'_* is acyclic. It follows that \mathfrak{o}_k is the coboundary of some element $\mathfrak{b} \in \text{Hom}(CDP'_k, \widehat{\Omega}_{\text{fr}}^k)$;
- We use \mathfrak{b} to adjust the definition of the k -dimensional moduli spaces that we previously constructed, so that all cocycles \mathfrak{o}_k vanish. (We do not change the definition of any moduli spaces of dimension $k-1$ or lower.)
- Then $\partial' \overline{\mathcal{M}}_{\vec{N}, \vec{\lambda}}(D)$ is framed null-cobordant. We fill it in arbitrarily to obtain the desired framed moduli space $\overline{\mathcal{M}}_{\vec{N}, \vec{\lambda}}(D)$, and continue with the induction.

A key role in this construction is played by the complex CDP'_* . To define CDP'_* , we first introduce a chain complex CD_* generated by positive domains on the grid; this is a close cousin of the complex of positive pairs CP^* used in [23, Section 4]. We then enhance CD_* by adding vectors of partitions to its generators; the result is the complex CDP_* . We show that the homology of CDP_* is supported by triples $(D, \vec{N}, \vec{\lambda})$ where D is a fixed trivial domain and \vec{N} is made of 0's and 1's; hence, the quotient CDP'_* of CDP_* by these triples is acyclic. Thus, it is important that we first defined some moduli spaces by hand (to be permutohedra); otherwise we would have had to work with CDP_* , which is not acyclic.

Once the framed moduli spaces $\overline{\mathcal{M}}_{\vec{N}, \vec{\lambda}}(D)$ are defined, the spectrum $\mathcal{X}^+(\mathbb{G})$ is obtained by a standard procedure from [6], [18]. We remark that for the version $\mathcal{X}^+(\mathbb{G})$, we only use moduli spaces $\overline{\mathcal{M}}_0(D)$ for domains D that do not cross any X -markings. These spaces do not involve configurations of bubbles, because D cannot contain a full row or column. Nevertheless, if we had tried to construct only these spaces $\overline{\mathcal{M}}_0(D)$, we would have run into the problem that the analogue of CDP'_* (using domains that do not cross the X -markings) is not acyclic. Thus, even if we were only interested in the plus version $\mathcal{X}^+(\mathbb{G})$, we still had to build all the spaces $\overline{\mathcal{M}}_{\vec{N}, \vec{\lambda}}(D)$ and discuss bubbling.

1.3. Further directions. We conjecture that the stable homotopy type of $\mathcal{X}^+(\mathbb{G})$ is a link invariant, that is, it is independent of the choice of grid diagram \mathbb{G} representing a given link. The proof of this

is beyond the scope of the present paper. Invariance of grid homology is proved in [22] by checking the Cromwell-Dynnikov moves: cyclic permutation, commutation, and stabilization. We expect that a combination of those arguments with the techniques from this paper will yield invariance for $\mathcal{X}^+(\mathbb{G})$. The main challenge is to prove that suitable complexes of positive domains and partitions associated to the commutation and stabilization moves are acyclic.

Another limitation of our paper is that we only consider domains that do not cross a given marking X_n . The reason for this is to ensure the acyclicity of CDP'_* . One can check that the analogue of CDP'_* using all domains on the grid is not acyclic. Nevertheless, one can compute its homology and attempt to get a handle on the analogues of the obstruction classes $[\mathfrak{o}_k]$. We expect that all versions of grid homology (including those involving domains that go over X_n) admit stable homotopy refinements, in the form of spectra or pro-spectra.

1.4. Organization of the paper. In Section 2 we fix notation and review some facts about grid diagrams and grid homology.

In Section 3 we define the complex CD_* whose generators are positive domains on the grid.

In Section 4 we define the complex CDP_* of positive domains with partitions, we compute its homology, and introduce the acyclic quotient CDP'_* .

In Section 5 we review $\langle n \rangle$ -manifolds, the type of manifolds with corners that are used in framed flow categories.

In Section 6 we discuss different notions of stratified spaces, such as Whitney and Thom-Mather stratifications.

In Section 7 we describe the local models for the stratified spaces that appear in this paper; these are generalizations of the Whitney umbrella.

In Section 8 we give examples of stratified spaces that can be associated to some simple domains on the grid.

In Section 9 we list the strata that should be included in the compactification of each space $\mathcal{M}_{\vec{N}, \vec{\lambda}}(D)$.

In Section 10 we introduce the notion of neat embedding for a space $\overline{\mathcal{M}}_{\vec{N}, \vec{\lambda}}(D)$, and explain what we mean by internal and external framings.

In Section 11 we define the embedded framed cobordism group $\tilde{\Omega}_{\text{fr}}^k$, and show that it is isomorphic to the usual Ω_{fr}^k .

Section 12 is the heart of the paper, in which we construct the spaces $\overline{\mathcal{M}}_{\vec{N}, \vec{\lambda}}(D)$ inductively.

The case where D is trivial and \vec{N} is made of 0's and 1's is relegated to Section 13, where we describe a neat embedding of the permutohedron, and give it a normal framing.

Finally, in Section 14 we review the Cohen-Jones-Segal construction of a spectrum from a framed Floer category. We then define $\mathcal{X}^+(\mathbb{G})$ and its variants, and give some examples.

1.5. Conventions. Throughout the paper \mathbb{N} denotes the natural numbers including 0. We also let $\mathbb{R}_+ = [0, \infty)$.

1.6. Acknowledgements. We would like to thank Mohammed Abouzaid, Mike Hill, and Danny Ruberman for helpful conversation. We are particularly indebted to Robert Lipshitz who suggested a key idea for framing the permutohedron in Section 13.

2. BACKGROUND

2.1. Grid diagrams. Definitions and notions related to grid diagrams have been listed in the following enumerated list. For details, see [21, 22, 32].

- (G-1) An index- n *grid diagram* \mathbb{G} consists of the torus, obtained from $[0, n] \times [0, n]$ by identifying opposite edges, n ‘horizontal’ α -circles, $\alpha_1, \dots, \alpha_n$, with α_i being the image of $[0, n] \times \{i-1\}$, and n ‘vertical’ β -circles, β_1, \dots, β_n , with β_i being the image of $\{i-1\} \times [0, n]$.
- (G-2) The n components of the complement of α circles are called *horizontal annuli* or *rows*, the n components of the complement of β circles are called *vertical annuli* or *columns*, and the n^2 components of the complement of α and β circles are called *square regions*.
- (G-3) Grid diagrams are decorated with n *O-markings*, O_1, \dots, O_n , placed in n distinct square regions so that each horizontal annulus has one O marking and each vertical annulus has one O marking. Let H_i , respectively V_i , be the horizontal, respectively vertical, annulus that contains O_i .
- (G-4) We can also order and label the annuli more naturally, without regard for the position of the O ’s. We define the horizontal annulus $H_{(i)}$ to be the image of $[0, n] \times (i-1, i)$, and the vertical annulus $V_{(i)}$ to be the image of $(i-1, i) \times [0, n]$.
- (G-5) Grid diagrams will also be decorated with n *X-markings*, X_1, \dots, X_n , placed in n distinct square regions so that each horizontal annulus has one X marking and each vertical annulus has one X marking; since we are working on a torus, without loss of generality, we will assume that X_n lies in the ‘top-right’ square region, that is,

$$X_n \in H_{(n)} \cap V_{(n)}.$$

- (G-6) By joining the O and X markings by segments in each row and column, and letting the vertical segments be overpasses, we obtain a planar diagram for a link $L \subset S^3$. We say that \mathbb{G} is a grid diagram presentation for the link L .
- (G-7) A *generator* or a *state* x is a unordered n -tuple (x_1, \dots, x_n) of points on the torus, so that each α -circle contains some x_i and each β -circle contains some x_j . The x_i ’s are called the *coordinates* of x . We sometimes view x as a formal sum of its coordinates, $x_1 + x_2 + \dots + x_n$. Generators are in one-to-one correspondence with permutations of $\{1, 2, \dots, n\}$, with permutation σ corresponding to the generator

$$x^\sigma = (\alpha_{\sigma(1)} \cap \beta_1, \alpha_{\sigma(2)} \cap \beta_2, \dots, \alpha_{\sigma(n)} \cap \beta_n).$$

The set of all generators on a grid diagram \mathbb{G} is denoted $\mathbb{S} = \mathbb{S}(\mathbb{G})$.

- (G-8) A *domain* D from a generator x to a generator y is a 2-chain given by a \mathbb{Z} -linear combination of (the closures of) the square regions, with the property that $\partial D \cap \alpha = y - x$. In this paper, we are only interested in domains that have coefficient zero at X_n , and we will let $\mathcal{D}(x, y)$ denote the set of domains from x to y that avoid X_n .
- (G-9) For any domain D , let $\mathbb{O}(D) \in \mathbb{Z}^n$ be the vector that records the coefficients of D at the O -markings; that is, the i^{th} component of $\mathbb{O}(D)$, denoted $O_i(D)$, is the coefficient of D at O_i , for $1 \leq i \leq n$. Similarly, we let $\mathbb{X}(D) \in \mathbb{Z}^n$ be the vector that records the coefficients of D at the X -markings.
- (G-10) We let $\vec{e}_i = \mathbb{O}(H_i) = \mathbb{O}(V_i) \in \mathbb{Z}^n$ be the coordinate vector with 1 in position i , and zeros elsewhere;
- (G-11) Given $D \in \mathcal{D}(x, y), E \in \mathcal{D}(y, z)$, by adding the underlying 2-chains, we get a domain $D * E \in \mathcal{D}(x, z)$.
- (G-12) A domain is said to be *positive* if it has no negative coefficients. Let $\mathcal{D}^+(x, y) \subset \mathcal{D}(x, y)$ be the subset of positive domains. (Note that this includes the zero domain.)
- (G-13) For any generators x, y , the set $\mathcal{D}(x, x)$ can be identified with $\mathcal{D}(y, y)$ by identifying the underlying 2-chains. We call either of these sets \mathcal{P} , the set of *periodic domains*. Further, we

denote by \mathcal{P}^+ the subset consisting of positive periodic domains (including zero). We have

$$\mathcal{P} = \mathbb{Z}\langle H_{(1)}, \dots, H_{(n-1)}, V_{(1)}, \dots, V_{(n-1)} \rangle \quad \mathcal{P}^+ = \mathbb{N}\langle H_{(1)}, \dots, H_{(n-1)}, V_{(1)}, \dots, V_{(n-1)} \rangle.$$

Indeed, for any periodic domain, its multiplicity at the region $H_{(i)} \cap V_{(n)}$, respectively $H_{(n)} \cap V_{(i)}$, gives the coefficient of $H_{(i)}$, respectively $V_{(i)}$, in the above formula.

(G-14) For every domain D , there is an associated integer $\mu(D)$ called its Maslov index, satisfying the following properties:

- (a) For any $D \in \mathcal{D}(x, y), E \in \mathcal{D}(y, z)$, $\mu(D * E) = \mu(D) + \mu(E)$.
- (b) For any $D \in \mathcal{D}^+(x, y)$, $\mu(D) \geq 0$.
- (c) If $D \in \mathcal{D}^+(x, y)$, then $\mu(D) = 0$ if and only if $x = y$ and D is the trivial domain; let $c_x \in \mathcal{D}^+(x, x)$ denote the trivial domain.
- (d) If $D \in \mathcal{D}^+(x, y)$, then $\mu(D) = 1$ if and only if D is a *rectangle* in the torus: its ‘bottom-left’ and ‘top-right’ corners are coordinates of x and its ‘bottom-right’ and ‘top-left’ corners are coordinates of y ; the other $(n - 2)$ -coordinates of x and y agree and none of them lie in D . Let

$$\mathcal{R}(x, y) = \{D \in \mathcal{D}^+(x, y) \mid \mu(D) = 1\}.$$

- (e) If $D \in \mathcal{D}^+(x, y)$, then $\mu(D) = k$ if and only if D has a (possibly non-unique) *decomposition* into rectangles

$$D = R_1 * R_2 * \dots * R_k \quad R_1 \in \mathcal{R}(x = w_0, w_1), R_2 \in \mathcal{R}(w_1, w_2), \dots, R_k \in \mathcal{R}(w_{k-1}, w_k = y).$$

In particular, D is a positive index-2 domain if and only if it can be decomposed into two rectangles; that is, it can be two rectangles, either overlapping like a cross or disjoint,

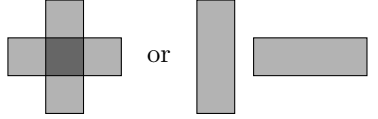

or a hexagon in one of four possible shapes,

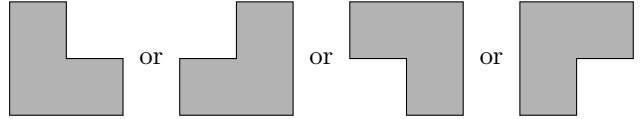

or a horizontal annulus, or a vertical annulus. Note, in the first six cases, D has exactly two decompositions into rectangles, while in the last two cases, D has exactly one.

(G-15) Generators carry a well-defined integer-valued grading—called the Maslov grading and denoted $\text{gr}(x)$ —so that for any domain $D \in \mathcal{D}(x, y)$,

$$\text{gr}(x) - \text{gr}(y) = \mu(D) - 2|\mathbb{O}(D)|,$$

where $|\mathbb{O}(D)| = \sum_i O_i(D)$.

(G-16) Generators also admit an Alexander grading $A(x) \in \mathbb{Z}$ with the property that for any $D \in \mathcal{D}(x, y)$,

$$A(x) - A(y) = |\mathbb{X}(D)| - |\mathbb{O}(D)|.$$

In fact, if L is a link of ℓ components, we have an Alexander multi-grading $(A_1(x), \dots, A_\ell(x)) \in (\frac{1}{2}\mathbb{Z})^\ell$ such that $A(x) = A_1(x) + \dots + A_\ell(x)$.

(G-17) A *sign assignment* s is a function $s: \cup_{x,y} \mathcal{R}(x,y) \rightarrow \{\pm 1\}$ satisfying the following. For any $D \in \mathcal{D}^+(x,y)$ with $\mu(D) = 2$ that is not a horizontal or a vertical annulus (that is, one of the types pictured above), if $R_1 * S_1$ and $R_2 * S_2$ are the two decompositions of D into rectangles, then

$$(2.1) \quad s(R_1)s(S_1) = -s(R_2)s(S_2).$$

Furthermore, if $R * S$ is a decomposition of a horizontal annulus into rectangles, then

$$(2.2) \quad s(R)s(S) = 1,$$

and if $R * S$ is a decomposition of a vertical annulus into rectangles, then

$$(2.3) \quad s(R)s(S) = -1.$$

2.2. Grid complexes. Let \mathbb{G} be a grid diagram decorated with O - and X -markings and equipped with a sign assignment s . To \mathbb{G} one can associate chain complexes in various flavors, which are typically called *grid complexes*. We will concentrate on the following flavor. As an Abelian group, the chain group $GC^+ = GC^+(\mathbb{G})$ is freely generated by elements of the form

$$[x, j_1, \dots, j_n], \quad x \in \mathbb{S}, \quad j_1, \dots, j_n \in \mathbb{N}.$$

The homological grading of a generator is

$$\text{gr}([x, j_1, \dots, j_n]) = \text{gr}(x) + 2j_1 + \dots + 2j_n.$$

We equip GC^+ with the structure of a module over $\mathbb{Z}[U_1, \dots, U_n]$, by letting U_i act on $[x, j_1, \dots, j_n]$ by decreasing j_i by 1, if $j_i \geq 1$; if $j_i = 0$, then U_i acts by zero. Notice that U_i has homological grading (-2) . We can alternatively describe the generators of GC^+ as

$$U_1^{-j_1} \dots U_n^{-j_n} x = [x, j_1, \dots, j_n].$$

The differential on GC^+ is given by

$$\partial([x, j_1, \dots, j_n]) = \sum_y \sum_{\substack{R \in \mathcal{R}(x,y) \\ \mathbb{X}(R) = (0, \dots, 0)}} s(R) U^{\mathbb{O}(R)} [y, j_1, \dots, j_n],$$

where we used the notation

$$U^{\mathbb{O}(R)} := U_1^{O_1(R)} \dots U_n^{O_n(R)}.$$

The complex GC^+ admits an Alexander multi-grading induced from the one on generators. If O_i is in the j th component of the link L , we let U_i decrease the Alexander grading component A_j by one, and keep the other components constant.

Grid diagrams are particular examples of Heegaard diagrams for link complements, and grid complexes correspond to link Floer complexes, as in [30]. From any Heegaard diagram \mathcal{H} of a link $L \subset S^3$, one can define a link Floer complex $gCFL^+(\mathcal{H})$, in the same way as we did for GC^+ , but using pseudo-holomorphic disks instead of rectangles. When L is a knot and the Heegaard diagram has only two basepoints, $gCFL^+ = gCFK^+$ is the associated graded (with respect to the Alexander filtration) of the knot Floer complex CFK^+ defined in [28]. The homology of $gCFK^+$ is the knot Floer homology HFK^+ . For links (or for knots with more basepoints), the more common version of a link Floer complex studied in the literature is CFL^- , with generators

$$U_1^{j_1} \dots U_n^{j_n} x, \quad x \in \mathbb{S}, \quad j_1, \dots, j_n \in \mathbb{N},$$

and differentials going over both types of basepoints. Its associated graded with respect to the Alexander filtration is $gCFL^-$, with homology the link Floer homology $HFL^-(L)$. It is proved in

[21, Section 2] that this is an invariant of L . The module structure on HFL^- is as follows: If L_1, \dots, L_ℓ are the link components of L , then $HFL^-(L)$ is a module over $\mathbb{Z}[U'_1, \dots, U'_\ell]$, where all U_i variables corresponding to markings on L_j act as a single U'_j , for $j = 1, \dots, \ell$.

For completeness, we include here the invariance result for the plus version.

Proposition 2.1. *The homology $HFL^+(L)$ of $gCFL^+(\mathcal{H})$, together with its Alexander multi-grading and $\mathbb{Z}[U'_1, \dots, U'_\ell]$ -module structure, is an invariant of the link L . The U_i variables corresponding to markings on the same link component $L_j \subset L$ all act the same way on $HFL^+(L)$, as U'_j .*

Proof. If we restrict to Heegaard diagrams with only two basepoints on each link component, the argument is entirely similar to that in [30, Theorem 4.7]; it involves checking invariance under isotopies, handleslides, and index one/two stabilizations. Note that in this case there is a single U variable for each component, and we can call it U'_j .

Once we allow more basepoints, we also need to check invariance under index zero/three stabilizations. This was done for the minus version in [21, Section 2]. For the plus version, the arguments there show that the stabilized complex C' is isomorphic to a mapping cone

$$(2.4) \quad C[U_1^{-1}] \xrightarrow{U_1 - U_2} C[U_1^{-1}],$$

where C is the complex $gCFL^+$ for the diagram before stabilization, U_1 is a new variable, and U_2 is an old variable for a marking on the same link component. We would like to show that C' is quasi-isomorphic to C , as a module over the old variables. Once this is done, the desired conclusion follows inductively: by [21, Lemma 2.4], we can choose any of the markings on a given component L_j to be the new one. Hence, when we do induction on the number of markings on L_j , we can fix any of the U_i variables to be the oldest one, and its action on HFL^+ will be identified with that of U'_j .

To check that the complexes C and C' are quasi-isomorphic, we introduce a filtration \mathcal{F} on C' as follows. For a generator $U_1^{-j_1} \dots U_n^{-j_n} x$ in the domain of (2.4), we let

$$\mathcal{F}(U_1^{-j_1} \dots U_n^{-j_n} x) = -j_1.$$

For a generator $U_1^{-j_1} \dots U_n^{-j_n} x$ in the target of (2.4), we let

$$\mathcal{F}(U_1^{-j_1} \dots U_n^{-j_n} x) = -j_1 - 1.$$

Let $\text{gr}_k^{\mathcal{F}} C'$ be the associated graded of C' with respect to \mathcal{F} . When we pass from C' to the associated graded $\text{gr}_k^{\mathcal{F}} C'$ for $k < 0$, the $U_1 - U_2$ map in the cone (2.4) becomes only U_1 , and is therefore an isomorphism (taking the term $U_1^{-j_1-1} \dots U_n^{-j_n} x$ in the domain to $U_1^{-j_1} \dots U_n^{-j_n} x$ in the target). Therefore, the homology of $\text{gr}_k^{\mathcal{F}} C'$ is zero for all $k < 0$. Further, if we restrict to any fixed Alexander grading, the filtration \mathcal{F} is bounded, allowing us to deduce the acyclicity of a filtered complex from that of its associated graded. We conclude that the subcomplex of C' with $\mathcal{F} < 0$ is acyclic. Hence, C' is quasi-isomorphic to its associated graded in \mathcal{F} -degree zero, which is just $C = \text{gr}_0^{\mathcal{F}} C'$. \square

Specializing Proposition 2.1 to grid diagrams, we see that the homology $GH^+(\mathbb{G})$ of $GC^+(\mathbb{G})$ is $HFL^+(L)$.

Remark 2.2. There is also a minus version of grid homology, $GH^-(\mathbb{G})$, for which we use the complex generated by $[x, j_1, \dots, j_n]$ with $j_i \leq 0$; this is called the *unblocked grid homology* in [32]. In this paper we chose to work with the plus, rather than minus, version of the grid complex because we want to construct the Floer spectrum by adding cells inductively on dimension. It is thus helpful to have a chain complex bounded below in homological grading.

Here are a few other flavors of grid complexes. Let us pick one O marking on each component of the link L . We let \widehat{GC} be the quotient complex of GC^+ generated by $[x, j_1, \dots, j_n]$, where $j_i = 0$ for all the markings O_i that we picked. By adapting the proof of Proposition 2.1 to this setting, we see that the homology of \widehat{GC} is $\widehat{HFL}(L)$, the hat flavor of link Floer homology. If instead we ask for all j_i to be zero (that is, the complex is generated over \mathbb{Z} by $x \in \mathbb{S}$), we have a complex denoted \widetilde{GC} , with homology $\widehat{HFL}(L) \otimes V^{n-\ell}$, where $V = H_{*+1}(S^1)$. Just like GC^+ , the complexes \widehat{GC} and \widetilde{GC} admit Alexander multi-gradings.

Remark 2.3. We followed here the notational conventions from [32], where grid complexes with rectangles not going over the X -markings are denoted by GC (with various decorations). In [22, Section 2.3], these complexes are denoted CL .

Let us also introduce a new grid complex for links, which we denote $GC^{+'}$. The generators are the same as GC^+ , but the differential is

$$\partial([x, j_1, \dots, j_n]) = \sum_y \sum_{\substack{R \in \mathcal{R}(x,y) \\ \mathbb{X}'(R) = (0, \dots, 0)}} s(R) U^{\mathbb{O}(R)} [y, j_1, \dots, j_n],$$

where $\mathbb{X}'(R)$ denotes the subvector of $\mathbb{X}(R)$ consisting of only those entries corresponding to X -markings that are on the same link component as the top-right marking X_n . In other words, we now allow rectangles to pass through the X -markings on all but one of the components of L . The Alexander multi-grading on generators produces an Alexander (multi-)filtration on $GC^{+'}$, one of whose components is a grading.

When L is a knot, we have that $GC^{+'} = GC^+$, but in general, $GC^{+'}$ (equipped with its Alexander filtration) contains more information than GC^+ .

3. THE COMPLEX OF POSITIVE DOMAINS

In this section we will study a different chain complex, CD_* , associated to grid diagrams. Unlike the grid complex, the complex CD_* does not carry any interesting topological information. Rather, it is the first step towards constructing a slightly more complicated complex, CDP_* , which will be defined in Section 4. The obstruction classes that we will encounter while constructing our CW complex will live in CDP_* .

Definition 3.1. Given a grid diagram \mathbb{G} and a sign assignment s , the *complex of positive domains*, $CD_* = CD_*(\mathbb{G})$, is freely generated over \mathbb{Z} by the positive domains (avoiding X_n), with the homological grading being the Maslov index:

$$CD_k = \mathbb{Z}\langle \{(x, y, D) \mid D \in \mathcal{D}^+(x, y), \mu(D) = k\} \rangle.$$

We will usually drop x and y from the notation for a generator of CD_* , and just write it as D .

The differential $\delta: CD_k \rightarrow CD_{k-1}$, on a basis element $D \in \mathcal{D}^+(x, y)$, is given as follows:

$$\delta(D) = \sum_{\substack{(R, E) \in \mathcal{R}(x, w) \times \mathcal{D}^+(w, y) \\ R * E = D}} s(R) E + (-1)^k \sum_{\substack{(E, R) \in \mathcal{D}^+(x, w) \times \mathcal{R}(w, y) \\ E * R = D}} s(R) E.$$

Note that CD_* is independent of the locations of the markings O_1, \dots, O_n and X_1, \dots, X_{n-1} .

Lemma 3.2. *The complex from Definition 3.1 is indeed a chain complex, that is, $\delta^2 = 0$.*

Proof. The proof is essentially the same as the proof that the grid complex is a chain complex.

$$\begin{aligned}
\delta^2(D) &= \sum_{\substack{(R,E) \in \mathcal{R}(x,w) \times \mathcal{D}^+(w,y) \\ R * E = D}} s(R)\delta(E) + (-1)^k \sum_{\substack{(E,R) \in \mathcal{D}^+(x,w) \times \mathcal{R}(w,y) \\ E * R = D}} s(R)\delta(E) \\
&= \sum_{\substack{(R,S,F) \in \mathcal{R}(x,w) \times \mathcal{R}(w,z) \times \mathcal{D}^+(z,y) \\ R * S * F = D}} s(R)s(S)F + (-1)^{k-1} \sum_{\substack{(R,F,S) \in \mathcal{R}(x,w) \times \mathcal{D}^+(w,z) \times \mathcal{R}(z,y) \\ R * F * S = D}} s(R)s(S)F \\
&\quad + (-1)^k \sum_{\substack{(S,F,R) \in \mathcal{R}(x,z) \times \mathcal{D}^+(z,w) \times \mathcal{R}(w,y) \\ S * F * R = D}} s(R)s(S)F - \sum_{\substack{(F,S,R) \in \mathcal{D}^+(x,z) \times \mathcal{R}(z,w) \times \mathcal{R}(w,y) \\ F * S * R = D}} s(R)s(S)F.
\end{aligned}$$

The second and the third terms cancel. For the first term, if the index-2 domain $R * S \in \mathcal{D}^+(x, z)$ is not a horizontal annulus or a vertical annulus, then it has a unique other decomposition which contributes with the opposite sign. Therefore, it only contributes when $x = z$ and $R * S$ is a horizontal or a vertical annulus. Similarly, the fourth term only contributes when $z = y$ and $S * R$ is a horizontal annulus or a vertical annulus. These two terms contribute with opposite signs, and hence cancel. \square

Remark 3.3. A similar complex of positive pairs, denoted CP^* , is defined in [23, Section 4.1], and a certain obstruction class lives in its cohomology. Roughly, the complex CP^* is generated by pairs of generators such that there exists a positive domain between them; in other words, it is generated by positive domains modulo an equivalence relation given by adding or subtracting periodic domains. By contrast, the complex CD_* is generated by positive domains, without dividing by an equivalence relation.

We will spend the rest of this section in showing that the complex CD_* has no interesting homology.

Proposition 3.4. *The complex of positive domains, CD_* , has homology \mathbb{Z} supported in grading 0, generated by the trivial domain c_x for some generator x .*

In order to prove this, we need to define a few objects and establish some of their properties, which we do in the following subsections.

3.1. Decompositions into rectangles. For any domain D , let $A(D) \in \mathbb{N}^{n-1}$ be the vector recording the coefficients of D in the rightmost vertical annulus; that is, the i^{th} component of $A(D)$ is the coefficient of D at the region $H_{(i)} \cap V_{(n)}$. Similarly, let $B(D) \in \mathbb{N}^{n-1}$ be the vector recording the coefficients of D in the topmost horizontal annulus.

Lemma 3.5. *If $D \in \mathcal{D}^+(x, y)$ contains no horizontal (respectively, vertical) annulus—that is, if $D * (-H_i)$ (respectively, $D * (-V_i)$) is not a positive domain for any i —and has $A(D) \neq 0$ (respectively, $B(D) \neq 0$), then there is a decomposition $D = E * R$, with $E \in \mathcal{D}^+(x, z)$ and $R \in \mathcal{R}(z, y)$ and $A(R) \neq 0$ (respectively, $B(R) \neq 0$).*

Proof. We prove the case when D contains no horizontal annulus and $A(D) \neq 0$. The other case is similar.

By [35, Lemma 3.5], there exists at least one decomposition of D into rectangles

$$D = R_1 * R_2 * \cdots * R_n \quad R_1 \in \mathcal{R}(x = w_0, w_1), R_2 \in \mathcal{R}(w_1, w_2), \dots, R_n \in \mathcal{R}(w_{n-1}, w_n = y).$$

Since we assumed that $A(D) \neq 0$, there is some i such that $A(R_i) \neq 0$. Given such a decomposition \mathbf{m} of D , let $\iota(\mathbf{m})$ be the largest such i .

We claim that if $\iota(\mathbf{m}) \neq n$, then there is some other decomposition \mathbf{m}' with $\iota(\mathbf{m}') = \iota(\mathbf{m}) + 1$. If R_1, R_2, \dots, R_n are the rectangles appearing in \mathbf{m} , look at the domain

$$H = R_{\iota(\mathbf{m})} * R_{\iota(\mathbf{m})+1} \in \mathcal{D}^+(w_{\iota(\mathbf{m})-1}, w_{\iota(\mathbf{m})+1}).$$

By assumption $A(R_{\iota(\mathbf{m})}) \neq 0$ and $A(R_{\iota(\mathbf{m})+1}) = 0$. Therefore, H is not a vertical annulus. We have already assumed that D does not contain any horizontal annulus, so H is not a horizontal annulus either. Therefore, H is either a (possibly non-disjoint) union of two rectangles or a hexagon, as pictured in Item (G-14e).

In each case, we claim that if $H = S * T$ is the (unique) other decomposition of H into rectangles with $S \in \mathcal{R}(w_{\iota(\mathbf{m})-1}, w')$ and $T \in \mathcal{R}(w', w_{\iota(\mathbf{m})+1})$, then $A(T) \neq 0$. This is clear in the first case when H is a union of two rectangles. In the second case, depending on the shape of H and how it intersects $V_{(n)}$, the rightmost vertical annulus (shown as a vertical line in the following figure), there are the following eight possibilities; in each case, we have shown a decomposition of $H = S * T$ with $A(T) \neq 0$. (Two of the following configurations—the second and the eighth—cannot actually appear since they do not admit any decomposition $R_{\iota(\mathbf{m})} * R_{\iota(\mathbf{m})+1}$ with $A(R_{\iota(\mathbf{m})+1}) = 0$.)

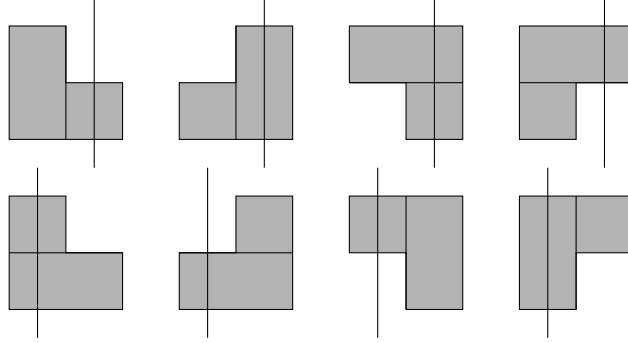

Therefore, if we look at the decomposition \mathbf{m}'

$$D = R_1 * \dots * R_{\iota(\mathbf{m})-1} * S * T * R_{\iota(\mathbf{m})+2} * \dots * R_n,$$

then $\iota(\mathbf{m}') = \iota(\mathbf{m}) + 1$. Consequently, there is some decomposition \mathbf{m} with $\iota(\mathbf{m}) = n$. That is, D has a decomposition $E * R$, with $E \in \mathcal{D}^+(x, z)$ and $R \in \mathcal{R}(z, y)$ with $A(R) \neq 0$. \square

3.2. The partial order on generators. Let us first introduce some notation. In the symmetric group, we will denote by τ_p the adjacent transposition $(p, p + 1)$. Further, in any partially ordered set, when $y \leq x$, we denote by $[y, x]$ the interval consisting of all z with $y \leq z \leq x$.

Next, recall that the standard (strong) *Bruhat order* on the symmetric group is defined as follows. For any permutation σ , a *reduced word* for σ is a minimal decomposition of σ as a product of adjacent transpositions. All reduced words for σ have the same length, which we denote $|\sigma|$. Define $\sigma \leq \tau$ if some (not necessarily consecutive) substring of some (equivalently, every) reduced word for τ is a reduced word for σ .

Now define the following partial order on the set \mathbb{S} of generators:

$$y \leq x \text{ if } \{D \in \mathcal{D}^+(x, y) \mid A(D) = B(D) = 0\} \neq \emptyset.$$

The relation between this partial order and the Bruhat order is explained below.

- (P-1) If x^σ denotes the generator corresponding to the permutation σ of $\{1, 2, \dots, n\}$ from Item (G-7), then $x^\sigma \leq x^\tau$ if and only if $\sigma \geq \tau$, that is, the above order is the *opposite* of the usual Bruhat order on the symmetric group.
- (P-2) The poset has a unique maximum x^{Id} , the generator corresponding to the identity permutation. For any permutation σ , there is a unique (positive) domain $D_\sigma \in \mathcal{D}(x^{\text{Id}}, x^\sigma)$ with $A(D_\sigma) = B(D_\sigma) = 0$ —that is, D_σ avoids the rightmost vertical annulus and the topmost horizontal annulus.
- (P-3) For any reduced word $\sigma_1\sigma_2 \cdots \sigma_k$ for σ , there is a decomposition of $D_\sigma = R_1 * R_2 * \cdots * R_k$ into rectangles so that, for all $1 \leq i \leq k$, R_i is a width-one rectangle supported in the vertical annulus $V_{(j)}$, where σ_i is the adjacent permutation $\tau_j = (j, j+1)$. Therefore, minimal words for σ correspond to decompositions of D_σ into width-one rectangles. In particular, $\mu(D_\sigma) = |\sigma|$.
- (P-4) If $\sigma_1\sigma_2 \cdots \sigma_k$ is a reduced word for σ , then $\sigma_1\sigma_2 \cdots \sigma_{k-1}$ is a reduced word for $\sigma\sigma_k$. To wit, if $R_1 * R_2 * \cdots * R_k$ is the decomposition of D_σ into width-one rectangles corresponding to $\sigma_1\sigma_2 \cdots \sigma_k$, then $R_1 * R_2 * \cdots * R_{k-1}$ is a decomposition of $D_{\sigma\sigma_k}$ into width-one rectangles.
- (P-5) If the coordinate of x^σ on β_p lies to the bottom-left of the coordinate of x^σ on β_{p+1} for some $1 \leq p < n$, then for any reduced word $\sigma_1\sigma_2 \cdots \sigma_k$ of σ , $\sigma_1\sigma_2 \cdots \sigma_k\tau_p$ is a reduced word for $\sigma\tau_p$. The proof is similar to that in Item (P-4). There is a rectangle $R \in \mathcal{R}(x^\sigma, x^{\sigma\tau_p})$ with width one, supported in $V_{(p)}$ and avoiding $H_{(n)}$. If $D_\sigma = R_1 * R_2 * \cdots * R_k$ is the decomposition into width-one rectangles corresponding to $\sigma_1\sigma_2 \cdots \sigma_k$, then $D_{\sigma\tau_p} = R_1 * R_2 * \cdots * R_k * R$ is a decomposition into width-one rectangles corresponding to $\sigma_1\sigma_2 \cdots \sigma_k\tau_p$.
- (P-6) For any $1 \leq p < n$, the permutation σ has a reduced word ending in the transposition τ_p if and only if the coordinate of x^σ on β_p lies to the top-left of the coordinate of x^σ on β_{p+1} .

One direction is clear. If σ has a reduced word ending in τ_p , then D_σ has a decomposition $E * R$, with $E \in \mathcal{D}^+(x^{\text{Id}}, y)$ and $R \in \mathcal{R}(y, x^\sigma)$ being a width-one rectangle supported in the vertical annulus $V_{(p)}$ (and avoiding the top horizontal annulus $H_{(n)}$), and hence the coordinate of x^σ on β_p lies to the top-left of the coordinate of x^σ on β_{p+1} . The proof for the other direction is similar to Lemma 3.5. Let $\mathbf{w} = \sigma_1\sigma_2 \cdots \sigma_k$ be a reduced word for σ . By Item (P-4), $\eta_i = \sigma_1\sigma_2 \cdots \sigma_i$ is a reduced word. Call a permutation to be *inverted* if its coordinate on β_p lies to the top-left of its coordinate on β_{p+1} . By assumption $\eta_k = \sigma$ is inverted, while $\eta_0 = x^{\text{Id}}$ is not. Let $\iota(\mathbf{w})$ be the smallest i , so that $\eta_i, \eta_{i+1}, \dots, \eta_k$ are all inverted. Since $\eta_{\iota(\mathbf{w})-1}$ is not inverted, but $\eta_{\iota(\mathbf{w})} = \eta_{\iota(\mathbf{w})-1}\sigma_{\iota(\mathbf{w})}$ is, we must have $\sigma_{\iota(\mathbf{w})} = \tau_p$.

If $\iota(\mathbf{w}) \neq k$, we will find a new reduced word \mathbf{w}' for σ with $\iota(\mathbf{w}') = \iota(\mathbf{w}) + 1$. Continuing, we will eventually find a word with $\iota = k$, and we will be done.

If $\sigma_{\iota(\mathbf{w})+1}$ is a transposition that is far from τ_p , then switching $\sigma_{\iota(\mathbf{w})} = \tau_p$ and $\sigma_{\iota(\mathbf{w})+1}$ works; that is, $\mathbf{w}' = \sigma_1\sigma_2 \cdots \sigma_{\iota(\mathbf{w})-1}\sigma_{\iota(\mathbf{w})+1}\tau_p\sigma_{\iota(\mathbf{w})+2} \cdots \sigma_k$ has $\iota(\mathbf{w}') = \iota(\mathbf{w}) + 1$. Now let us do the case $\sigma_{\iota(\mathbf{w})+1} = \tau_{p-1}$ (the case τ_{p+1} is similar). Note that $\tau_p\tau_{p-1} = (p-1, p+1) \cdot \tau_p$, where $(p-1, p+1)$ denotes the non-adjacent transposition. Therefore, $\eta_{\iota(\mathbf{w})+1} = \sigma'\tau_p$, where $\sigma' = \sigma_1\sigma_2 \cdots \sigma_{\iota(\mathbf{w})-1} \cdot (p-1, p+1)$. Since we have assumed that $\eta_{\iota(\mathbf{w})+1}$ is also inverted, the index-two domain corresponding to $\tau_p\tau_{p-1} = (p-1, p+1) \cdot \tau_p$ looks like the third hexagon from Item (G-14e). Therefore, σ' is not inverted, and therefore, for any reduced word $\sigma'_1\sigma'_2 \cdots \sigma'_{\iota(\mathbf{w})}$ for σ' , we have that $\sigma'_1\sigma'_2 \cdots \sigma'_{\iota(\mathbf{w})}\tau_p$ is a reduced word for $\eta_{\iota(\mathbf{w})+1}$ (by Item P-5), and hence $\mathbf{w}' = \sigma'_1\sigma'_2 \cdots \sigma'_{\iota(\mathbf{w})}\tau_p\sigma_{\iota(\mathbf{w})+2} \cdots \sigma_k$ has $\iota(\mathbf{w}') = \iota(\mathbf{w}) + 1$.

- (P-7) If σ does not have a reduced word ending in the transposition τ_p , then for any reduced word $\sigma_1\sigma_2 \cdots \sigma_k$ of σ , we have that $\sigma_1\sigma_2 \cdots \sigma_k\tau_p$ is a reduced word for $\sigma\tau_p$. This follows immediately from Items (P-5) and (P-6).

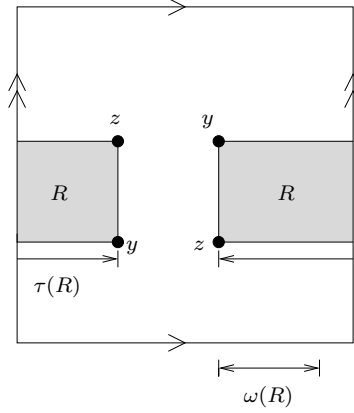
FIGURE 2. The shaded rectangle R is an A -witness.

3.3. Plausible triples. Given two partially ordered sets S_1, \dots, S_m , the *product partial order* on $S_1 \times \dots \times S_m$ is given by

$$(s_1, \dots, s_m) \leq (s'_1, \dots, s'_m) \iff (s_i \leq s'_i \text{ for all } i).$$

We will give \mathbb{N}^{n-1} the product partial order coming from its factors.

In the proof of Proposition 3.4 that will be given in Section 3.4, we will filter positive domains according to the vectors $A(D), B(D)$ that capture their multiplicities on the rightmost column and topmost row. In the process, given a triple (a, b, y) , with $y \in \mathbb{S}$ and $(a, b) \in \mathbb{N}^{n-1} \times \mathbb{N}^{n-1}$, we will be interested in the set of generators

$$G^{a,b,y} = \{x \in \mathbb{S} \mid \exists D \in \mathcal{D}^+(x, y), A(D) = a, B(D) = b\}.$$

This is an upward closed subset: that is, if $x \in G^{a,b,y}$ and $x \leq x'$, then $x' \in G^{a,b,y}$. Therefore, $G^{a,b,y}$ always contains x^{Id} . Moreover, if $D \in \mathcal{D}^+(x, y)$ with $A(D) \leq a$ and $B(D) \leq b$, then $x \in G^{a,b,y}$, since there exists a (unique) periodic domain $E \in \mathcal{D}^+$ with $(A(E), B(E)) = (a - A(D), b - B(D))$, and therefore, $D * E \in \mathcal{D}^+(x, y)$ satisfies the required condition. That is, $G^{a,b,y}$ has an alternate description

$$G^{a,b,y} = \{x \mid \exists D \in \mathcal{D}^+(x, y), A(D) \leq a, B(D) \leq b\}.$$

In particular, since $c_y \in \mathcal{D}^+(y, y)$, the set $G^{a,b,y}$ contains y , and hence all z with $z \geq y$.

We would like to understand in what cases $G^{a,b,y}$ contains more elements than just those in the interval $[y, x^{\text{Id}}]$. An example is shown in Figure 2, where $z \leq y$ but the rectangle R with $A(R) = a > 0$ and $B(R) = 0$ makes it so that $z \in G^{a,0,y}$.

It turns out that the specific condition we need is *plausibility*, as defined below. Consider triples (a, b, y) with y a generator and $(a, b) \in \mathbb{N}^{n-1} \times \mathbb{N}^{n-1}$. Call such a triple *A -plausible* (respectively, *B -plausible*) if there exist z and $R \in \mathcal{R}(z, y)$ with $0 < A(R) \leq a$ (respectively, $0 < B(R) \leq b$); call such rectangles *A -witnesses* (respectively, *B -witnesses*). Assign to any such witness R a pair $(\omega(R), \tau(R)) \in \mathbb{N}^2$, where $\omega(R)$ is number of vertical annuli to the left of $V_{(n)}$ (respectively, horizontal annuli below $H_{(n)}$) that R intersects, and $\tau(R)$ is the horizontal width (respectively, vertical height) of R . See again Figure 2.

Lemma 3.6. *If (a, b, y) is neither A-plausible nor B-plausible, and $D \in \mathcal{D}^+(x, y)$ with $(A(D), B(D)) = (a, b)$, then $x \geq y$.*

Proof. Look at decompositions $D = E * F$ where $E \in \mathcal{P}^+$ and $F \in \mathcal{D}^+(x, y)$, and consider the one that maximizes the Maslov index of E . Then F does not contain any vertical annulus or any horizontal annulus.

By Lemma 3.5, if $(A(F), B(F)) \neq (0, 0)$, then F has a decomposition $G * R$, with $G \in \mathcal{D}^+(x, z)$ and $R \in \mathcal{R}(z, y)$ with $(A(R), B(R)) \neq (0, 0)$. Then R is a witness, which contradicts the hypothesis. Therefore, we must have $(A(F), B(F)) = (0, 0)$. Then $x \geq y$ due to the domain F , and we are done. \square

Lemma 3.7. *If (a, b, y) is A-plausible, and $D \in \mathcal{D}^+(x, y)$ with $(A(D), B(D)) = (a, b)$, then there exists an A-witness $R \in \mathcal{R}(z, y)$ and $E \in \mathcal{D}^+(x, z)$ with $E * R = D$. We may choose R to be one that minimizes ω among all A-witnesses. In fact, we may choose R to be the (unique) A-witness R_0 that minimizes the pair (ω, τ) , ordered lexicographically, among all A-witnesses.*

Analogous statements hold if (a, b, y) is B-plausible.

Proof. Let us only consider the case for A-plausible. The other case is similar. We prove this by induction on the Maslov index of D . There are three statements in the problem, and for clarity, we write them out. Each statement is weaker than the next.

- (P_1^n) If (a, b, y) is A-plausible, and $D \in \mathcal{D}^+(x, y)$ with $\mu(D) = n$ and $(A(D), B(D)) = (a, b)$, then there exists an A-witness $R \in \mathcal{R}(z, y)$ and $E \in \mathcal{D}^+(x, z)$ with $E * R = D$.
- (P_2^n) If (a, b, y) is A-plausible, and $D \in \mathcal{D}^+(x, y)$ with $\mu(D) = n$ and $(A(D), B(D)) = (a, b)$, then there exists an A-witness $R \in \mathcal{R}(z, y)$ and $E \in \mathcal{D}^+(x, z)$ with $E * R = D$, and R minimizes ω among all A-witnesses.
- (P_3^n) If (a, b, y) is A-plausible, and $D \in \mathcal{D}^+(x, y)$ with $\mu(D) = n$ and $(A(D), B(D)) = (a, b)$, then there exists an A-witness $R \in \mathcal{R}(z, y)$ and $E \in \mathcal{D}^+(x, z)$ with $E * R = D$, and R minimizes (ω, τ) among all A-witnesses.

The base case for the induction is either vacuous or trivial, depending on whether one starts at $n = 0$ or $n = 1$. We will do induction on n , and at each step, we will first get (P_1^n) , then (P_2^n) , and then (P_3^n) . For this, we will make use of the following implications.

(Ind-1) $(P_1^n) \wedge (P_2^{n-1}) \Rightarrow (P_2^n)$. Consider the decomposition $D = E * R$ as provided by (P_1^n) , with $R \in \mathcal{R}(z, y)$. Consider an A-witness S that minimizes ω . If $\omega(R) = \omega(S)$, we are done. Otherwise $\omega(S) < \omega(R)$; therefore, the top-left corner of S lies outside R , and the configuration of S (shaded), R (striped), and y -coordinates (dots) looks like one of the follows (the vertical column $V_{(n)}$ is once again shown as a vertical line).

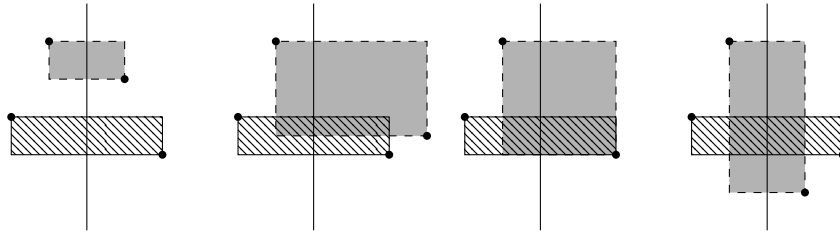

In each case, the domain $E \in \mathcal{D}^+(x, z)$ is A-plausible and the following A-witness (shaded) has minimum ω , which equals $\omega(S)$.

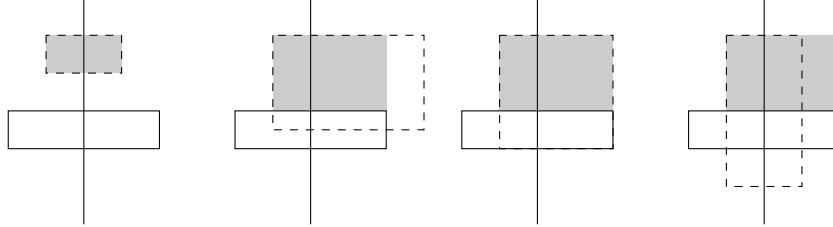

Therefore, by (P_2^{n-1}) , we have a decomposition $E = F * T$, with $F \in \mathcal{D}^+(x, w)$ and $T \in \mathcal{R}(w, z)$ with $\omega(T) = \omega(S)$. Therefore, the Maslov index 2 domain $H = T * R \in \mathcal{D}^+(w, y)$ looks like one of the following (the decomposition $T * R$ and the y -coordinates are also shown).

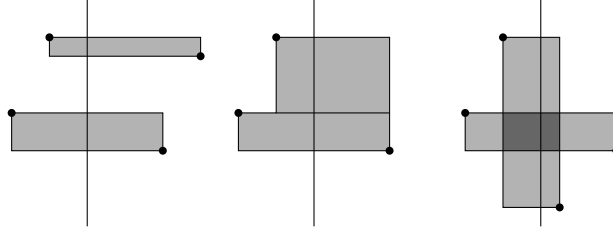

In each case, the other decomposition $H = T' * R'$ satisfies $\omega(R') = \omega(S)$. Therefore, we have a decomposition $D = (F * T') * R'$, with R' an A-witness minimizing ω .

(Ind-2) $(P_2^n) \wedge (P_3^{n-1}) \Rightarrow (P_3^n)$. The proof is similar to (but easier than) the previous proof. Consider the decomposition $D = E * R$ as provided by (P_2^n) , with $R \in \mathcal{R}(z, y)$ minimizing ω . Consider an A-witness S that minimizes (ω, τ) , ordered lexicographically. We must have $\omega(R) = \omega(S)$. If in addition, $\tau(R) = \tau(S)$, we are done. Otherwise $\tau(S) < \tau(R)$; therefore, the configuration of S (shaded), R (striped), and y -coordinates (dots) looks as follows.

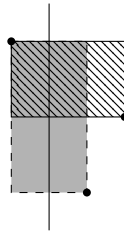

Therefore, the domain $E \in \mathcal{D}^+(x, z)$ is A-plausible and the following A-witness T (shaded) has minimum (ω, τ) , which equals $(\omega(S), \tau(S))$.



By (P_3^{n-1}) , we have a decomposition $E = F * T$ with $F \in \mathcal{D}^+(x, w)$ and $T \in \mathcal{R}(w, z)$. The Maslov index 2-domain $H = T * R \in \mathcal{D}^+(w, y)$ is a hexagon, and the other decomposition $H = T' * R'$ satisfies $(\omega(R'), \tau(R')) = (\omega(S), \tau(S))$. Therefore, we have a decomposition $D = (F * T') * R'$, with R' the unique A-witness minimizing (ω, τ) .

(Ind-3) $(P_1^{n-1}) \wedge (P_3^n) \Rightarrow (P_1^{n+1})$. Let D be the given domain with $\mu(D) = n+1$, and consider the A-witness R for D which minimizes (ω, τ) . Since R minimizes (ω, τ) , none of the y -coordinates can lie in the interior of R .

If D does not contain any horizontal annuli, we are done by Lemma 3.5. Therefore, assume D contains some horizontal annulus H . If H is disjoint from the interior of R , then $D * (-H)$ is a domain with $\mu = n - 1$, which is still A-plausible since it still contains the A-witness R . Therefore, by (P_1^{n-1}) , it admits a decomposition $E * T$ with $E \in \mathcal{D}^+(x, w), T \in \mathcal{R}(w, y)$ with $A(T) \neq 0$; consequently, D has a decomposition $(E * H) * T$ and we are done.

Therefore, we may assume that D contains some horizontal annulus H that intersects R . Let $H = S * T$ with $S \in \mathcal{R}(y, w), T \in \mathcal{R}(w, y)$ be the unique decomposition of H into rectangles. Exactly one of $A(S)$ and $A(T)$ is non-zero. If $A(T) \neq 0$, we are done, since D then has a decomposition $(D * (-T)) * T$. So we may assume $A(S) \neq 0$ and $A(T) = 0$.

Therefore, the configuration of the A-witness R (shaded), the horizontal annulus H (striped), and the y -coordinates (dots) looks as follows.

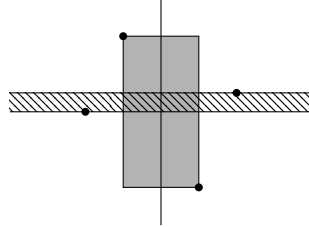

Therefore, the domain $D * (-T) \in \mathcal{D}^+(x, w)$ is A-plausible, with R still being the A-witness that minimizes (ω, τ) . By (P_3^n) , $D * (-T)$ contains the rectangle R , and therefore, D contains R as well. \square

3.4. Proof of acyclicity. Given a triple (a, b, y) , with y a generator and $(a, b) \in \mathbb{N}^{n-1} \times \mathbb{N}^{n-1}$, in Section 3.3 we defined the following set of generators

$$\begin{aligned} G^{a,b,y} &= \{x \in \mathbb{S} \mid \exists D \in \mathcal{D}^+(x, y), A(D) = a, B(D) = b\} \\ &= \{x \in \mathbb{S} \mid \exists D \in \mathcal{D}^+(x, y), A(D) \leq a, B(D) \leq b\}. \end{aligned}$$

This is an upward closed subset that contains y .

Lemma 3.8. *The set $G^{a,b,y}$ has a unique minimum $m^{a,b,y}$, so that $G^{a,b,y}$ is the interval $[m^{a,b,y}, x^{\text{Id}}]$. Furthermore, $m^{a,b,y}$ equals x^{Id} if and only if $a = b = 0$ and $y = x^{\text{Id}}$.*

Proof. We prove this by induction on (a, b) , viewed as an element of the poset \mathbb{N}^{2n-2} under the product partial order. For the base case, we have $G^{0,0,y} = [y, x^{\text{Id}}]$, and so it has a unique minimum $m^{0,0,y} := y$.

Now consider the case $(a, b) \neq (0, 0)$. For the first part, if (a, b, y) is neither A-plausible nor B-plausible, then it follows from Lemma 3.6 that $m^{a,b,y}$ exists and equals y . On the other hand, if (a, b, y) is A-plausible (respectively, B-plausible), and $R_0 \in \mathcal{R}(z, y)$ is the unique A-witness (respectively B-witness) that minimizes (ω, τ) , then it follows from Lemma 3.7 (using induction on (a, b)) that $m^{a,b,y}$ exists and equals $m^{a-A(R_0),b,z}$ (respectively, $m^{a,b-B(R_0),z}$).

For $(a, b) \neq (0, 0)$, the second part follows from the first part. Let $D \in \mathcal{D}^+(y, y)$ with $(A(D), B(D)) = (a, b)$, and consider some decomposition of D into rectangles:

$$D = R_1 * R_2 * \cdots * R_n \quad R_1 \in \mathcal{R}(y = w_0, w_1), R_2 \in \mathcal{R}(w_1, w_2), \dots, R_n \in \mathcal{R}(w_{n-1}, w_n = y).$$

Clearly, $w_i \in G^{a,b,y}$ for all i because of the domain $R_{i+1} * \cdots * R_n \in \mathcal{D}^+(w_i, y)$. Since $(a, b) \neq (0, 0)$, D is non-trivial, and therefore, there is at least one rectangle, and consequently, the set $\{w_0, \dots, w_n\}$ contains at least two elements. Therefore, $G^{a,b,y}$ is not the one-element set $\{x^{\text{Id}}\}$. \square

We are now ready to prove Proposition 3.4.

Proof of Proposition 3.4. The idea of the proof is to construct a sequence of filtrations on the chain complex, and to prove that various associated graded complexes are acyclic.

For domain $D \in CD_*$, let $(A(D), B(D))$ be its filtration grading in the product partial order on \mathbb{N}^{2n-2} . It is clear that the differential either preserves (A, B) or lowers it. For $(a, b) \in \mathbb{N}^{n-1} \times \mathbb{N}^{n-1}$, let $CD_*^{a,b}$ be the associated graded complex in filtration grading (a, b) . We will prove that $CD_*^{a,b}$ is acyclic if $(a, b) \neq (0, 0)$, and $CD_*^{0,0}$ has homology \mathbb{Z} generated by $c_{x^{\text{Id}}}$.

Now put a new filtration grading on $CD_*^{a,b}$ as follows. For any domain $D \in \mathcal{D}^+(x, y)$ with $(A(D), B(D)) = (a, b)$, define its filtration grading to be y , viewed as an element of the poset from Section 3.2. The differential δ on the associated graded complex $CD_*^{a,b}$ either preserves y or increases it. Now let $CD_*^{a,b,y}$ be associated graded complex consisting of only those domains that end at y . Now, it is enough to show that $CD_*^{a,b,y}$ is acyclic, unless $a = b = 0$ and $y = x^{\text{Id}}$. When $a = b = 0$ and $y = x^{\text{Id}}$, the homology is clearly \mathbb{Z} , generated by the trivial domain $c_{x^{\text{Id}}}$.

The complex $CD_*^{a,b,y}$ is generated by domains $D \in \mathcal{D}^+(x, y)$ with $(A(D), B(D)) = (a, b)$. Note, if there is such a domain, then $x \in G^{a,b,y}$ by definition, and conversely, for any $x \in G^{a,b,y}$, there is a unique such positive domain D . Note that $G^{a,b,y} = [m^{a,b,y}, x^{\text{Id}}]$ by Lemma 3.8. Therefore, the complex $CD_*^{a,b,y}$ is isomorphic to the following complex (which resembles the grid complex from Section 2.2). It is generated by the elements of $[m^{a,b,y}, x^{\text{Id}}]$, and the differential on a generator is given by

$$\delta(x) = \sum_{\substack{m^{a,b,y} \leq z < x \\ R \in \mathcal{R}(x, z) \\ A(R) = B(R) = 0}} s(R)z.$$

If in the above formula we have $m^{a,b,y} = x^\sigma$, $x = x^\theta$ and $z = x^\eta$, for some permutations σ, θ, η , then the condition

$$m^{a,b,y} \leq z < x \text{ and } \exists R \in \mathcal{R}(x, z) \text{ with } A(R) = B(R) = 0$$

is equivalent to

$$\sigma \geq \eta > \theta \text{ and } |\eta| = |\theta| + 1 \text{ and } R = (-D_\theta) * D_\eta.$$

Therefore, the complex $CD_*^{a,b,y}$ is isomorphic to the following. It is generated by permutations in $[\text{Id}, \sigma]$, and the differential on a generator is given by

$$\delta(\theta) = \sum_{\substack{\sigma \geq \eta > \theta \\ |\eta| = |\theta| + 1}} s((-D_\theta) * D_\eta) \eta.$$

Now fix some reduced word $\sigma_1 \sigma_2 \cdots \sigma_k$ for σ . If $(a, b) \neq (0, 0)$, then $m^{a,b,y} \neq x^{\text{Id}}$ (once again, using Lemma 3.8), and hence $k > 0$. Let σ_k be the transposition $\tau_p = (p, p+1)$. Define a grading on permutations by declaring its value on θ to be $|\theta| - 1$ if θ has a reduced word ending in τ_p , and $|\theta|$ otherwise. Since the differential increases the length $|\cdot|$ by one, this defines a filtration grading on above complex.

We claim that the associated graded complex is a direct sum of two-generator acyclic complexes, and hence is acyclic. If η and θ are in the same filtration grading and η appears in $\delta(\theta)$, then the filtration grading must be $|\eta| - 1 = |\theta|$. Therefore, η has a reduced word, say \mathfrak{w} of length ℓ , ending in τ_p ; since $\theta < \eta$ with $|\theta| = |\eta| - 1$, θ has a reduced word \mathfrak{w}' of length $\ell - 1$ which is a sub-word of \mathfrak{w} . But since θ does not have any reduced word ending in τ_p , \mathfrak{w}' must be obtained from \mathfrak{w} by deleting τ_p from the end. That is, $\eta = \theta \tau_p$, and there is a (width-one) rectangle from x^θ to x^η .

On the other hand, if θ does not have a reduced word ending in τ_p , and $\theta \leq \sigma$, consider some reduced word \mathfrak{w} for θ that is a sub-word of $\sigma_1 \sigma_2 \cdots \sigma_k$, and hence a sub-word of $\sigma_1 \sigma_2 \cdots \sigma_{k-1}$. By Item (P-7), $\mathfrak{w} \tau_p$ is a reduced word for $\theta \tau_p$; since it is a sub-word of $\sigma_1 \sigma_2 \cdots \sigma_k$, $\theta \tau_p \leq \sigma$. Similarly, if θ has a reduced word ending in τ_p , by Item (P-4), removing τ_p from the end produces a reduced word for $\theta \tau_p$, and hence $\theta \tau_p < \theta$; so if $\theta \leq \sigma$, $\theta \tau_p \leq \sigma$ as well. In either case, if $\theta \leq \sigma$, $\theta \tau_p \leq \sigma$. Therefore, θ and $\theta \tau_p$ span an acyclic summand of the associated graded complex. Therefore, the associated graded complex is acyclic, and this concludes the proof. \square

4. THE COMPLEX OF POSITIVE DOMAINS WITH PARTITIONS

4.1. Ordered partitions. For $N \geq 0$, denote by $\text{Part}(N)$ the set of ordered partitions of N as sums of positive integers. Thus, an element $\lambda \in \text{Part}(N)$ is of the form

$$\lambda = (\lambda_1, \dots, \lambda_m), \quad m \geq 0, \quad \sum \lambda_j = N.$$

We denote by $\ell(\lambda) = m$ the length of the partition.

The number of ordered partitions of N is 2^{N-1} for $N \geq 1$, and 1 for $N = 0$. Indeed, to each $\lambda \in \text{Part}(N)$ we can uniquely associate an $(N-1)$ -tuple

$$(4.1) \quad \epsilon(\lambda) = (\epsilon_1(\lambda), \dots, \epsilon_{N-1}(\lambda)) \in \{0, 1\}^{N-1}$$

as follows: Consider N objects (represented by bullets) in a row, with the first λ_1 in the first partition class, the next λ_2 in the second class, etc. We place a 0 between objects in the same class, and a 1 between objects in a different class. For example, the partition $2 + 3 + 1$ corresponds to the string 01001:

$$(\bullet \ 0 \ \bullet) \ 1 \ (\bullet \ 0 \ \bullet \ 0 \ \bullet) \ 1 \ (\bullet)$$

For $\lambda = (\lambda_1, \dots, \lambda_m) \in \text{Part}(N)$ and $\lambda' = (\lambda'_1, \dots, \lambda'_p) \in \text{Part}(N')$, we define their *concatenation*

$$(4.2) \quad \lambda * \lambda' = (\lambda_1, \dots, \lambda_m, \lambda'_1, \dots, \lambda'_p) \in \text{Part}(N + N').$$

For $\lambda, \lambda' \in \text{Part}(N)$, we write $\lambda \leq \lambda'$ if λ is a *refinement* of $\lambda' = (\lambda'_1, \dots, \lambda'_m)$, that is, if there are partitions of each λ'_j such that their concatenation gives λ . We have

$$\lambda \leq \lambda' \iff \epsilon(\lambda) \geq \epsilon(\lambda'),$$

where on the right hand side we used the product partial order on $\{0, 1\}^{N-1}$.

More generally, if $\lambda \in \text{Part}(N)$ and $\lambda' = (\lambda'_1, \dots, \lambda'_m) \in \text{Part}(N')$ for $N' \geq N$, we write $\lambda \leq \lambda'$ if λ is a refinement of a partition $\eta = (\eta_1, \dots, \eta_m) \in \text{Part}(N)$, such that $\eta_j \leq \lambda'_j$ for all $j = 1, \dots, m$.

Definition 4.1. If $\lambda, \lambda' \in \text{Part}(N)$ are such that $\lambda \leq \lambda'$, we say that λ is *finer* than λ' , and λ' is *coarser* than λ . If $\lambda \leq \lambda'$ and $\ell(\lambda') = \ell(\lambda) - 1$, we say that λ' is an *elementary coarsening* of λ . We denote by $\text{EC}(\lambda)$ the set of elementary coarsenings of λ .

If $\lambda' = (\lambda'_1, \dots, \lambda'_m) \in \text{EC}(\lambda)$, then there is an index k and $\lambda_k^1, \lambda_k^2 \geq 1$ such that

$$\lambda = (\lambda'_1, \dots, \lambda'_{k-1}, \lambda_k^1, \lambda_k^2, \lambda'_{k+1}, \dots, \lambda'_m), \quad \lambda_k^1 + \lambda_k^2 = \lambda'_k.$$

We define the *sign* of the elementary coarsening to be

$$s(\lambda, \lambda') = (-1)^k.$$

Alternatively, note that there is a unique $i \in \{1, \dots, N-1\}$ such that $\epsilon_i(\lambda) = 1$ and $\epsilon_i(\lambda') = 0$; and for all $j \neq i$, we have $\epsilon_j(\lambda) = \epsilon_j(\lambda')$. We have

$$s(\lambda, \lambda') = (-1)^{\epsilon_1(\lambda) + \dots + \epsilon_{j-1}(\lambda) + 1}.$$

Definition 4.2. If $\lambda = (\lambda_1, \dots, \lambda_m) \in \text{Part}(N)$, a *unit enlargement* of λ is a partition $\lambda' \in \text{Part}(N+1)$ of the form

$$\lambda' = (\lambda_1, \dots, \lambda_{k-1}, 1, \lambda_k, \dots, \lambda_m)$$

for some $k \in \{1, \dots, m\}$. The sign of the unit enlargement is defined to be

$$s(\lambda, \lambda') = (-1)^{k-1}.$$

The set of unit enlargements of λ is denoted $\text{UE}(\lambda)$.

Definition 4.3. If $\lambda = (\lambda_1, \dots, \lambda_m) \in \text{Part}(N)$, the *initial reduction* of λ is the partition

$$\lambda^- := (\lambda_2, \dots, \lambda_m) \in \text{Part}(N - \lambda_1).$$

The *final reduction* of λ is the partition

$$\lambda^+ := (\lambda_1, \dots, \lambda_{m-1}) \in \text{Part}(N - \lambda_m).$$

The reductions are not well-defined when $N = 0$ (and λ is the empty partition). We define the sets

$$\text{IR}(\lambda) := \begin{cases} \{\lambda^-\} & \text{if } N > 0, \\ \emptyset & \text{if } N = 0; \end{cases} \quad \text{and} \quad \text{FR}(\lambda) := \begin{cases} \{\lambda^+\} & \text{if } N > 0, \\ \emptyset & \text{if } N = 0. \end{cases}$$

4.2. The new complex. We now define a slightly more complicated complex, $CDP_* = CDP_*(\mathbb{G})$, associated to a grid diagram \mathbb{G} and a sign assignment s . We will call it the *complex of positive domains with partitions*. As an Abelian group, CDP_* is feely generated by triples

$$(D, \vec{N}, \vec{\lambda}) \quad \text{with } \vec{N} = (N_1, \dots, N_n) \in \mathbb{N}^n, \vec{\lambda} = (\lambda_1, \dots, \lambda_n), \lambda_j = (\lambda_{j,1}, \dots, \lambda_{j,m_j}) \in \text{Part}(N_j).$$

The intuition is that a triple of this type will be associated to a configuration consisting of a pseudo-holomorphic strip in $\text{Sym}^n(T^2)$ (with domain D) and several disk bubbles. There are N_j bubbles going through the marking O_j , and they can have as domain either the row H_j or the column V_j . These N_j bubbles are partitioned according to λ_j , so that the bubbles in the same partition class

are attached to the strip at the same height on its boundary. Further, the ordering of the partition classes corresponds to the ordering of the heights.

For future reference, set

$$\begin{aligned} |\vec{N}| &= N_1 + \cdots + N_n \\ |\vec{\lambda}| &= \ell(\lambda_1) + \cdots + \ell(\lambda_n). \end{aligned}$$

The grading on CDP_* is given by

$$\text{gr}(D, \vec{N}, \vec{\lambda}) = \mu(D) + |\ell(\vec{\lambda})|$$

The differential $\delta : CDP_k \rightarrow CDP_{k-1}$ has four kinds of terms:

- **Type I** terms, given by taking out a rectangle from the domain, just as in the complex CD_* ;
- **Type II** terms, given by boundary degenerations, i.e., taking out a row H_j or a column V_j from the domain D , and at the same time increasing N_j by one, and changing λ_j by a unit enlargement;
- **Type III** terms, given by an elementary coarsening of one of the partitions λ_j . This corresponds to two bubbles reaching the same height.
- **Type IV** terms, given by taking the initial or final reduction of one of the partitions λ_j . This corresponds to removing a boundary degeneration, in the limit as its height goes to $-\infty$ (for initial reductions) or $+\infty$ (for final reductions).

Precisely, we can write

$$(4.3) \quad \delta = \delta^{\text{I}} + \delta^{\text{II}} + \delta^{\text{III}} + \delta^{\text{IV}}$$

such that, for $D \in \mathcal{D}^+(x, y)$, we have

$$(4.4) \quad \delta^{\text{I}}(D, \vec{N}, \vec{\lambda}) = \sum_{\substack{(R, E) \in \mathcal{R}(x, w) \times \mathcal{D}^+(w, y) \\ R * E = D}} s(R)(E, \vec{N}, \vec{\lambda}) + (-1)^{\mu(D)} \sum_{\substack{(E, R) \in \mathcal{D}^+(x, w) \times \mathcal{R}(w, y) \\ E * R = D}} s(R)(E, \vec{N}, \vec{\lambda}),$$

$$(4.5) \quad \delta^{\text{II}}(D, \vec{N}, \vec{\lambda}) = (-1)^{\mu(D)} \sum_{j=1}^n (-1)^{\ell(\lambda_1) + \cdots + \ell(\lambda_{j-1})} \sum_{\substack{E \in \mathcal{D}^+(x, y) \\ E + H_j = D \\ \text{or} \\ E + V_j = D}} \sum_{\lambda'_j \in \text{UE}(\lambda_j)} s(\lambda_j, \lambda'_j)(E, \vec{N} + \vec{e}_j, \vec{\lambda}'),$$

$$(4.6) \quad \delta^{\text{III}}(D, \vec{N}, \vec{\lambda}) = (-1)^{\mu(D)} \sum_{j=1}^n (-1)^{\ell(\lambda_1) + \cdots + \ell(\lambda_{j-1})} \sum_{\lambda'_j \in \text{EC}(\lambda_j)} s(\lambda_j, \lambda'_j)(D, \vec{N}, \vec{\lambda}').$$

$$(4.7) \quad \delta^{\text{IV}}(D, \vec{N}, \vec{\lambda}) = (-1)^{\mu(D)} \sum_{j=1}^n (-1)^{\ell(\lambda_1) + \cdots + \ell(\lambda_{j-1})} \sum_{\lambda'_j \in \text{IR}(\lambda_j)} (D, \vec{N} - \lambda_{j,1} \vec{e}_j, \vec{\lambda}') \\ + (-1)^{\mu(D)} \sum_{j=1}^n (-1)^{\ell(\lambda_1) + \cdots + \ell(\lambda_j)} \sum_{\lambda'_j \in \text{FR}(\lambda_j)} (D, \vec{N} - \lambda_{j,m_j} \vec{e}_j, \vec{\lambda}').$$

In the expressions (4.5), (4.6) and (4.7) we used the notation

$$\vec{\lambda}' = (\lambda_1, \dots, \lambda_{j-1}, \lambda'_j, \lambda_{j+1}, \dots, \lambda_n).$$

Lemma 4.4. *The complex CDP_* defined above is indeed a chain complex, i.e., $\delta^2 = 0$.*

Proof. We claim that each of δ^I , δ^{II} and δ^{III} squares to zero, and that any two of these differentials anti-commute with each other. We also claim that δ^{IV} anti-commutes with δ^I and δ^{II} , and that we have

$$(4.8) \quad (\delta^{IV})^2 + \delta^{III}\delta^{IV} + \delta^{IV}\delta^{III} = 0.$$

Together, these claims will show that $\delta^2 = 0$.

Let us start with the differential δ^I . This gave the complex CD_* , and fact that $(\delta^I)^2 = 0$ was established in Lemma 3.2.

To see that $(\delta^{II})^2 = 0$, note that in the expression $(\delta^{II})^2(D, \vec{N}, \vec{\lambda})$ we encounter terms of two kinds. Some are of the form

$$(4.9) \quad \pm(E, \vec{N} + \vec{e}_i + \vec{e}_j, \vec{\lambda}''), \quad i > j$$

such that E is obtained from D by deleting a (vertical or horizontal) annulus going through O_i and another annulus through O_j . Also, $\vec{\lambda}'' = (\lambda''_1, \dots, \lambda''_n)$ is obtained from $\vec{\lambda} = (\lambda_1, \dots, \lambda_n)$ by doing unit enlargements to λ_i and λ_j . The terms of the form (4.9) come in pairs, corresponding to the order in which we delete the two annuli (and do the respective unit enlargements). The presence of the sign $(-1)^{\ell(\lambda_1) + \dots + \ell(\lambda_{j-1})}$ guarantees that these terms cancel in pairs.

Second, we also have terms of the form

$$\pm(E, \vec{N} + 2\vec{e}_j, \vec{\lambda}'')$$

where E is obtained from D by deleting two annuli through the same O_j , and $\vec{\lambda}''$ is obtained from $\vec{\lambda}$ by doing two unit enlargements to the same partition λ_j . Again, these terms cancel in pairs, due to presence of the signs $s(\lambda'_j, \lambda'_j)$ and $s(\lambda''_j, \lambda''_j)$, where λ'_j is the intermediate partition. Indeed, if for one term the unit enlargements are done after positions k and then l with $l < k$, then for the other term they are done in positions l and $k + 1$. Thus, the value of $s(\lambda'_j, \lambda'_j)s(\lambda''_j, \lambda''_j)$ is $(-1)^{k+l}$ in one case, and $(-1)^{k+l+1}$ in the other. This completes the proof that $(\delta^{II})^2 = 0$.

The proof that $(\delta^{III})^2 = 0$ is similar, with elementary coarsenings instead of unit enlargements. Once again, the signs $(-1)^{\ell(\lambda_1) + \dots + \ell(\lambda_{j-1})}$ and $s(\lambda'_j, \lambda'_j)$ ensure that the resulting terms cancel out in pairs.

The same kind of argument can be used to show that

$$(\delta^{II}\delta^{III} + \delta^{III}\delta^{II})(D, \vec{N}, \vec{\lambda}) = 0.$$

Next, let us check that

$$(\delta^I\delta^{II} + \delta^{II}\delta^I)(D, \vec{N}, \vec{\lambda}) = 0.$$

Here we obtain terms of the form $\pm(E, \vec{N} + \vec{e}_j, \vec{\lambda}')$, where E is obtained from D by deleting a rectangle R and an annulus H_j or V_j , and $\vec{\lambda}'$ is obtained from $\vec{\lambda}$ by doing a unit enlargement to λ_j . The terms come in pairs, corresponding to which of the operations δ^I and δ^{II} we do first. To see that they cancel out, observe that they get the same sign contributions from the factor $(-1)^{\mu(D)}$ in (4.4); the same goes for the factors $(-1)^{\ell(\lambda_1) + \dots + \ell(\lambda_{j-1})}$ and $s(\lambda'_j, \lambda'_j)$ in (4.5). However, the contributions due to the factor $(-1)^{\mu(D)}$ in (4.5) differ: for one term we get $(-1)^{\mu(D)}$, and for the other $(-1)^{\mu(E)}$, where $\mu(D) = \mu(E) + 1$.

The proofs that

$$\begin{aligned} (\delta^I\delta^{III} + \delta^{III}\delta^I)(D, \vec{N}, \vec{\lambda}) &= 0, \\ (\delta^I\delta^{IV} + \delta^{IV}\delta^I)(D, \vec{N}, \vec{\lambda}) &= 0 \end{aligned}$$

are similar. The cancellations are due to the signs $(-1)^{\mu(D)}$ in (4.6) and (4.7).

Next, we check that

$$(\delta^{\text{II}}\delta^{\text{IV}} + \delta^{\text{IV}}\delta^{\text{II}})(D, \vec{N}, \vec{\lambda}) = 0.$$

On the left hand side we obtain terms of the form $\pm(E, \vec{N} + \vec{e}_j - \lambda_{i,1}\vec{e}_i, \vec{\lambda}'')$ (from a unit enlargement combined with an initial reduction, in either order) and $\pm(E, \vec{N} + \vec{e}_j - \lambda_{i,m_i}\vec{e}_i, \vec{\lambda}'')$ (from a unit enlargement combined with a final reduction, in either order). These terms cancel in pairs as follows:

- When $i \neq j$, the term from a unit enlargement followed by a reduction cancels with the one where the operations are done in the opposite order. The signs of the terms differ due to the presence of the $(-1)^{\ell(\lambda_1) + \dots + \ell(\lambda_{j-1})}$ in (4.5) and (4.7);
- When $i = j$, the term from a unit enlargement in position k , which is not the first ($k \geq 2$), followed by an initial reduction, cancels with the one from the initial reduction followed by a unit enlargement in position $k - 1$. This is because of the sign $s(\lambda_j, \lambda'_j)$ in (4.5), which is $(-1)^{k-1}$ in one case and $(-1)^k$ in the other;
- When $i = j$, the term from a unit enlargement in position k , which is not the last ($k < m_j$), followed by a final reduction, cancels with the one from the final reduction followed by the same unit enlargement in position k . This is because of the extra sign $(-1)^{\ell(\lambda_j)}$ in the final reduction term in (4.7);
- When $i = j$, the term from a unit enlargement in the first position, followed by an initial reduction, cancels with the one from a unit enlargement in the last position, followed by a final reduction. Indeed, the former term is $(D, \vec{N}, \vec{\lambda})$ and the latter term is $(-1)^{m_j}(-1)^{m_j+1}(D, \vec{N}, \vec{\lambda}) = -(D, \vec{N}, \vec{\lambda})$.

Finally, we prove Equation (4.8). In the expression

$$((\delta^{\text{IV}})^2 + \delta^{\text{III}}\delta^{\text{IV}} + \delta^{\text{IV}}\delta^{\text{III}})(D, \vec{N}, \vec{\lambda})$$

we encounter terms of the form $(D, \vec{N}, \vec{\lambda}'')$, where $\vec{\lambda}''$ is obtained from $\vec{\lambda}$ either by a combination of an elementary coarsening and a reduction, or by two reductions. Most of the time, these terms cancel each other in pairs corresponding to reversing the order of the two operations. There are, however, two special cases:

- The term obtained by doing an elementary coarsening by combining the first two pieces of the partition λ_j , followed by an initial reduction of that partition, cancels with the term obtained by doing two initial reductions of λ_j ;
- Similarly, the term obtained by doing an elementary coarsening by combining the last two pieces of the partition λ_j , followed by a final reduction of that partition, cancels with the term obtained by doing two final reductions of λ_j .

Checking that the signs of the paired terms differ is a straightforward exercise. \square

Recall from Proposition 3.4 that the simpler complex CD_* has homology generated by the constant domain $c_{x^{\text{Id}}}$, for the generator x^{Id} . In fact, the span $\langle c_{x^{\text{Id}}} \rangle \cong \mathbb{Z}$ is a subcomplex of CD_* , and its quotient complex Q is acyclic. We will now establish a similar result for CDP_* .

Definition 4.5. We denote by $CDP_*^\dagger \subset CDP_*$ the subcomplex generated by triples $(c_{x^{\text{Id}}}, \vec{N}, \vec{\lambda})$ with \vec{N} made only of 0's and 1's. We let CDP'_* be the quotient complex CDP_*/CDP_*^\dagger .

Proposition 4.6. (a) *The complex CDP'_* is acyclic, and therefore the inclusion of CDP_*^\dagger in CDP_* is a quasi-isomorphism.*

(b) For a grid diagram \mathbb{G} of size n , the homology of CDP_*^\dagger (and hence also of CDP_*) is isomorphic to \mathbb{Z}^{2^n} . Its rank in degree k is $\binom{n}{k}$.

Proof. (a) As in the proof of Proposition 3.4, we filter the complex CDP'_* by the quantity

$$(A(D), B(D)) = (a, b) \in \mathbb{N}^{2n-2}$$

capturing the multiplicities of the domain D in the last column and the last row. In the associated graded, the differential has no more Type II terms. Then, note that the quantity $|\vec{N}|$ is kept constant by Type I and III terms, and decreased by Type IV terms. Thus, we can filter the associated graded complex by $|\vec{N}|$, and in the new associated graded, Type IV terms also disappear. Next, again following the proof of Proposition 3.4, we filter with respect to the endpoint y of the domain D . The resulting associated graded complex breaks as a direct sum of complexes

$$CDP_*^{a,b,y,\vec{N}}$$

generated by triples $(D, \vec{N}, \vec{\lambda})$ with $D \in \mathcal{D}^+(x, y)$ such that $(A(D), B(D)) = (a, b)$. It suffices to show that all of these complexes are acyclic.

When $y \neq x^{\text{Id}}$, we filter $CDP_*^{a,b,y,\vec{N}}$ with respect to the quantity $|\ell(\vec{\lambda})|$, and get rid of the Type III terms in the differential. We are left with only Type I terms. The resulting associated graded is a direct sum of complexes of the form $CD_*^{a,b,y}$, which were shown to be acyclic in the proof of Proposition 3.4. We deduce that $CDP_*^{a,b,y,\vec{N}}$ is acyclic.

When $y = x^{\text{Id}}$, the domain D is a periodic domain determined by a and b , and our complex $CDP_*^{a,b,x^{\text{Id}},\vec{N}}$ has only Type III terms in the differential. Here, $\vec{N} = (N_1, \dots, N_n) \in \mathbb{N}^n$ and, because of how we defined CDP'_* , we only consider the case when at least one N_i is ≥ 2 . We find that $CDP_*^{a,b,x^{\text{Id}},\vec{N}}$ is the tensor product of complexes $CDP_*(\text{Id}, N_j)$, for $j = 1, \dots, n$, where $CDP_*(\text{Id}, N_j)$ is generated by the partitions of N_j . By the Künneth formula, it suffices to show that $CDP_*(\text{Id}, N_j)$ is acyclic when $N_j \geq 2$.

Let us represent the partitions of N_j by sequences $(\epsilon_1, \dots, \epsilon_{N_j-1})$ as in (4.1). We see that $CDP_*(\text{Id}, N_j)$ is a hypercube complex, with the differential decreasing one of the ϵ_k by 1. In fact, we can describe $CDP_*(\text{Id}, N_j)$ as the tensor product of $N_j - 1$ complexes of the form $\mathbb{Z} \xrightarrow{\cong} \mathbb{Z}$, which are acyclic. Thus, $CDP_*(\text{Id}, N_j)$ is acyclic for $N_j \geq 2$, and the conclusion follows.

(b) Note that the differential on CDP_*^\dagger only has terms of Type IV, corresponding to initial or final reductions. We can identify the generators of CDP_*^\dagger with sequences $\vec{N} = (N_1, \dots, N_n) \in \{0, 1\}^n$. The terms in the differential come in pairs, corresponding to an initial and final reduction that do the same thing: change a value of N_j from 1 to 0. The paired terms come with opposite signs, because $\ell(\lambda_j) = 1$. We get that CDP_*^\dagger is the tensor product of n copies of the complex $\mathbb{Z} \xrightarrow{0} \mathbb{Z}$. The calculation of the homology of CDP_*^\dagger now follows from the Künneth formula. \square

5. $\langle n \rangle$ -MANIFOLDS

5.1. Definitions and examples. We recall the definition of an $\langle n \rangle$ -manifold, following Jänich [11]; see also [16] and [18, Section 3.1]. We will borrow the terminology from [17, Definition 3.2].

We say that a map from a subset $S \subset \mathbb{R}^k$ to \mathbb{R}^n is *smooth* if it is the restriction of a smooth map defined on an open set containing S . In particular, this allows us to define diffeomorphisms between open subsets of \mathbb{R}_+^k . Then, following Cerf [5] and Douady [8], we define a k -dimensional *manifold with corners* to be a topological space X along with a maximal atlas, where an atlas is a collection

of charts (U, ϕ) , where $U \subseteq X$ is open and ϕ is a homeomorphism from U to an open subset of \mathbb{R}_+^k , such that the sets U cover X , and, for any two charts (U, ϕ) and (V, ψ) , the map

$$\phi \circ \psi^{-1} : \psi(U \cap V) \rightarrow \phi(U \cap V)$$

is a diffeomorphism.

For $x \in X$, let $c(x)$ denote the number of coordinates in $\phi(x)$ which are zero, for some (and hence any) chart (U, ϕ) with $x \in U$. The codimension- i boundary of X is the subspace $\{x \in X \mid c(x) = i\}$; the usual boundary ∂X is the closure of the codimension-1 boundary. A *facet* is the closure of a connected component of the codimension-1 boundary of X . A *multifacet* of X is a (possibly empty) union of connected faces of X .

A k -dimensional *multifaceted manifold* is a k -dimensional manifold with corners X such that every $x \in X$ belongs to exactly $c(x)$ facets of X . For example, a simple polytope in \mathbb{R}^m is a multifaceted manifold. By contrast, the following “teardrop” manifold with corners

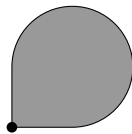

is not a multifaceted manifold, because the codimension-2 corner belongs to a single facet.

A k -dimensional $\langle n \rangle$ -*manifold* X is a k -dimensional multifaceted manifold, together with an ordered n -tuple $(\partial_1 X, \dots, \partial_n X)$ of multifacets of X such that

- $\cup_i \partial_i X = \partial X$ and
- $\partial_i X \cap \partial_j X$ is a multifacet of both $\partial_i X$ and $\partial_j X$ for all $i \neq j$.

For a subset $I \subset \{1, \dots, n\}$, we write

$$(5.1) \quad \partial_I X := \bigcap_{i \in I} \partial_i X, \quad \overset{\circ}{\partial}_I X := \partial_I X \setminus \bigcup_{I \subsetneq J} \overset{\circ}{\partial}_J X.$$

The subsets $\overset{\circ}{\partial}_I X$ are called the *strata* of X , and $\partial_I X$ are the *closed strata*.

Example 5.1. The n -dimensional hypercube $X = [0, 1]^n$ is an $\langle n \rangle$ -manifold, with $\partial_i X$ being the union of the two subsets given by setting the i th coordinate to either 0 or 1.

Example 5.2. Consider the $(n - 1)$ -dimensional permutohedron Π_n , defined as the convex hull of all points in \mathbb{R}^n whose coordinates are a permutation of $(1, 2, 3, \dots, n)$. This is an $\langle n - 1 \rangle$ -manifold, with the facets being the convex hulls of points for permutations that preserve a given partition of $\{1, 2, 3, \dots, n\}$ into two subsets A and B . The boundary $\partial_i \Pi_n$ consists of those facets for which $|A| = i$ and $|B| = n - i$. We refer to [41, Example 0.10], [2, Section 2] or [17, Section 3.3] for more details.

Remark 5.3. Given an injection

$$f : \{1, \dots, n\} \rightarrow \{1, \dots, l\},$$

we can view an $\langle n \rangle$ -manifold as an $\langle l \rangle$ -manifold, by writing $\partial_{f(i)} X$ instead of $\partial_i X$, and letting $\partial_j X = \emptyset$ when j is not in the image of f .

5.2. **Neat embeddings and smoothings.** Let

$$\mathbb{E}(N, n) = \mathbb{R}^N \times \mathbb{R}_+^n$$

for some $N, n \geq 0$. We will describe a class of embeddings of $\langle n \rangle$ -manifolds into $\mathbb{E}(N, n)$, called *neat*. Neat embeddings of $\langle n \rangle$ -manifolds were defined by Laures in [16] and used by Lipshitz and Sarkar in [18] to construct a Khovanov stable homotopy type. Our definition here will be slightly different, in that we require more than the intersections of strata with the boundaries of $\mathbb{E}(N, n)$ being perpendicular; we ask that the strata contain small product neighborhoods of a special form near the boundaries.

Let X be a $\langle n \rangle$ -manifold. Let t_1, \dots, t_n be the coordinates on $\mathbb{E}(N, n)$ corresponding to the \mathbb{R}_+ factors. We view $\mathbb{E}(N, n)$ as a $\langle n \rangle$ -manifold, with $\partial_I \mathbb{E}(N, n)$ being given by $t_i = 0$ for $i \in I$. We also let $\nu_\epsilon(\partial_I \mathbb{E}(N, n))$ be an ϵ -neighborhood of $\partial_I \mathbb{E}(N, n)$, given by $t_i \in [0, \epsilon]$ for $i \in I$. Finally, we let

$$\pi_I : \mathbb{E}(N, n) \rightarrow \partial_I \mathbb{E}(N, n)$$

be the orthogonal projection.

Definition 5.4. A smooth embedding of the $\langle n \rangle$ -manifold X into $\mathbb{E}(N, n)$ is called *neat* if

- (1) It respects the strata, i.e., for every i , we have $\partial_i X = X \cap \partial_i \mathbb{E}(N, n)$.
- (2) For every $I \subset \{1, \dots, n\}$, there exists $\epsilon > 0$ such that

$$\nu_\epsilon(\partial_I \mathbb{E}(N, n)) \cap X = \nu_\epsilon(\partial_I \mathbb{E}(N, n)) \cap \pi_I^{-1}(\partial_I X).$$

Remark 5.5. The condition that the embedding be smooth makes sense in terms of maps of smooth manifolds with corners. However, once we assume conditions (1) and (2), we can rephrase smoothness by simply asking for a topological embedding such that its restriction to every stratum $\mathring{\partial}_I X$ is a smooth embedding into the corresponding stratum $\mathring{\partial}_I \mathbb{E}(N, n)$.

Example 5.6. The permutohedron Π_2 is a hexagon, and Figure 3 shows a neat embedding of that hexagon. The edges are perpendicular to \mathbb{R}^N at vertices, and in fact contain small perpendicular intervals. We then fill in the hexagon so that, near an edge contained in one of the two hyperplanes $\mathbb{R}^N \times \mathbb{R}_+ \times 0$ or $\mathbb{R}^N \times 0 \times \mathbb{R}_+$, it contains the product of that edge and an interval $[0, \epsilon]$ in the direction perpendicular to that hyperplane.

Proposition 5.7. *Let X be an $\langle n \rangle$ -manifold such that ∂X is compact. Then X admits a neat embedding into $\mathbb{E}(N, n)$ for some N .*

Proof. This was proved by Laures in [16, Proposition 2.1.7], for X compact. He used his definition of neat embedding, which only required the intersections of strata with the boundaries of $\mathbb{E}(N, n)$ to be perpendicular. However, an inspection of his proof shows that the resulting embedding is neat in our sense. Further, the compactness condition can be weakened to ∂X being compact. Indeed, the proof proceeds by constructing collar neighborhoods of the strata (by integrating vector fields), then neatly embedding a neighborhood of ∂X , and then extending the embedding to the interior. The last step can also be done when X is not compact, in a similar way to the proof that ordinary smooth manifolds can be embedded in Euclidean space. \square

Remark 5.8. With a little more work, one can also drop the compactness assumption on ∂X in Proposition 5.7. However, we will not need this more general statement.

Note that the boundary of $\mathbb{E}(N, n)$ is given by the equation $t_1 t_2 \dots t_n = 0$, which can be smoothed into $t_1 t_2 \dots t_n = \delta$. Neat embeddings allow us to smooth the boundaries on $\langle n \rangle$ -manifolds in a similar fashion.

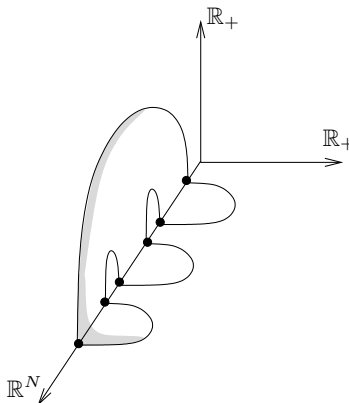

FIGURE 3. A neat embedding of the permutohedron Π_2 . Some part of the hexagon is shown shaded.

Definition 5.9. Let X be a compact $\langle n \rangle$ -manifold. Pick a neat embedding of X into some $\mathbb{E}(N, n)$, and a value $\delta > 0$ smaller than all ϵ appearing (for different I) in Definition 5.4. Then, the subset

$$\text{sm}[X] = X \cap \{(x, t_1, t_2, \dots, t_n) \in \mathbb{E}(N, n) \mid t_1 t_2 \dots t_n \geq \delta\}$$

is a smooth manifold with boundary, called a *smoothing* of X . The boundary $\partial \text{sm}[X]$ is called the *smoothed boundary* of X .

6. STRATIFIED SPACES

There are many different definitions of stratified spaces in the literature. We will start with the following simple minded one.

Definition 6.1. A *stratified space* is a topological space X together with a locally finite decomposition of X into disjoint subsets, called *strata*, such that each stratum is equipped with the structure of a smooth manifold. The decomposition is called a *stratification* of X .

It will be helpful to know that the stratified spaces we will encounter in this paper satisfy certain properties; in particular, we will need to be able to smooth the boundary of each stratum, to obtain manifolds with boundary. This can be done for *Thom-Mather stratified spaces*. In turn, to show that a space is Thom-Mather stratified, it suffices to show that it is Whitney stratified, so we will start by defining *Whitney stratifications*.

6.1. Whitney stratified spaces. Whitney stratified spaces were defined in [40]. See [9] for another exposition.

Definition 6.2. Let $X, Y \subseteq \mathbb{R}^n$ be smooth submanifolds, and let $x \in X$. We say that Y is *Whitney regular over X at x* if, whenever two sequences (x_i) of points in X and (y_i) of points in Y , with $x_i \neq y_i$, are such that:

- both sequences (x_i) and (y_i) converge to x ,
- the sequences of tangent spaces $T_{y_i} Y$ converge to a subspace $T \subseteq \mathbb{R}^n$, and
- the secant lines $\overrightarrow{x_i y_i}$ converge to a line $L \subseteq \mathbb{R}^n$,

then L is contained in T .

Definition 6.3. Let M be a smooth m -dimensional manifold, $X, Y \subset M$ be smooth submanifolds, and $x \in X$. We say that Y is *Whitney regular over X at x* if their images in \mathbb{R}^m are so, under one (and therefore under any) coordinate chart for M at x .

We define the *bad set* $B(X, Y)$ to be the set of $x \in X$ such that Y is not Whitney regular over X at x . We say that Y is *Whitney regular over X* if $B(X, Y) = \emptyset$.

Definition 6.4. Let M be a smooth manifold, and $V \subseteq M$ a subset. A *Whitney stratification* of V is a stratification such that all the strata are smooth submanifolds of M , and they are regular over each other.

The commonly given example of a non-Whitney stratification is that of the Whitney umbrella $\{(x, y, z) \in \mathbb{R}^3 \mid x^2z = y^2\}$, where one stratum X is the z -axis and the other stratum Y is its complement. Then Y is not Whitney regular over X at the origin. However, if we make the origin into a separate stratum of its own, we get a Whitney stratification. We will come back to the Whitney umbrella in Section 7.2; see Figure 6.

More generally, Thom [38] showed that all semialgebraic sets admits Whitney stratifications. Recall that the class of *semialgebraic sets* of \mathbb{R}^n is the smallest Boolean algebra of subsets of \mathbb{R}^n which contains all sets of the form

$$\{x \in \mathbb{R}^n \mid f(x) > 0\}$$

with $f : \mathbb{R}^n \rightarrow \mathbb{R}$ a polynomial function. For our purposes, we will need the following three results:

Proposition 6.5 (Proposition (2.1) in [9]). *Let $f : \mathbb{R}^n \rightarrow \mathbb{R}^m$ be a polynomial map, and $V \subseteq \mathbb{R}^n$ a semialgebraic set. Then the image $f(V)$ is semialgebraic.*

Proof. The Tarski-Seidenberg theorem says that the conclusion is true when f is a linear projection. For the general statement, consider the graph of f in $\mathbb{R}^n \times \mathbb{R}^m$. This is semialgebraic, and its linear projection to \mathbb{R}^m is $f(V)$. \square

Proposition 6.6 (Whitney's theorem [40, 39]; Proposition (2.6) in [9]). *Let X, Y be semialgebraic smooth submanifolds of \mathbb{R}^n . Then the bad set $B(X, Y)$ is semialgebraic, of dimension strictly smaller than the dimension of X .*

Proposition 6.7 (Proposition (1.2) in [9]). *Let V_1, \dots, V_m be Whitney stratified spaces. Then the product stratification on $V_1 \times \dots \times V_m$ (consisting of Cartesian products of the strata in each V_i) is a Whitney stratification.*

6.2. Thom-Mather stratified spaces. The following definition is based on [24, Section 8].

Definition 6.8. A *Thom-Mather stratified space* is a triple $(V, \mathcal{S}, \mathcal{T})$ satisfying the following axioms:

- (A-1) V is a Hausdorff, locally compact, second countable topological space;
- (A-2) \mathcal{S} is a family of locally closed subsets of V , such that V is the disjoint union of the members of \mathcal{S} . The members of \mathcal{S} are called the *strata* of V , and their closures are called the *closed strata*.
- (A-3) Each stratum of V (with the induced topology from V) is a topological manifold, and additionally equipped with a C^∞ structure;
- (A-4) The family \mathcal{S} is locally finite.
- (A-5) If $X, Y \in \mathcal{S}$ and $X \cap \overline{Y} \neq \emptyset$, then $X \subseteq \overline{Y}$. If this is the case, we write $X \leq Y$. If $X \leq Y$ and $X \neq Y$, we write $X < Y$.
- (A-6) \mathcal{T} is a collection of triples (T_X, π_X, ρ_X) , one for each $X \in \mathcal{S}$, where T_X is an open neighborhood of X in V (called a *tubular neighborhood*), $\pi_X : T_X \rightarrow X$ is a continuous retraction, and $\rho_X : T_X \rightarrow [0, \infty)$ a continuous function.

(A-7) $X = \{v \in T_X \mid \rho_X(v) = 0\}$.

(A-8) For $X, Y \in \mathcal{S}$, denote

$$T_{X,Y} = T_X \cap Y, \quad \pi_{X,Y} = \pi_X|_{T_{X,Y}}, \quad \rho_{X,Y} = \rho_X|_{T_{X,Y}}.$$

Then, we require that for any distinct strata X and Y the mapping

$$(\pi_{X,Y}, \rho_{X,Y}) : T_{X,Y} \rightarrow X \times (0, \infty)$$

is a smooth submersion.

(A-9) For any strata X, Y , and Z , we have

$$\pi_X \pi_Y(v) = \pi_X(v), \quad \rho_X \pi_Y(v) = \rho_X(v)$$

whenever both sides of the respective equation are defined.

(A-10) If $X, Y \in \mathcal{S}$ satisfy $T_{X,Y} \neq \emptyset$, then $X \leq Y$.

(A-11) If $X, Y \in \mathcal{S}$ are such that $T_X \cap T_Y \neq \emptyset$, then X and Y are comparable, i.e., we have $X \leq Y$ or $Y \leq X$.

Remark 6.9. The terminology used in [24] is *abstract stratified set*. This is required to only satisfy the conditions (A-1)–(A-9), but it is noted there that every such set is equivalent to one that also satisfies (A-10) and (A-11).

Remark 6.10. The function ρ_X is called the *tubular function* of X . Roughly, it is meant to play the role of the distance to X .

Remark 6.11. As noted in [24], the assumptions (A-1)–(A-10) above also have the following implications:

- The relation \leq is a partial order on \mathcal{S} ;
- $X \leq Y$ if and only if $T_{X,Y} \neq \emptyset$;
- X and Y are comparable if and only if $T_X \cap T_Y \neq \emptyset$.

Remark 6.12. Another implication is that if x is a point in a k -dimensional stratum X , then there is a neighborhood V_x of x in V homeomorphic to $\mathbb{R}^k \times C(L)$, where L is a stratified space and $C(L) = (L \times [0, 1]) / (L \times \{0\})$ is the open cone on L . Specifically, we can take V_x to be the preimage of a chart in X under the map π_X . If we identify

$$L \cong \{0\} \times L \times \{1/2\} \subset \mathbb{R}^k \times C(L) \cong V_x,$$

then the stratification of L is given by intersections with the strata Y such that $X < Y$.

The space L is called the *link* of X at x . We will refer to $\mathbb{R}^k \times C(L)$ as the *local model* of V around x , and to $C(L)$ as the *local model in the normal directions*.

Remark 6.13. Given a stratum X in a Thom-Mather stratified space, its closure \overline{X} and the boundary $\partial X = \overline{X} \setminus X$ have induced Thom-Mather stratifications. The boundary ∂X is the union of all strata Y such that $Y < X$.

We now turn to examples of Thom-Mather stratified spaces. First, an $\langle n \rangle$ -manifold X can be made into a Thom-Mather stratified space as follows. Let $\partial_i X$, for $i = 1, \dots, n$, be the distinguished collection of multifacets, and $\partial_I X$ and $\overset{\circ}{\partial}_I X$ be as in (5.1). We let $\overset{\circ}{\partial}_I X$ be the strata in X and $\partial_I X$ are their closures. Observe that

$$\partial_J X \subseteq \partial_I X \iff I \subseteq J.$$

The tubular neighborhood of a stratum $\overset{\circ}{\partial}_I X$ in an $\langle n \rangle$ -manifold X can be constructed by integrating a smooth vector field that is transverse to $\overset{\circ}{\partial}_I X$, and vanishes at the boundary of $\overset{\circ}{\partial}_I X$.

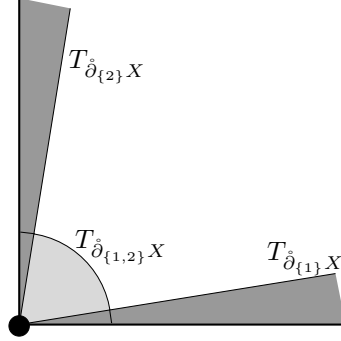

FIGURE 4. The Thom-Mather stratified space $X = [0, \infty)^2$, with tubular neighborhoods.

Example 6.14. Consider the quadrant $X = [0, \infty)^2$, and view it as a $\langle 2 \rangle$ -manifold with $\partial_1 X = [0, \infty) \times \{0\}$ and $\partial_2 X = \{0\} \times [0, \infty)$. There are four strata:

$$\mathring{\partial}_{\emptyset} X = (0, \infty)^2, \quad \mathring{\partial}_{\{1\}} X = (0, \infty) \times \{0\}, \quad \mathring{\partial}_{\{2\}} X = \{0\} \times (0, \infty), \quad \mathring{\partial}_{\{1,2\}} X = \{(0, 0)\}.$$

Their tubular neighborhoods are shown in Figure 4: that of $\mathring{\partial}_{\{1,2\}} X$ is the lightly shaded quarter-disk, those of $\mathring{\partial}_{\{1\}} X$ and $\mathring{\partial}_{\{2\}} X$ are darkly shaded, and the tubular neighborhood of $\mathring{\partial}_{\emptyset} X$ is $\mathring{\partial}_{\emptyset} X$ itself.

Remark 6.15. In [16, Lemma 2.1.6] it is proved that the *closed* strata $\partial_I X$ in an $\langle n \rangle$ -manifold admit a system of collar neighborhoods, of the form $\mathbb{R}^{|I|} \times \partial_I X$. These are different from the tubular neighborhoods that we consider in their paper, but serve similar purposes. The collar neighborhoods from [16, Lemma 2.1.6] were used in the construction of the Khovanov stable homotopy type in [18]. We do not use them here because they do not admit a straightforward generalization to other stratified spaces.

A larger class of Thom-Mather stratified spaces is provided by the following result.

Theorem 6.16 (Thom [38], Mather [24]). *The strata in Whitney stratified spaces admit tubular neighborhoods as in Definition 6.8, and therefore Whitney stratified spaces can be turned into Thom-Mather stratified spaces.*

6.3. Smoothings. We now explain how one can smooth the boundary of a stratum in a Thom-Mather stratified space. The lemma below is key: it allows us to find neighborhoods of the boundary that are submanifolds with corners.

Lemma 6.17. *Let X be an n -dimensional stratum in a Thom-Mather stratified space $(V, \mathcal{S}, \mathcal{T})$. For any stratum $Y \subseteq \partial X$, choose $\epsilon_Y > 0$ sufficiently small, inductively on the dimension of Y , so that $\epsilon_Y \ll \epsilon_Z$ when $Z \leq Y$. Consider the following closed neighborhood of ∂X in \bar{X} :*

$$\mathcal{N} = \bigcup_{Y < X} (\rho_Y^{-1}([0, \epsilon_Y]) \cap \bar{X}).$$

Then, the complement

$$M := \bar{X} \setminus \text{int}(\mathcal{N})$$

is an n -dimensional $\langle n \rangle$ -manifold.

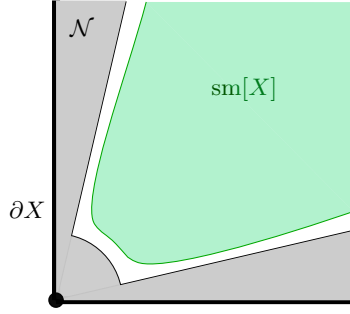

FIGURE 5. A smoothing of the stratified space from Figure 4.

Proof. It is convenient to set $\rho_Y(x) = \infty$ where ρ_Y is undefined, i.e., for $x \notin T_Y$. Then we can write

$$M = \bar{X} \cap \bigcap_{Y < X} \rho_Y^{-1}([\epsilon_Y, \infty]).$$

For $i = 1, \dots, n$, set

$$\partial_i M = \{x \in M \mid \rho_Y(x) = \epsilon_Y \text{ for some } Y < X \text{ with } \dim Y = i - 1\}.$$

To see that this turns M into an $\langle n \rangle$ -manifold, pick any point $x \in \partial M = \cup_i \partial_i M$, and consider the strata $Y < X$ that satisfy $\rho_Y(x) = \epsilon_Y$. Using (A-11), we see that \leq is a total order on these strata, so the strata have different dimensions and we can label them by $Y_1 < Y_2 < \dots < Y_k$. Thus, x lies at the intersection of the boundaries $\partial_i M$ where $i = \dim Y_j$ for some j . Furthermore, near x , the subset $M \subseteq X$ is given by the inequalities

$$\rho_{Y_i} \geq \epsilon_{Y_i}, \quad i = 1, \dots, k.$$

We claim that x is a codimension k corner, that is, the local model for M near x is $0 \in \mathbb{R}^{n-k} \times \mathbb{R}_+^k$. For this, it suffices to show that the map

$$(\rho_{Y_1, X}, \rho_{Y_2, X}, \dots, \rho_{Y_k, X}) : U(x) \rightarrow \mathbb{R}^k$$

is a submersion at x . (Here, $U(x)$ is a neighborhood of x in X .)

We prove by induction on $j \leq k$ that

$$(\rho_{Y_1, X}, \rho_{Y_2, X}, \dots, \rho_{Y_j, X}) : U(x) \rightarrow \mathbb{R}^j$$

is a submersion at x . The base case $j = 1$ follows from (A-8). For the inductive step, using (A-9), we write

$$(\rho_{Y_1, X}, \rho_{Y_2, X}, \dots, \rho_{Y_j, X}) = (\rho_{Y_1, Y_j}, \rho_{Y_2, Y_j}, \dots, \rho_{Y_{j-1}, Y_j}, \text{id}) \circ (\pi_{Y_j, X}, \rho_{Y_j, X}).$$

Note that $(\pi_{Y_j, X}, \rho_{Y_j, X})$ is a submersion by (A-8). Using the inductive hypothesis for $j - 1$ and the fact that the composition of submersions is a submersion, the claim follows. \square

Definition 6.18. Let X be an n -dimensional stratum of a Thom-Mather stratified space, such that ∂X is compact. We define the *smoothing of X* to be the n -dimensional smooth manifold with boundary

$$\text{sm}[X] := \text{sm}[M]$$

where $M \subseteq X$ is the $\langle n \rangle$ -manifold from Lemma 6.17, and $\text{sm}[M] \subseteq M$ was defined in Definition 5.9.

See Figure 5 for an example.

7. LOCAL MODELS

In this paper we will work with a certain kind of stratified spaces, where we have boundaries and corners as in $\langle n \rangle$ -manifolds, but we also allow a different type of boundary, modeled on “generalized Whitney umbrellas” and called the *special boundary*. When we glue several of these spaces along their special boundaries, we will obtain an $\langle n \rangle$ -manifold.

The spaces will be constructed in Section 12. For now, we will limit ourselves to describing the local models that appear in their stratifications.

7.1. The spaces I_N . Let us first consider the space

$$I_N = \text{Sym}^N(\mathbb{R})/\mathbb{R},$$

where $N \geq 0$ and Sym^N denotes the N^{th} symmetric product, and \mathbb{R} acts by simultaneous translation on all factors. Recall from Section 4.1 that $\text{Part}(N)$ denotes the set of ordered partitions of N . For

$$\lambda = (\lambda_1, \dots, \lambda_m) \in \text{Part}(N),$$

let $I(\lambda) \subseteq I_N$ be the subset consisting of N -tuples of real numbers (modulo \mathbb{R}) such that the first λ_1 of these numbers coincide (take the same value x_1), the next λ_2 coincide (taking a value x_2), and so on, with $x_i < x_j$ for $i < j$. The decomposition

$$(7.1) \quad I_N = \bigsqcup_{\lambda \in \text{Part}(N)} I(\lambda)$$

gives I_N the structure of a stratified space, with strata $I(\lambda)$.

The dimension of I_N is $\ell(\lambda) - 1$, where $\ell(\lambda) = m$ is the length of the partition. The local model of I_N around a point in $I(\lambda)$ is

$$\mathbb{R}^{m-1} \times I_{\lambda_1} \times \dots \times I_{\lambda_m}.$$

The refinement order on partitions introduced in Section 4.1 is relevant to the decomposition of I_N , because it tells us which strata are in the closures of other strata:

$$(7.2) \quad I(\lambda) \leq I(\mu) \iff \mu \leq \lambda.$$

Example 7.1. When $N = 0$ or 1 , there is a unique partition of N , and in both cases I_N is a point. When $N = 2$, we have $I_2 \cong [0, \infty)$, with the strata in the decomposition being $I_2(2) = \{0\}$ and $I_2(1, 1) = (0, \infty)$. When $N = 3$, one can check that $I_3 \cong [0, \infty)^2$, with $I_3(3)$ being the origin, $I_3(1, 2)$ and $I_3(2, 1)$ being the two half-lines on the boundary, and $I_3(1, 1, 1) \cong (0, \infty)^2$. When $N \geq 4$, the topology of I_N is more complicated; see [3].

7.2. The spaces Z_N . Next, consider the space

$$Z_N = \text{Sym}^N(\mathbb{C})/\mathbb{R},$$

where \mathbb{R} acts on the \mathbb{C} factors by translating the real parts. If we let the coordinates on each copy of \mathbb{C} be

$$z_j = x_j + iy_j, \quad j = 1, \dots, N,$$

note that $\text{Sym}^N(\mathbb{C})$ can be identified with \mathbb{C}^N using the elementary symmetric polynomials in z_1, \dots, z_N :

$$(7.3) \quad s_1 = \sum_j z_j, \quad s_2 = \sum_{j < l} z_j z_l, \quad \dots, \quad s_N = \prod_j z_j.$$

Further, dividing by \mathbb{R} is equivalent to setting $\operatorname{Re}(s_1) = x_1 + \cdots + x_N = 0$. Therefore, we can identify Z_N with \mathbb{R}^{2N-1} , with real coordinates being

$$(7.4) \quad \operatorname{Im}(s_1), \operatorname{Re}(s_2), \operatorname{Im}(s_2), \dots, \operatorname{Re}(s_N), \operatorname{Im}(s_N).$$

We put a stratification on $Z_N \cong \mathbb{R}^{2N-1}$, with the strata being given by the signs of the imaginary parts $y_j = \operatorname{Im}(z_j)$, as well as by which real coordinates coincide for the indices j with $y_j = 0$. Precisely, consider the decomposition

$$Z_N = \bigsqcup_{\substack{p^- + p^0 + p^+ = N \\ \lambda \in \operatorname{Part}(p^0)}} Z(p^-, p^0, p^+; \lambda),$$

with $Z(p^-, p^0, p^+; \lambda)$ consisting of the multisets $\{z_1, \dots, z_N\}$ where p^- of the y_j 's are less than zero, p^0 are zero, p^+ are greater than zero, and the p^0 coordinates x_j (those for which $y_j = 0$) are split according to the partition λ , as in the decomposition (7.1) of the space I_{p^0} . Observe that

$$(7.5) \quad Z(p^-, p^0, p^+; \lambda) \leq Z(q^-, q^0, q^+; \mu) \iff (p^- \leq q^-, p^+ \leq q^+ \text{ and } \mu \leq \lambda).$$

We will denote the closure of $Z(p^-, p^0, p^+; \lambda)$ by $\bar{Z}(p^-, p^0, p^+; \lambda)$.

We have

$$\dim Z(p^-, p^0, p^+; \lambda) = 2p^- + 2p^+ + \ell(\lambda) - 1.$$

For example, there is a unique zero dimensional stratum, namely $Z(0, N, 0; N)$.

Observe that the codimension of a stratum $Z(p^-, p^0, p^+; \lambda) \subset Z_N$ is $2p^0 - \ell(\lambda)$, which is at least p^0 . In particular, there are $N + 1$ codimension zero strata, corresponding to $p^0 = 0$.

We let $Z(p^-, p^0, p^+)$ be the union of $Z(p^-, p^0, p^+; \lambda)$ over all $\lambda \in \operatorname{Part}(p^0)$. In particular, $Z(0, N, 0)$ is our old space I_N . Also, note that when $p^0 = 0$ or 1 , there is a unique partition (p^0) , so $Z(p^-, p^0, p^+) = Z(p^-, p^0, p^+; p^0)$.

Example 7.2. When $N = 1$, we look at

$$Z_1 = \operatorname{Sym}^1(\mathbb{C})/\mathbb{R} \cong \mathbb{R},$$

with the three strata $(-\infty, 0)$, $\{0\}$ and $(0, \infty)$.

Example 7.3. When $N = 2$, we look at $Z_2 = \operatorname{Sym}^2(\mathbb{C})/\mathbb{R}$, with the coordinates on the two copies of \mathbb{C} being

$$z_1 = x_1 + iy_1, \quad z_2 = x_2 + iy_2.$$

We identify $\operatorname{Sym}^2(\mathbb{C})$ with \mathbb{C}^2 using the symmetric polynomials $z_1 + z_2$ and $z_1 z_2$. After dividing by \mathbb{R} -translation (that is, setting $x_1 + x_2 = 0$), we are left with three real coordinates on Z_2 :

$$\begin{aligned} a &= \operatorname{Im}(z_1 + z_2) = y_1 + y_2, \\ b &= -\operatorname{Re}(z_1 z_2) = x_1^2 + y_1 y_2, \\ c &= -\operatorname{Im}(z_1 z_2) = x_1(y_1 - y_2). \end{aligned}$$

Let $W \subset Z_2$ be the hypersurface given by the condition that at least one of z_1 and z_2 be real, i.e. $y_1 y_2 = 0$. From here we get $b = x_1^2 \geq 0$ and $c = \pm x_1 a$, so $a^2 b = c^2$:

$$W = \{(a, b, c) \in \mathbb{R}^3 \mid b \geq 0, a^2 b = c^2\}.$$

This is the Whitney umbrella shown in Figure 6. The complement of W in Z_2 splits into three connected components:

$$Z(2, 0, 0) = \{(a, b, c) \in \mathbb{R}^3 \mid a^2 b > c^2, c < 0\},$$

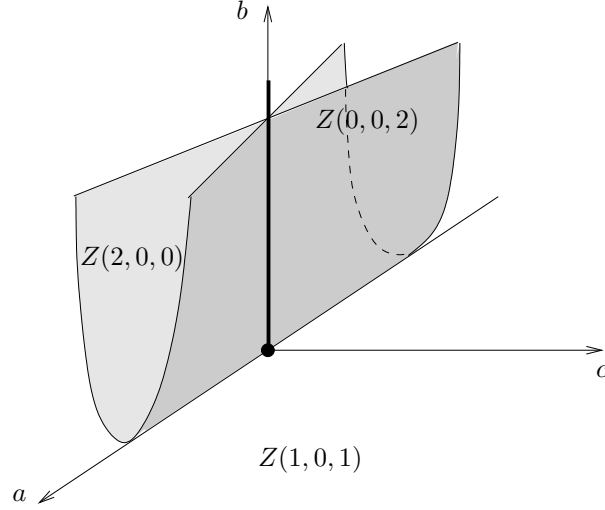

FIGURE 6. A Whitney umbrella inside Z_2 . The black dot is the stratum $Z(0, 2, 0; 2)$, and the thickened half-line is $Z(0, 2, 0; 1, 1)$.

$$\begin{aligned} Z(1, 0, 1) &= \{(a, b, c) \in \mathbb{R}^3 \mid a^2 b < c^2\}, \\ Z(0, 0, 2) &= \{(a, b, c) \in \mathbb{R}^3 \mid a^2 b > c^2, c > 0\}, \end{aligned}$$

corresponding to none, one, or two of the y_j coordinates being positive, and the rest negative.

The codimension-1 strata are the two halves of W :

$$\begin{aligned} Z(1, 1, 0) &= \{(a, b, c) \in \mathbb{R}^3 \mid a^2 b = c^2, a < 0\}, \\ Z(0, 1, 1) &= \{(a, b, c) \in \mathbb{R}^3 \mid a^2 b = c^2, a > 0\}. \end{aligned}$$

This leaves the strata corresponding to $y_1 = y_2 = 0$, which give the half-line

$$Z(0, 2, 0) = \{(0, b, 0) \in \mathbb{R}^3 \mid b \geq 0\}.$$

This is further decomposed into the codimension-2 stratum $Z(0, 2, 0; 1, 1)$, which is the open half-line, and the stratum $Z(0, 2, 0; 2)$, which is just the point $\{(0, 0, 0)\}$.

7.3. Models for internal framings. We will now construct explicit framings for the normal bundles to the strata in Z_N . These will be models for the internal framings in Section 10.3 below.

Convention 7.4. A framing of a vector bundle is defined to be a smoothly varying, ordered basis of the fibers. (We do not ask it to be orthonormal.) The normal bundle to a submanifold $X \subset V$ is defined to be the quotient TV/TX , which we can identify with any complement of TX in TV . Throughout this paper, when talking about a framing of the normal bundle, we will always mean that such a complement has been chosen, and we consider a framing of it; thus, the frame consists of vectors in TV . We do not ask for the complement to be the orthogonal complement. Of course, from a framing as above one can get one of the orthogonal complement, and/or an orthonormal framing, by using the Gram-Schmidt process. However, it is convenient to have the extra flexibility.

Let $\tilde{Z}_N = \text{Sym}^N(\mathbb{C})$, which we can identify with $\mathbb{R} \times Z_N$ by letting the first coordinate be $\text{Re}(s_1)$ in the notation of (7.3). The space \tilde{Z}_N has a stratification with strata

$$\tilde{Z}(p^-, p^0, p^+; \lambda) = \mathbb{R} \times Z(p^-, p^0, p^+; \lambda).$$

The normal bundle to $Z(p^-, p^0, p^+; \lambda)$ in Z_N is then identified with the normal bundle to $\tilde{Z}(p^-, p^0, p^+; \lambda)$ in \tilde{Z}_N , so it suffices to frame the latter.

Let us start by describing the tangent space to \tilde{Z}_N . Of course, \tilde{Z}_N is an affine space with coordinates (7.3). However, it is helpful to think of the elements of \tilde{Z}_N as multisets $\{z_1, \dots, z_N\}$, and express the tangent space in terms of the infinitesimal variations $w_j = \delta z_j$.

At a point $\{z_1, \dots, z_N\} \in Z_N$ where all z_j are distinct, the z_j 's form a local coordinate system and therefore w_1, \dots, w_N give a basis for the tangent space. In general, suppose $\{z_1, \dots, z_N\}$ are grouped according to a partition $\mu = (\mu_1, \dots, \mu_m) \in \text{Part}(N)$, so that the first μ_1 are equal, the next μ_2 are equal, and so on. For each subset of coordinates equal to each other, say $z_{i_1} = \dots = z_{i_k}$ with $k = \mu_j$ for some j , consider the corresponding variables w_{i_1}, \dots, w_{i_k} . Then, the k elementary symmetric polynomials in w_{i_1}, \dots, w_{i_k} , taken together over all parts of μ , give a local coordinate chart for \tilde{Z}_N . We call these *local coordinates tailored to the point* $\{z_1, \dots, z_N\}$.

Next, let us consider the tangent space to a stratum $\tilde{Z}(p^-, p^0, p^+; \lambda)$. At a point $\{z_1, \dots, z_N\}$ in that stratum, $p^- + p^+$ of the coordinates have nonzero imaginary values, and when we group them according to how many are equal to each other, the elementary symmetric polynomials in the corresponding w_j give some linearly independent vectors (just as they did for \tilde{Z}_N). The difference lies in the p^0 coordinates with zero imaginary values. These are grouped according to the partition $\lambda = (\lambda_1, \dots, \lambda_m)$. Let us relabel the respective coordinates as

$$z_{i,1} = z_{i,2} = \dots = z_{i,\lambda_i}, \quad i = 1, \dots, m$$

with

$$\text{Re}(z_{i,1}) < \text{Re}(z_{i,2}) < \dots < \text{Re}(z_{i,\lambda_i}).$$

Let $w_{i,j}$ be the corresponding infinitesimal variations. Then, to complete a basis for the tangent space to $\tilde{Z}(p^-, p^0, p^+; \lambda)$, we will include the vectors

$$\text{Re}(w_{i,1} + \dots + w_{i,\lambda_i}),$$

for each $i = 1, \dots, m$.

With that in mind, it is easy to write down a basis for the normal bundle to $\tilde{Z}(p^-, p^0, p^+; \lambda)$ in \tilde{Z}_N . It consists of the real and imaginary parts of the elementary symmetric polynomials in each set $\{w_{i,1}, \dots, w_{i,\lambda_i}\}$, except that we do not include the real parts of the first symmetric polynomials (the sums). Let us write

$$s_{i,1} = \sum_j z_{i,j}, \quad s_{i,2} = \sum_{j < l} z_j z_l, \dots, \quad s_{i,\lambda_i} = \prod_j z_j.$$

Definition 7.5. The *standard frame* for the normal bundle to $Z(p^-, p^0, p^+; \lambda)$ in Z_N is given by the vectors

$$\begin{aligned} & \text{Im}(s_{1,1}), \text{Re}(s_{1,2}), \text{Im}(s_{1,2}), \dots, \text{Re}(s_{1,\lambda_1}), \text{Im}(s_{1,\lambda_1}), \\ & \text{Im}(s_{2,1}), \text{Re}(s_{2,2}), \text{Im}(s_{2,2}), \dots, \text{Re}(s_{2,\lambda_2}), \text{Im}(s_{2,\lambda_2}), \\ & \dots \\ & \text{Im}(s_{m,1}), \text{Re}(s_{m,2}), \text{Im}(s_{m,2}), \dots, \text{Re}(s_{m,\lambda_m}), \text{Im}(s_{m,\lambda_m}), \end{aligned}$$

in this order.

Example 7.6. Consider the stratified space Z_2 from Example 7.3. The normal bundle to either of the two sides of the Whitney umbrella, $Z(1, 1, 0)$ or $Z(0, 1, 1)$, has a standard frame consisting of a single vector $\text{Im}(w_1) = \delta y_1$. In terms of the coordinates a, b, c , the vector is expressed by taking the derivatives of their expression with respect to y_1 . We get the vector $(1, y_2, x_1)$. Since we are at a point where $y_1 = 0$, we can write this normal vector as $(1, a, -c/a)$. Observe that this points in the direction away from $Z(0, 0, 2)$ and towards $Z(1, 0, 1)$ when $a < 0$, and in the direction away from $Z(1, 0, 1)$ and towards $Z(2, 0, 0)$ when $a > 0$.

Example 7.7. We can also look at the normal bundle to the half-line $Z(0, 2, 0; 1, 1) \subset Z_2$. This stratum is characterized by $y_1 = y_2 = 0$ and $x_1 < x_2$. The standard frame is given by

$$w_1 = (1, 0, -\sqrt{b}), w_2 = (1, 0, \sqrt{b}),$$

which are the limits of the normal vectors to the sides of the Whitney umbrella.

Example 7.8. Finally, the normal bundle to the origin $Z(0, 2, 0; 2) \subset Z_2$ has standard frame given by $\text{Im}(w_1 + w_2)$, $\text{Re}(w_1 w_2)$, $\text{Im}(w_1 w_2)$. This is simply the usual orthonormal frame to \mathbb{R}^3 : $(1, 0, 0)$, $(0, 1, 0)$ and $(0, 0, 1)$.

7.4. Local models from Z_N . Consider a stratum

$$Y = Z(p^-, p^0, p^+; \lambda) \subseteq Z_N$$

with $\lambda = (\lambda_1, \dots, \lambda_m)$. Around a point $y \in Y$, take the tailored local coordinate system around y considered in the previous subsection. (Note that this may differ from the global coordinate system on Z_N used in Section 7.2, which is given by the elementary symmetric polynomials in all z_i .) In the tailored local coordinate system, consider the linear subspace generated by the standard frame for the normal bundle to Y , as in Definition 7.5. This linear subspace is the *local model for Y in the normal directions*, and we denote it by

$$(7.6) \quad \mathcal{L}(Y) := Z_{\lambda_1} \times \dots \times Z_{\lambda_m}.$$

Of course, each Z_i is a Euclidean space, and hence so is $\mathcal{L}(Y)$. However, writing it as above allows us to understand the local models around y inside all the other strata.

Indeed, consider another stratum $X = Z(q^-, q^0, q^+; \mu)$ with $Y \leq X$. Using the local coordinate system around y , we can identify $\mathcal{L}(Y)$ with a small disk inside Z_N , transverse to Y at y and of complementary dimension. The stratification of each Z_{λ_i} induces a product stratification of $\mathcal{L}(Y)$, and the intersection

$$\mathcal{L}(Y; X) := \mathcal{L}(Y) \cap X$$

is a union of some of the resulting strata. Precisely, the product stratum

$$Z_{\lambda_1}(q_1^-, q_1^0, q_1^+; \mu^1) \times \dots \times Z_{\lambda_m}(q_m^-, q_m^0, q_m^+; \mu^m)$$

is part of $\mathcal{L}(Y; X)$ provided that:

$$q^- = p^- + \sum q_i^-, \quad q^0 = \sum q_i^0, \quad q^+ = p^+ + \sum q_i^+$$

and

$$\mu = \mu^1 * \dots * \mu^m$$

where $*$ is the concatenation of partitions from (4.2). We call $\mathcal{L}(Y, X)$ the *local model for Y in the normal directions inside X* .

Example 7.9. In Example 7.2, the origin 0 lives inside the closed stratum $\bar{Z}(0,0,1)$ as $0 \in \mathbb{R}_+$ (a codimension-1 boundary point). However, in our stratified spaces X we will distinguish the points with this model from those in the multifacets $\partial_i X$. The points with the local model $0 \in \bar{Z}(0,0,1)$ will be part of the special boundary of X .

We can now prove the following.

Proposition 7.10. *The stratification of $Z_N \cong \mathbb{R}^{2N-1}$ described in Section 7.2 is a Whitney stratification.*

Proof. Given the local models (7.6) and the fact that products of Whitney stratifications are Whitney (cf. Proposition 6.7), it suffices to consider the origin $0 \in Z_N$, and show that all the bigger strata are Whitney regular over it.

Consider the projection

$$\pi : \mathbb{C}^N \rightarrow Z_N, \quad \pi(z_1, \dots, z_N) = (s_1, \dots, s_N)$$

where s_i are the elementary symmetric polynomials from (7.3). Any stratum $Y \subset Z_N$ is the image under π of a subset of \mathbb{C}^N given by linear equalities and inequalities. Since π is a polynomial mapping, Proposition 6.5 implies that Y is semialgebraic. Proposition 6.6 shows that the bad set $B(\{0\}, Y) \subset \{0\}$ is empty, and therefore Y is Whitney regular over the origin. \square

7.5. More general local models. We now complete the description of the local models that will appear in the stratified spaces in this paper. More generally than Z_N , let $\vec{N} = (N_1, \dots, N_n) \in \mathbb{N}^n$, and consider the space

$$(7.7) \quad Z_{\vec{N}} := (\text{Sym}^{N_1}(\mathbb{C}) \times \dots \times \text{Sym}^{N_n}(\mathbb{C})) / \mathbb{R},$$

where we divided by the diagonal action of \mathbb{R} . This is a Euclidean space, and admits a decomposition into strata

$$Z(\vec{p}^-, \vec{p}^0, \vec{p}^+; \vec{\lambda})$$

where $\vec{p}^* = (p_1^*, \dots, p_n^*)$ for $*$ $\in \{-, 0, +\}$ and $\vec{\lambda} = (\lambda_1, \dots, \lambda_n)$ satisfy

$$p_i^- + p_i^0 + p_i^+ = N_i, \quad \lambda_i \in \text{Part}(p_i^0).$$

Specifically, $Z(\vec{p}^-, \vec{p}^0, \vec{p}^+; \vec{\lambda})$ is given by asking the imaginary parts of the coordinates in each $\text{Sym}^{N_i}(\mathbb{C})$ to consist of p_i^- negative numbers, p_i^0 zeros (with the corresponding real parts decomposed according to the partition λ_i), and p_i^+ positive numbers.

Definition 7.11. The *standard frame* for the normal bundle to a stratum $Z(\vec{p}^-, \vec{p}^0, \vec{p}^+; \vec{\lambda}) \subset Z_{\vec{N}}$ is obtained by concatenating the standard frames for each $Z(p_i^-, p_i^0, p_i^+; \lambda_i) \subset Z_{N_i}$ described in Definition 7.5.

Even more generally, for the local models in Section 8 we will consider products of the ones considered above, as well as half-intervals $[0, \infty)$ that account for the usual (non-special) boundaries of (n) -manifolds, and \mathbb{R} factors that just correspond to some tangent directions inside the stratum. The most general model is of the form

$$(7.8) \quad \mathbb{R}^a \times \mathbb{R}_+^{r-1} \times Z_{\vec{N}_1} \times Z_{\vec{N}_2} \times \dots \times Z_{\vec{N}_r},$$

with the induced product stratification from its factors—where \mathbb{R} has a single stratum, and \mathbb{R}_+ has two strata: $\{0\}$ and $(0, \infty)$. The local models will be based on the strata of this space inside the closures of bigger strata.

Note that we can define tailored local coordinates around any point in (7.8), in a manner similar to what we did for Z_N in Section 7.3.

Definition 7.12. The *standard frame* for the normal bundle to a stratum inside the space (7.8) is obtained by concatenating the standard frames for each of the factors, where for $\{0\} \subset \mathbb{R}^+$ we use the standard unit vector, and for the strata in each $Z_{\vec{N}_i}$ we use the frames from Definition 7.11.

Definition 7.13. Given strata

$$Y, X \subset \mathbb{R}^a \times \mathbb{R}_+^{r-1} \times Z_{\vec{N}_1} \times Z_{\vec{N}_2} \times \cdots \times Z_{\vec{N}_r}$$

with $Y \leq X$, we let the *local model for Y in the normal directions inside X* , denoted $\mathcal{L}(Y; X)$, be the intersection of X with a small ball in the linear subspace spanned by the standard frame for the normal bundle to Y (in tailored local coordinates around any point of Y). The union of $\mathcal{L}(Y; X)$ over all $X \geq Y$ is denoted $\mathcal{L}(Y)$.

Proposition 7.14. *The given stratification of (7.8) is a Whitney stratification.*

Proof. Since the Whitney condition is local, observe that a stratification of a space of the form V/\mathbb{R} (where \mathbb{R} acts freely on V) is Whitney if and only if its pullback to V is Whitney. In Proposition 7.10 we established that the stratification of $Z_N = \text{Sym}^n(\mathbb{C})/\mathbb{R}$ is Whitney. Furthermore, Proposition 6.7 says that the product of Whitney stratifications is Whitney. Combining these facts, we get the conclusion. \square

8. MODULI SPACES

Let us recall some notation from Section 2.1. Let O_1, \dots, O_n and X_1, \dots, X_n be the markings on the grid. For any $D \in \mathcal{D}(x, y)$, let $\mathbb{O}(D) \in \mathbb{Z}^n$ be the vector that records the coefficients of D at the O -markings. We only consider domains that do not go over the last X -marking X_n .

For each j , let H_j , respectively V_j , be the horizontal row, respectively vertical column, that contains O_j . For any x, y , $\mathcal{D}(x, x)$ can be identified with $\mathcal{D}(y, y)$, and we call either \mathcal{P} , the set of periodic domains. Further, we denote by \mathcal{P}^+ the subset consisting of positive periodic domains. We have

$$\mathcal{P} = \mathbb{Z}\langle H_1, \dots, H_{(n-1)}, V_1, \dots, V_{(n-1)} \rangle \quad \mathcal{P}^+ = \mathbb{N}\langle H_1, \dots, H_{(n-1)}, V_1, \dots, V_{(n-1)} \rangle.$$

For every domain $D \in \mathcal{D}^+(x, y)$ and vectors

$$\vec{N} = (N_1, \dots, N_n) \in \mathbb{N}^n,$$

$$\vec{\lambda} = (\lambda_1, \dots, \lambda_n), \lambda_j \in \text{Part}(N_j),$$

we will construct a stratified space

$$\overline{\mathcal{M}}_{\vec{N}, \vec{\lambda}}(D).$$

This will come equipped with an embedding in a Euclidean space, be Whitney stratified and hence (by Theorem 6.16) Thom-Mather stratified. The local models for the stratification will be those considered in Section 7.

The space $\overline{\mathcal{M}}_{\vec{N}, \vec{\lambda}}(D)$ will be a model for the compactified moduli space of pseudo-holomorphic strips in $\text{Sym}^n(T^2)$ relative to $\mathbb{T}_\alpha, \mathbb{T}_\beta$, modulo translation by \mathbb{R} , such that:

- the strips have domain D ;

- each strip is equipped with $|\vec{N}| := N_1 + \cdots + N_n$ marked points on the alpha and beta boundaries, combined into groups of N_j points, $j = 1, \dots, n$, where the points in each group are unordered. The N_j points in the j^{th} group are meant to be the places where a holomorphic α - or β -degeneration (disk) with domain H_j or V_j has bubbled off;
- for each $j = 1, \dots, n$, the N_j points in the j^{th} group are partitioned according to λ_j . Points in the same part of λ_j are supposed to be at the same height on the boundary of the strip.

There is a special case that we will not discuss in this paper, namely when $D = 0$ and $\vec{N} = \vec{0}$. (In that case, the moduli space should be a point divided by a trivial \mathbb{R} action.) From now on we will always assume that at least one of D and \vec{N} is nonzero. Then, the dimension k of $\overline{\mathcal{M}}_{\vec{N}, \vec{\lambda}}(D)$ will given by

$$(8.1) \quad k = \mu(D) - 1 + \sum_{j=1}^n \ell(\lambda_j).$$

As we shall see in later sections, the strata of $\overline{\mathcal{M}}_{\vec{N}, \vec{\lambda}}(D)$ will be products of lower-dimensional moduli spaces, corresponding to trajectory breaking and/or bubbling off further α - and β -degenerations. There will be a single codimension-zero stratum in $\overline{\mathcal{M}}_{\vec{N}, \vec{\lambda}}(D)$, denoted $\mathcal{M}_{\vec{N}, \vec{\lambda}}(D)$. The strata that correspond to some bubbles will comprise what we call the *special boundary* of $\overline{\mathcal{M}}_{\vec{N}, \vec{\lambda}}(D)$.

For simplicity, when $\vec{N} = \vec{0}$, we will write

$$\overline{\mathcal{M}}_0(D) := \overline{\mathcal{M}}_{\vec{0}, \vec{0}}(D).$$

Let us put an equivalence relation on domains by

$$(8.2) \quad D \sim D' \iff (D - D' \in \mathcal{P} \text{ and } \mathbb{O}(D) = \mathbb{O}(D')).$$

Two domains in the same equivalence class differ from each other by a linear combination of $H_j - V_j$, over those indices j such that O_j is neither in the last row nor in the last column.

Note that an equivalence class of domains is specified by the initial and final points of the domain (call them x and y), as well as the vector $\mathbb{O}(D) = (m_1, \dots, m_n)$. The moduli spaces $\overline{\mathcal{M}}_0(D)$, over all D in the same equivalence class, are supposed to glue together along their special boundaries, to produce a single $\langle k \rangle$ -manifold

$$(8.3) \quad \overline{\mathcal{M}}([D]) = \overline{\mathcal{M}}(x, U_1^{m_1} \dots U_n^{m_n} y).$$

The construction of the stratified spaces $\overline{\mathcal{M}}_{\vec{N}, \vec{\lambda}}(D)$ will be given in Sections 12. For now, to help the reader get some intuition, we present some examples of spaces that could *potentially* play the role of $\overline{\mathcal{M}}_{\vec{N}, \vec{\lambda}}(D)$, in a few simple cases. We emphasize that these spaces are not actually what the later constructions will produce. Those constructions will be inductive and hard to make explicit. Rather, the spaces we describe in the examples below satisfy the formal properties of $\overline{\mathcal{M}}_{\vec{N}, \vec{\lambda}}(D)$. Specifically, they have the right dimension, their strata are indexed on the different possibilities for trajectory breaking and bubbles, and the spaces corresponding to D 's in the same equivalence class can be glued together to form $\langle k \rangle$ -manifolds.

Example 8.1. Suppose $D \in \mathcal{D}(x, x)$ is trivial and write $\vec{\lambda} = (\lambda_1, \dots, \lambda_{n-1})$ with $\lambda_j = (\lambda_{j1}, \lambda_{j2}, \dots)$. Then,

$$\overline{\mathcal{M}}_{\vec{N}, \vec{\lambda}}(0) = \overline{\left(\prod_j \text{Sym}^{\ell(\lambda_j)}(\mathbb{R}) \right) / \mathbb{R}},$$

where the compactification is induced from the compactification of \mathbb{R} by $\overline{\mathbb{R}} = \{-\infty\} \cup \mathbb{R} \cup \{+\infty\}$.

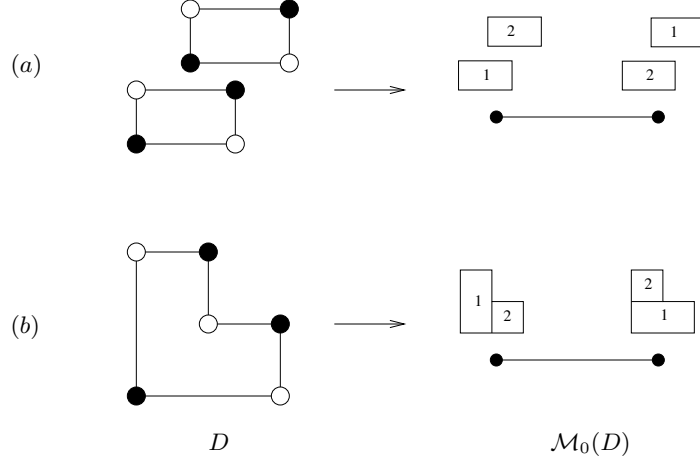

FIGURE 7. Domains of index two on the grid, and the associated moduli spaces $\overline{\mathcal{M}}_0(D)$. On the left hand side, the black dots are part of the initial point x in each domain, and the white dots part of the final point y . The ends of the moduli space correspond to different decompositions $D = D^1 * D^2$. In each picture we indicate D^i with the respective digit $i \in \{1, 2\}$.

Example 8.2. When D is a rectangle and $\vec{N} = 0$, we let $\overline{\mathcal{M}}_0(D)$ be a point.

Example 8.3. Let D be a positive domain of index two on the grid, that is, either: (a) the union of two rectangles or (b) an L-shape, as shown in Figure 7 (possibly rotated). Then $\overline{\mathcal{M}}_0(D)$ is an interval, which can be viewed as a 1-dimensional $\langle 1 \rangle$ -manifold. The two ends correspond to the different ways of splitting D into two domains of index one (trajectory breaking).

Example 8.4. More generally, suppose D is a positive domain of index $k+1$ on a planar $(n-1) \times (n-1)$ grid, so that α - and β -degenerations are impossible. Then $\overline{\mathcal{M}}_0(D)$ is a k -dimensional $\langle k \rangle$ -manifold, with the boundary corresponding to trajectory breaking. The i -colored multifacet $\partial_i(\overline{\mathcal{M}}_0(D))$ (for $i = 1, \dots, k$) corresponds to splittings of D the form $D^1 * D^2$, where $\mu(D^1) = i$ and $\mu(D^2) = k+1-i$. See Figure 8 for a picture of $\overline{\mathcal{M}}_0(D)$ for an index three domain. In general, to an index k domain made of k disjoint rectangles one can associate the k -dimensional permutohedron (cf. Example 5.2). Other types of domains yield other $\langle k \rangle$ -manifolds.

Example 8.5. When H_i is a full row and $N = 0$, we let $\overline{\mathcal{M}}_0(H_i)$ be an interval, where one end corresponds to the decomposition into two rectangles and the other end is the special boundary, corresponding to an α -degeneration. If V_i is the column that contains the same O_i marking as H_i , then $\overline{\mathcal{M}}_0(V_i)$ is another interval. Gluing $\overline{\mathcal{M}}_0(H_i)$ to $\overline{\mathcal{M}}_0(V_i)$ along their special boundaries yields the $\langle 1 \rangle$ -manifold $\overline{\mathcal{M}}([H_i]) = \overline{\mathcal{M}}([V_i])$. See Figure 9.

Example 8.6. Figure 10 shows the spaces $\overline{\mathcal{M}}_0$ for two domains of index three: the column $V_i = C+D$ plus a rectangle C contained it, and the row $H_i = A+B$ plus the disjoint rectangle C . These domains would be glued together to produce the $\langle 2 \rangle$ -manifold $\overline{\mathcal{M}}([A+B+C]) = \overline{\mathcal{M}}([2C+D])$.

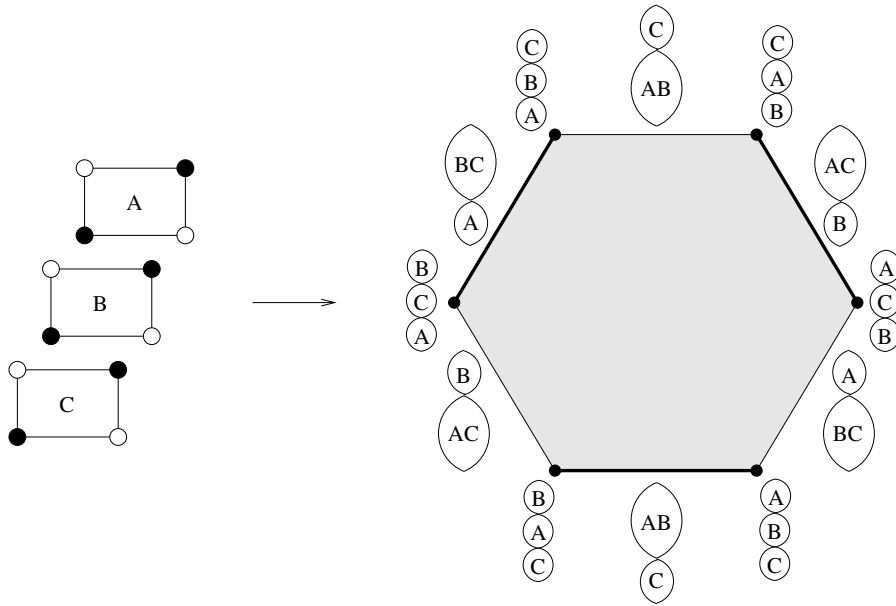

FIGURE 8. A domain of index three on the grid, and the associated moduli spaces $\overline{\mathcal{M}}_0(D)$. For each edge and vertex on the boundary we show the corresponding decomposition $D = D^1 * D^2$ or $D = D^1 * D^2 * D^3$ by a picture of the trajectory breaking. (For example, the bottom edge corresponds to $(A \cup B) * C$.) The multifacet $\partial_1 \overline{\mathcal{M}}_0(D)$ is made of the thin edges, and the multifacet $\partial_2 \overline{\mathcal{M}}_0(D)$ is made of the thick edges.

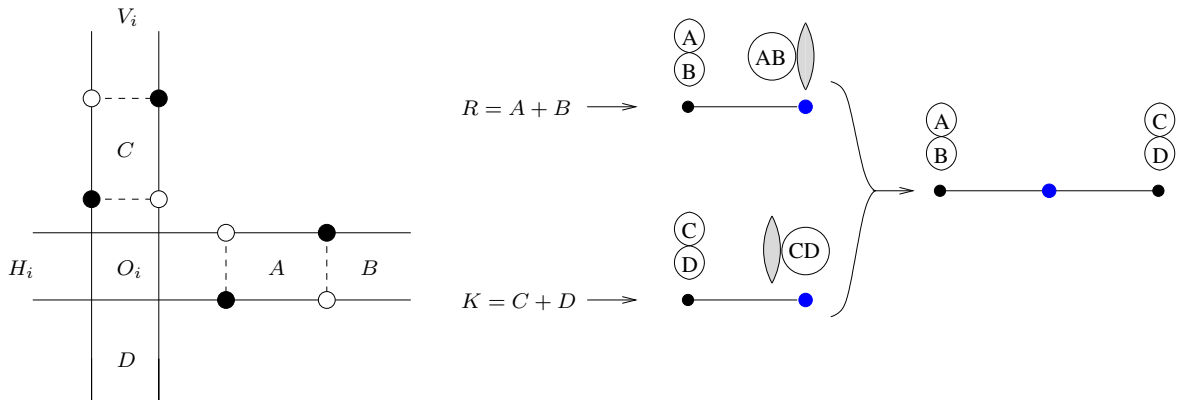

FIGURE 9. Gluing the moduli spaces for the row and the column that contain the same marking O_i . The special boundary points are shown in blue. These blue points are associated to a configuration made of a trivial strip (shown in gray) and a boundary degeneration.

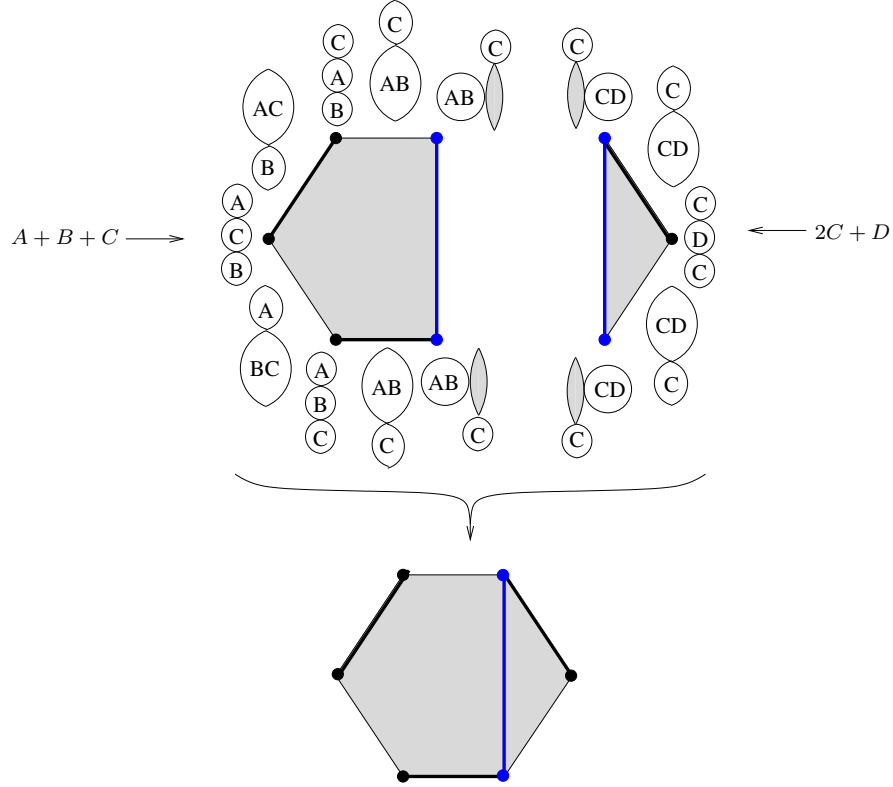

FIGURE 10. For the same picture as on the left of Figure 9, we glue the moduli space for $A + B + C$ to that for $2C + D$. The special boundary is the blue edge. As in Figure 8, the thin edges represent $\partial_1 \overline{\mathcal{M}}_0$, and the thick edges represent $\partial_2 \overline{\mathcal{M}}_0$.

Example 8.7. Suppose we have rows $H_i = A + B$, $H_j = C + D$, as well as columns $V_i = E + F$, $V_j = G + H$ as in Figure 11. Then, the moduli space $\overline{\mathcal{M}}_0(H_i + H_j)$ is shown in Figure 12; those for the domains $H_i + V_j$, $V_i + H_j$ and $V_i + V_j$ are very similar. These four spaces glue together along their special boundaries to form the $\langle 3 \rangle$ -manifold $\overline{\mathcal{M}}_0([H_i + H_j])$, which is a three-dimensional permutohedron. Note that in this gluing, the special edge drawn in green in Figure 12 is common to all four polyhedra.

Remark 8.8. In symplectic geometry we encounter moduli spaces of bubble trees that we do not consider here. For example, in Figure 12 the green edge corresponds to two disk degenerations, and as we move along the edge we change the relative heights where these two degenerations take place. In particular, there is a point in the middle that corresponds to the two degenerations happening at the same height. If we were to actually consider the Gromov compactification from symplectic geometry, instead of that point we would have a whole new (two-dimensional) facet, corresponding to degenerating an index four disk with domain $H_i + H_j = A + B + C + D$, as in Figure 13. Thus, our moduli spaces $\overline{\mathcal{M}}_0$ are only approximations to what actually happens for the moduli spaces of holomorphic strips. Nevertheless, these approximations are sufficient for the purposes of this paper.

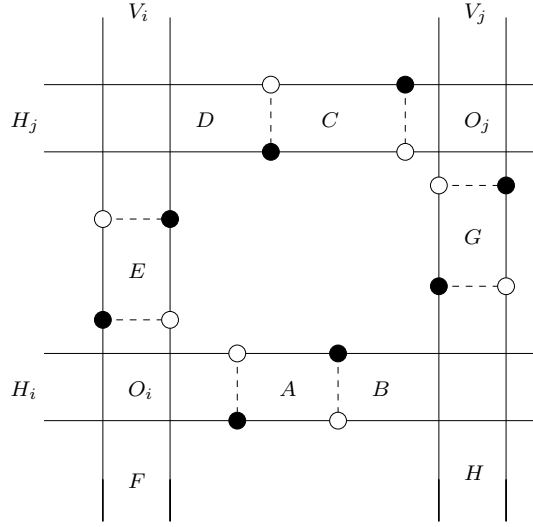

FIGURE 11. Two rows and two columns on the grid.

Example 8.9. Let us now go back to the situation on the left of Figure 9, where $H_i = A + B$ is a row and $V_i = C + D$ is a column. The space $\overline{\mathcal{M}}_0$ for the domain $H_i + V_i = A + B + C + D$ made of a row and a column is shown in Figure 14. In fact, it is almost the same polyhedron as in Figure 12, except that the green edge is folded in half. The folding is due to the fact that since H_i and V_i go through the same O_i marking, we want to identify the AB and CD disk degenerations. Thus, the point on the green edge where the AB degeneration is at a certain distance up from the CD degeneration, is identified with the point where the CD degeneration is on top of AB , at the same distance.

To be more precise, with the notation from Example 8.1, the green line in Figure 12 is the space $\overline{\mathcal{M}}_{\vec{N}, \vec{\lambda}}(0)$ with \vec{N} being the vector with 1's in positions i and j (and 0 otherwise), and $\vec{\lambda}$ the unique possible vector of partitions. This space is the compactification of

$$(\text{Sym}^1(\mathbb{R}) \times \text{Sym}^1(\mathbb{R}))/\mathbb{R},$$

which is just $\overline{\mathbb{R}} = \{-\infty\} \cup \mathbb{R} \cup \{+\infty\}$.

On the other hand, the (folded) green line in Figure 14 is $\overline{\mathcal{M}}_{\vec{N}, \vec{\lambda}}(0)$ with \vec{N} being the vector with a single 2 in position i , and $\vec{\lambda}$ consisting of trivial partitions except for $\lambda_i = (1, 1)$. This is the compactification of

$$\text{Sym}^2(\mathbb{R})/\mathbb{R}.$$

In particular, there is a special point (the left green dot in Figure 14) where the AB and CD degenerations happen at the same height. There, the local model for the space $\overline{\mathcal{M}}_0(H_i + V_i)$ is

$$Z(1, 0, 1) \subset Z_2$$

from Figure 6. The green line corresponds to the thickened line in Figure 6, and the front and right facets in Figure 14 meet along the green line, forming a Whitney umbrella.

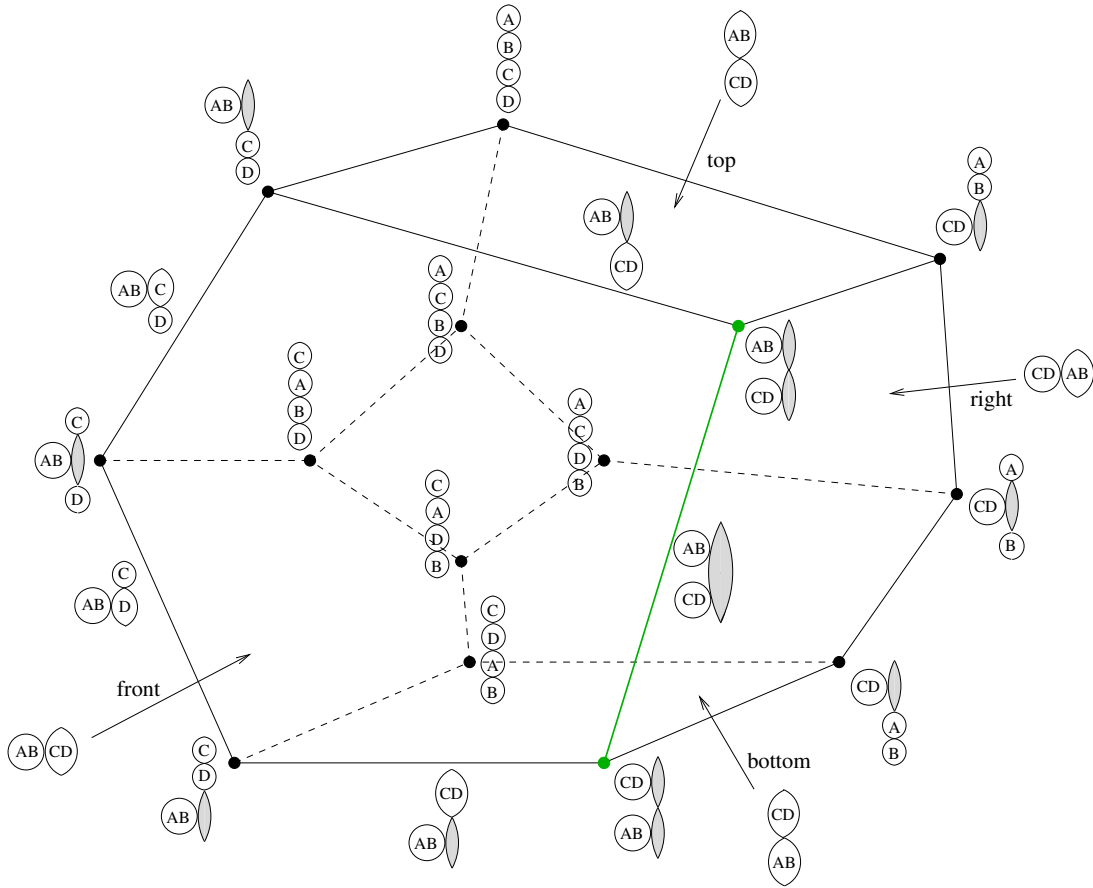

FIGURE 12. For the picture in Figure 11, we show the moduli space for $H_i + H_j = A + B + C + D$. This is a polyhedron with 9 facets; two of these (the front and the right facet) form the special boundary. We show the configurations corresponding to each vertex, and to some of the facets (the top, bottom, right, and front one). We also show the configurations for the five edges along the front facet. (In particular, note that the green edge corresponds to two disk degenerations.) The configurations that correspond to the remaining edges and facets can be easily deduced.

Example 8.10. Again in the situation from the left of Figure 9, we consider the domain $2H_i = 2A + 2B$ (a row with multiplicity two). The corresponding space $\overline{\mathcal{M}}_0(2H_i)$ is pictured in Figure 15. This is glued with a similar space $\overline{\mathcal{M}}_0(2V_i)$, as well as with the space $\overline{\mathcal{M}}_0(H_i + V_i)$ from Example 8.9, to yield a single $\langle 3 \rangle$ -manifold $\overline{\mathcal{M}}_0([2H_i])$. Around the top green dot, the gluing is modeled on the Whitney umbrella from Figure 6, with $\overline{\mathcal{M}}_0(2H_i)$, $\overline{\mathcal{M}}_0(H_i + V_i)$ and $\overline{\mathcal{M}}_0(2V_i)$ playing the roles of $Z(2, 0, 0)$, $Z(1, 0, 1)$ and $Z(0, 0, 2)$, respectively.

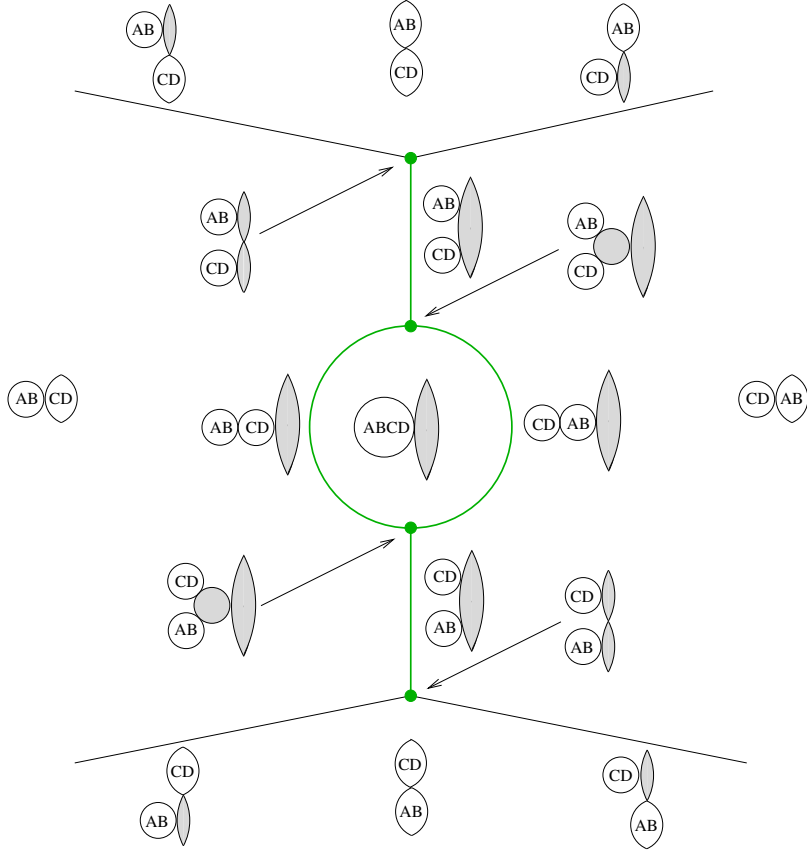

FIGURE 13. If we consider the actual Gromov compactification of the moduli space, then the green edge from Figure 12 gets replaced by more complicated spaces of bubble trees, as shown here.

9. THE STRATIFICATION

We now describe the intended stratification of the spaces $\overline{\mathcal{M}}_{\vec{N}, \vec{\lambda}}(D)$, where

$$\vec{N} = (N_1, \dots, N_n) \in \mathbb{N}^n,$$

$$\vec{\lambda} = (\lambda_1, \dots, \lambda_n), \lambda_j \in \text{Part}(N_j), D \in \mathcal{D}^+(x, y).$$

9.1. **Enumeration of strata.** We ask that $\overline{\mathcal{M}}_{\vec{N}, \vec{\lambda}}(D)$ has the following strata:

$$(9.1) \quad \mathcal{M}_{\vec{N}^1 + \mathbb{O}(E^1) + \mathbb{O}(F^1), \vec{\lambda}^1}(D^1) \times \cdots \times \mathcal{M}_{\vec{N}^r + \mathbb{O}(E^r) + \mathbb{O}(F^r), \vec{\lambda}^r}(D^r),$$

with

$$r \geq 1, \quad x = w_0, w_1, \dots, w_{r-1}, w_r = y,$$

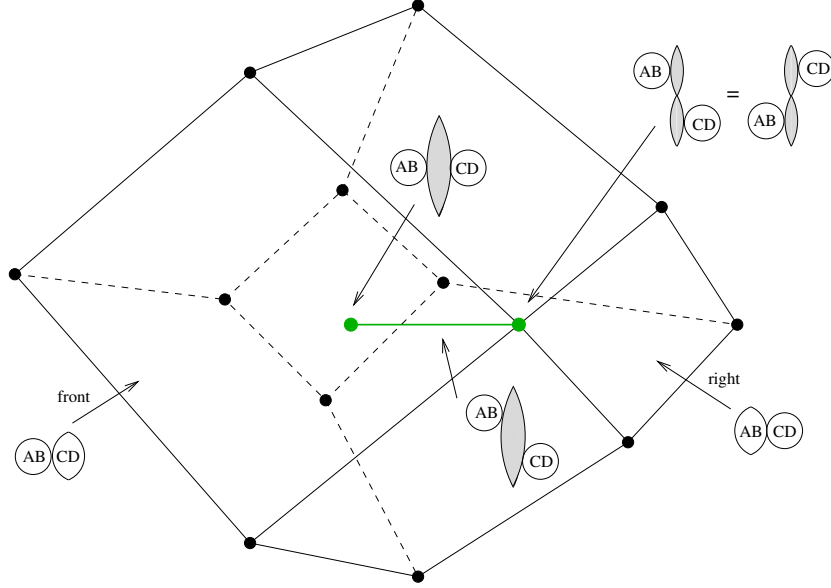

FIGURE 14. The moduli space for $H_i + V_i = A + B + C + D$, where H_i and V_i are as in Figure 9. This is obtained from the polyhedron in Figure 12 by folding the green edge in half. The front, bottom, top and right facets from Figure 12 now meet at a single point (the right green dot). For simplicity, we only show the configurations for the green edge, for its two endpoints, and for the two facets that form the special boundary (the front and the right facet, which meet along the green edge). The other labels are just as in Figure 12, except that the CD disk degenerations are now to the right of the strips. Note that the moduli space shown here is not a convex polyhedron, but rather a stratified space, where the local picture near the left green dot is the Whitney umbrella from Figure 6.

such that for each $1 \leq i \leq r$, we have $D^i \in \mathcal{D}^+(w_{i-1}, w_i)$,

$$E^i = \sum_{j=1}^n O_j(E^i) H_j \in \mathcal{P}^+ \text{ is a sum of rows,}$$

$$F^i = \sum_{j=1}^n O_j(F^i) V_j \in \mathcal{P}^+ \text{ is a sum of columns,}$$

satisfying

$$\sum_i (D^i + E^i + F^i) = D.$$

Note that all the rows contributing to E^i and all the columns contributing to F^j are *allowable* in the sense that they do not contain the forbidden marking X_n ; that is, they cannot be the last row $H_{(n)}$ or the last column $V_{(n)}$.

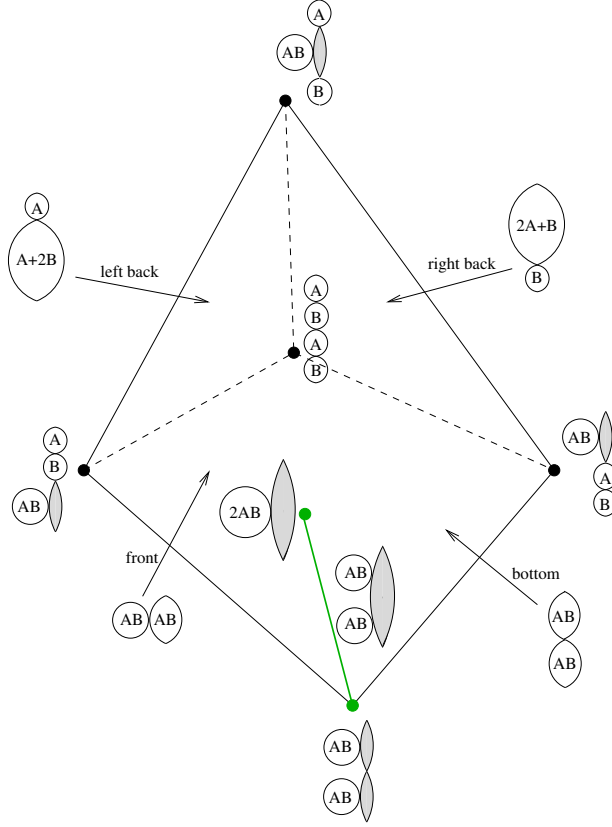

FIGURE 15. The moduli space for $2H_i = 2A + 2B$, where H_i is as in Figure 9. This is obtained from a convex pyramid (with a quadrilateral base) by smoothing along the top half of the front edge, and pulling the midpoint of that edge (the top green dot) outwards, so that the local picture near the top green dot is like $Z(2, 0, 0) \subset Z_2$ from Figure 6. We labeled the configurations corresponding to each vertex and facet, as well as that for the green edge. The labels on the other edges can be easily deduced.

Further,

$$\vec{N}^i = (N_1^i, \dots, N_n^i) \in \mathbb{N}^n, \quad \sum_i \vec{N}^i = \vec{N},$$

and

$$\vec{\lambda}^i = (\lambda_1^i, \dots, \lambda_n^i), \quad \vec{\lambda}_j^i \in \text{Part}(N_j^i + |O_j(E^i)| + |O_j(F^i)|)$$

are such that there exist some other partitions

$$\vec{\eta}^i = (\eta_1^i, \dots, \eta_n^i), \quad \eta_j^i \in \text{Part}(N_j^i)$$

with $\eta_j^i \leq \lambda_j^i$ (in the notation of Section 7) and

$$\eta_j^1 * \dots * \eta_j^r = \lambda_j, \quad j = 1, \dots, n.$$

Here, $*$ is the concatenation of partitions defined in (4.2). Note that, if $\bar{\eta}^i$ exist, then they are unique. This is because an ordered partition can be uniquely (if at all) decomposed as a concatenation of partitions of specified sizes.

A few explanations are in order. In the description of the strata, the D^i 's are the pieces in the trajectory breaking, the E^i 's are supposed to correspond to α -boundary degenerations, and the F^i 's to β -boundary degenerations. The points where the boundary degenerations through O_j are attached were originally partitioned according to λ_j . When the trajectory breaks into r pieces, these points they get split into r groups, where the i th group is partitioned according to η_j^i . Since we also pick up extra boundary degenerations from the E^i and F^i , we should actually add more points. We could also join some of the parts, to make the partition η_j^i coarser, since this is what happens in lower dimensional strata; compare Equations (7.2) and (7.5). The result of this process is the partition $\lambda_j^i \geq \eta_j^i$.

In view of the dimension formula (8.1), the codimension of the stratum described in Equation (9.1) is

$$(9.2) \quad r - 1 + \sum_{j=1}^n \left(\ell(\lambda_j) - \sum_{i=1}^r \ell(\lambda_j^i) \right) = r - 1 + \sum_{i,j} (\ell(\eta_j^i) - \ell(\lambda_j^i)) \geq r - 1.$$

In particular, $\mathcal{M}_{\bar{N}, \bar{\lambda}}(D)$ appears as the unique codimension zero stratum, with $r = 1$, $D^1 = D$, $E^1 = F^1 = 0$.

9.2. Coherence. The strata of $\bar{\mathcal{M}}_{\bar{N}, \bar{\lambda}}(D)$ are required to satisfy the following coherence relations with respect to their closures. Given a stratum as in (9.1), its closure in $\bar{\mathcal{M}}_{\bar{N}, \bar{\lambda}}(D)$ should be the product of the closures of its factors:

$$(9.3) \quad \bar{\mathcal{M}}_{\bar{N}^1 + \mathbb{O}(E^1) + \mathbb{O}(F^1), \bar{\lambda}^1}(D^1) \times \cdots \times \bar{\mathcal{M}}_{\bar{N}^r + \mathbb{O}(E^r) + \mathbb{O}(F^r), \bar{\lambda}^r}(D^r).$$

Further, if for $i = 1, \dots, r$ we have strata

$$\prod_{k=1}^{m_i} \mathcal{M}_{\bar{N}^{i,k} + \mathbb{O}(E^{i,k}) + \mathbb{O}(F^{i,k}), \bar{\lambda}^{i,k}}(D^{i,k}) \subset \bar{\mathcal{M}}_{\bar{N}^i + \mathbb{O}(E^i) + \mathbb{O}(F^i), \bar{\lambda}^i}(D^i)$$

we ask that the inclusion of the product stratum

$$\prod_{k=1}^{m_1} \mathcal{M}_{\bar{N}^{1,k} + \mathbb{O}(E^{1,k}) + \mathbb{O}(F^{1,k}), \bar{\lambda}^{1,k}}(D^{1,k}) \times \cdots \times \prod_{k=1}^{m_r} \mathcal{M}_{\bar{N}^{r,k} + \mathbb{O}(E^{r,k}) + \mathbb{O}(F^{r,k}), \bar{\lambda}^{r,k}}(D^{r,k})$$

into $\bar{\mathcal{M}}_{\bar{N}, \bar{\lambda}}(D)$ factors through (9.3).

9.3. Codimension one strata. For future reference, let us also describe the codimension-one boundary of $\bar{\mathcal{M}}_{\bar{N}, \bar{\lambda}}(D)$. In view of (9.2), this consists of strata of three possible types.

Type I correspond to $r = 2$ and pure trajectory breaking, with no disk degenerations ($E^i = F^i = 0$), and no coarsening of the partitions. We get the following strata:

$$(9.4) \quad \mathcal{M}_{\bar{N}^1, \bar{\lambda}^1}(D^1) \times \mathcal{M}_{\bar{N}^2, \bar{\lambda}^1}(D^2)$$

where

- w is an intermediate generator,
- $D^1 \in \mathcal{D}^+(x, w)$ and $D^2 \in \mathcal{D}^+(w, y)$ are such that $D^1 + D^2 = D$,
- $\bar{N}^1, \bar{N}^2 \in \mathbb{N}^n$ are such that $\bar{N}^1 + \bar{N}^2 = \bar{N}$,
- $\bar{\lambda}^i = (\bar{\lambda}_1^i, \dots, \bar{\lambda}_n^i)$, $i = 1, 2$ are vectors of partitions such that $\bar{\lambda}_j^1 * \bar{\lambda}_j^2 = \bar{\lambda}$ for all $j = 1, \dots, n$.

Note that, among the strata (9.4), the terms where one of the two factors is zero-dimensional are when either D^1 or D^2 is a rectangle, and the partition corresponding to that rectangle is empty:

$$(9.5) \quad \mathcal{M}_{\vec{N}, \vec{\lambda}}(D^1) \times \mathcal{M}_0(R), \quad \text{with } D^1 \in \mathcal{D}^+(x, w), R \in \mathcal{R}(w, y), D^1 + R = D,$$

$$(9.6) \quad \mathcal{M}_0(R) \times \mathcal{M}_{\vec{N}, \vec{\lambda}}(D^2), \quad \text{with } R \in \mathcal{R}(x, w), D^2 \in \mathcal{D}^+(w, y), R + D^2 = D,$$

or when either D^1 or D^2 is constant, with one marking corresponding to a boundary degeneration made of an allowable multiple of a row H_j or allowable multiple of a column V_j , for some j :

$$(9.7) \quad \mathcal{M}_{\vec{N}^1, \vec{\lambda}^1}(D^1) \times \mathcal{M}_{N^2 \vec{e}_j, (N^2)_j}(c_y), \quad \text{with } D^1 + N^2 H_j = D,$$

$$(9.8) \quad \mathcal{M}_{N^1 \vec{e}_j, (N^1)_j}(c_x) \times \mathcal{M}_{\vec{N}^2, \vec{\lambda}^2}(D^2), \quad \text{with } N^1 H_j + D^2 = D,$$

$$(9.9) \quad \mathcal{M}_{\vec{N}^1, \vec{\lambda}^1}(D^1) \times \mathcal{M}_{N^2 \vec{e}_j, (N^2)_j}(c_y), \quad \text{with } D^1 + N^2 V_j = D,$$

$$(9.10) \quad \mathcal{M}_{N^1 \vec{e}_j, (N^1)_j}(c_x) \times \mathcal{M}_{\vec{N}^2, \vec{\lambda}^2}(D^2), \quad \text{with } N^1 V_j + D^2 = D.$$

Here, $c_x \in \mathcal{D}(x, x)$ and $c_y \in \mathcal{D}(y, y)$ denote the trivial domains, and N^1, N^2 (when written without the vector symbols) are natural numbers.

Remark 9.1. We denoted by $(\lambda)_j$ the vector consisting of a partition λ in position j , and trivial partitions elsewhere.

Type II codimension-one strata are those that correspond to no trajectory breaking ($r = 1$) and a single boundary degeneration (with domain an allowable row H_j or an allowable column V_j for some j):

$$(9.11) \quad \mathcal{M}_{\vec{N} + \vec{e}_j, \vec{\lambda}'}(D^1), \quad \text{with } D^1 + H_j = D,$$

$$(9.12) \quad \mathcal{M}_{\vec{N} + \vec{e}_j, \vec{\lambda}'}(D^1), \quad \text{with } D^1 + V_j = D,$$

where

$$\vec{\lambda}' = (\lambda'_1, \dots, \lambda'_n)$$

is such that $\lambda'_j \in \text{UE}(\lambda_j)$, and $\lambda_s = \lambda'_s$ for all $s \neq j$. Here, $\text{UE}(\lambda_j)$ is the set of unit enlargements of λ_j (cf. Definition 4.2).

Type III codimension-one strata are those that correspond to no trajectory breaking ($r = 1$) and no boundary degenerations, but rather an elementary coarsening of a partition λ_j (for some j):

$$(9.13) \quad \mathcal{M}_{\vec{N}, \vec{\lambda}'}(D), \quad \text{with } \vec{\lambda}' = (\lambda'_1, \dots, \lambda'_n),$$

where $\lambda'_j \in \text{EC}(\lambda_j)$, and $\lambda_s = \lambda'_s$ for all $s \neq j$. Here, $\text{EC}(\lambda_j)$ is the set of elementary coarsenings (cf. Definition 4.1).

Remark 9.2. The different types of strata correspond to different kinds of terms in the differential δ on the complex CDP_* ; cf. Section 4.2. Type I strata, where one of the factors is zero dimensional, correspond to terms of δ of types I and IV; precisely, those of type IV come from strata of the form (9.7)–(9.10). Type II corresponds to type II, and type III to type III.

Definition 9.3. Let $X = \overline{\mathcal{M}}_{\vec{N}, \vec{\lambda}}(D)$ be of dimension k . By analogy with the notation for $\langle n \rangle$ -manifolds in Section 5, for $i = 1, \dots, k-1$, we let $\partial_i X$ be the closure of the union of all codimension-one strata of type I of the form

$$\mathcal{M}_{\vec{N}^1, \vec{\lambda}^1}(D^1) \times \mathcal{M}_{\vec{N}^2, \vec{\lambda}^1}(D^2)$$

with

$$\dim \mathcal{M}_{\vec{N}^1, \vec{\lambda}^1}(D^1) = i.$$

We also let the *special boundary* of X , denoted $\partial_s X$, be the closure of the union of all codimension-one strata of types II and III.

It is easy to see that every higher codimension stratum is contained in the closure of a codimension-one stratum. Therefore, altogether, the boundary of X is

$$\partial X = (\partial_1 X \cup \cdots \cup \partial_{k-1} X) \cup \partial_s X.$$

9.4. Local models. Let us describe the local models for how the strata (9.1) should live inside the moduli spaces $\overline{\mathcal{M}}_{\vec{N}, \vec{\lambda}}(D)$. Note that every $\overline{\mathcal{M}}_{\vec{N}, \vec{\lambda}}(D)$ is itself a stratum of a space of the form

$$\overline{\mathcal{M}}_0(\tilde{D}), \text{ with } \tilde{D} = D + \tilde{E} + \tilde{F}, \quad \mathbb{O}(\tilde{E}) + \mathbb{O}(\tilde{F}) = \vec{N}.$$

There are several possible choices of such \tilde{D} , depending on whether we choose rows or columns to go through our fixed O markings. (For example, for the green line in the Whitney umbrella from Figure 9 and 15 we have three such choices.)

The different possible \tilde{D} are in the same equivalence class $[\tilde{D}]$. The union of all these $\overline{\mathcal{M}}_0(\tilde{D})$ forms a space $\overline{\mathcal{M}}([\tilde{D}])$; cf (8.3). The dimension l of each $\overline{\mathcal{M}}_0(\tilde{D})$ is given by

$$(9.14) \quad l = \mu(D) - 1 + 2 \sum_{j=1}^n N_j.$$

We call l the *thick dimension* of $\overline{\mathcal{M}}_{\vec{N}, \vec{\lambda}}(D)$ and denote it by $\text{tdim } \overline{\mathcal{M}}_{\vec{N}, \vec{\lambda}}(D)$.

Recall from Section 6.2 that if we specify a tubular neighborhood T_X of a stratum X inside a stratified space, the tubular neighborhoods $T_{X,Y}$ of X inside other strata Y are just given by intersecting T_X with Y . Thus, to understand the local model of a stratum inside $\overline{\mathcal{M}}_{\vec{N}, \vec{\lambda}}(D)$, it suffices to consider its local model inside the bigger space $\overline{\mathcal{M}}_0(\tilde{D})$.

We ask that the local model in the normal directions for

$$\mathcal{M}_{\vec{N}^1 + \mathbb{O}(E^1) + \mathbb{O}(F^1), \vec{\lambda}^1}(D^1) \times \cdots \times \mathcal{M}_{\vec{N}^r + \mathbb{O}(E^r) + \mathbb{O}(F^r), \vec{\lambda}^r}(D^r)$$

inside $\overline{\mathcal{M}}_0(\tilde{D})$ is the same as the local model for

$$\mathbb{R}^{\sum \mu(D^i) - r} \times \{0\} \times Z(0, \vec{N}^1 + \mathbb{O}(E^1) + \mathbb{O}(F^1), 0; \vec{\lambda}^1) \times \cdots \times Z(0, \vec{N}^r + \mathbb{O}(E^r) + \mathbb{O}(F^r), 0; \vec{\lambda}^r)$$

inside

$$\mathbb{R}^{\sum \mu(D^i) - r} \times \mathbb{R}_+^{r-1} \times \overline{Z}(\mathbb{O}(E^1) + \mathbb{O}(\tilde{E}^1), 0, \mathbb{O}(F^1) + \mathbb{O}(\tilde{F}^1)) \times \cdots \times \overline{Z}(\mathbb{O}(E^r) + \mathbb{O}(\tilde{E}^r), 0, \mathbb{O}(F^r) + \mathbb{O}(\tilde{F}^r)),$$

in the notation of Section 7.5. Here, \tilde{E}^i is a sum of allowable rows and \tilde{F}^i is a sum of allowable columns such that

$$\mathbb{O}(\tilde{E}^i) + \mathbb{O}(\tilde{F}^i) = \vec{N}^i, \quad \sum \tilde{E}^i = \tilde{E}, \quad \sum \tilde{F}^i = \tilde{F}.$$

We will come back to these local models in Section 10, when we will describe neat embeddings of our moduli spaces.

10. EMBEDDINGS AND FRAMINGS

The moduli spaces $\overline{\mathcal{M}}_{\vec{N}, \vec{\lambda}}(D)$ will come equipped with suitable embeddings in

$$\mathbb{E}_l^d := \mathbb{R}^d \times \mathbb{R}_+ \times \mathbb{R}^d \times \mathbb{R}_+ \times \cdots \times \mathbb{R}_+ \times \mathbb{R}^d \cong \mathbb{R}^{d(l+1)} \times \mathbb{R}_+^l$$

and they will also be framed. Here, $d \gg 0$ is a constant depending only on the grid \mathbb{G} , whereas $l = \text{tdim } \overline{\mathcal{M}}_{\vec{N}, \vec{\lambda}}(D)$ is the thick dimension given by the formula (9.14). Note that \mathbb{E}_l^d is $\mathbb{E}(d(l+1), l)$ in the notation of Section 5.2.

10.1. Neat embeddings of stratified spaces. In this section we will describe the required properties for the embedding of $X = \overline{\mathcal{M}}_{\vec{N}, \vec{\lambda}}(D) \hookrightarrow \mathbb{E}_l^d$ that we plan to construct. By analogy with Section 5.2, an embedding with these properties will be called *neat*. We assume that the strata of X are as described in Section 9.

Definition 10.1. A *neat embedding* of $X = \overline{\mathcal{M}}_{\vec{N}, \vec{\lambda}}(D)$ into \mathbb{E}_l^d consists of the following data:

- a $\langle l \rangle$ -manifold U , called a *thickening* of X ,
- a topological embedding $X \hookrightarrow U$, which is a smooth embedding when restricted to every open stratum; and
- a neat embedding $U \hookrightarrow \mathbb{E}_l^d$,

such that, after identifying spaces with their images under these embeddings, for every x in the stratum

$$Y = \mathcal{M}_{\vec{N}^1 + \mathbb{O}(E^1) + \mathbb{O}(F^1), \vec{\lambda}^1}(D^1) \times \cdots \times \mathcal{M}_{\vec{N}^r + \mathbb{O}(E^r) + \mathbb{O}(F^r), \vec{\lambda}^r}(D^r)$$

there is a neighborhood U_x of x in U and a neat embedding ι_x of

$$\mathbb{R}^{\sum \mu(D^i)} \times \mathbb{R}_+^{r-1} \times Z_{\vec{N}^1 + \mathbb{O}(E^1) + \mathbb{O}(F^1)} \times \cdots \times Z_{\vec{N}^r + \mathbb{O}(E^r) + \mathbb{O}(F^r)}$$

into \mathbb{E}_l^d such that:

- the image of ι_x is U_x ;
- the preimage of $U_x \cap Y$ under ι_x is $\mathbb{R}^{\sum \mu(D^i)} \times \{0\} \times Z(0, \vec{N}^1 + \mathbb{O}(E^1) + \mathbb{O}(F^1), 0; \vec{\lambda}^1) \times \cdots \times Z(0, \vec{N}^r + \mathbb{O}(E^r) + \mathbb{O}(F^r), 0; \vec{\lambda}^r)$;
- more generally, we have the following condition on the compatibility of strata:

Let

$$Y^\dagger = \mathcal{M}_{\vec{N}^{1\dagger} + \mathbb{O}(E^{1\dagger}) + \mathbb{O}(F^{1\dagger}), \vec{\lambda}^{1\dagger}}(D^{1\dagger}) \times \cdots \times \mathcal{M}_{\vec{N}^{s\dagger} + \mathbb{O}(E^{s\dagger}) + \mathbb{O}(F^{s\dagger}), \vec{\lambda}^{s\dagger}}(D^{s\dagger})$$

be any stratum of \overline{X} whose closure contains Y . Here

$$\begin{aligned} \vec{N}^{1\dagger} &= \vec{N}^1 + \cdots + \vec{N}^{r_1}, \\ \vec{N}^{2\dagger} &= \vec{N}^{r_1+1} + \cdots + \vec{N}^{r_2}, \\ &\dots \\ \vec{N}^{s\dagger} &= \vec{N}^{r_{s-1}+1} + \cdots + \vec{N}^{r_s} \end{aligned}$$

for some $r_1 < r_2 < \cdots < r_s = r$. Then, we ask that the preimage of $U_x \cap Y^\dagger$ under ι_x is

$$\begin{aligned} &\mathbb{R}^{\sum \mu(D^i)} \times (0, \infty)^{r_1-1} \times \{0\} \times (0, \infty)^{r_2-1} \times \{0\} \times \cdots \times \{0\} \times (0, \infty)^{r_s-1} \times \\ &\bigcup \left(Z(\mathbb{O}(E^1) - \mathbb{O}(G^1), \vec{N}^1 + \mathbb{O}(G^1) + \mathbb{O}(H^1), \mathbb{O}(F^1) - \mathbb{O}(H^1); \vec{\eta}^1) \times \cdots \times \right. \\ &\quad \left. Z(\mathbb{O}(E^r) - \mathbb{O}(G^r), \vec{N}^r + \mathbb{O}(G^r) + \mathbb{O}(H^r), \mathbb{O}(F^r) - \mathbb{O}(H^r); \vec{\eta}^r) \right), \end{aligned}$$

where the union is over all possible choices of periodic domains $G^1, \dots, G^r, H^1, \dots, H^r$ such that

$$G^{r_{i-1}+1} + \dots + G^{r_i} = E^{i\ddagger},$$

$$H^{r_{i-1}+1} + \dots + H^{r_i} = F^{i\ddagger},$$

for $i = 1, \dots, s$. In the above, the vectors of partitions

$$\vec{\eta}^1 = (\eta_1^1, \dots, \eta_m^1), \dots, \vec{\eta}^r = (\eta_1^r, \dots, \eta_n^r)$$

are determined by the concatenation relations

$$\eta_j^{r_{i-1}+1} * \dots * \eta_j^{r_i} = \lambda_j^i,$$

for $i = 1, \dots, s$ and $j = 1, \dots, n$, where $\vec{\lambda}^i = (\lambda_1^i, \dots, \lambda_n^i)$.

Remark 10.2. Since each $Z_{\vec{N}^i + \mathbb{O}(E^i) + \mathbb{O}(F^i)}$ is a Euclidean space (cf. Section 7.5), we see that

$$\mathbb{R}^{\sum \mu(D^i)} \times \mathbb{R}_+^{r-1} \times Z_{\vec{N}^1 + \mathbb{O}(E^1) + \mathbb{O}(F^1)} \times \dots \times Z_{\vec{N}^r + \mathbb{O}(E^r) + \mathbb{O}(F^r)}$$

is an $\langle r-1 \rangle$ -manifold. We can view it as an $\langle l \rangle$ -manifold as in Remark 5.3, using the injection

$$\{1, \dots, r-1\} \rightarrow \{1, \dots, l\}, \quad j \mapsto \sum_{i=1}^j \text{tdim } \mathcal{M}_{\vec{N}^i + \mathbb{O}(E^i) + \mathbb{O}(F^i), \vec{\lambda}^i}(D^i).$$

With that in mind, when we ask for ι_x to be a neat embedding, we mean this in the sense of Definition 5.4.

Remark 10.3. Definition 10.1 is inspired from the local models presented in Section 9.4. The thickening U corresponds to a “tubular” neighborhood of X in the larger space $\overline{\mathcal{M}}([\tilde{D}])$, where $\tilde{D} = D + \tilde{E} + \tilde{F}$ is as in Section 9.4. One difference is that the ambient local model we wrote in that section was based on

$$\mathbb{R}^{\sum \mu(D^i)} \times \mathbb{R}_+^{r-1} \times \overline{Z}(\mathbb{O}(E^1) + \mathbb{O}(\tilde{E}^1), 0, \mathbb{O}(F^1) + \mathbb{O}(\tilde{F}^1)) \times \dots \times \overline{Z}(\mathbb{O}(E^r) + \mathbb{O}(\tilde{E}^r), 0, \mathbb{O}(F^r) + \mathbb{O}(\tilde{F}^r)),$$

which is a codimension zero stratum of the $\langle r-1 \rangle$ -manifold

$$\mathbb{R}^{\sum \mu(D^i)} \times \mathbb{R}_+^{r-1} \times Z_{\vec{N}^1 + \mathbb{O}(E^1) + \mathbb{O}(F^1)} \times \dots \times Z_{\vec{N}^r + \mathbb{O}(E^r) + \mathbb{O}(F^r)}.$$

Here we use the $\langle r-1 \rangle$ -manifold itself, so that we can employ our already-defined concept of neat embedding for such a space. In other words, we look at the local model for X inside $\overline{\mathcal{M}}([\tilde{D}])$ instead of $\overline{\mathcal{M}}_0(\tilde{D})$.

We will have two notions of (normal) framings of the moduli space $\overline{\mathcal{M}}_{\vec{N}, \vec{\lambda}}(D)$ inside \mathbb{E}_l^d . Here is the simplest one.

Definition 10.4. Suppose we have a neat embedding of $X = \overline{\mathcal{M}}_{\vec{N}, \vec{\lambda}}(D)$ into \mathbb{E}_l^d , with associated thickening U . An *external framing* of X is a framing of the normal bundle to U in \mathbb{E}_l^d ; in other words, a smoothly varying, ordered basis for a complement of TU in $T\mathbb{E}_l^d$ (cf. Convention 7.4).

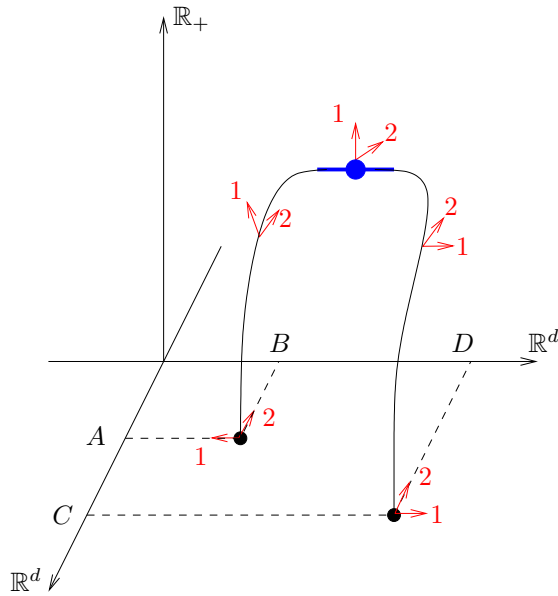

FIGURE 16. Neat embeddings for the moduli spaces in Figure 9. The blue interval is the thickening of the blue dot. The two red arrows (ordered as 1 and 2) indicate the external framings.

10.2. Examples.

Example 10.5. If $X = \mathcal{M}_0(D)$ and D does not contain any row or column (as in Example 8.4), then X is a $\langle k \rangle$ -manifold, the thickening U is just X itself, and the notion of neat embedding coincides with that for $\langle k \rangle$ -manifolds given in Section 5.2. For example, the hexagon moduli space from Figure 8 is a $\langle 2 \rangle$ -manifold, and Figure 3 shows a neat embedding of that hexagon. The procedure we will use in Section 12 to construct such a neat embedding will be as follows. We start by choosing embeddings of the zero-dimensional moduli spaces $\mathcal{M}_0(A)$, $\mathcal{M}_0(B)$, and $\mathcal{M}_0(C)$ in \mathbb{R}^d . The six black dots on the \mathbb{R}^{3d} line are products of these moduli spaces, corresponding to permutations in the order in which they appear as vertices in Figure 8:

$$\mathcal{M}_0(A) \times \mathcal{M}_0(B) \times \mathcal{M}_0(C), \quad \mathcal{M}_0(A) \times \mathcal{M}_0(C) \times \mathcal{M}_0(B), \dots$$

We will then construct neat embeddings of the one-dimensional moduli spaces $\mathcal{M}_0(A+B)$, $\mathcal{M}_0(B+C)$ and $\mathcal{M}_0(A+C)$ in $\mathbb{R}^{2d} \times \mathbb{R}_+$. By taking products of the zero- and one-dimensional moduli spaces we get neat embeddings of the edges of the hexagon. Finally, we fill in the hexagon.

Example 10.6. In Figure 16, we show neat embeddings for the moduli spaces from Figure 9, corresponding to the row $R = A + B$ and the column $K = C + D$. The two are glued at the blue point $x = \overline{\mathcal{M}}_{1,(1)}(0)$ where we also specify a thickening of that point (the blue interval). We give external framings to the moduli spaces.

Example 10.7. In Figure 17 we show a neat embedding for the moduli space $\overline{\mathcal{M}}_0(2C + D)$ from Figure 10, together with an external framing. For simplicity, we do not draw the thickenings. Half of the thickening of the special (blue) boundary would be a tubular neighborhood of that

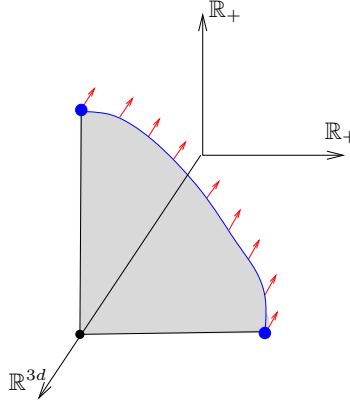

FIGURE 17. A neat embedding for the triangular moduli space from the right hand side of Figure 10. The red arrows indicate the external framing.

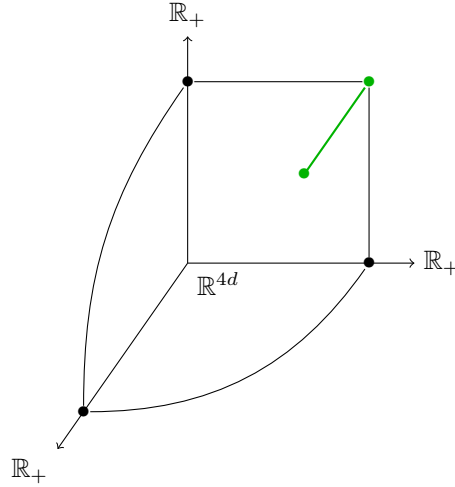

FIGURE 18. A neat embedding for the front facet of the moduli space shown in Figure 14.

boundary inside the moduli space $\overline{\mathcal{M}}_0(2C + D)$. The other half of the thickening would be a tubular neighborhood of the blue edge inside the moduli space $\overline{\mathcal{M}}_0(A + B + C)$ from Figure 10.

Example 10.8. In Figure 18 we show a neat embedding for the front facet of Figure 14, that is, the moduli space for a strip CD with the disk AB attached.

10.3. Internal framings. We now discuss the second notion of framing for the moduli spaces.

Definition 10.9. Suppose we have a neat embedding of $X = \overline{\mathcal{M}}_{\vec{N}, \vec{\lambda}}(D)$ into \mathbb{E}_I^d , with associated thickening U . Let

$$Y = \mathcal{M}_{\vec{N}^1 + \mathcal{O}(E^1) + \mathcal{O}(F^1), \vec{\lambda}^1}(D^1) \times \cdots \times \mathcal{M}_{\vec{N}^r + \mathcal{O}(E^r) + \mathcal{O}(F^r), \vec{\lambda}^r}(D^r)$$

be a stratum of X . An *internal framing* of Y is defined to be a framing of the normal bundle to Y in U .

Note that the internal framings are defined separately on the open strata. In fact, different strata have different dimensions, and therefore the framings consist of a different numbers of vectors. Nevertheless, we can define a notion of internal framing for the whole compactified moduli space X by asking for the internal framings to satisfy certain compatibility relations, based on the local models from Section 7.3.

Definition 10.10. Suppose we have a neat embedding of $X = \overline{\mathcal{M}}_{\vec{N}, \vec{\lambda}}(D)$ into \mathbb{E}_l^d , with associated thickening U . An *internal framing* of X consists of internal framings for all the strata $Y \subset X$, as in Definition 10.9, with the following property: Near every $x \in X$ there exists an embedding ι_x as in Definition 10.1 such that the pullback of the internal framings at the points in $U_x \cap X$ produce the standard frames from Definition 7.12.

11. THE EMBEDDED FRAMED COBORDISM GROUP

The obstruction classes that we will define during the construction will naturally live inside a group

$$\tilde{\Omega}_{\text{fr}}^k = \text{colim}_m \tilde{\Omega}_{\text{fr}, m}^k,$$

which we call the *embedded framed cobordism group*.

Recall that the usual framed cobordism group

$$\Omega_{\text{fr}}^k = \text{colim}_m \Omega_{\text{fr}, m}^k$$

is defined as follows: the elements of $\Omega_{\text{fr}, m}^k$ are the equivalence classes of closed k -dimensional manifolds M embedded in \mathbb{R}^m , together with a framing of the normal bundle; the equivalence relation is given by framed cobordisms in $\mathbb{R}^m \times [0, 1]$; and the group structure is $[M_1] + [M_2] = [M \amalg M'_2]$, where M'_2 is a sufficiently large translation of M_2 . There is a natural map $\sigma : \Omega_{\text{fr}, m}^k \rightarrow \Omega_{\text{fr}, m+1}^k$, and Ω_{fr}^k is the colimit.

The group $\tilde{\Omega}_{\text{fr}, m}^k$ is defined similarly to $\Omega_{\text{fr}, m}^k$, except we require the framed cobordisms to also be embedded in \mathbb{R}^m . More precisely:

- (Ω -1) The elements of $\tilde{\Omega}_{\text{fr}, m}^k$ are the equivalence classes of closed k -dimensional manifolds M embedded in \mathbb{R}^m , together with a vector field \vec{v} (in \mathbb{R}^m) along M which is everywhere transverse to TM , and a framing of an $(m - k - 1)$ -dimensional complement of $TM \oplus \langle \vec{v} \rangle$. We assume $m \geq 2k + 3$. (Also, we will always follow Convention 7.4: framings are not necessarily orthonormal, and complements are not necessarily orthogonal.)
- (Ω -2) The equivalence relation stipulates $(M_1, \vec{v}_1) \sim (M_2, \vec{v}_2)$ if there is an embedded framed cobordism in \mathbb{R}^m from M_1 to M'_2 , which starts in the direction of \vec{v}_1 and ends in the direction of $-\vec{v}_2$. Here, M'_2 is a translation of M_2 in a generic direction so that $M_1 \cap M'_2 = \emptyset$. We call a direction $\vec{e} \in S^{m-1}$ *generic for (M, \vec{v})* if the projection $\pi : \mathbb{R}^m \rightarrow \mathbb{R}^{m-1}$ to the hyperplane perpendicular to \vec{e} sends M diffeomorphically unto an embedded submanifold of \mathbb{R}^{m-1} and \vec{v} to a vector field in \mathbb{R}^{m-1} along $\pi(M)$ which is everywhere transverse to the tangent space of $\pi(M)$. (A standard application of Sard's lemma shows that if $m \geq 2k + 2$, then non-generic directions constitute a measure zero subset of S^{m-1} .)
- (Ω -3) The group structure on $\tilde{\Omega}_{\text{fr}}^k$ is given by $[(M_1, \vec{v}_1)] + [(M_2, \vec{v}_2)] = [(M_1, \vec{v}_1) \amalg (M'_2, \vec{v}_2)]$, where M'_2 is a translation of M_2 in a generic direction, as above.

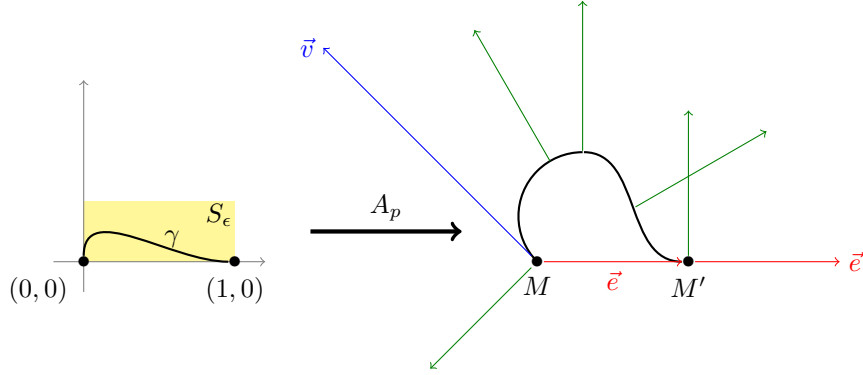

FIGURE 19. A picture illustrating the proof of Lemma 11.1; the notation is same from the lemma. The vector \vec{e} is shown in red, the vector field \vec{v} is shown in blue, and the normal framings are shown in green.

(Ω -4) The zero element is the empty submanifold, and negation is given by reversing \vec{v} , that is, $-[(M, \vec{v})] = [(M, -\vec{v})]$.

The above definition deserves some justification, specifically to show that \sim defines a well-defined equivalence relation, and that $(M, -\vec{v})$ is the inverse of (M, \vec{v}) . The following lemmas are key.

Lemma 11.1. *Consider a framed (M, \vec{v}) as above and let \vec{e} be a generic direction for (M, \vec{v}) . Let M' denote a pushoff in the direction of \vec{e} . Then there is an embedded framed cobordism (as described in Item (Ω -2)) from (M, \vec{v}) to (M', \vec{e}) , for some normal framing of (M', \vec{e}) .*

Proof. By rescaling if necessary, we can assume the pushoff M' of M is by the unit vector \vec{e} .

Fix a smooth embedding $\gamma : [0, 1] \rightarrow \mathbb{R}^2$ such that

$$\gamma(0) = (0, 0), \quad \gamma(1) = (1, 0), \quad \gamma'(0) = (0, 1), \quad \gamma'(1) = (0, 1)$$

and such that the image of γ is contained in the strip $S_\epsilon = [0, 1] \times [0, \epsilon]$, for $\epsilon > 0$ small.

For every $p \in M$, let $V_p = \text{Span}(\vec{e}, \vec{v}_p)$ and let $A_p : \mathbb{R}^2 \rightarrow V_p$ be the linear isomorphism that takes $(1, 0)$ to \vec{e} and $(0, 1)$ to \vec{v}_p . If ϵ is sufficiently small, the genericity condition on \vec{e} guarantees that the union of all $p + A_p(S_\epsilon)$ forms a smoothly embedded bundle over M , with fiber S_ϵ . Then, the map

$$f : [0, 1] \times M \rightarrow \mathbb{R}^m, \quad f(t, p) = p + A_p \circ \gamma(t)$$

describes a smoothly embedded cobordism S from (M, \vec{v}) to (M', \vec{e}) . We can also choose a normal framing on this cobordism, which agrees with the given framing at (M, \vec{v}) . Figure 19 illustrates the proof. \square

Lemma 11.2. *As in Lemma 11.1, consider (M, \vec{v}) , a generic direction \vec{e} for (M, \vec{v}) , and a pushoff M' in the direction of \vec{e} . Then there is an embedded framed cobordism from (M, \vec{v}) to (M', \vec{v}) (as described in Item (Ω -2)), with the normal framing on (M', \vec{v}) the same as the given normal framing on (M, \vec{v}) .*

Proof. Let N be another pushoff of M in the direction of \vec{e} ; assume this pushoff is much smaller compared to the given pushoff M' . Let N' be the symmetric pushoff of M' in the direction of $-\vec{e}$. By Lemma 11.1, there is an embedded framed cobordism F from (M, \vec{v}) to (N, \vec{e}) , for some normal

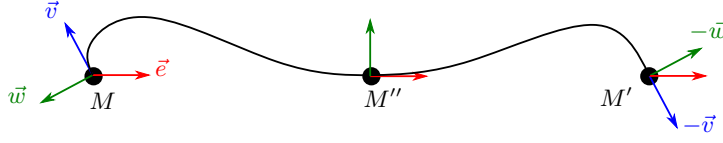

FIGURE 20. The cobordism in Lemma 11.3.

framing of (N, \vec{e}) . Consider the symmetric cobordism F' from $(M', -\vec{v})$ to $(N', -\vec{e})$, and view it as a cobordism from (N', \vec{e}) to (M', \vec{v}) . The framing of F induces a framing of F' by symmetry; in particular, the normal framings on (N, \vec{e}) and (N', \vec{e}) agree, and the normal framings on (M, \vec{v}) and (M', \vec{v}) agree.

Simply by translating along the \vec{e} direction, we get an embedded framed cobordism S from (N, \vec{e}) to (N', \vec{e}) . Then the union $F \cup S \cup F'$ is a framed cobordism from (M, \vec{v}) to (M', \vec{v}) as required. \square

Lemma 11.3. *Given a framed (M, \vec{v}) with a generic direction \vec{e} , let M' be a pushoff of M in the direction of \vec{e} , and let $(-M', -\vec{v})$ be obtained from $(M', -\vec{v})$ by changing the sign of one of the framing vectors. Then, there exists an embedded framed cobordism from (M, \vec{v}) to $(-M', -\vec{v})$.*

Proof. Note that when flowing M we are allowed to continuously deform its framing. Thus, without loss of generality, we can assume that one of the framing vectors of M , call it \vec{w} , lies in the plane spanned by \vec{e} and \vec{v} ; in fact, we can assume it to be perpendicular to \vec{v} in that plane.

Let M'' be a smaller pushoff of M in the direction of \vec{e} , so that M'' is intermediate between M and M' . Consider the cobordism S from (M, \vec{v}) to (M'', \vec{e}) defined in Lemma 11.1, and compose it with the reverse of the cobordism from (M', \vec{v}) to $(M'', -\vec{e})$, provided by the same lemma. Altogether, we get a cobordism from (M, \vec{v}) to $(M', -\vec{v})$. Furthermore, we can choose one of the vector fields in the framing to be perpendicular to S in the plane spanned by \vec{v} and \vec{e} , and let the other vectors stay constant. Following the framing, we see that the distinguished framing vector \vec{w} gets turned into $-\vec{w}$; see Figure 20. Thus, when taking into account the framing, the end of the cobordism is $(-M', -\vec{v})$. \square

Armed with these lemmas, we can prove:

Proposition 11.4. *Items $(\Omega-1)$ - $(\Omega-4)$ make $\tilde{\Omega}_{\text{fr}, m}^k$ into a well-defined Abelian group.*

Proof. Let us start by showing that the relation \sim is well-defined, i.e., it does not depend on which translation we choose in $(\Omega-2)$. Consider (M, \vec{v}) and (N, \vec{w}) , and assume there is an embedded framed cobordism S from (M, \vec{v}) to (N', \vec{w}) for some generic pushoff N' . If N'' is another generic pushoff, then by Lemma 11.2, there are embedded framed cobordisms F from (N', \vec{w}) to (N, \vec{w}) and F' from (N, \vec{w}) to (N'', \vec{w}) . The union $S \cup F \cup F'$ then is an immersed framed cobordism from (M, \vec{v}) to (N'', \vec{w}) . However, since we assumed $m \geq 2k + 3$, by perturbing the cobordism in the interior, we may assume it is embedded.

The proof that the relation \sim is transitive is similar to the above argument. The statement that \sim is reflexive is same as the statement that $(M, -\vec{v})$ is the inverse of (M, \vec{v}) , and it is Lemma 11.2. To see that \sim is symmetric, note that if $(M, \vec{v}) \sim (N, \vec{w})$, by reversing the cobordism and its framing we get that $(-N, -\vec{w}) \sim (-M, -\vec{v})$; applying Lemma 11.3, we deduce that $(N, \vec{w}) \sim (M, \vec{v})$.

It is also not hard to check that the group operation $[(M_1, \vec{v}_1)] + [(M_2, \vec{v}_2)] = [(M_1, \vec{v}_1) \amalg (M_2, \vec{v}_2)]$ is well-defined, and commutative. \square

There is a natural stabilization map

$$(11.1) \quad \sigma : \tilde{\Omega}_{\text{fr},m}^k \rightarrow \tilde{\Omega}_{\text{fr},m+1}^k$$

defined as follows. Given (M, \vec{v}) inside \mathbb{R}^m along with a normal framing $\langle \vec{w}_1, \dots, \vec{w}_{m-k-1} \rangle$, consider it as an element of $\tilde{\Omega}_{\text{fr},m+1}^k$ by considering $M \times \{0\}$ inside $\mathbb{R}^m \times \{0\} \subset \mathbb{R}^{m+1}$, using the same vector field \vec{v} , and using the normal framing $\langle \vec{w}_1, \dots, \vec{w}_{m-k-1}, \vec{e} \rangle$, where \vec{e} is the positive unit normal vector in the new \mathbb{R} direction.

We define $\tilde{\Omega}_{\text{fr}}^k$ to be the colimit of the groups $\tilde{\Omega}_{\text{fr},m}^k$ under the maps $\tilde{\Omega}_{\text{fr},m}^k \rightarrow \tilde{\Omega}_{\text{fr},m+1}^k$. It is worth comparing this new group $\tilde{\Omega}_{\text{fr}}^k = \text{colim}_m \tilde{\Omega}_{\text{fr},m}^k$ with the usual framed cobordism group $\Omega_{\text{fr}}^k = \text{colim}_m \Omega_{\text{fr},m}^k$.

Proposition 11.5. *The groups $\tilde{\Omega}_{\text{fr}}^k$ and Ω_{fr}^k are isomorphic.*

We first need another lemma.

Lemma 11.6. *Consider a framed (M, \vec{v}) as in the definition of $\tilde{\Omega}_{\text{fr},m}^k$, and let \vec{w} be one of the vector fields in the framing of M . Let $(M, -\vec{w})$ be framed by replacing the vector field \vec{w} with \vec{v} . Then, (M, \vec{v}) and $(M, -\vec{w})$ map to the same element under the stabilization map $\tilde{\Omega}_{\text{fr},m}^k \rightarrow \tilde{\Omega}_{\text{fr},m+1}^k$. Hence, (M, \vec{v}) and $(M, -\vec{w})$ represent the same element in $\tilde{\Omega}_{\text{fr}}^k$.*

Proof. Let \vec{e} be the new unit coordinate vector in \mathbb{R}^{m+1} , normal to \mathbb{R}^m . Under the stabilization map, we identify $M \subset \mathbb{R}^m$ with $M \times \{0\} \subset \mathbb{R}^{m+1}$, and we add \vec{e} to the normal framings of (M, \vec{v}) and $(M, -\vec{w})$. Let M' be the pushoff of M in the direction \vec{e} . Note that \vec{e} is a generic vector for (M, \vec{v}) in \mathbb{R}^{m+1} . Thus, it suffices to construct an embedded framed cobordism from (M, \vec{v}) to $(M', -\vec{w})$ in \mathbb{R}^{m+1} , which we do as follows.

The argument is similar to that in the proof of Lemma 11.1. Fix a smooth embedding $\gamma : [0, 1] \rightarrow \mathbb{R}^2$ such that

$$\gamma(0) = \gamma(1) = (0, 0), \quad \gamma'(0) = (1, 0), \quad \gamma'(1) = (0, -1)$$

and such that the image of γ is contained in the ball $B(\epsilon)$ of radius ϵ around the origin, for $\epsilon > 0$ small. We let γ^\perp be the normal vector field to the image of γ , obtained from γ' by a counterclockwise rotation by 90° . For example, $\gamma^\perp(0) = (0, 1)$ and $\gamma^\perp(1) = (1, 0)$.

Fix also a smooth map $\zeta : [0, 1] \rightarrow [0, 1]$ with

$$\zeta(0) = 0, \quad \zeta(1) = 1, \quad \zeta'(0) = \zeta'(1) = 0 \text{ and } \zeta'(t) > 0 \text{ for } t \in (0, 1).$$

For every $p \in M$, let $V_p = \text{Span}(\vec{v}_p, \vec{w}_p)$ and let $A_p : \mathbb{R}^2 \rightarrow V_p$ be the linear isomorphism that takes $(1, 0)$ to \vec{v}_p and $(0, 1)$ to \vec{w}_p . If ϵ is sufficiently small, the union of all $p + A_p(B(\epsilon))$ forms a smoothly embedded disk bundle over M in \mathbb{R}^m . Then, the map

$$f : [0, 1] \times M \rightarrow \mathbb{R}^{m+1}, \quad f(t, p) = p + A_p \circ \gamma(t) + \zeta(t) \cdot \vec{e}$$

describes a smoothly embedded cobordism S from (M, \vec{v}) to $(M, -\vec{w})$. For the normal framing on S , we use the pushforward of γ^\perp under A_p to interpolate between \vec{w} and \vec{v} as t goes from 0 to 1. We also keep \vec{e} as part of the normal framing throughout the cobordism. \square

Proof of Proposition 11.5. There is a natural map $f : \Omega_{\text{fr},m}^k \rightarrow \tilde{\Omega}_{\text{fr},m+1}^k$. Given a framed manifold $M \subset \mathbb{R}^m$, we let $f(M)$ be the same manifold, viewed inside $\mathbb{R}^m \times \{0\} \subset \mathbb{R}^{m+1}$, the vector field \vec{v} be the constant positive unit vector field in the new \mathbb{R} direction, and the normal framing be the original framing of M , multiplied by $(-1)^m$. It is immediate from the definitions that if $M \sim N$ in $\Omega_{\text{fr},m}^k$, then $f(M) \sim f(N)$ in $\tilde{\Omega}_{\text{fr},m+1}^k$.

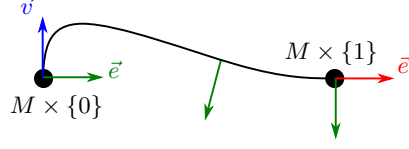
 FIGURE 21. The cobordism $S(M, \vec{v})$ from Proposition 11.5.

Next, consider the following diagram:

$$(11.2) \quad \begin{array}{ccc} \Omega_{\text{fr},m}^k & \xrightarrow{f} & \tilde{\Omega}_{\text{fr},m+1}^k \\ \sigma \downarrow & & \downarrow \sigma \\ \Omega_{\text{fr},m+1}^k & \xrightarrow{f} & \tilde{\Omega}_{\text{fr},m+2}^k \end{array}$$

where the vertical arrows are stabilization maps. We claim that the diagram (11.2) commutes after one more stabilization, i.e., $\sigma \circ \sigma \circ f = \sigma \circ f \circ \sigma$. Indeed, suppose we have a manifold $M \subset \mathbb{R}^m$ framed by the sequence of vectors $(\vec{w}_1, \dots, \vec{w}_{m-k})$. Let \vec{e}_{m+1} and \vec{e}_{m+2} denote the two new unit vectors when we stabilize from \mathbb{R}^m to \mathbb{R}^{m+2} . The images of $[M, (\vec{w}_1, \dots, \vec{w}_{m-k})] \in \Omega_{\text{fr},m}^k$ under the two possible compositions in (11.2) are

$$(-1)^m [(M, (\vec{w}_1, \dots, \vec{w}_{m-k}, \vec{e}_{m+1})), \vec{e}_{m+2}] \quad \text{and} \quad (-1)^{m+1} [(M, (\vec{w}_1, \dots, \vec{w}_{m-k}, \vec{e}_{m+2})), \vec{e}_{m+1}].$$

These become identical after one more stabilization, as proved in Lemma 11.6. From here it follows that the maps f induce a well-defined map

$$\Omega_{\text{fr}}^k \rightarrow \tilde{\Omega}_{\text{fr}}^k$$

on the colimits.

There is also a natural map

$$g: \tilde{\Omega}_{\text{fr},m}^k \rightarrow \Omega_{\text{fr},m}^k$$

defined as follows. Given (M, \vec{v}) inside \mathbb{R}^m along with a normal framing $(\vec{w}_1, \dots, \vec{w}_{m-k-1})$, we map it to M with the normal framing

$$(\vec{w}_1, \dots, \vec{w}_{m-k-1}, (-1)^{m+1} \vec{v}).$$

To see that the map g is well-defined, let us consider (M, \vec{v}) as an element of $\tilde{\Omega}_{\text{fr},m+1}^k$ as in the definition of the stabilization map (11.1). Let $M' = M \times \{1\} \subset \mathbb{R}^{m+1}$ be the unit pushoff in the new \vec{e} direction. By Lemma 11.1, there is an embedded framed cobordism $S(M, \vec{v})$ from $(M \times \{0\}, \vec{v})$ to $(M \times \{1\}, \vec{e})$ in \mathbb{R}^{m+1} ; indeed, the proof of the lemma shows that the cobordism lies inside $\mathbb{R}^m \times [0, 1]$. Furthermore, the induced normal framing of $(M \times \{1\}, \vec{e})$ in \mathbb{R}^{m+1} is $(\vec{w}_1, \dots, \vec{w}_{m-k-1}, -\vec{v})$; see Figure 21. Now, if we have a framed cobordism W from (M_1, \vec{v}_1) to (M_2, \vec{v}_2) in \mathbb{R}^m , we can treat it as a cobordism inside $\mathbb{R}^m \times \{\frac{1}{2}\}$, and compose with the reverse cobordism $S(M_1, \vec{v}_1)^r$ from (M_1, \vec{e}) to (M_1, \vec{v}_1) (viewed inside $\mathbb{R}^m \times [0, \frac{1}{2}]$) and with $S(M_2, \vec{v}_2)$ from (M_2, \vec{v}_2) to (M_2, \vec{e}) (viewed inside $\mathbb{R}^m \times [\frac{1}{2}, 1]$); see Figure 22. This produces a framed cobordism in $\mathbb{R}^m \times [0, 1]$ from $M_1 \times \{0\}$ to $M_2 \times \{1\}$, where the last framing vectors are $-\vec{v}_1$ and $-\vec{v}_2$, respectively. After multiplying the framing on this cobordism by $(-1)^m$, we get a framed cobordism from $g(M_1, \vec{v}_1)$ to $g(M_2, \vec{v}_2)$. Thus, g is well-defined. The presence of the $(-1)^{m+1}$ factor in the definition of g ensures that it commutes with the stabilization maps, producing a map $\tilde{\Omega}_{\text{fr}}^k \rightarrow \Omega_{\text{fr}}^k$ in the colimit.

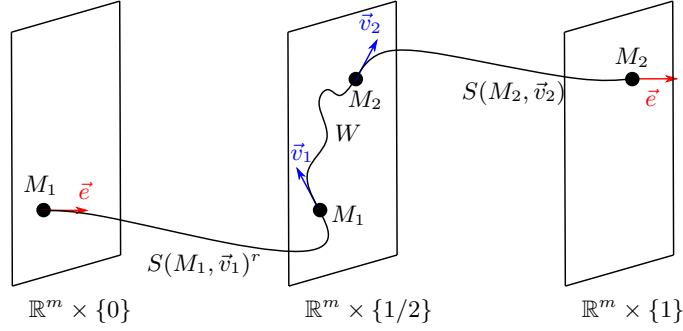

FIGURE 22. The composed cobordism from Proposition 11.5.

It is immediate that the composition $g \circ f$ is the stabilization $\Omega_{\text{fr},m}^k \rightarrow \Omega_{\text{fr},m+1}^k$. In the other direction, $(f \circ g)(M, \vec{v})$ is equivalent in (M, \vec{v}) in $\tilde{\Omega}_{\text{fr},m+1}^k$ using the framed cobordism $S(M, \vec{v})$ from $(M \times \{0\}, \vec{v})$ to $(M \times \{1\}, \vec{e})$ in $\mathbb{R}^m \times [0, 1]$. It follows that the maps induced by f and g on the colimits are inverse to each other. \square

12. CONSTRUCTING THE MODULI SPACES

We will construct the stratified spaces $\overline{\mathcal{M}}_{\vec{N}, \vec{\lambda}}(D)$, along with their embeddings and framings, inductively by dimension. For the reader's convenience, we first outline the procedure in Subsection 12.1, and then give more details in the following subsections.

12.1. Outline. We will first construct the moduli spaces $\overline{\mathcal{M}}_{\vec{N}, \vec{\lambda}}(c_{x\text{Id}})$, where \vec{N} is just made of 0's and 1's. This will be done in Section 13. Recall from Proposition 4.6 that the triples $(c_{x\text{Id}}, \vec{N}, \vec{\lambda})$ of this form generate a subcomplex $CDP_*^\dagger \subset CDP$ such that the quotient complex CDP'_* is acyclic.

After this, we will construct the remaining spaces $\overline{\mathcal{M}}_{\vec{N}, \vec{\lambda}}(D)$ inductively on their dimension k . The base case is $k = 0$.

- (C-1) Assume spaces up to dimension k have been constructed (together with neat embeddings in a suitable \mathbb{E}_l^d , as well as internal and external framings). Therefore, the boundaries of the $(k+1)$ -dimensional spaces have been constructed.
- (C-2) The boundary $\partial \overline{\mathcal{M}}_{\vec{N}, \vec{\lambda}}(D)$ has already been constructed. This has a thickening, which is part of the data of a neat embedding. Making use of the internal framings, we construct a neighborhood V of $\partial \overline{\mathcal{M}}_{\vec{N}, \vec{\lambda}}(D)$ inside $\overline{\mathcal{M}}_{\vec{N}, \vec{\lambda}}(D)$, neatly embedded in \mathbb{E}_l^d .
- (C-3) The neighborhood V is a Whitney (and hence Thom-Mather) stratified space, having local models as in Section 7; see Proposition 7.14 and Section 9.4. Its boundary $\partial V = \partial \overline{\mathcal{M}}_{\vec{N}, \vec{\lambda}}(D)$ is compact, and therefore the stratum $\text{int}(V)$ can be smoothed as in Definition 6.18. Then

$$W = V \setminus \text{int}(\text{sm}[\text{int}(V)])$$

is a new neighborhood of $\partial \overline{\mathcal{M}}_{\vec{N}, \vec{\lambda}}(D)$, whose boundary consists of $\partial \overline{\mathcal{M}}_{\vec{N}, \vec{\lambda}}(D)$ together with a smooth k -dimensional manifold, denoted $\partial' \overline{\mathcal{M}}_{\vec{N}, \vec{\lambda}}(D)$.

- (C-4) The external framing on $\partial \overline{\mathcal{M}}_{\vec{N}, \vec{\lambda}}(D)$, together with some part of the internal framing, induces a framing of $\partial' \overline{\mathcal{M}}_{\vec{N}, \vec{\lambda}}(D)$. We also equip $\partial' \overline{\mathcal{M}}_{\vec{N}, \vec{\lambda}}(D)$ with a vector field \vec{v} , the outer normal to W . Thus, we obtain an element $[\partial' \overline{\mathcal{M}}_{\vec{N}, \vec{\lambda}}(D)]$ in the framed cobordism group $\tilde{\Omega}_{\text{fr}}^k$.

(C-5) If $[\mathcal{M}_{\mathbb{N}; \sim}(D)]$ is nonzero, we cannot construct $\overline{\mathcal{M}}_{\mathbb{N}; \sim}(D)$ as a framed manifold immediately, by filling in $\mathcal{M}_{\mathbb{N}; \sim}(D)$. Putting together all D 's, we have an obstruction class in the form of a cochain

$$\alpha_k \in \text{Hom}(\text{CDP}_{k+1}^0; \sim^k_{\text{fr}}); \quad \alpha_k(D; \mathbb{N}; \sim) = [\mathcal{M}_{\mathbb{N}; \sim}(D)]:$$

(C-6) We prove that α_k is a cocycle.

(C-7) Since CDP^0 is acyclic, it follows that α_k is a coboundary of some element $\beta \in \text{Hom}(\text{CDP}_k^0; \sim^k_{\text{fr}})$. Use β to change the k -dimensional spaces of the form $\overline{\mathcal{M}}_{\mathbb{N}; \sim}(\cdot)$. (Note that we don't change any lower dimensional spaces.) After this, all k -dimensional $\mathcal{M}_{\mathbb{N}; \sim}(D)$ are framed null-cobordant.

(C-8) Now after making sure $\mathcal{M}_{\mathbb{N}; \sim}(D)$ is framed null-cobordant, fill it in arbitrarily to obtain the desired moduli space $\overline{\mathcal{M}}_{\mathbb{N}; \sim}(D) \subset E_1^d$, with a normal framing of its interior. This finishes the construction of all $(k + 1)$ -dimensional spaces.

(C-9) We split the normal framings to the moduli spaces $\mathcal{M}_{\mathbb{N}; \sim}(D)$ into internal and external framings, and construct thickenings by exponentiating the internal framings.

(C-10) Then continue with induction, and construct the $(k + 2)$ -dimensional spaces. That might require modifying the just-constructed $(k + 1)$ -dimensional spaces, but none of the smaller dimensions.

12.2. The base case. Let us recall the formulas (8.1), (9.14) for the dimension k and the thick dimension l of the moduli spaces $\mathcal{M}_{\mathbb{N}; \sim}(D)$:

$$(12.1) \quad k = (D) + 1 + \sum_j \binom{D}{j};$$

$$(12.2) \quad l = (D) + 2 \sum_j N_j;$$

The base case in the induction corresponds to moduli spaces with $k = 0$. From the above formula we see that there are two kinds of such moduli spaces:

- those with $(D) = 1$ and trivial \mathbb{N} (that is, $\mathbb{N} = \emptyset$); since D is supposed to be positive, it must be a rectangle R on the grid, and we are looking at the moduli spaces $\mathcal{M}_0(R)$;
- those with $(D) = 0$ and $\mathbb{N} = (N)$ for some j , where N denotes N_j , and we have $N_i = 0$ for all $i \neq j$; then D is the constant domain c_x for some $x \in S$, and we write the moduli spaces as $\mathcal{M}_{N_{\emptyset_j}; (N)_j}(c_x)$, with the notation from Remark 9.1.

The moduli spaces of the first kind have thick dimension 0. We define them to be single points, embedded in $E_0^d = \mathbb{R}^d$ in any way, and framed so that the resulting element in $\mathcal{H}_0^0 = \mathbb{Z}$ is the sign $\text{sgn}(R) \in \mathbb{Z} = \mathbb{Z} \oplus \mathbb{Z}$ from (G-17).

The moduli spaces of the second kind have thick dimension $h = 2N - 1$. We define them to be single points as well, embedded arbitrarily in the interior of E_1^d . For the thickening, we choose an open embedding of the local model Z_N in the interior of E_1^d , with the origin in Z_N mapped to the chosen point. For the internal framing, we push forward the standard framing on Z_N . For the external framing (the one normal to the thickening), we choose it so that the direct sum of the internal and external framings gives the positive framing on the point; i.e., so that it represents the element $1 \in \mathbb{Z} \oplus \mathbb{Z}$.

12.3. Boundaries and their neighborhoods. We now give more detailed explanations for some of the steps in the outline of the induction above. In this subsection we discuss steps (C-1) and (C-2).

For Step (C-1), recall that a stratum of $\partial\overline{\mathcal{M}}_{\vec{N},\vec{\lambda}}(D)$ is of the form

$$(12.3) \quad Y = \mathcal{M}_{\vec{N}^1 + \mathbb{O}(E^1) + \mathbb{O}(F^1), \vec{\lambda}^1}(D^1) \times \cdots \times \mathcal{M}_{\vec{N}^r + \mathbb{O}(E^r) + \mathbb{O}(F^r), \vec{\lambda}^r}(D^r).$$

Each $\mathcal{M}_{\vec{N}^i + \mathbb{O}(E^i) + \mathbb{O}(F^i), \vec{\lambda}^i}(D^i)$ already comes with a neat embedding (including a thickening U_i) and internal and external framings in $\mathbb{E}_{l_i}^d$, where l_i is its thick dimension. Altogether, we obtain an embedding of the product

$$U_1 \times U_2 \times \cdots \times U_r \hookrightarrow \mathbb{E}_{l_1}^d \times \{0\} \times \mathbb{E}_{l_2}^d \times \{0\} \times \cdots \times \{0\} \times \mathbb{E}_{l_r}^d \subset \mathbb{E}_l^d,$$

where

$$(12.4) \quad l = \text{tdim } \overline{\mathcal{M}}_{\vec{N},\vec{\lambda}}(D) = l_1 + \cdots + l_r + (r-1)$$

and we identify

$$(12.5) \quad \mathbb{E}_l^d = \mathbb{E}_{l_1}^d \times \mathbb{R}_+ \times \mathbb{E}_{l_2}^d \times \mathbb{R}_+ \times \cdots \times \mathbb{R}_+ \times \mathbb{E}_{l_r}^d.$$

Let

$$U(Y) = U_1 \times [0, \epsilon_Y) \times U_2 \times [0, \epsilon_Y) \cdots \times [0, \epsilon_Y) \times U_r \subset \mathbb{E}_l^d$$

and define the *thickening of the boundary* $\partial\overline{\mathcal{M}}_{\vec{N},\vec{\lambda}}(D)$ to be

$$U(\partial\overline{\mathcal{M}}_{\vec{N},\vec{\lambda}}(D)) = \bigcup_{Y \subset \partial\overline{\mathcal{M}}_{\vec{N},\vec{\lambda}}(D)} U(Y),$$

where $\epsilon_Y > 0$ are chosen so that $\epsilon_Y \ll \epsilon_Z$ for $Z \leq Y$.

Thus, we have constructed embeddings

$$\partial\overline{\mathcal{M}}_{\vec{N},\vec{\lambda}}(D) \hookrightarrow U(\partial\overline{\mathcal{M}}_{\vec{N},\vec{\lambda}}(D)) \hookrightarrow \mathbb{E}_l^d.$$

Next, in Step (C-2), we seek to construct a $(k+1)$ -dimensional stratified space $V \subseteq U(\partial\overline{\mathcal{M}}_{\vec{N},\vec{\lambda}}(D))$, which will play the role of a neighborhood of $\partial\overline{\mathcal{M}}_{\vec{N},\vec{\lambda}}(D)$ inside $\overline{\mathcal{M}}_{\vec{N},\vec{\lambda}}(D)$.

We will construct a subset $V(Y) \subseteq U(Y)$ for each stratum Y as in (12.3), and then take the union of all $V(Y)$ to get V . Consider the internal framings of each factor in (12.3), which are normal framings of

$$\mathcal{M}_{\vec{N}^i + \mathbb{O}(E^i) + \mathbb{O}(F^i), \vec{\lambda}^i}(D^i) \subset U_i.$$

The framings consist of vector fields along $\mathcal{M}_{\vec{N}^i + \mathbb{O}(E^i) + \mathbb{O}(F^i), \vec{\lambda}^i}(D^i)$. Extend these smoothly to vector fields in a neighborhood of each $\mathcal{M}_{\vec{N}^i + \mathbb{O}(E^i) + \mathbb{O}(F^i), \vec{\lambda}^i}(D^i)$ in U_i , so that these are still linearly independent at each point. By exponentiating these vector fields we obtain local flows consisting of families of diffeomorphisms $\phi_{1,t}, \dots, \phi_{m_i,t}$ for some $m_i \in \mathbb{N}$, over $t \in (-\delta, \delta)$ for some $\delta > 0$. From here we get an open embedding

$$\psi_i : \mathcal{M}_{\vec{N}^i + \mathbb{O}(E^i) + \mathbb{O}(F^i), \vec{\lambda}^i}(D^i) \times (-\delta, \delta)^{m_i} \hookrightarrow U_i$$

given by

$$\psi_i(x, t_1, \dots, t_{m_i}) = (\phi_{1,t_1} \circ \cdots \circ \phi_{m_i,t_{m_i}})(x).$$

Combining the ψ_i with the identity maps on the $[0, \epsilon_Y)$ factors we get an open embedding

$$(12.6) \quad Y \times \prod [0, \epsilon_Y)^{r-1} \times \prod (-\delta, \delta)^{m_i} \hookrightarrow U(Y).$$

Recall from the definition of a neat embedding (Definition 10.1) that $Y \subset U$ looks locally like the stratum

$$Y' = \{0\} \times Z(0, \vec{N}^1 + \mathbb{O}(E^1) + \mathbb{O}(F^1), 0; \vec{\lambda}^1) \times \cdots \times Z(0, \vec{N}^r + \mathbb{O}(E^r) + \mathbb{O}(F^r), 0; \vec{\lambda}^r)$$

inside

$$\mathbb{R}_+^{r-1} \times Z_{\vec{N}^1 + \mathbb{O}(E^1) + \mathbb{O}(F^1)} \times \cdots \times Z_{\vec{N}^r + \mathbb{O}(E^r) + \mathbb{O}(F^r)}.$$

It follows that we can identify a ball around 0 in $\prod [0, \epsilon_Y]^{r-1} \times \prod (-\delta, \delta)^{m_i}$ with the local model $\mathcal{L}(Y')$ in the normal directions to Y' , which appeared in Definition 7.13. Indeed, the local model lives inside a vector space generated by the standard frame of the normal bundle to Y , and the internal frame is locally like this standard frame. Thus, the restriction of (12.6) to a smaller ball gives an open embedding

$$(12.7) \quad \psi_Y : Y \times \mathcal{L}(Y') \hookrightarrow U(Y).$$

In other words, by exponentiating the internal frames, we managed to graft the local model $\mathcal{L}(Y')$ everywhere along Y . For simplicity, let us now change the definition of $U(Y)$, by letting $U(Y)$ denote the image of ψ_Y .

Our goal is to find $V(Y) \subset U(Y)$ which corresponds to the intersection of the (not yet constructed) moduli space $\overline{\mathcal{M}}_{\vec{N}, \vec{\lambda}}(D)$ with $U(Y)$. We know that $\overline{\mathcal{M}}_{\vec{N}, \vec{\lambda}}(D)$ is supposed to consist of various strata, and we know their local models. For all the strata $Y^\dagger \subset \overline{\mathcal{M}}_{\vec{N}, \vec{\lambda}}(D)$ with $Y^\dagger \geq Y$, the local model is some stratum $Y^{\dagger'}$ inside

$$\mathbb{R}_+^{r-1} \times Z_{\vec{N}^1 + \mathbb{O}(E^1) + \mathbb{O}(F^1)} \times \cdots \times Z_{\vec{N}^r + \mathbb{O}(E^r) + \mathbb{O}(F^r)}.$$

Then, take the local model

$$\mathcal{L}(Y'; Y^{\dagger'}) = \mathcal{L}(Y') \cap Y^{\dagger'}$$

and graft it according to ψ_Y ; that is, we construct a neighborhood of Y in Y^\dagger as $\psi_Y(Y \times \mathcal{L}(Y'; Y^{\dagger'}))$. The union of all these neighborhoods, over all such Y^\dagger , is the desired $V(Y)$. Note that $V(Y)$ comes equipped with a stratification by the various $Y^\dagger \cap V(Y)$.

We now set

$$V = \bigcup_{Y \subset \partial \overline{\mathcal{M}}_{\vec{N}, \vec{\lambda}}(D)} V(Y).$$

This is the desired neighborhood of $\partial \overline{\mathcal{M}}_{\vec{N}, \vec{\lambda}}(D)$ inside $\overline{\mathcal{M}}_{\vec{N}, \vec{\lambda}}(D)$.

We need to ensure one more thing: that the given stratifications of each $V(Y)$ glue together to produce a stratification of V , where the strata will be the intersections of $V(Y)$ with various strata in $\overline{\mathcal{M}}_{\vec{N}, \vec{\lambda}}(D)$. For this, our “grafting” of local models for Y needs to be done in a compatible way between the different Y . We can arrange this by constructing $V(Y)$ inductively on the dimension of Y : starting with the 0-dimensional strata Y and working our way up. At each step, when we construct some $V(Y)$, we already know (cf. Definition 10.10) that the internal framings are compatible with the lower strata in ∂Y . The internal framings consist of vector fields along Y , and recall that in the construction we extend them to a neighborhood of Y in $U(Y)$ (and then exponentiate). The inductive step tells us what the extension should be in a neighborhood of ∂Y in $U(Y)$. Thus, we are given vector fields along the union of Y and a neighborhood of $\partial Y \subset U(Y)$. This union is a deformation retract of the neighborhood of Y in $U(Y)$, so we can extend the vector fields to that neighborhood of Y . This guarantees that the resulting stratification is compatible with the previously-constructed stratifications.

This completes the discussion of Step (C-2).

12.4. Obtaining a cochain. Next, from the boundaries of the moduli spaces, we seek to obtain the cochains \mathfrak{o}_k . This corresponds to Steps (C-3) through (C-5) in the outline. Actually, Steps (C-3) and (C-5) were fully discussed in the outline and need no further explanation. We explain Step (C-4) in more detail.

In Step (C-4), note that $\partial' \overline{\mathcal{M}}_{\vec{N}, \vec{\lambda}}(D)$ is a smooth k -dimensional submanifold of $\text{int}(\mathbb{E}_l^d)$, and we can identify $\text{int}(\mathbb{E}_l^d)$ with a Euclidean space. We want $\partial' \overline{\mathcal{M}}_{\vec{N}, \vec{\lambda}}(D)$ to give an element of $\tilde{\Omega}_{\text{fr}}^k$. For this, we equip it with \vec{v} (the outer normal to W), and we are left to specify a normal framing to

$$T(\partial' \overline{\mathcal{M}}_{\vec{N}, \vec{\lambda}}(D)) \oplus \langle \vec{v} \rangle = TW|_{\partial' \overline{\mathcal{M}}_{\vec{N}, \vec{\lambda}}(D)}.$$

Note that W deformation retracts onto the neighborhood V constructed in Step (C-2). Thus, it suffices to give a normal framing to TV on the interior of V . (This will uniquely specify a normal framing to the interior of W .)

The neighborhood V is built out of subsets $V(Y)$ for strata of the form

$$Y = \mathcal{M}_{\vec{N}^1 + \mathbb{O}(E^1) + \mathbb{O}(F^1), \vec{\lambda}^1}(D^1) \times \cdots \times \mathcal{M}_{\vec{N}^r + \mathbb{O}(E^r) + \mathbb{O}(F^r), \vec{\lambda}^r}(D^r).$$

Recall that $V(Y)$ live inside thickenings

$$U(Y) = U_1 \times [0, \epsilon_Y] \times U_2 \times [0, \epsilon_Y] \cdots \times [0, \epsilon_Y] \times U_r.$$

By the inductive hypothesis, each factor of Y has an external framing; i.e., a normal framing of its thickening U_i . Together, these give a normal framing of $U(Y)$ inside $\text{int}(\mathbb{E}_l^d)$.

Furthermore, the interior of $V(Y)$ is identified with $Y \times \mathcal{L}(Y'; X')$, where X is the stratum inside

$$\mathbb{R}_+^{r-1} \times Z_{\vec{N}^1 + \mathbb{O}(E^1) + \mathbb{O}(F^1)} \times \cdots \times Z_{\vec{N}^r + \mathbb{O}(E^r) + \mathbb{O}(F^r)}$$

which serves as local model for X inside $U(Y)$. Thus, taking the standard framing for the normal bundle to X' we get a normal framing for $V(Y)$ inside $U(Y)$ (which we can think of as some part of the internal framing to Y). Combining this with the normal framing of $U(Y)$ inside $\text{int}(\mathbb{E}_l^d)$, we get a normal framing for $V(Y)$ inside $\text{int}(\mathbb{E}_l^d)$. These normal framings are compatible with each other as we vary Y , due to the compatibility of internal framings (cf. Definition 10.10). Altogether, we obtain the desired normal framing to TV , which gives the element

$$[\partial' \overline{\mathcal{M}}_{\vec{N}, \vec{\lambda}}(D)] \in \tilde{\Omega}_{\text{fr}}^k.$$

12.5. The cocycle condition. We now turn to Step (C-6). We split the discussion into two cases, according to whether $k = 0$ or $k \geq 1$. In the case $k = 0$, we obtain a stronger conclusion:

Proposition 12.1. *We have $\mathfrak{o}_0 = 0 \in \text{Hom}(CDP'_1, \tilde{\Omega}_{\text{fr}}^0)$.*

Proof. We seek to show that for every 1-dimensional moduli space $\partial' \overline{\mathcal{M}}_{\vec{N}, \vec{\lambda}}(D)$, the smoothed boundary $\partial' \overline{\mathcal{M}}_{\vec{N}, \vec{\lambda}}(D)$ represents the zero element in $\tilde{\Omega}_{\text{fr}}^0$. Using the formula (12.1), we find that 1-dimensional moduli spaces are of one of the following kinds (using the notation from Remark 9.2):

- (1) $\overline{\mathcal{M}}_0(D)$, where D is a positive domain of index 2 on the grid, which is either a disjoint union of two rectangles or an L-shape. Then, D has two distinct representations as concatenations of two rectangles, and therefore the boundary $\partial \overline{\mathcal{M}}_0(D)$ consists of two type I strata of the form $\mathcal{M}_0(R_1) \times \mathcal{M}_0(R_2)$; cf. Example 8.3 and Figure 7;
- (2) $\overline{\mathcal{M}}_0(D)$, where D is either a horizontal annulus H_j or a vertical annulus V_j . Then, the boundary $\partial \overline{\mathcal{M}}_0(D)$ consists of a type I stratum $\mathcal{M}_0(R_1) \times \mathcal{M}_0(R_2)$ and a type II stratum $\mathcal{M}_{\vec{e}_j, (1)_j}(c_x)$; cf. Example 8.5 and Figure 9;

- (3) $\overline{\mathcal{M}}_{N\vec{e}_j, (N)_j}(R)$, where R is a rectangle (of index 1) from x to y , $N \in \mathbb{N}$, and $j \in \{1, \dots, n\}$. Then, $\partial\overline{\mathcal{M}}_{\vec{N}, \vec{\lambda}}(D)$ consists of two strata of type I, namely $\mathcal{M}_{N\vec{e}_j, (N)_j}(c_x) \times \mathcal{M}_0(R)$ and $\mathcal{M}_0(R) \times \mathcal{M}_{N\vec{e}_j, (N)_j}(c_y)$;
- (4) $\overline{\mathcal{M}}_{N\vec{e}_i + M\vec{e}_j, (N)_i + (M)_j}(c_x)$, where c_x is a constant domain and $N, M \in \mathbb{N}$, $i \neq j$. Then, $\partial\overline{\mathcal{M}}_{\vec{N}, \vec{\lambda}}(D)$ has two strata of type I, namely $\mathcal{M}_{N\vec{e}_i, (N)_i}(c_x) \times \mathcal{M}_{M\vec{e}_j, (M)_j}(c_x)$ and $\mathcal{M}_{M\vec{e}_j, (M)_j}(c_x) \times \mathcal{M}_{N\vec{e}_i, (N)_i}(c_x)$;
- (5) $\overline{\mathcal{M}}_{(N+M)\vec{e}_i, (N+M)_i}(c_x)$. Then, $\partial\overline{\mathcal{M}}_{\vec{N}, \vec{\lambda}}(D)$ consists of the stratum $\mathcal{M}_{N\vec{e}_i, (N)_i}(c_x) \times \mathcal{M}_{M\vec{e}_i, (M)_i}(c_x)$ of type I, and the stratum $\mathcal{M}_{(N+M)\vec{e}_i, (N+M)_i}(c_x)$ of type III.

In all the above situations, the boundaries $\partial\overline{\mathcal{M}}_{\vec{N}, \vec{\lambda}}(D)$ consist of two zero-dimensional strata, which are points according to the construction in Section 12.2. Hence, the smoothings $\partial'\overline{\mathcal{M}}_{\vec{N}, \vec{\lambda}}(D)$ also consist of two points. By a case by case analysis, using the definitions in Section 12.2 and the properties (2.1), (2.2), (2.3) of the sign assignment on rectangles, one can check that the two points come with opposite signs in $\tilde{\Omega}_{\text{fr}}^0 \cong \Omega_{\text{fr}}^0 \cong \mathbb{Z}$, so they sum up to 0.

For example, the fact that the two boundary points in case (1) come with opposite signs is a consequence of Equation (2.1). In case (2), the type II stratum is a positively oriented point; when viewed inside the moduli space for a horizontal annulus, its neighborhood W is an interval, with one end being the type II stratum itself and the other being $\partial'\overline{\mathcal{M}}_{\vec{N}, \vec{\lambda}}(D)$, with the outer normal \vec{v} oriented negatively. This cancels with the type I stratum, which is positively oriented according to (2.2). On the other hand, for the moduli space for a vertical annulus, the type II stratum produces a space W whose other end has a normal vector oriented positively, whereas the type I stratum is oriented negatively by (2.3). We leave the verification of signs for the other cases as an exercise. \square

For $k \geq 1$, we have:

Proposition 12.2. *The element $\mathfrak{o}_k \in \text{Hom}(CDP'_{k+1}, \tilde{\Omega}_{\text{fr}}^k)$ is a cocycle.*

Proof. We need to show that $\delta\mathfrak{o}_k$ evaluates to zero on any generator $(E, \vec{M}, \vec{\mu}) \in CDP'_{k+2}$. This is equivalent to

$$\mathfrak{o}_k(\delta(E, \vec{M}, \vec{\mu})) = 0.$$

Write

$$\delta(E, \vec{M}, \vec{\mu}) = \sum s_{D, \vec{N}, \vec{\lambda}}(D, \vec{N}, \lambda),$$

where $s_{D, \vec{N}, \vec{\lambda}} \in \{\pm 1\}$ and $(D, \vec{N}, \vec{\lambda}) \in CDP'_{k+1}$. Here and later, when we sum over $(D, \vec{N}, \vec{\lambda})$, we consider only the triples that appear with a non-zero coefficient in $\delta(E, \vec{M}, \vec{\mu})$.

We aim to prove that $\sum s_{D, \vec{N}, \vec{\lambda}} \cdot \mathfrak{o}_k(D, \vec{N}, \lambda) = 0$, that is,

$$(12.8) \quad \sum s_{D, \vec{N}, \vec{\lambda}} [\partial'\overline{\mathcal{M}}_{\vec{N}, \vec{\lambda}}(D)] = 0.$$

Consider the $(k+2)$ -dimensional moduli space $\overline{\mathcal{M}}_{\vec{M}, \vec{\mu}}(E)$. Of course, this has not yet been constructed in our inductive procedure. Nevertheless, as mentioned in Section 9.3, we know that its codimension-1 strata are supposed to be of three types: products (Type I) and single moduli spaces (Type II and III). Furthermore, let us distinguish between the Type I products where one of the factors is zero-dimensional, and those where both factors are positive dimensional. When a factor is zero-dimensional, it must be a single point (see Section 12.2 and Remark 12.3 below), and therefore the product can be identified with the other factor, which is some k -dimensional moduli space $\mathcal{M}_{\vec{N}, \vec{\lambda}}(D)$.

The triples $(D, \vec{N}, \vec{\lambda})$ that appear in $\delta(E, \vec{M}, \vec{\mu})$ come from Type I products where one factor is zero-dimensional and the other is $\mathcal{M}_{\vec{N}, \vec{\lambda}}(D)$, as well as from Type II and III strata; see Remark 9.2.

Recall that all the moduli spaces of dimension up to k have already been constructed. Let us define the *old boundary* of $\overline{\mathcal{M}}_{\vec{M}, \vec{\mu}}(E)$, denoted $\partial^{\text{old}} \overline{\mathcal{M}}_{\vec{M}, \vec{\mu}}(E)$, to be the union of all strata of $\overline{\mathcal{M}}_{\vec{M}, \vec{\mu}}(E)$ of codimension 2 or higher (that is, dimension k or lower), together with the codimension-1 strata that are Type I products where neither factor is zero-dimensional (and therefore both factors are of dimension k or lower). Thus, $\partial^{\text{old}} \overline{\mathcal{M}}_{\vec{M}, \vec{\mu}}(E)$ has already been constructed in our inductive procedure, together with its embedding in \mathbb{E}_t^d and internal and external framings.

Observe that $\partial^{\text{old}} \overline{\mathcal{M}}_{\vec{M}, \vec{\mu}}(E)$ contains all the boundaries of the spaces $\overline{\mathcal{M}}_{\vec{N}, \vec{\lambda}}(D)$ with $(D, \vec{N}, \vec{\lambda}) \in \delta(E, \vec{M}, \vec{\mu})$. In Step (C-2) we constructed neighborhoods $V = V(D, \vec{N}, \vec{\lambda})$ of $\partial \overline{\mathcal{M}}_{\vec{N}, \vec{\lambda}}(D)$ in $\overline{\mathcal{M}}_{\vec{N}, \vec{\lambda}}(D)$ by exponentiating the internal framings which correspond to strata in $\overline{\mathcal{M}}_{\vec{N}, \vec{\lambda}}(D)$, and grafting the respective local models. We can similarly construct a neighborhood V^* of $\partial^{\text{old}} \overline{\mathcal{M}}_{\vec{M}, \vec{\mu}}(E)$ in $\overline{\mathcal{M}}_{\vec{M}, \vec{\mu}}(E)$, by exponentiating one more vector field and grafting the corresponding local model. There are, in fact, two cases: When $\mathcal{M}_{\vec{N}, \vec{\lambda}}(D)$ is a Type II or III stratum in the boundary of $\overline{\mathcal{M}}_{\vec{M}, \vec{\mu}}(E)$, then the thick dimension of $\overline{\mathcal{M}}_{\vec{M}, \vec{\mu}}(E)$ and $\overline{\mathcal{M}}_{\vec{N}, \vec{\lambda}}(D)$ is the same, and the new vector field we use is part of the internal framing. When $\mathcal{M}_{\vec{N}, \vec{\lambda}}(D)$ is a factor in a Type I stratum in $\partial \overline{\mathcal{M}}_{\vec{M}, \vec{\mu}}(E)$ (and the other factor is a point), then

$$\text{tdim } \overline{\mathcal{M}}_{\vec{M}, \vec{\mu}}(E) = \text{tdim } \overline{\mathcal{M}}_{\vec{N}, \vec{\lambda}}(D) + 1$$

and the extra vector field is in the direction of a \mathbb{R}_+ factor in (12.5).

In either of these cases, by grafting the local model for $\overline{\mathcal{M}}_{\vec{M}, \vec{\mu}}(E)$, we obtain a neighborhood V^* of $\partial^{\text{old}} \overline{\mathcal{M}}_{\vec{M}, \vec{\mu}}(E)$. We smooth its boundary to get another neighborhood W^* , extending the previous smoothing $W = W(D, \vec{N}, \vec{\lambda})$ of $V = V(D, \vec{N}, \vec{\lambda})$. Further, W^* comes with a normal framing on its interior, just as W did in Step (C-4).

The stratified space W^* has boundary

$$\partial W^* = \partial'' \overline{\mathcal{M}}_{\vec{M}, \vec{\mu}}(E) \cup \bigcup_{D, \vec{N}, \vec{\lambda}} W(D, \vec{N}, \vec{\lambda})$$

where $\partial'' \overline{\mathcal{M}}_{\vec{M}, \vec{\mu}}(E)$ is a filling of

$$\partial(\partial'' \overline{\mathcal{M}}_{\vec{M}, \vec{\mu}}(E)) = \bigcup_{D, \vec{N}, \vec{\lambda}} \left(W(D, \vec{N}, \vec{\lambda}) \cap \partial'' \overline{\mathcal{M}}_{\vec{M}, \vec{\mu}}(E) \right) = \bigcup_{D, \vec{N}, \vec{\lambda}} \partial' \overline{\mathcal{M}}_{\vec{N}, \vec{\lambda}}(D).$$

Thus, $\partial'' \overline{\mathcal{M}}_{\vec{M}, \vec{\mu}}(E)$ is a manifold whose boundary is the union of all $\partial' \overline{\mathcal{M}}_{\vec{N}, \vec{\lambda}}(D)$. See Figure 23 for an example.

Moreover, if \vec{w} denotes the outer normal to W^* along $\partial'' \overline{\mathcal{M}}_{\vec{M}, \vec{\mu}}(E)$, we equip $\partial'' \overline{\mathcal{M}}_{\vec{M}, \vec{\mu}}(E)$ with the inner normal $-\vec{w}$ and with the restriction of the normal framing to W^* . In this way, its framed boundary (as in the definition of the group $\tilde{\Omega}_{\text{fr}}^k$) is the union of all $\partial' \overline{\mathcal{M}}_{\vec{N}, \vec{\lambda}}(D)$, with the correct signs. Indeed, to give an element in $\tilde{\Omega}_{\text{fr}}^k$, the moduli space $\partial' \overline{\mathcal{M}}_{\vec{N}, \vec{\lambda}}(D)$ was equipped with its outer normal \vec{v} to $W(D, \vec{N}, \vec{\lambda})$, whereas \vec{w} was part of its normal framing. On the other hand, when looking at $\partial' \overline{\mathcal{M}}_{\vec{N}, \vec{\lambda}}(D)$ as part of the boundary of $\partial'' \overline{\mathcal{M}}_{\vec{M}, \vec{\mu}}(E)$, then the distinguished vector is $-\vec{w}$, whereas \vec{v} is in the normal framing. Using Lemma 11.6, we swap the framings and conclude that the two perspectives produce the same element in $\tilde{\Omega}_{\text{fr}}^k$.

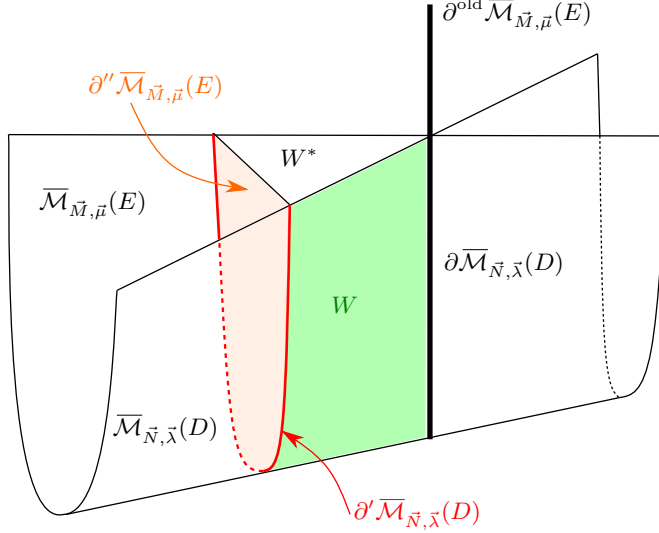

FIGURE 23. This is the Whitney umbrella example from Figure 6. We assume $\overline{\mathcal{M}}_{\overline{M}, \overline{\mu}}(E)$ is locally like the sector $Z(2, 0, 0)$ from that picture, and $\overline{\mathcal{M}}_{\overline{N}, \overline{\lambda}}(D)$ is $Z(1, 1, 0)$, one half of the umbrella. The handle $Z(0, 2, 0; 1, 1)$ of the umbrella is $\partial \overline{\mathcal{M}}_{\overline{N}, \overline{\lambda}}(D) \subset \partial^{\text{old}} \overline{\mathcal{M}}_{\overline{M}, \overline{\mu}}(E)$. We show a filling $\partial' \overline{\mathcal{M}}_{\overline{M}, \overline{\mu}}(E)$ of $\partial' \overline{\mathcal{M}}_{\overline{N}, \overline{\lambda}}(D)$.

Once we see that the union of all $\partial' \overline{\mathcal{M}}_{\overline{N}, \overline{\lambda}}(D)$ is the framed boundary of a space, the identity (12.8) follows. \square

12.6. Concluding the induction. For Step (C-7), to change the framings, we simply take disjoint union with a suitable framed manifold representing minus of the given class.

Remark 12.3. In view of Proposition 12.1, we see that Step (C-7) is unnecessary when $k = 0$. Thus, the 0-dimensional moduli spaces are not changed in the process, and they will always remain single points, as they were defined in Section 12.2.

In Step (C-8), once we have that $\partial' \overline{\mathcal{M}}_{\overline{N}, \overline{\lambda}}(D)$ is framed null-cobordant, we choose a filling $\mathcal{M}'_{\overline{N}, \overline{\lambda}}(D) \subset \text{int}(\mathbb{E}_l^d)$ and define

$$\mathcal{M}_{\overline{N}, \overline{\lambda}}(D) := W \cup \mathcal{M}'_{\overline{N}, \overline{\lambda}}(D).$$

Finally, for Step (C-9), note that, by construction, $\mathcal{M}_{\overline{N}, \overline{\lambda}}(D)$ comes equipped with a framing of its normal bundle in \mathbb{E}_l^d . To finish the inductive step, we need to give $\overline{\mathcal{M}}_{\overline{N}, \overline{\lambda}}(D)$ a neat embedding (in particular, a thickening), as well as split its normal framing into an internal and an external one. A thickening $U(\partial \overline{\mathcal{M}}_{\overline{N}, \overline{\lambda}}(D))$ was already constructed in Step (C-2) in a neighborhood of the boundary $\partial \overline{\mathcal{M}}_{\overline{N}, \overline{\lambda}}(D)$. Furthermore, the restriction of the normal framing to that neighborhood is already split into vectors that are tangent to $U(\partial \overline{\mathcal{M}}_{\overline{N}, \overline{\lambda}}(D))$ (the internal framing) and vectors that are normal to $U(\partial \overline{\mathcal{M}}_{\overline{N}, \overline{\lambda}}(D))$ (the external framing). We define the internal (resp. external) framing to $\overline{\mathcal{M}}_{\overline{N}, \overline{\lambda}}(D)$ to consist of the vector fields that are part of its normal framing and restrict to the internal (resp. external) framing on the neighborhood of the boundary. Then, exponentiate the

internal framing (similarly to how we did in Step (C-2)) to construct a thickening U that extends $U(\partial\overline{\mathcal{M}}_{\vec{N},\vec{\lambda}}(D))$.

Step (C-10) needs no additional explanation.

12.7. Gluing moduli spaces. Recall the equivalence relation on domains given by (8.2):

$$D \sim D' \iff (D - D' \in \mathcal{P} \text{ and } \mathbb{O}(D) = \mathbb{O}(D')).$$

Now that we have constructed all the framed moduli spaces $\overline{\mathcal{M}}_{\vec{N},\vec{\lambda}}(D)$, we glue $\overline{\mathcal{M}}_0(D)$ for all D in the same equivalence class. The result are the required moduli spaces $\overline{\mathcal{M}}([D])$ as in (8.3), which are $\langle k \rangle$ -manifolds neatly embedded in \mathbb{E}_l^d , and equipped with normal (external) framings there.

The fact that we can glue the different $\overline{\mathcal{M}}_0(D)$ is automatic provided we made compatible choices in the inductive construction. Precisely, in Step (C-2), suppose we have a stratum Y that is part of several different $\overline{\mathcal{M}}_0(D)$. We ask that, when we extend the internal framings of Y to vector fields in the thickening $U(Y)$, these extensions should be the same for all D . Then, recall that the thickening $U(Y)$ is identified with $Y \times \mathcal{L}(Y')$ as in (12.7), where $\mathcal{L}(Y')$ is the local model. These identifications are the same for the different D . It follows that $U(Y)$ will be the union of the $V(Y)$'s constructed for each D , that is, $U(Y)$ represents a neighborhood of Y inside the union $\overline{\mathcal{M}}([D])$ of all $\overline{\mathcal{M}}_0(D)$. Since thickenings are defined to be $\langle k \rangle$ -manifolds, the space $\overline{\mathcal{M}}([D])$ will be a $\langle k \rangle$ -manifold as well.

13. EMBEDDING AND FRAMING THE PERMUTOHEDRA

In this section we construct (and frame) the moduli spaces $\overline{\mathcal{M}}_{\vec{N},\vec{\lambda}}(D)$, where $D = c_{x^{\text{Id}}}$, the constant domain from the fixed generator x^{Id} to itself, and each entry in \vec{N} is 0 or 1 (so $\vec{\lambda}$ is a trivial partition). These correspond to the triples $(D, \vec{N}, \vec{\lambda})$ generating the subcomplex $CDP_*^\dagger \subset CDP$ that carries all the homology of CDP ; cf. Proposition 4.6.

Suppose \vec{N} is as above and let $|\vec{N}| = n$. (In this section, n no longer denotes the grid index.) We will use the notation

$$(13.1) \quad I = \{i \mid N_i = 1\} = \{p_1 < \dots < p_n\}$$

and

$$(13.2) \quad X_I := \overline{\mathcal{M}}_{\vec{N},\vec{\lambda}}(c_{x^{\text{Id}}}).$$

Note that X_I is supposed to be an $(n-1)$ -dimensional $\langle n-1 \rangle$ -manifold. Its thick dimension is $2n-1$.

We will define X_I to be the permutohedron Π_n , which is the convex hull of the $n!$ points in \mathbb{R}^n obtained by permuting the coordinates of $(1, 2, \dots, n)$; cf. Example 5.2. We will then embed and frame Π_n inside

$$\mathbb{R}^d \times \mathring{\mathbb{R}}_+ \times \mathbb{R}^d \times \mathbb{R}_+ \times \mathbb{R}^d \times \dots \times \mathbb{R}_+ \times \mathbb{R}^d \times \mathring{\mathbb{R}}_+ \times \mathbb{R}^d \cong \mathbb{R}^{2dn} \times \mathring{\mathbb{R}}_+^n \times \mathbb{R}_+^{n-1} \subset \mathbb{E}_{2n-1}^d,$$

coherently with respect to the embeddings and framings of the lower dimensional strata. We will actually do this for the case $d=0$. For larger d , we can then simply compose with the standard inclusion

$$\mathring{\mathbb{R}}_+^n \times \mathbb{R}_+^{n-1} \hookrightarrow \mathbb{R}^{2dn} \times \mathring{\mathbb{R}}_+^n \times \mathbb{R}_+^{n-1}, \quad x \mapsto (0, x).$$

For the case $d=0$, we will use the fact that the quotient of $\mathbb{R}^n \times \Pi_n$ by the symmetric group is diffeomorphic to $\mathring{\mathbb{R}}_+^n \times \mathbb{R}_+^{n-1}$. We will first embed X_I inside $\mathbb{R}^n \times \Pi_n$ by the map $x \mapsto ((p_1, \dots, p_n), x)$ and then quotient by the symmetric group action.

13.1. The permutohedron. In this section, we will collect well-known facts about the permutohedron Π_n . See for instance [41, Example 0.10] and [17, Section 3.3].

- (II-1) Letting S_n denote the group of permutations of $\{1, 2, \dots, n\}$, the permutohedron Π_n is the convex hull of the $n!$ points $v_\sigma = (\sigma^{-1}(1), \dots, \sigma^{-1}(n))$ in \mathbb{R}^n , for $\sigma \in S_n$.
- (II-2) The permutohedron Π_n is $(n - 1)$ -dimensional and lies in the hyperplane

$$\mathbb{A}^{n-1} = \{(x_1, \dots, x_n) \in \mathbb{R}^n \mid \sum_j x_j = n(n + 1)/2\}$$

and the points v_σ are its vertices.

- (II-3) For any non-empty proper subset $S \subset \{1, 2, \dots, n\}$ of cardinality say k , let $\mathbb{H}_S \subset \mathbb{A}^{n-1}$ denote the half-space $\{(x_1, \dots, x_n) \in \mathbb{A}^{n-1} \mid \sum_{j \in S} x_j \geq k(k + 1)/2\}$. Then Π_n is also the intersection of the $2^n - 2$ half-spaces \mathbb{H}_S , and the facets of Π_n are $F_S = \Pi_n \cap \partial \mathbb{H}_S$.
- (II-4) The vertices in the facet F_S are precisely the v_σ so that $\{\sigma(1), \sigma(2), \dots, \sigma(k)\} = S$.
- (II-5) The permutohedron carries the structure of $(n - 1)$ -manifold by declaring

$$\partial_k \Pi_n = \bigcup_{\{S, |S|=k\}} F_S.$$

- (II-6) Each of the facets $F_S \subset \partial_k \Pi_n$ can be identified with products of lower dimensional permutohedra $\Pi_k \times \Pi_{n-k}$. Identify \mathbb{R}^n with $\prod_{j \in \{1, \dots, n\}} \mathbb{R}$, and using the linear ordering of the elements of S and $S^c = \{1, 2, \dots, n\} \setminus S$, identify \mathbb{R}^k and \mathbb{R}^{n-k} with $\prod_{j \in S} \mathbb{R}$ and $\prod_{j \in S^c} \mathbb{R}$, respectively. Then the map

$$\prod_{j \in S} \mathbb{R} \times \prod_{j \in S^c} \mathbb{R} \xrightarrow{+(0, \dots, 0, k, \dots, k)} \prod_{j \in S} \mathbb{R} \times \prod_{j \in S^c} \mathbb{R} \cong \prod_{j \in \{1, \dots, n\}} \mathbb{R}$$

identifies $\Pi_k \times \Pi_{n-k} \subset \mathbb{R}^k \times \mathbb{R}^{n-k}$ with the facet $F_S \subset \partial_k \Pi_n \subset \mathbb{R}^n$.

- (II-7) We will also need the action of S_n on Π_n . Consider the left action of S_n on \mathbb{R}^n given by:

$$\sigma \cdot (x_1, \dots, x_n) = (x_{\sigma^{-1}(1)}, \dots, x_{\sigma^{-1}(n)}).$$

This restricts to an action on \mathbb{A}^{n-1} and Π_n . On the vertices of the permutohedron, S_n acts by $\sigma \cdot v_\tau = v_{\sigma\tau}$.

See Figure 24 for an illustration of some of these concepts.

13.2. Construction of the moduli spaces. We define the moduli spaces X_I from Equation (13.2) as permutohedra:

$$(13.3) \quad X_I = \Pi_n \subset \mathbb{R}^n \cong \prod_I \mathbb{R},$$

where for convenience, we have identified the ambient space \mathbb{R}^n with $\prod_I \mathbb{R}$ using the linear ordering of the elements of I (cf. Equation (13.1)), that is, using the bijection $\{1, \dots, n\} \rightarrow I, i \mapsto p_i$. (It is understood that for distinct subsets I, I' of cardinality n , the spaces X_I and $X_{I'}$ are *different* copies of Π_n ; for this it might be useful to regard them as living in different ambient spaces $\prod_I \mathbb{R}$ and $\prod_{I'} \mathbb{R}$.)

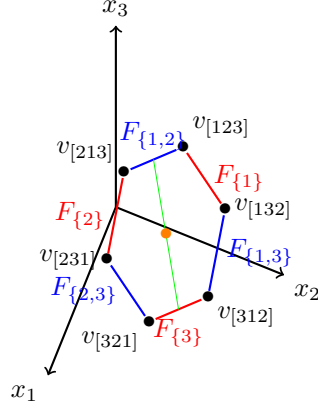

FIGURE 24. The permutohedron $\Pi_3 \subset \mathbb{R}^3$. Here the permutations $\sigma \in S_3$ are denoted as $[\sigma(1)\sigma(2)\sigma(3)]$. The facets in $\partial_1\Pi_3$ are shown in red and the facets in $\partial_2\Pi_3$ are shown in blue. The action of S_3 is also shown; S_3 is generated by the transposition $[213]$ and the 3-cycle $[231]$, and they act on Π_3 by reflection across the green line, and by positive rotation by 120° around the orange point, respectively.

We need to check that the stratification on X_I is as described in Sections 9.1 and 9.2. Indeed, it follows from Items (II-5) and (II-6) that X_I is a $\langle n-1 \rangle$ -manifold with $\partial_k X_I$ identified with

$$\coprod_{\substack{J \subset I \\ |J|=k}} X_J \times X_{I \setminus J}.$$

Moreover, these identifications are coherent, that is, for any $k < \ell$, the two identifications of $\partial_{\{k,\ell\}} X_I$ with

$$\coprod_{\substack{K \subset J \subset I \\ |K|=k, |J|=\ell}} X_K \times X_{J \setminus K} \times X_{I \setminus J}$$

are the same. See for instance [17, Lemma 3.17].

13.3. Quotienting by the symmetric group. In this section, we will consider the diagonal actions by the symmetric group on $\mathbb{R}^n \times \mathbb{R}^n$, $\mathbb{R}^n \times \mathbb{A}^{n-1}$, and $\mathbb{R}^n \times \Pi^{n-1}$. We will prove that the quotient $(\mathbb{R}^n \times \Pi_n)/S_n$ is diffeomorphic to $\mathbb{R}^n \times \mathbb{R}_+^{n-1}$; this is stated more precisely as Proposition 13.1 below.

Let $\pi: \mathbb{R}^n \times \mathbb{R}^n \rightarrow (\mathbb{R}^n \times \mathbb{R}^n)/S_n$ denote the projection to the quotient. Consider the well-known homeomorphism

$$\psi_n: (\mathbb{R}^n \times \mathbb{R}^n)/S_n \rightarrow \mathbb{R}^{2n}$$

given by the Viète relations. In more detail, let $\alpha_1, \dots, \alpha_n, \beta_1, \dots, \beta_n$ be the coordinates on $\mathbb{R}^n \times \mathbb{R}^n$, which we group into complex variables $\alpha_j + i\beta_j$, and let $a_1, \dots, a_n, b_1, \dots, b_n$ be the coordinates of the target \mathbb{R}^{2n} , which we also group into complex variables $a_j + ib_j$. Then the function ψ_n is induced by the smooth function $\psi_n \circ \pi: \mathbb{R}^n \times \mathbb{R}^n \rightarrow \mathbb{R}^{2n}$, which is given by equating the coefficients of the

polynomial

$$(13.4) \quad \prod_{j=1}^n (z - \alpha_j - i\beta_j) = z^n - (a_1 + ib_1)z^{n-1} + (a_2 + ib_2)z^{n-2} - \cdots + (-1)^n(a_n + ib_n).$$

Note that ψ_n restricts to a homeomorphism $(\mathbb{R}^n \times \mathbb{A}^{n-1})/S_n \rightarrow \mathbb{R}^{2n-1}$, which we also denote by ψ_n . To wit, $\mathbb{R}^n \times \mathbb{A}^{n-1}$ is the subspace given by $\beta_1 + \cdots + \beta_n = n(n+1)/2$, and so its image is given by the subspace $b_1 = n(n+1)/2$.

Proposition 13.1. *The image of $(\mathbb{R}^n \times \Pi_n)/S_n$ under ψ_n is a smooth submanifold with corners of \mathbb{R}^{2n-1} , and there is a diffeomorphism*

$$(13.5) \quad \Psi_n: \mathbb{R}^n \times \mathbb{R}_+^{n-1} \rightarrow \psi_n((\mathbb{R}^n \times \Pi_n)/S_n).$$

Moreover, the composition $\iota \circ \Psi_n: \mathbb{R}^n \times \mathbb{R}_+^{n-1} \rightarrow \mathbb{R}^{2n-1}$ (where ι is the inclusion) is a proper smooth embedding and the composition $\Psi_n^{-1} \circ \psi_n \circ \pi: \mathbb{R}^n \times \Pi_n \rightarrow \mathbb{R}^n \times \mathbb{R}_+^{n-1}$ is a smooth map of $(n-1)$ manifolds which is a smooth covering map away from the big diagonal (i.e., the subset on which the S_n -action is not free). That is, we have the following diagram

$$(13.6) \quad \begin{array}{ccccc} \mathbb{R}^n \times \Pi_n & \xrightarrow{\pi} & (\mathbb{R}^n \times \Pi_n)/S_n & \xrightarrow{\psi_n} & \psi_n((\mathbb{R}^n \times \Pi_n)/S_n) & \xleftarrow{\Psi_n} & \mathbb{R}^n \times \mathbb{R}_+^{n-1} \\ \downarrow & \searrow & \downarrow & \searrow & \downarrow & & \\ \mathbb{R}^n \times \mathbb{A}^{n-1} & \xrightarrow{\pi} & (\mathbb{R}^n \times \mathbb{A}^{n-1})/S_n & \xrightarrow{\psi_n} & \mathbb{R}^{2n-1} & & \\ \downarrow & \searrow & \downarrow & \searrow & \downarrow & & \\ \mathbb{R}^n \times \mathbb{R}^n & \xrightarrow{\pi} & (\mathbb{R}^n \times \mathbb{R}^n)/S_n & \xrightarrow{\psi_n} & \mathbb{R}^{2n} & & \end{array}$$

Here, the thick arrows are smooth and the solid-head arrows are homeomorphisms (and the solid-head thick arrows are diffeomorphisms) and all the embeddings are proper.

Moreover, these maps will be compatible with the identifications of facets $F_S \subset \partial_k \Pi_n$ with $\Pi_k \times \Pi_{n-k}$ from Item (II-6). Specifically, the following diagram will commute:

$$(13.7) \quad \begin{array}{ccc} (\mathbb{R}^k \times \Pi_k) \times (\mathbb{R}^{n-k} \times \Pi_{n-k}) & \xleftarrow{\cong} & \mathbb{R}^n \times F_S & \xrightarrow{\quad} & \mathbb{R}^n \times \Pi_n \\ (\Psi_k^{-1} \psi_k \pi, \Psi_{n-k}^{-1} \psi_{n-k} \pi) \downarrow & & & & \downarrow \pi \\ (\mathbb{R}^k \times \mathbb{R}_+^{k-1}) \times (\mathbb{R}^{n-k} \times \mathbb{R}_+^{n-k-1}) & & & & (\mathbb{R}^n \times \Pi_n)/S_n \\ \cong \downarrow & & & & \downarrow \psi_n \\ \mathbb{R}^n \times (\mathbb{R}_+^{k-1} \times \{0\} \times \mathbb{R}_+^{n-k-1}) & \xrightarrow{\quad} & \mathbb{R}^n \times \mathbb{R}_+^{n-1} & \xrightarrow{\Psi_n} & \mathbb{R}^{2n-1} \end{array}$$

Here, the identification $\mathbb{R}^k \times \mathbb{R}^{n-k} \xrightarrow{\cong} \mathbb{R}^n$ in the bottom-left vertical arrow is the usual one. However, the identification $\mathbb{R}^n \xrightarrow{\cong} \mathbb{R}^k \times \mathbb{R}^{n-k}$ on the top-left horizontal arrow is similar to the one from Item (II-6); that is, we identify \mathbb{R}^n , \mathbb{R}^k , \mathbb{R}^{n-k} with $\prod_{j \in \{1, \dots, n\}} \mathbb{R}$, $\prod_{j \in S} \mathbb{R}$ and $\prod_{j \in S^c} \mathbb{R}$, respectively, and then identify $\prod_{j \in \{1, \dots, n\}} \mathbb{R}$ with $\prod_{j \in S} \mathbb{R} \times \prod_{j \in S^c} \mathbb{R}$.

Proof. The construction of the diffeomorphism from Equation (13.5) is inductive. For the base case $n = 1$, the maps π and ψ_1 are identity (after naturally identifying the relevant spaces with \mathbb{R}), and we may define Ψ_1 to be the identity as well.

We explicitly also do the next case $n = 2$ to help build intuition. (Also, a portion of the proof for $n > 2$ does not generalize to $n = 2$). Recall, $\mathbb{R}^2 \times \Pi_2$ is the subset of $\mathbb{R}^2 \times \mathbb{R}^2$ given by

$$\beta_1 \geq 1, \quad \beta_2 \geq 1, \quad \beta_1 + \beta_2 = 3,$$

and $\mathbb{R}^2 \times \partial\Pi_2$ is given by $\beta_1 = 1$ (and hence $\beta_2 = 2$) or $\beta_2 = 1$ (and hence $\beta_1 = 2$). We want to satisfy the compatibility from Equation (13.7), so we need to analyse the image of $(\mathbb{R}^2 \times \partial\Pi_2)/S_2$ under ψ_2 . Since we are quotienting by the action of S_2 , we may assume $\beta_1 = 1$ and $\beta_2 = 2$.

From Equation (13.4), the image of the boundary is given by the coefficients of the polynomial $z^2 - (a_1 + ib_1)z + (a_2 + ib_2) = (z - \alpha_1 - i)(z - \alpha_2 - 2i) = z^2 - (\alpha_1 + \alpha_2 + 3i)z + (\alpha_1\alpha_2 - 2) + i(2\alpha_1 + \alpha_2)$. As we already observed, this lies in the subspace $\mathbb{R}^3 \subset \mathbb{R}^4$ given by $b_1 = 3$. The image is a parametrized surface in this \mathbb{R}^3 , given by

$$(13.8) \quad a_1 = \alpha_1 + \alpha_2, \quad a_2 = \alpha_1\alpha_2 - 2, \quad b_2 = 2\alpha_1 + \alpha_2.$$

Here, a_1, a_2, b_2 are the coordinates of \mathbb{R}^3 and α_1, α_2 are the parameters. We may solve for α_1, α_2 in terms of a_1, b_2 , and so this surface can also be written as $\{a_2 = 3a_1b_2 - 2a_1^2 - b_2^2 - 2\}$. This is a graph of 2-variable function in a_1, b_2 , and therefore represents a properly embedded \mathbb{R}^2 via the map $(a_1, b_2) \mapsto (a_1, 3a_1b_2 - 2a_1^2 - b_2^2 - 2, b_2)$. Furthermore, its complement has two components, say $A = \{a_2 < 3a_1b_2 - 2a_1^2 - b_2^2 - 2\}$ and $B = \{a_2 > 3a_1b_2 - 2a_1^2 - b_2^2 - 2\}$, and the closure of each is a properly embedded $\mathbb{R}^2 \times \mathbb{R}_+$ via the maps $(a_1, b_2, t) \mapsto (a_1, 3a_1b_2 - 2a_1^2 - b_2^2 - 2 - t, b_2)$ and $(a_1, b_2, t) \mapsto (a_1, 3a_1b_2 - 2a_1^2 - b_2^2 - 2 + t, b_2)$, respectively.

On the ambient \mathbb{R}^3 , define the continuous function

$$\Sigma_1 : \mathbb{R}^3 \rightarrow \mathbb{R}$$

as the minimum of the two imaginary parts of the two roots of $z^2 - (a_1 + 3i)z + (a_2 + ib_2)$. Then the given surface $\psi_2((\mathbb{R}^2 \times \partial\Pi_2)/S_2)$ is precisely the subspace $\{\Sigma_1 = 1\}$, while $\psi_2((\mathbb{R}^2 \times \Pi_2)/S_2)$ is the subspace $\{\Sigma_1 \geq 1\}$. By intermediate value theorem, the latter is one of the closures \bar{A} or \bar{B} , which is indeed diffeomorphic to $\mathbb{R}^2 \times \mathbb{R}_+$. Indeed, we can determine that it is \bar{A} since the value of ψ_2 at any specific point of $(\mathbb{R}^2 \times \dot{\Pi}_1)/S_2$ (say $\alpha_1 = \alpha_2 = 0, \beta_1 = \beta_2 = 3/2$) lies in A (at the point $a_1 = b_2 = 0, a_2 = -9/4$).

Although in this case we were explicitly able to see the parametrized surface as a properly embedded $\mathbb{R}^2 \subset \mathbb{R}^3$, there is a more abstract argument which also works. The abstract argument is also needed to check compatibility. Let us take $S = \{1\}$ (respectively, $S = \{2\}$), and start with the point $((\alpha_1, \alpha_2), (1, 2)) \in \mathbb{R}^2 \times F_S$ (respectively, $((\alpha_1, \alpha_2), (2, 1)) \in \mathbb{R}^2 \times F_S$) in the top-middle vertex of Equation (13.7). Starting left and following four arrows, we get

$$((\alpha_1, \alpha_2), (1, 2)) \mapsto ((\alpha_1, 1), (\alpha_2, 1)) \mapsto ((\alpha_1), (\alpha_2)) \mapsto ((\alpha_1, \alpha_2), (0)) \mapsto ((\alpha_1, \alpha_2), (0)) \in \mathbb{R}^2 \times \mathbb{R}_+^1$$

(respectively,

$$((\alpha_1, \alpha_2), (2, 1)) \mapsto ((\alpha_2, 1), (\alpha_1, 1)) \mapsto ((\alpha_2), (\alpha_1)) \mapsto ((\alpha_2, \alpha_1), (0)) \mapsto ((\alpha_2, \alpha_1), (0)) \in \mathbb{R}^2 \times \mathbb{R}_+^1),$$

while starting right, and following three arrows, we get

$$((\alpha_1, \alpha_2), (1, 2)) \mapsto ((\alpha_1, \alpha_2), (1, 2)) \mapsto [((\alpha_1, \alpha_2), (1, 2))] \mapsto (\alpha_1 + \alpha_2, \alpha_1\alpha_2 - 2, 2\alpha_1 + \alpha_2)$$

(respectively,

$$((\alpha_1, \alpha_2), (2, 1)) \mapsto ((\alpha_1, \alpha_2), (2, 1)) \mapsto [((\alpha_2, \alpha_1), (1, 2))] \mapsto (\alpha_2 + \alpha_1, \alpha_2\alpha_1 - 2, 2\alpha_2 + \alpha_1)).$$

Therefore, in either case, the compatibility condition tells us that the map $\Psi_2 : \mathbb{R}^2 \times \mathbb{R}_+ \rightarrow \mathbb{R}^3$ must restrict on the boundary to the given parametrization from Equation (13.8). Letting Ψ_1 denote the map $\mathbb{R}^2 \rightarrow \mathbb{R}^3$ given by Equation (13.8), we then have to prove the following:

- (1) **Properly embedded:** We have to prove $\Psi|: \mathbb{R}^2 \rightarrow \mathbb{R}^3$ is a proper smooth embedding, that is, it is a proper map which is an immersion and a diffeomorphism onto its image.

For injectivity, note that image of $\Psi|$ is the subspace $\{\Sigma_1 = 1\}$ of \mathbb{R}^3 , which consists of monic quadratic polynomials whose one root has imaginary part 1 and the other root has imaginary part 2; and such polynomials *uniquely* factorize as $(z - \alpha_1 - i)(z - \alpha_2 - 2i)$.

To show it is an immersion, consider the map $\psi_2 \circ \pi: \mathbb{R}^2 \times \mathbb{R}^2 \rightarrow \mathbb{R}^4$ given by the Viète relations, as shown in the bottom row of Equation (13.6). It is well-known that away from the diagonal this is a local diffeomorphism (that is, roots of a polynomial are smooth functions of its coefficients), so $d(\psi_2 \circ \pi)$ has rank 4 at each point. Our map $\Psi|$ is the restriction to the 2-dimensional affine subspace $\beta_1 = 1, \beta_2 = 2$ (which lies in the complement of the diagonal), and so $d\Psi|$ has rank 2 at each point.

The statement that the inverse map is smooth is again just the statement that the roots of a polynomial are smooth functions of its coefficients.

Finally, $\Psi|$ is automatically proper since it is an embedding with closed image $\{\Sigma_1 = 1\} \subset \mathbb{R}^3$.

- (2) **Extendable:** We have to prove the proper smooth embedding $\Psi|: \mathbb{R}^2 \rightarrow \mathbb{R}^3$ extends to a proper smooth embedding $\Psi_2: \mathbb{R}^2 \times \mathbb{R}_+ \rightarrow \mathbb{R}^3$ with image $\bar{A} = \{\Sigma_1 \geq 1\} = \psi_2((\mathbb{R}^2 \times \Pi_2)/S_2)$. This is the part where the general proof for $n > 2$ does not work, so we have to fall back to our explicit computation from before and simply set

$$\Psi_2(\alpha_1, \alpha_2, t) = (\alpha_1 + \alpha_2, \alpha_1\alpha_2 - 2 - t, 2\alpha_1 + \alpha_2).$$

Let us now do the general case for $n \geq 3$. We will use the following.

Proposition 13.2. *Assume $m \geq 4$. Let $i: \mathbb{R}^m \hookrightarrow \mathbb{R}^{m+1}$ be a proper smooth embedding. Then the embedding splits \mathbb{R}^{m+1} into two pieces, each the image of a proper smooth embedding of $\mathbb{R}^m \times \mathbb{R}_+$; moreover, the embeddings of $\mathbb{R}^m \times \mathbb{R}_+$ may be chosen to agree with i on the boundary.*

Proof. The Jordan-Brouwer theorem says that the complement of $i(\mathbb{R}^m)$ has two connected components. Let A be the closure of one of these components. Then A is a smooth manifold with boundary, and we need to show it is a properly embedded $\mathbb{R}^m \times \mathbb{R}_+$.

By taking one-point compactifications, we can extend i to an embedding of S^m into S^{m+1} , smooth away from a point. By a result of Kirby [13], since $m \geq 4$, the embedding cannot fail to be locally flat at exactly one point. Therefore, it is locally flat. By the topological Schönflies theorem [4, 25, 26], S^m splits S^{m+1} into two pieces, each homeomorphic to B^m . After removing the point at infinity, we get that A is homeomorphic to $\mathbb{R}^m \times \mathbb{R}_+$. We will show that A is diffeomorphic to $\mathbb{R}^m \times \mathbb{R}_+$.

We also know that A is smooth, and ∂A is a properly embedded \mathbb{R}^m . Using the tubular neighborhood theorem for proper smooth embeddings, choose a tubular neighborhood V of ∂A in A , with closure \bar{V} , such that we have a diffeomorphism

$$\phi_1: \bar{V} \rightarrow \mathbb{R}^m \times [0, \epsilon].$$

By the same argument as for A (taking one-point compactifications), we find that $A \setminus V$ is homeomorphic to $\mathbb{R}^m \times \mathbb{R}_+$. Let

$$\phi_2: (A \setminus V) \rightarrow \mathbb{R}^m \times [\epsilon, \infty)$$

be a homeomorphism.

Let us identify $\mathbb{R}^m \times \{\epsilon\}$ with \mathbb{R}^m , and view the restriction of $\phi_1 \circ \phi_2^{-1}$ as a self-homeomorphism $h: \mathbb{R}^m \rightarrow \mathbb{R}^m$. This can be extended to a self-homeomorphism

$$\tilde{h}: \mathbb{R}^m \times [\epsilon, \infty) \rightarrow \mathbb{R}^m \times [\epsilon, \infty), \quad \tilde{h}(x, t) = (h(x), t).$$

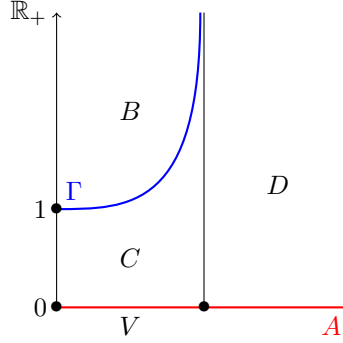

FIGURE 25. The smooth manifold (with corners) $A \times \mathbb{R}_+$. The region $C \cup D$ is a proper h-cobordism with boundary, from A (in red) to Γ (in blue).

By replacing ϕ_2 with $\tilde{h} \circ \phi_2$, we can assume without loss of generality that ϕ_1 and ϕ_2 coincide on the boundary $\partial(A \setminus V)$. Let $\bar{\phi}: A \rightarrow \mathbb{R}^m \times [0, \infty)$ be the homeomorphism obtained by gluing ϕ_1 and ϕ_2 .

Consider the product $A \times \mathbb{R}_+$, which is homeomorphic to $\mathbb{R}^m \times \mathbb{R}_+ \times \mathbb{R}_+$ by $\bar{\phi} \times \text{id}$. This is an $(m+1)$ -dimensional smooth manifold with corners. Fix a strictly increasing smooth function $f: [0, \epsilon) \rightarrow \mathbb{R}_+$ with $f(0) = 1$, $f'(0) = 0$, and $\lim_{t \rightarrow \epsilon} f(t) = \infty$, for instance $f(t) = \sec(\frac{\pi t}{2\epsilon})$. Inside the half-strip $V \times \mathbb{R}_+$, consider the graph Γ of the smooth composition function

$$V \xrightarrow{\phi_1} \mathbb{R}^m \times [0, \epsilon) \xrightarrow{\pi_2} [0, \epsilon) \xrightarrow{f} \mathbb{R}_+.$$

Note that Γ is diffeomorphic to $\mathbb{R}^m \times \mathbb{R}_+$ and splits the collar $V \times \mathbb{R}_+$ into two pieces B (above Γ) and C (below Γ), as in Figure 25.

Let $D = (A \setminus V) \times \mathbb{R}_+$. Then $C \cup D$ is a proper cobordism with boundary, from A to Γ . In fact, the homeomorphism $\bar{\phi} \times \text{id}$ sends $C \cup D$ to $\mathbb{R}^m \times E$, where $E \subset \mathbb{R}_+^2$ is the region in the first quadrant that lies below and to the right of the graph of the function $f(t)$, $0 \leq t < \epsilon$. Since E is diffeomorphic to $\mathbb{R}_+ \times [0, 1]$, we find that $C \cup D$ is homeomorphic to $\mathbb{R}^m \times \mathbb{R}_+ \times [0, 1]$. Thus, $C \cup D$ is a proper h-cobordism with boundary, with inclusion of either end a simple equivalence, and has dimension $m+2 \geq 6$. Siebenmann's proper h-cobordism theorem [37] (applied to cobordisms of manifolds with boundary, where the boundary cobordism is a cylinder, cf. [37, Footnote 1 on pp. 484]) implies that $C \cup D$ is diffeomorphic to a cylinder. Therefore, A is diffeomorphic to $\Gamma \cong \mathbb{R}^m \times \mathbb{R}_+$.

If $j: \mathbb{R}^m \times \mathbb{R}_+ \xrightarrow{\cong} A$ is any diffeomorphism, then let $g: \mathbb{R}^m \rightarrow \mathbb{R}^m$ denote the self-diffeomorphism $j^{-1} \circ i$; extend this to a self-diffeomorphism $\tilde{g}: \mathbb{R}^m \times \mathbb{R}_+ \rightarrow \mathbb{R}^m \times \mathbb{R}_+$ by $\tilde{g}(x, t) = (g(x), t)$. Then $j \circ \tilde{g}: \mathbb{R}^m \times \mathbb{R}_+ \rightarrow A$ is a diffeomorphism that agrees with given embedding i on the boundary. Moreover, the composition $\mathbb{R}^m \times \mathbb{R}_+ \xrightarrow{j \circ \tilde{g}} A \hookrightarrow \mathbb{R}^{m+1}$ is a smooth embedding with closed image, so it is a proper embedding. \square

We will also need the following in order to glue diffeomorphisms on the boundary.

Proposition 13.3. *Let $i: \mathbb{R}^m \times \mathbb{R}_+ \hookrightarrow \mathbb{R}^{m+1}$ be a proper smooth embedding. Let $j: \mathbb{R}^m \times [0, 1] \hookrightarrow \mathbb{R}^{m+1}$ be a collar neighborhood of $i(\mathbb{R}^m \times \{0\})$ inside $i(\mathbb{R}^m \times \mathbb{R}_+)$ which agrees with i on $\mathbb{R}^m \times \{0\}$. Then there exists a proper smooth embedding $i': \mathbb{R}^m \times \mathbb{R}_+ \hookrightarrow \mathbb{R}^{m+1}$ with the same image as i which agrees with j on some open neighborhood of $\mathbb{R}^m \times \{0\}$ inside $\mathbb{R}^m \times [0, 1]$.*

Proof. By pulling back by the diffeomorphism i , we may assume i is the identity map. That is, we have a collar neighborhood $j: \mathbb{R}^m \times [0, 1] \rightarrow \mathbb{R}^m \times \mathbb{R}_+$ with $j(x, 0) = (x, 0)$ for all $x \in \mathbb{R}^m$, and we want to construct a diffeomorphism $i': \mathbb{R}^m \times \mathbb{R}_+ \rightarrow \mathbb{R}^m \times \mathbb{R}_+$ which agrees with j on some open set around $\mathbb{R}^m \times \{0\}$.

Apply the local collaring uniqueness theorem [14, Theorem A.1] with $M = \mathbb{R}^m \times \{0\}$, $W = \mathbb{R}^m \times \mathbb{R}_+$, $C = \emptyset$, $D = M$, $f: \mathbb{R}^m \times [0, 1] \rightarrow \mathbb{R}^m \times \mathbb{R}_+$ the given collar neighborhood j , and $g: \mathbb{R}^m \times [0, 1] \rightarrow \mathbb{R}^m \times \mathbb{R}_+$ the standard inclusion. The required diffeomorphism i' is then the map $h_1: \mathbb{R}^m \times \mathbb{R}_+ \rightarrow \mathbb{R}^m \times \mathbb{R}_+$. \square

We will now construct a proper smooth embedding $\Psi_n: \mathbb{R}^n \times \mathbb{R}_+^{n-1} \rightarrow \mathbb{R}^{2n-1}$ with image $\psi_n((\mathbb{R}^n \times \Pi_n)/S_n)$, as in Equation (13.6). Moreover, it will respect the $(n-1)$ -manifold structures, so it will map $\mathbb{R}^n \times \partial_J \mathbb{R}_+^{n-1}$ to $\psi_n((\mathbb{R}^n \times \partial_J \Pi_n)/S_n)$ for any $J \subset \{1, 2, \dots, n-1\}$, where ∂_J denotes $\bigcap_{j \in J} \partial_j$.

The map Ψ_n is required to satisfy the compatibility condition from Equation (13.7); therefore, it is already defined on $\mathbb{R}^n \times \partial \mathbb{R}_+^{n-1}$ respecting the stratification given by the closed strata $\mathbb{R}^n \times \partial_J \mathbb{R}_+^{n-1}$. This statement deserves further details.

Define continuous functions $\Sigma_k: \mathbb{R}^{2n-1} \rightarrow \mathbb{R}$, $k = 1, \dots, n-1$, as follows: $\Sigma_k(a_1, \dots, a_n, b_2, \dots, b_n)$ is the sum of the k smallest imaginary parts among the n roots of the polynomial

$$z^n - (a_1 + in(n+1)/2)z^{n-1} + (a_2 + ib_2)z^{n-2} - \dots + (-1)^n(a_n + ib_n).$$

Recall from Item (II-3) that the permutohedron $\Pi_n \subset \mathbb{A}^{n-1}$ is the intersection of the half-spaces $\mathbb{H}_S = \{(x_1, \dots, x_n) \in \mathbb{A}^{n-1} \mid \sum_{j \in S} x_j \geq k(k+1)/2\}$; therefore, $\psi_n((\mathbb{R}^n \times \Pi_n)/S_n)$ is precisely the subspace

$$\{\Sigma_1 \geq 1, \Sigma_2 \geq 3, \dots, \Sigma_k \geq k(k+1)/2, \dots, \Sigma_{n-1} \geq (n-1)n/2\} \subset \mathbb{R}^{2n-1}.$$

Moreover, if $|S| = k$, then $F_S = \Pi_n \cap \partial \mathbb{H}_S$, and therefore $\psi_n((\mathbb{R}^n \times \partial_k \Pi_n)/S_n)$ is precisely the subspace

$$\{\Sigma_1 \geq 1, \Sigma_2 \geq 3, \dots, \Sigma_k = k(k+1)/2, \dots, \Sigma_{n-1} \geq (n-1)n/2\} \subset \mathbb{R}^{2n-1}.$$

More tersely, define the continuous function $\bar{\Sigma}: \mathbb{R}^{2n-1} \rightarrow \mathbb{R}$ by

$$(13.9) \quad \bar{\Sigma} = \min \{\Sigma_1 - 1, \Sigma_2 - 3, \dots, \Sigma_k - k(k+1)/2, \dots, \Sigma_{n-1} - (n-1)n/2\}.$$

Then $\psi_n((\mathbb{R}^n \times \partial \Pi_n)/S_n) = \{\bar{\Sigma} = 0\}$ and $\psi_n((\mathbb{R}^n \times \Pi_n)/S_n) = \{\bar{\Sigma} \geq 0\}$.

Consider the subset $S = \{1, 2, \dots, k\}$, and the corresponding facet $F_S \subset \partial_k \Pi_n$. Fix any point $(\alpha_1, \dots, \alpha_n, \beta_1, \dots, \beta_n) \in \mathbb{R}^n \times F_S$; so we have

$$\beta_1 + \dots + \beta_k = k(k+1)/2, \quad \beta_{k+1} + \dots + \beta_n = (n(n+1) - k(k+1))/2.$$

Starting from this point on the top-middle vertex of Equation (13.7), and following three arrows on the right, we get the point $(a_1, \dots, a_n, b_2, \dots, b_n) \in \mathbb{R}^{2n-1}$ by equating the coefficients of the polynomial—call it $P(z)$ —from Equation (13.4). However, starting left, the first arrow takes it to the point

$$((\alpha_1, \dots, \alpha_k, \beta_1, \dots, \beta_k), (\alpha_{k+1}, \dots, \alpha_n, \beta_{k+1} - k, \dots, \beta_n - k)) \in (\mathbb{R}^k \times \Pi_k) \times (\mathbb{R}^{n-k} \times \Pi_{n-k}).$$

Under the map $\psi_k \circ \pi$, the point $(\alpha_1, \dots, \alpha_k, \beta_1, \dots, \beta_k)$ maps to $(c_1, \dots, c_k, d_2, \dots, d_k) \in \mathbb{R}^{2k-1}$ given by equating the coefficients of the polynomial $Q_0(z)$, again from Equation (13.4) (but with k instead of n , c_j instead of a_j , and d_j instead of b_j). Under the map $\psi_{n-k} \circ \pi$, the point $(\alpha_{k+1}, \dots, \alpha_n, \beta_{k+1} -$

$k, \dots, \beta_n - k$) maps to the point $(\tilde{e}_1, \dots, \tilde{e}_{n-k}, \tilde{f}_2, \dots, \tilde{f}_{n-k}) \in \mathbb{R}^{2n-2k-1}$ given by equating the coefficients of the polynomial

$$\tilde{Q}_1(z) = \prod_{j=k+1}^n (z - \alpha_j - i(\beta_j - k)) = z^{n-k} - (\tilde{e}_1 + i\tilde{f}_1)z^{n-k-1} + \dots + (-1)^{n-k}(\tilde{e}_{n-k} + i\tilde{f}_{n-k}),$$

with $\tilde{f}_1 = \frac{(n-k)(n-k+1)}{2}$. Let $(e_1, \dots, e_{n-k}, f_2, \dots, f_{n-k}) \in \mathbb{R}^{2n-2k-1}$ be given by the polynomial $Q_1(z)$ from Equation (13.4) (but with $n-k$ instead of n , e_j instead of a_j , f_j instead of b_j , and roots $\alpha_j + i\beta_j$ for $k < j \leq n$):

$$Q_1(z) = \prod_{j=k+1}^n (z - \alpha_j - i\beta_j) = z^{n-k} - (e_1 + if_1)z^{n-k-1} + \dots + (-1)^{n-k}(e_{n-k} + if_{n-k}),$$

with $f_1 = \frac{n(n+1)-k(k+1)}{2}$. Then $(e_1, \dots, e_{n-k}, f_2, \dots, f_{n-k})$ can be obtained from $(\tilde{e}_1, \dots, \tilde{e}_{n-k}, \tilde{f}_2, \dots, \tilde{f}_{n-k})$ by applying a diffeomorphism

$$(13.10) \quad \xi_{n,k}: \mathbb{R}^{2n-2k-1} \xrightarrow{\cong} \mathbb{R}^{2n-2k-1},$$

namely, by equating the coefficients of the polynomial $Q_1(z) = \tilde{Q}_1(z - ik)$:

$$\begin{aligned} z^{n-k} - (e_1 + i\frac{n(n+1)-k(k+1)}{2})z^{n-k-1} + \dots + (-1)^{n-k}(e_{n-k} + if_{n-k}) \\ = (z - ik)^{n-k} - (\tilde{e}_1 + i\frac{(n-k)(n-k+1)}{2})(z - ik)^{n-k-1} + \dots + (-1)^{n-k}(\tilde{e}_{n-k} + i\tilde{f}_{n-k}). \end{aligned}$$

Assume

$$\begin{aligned} \Psi_k^{-1}(c_1, \dots, c_k, d_2, \dots, d_k) &= (s_1, \dots, s_k, t_1, \dots, t_{k-1}) \in \mathbb{R}^k \times \mathbb{R}_+^{k-1} \\ \Psi_{n-k}^{-1}(\tilde{e}_1, \dots, \tilde{e}_{n-k}, \tilde{f}_2, \dots, \tilde{f}_{n-k}) &= (s_{k+1}, \dots, s_n, t_{k+1}, \dots, t_{n-1}) \in \mathbb{R}^{n-k} \times \mathbb{R}_+^{n-k-1}. \end{aligned}$$

Then the compatibility condition from Equation (13.7) states that Ψ_n must be defined on $\mathbb{R}^n \times \partial_k \mathbb{R}_+^{n-1}$ as follows:

$$\Psi_n((s_1, \dots, s_n), (t_1, \dots, t_{k-1}, 0, t_{k+1}, \dots, t_{n-1})) = (a_1, \dots, a_n, b_2, \dots, b_n).$$

This map has an explicit description in terms of Ψ_k and Ψ_{n-k} . We have

$$\Psi_k(s_1, \dots, s_k, t_1, \dots, t_{k-1}) = (c_1, \dots, c_k, d_2, \dots, d_k) \in \mathbb{R}^{2k-1}$$

$$\xi_{n,k} \circ \Psi_{n-k}(s_{k+1}, \dots, s_n, t_{k+1}, \dots, t_{n-1}) = (e_1, \dots, e_{n-k}, f_2, \dots, f_{n-k}) \in \mathbb{R}^{2n-2k-1},$$

and since $P(z) = Q_0(z)Q_1(z)$, the point $(a_1, \dots, a_n, b_2, \dots, b_n)$ can be obtained from $(c_1, \dots, c_k, d_2, \dots, d_k)$ and $(e_1, \dots, e_{n-k}, f_2, \dots, f_{n-k})$ by equating the coefficients of

$$\begin{aligned} z^n - (a_1 + i\frac{n(n+1)}{2})z^{n-1} + \dots + (-1)^n(a_n + ib_n) \\ = (z^k - (c_1 + i\frac{k(k+1)}{2})z^{k-1} + \dots + (-1)^k(c_n + id_n)) \\ \times (z^{n-k} - (e_1 + i\frac{n(n+1)-k(k+1)}{2})z^{n-k-1} + \dots + (-1)^{n-k}(e_{n-k} + if_{n-k})). \end{aligned}$$

As before, let $\Psi|_1$ denote this map $\mathbb{R}^n \times \partial \mathbb{R}_+^{n-1} \rightarrow \mathbb{R}^{2n-1}$ with image $\psi_n((\mathbb{R}^n \times \partial \Pi_n)/S_n)$. We have to extend it to a map $\Psi_n: \mathbb{R}^n \times \mathbb{R}_+^{n-1} \rightarrow \mathbb{R}^{2n-1}$ which is a diffeomorphism onto its image $\psi_n((\mathbb{R}^n \times \Pi_n)/S_n)$. Therefore, we need to check the following.

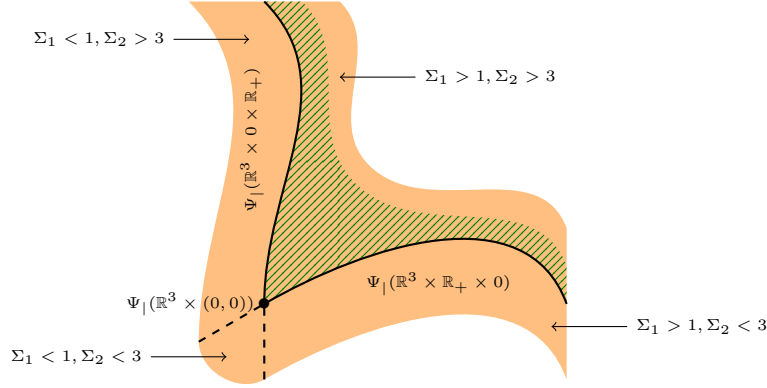

FIGURE 26. The embedding $\Psi_1: \mathbb{R}^3 \times \partial\mathbb{R}_+^2 \rightarrow \mathbb{R}^5$ (for the case $n = 3$). We have indicated the signs of the functions $\Sigma_1 - 1$ and $\Sigma_2 - 3$ in a neighborhood (shown in orange) of $\Psi_1(\mathbb{R}^3 \times \partial\mathbb{R}_+^2)$. A collar extension (shaded in green) is also shown, which will be used to extend Ψ_1 to $\Psi_3: \mathbb{R}^3 \times \mathbb{R}_+^2 \rightarrow \mathbb{R}^5$.

- (1) **Well-defined:** For well-definedness we have to prove the following couple of things.

The map Ψ_1 on $\mathbb{R}^n \times \partial_k \mathbb{R}_+^{n-1}$ was defined from the subset $S = \{1, 2, \dots, k\}$ via Equation (13.7). We need to show that for any other subset S' with $|S'| = k$, Equation (13.7) would have produced the same map. Fix any point $p' = (\alpha'_1, \dots, \alpha'_n, \beta'_1, \dots, \beta'_n) \in \mathbb{R}^n \times F_{S'}$. There exists some permutation $\sigma \in S_n$ which maps this point to some point $p = (\alpha_1, \dots, \alpha_n, \beta_1, \dots, \beta_n) \in \mathbb{R}^n \times F_S$. Since we quotient by S_n , if we start at either p or p' at the top-middle vertex of Equation (13.7) and proceed rightwards by three arrows, we will end up at the same point $(a_1, \dots, a_n, b_2, \dots, b_n) \in \mathbb{R}^{2n-1}$. However, if we proceed leftwards by one arrow, we will end up at the point

$$((\alpha_1, \dots, \alpha_k, \beta_1, \dots, \beta_k), (\alpha_{k+1}, \dots, \alpha_n, \beta_{k+1} - k, \dots, \beta_n - k)) \in (\mathbb{R}^k \times \Pi_k) \times (\mathbb{R}^{n-k} \times \Pi_{n-k});$$

this is due to way the identification $\mathbb{R}^n \xrightarrow{\cong} \mathbb{R}^k \times \mathbb{R}^{n-k}$ is set up in Equation (13.7). Therefore, the map Ψ_1 defined using the subset S' will be same as the map Ψ_1 defined using the subset $S = \{1, 2, \dots, k\}$.

We also need to check that the maps Ψ_1 , as defined on $\mathbb{R}^n \times \partial_k \mathbb{R}_+^{n-1}$ and $\mathbb{R}^n \times \partial_\ell \mathbb{R}_+^{n-1}$, agree on their common boundary $\mathbb{R}^n \times \partial_{\{k, \ell\}} \mathbb{R}_+^{n-1}$. Let $k < \ell$, and let $S = \{1, 2, \dots, k\}$ and $T = \{1, 2, \dots, \ell\}$. Using repeated applications of Equation (13.7), it is not hard to show that in either case, the map $\Psi_1: \mathbb{R}^n \times \partial_{\{k, \ell\}} \mathbb{R}_+^{n-1} \rightarrow \mathbb{R}^{2n-1}$ is given as follows. For any point $p = ((s_1, \dots, s_n), (t_1, \dots, t_{k-1}, 0, t_{k+1}, \dots, t_{\ell-1}, 0, t_{\ell+1}, \dots, t_{n-1})) \in \mathbb{R}^n \times \partial_{\{k, \ell\}} \mathbb{R}_+^{n-1}$, let

$$\begin{aligned} (c_1, \dots, c_k, d_2, \dots, d_k) &= \Psi_k(s_1, \dots, s_k, t_1, \dots, t_{k-1}) \\ (e_1, \dots, e_{\ell-k}, f_2, \dots, f_{\ell-k}) &= \xi_{\ell, k} \circ \Psi_{\ell-k}(s_{k+1}, \dots, s_\ell, t_{k+1}, \dots, t_{\ell-1}) \\ (g_1, \dots, g_{n-\ell}, h_2, \dots, h_{n-\ell}) &= \xi_{n, \ell} \circ \Psi_{n-\ell}(s_{\ell+1}, \dots, s_n, t_{\ell+1}, \dots, t_{n-1}). \end{aligned}$$

where $\xi_{\ell,k}: \mathbb{R}^{2\ell-2k-1} \rightarrow \mathbb{R}^{2\ell-2k-1}$ and $\xi_{n,\ell}: \mathbb{R}^{2n-2\ell-1} \rightarrow \mathbb{R}^{2n-2\ell-1}$ are as defined in Equation (13.10). Then $\Psi_{\lfloor}(p) = (a_1, \dots, a_n, b_2, \dots, b_n)$ is obtained by equating the coefficients of

$$\begin{aligned} & z^n - (a_1 + i\frac{n(n+1)}{2})z^{n-1} + \dots + (-1)^n(a_n + ib_n) \\ &= (z^k - (c_1 + i\frac{k(k+1)}{2})z^{k-1} + \dots + (-1)^k(c_n + id_n)) \\ &\quad \times (z^{\ell-k} - (e_1 + i\frac{\ell(\ell+1) - k(k+1)}{2})z^{\ell-k-1} + \dots + (-1)^{\ell-k}(e_{\ell-k} + if_{\ell-k})) \\ &\quad \times (z^{n-\ell} - (g_1 + i\frac{n(n+1) - \ell(\ell+1)}{2})z^{n-\ell-1} + \dots + (-1)^{n-\ell}(g_{n-\ell} + ih_{n-\ell})). \end{aligned}$$

(2) **Properly embedded:** We next have to prove $\Psi_{\lfloor}: \mathbb{R}^n \times \partial\mathbb{R}_+^{n-1} \rightarrow \mathbb{R}^{2n-1}$ is a proper smooth embedding, that is, it is a proper map which is an immersion and a diffeomorphism onto its image.

For injectivity, we first check that the image of different open strata of $\mathbb{R}^n \times \partial\mathbb{R}_+^{n-1}$ are disjoint. This follows from the observation that for any non-empty subset $J \subset \{1, 2, \dots, n-1\}$, the image of the interior of $\mathbb{R}^n \times \partial_J\mathbb{R}_+^{n-1}$ is given by

$$(13.11) \quad \{p \in \mathbb{R}^{2n-1} \mid \Sigma_k(p) = \frac{k(k+1)}{2}, \forall k \in J \text{ and } \Sigma_k(p) > \frac{k(k+1)}{2}, \forall k \notin J\}.$$

So it is now enough to show that Ψ_{\lfloor} , restricted to any open stratum, is injective. Fix any stratum $\mathbb{R}^n \times \partial_J(\mathbb{R}^n)$ with $J = \{k_1 < k_2 < \dots < k_m\}$, and fix any point

$$p = ((s_1, \dots, s_n), (t_1, \dots, t_{k_1-1}, 0, t_{k_1+1}, \dots, t_{k_2-1}, 0, t_{k_2+1}, \dots, t_{k_m-1}, 0, t_{k_m+1}, \dots, t_{n-1}))$$

in its interior. Let $\Psi_{\lfloor}(p) = (a_1, \dots, a_n, b_2, \dots, b_n) \in \mathbb{R}^{2n-1}$ and consider the polynomial

$$(13.12) \quad P(z) = z^n - (a_1 + ib_1)z^{n-1} + \dots + (-1)^n(a_n + ib_n)$$

with $b_1 = \frac{n(n+1)}{2}$. In the same vein as the definition of Ψ_{\lfloor} (and also the second part of the above argument for well-definedness), for $\ell = 0, 1, \dots, m$, define

$$(c_1^\ell, \dots, c_{k_{\ell+1}-k_\ell}^\ell, d_2^\ell, \dots, d_{k_{\ell+1}-k_\ell}^\ell) = \xi_{k_{\ell+1}, k_\ell} \circ \Psi_{k_{\ell+1}-k_\ell}(s_{k_{\ell+1}}, \dots, s_{k_{\ell+1}}, t_{k_\ell+1}, \dots, t_{k_{\ell+1}-1})$$

(with the understanding that $k_0 = 0$ and $k_{m+1} = n$), and consider the polynomial

$$(13.13) \quad Q_\ell(z) = z^{k_{\ell+1}-k_\ell} - (c_1^\ell + id_1^\ell)z^{k_{\ell+1}-k_\ell-1} + \dots + (-1)^{k_{\ell+1}-k_\ell}(c_{k_{\ell+1}-k_\ell}^\ell + id_{k_{\ell+1}-k_\ell}^\ell)$$

with $d_1^\ell = \frac{k_{\ell+1}(k_{\ell+1}+1) - k_\ell(k_\ell+1)}{2}$. Then we have

$$(13.14) \quad P(z) = Q_0(z)Q_1(z) \cdots Q_m(z)$$

and expanding the coefficients, we get $(a_1, \dots, a_n, b_2, \dots, b_n)$ as a function of $(c_1^1, \dots, c_{n-k_m}^m, d_2^1, \dots, d_{n-k_m}^m)$. The maps $\Psi_{k_{\ell+1}-k_\ell}$ are embeddings and the maps $\xi_{k_{\ell+1}, k_\ell}$ are diffeomorphisms, so the only place non-injectivity might arise is in this final map. Let $\alpha_1 + i\beta_1, \dots, \alpha_n + i\beta_n$ be the roots of $P(z)$ arranged in increasing order of their imaginary parts, that is, $\beta_1 \leq \beta_2 \leq \dots \leq \beta_n$. From Equation (13.11), we know:

$$\sum_{j=1}^k \beta_j = \frac{k(k+1)}{2}, \forall k \in J \cup \{n\}, \quad \sum_{j=1}^k \beta_j > \frac{k(k+1)}{2}, \forall k \in \{1, 2, \dots, n-1\} \setminus J$$

Therefore, for every $k \in J$,

$$(13.15) \quad \begin{aligned} \beta_k &= \sum_{j=1}^k \beta_j - \sum_{j=1}^{k-1} \beta_j \leq \frac{k(k+1)}{2} - \frac{(k-1)k}{2} = k \\ \beta_{k+1} &= \sum_{j=1}^{k+1} \beta_j - \sum_{j=1}^k \beta_j \geq \frac{(k+1)(k+2)}{2} - \frac{k(k+1)}{2} = k+1. \end{aligned}$$

Therefore, the set of k smallest β_j 's is well-defined, for every $k \in J$. Note that for every $1 \leq \ell \leq m$, the polynomial $Q_0(z)Q_1(z)\cdots Q_{\ell-1}(z)$ has roots $\alpha_j + i\beta_j$, for the k_ℓ smallest β_j 's. Therefore, the factorization from Equation (13.14) is the unique one of that form, thus completing the proof of injectivity.

Being an immersion is a local condition. Since $\mathbb{R}^n \times \partial\mathbb{R}_+^{n-1}$ is not a smooth manifold, rather the boundary of a manifold with corners, let us clarify what we mean by an immersion. For any point $p \in \mathbb{R}^n \times \partial\mathbb{R}_+^{n-1}$, we will construct a neighborhood U of p inside $\mathbb{R}^n \times \mathbb{R}^{n-1}$ and an extension of $\Psi|_U$ which is a smooth embedding. Continuing from the proof of injectivity, fix a point p in some open stratum $\mathbb{R}^n \times \mathring{\partial}_J\mathbb{R}_+^{n-1}$, and let us reuse the same notation. Instead of parametrizing $\Psi|_U(\mathbb{R}^n \times \mathring{\partial}_J(\mathbb{R}^n))$ by the parameters s_j ($1 \leq j \leq n$) and t_j ($j \in \{1, \dots, n-1\} \setminus J$), let us parametrize it by the variables c_j^ℓ ($0 \leq \ell \leq m$, $1 \leq j \leq k_{\ell+1} - k_\ell$) and d_j^ℓ ($0 \leq \ell \leq m$, $2 \leq j \leq k_{\ell+1} - k_\ell$), which is a valid reparametrization since the maps $\Psi_{k_{\ell+1}-k_\ell}$ are smooth embeddings and the maps $\xi_{k_{\ell+1}, k_\ell}$ are diffeomorphisms. As before, create and set additional variables $d_1^\ell = \frac{k_{\ell+1}(k_{\ell+1}+1) - k_\ell(k_\ell+1)}{2}$, for $0 \leq \ell \leq m$. Define the polynomials $Q_\ell(z)$ as in Equation (13.13), and if we define the polynomial $P(z)$ using Equations (13.12) and (13.14), this determines the variables $a_1, \dots, a_n, b_1, \dots, b_n$ as smooth functions of the variables (c_j^ℓ, d_j^ℓ) (with $b_1 = \frac{n(n+1)}{2}$). We now let the variables d_1^ℓ vary in small neighborhoods, and apply the same function to get the variables a_j, b_j (of course, now b_1 also varies). Since the inequalities from Equation (13.15) still hold up to some small $\epsilon > 0$, we still have $\beta_k < \beta_{k+1}$ for all $k \in J$, and therefore, the factorization from Equation (13.14) is still well-defined, and so the function $(c_j^\ell, d_j^\ell) \mapsto (a_j, b_j)$ is still injective. Since the roots of a polynomial are smooth functions of its coefficients, this is a local diffeomorphism, and therefore its linearization has rank $2n$ near p . If we restrict to the affine subspace $\sum_\ell d_1^\ell = \frac{n(n+1)}{2}$ (corresponding to the affine subspace $b_1 = \frac{n(n+1)}{2}$ in the target), we get a local diffeomorphism from some neighborhood U of p in $\mathbb{R}^n \times \mathbb{R}^{n-1}$ to some neighborhood of $\Psi|_U(p)$ in \mathbb{R}^{2n-1} .

To finish the argument that $\Psi|_U$ is a smooth embedding, we need to prove that it is a diffeomorphism onto its image. Since it is already an injective immersion, we simply have to show that the inverse map is continuous. This is again the statement that roots of a polynomial are continuous functions of its coefficients.

The statement that $\Psi|_U: \mathbb{R}^n \times \partial\mathbb{R}_+^{n-1} \rightarrow \mathbb{R}^{2n-1}$ is proper is automatic since it is an embedding with closed image $\{\bar{\Sigma} = 0\}$, where $\bar{\Sigma}$ is the function defined in Equation (13.9).

- (3) **Extendable:** Finally, we have to extend $\Psi|_U$ to a proper smooth embedding $\Psi_n: \mathbb{R}^n \times \mathbb{R}_+ \rightarrow \mathbb{R}^{2n-1}$ with image $\psi_n((\mathbb{R}^n \times \Pi_n)/S_n)$. Let $F: \mathbb{R}^n \times \mathbb{R}_+^{n-1} \rightarrow \mathbb{R}_+$ be the function

$$(s_1, \dots, s_n, t_1, \dots, t_{n-1}) \mapsto t_1 t_2 \cdots t_{n-1}.$$

Let $\mathbb{K}^{n-1} = \mathbb{R}^{n-1} \setminus \mathbb{R}_*^{n-1}$ be the union of the coordinate axes. Since $\Psi|_U$ is a proper embedding, by the collar neighborhood theorem, $\Psi|_U$ extends to an embedding—call it $\tilde{\Psi}$ —of some neighborhood

U of $\mathbb{R}^n \times \partial\mathbb{R}_+^{n-1}$ inside $\mathbb{R}^n \times \mathbb{R}^{n-1}$. (Such an extension can be obtained by patching together the local extensions—as constructed during the immersion proof earlier—using partitions of unity.) By rescaling if necessary, we may further assume U contains the subspace $F^{-1}([0, \epsilon])$ for some small $\epsilon > 0$, and $\tilde{\Psi}$ restricts to a proper smooth embedding on that subspace. See Figure 26 for the case $n = 3$, which shows $\tilde{\Psi}(U)$ (inside \mathbb{R}^5) in orange, $\tilde{\Psi}(U \cap (\mathbb{R}^3 \times \mathbb{K}^2))$ as black lines (which are solid or dashed depending on whether they are in $\Psi_{\downarrow}(\mathbb{R}^3 \times \partial\mathbb{R}_+^2)$ or not), and $\tilde{\Psi}(F^{-1}([0, \epsilon]))$ shaded in green. Then $\tilde{\Psi}(F^{-1}(\epsilon/2))$ is a smoothly properly embedded \mathbb{R}^{2n-2} inside \mathbb{R}^{2n-1} ; let A denote the component of its complement that *does not* contain $\tilde{\Psi}(U \cap (\mathbb{R}^n \times \mathbb{K}^{n-1}))$. Using Propositions 13.2 and 13.3 with $m = 2n - 2$, we get a proper smooth embedding $F^{-1}([\epsilon/2, \infty)) \rightarrow \mathbb{R}^{2n-1}$ with image A , which agrees with $\tilde{\Psi}$ on some neighborhood of $F^{-1}(\epsilon/2)$ inside $F^{-1}([\epsilon/2, \epsilon])$; therefore, it glues with $\tilde{\Psi}$ on $F^{-1}([0, \epsilon/2])$ and produces a proper smooth embedding $\Psi_n: \mathbb{R}^n \times \mathbb{R}_+^{n-1} \rightarrow \mathbb{R}^{2n-1}$.

The only thing left to check is that Ψ_n has the correct image, namely the subspace

$$\psi_n((\mathbb{R}^n \times \Pi_n)/S_n) = \{\Sigma_1 \geq 1, \dots, \Sigma_k \geq k(k+1)/2, \dots, \Sigma_{n-1} \geq (n-1)n/2\} = \{\bar{\Sigma} \geq 0\} \subset \mathbb{R}^{2n-1},$$

where $\bar{\Sigma}$ is the function defined in Equation (13.9). By the Jordan-Brouwer theorem, $\mathbb{R}^{2n-1} \setminus \Psi_{\downarrow}(\mathbb{R}^n \times \partial\mathbb{R}_+^{n-1})$ has two components. Let B be the component containing $\tilde{\Psi}(F^{-1}([0, \epsilon]))$, and therefore, $B = \Psi_n(\mathbb{R}^n \times \mathbb{R}_+^{n-1})$. Let $C = \mathbb{R}^{2n-1} \setminus \bar{B}$. The construction of Ψ_{\downarrow} ensures that $\bar{\Sigma} = 0$ precisely on $\Psi_{\downarrow}(\mathbb{R}^n \times \mathbb{R}_+^{n-1})$, hence $\bar{\Sigma} \neq 0$ on $B \cup C$. So we have to show $\bar{\Sigma} > 0$ somewhere on B and $\bar{\Sigma} < 0$ somewhere on C . Consider the point

$$p = ((0, \dots, 0), (1, 2, \dots, n)) \in \mathbb{R}^n \times \Pi_n \subset \mathbb{R}^n \times \mathbb{A}^{n-1}.$$

It is contained in the affine subspaces $\mathbb{R}^n \times \partial\mathbb{H}_S \subset \mathbb{R}^n \times \mathbb{A}^{n-1}$ from Item (II-3) for $S = \{1, 2, \dots, k\}$, $1 \leq k < n$. Consider a small open ball V around p in $\mathbb{R}^n \times \mathbb{A}^{n-1}$. These $(n-1)$ hyperplanes cut V into 2^{n-1} regions, which are distinguished by the signs of the following $(n-1)$ functions:

$$\beta_1 - 1, \beta_1 + \beta_2 - 3, \dots, \sum_{j=1}^k \beta_j - \frac{k(k+1)}{2}, \dots, \sum_{j=1}^{n-1} \beta_j - \frac{(n-1)n}{2}.$$

The unique region where all the signs are positive is the one that contains $\mathbb{R}^n \times \mathring{\Pi}_{n-1}$; therefore, the image of that region under the map $\psi_n \circ \pi$ (from Equation (13.6)) has $\bar{\Sigma} > 0$, and the image of the other $2^{n-1} - 1$ regions has $\bar{\Sigma} < 0$. From the immersion proof from before, the map $\tilde{\Psi}^{-1} \circ \psi_n \circ \pi$ is a diffeomorphism from the small open ball V around p to a (not necessarily round) small open ball W around $((0, \dots, 0), (0, \dots, 0))$ inside U inside $\mathbb{R}^n \times \mathbb{R}^{n-1}$. Under this local map, the union of the hyperplanes

$$\bigcup_{\substack{S=\{1, \dots, k\} \\ 1 \leq k < n}} V \cap (\mathbb{R}^n \times \partial\mathbb{H}_S)$$

maps to $W \cap (\mathbb{R}^n \times \mathbb{K}^{n-1})$. Therefore, one of the 2^{n-1} regions maps into $\tilde{\Psi}^{-1}(B)$, while the other $2^{n-1} - 1$ regions map into $\tilde{\Psi}^{-1}(C)$. Since $\bar{\Sigma}$ has the same sign on C , on these latter $2^{n-1} - 1$ regions, $\bar{\Sigma}$ must have the same sign, which then must be negative. (We are using $n \geq 3$, so we can distinguish the numbers $2^{n-1} - 1$ and 1.) Consequently on B , the function $\bar{\Sigma}$ must be positive, thus completing the proof. See also Figure 26. \square

13.4. Embedding and framing the moduli spaces. In this section, we will smoothly embed and frame the moduli spaces X_I , which were defined to be permutohedra in Equation (13.3). As in Equation (13.1), let $I = \{p_1 < \dots < p_n\}$. Consider the smooth embedding

$$(13.16) \quad j_I: X_I \hookrightarrow \mathbb{R}^n \times \Pi_n, \quad x \mapsto ((p_1, p_2, \dots, p_n), x),$$

which also respects the $\langle n-1 \rangle$ -manifold structure. As in the previous sections, using the linear ordering of the elements of I , it will be useful to identify the first factor \mathbb{R}^n with $\prod_I \mathbb{R}$ and to treat the second factor Π_n as embedded in $\prod_I \mathbb{R}$.

Compose with the map $\Psi_n^{-1} \circ \psi_n \circ \pi$ from Proposition 13.1 to get a smooth map of $\langle n-1 \rangle$ -manifolds

$$(13.17) \quad \Psi_n^{-1} \circ \psi_n \circ \pi \circ j_I: X_I \rightarrow \mathbb{R}^n \times \mathbb{R}_+^{n-1}.$$

Since the points p_i are distinct, every non-trivial element of the symmetric group S_n sends the subset $j_I(X_I) \subset \mathbb{R}^n \times \Pi_n$ to a disjoint subset, and therefore, the map from Equation (13.17) is a smooth embedding. To fit our requirements regarding embeddings of moduli spaces, we need to replace \mathbb{R} with $\mathring{\mathbb{R}}_+$. Fix a diffeomorphism $f: \mathbb{R} \rightarrow \mathring{\mathbb{R}}_+$, and consider the diffeomorphism

$$F: \mathbb{R}^n \times \mathbb{R}_+^{n-1} \rightarrow \mathring{\mathbb{R}}_+^n \times \mathbb{R}_+^{n-1}, \quad (s_1, \dots, s_n, t_1, \dots, t_{n-1}) \mapsto (f(s_1), \dots, f(s_n), t_1, \dots, t_{n-1}).$$

Then we embed the moduli spaces by the map

$$(13.18) \quad \iota_I := F \circ \Psi_n^{-1} \circ \psi_n \circ \pi \circ j_I: X_I \hookrightarrow \mathring{\mathbb{R}}_+^n \times \mathbb{R}_+^{n-1}.$$

We will also need to choose a framing of the normal bundle of this embedding. Due to the dimensions, at each point $x \in X_I$ this will consist entirely of an internal frame with n vectors which will span a complement to the tangent space to $\iota_I(X_I)$ in $\mathring{\mathbb{R}}_+^n \times \mathbb{R}_+^{n-1}$ at $\iota_I(x)$. The vectors in the frame are indexed by the set I ; so we will let $(v_{p_1}(x), \dots, v_{p_n}(x))$ denote the frame at x so that the vector $v_{p_i}(x)$ corresponds to the point $p_i \in I$. Let $(e_{p_1}, \dots, e_{p_n})$ be the unit vectors in $\prod_I \mathbb{R}$; they frame the normal bundle of the embedding j_I from Equation (13.16). Then define

$$(13.19) \quad v_{p_i}(x) = (d\iota_I)_x(e_{p_i}) \quad 1 \leq i \leq n, x \in X_I.$$

All that remains is to check that these embeddings and framings satisfy the required coherence conditions on their lower-dimensional strata. Fix any non-empty proper subset $J \subset I$ of cardinality k . Then there is a corresponding facet in $\partial_k X_I$ which is identified with $X_J \times X_{I \setminus J}$. To show that the embeddings are coherent, we need to check the following diagram commutes,

$$(13.20) \quad \begin{array}{ccc} X_J \times X_{I \setminus J} & \xleftarrow{(\iota_J, \iota_{I \setminus J})} & \mathring{\mathbb{R}}_+^k \times \mathbb{R}_+^{k-1} \times \mathring{\mathbb{R}}_+^{n-k} \times \mathbb{R}_+^{n-k-1} \\ \downarrow & & \downarrow \cong \\ \partial_k X_I & & \mathring{\mathbb{R}}_+^k \times \mathring{\mathbb{R}}_+^{n-k} \times \mathbb{R}_+^{k-1} \times \mathbb{R}_+^{n-k-1} \\ \downarrow \iota_I & & \downarrow \cong \\ \mathring{\mathbb{R}}_+^n \times \mathbb{R}^{n-1} & \xleftarrow{\quad} & \mathring{\mathbb{R}}_+^n \times \mathbb{R}_+^{k-1} \times \{0\} \times \mathbb{R}_+^{n-k-1}, \end{array}$$

where the identifications on the rightmost column are the usual ones by rearranging the factors. This follows from the commutativity of the following diagram:

$$\begin{array}{ccc}
X_J \times X_{I \setminus J} & \hookrightarrow & X_I \\
\downarrow (j_J, j_{I \setminus J}) & & \downarrow j_I \\
\left(\prod_J \mathbb{R} \times X_J \right) \times \left(\prod_{I \setminus J} \mathbb{R} \times X_{I \setminus J} \right) & \hookrightarrow & \prod_I \mathbb{R} \times X_I \\
\downarrow (\Psi_k^{-1} \psi_k \pi, \Psi_{n-k}^{-1} \psi_{n-k} \pi) & & \downarrow \Psi_n^{-1} \psi_n \pi \\
(\mathbb{R}^k \times \mathbb{R}_+^{k-1}) \times (\mathbb{R}^{n-k} \times \mathbb{R}_+^{n-k-1}) & \xrightarrow{\cong} & \mathbb{R}^n \times (\mathbb{R}_+^{k-1} \times \{0\} \times \mathbb{R}_+^{n-k-1}) \hookrightarrow \mathbb{R}^n \times \mathbb{R}_+^{n-1} \\
\downarrow (F, F) & & \downarrow F \\
(\mathring{\mathbb{R}}_+^k \times \mathbb{R}_+^{k-1}) \times (\mathring{\mathbb{R}}_+^{n-k} \times \mathbb{R}_+^{n-k-1}) & \xrightarrow{\cong} & \mathring{\mathbb{R}}_+^n \times (\mathbb{R}_+^{k-1} \times \{0\} \times \mathbb{R}_+^{n-k-1}) \hookrightarrow \mathring{\mathbb{R}}_+^n \times \mathbb{R}_+^{n-1}
\end{array}$$

The central pentagon commutes by Equation (13.7); the top rectangle commutes by definition (Equation (13.16)); and the bottom two rectangles commute since the map F was defined using the map f on each \mathbb{R} component.

To see that the framings are coherent, we have to show that the normal framing of ι_I from Equation (13.19) agrees with the product framing on the subspace $X_J \times X_{I \setminus J}$. However, the normal framings of the embeddings j_I from Equation (13.16) are given by the unit vectors, and so they are indeed coherent. (Recall, the vectors in the frames are indexed by the elements of I .) Since the normal framings for ι_I are defined using those unit vectors via Equation (13.19), the commutativity of Diagram (13.20) implies that the framings are coherent.

14. THE COHEN-JONES-SEGAL CONSTRUCTION

We have now constructed all moduli spaces $\overline{\mathcal{M}}_{\vec{N}, \vec{\lambda}}(D)$, along with neat embeddings in \mathbb{E}_I^d , as well as internal and external framings. It remains to put them together into a framed flow category, and then run the Cohen-Jones-Segal construction to obtain the knot Floer stable homotopy types, following the set-up in [18].

14.1. Framed flow categories. We review here some definitions from [18, Section 3.2]. One slight difference is that we allow our categories to have infinitely many objects.

Definition 14.1. A *flow category* is a category \mathcal{C} with objects $\text{Ob} = \text{Ob}(\mathcal{C})$, equipped with a function $\text{gr} : \text{Ob} \rightarrow \mathbb{Z}$ (called the grading), such that:

- $\text{Hom}(x, x) = \{\text{Id}\}$ for all $x \in \text{Ob}$;
- For all distinct $x, y \in \text{Ob}$, the morphism space $\text{Hom}(x, y)$ is a compact $(\text{gr}(x) - \text{gr}(y) - 1)$ -dimensional $(\text{gr}(x) - \text{gr}(y) - 1)$ -manifold; in particular, it is empty for $\text{gr}(x) \leq \text{gr}(y)$;
- For distinct $x, y, z \in \text{Ob}$ with $\text{gr}(x) - \text{gr}(y) = m$, the composition

$$\circ : \text{Hom}(x, y) \times \text{Hom}(x, z) \rightarrow \text{Hom}(x, y)$$

is an embedding into $\partial_m \text{Hom}(x, y)$. Moreover,

$$\circ^{-1}(\partial_i \text{Hom}(x, y)) = \begin{cases} \partial_i \text{Hom}(z, y) \times \text{Hom}(x, z) & \text{for } i < m \\ \text{Hom}(z, y) \times \partial_{i-m} \text{Hom}(x, z) & \text{for } i > m \end{cases}$$

- For distinct $x, y \in \text{Ob}$, \circ induces a diffeomorphism

$$\partial_i \text{Hom}(x, y) \cong \coprod_{\{z \mid \text{gr}(z) = \text{gr}(y) + i\}} \text{Hom}(z, y) \times \text{Hom}(x, z).$$

Given a flow category \mathcal{C} and $x, y \in \text{Ob}$, we define the *compactified moduli space from x to y* as

$$\overline{\mathcal{M}}(x, y) = \begin{cases} \emptyset & \text{if } x = y, \\ \text{Hom}(x, y) & \text{if } x \neq y. \end{cases}$$

Furthermore, for $i \in \mathbb{Z}$, we let $\text{Ob}(i) = \{x \in \text{Ob} \mid \text{gr}(x) = i\}$, topologized as a discrete space. Then, for $i, j \in \mathbb{Z}$, we define

$$\overline{\mathcal{M}}(i, j) = \coprod_{x \in \text{Ob}(i), y \in \text{Ob}(j)} \overline{\mathcal{M}}(x, y).$$

Definition 14.2. A *neat embedding* ι of a flow category \mathcal{C} relative $d \in \mathbb{N}$ is a collection of neat embeddings

$$\iota_{x,y} : \overline{\mathcal{M}}(x, y) \hookrightarrow \mathbb{E}_{\text{gr}(y) - \text{gr}(x) - 1}^d,$$

defined for every $x, y \in \text{Ob}$, such that

- For all $i, j \in \mathbb{Z}$, the union of all $\iota_{x,y}$ for $x \in \text{Ob}(i), y \in \text{Ob}(j)$ induces a neat embedding of $\overline{\mathcal{M}}(i, j)$;
- For all $x, y, z \in \text{Ob}$ and for all $(p, q) \in \overline{\mathcal{M}}(x, z) \times \overline{\mathcal{M}}(z, y)$, we have

$$\iota_{x,y}(q \circ p) = (\iota_{z,y}(q), 0, \iota_{x,z}(p)) \in \mathbb{E}_{\text{gr}(z) - \text{gr}(x) - 1}^d \times \mathbb{R}_+ \times \mathbb{E}_{\text{gr}(x) - \text{gr}(z) - 1}^d = \mathbb{E}_{\text{gr}(y) - \text{gr}(x) - 1}^d.$$

Given a neat embedding ι of \mathcal{C} , and objects $x, y \in \text{Ob}$, we let $\nu_{x,y}$ denote the normal bundle to $\overline{\mathcal{M}}(x, y)$ under the embedding $\iota_{x,y}$.

Definition 14.3. A *framed flow category* is a framed flow category \mathcal{C} together with a neat embedding ι (relative some d), and also equipped with framings for the normal bundles $\nu_{x,y}$ for all $x, y \in \text{Ob}$, such that the product framing of $\nu_{z,y} \times \nu_{x,z}$ equals the pullback framing of $\circ^* \nu_{x,y}$ for all x, y, z .

14.2. From framed flow categories to spectra. We now review how to build a CW complex, and then a suspension spectrum, from a framed flow category. We follow [18, Section 3.3], which is in turn inspired from [6].

Let $(\mathcal{C}, \iota, \phi)$ be a framed flow category, with ι denoting the neat embedding, and ϕ the normal framings. For now, we assume that the grading function $\text{gr} : \text{Ob} \rightarrow \mathbb{Z}$ is bounded, with image in some interval $[B, A]$ with $A, B \in \mathbb{Z}$. Let

$$C_d(B, A) := (A - B)d - B.$$

We construct a CW complex $|\mathcal{C}|_{\iota, \phi, B, A}$ as follows. We start with a single 0-cell, and then for each $x \in \text{Ob}$, we attach a cell $\mathcal{C}(x)$, inductively on the grading $\text{gr}(x) = m$. The cell $\mathcal{C}(x)$ will have dimension $C_d(B, A) + m$.

Let us choose $\epsilon > 0$ sufficiently small so that for all i and j , the embedding $\iota_{i,j}$ of $\overline{\mathcal{M}}_{i,j}$ into \mathbb{E}_{j-i-1}^d extends to an embedding of $\overline{\mathcal{M}}_{i,j} \times [-\epsilon, \epsilon]^{(j-i)d}$ using the normal framings. Choose R sufficiently large so that for all i and j , the image $\iota_{i,j}(\overline{\mathcal{M}}(i, j) \times [-\epsilon, \epsilon]^{(j-i)d})$ lies in

$$[-R, R]^d \times [0, R] \times \cdots \times [0, R] \times [-R, R]^d \subset \mathbb{E}_{j-i-1}^d.$$

Let us suppose we attached all the lower dimensional cells and we want to attach $\mathcal{C}(x)$, where $\text{gr}(x) = m$. Define

$$\mathcal{C}(x) = [0, R] \times [-R, R]^d \times [0, R] \times \cdots \times [0, R] \times [-R, R]^d \times \{0\} \times [-\epsilon, \epsilon]^d \times \cdots \times \{0\} \times [-\epsilon, \epsilon]^d,$$

where we have $m - B$ instances of $[0, R]$ and $[-R, R]^d$, and $A - m$ instances of $\{0\}$ and $[-\epsilon, \epsilon]^d$.

To see how to attach $\mathcal{C}(x)$ to a lower cell $\mathcal{C}(y)$ where $\text{gr}(y) = l$, consider the neat embedding $\iota_{x,y}$, extended using the framing ϕ to give an identification of $\overline{\mathcal{M}}(x, y) \times [-\epsilon, \epsilon]^d \times \cdots \{0\} \times [-\epsilon, \epsilon]^d$ with a subset $\mathcal{C}_{y,1}(x)$ of $[-R, R]^d \times [0, R] \times \cdots \times [0, R] \times [-R, R]^d$. (Here $[-R, R]^d$ and $[0, R]$ appear $m - l$ times each.) Let

$$\mathcal{C}_y(x) = [0, R] \times [-R, R]^d \times [0, R] \times \cdots \times [0, R] \times [-R, R]^d \times \{0\} \times \mathcal{C}_{y,1}(x) \times \{0\} \times [-\epsilon, \epsilon]^d \times \cdots \{0\} \times [-\epsilon, \epsilon]^d,$$

where we have $l - B$ instances $[0, R]$ and $[-R, R]^d$, and still $A - m$ instances of $\{0\}$ and $[-\epsilon, \epsilon]^d$. We view $\mathcal{C}_y(x)$ as a subset of $\partial\mathcal{C}(x)$.

We then define the attaching map from $\partial\mathcal{C}(x)$ to the lower skeleton to be the projection to $\mathcal{C}(y)$ on each $\mathcal{C}_y(x) \cong \overline{\mathcal{M}}(x, y) \times \mathcal{C}(y)$, and to map everything else to the basepoint.

After attaching all the cells $\mathcal{C}(x)$, we obtain the desired CW complex $|\mathcal{C}|_{\iota, \phi, B, A}$. Its dependence on A and B is explained in [18, Lemma 3.26]. It is proved there that, if we have $B' \leq B$ and $A' \geq A$, then there is a homotopy equivalence

$$(14.1) \quad \Sigma^{C_d(B', A') - C_d(B, A)} |\mathcal{C}|_{\iota, \phi, B, A} \xrightarrow{\sim} |\mathcal{C}|_{\iota, \phi, B', A'}.$$

It follows that the formal desuspensions $\Sigma^{-C_d(B, A)} |\mathcal{C}|_{\iota, \phi, B, A}$ are equivalent in the Spanier-Whitehead stable homotopy category. In fact, we can define the following spectrum canonically:

$$S(\mathcal{C}, \iota, \phi) := \text{colim}_{A, B} \Sigma^{-C_d(B, A)} \Sigma^\infty |\mathcal{C}|_{\iota, \phi, B, A},$$

where Σ^∞ denotes the suspension spectrum associated to a topological space, and the colimit is taken using de-suspensions of the maps (14.1), as $A \rightarrow \infty$ and $B \rightarrow -\infty$.

So far we have worked under the assumption that the grading function gr is bounded. Let us relax this assumption by requiring only that gr is bounded below, by some constant B . For every $K \in \mathbb{Z}$, there is a full subcategory $\mathcal{C}_{\leq K}$ of \mathcal{C} , whose objects are those $x \in \text{Ob}$ with $\text{gr}(x) \leq K$. Restricting the embeddings and framings from \mathcal{C} , we turn $\mathcal{C}_{\leq K}$ into a framed flow category, where gr is bounded. Therefore, we have spectra $S(\mathcal{C}_{\leq K}, \iota, \phi)$ for all K . Furthermore, for $K \leq K' \leq A$, we have inclusions

$$|\mathcal{C}_{\leq K}|_{\iota, \phi, B, A} \hookrightarrow |\mathcal{C}_{\leq K'}|_{\iota, \phi, B, A}.$$

Taking the colimit over A and B , we get a map

$$S(\mathcal{C}_{\leq K}, \iota, \phi) \rightarrow S(\mathcal{C}_{\leq K'}, \iota, \phi).$$

We define

$$S(\mathcal{C}, \iota, \phi) := \text{colim}_K S(\mathcal{C}_{\leq K}, \iota, \phi).$$

Thus, we have spectra associated to framed Floer category even when gr is only bounded below. We can try to eliminate this hypothesis too. If gr is not bounded below, we have framed flow categories $\mathcal{C}_{\geq L}$ with objects those $x \in \text{Ob}$ with $\text{gr}(x) \geq L$. There are associated spectra $S(\mathcal{C}_{\geq L}, \iota, \phi)$. Projections between CW complexes (collapsing the lower dimensional cells up to some degree) induce maps

$$S(\mathcal{C}_{\geq L'}, \iota, \phi) \leftarrow S(\mathcal{C}_{\geq L}, \iota, \phi)$$

for all $L' \leq L$. This gives an inverse system of spectra, i.e., a pro-spectrum as in [6]. In this case, we define $S(\mathcal{C}, \iota, \phi)$ to be this pro-spectrum.

14.3. The knot Floer spectrum. We can now define the spectrum $\mathcal{X}^+(\mathbb{G})$ associated to a grid diagram \mathbb{G} , as advertised in the introduction.

In Section 12.7 we glued together the moduli spaces $\overline{\mathcal{M}}_0(D)$ for D in the same equivalence class, with the result being smooth $\langle k \rangle$ -manifolds $\overline{\mathcal{M}}([D])$. Since $\vec{N} = \vec{0}$, the thick dimension of these moduli spaces equals their actual dimension k , so the internal framings are empty. We have neat embeddings of $\overline{\mathcal{M}}([D])$ into \mathbb{E}_t^d , as well as normal (external) framings for these embeddings.

Recall from Section 2.2 that the grid complex $GC^+(\mathbb{G})$ has generators

$$[x, j_1, \dots, j_n] = U_1^{-j_1} \dots U_n^{-j_n} x$$

for $x \in \mathbb{S}$ and $j_1, \dots, j_n \in \mathbb{N}$. The generators also have Alexander multi-gradings $(A_1, \dots, A_\ell) \in (\frac{1}{2}\mathbb{Z})^\ell$, one for each component of the link L represented by \mathbb{G} .

Let us fix

$$h = (h_1, \dots, h_\ell) \in (\frac{1}{2}\mathbb{Z})^\ell.$$

We define a framed flow category $\mathcal{C}^+(\mathbb{G}, h)$ as follows. The objects are the generators of GC^+ with Alexander multi-grading equal to h , and we let gr be the Maslov grading. Given two objects $[x, j_1, \dots, j_n]$ and $[y, i_1, \dots, i_n]$, there is at most one domain $D \in \mathcal{D}^+(x, y)$ with $\mathbb{O}(D) = (j_1 - i_1, \dots, j_n - i_n)$ and $\mathbb{X}(D) = (0, \dots, 0)$. Since D does not pass over any X markings, it cannot contain a full row or column, so in fact D is unique in its equivalence class $[D]$. We let

$$\overline{\mathcal{M}}([x, j_1, \dots, j_n], [y, i_1, \dots, i_n]) = \overline{\mathcal{M}}([D]).$$

The enumeration of strata in Section 9.1 ensures that the conditions in the definition of a flow category are satisfied. Furthermore, the neat embeddings and the external framings turn $\mathcal{C}^+(\mathbb{G}, h)$ into a framed flow category. The compatibility conditions in Definitions 14.2 and 14.3 are satisfied because in the construction of the moduli spaces in Section 12, we started with their boundaries, and we used the product embeddings and framings for those boundary strata.

Since the generators of $GC^+(\mathbb{G})$ are bounded below in Maslov grading, we obtain a *knot Floer spectrum*

$$\mathcal{X}^+(\mathbb{G}, h) := S(\mathcal{C}^+(\mathbb{G}, h)).$$

By construction, its homology is the grid homology in Alexander multi-grading h :

$$\tilde{H}_i(\mathcal{X}^+(\mathbb{G}, h); \mathbb{Z}) \cong GH_i^+(\mathbb{G}, h).$$

If we are interested in only the total Alexander grading $A = A_1 + \dots + A_\ell$, we write

$$\mathcal{X}_j^+(\mathbb{G}) := \bigvee_{h_1 + \dots + h_\ell = j} \mathcal{X}^+(\mathbb{G}, h).$$

We can also take the wedge sum over all Alexander gradings, and set

$$\mathcal{X}^+(\mathbb{G}) := \bigvee_j \mathcal{X}_j^+(\mathbb{G}).$$

There is an additional structure given by the U_i maps. Suppose the marking U_i lies on the k^{th} component of the link. Consider the framed flow category obtained from $\mathcal{C}^+(\mathbb{G}, h)$ by removing the objects $[x, j_1, \dots, j_n]$ where $j_i = 0$. By mapping

$$[x, j_1, \dots, j_i, \dots, j_n] \mapsto [x, j_1, \dots, j_i - 1, \dots, j_n]$$

we get an isomorphism between this subcategory and $\mathcal{C}^+(\mathbb{G}, h - \vec{e}_k)[2]$, a category which is the same as $\mathcal{C}^+(\mathbb{G}, h - \vec{e}_k)$ except the Maslov grading is shifted by 2. (Here, \vec{e}_k is the unit vector in the k th coordinate.) At the level of the associated CW complexes and then spectra, we obtain a map

$$U_i : \mathcal{X}^+(\mathbb{G}, h) \rightarrow \Sigma^2 \mathcal{X}^+(\mathbb{G}, h - \vec{e}_k)$$

given by collapsing the cells corresponding to generators $[x, j_1, \dots, j_n]$ where $j_i = 0$. If we combine the Alexander multi-gradings into one, we can write

$$U_i : \mathcal{X}_j^+(\mathbb{G}) \rightarrow \Sigma^2 \mathcal{X}_{j-1}^+(\mathbb{G}).$$

14.4. Other versions. Several other variants of grid complexes were mentioned in Section 2.2. For \widehat{GC} and \widetilde{GC} , we construct knot Floer spectra $\widehat{\mathcal{X}}(\mathbb{G})$ and $\widetilde{GS}(\mathbb{G})$ in the same way as we did for GC^+ , but using fewer generators to define the framed Floer categories. In the case of \widehat{GC} , we only use those $[x, j_1, \dots, j_n]$ where $j_i = 0$ for one index i chosen from the O -markings on each link component. In the case of \widetilde{GC} , we only use the generators where $j_i = 0$ for all i . We then take the full subcategories of $\mathcal{C}^+(\mathbb{G}, h)$ with those generators as objects.

In the case of GC^- , the Maslov grading on generators is not bounded below. Nevertheless, we can still construct a framed flow category and CW complexes as before. As explained at the end of Section 14.2, the resulting object $\mathcal{X}^-(\mathbb{G})$ is a pro-spectrum instead of a spectrum.

When L is a link, we also have the grid complex $GC^{+'}$, whose filtered chain homotopy type has more information than GC^+ . In this case, to build the framed flow category, we also use moduli spaces $\overline{\mathcal{M}}([D])$ coming from domains that can go over some of the X -markings; therefore, there can be several domains in the same equivalence class $[D]$. Proceeding as before, we get a spectrum $\mathcal{X}^{+'}(\mathbb{G})$ which decomposes as a wedge sum according to a single-valued Alexander grading, from the link component that contains X_n . The other link components produce filtrations rather than gradings on the spectrum $\mathcal{X}^{+'}(\mathbb{G})$.

14.5. Examples. In some cases, the knot Floer spectra are determined by their homology. Indeed, we have the following well-known result:

Proposition 14.4. *Suppose that the (reduced) homology of a spectrum \mathcal{X} is free abelian and supported in at most two consecutive gradings; i.e. it is isomorphic to $\mathbb{Z}^k \oplus \mathbb{Z}^l$, with \mathbb{Z}^k in homological grading d and \mathbb{Z}^l in homological grading $d + 1$. Then \mathcal{X} is homotopy equivalent to the wedge sum of k copies of the (suspended) sphere spectrum S^d and l copies of S^{d+1} .*

Proof. By the Hurewicz theorem we have $\pi_d(\mathcal{X}) \cong \mathbb{Z}^k$, so there is a map $f : \vee^k S^d \rightarrow \mathcal{X}$ inducing an isomorphism on H_d . The cone of this map has homology \mathbb{Z}^l supported in degree l ; applying the Hurewicz theorem again, together with Whitehead's theorem, tells us that this cone is equivalent to $\vee^l S^{d+1}$. From the coexact sequence of f it follows that \mathcal{X} is equivalent to the cone of a map $\vee^l S^d \rightarrow \vee^k S^d$. This map is zero on homology, and therefore zero by the Hopf theorem. The conclusion follows. \square

Example 14.5. Suppose the grid diagram \mathbb{G} represents the unknot U . The knot Floer homology $\widehat{HFK}(U) \cong \widehat{GH}(\mathbb{G})$ is isomorphic to \mathbb{Z} , supported in Maslov and Alexander degrees 0. The plus version $HFK^+(U) \cong GH^+(\mathbb{G})$ is supported in Maslov-Alexander degrees $(2j, j)$ for all $j \geq 0$, and is isomorphic to \mathbb{Z} in each of those bi-degrees. Using Proposition 14.4, we deduce that

$$\widehat{\mathcal{X}}_j(\mathbb{G}) \sim \begin{cases} S^0 & \text{if } j = 0, \\ * & \text{otherwise;} \end{cases} \quad \mathcal{X}_j^+(\mathbb{G}) \sim \begin{cases} S^{2j} & \text{if } j \geq 0, \\ * & \text{otherwise.} \end{cases}$$

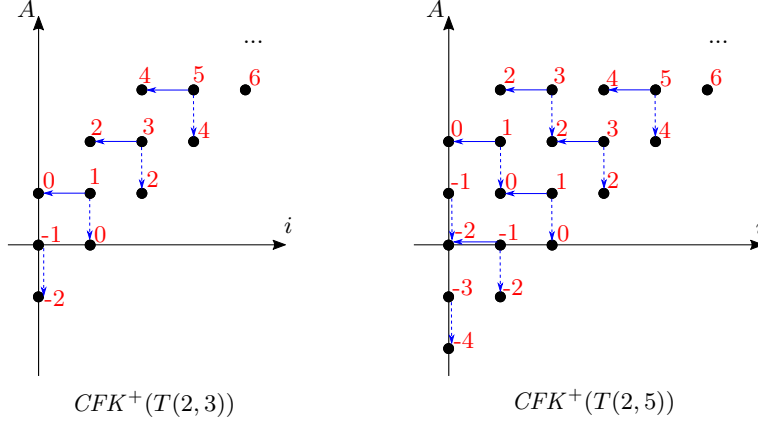

FIGURE 27. The knot Floer complexes for the torus knots $T(2, 3)$ and $T(2, 5)$. Each dot represents a generator, and the blue arrows are differentials. The horizontal coordinate i tells us that the generators are of the form $[x, i] = U^{-i}x$, and the vertical coordinate is the Alexander grading. The Maslov grading of each generator is written in red. When we consider the associated graded $gCFK^+$ whose homology is HFK^+ , the vertical dashed arrows disappear, and we only have the horizontal arrows in the differential.

Moreover, the maps $U_i : GH_j^+(\mathbb{G}) \rightarrow \Sigma^2 GH_{j-1}^+(\mathbb{G})$ are isomorphisms, because they are so at the homology level, and we have $\{S^{2j}, S^{2j}\} \cong \mathbb{Z}$ by the Hopf theorem.

Example 14.6. Let K be the right-handed trefoil, i.e., the torus knot $T(2, 3)$. Its knot Floer homology is well-known; see [34] or [27]. The knot Floer complex $CFK^+(K)$ is pictured on the left of Figure 27. The homology $\widehat{HFK}(K, j)$ is given by the dots in position $(0, j)$, and we see that there is at most one dot in a given position. The homology $HFK^+(K, j)$ is computed using the differentials on the horizontal line $A = j$. We get that it is 2-dimensional when $j = 0$ (in which case the two generators are in consecutive Maslov gradings), and is at most 1-dimensional for all other j . From Proposition 14.4 we deduce that

$$\widehat{\mathcal{X}}_j(\mathbb{G}) \sim \begin{cases} S^{j-1} & \text{if } j \in \{-1, 0, 1\}, \\ * & \text{otherwise;} \end{cases} \quad \mathcal{X}_j^+(\mathbb{G}) \sim \begin{cases} S^{2j} & \text{if } j = -1 \text{ or } j \geq 1, \\ S^{-1} \vee S^0 & \text{if } j = -0, \\ * & \text{otherwise.} \end{cases}$$

More generally, suppose the grid diagram \mathbb{G} represents a knot K that is either δ -thin (for example, an alternating knot) or an L-space knot (for example, a torus knot); cf. [33, Section 3.3], [27], [29]. Then, the hat version of the knot Floer homology of K has the property that, for every Alexander grading j there is an $n_j \in \mathbb{N}$ such that

$$\widehat{HFK}(K, j) \cong \mathbb{Z}^{n_j}$$

and this group is supported in a unique Maslov grading δ_j . Another application of Proposition 14.4 shows that

$$\widehat{\mathcal{X}}_j(\mathbb{G}) \sim \underbrace{S^{\delta_j} \vee \dots \vee S^{\delta_j}}_{n_j \text{ times}}.$$

On the other hand, for a typical knot K of this kind, the plus version $\mathcal{X}_j^+(\mathbb{G})$ is not uniquely determined by its homology.

Example 14.7. Let K be the torus knot $T(2, 5)$. This is both alternating and an L-space knot. Its knot Floer complex is pictured on the right of Figure 27. Arguing as in Example 14.6, we get

$$\widehat{\mathcal{X}}_j(\mathbb{G}) \sim \begin{cases} S^{j-2} & \text{if } |j| \leq 2, \\ * & \text{otherwise;} \end{cases} \quad \mathcal{X}_j^+(\mathbb{G}) \sim \begin{cases} S^{2j} & \text{if } j \in \{-2, 0\} \text{ or } j \geq 2, \\ S^{-3} \vee S^{-2} & \text{if } j = -1, \\ * & \text{if } j \leq -3. \end{cases}$$

This leaves the case $j = 1$, when the homology $HF\mathcal{K}^+(K, j)$ has two generators in Maslov gradings -1 and 2 . The same reasoning as in the proof of Proposition 14.4 tells us that $\mathcal{X}_1^+(\mathbb{G})$ is the cone of a stable map $\tau : S^1 \rightarrow S^{-1}$. There are two possibilities for this map, because the second stable stem is $\pi_2^{\text{st}}(S^0) \cong \mathbb{Z}/2$. We expect that τ is the zero map, so that $\mathcal{X}_1^+(\mathbb{G}) \sim S^{-1} \vee S^2$. We leave the calculation of τ for future work.

REFERENCES

- [1] Mohammed Abouzaid and Andrew Blumberg. Arnold Conjecture and Morava K-theory. Preprint, [arXiv:2103.01507v1](#).
- [2] Jonathan M. Bloom. A link surgery spectral sequence in monopole Floer homology. *Adv. Math.*, 226(4):3216–3281, 2011.
- [3] Karol Borsuk and Stanislaw Ulam. On symmetric products of topological spaces. *Bull. Amer. Math. Soc.*, 37(12):875–882, 1931.
- [4] Morton Brown. A proof of the generalized Schoenflies theorem. *Bull. Amer. Math. Soc.*, 66:74–76, 1960.
- [5] Jean Cerf. Topologie de certains espaces de plongements. *Bull. Soc. Math. France*, 89:227–380, 1961.
- [6] R. L. Cohen, J. D. S. Jones, and G. B. Segal. Floer’s infinite-dimensional Morse theory and homotopy theory. In *The Floer memorial volume*, volume 133 of *Progr. Math.*, pages 297–325. Birkhäuser, Basel, 1995.
- [7] Ralph L. Cohen. The Floer homotopy type of the cotangent bundle. *Pure Appl. Math. Q.*, 6(2, Special Issue: In honor of Michael Atiyah and Isadore Singer):391–438, 2010.
- [8] Adrien Douady. Variétés à bord anguleux et voisinages tubulaires. In *Séminaire Henri Cartan, 1961/62, Exp. 1*, page 11. Secrétariat mathématique, Paris, 1961/1962.
- [9] Christopher G. Gibson, Klaus Wirthmüller, Andrew A. du Plessis, and Eduard J. N. Looijenga. *Topological stability of smooth mappings*. Lecture Notes in Mathematics, Vol. 552. Springer-Verlag, Berlin-New York, 1976.
- [10] Jennifer Hom. A survey on Heegaard Floer homology and concordance. *J. Knot Theory Ramifications*, 26(2):1740015, 24, 2017.
- [11] Klaus Jänich. On the classification of $O(n)$ -manifolds. *Math. Ann.*, 176:53–76, 1968.
- [12] Tirasan Khandhawit, Jianfeng Lin, and Hirofumi Sasahira. Unfolded Seiberg-Witten Floer spectra, I: Definition and invariance. *Geom. Topol.*, 22(4):2027–2114, 2018.
- [13] Robion C. Kirby. On the set of non-locally flat points of a submanifold of codimension one. *Ann. of Math. (2)*, 88:281–290, 1968.
- [14] Robion C. Kirby and Laurence C. Siebenmann. *Foundational essays on topological manifolds, smoothings, and triangulations. (AM-88)*. Princeton University Press, 1977.
- [15] Thomas Kragh. Parametrized ring-spectra and the nearby Lagrangian conjecture. *Geom. Topol.*, 17(2):639–731, 2013. With an appendix by Mohammed Abouzaid.
- [16] Gerd Laues. On cobordism of manifolds with corners. *Trans. Amer. Math. Soc.*, 352(12):5667–5688, 2000.
- [17] Tyler Lawson, Robert Lipshitz, and Sucharit Sarkar. Khovanov homotopy type, Burnside category and products. *Geom. Topol.*, 24(2):623–745, 2020.
- [18] Robert Lipshitz and Sucharit Sarkar. A Khovanov stable homotopy type. *J. Amer. Math. Soc.*, 27(4):983–1042, 2014.
- [19] Ciprian Manolescu. Seiberg-Witten-Floer stable homotopy type of three-manifolds with $b_1 = 0$. *Geom. Topol.*, 7:889–932, 2003.
- [20] Ciprian Manolescu. An introduction to knot Floer homology. In *Physics and mathematics of link homology*, volume 680 of *Contemp. Math.*, pages 99–135. Amer. Math. Soc., Providence, RI, 2016.

- [21] Ciprian Manolescu, Peter Ozsváth, and Sucharit Sarkar. A combinatorial description of knot Floer homology. *Ann. of Math. (2)*, 169(2):633–660, 2009.
- [22] Ciprian Manolescu, Peter Ozsváth, Zoltán Szabó, and Dylan Thurston. On combinatorial link Floer homology. *Geom. Topol.*, 11:2339–2412, 2007.
- [23] Ciprian Manolescu, Peter S. Ozsváth, and Dylan P. Thurston. Grid diagrams and Heegaard Floer invariants. Preprint, [arXiv:0910.0078v3](https://arxiv.org/abs/0910.0078v3).
- [24] John Mather. Notes on topological stability. *Bull. Amer. Math. Soc. (N.S.)*, 49(4):475–506, 2012.
- [25] B. C. Mazur. On embeddings of spheres. *Acta Math.*, 105:1–17, 1961.
- [26] Marston Morse. A reduction of the Schoenflies extension problem. *Bull. Amer. Math. Soc.*, 66:113–115, 1960.
- [27] Peter Ozsváth and Zoltán Szabó. Heegaard Floer homology and alternating knots. *Geom. Topol.*, 7:225–254, 2003.
- [28] Peter Ozsváth and Zoltán Szabó. Holomorphic disks and knot invariants. *Adv. Math.*, 186(1):58–116, 2004.
- [29] Peter Ozsváth and Zoltán Szabó. On knot Floer homology and lens space surgeries. *Topology*, 44(6):1281–1300, 2005.
- [30] Peter Ozsváth and Zoltán Szabó. Holomorphic disks, link invariants and the multi-variable Alexander polynomial. *Algebr. Geom. Topol.*, 8(2):615–692, 2008.
- [31] Peter Ozsváth and Zoltán Szabó. An overview of knot Floer homology. In *Modern geometry: a celebration of the work of Simon Donaldson*, volume 99 of *Proc. Sympos. Pure Math.*, pages 213–249. Amer. Math. Soc., Providence, RI, 2018.
- [32] Peter S. Ozsváth, András I. Stipsicz, and Zoltán Szabó. *Grid homology for knots and links*, volume 208 of *Mathematical Surveys and Monographs*. American Mathematical Society, Providence, RI, 2015.
- [33] Jacob Rasmussen. Knot polynomials and knot homologies. In *Geometry and topology of manifolds*, volume 47 of *Fields Inst. Commun.*, pages 261–280. Amer. Math. Soc., Providence, RI, 2005.
- [34] Jacob Andrew Rasmussen. *Floer homology and knot complements*. ProQuest LLC, Ann Arbor, MI, 2003. Thesis (Ph.D.)—Harvard University.
- [35] Sucharit Sarkar. Grid diagrams and shellability. *Homology Homotopy Appl.*, 14(2):77–90, 2012.
- [36] Hirofumi Sasahira and Matthew Stoffregen. Seiberg-Witten Floer spectra for $b_1 > 0$. Preprint, [arXiv:2103.16536v1](https://arxiv.org/abs/2103.16536v1).
- [37] L. C. Siebenmann. Infinite simple homotopy types. *Nederl. Akad. Wetensch. Proc. Ser. A 73 = Indag. Math.*, 32:479–495, 1970.
- [38] R. Thom. Ensembles et morphismes stratifiés. *Bull. Amer. Math. Soc.*, 75:240–284, 1969.
- [39] René Thom. Propriétés différentielles locales des ensembles analytiques (d’après H. Whitney). In *Séminaire Bourbaki, Vol. 9*, pages Exp. No. 281, 69–80. Soc. Math. France, Paris, 1995.
- [40] Hassler Whitney. Local properties of analytic varieties. In *Differential and Combinatorial Topology (A Symposium in Honor of Marston Morse)*, pages 205–244. Princeton Univ. Press, Princeton, N. J., 1965.
- [41] Günter M. Ziegler. *Lectures on polytopes*, volume 152 of *Graduate Texts in Mathematics*. Springer-Verlag, New York, 1995.

DEPARTMENT OF MATHEMATICS, STANFORD UNIVERSITY, STANFORD, CA 94305
 Email address: cm5@stanford.edu

DEPARTMENT OF MATHEMATICS, UNIVERSITY OF CALIFORNIA, LOS ANGELES, CA 90095
 Email address: sucharit@math.ucla.edu