

A method for estimating the entropy of time series using artificial neural network

Andrei Velichko¹ and Hanif Heidari^{2*}

¹Institute of Physics and Technology, Petrozavodsk State University, 31 Lenina Str., 185910
Petrozavodsk, Russia,

²Department of Applied Mathematics, Damghan University, Damghan, Iran

*Corresponding author: heidari@du.ac.ir; Tel.: +98-23-35220092

Abstract

Measuring the predictability and complexity of time series is an essential tool in designing and controlling the nonlinear system. There exist different entropy measures in the literature to analyze the predictability and complexity of time series. However, these measures have some drawbacks especially in short time series. To overcome the difficulties, this paper proposes a new method for estimating the entropy of a time series using the LogNet 784:25:10 neural network model. The LogNet reservoir matrix consists of 19625 elements which is filled with the time series elements. After that, the network is trained on MNIST-10 dataset and the classification accuracy is calculated. The accuracy is considered as the entropy measure and denoted by NNetEn. A more complex transformation of the input information by the time series in the reservoir leads to higher NNetEn values. Many practical time series data have less than 19625 elements. Some duplicating or stretching methods are investigated to overcome this difficulty and the most successful method is identified for practical applications. The epochs number in the training process of LogNet is considered as the input parameter. A new time series characteristic called time series learning inertia is introduced to investigate the effect of epochs number in the efficiency of neural network. To show the robustness and efficiency of the proposed method, it is applied on some chaotic, periodic, random, binary and constant time series. The NNetEn is compared with some existing entropy measures. The results show that the proposed method is more robust and accurate than existing methods.

Keywords: Entropy, time series, neural network, classification, MNIST-10 database, LogNet.

1. Introduction

Measuring the regularity of dynamical system is one of hot topics in science and engineering. For example, it is used to investigate the healthy and disease state in medical science [1][2], real time anomaly detection in the dynamical network such as hacks in communication network [3] and earthquake prediction [4]. Different statistical and mathematical methods are explored to measure the degree of complexity in time series data, for example, Kolmogorov complexity measure [5], C_1/C_2 complexity measure [5] and entropy [6] are introduced.

Entropy is a thermodynamics concept which measures the molecular disorder in a closed system. This concept is used in nonlinear dynamical system to quantify the degree of complexity. Entropy is an interesting tool for analyzing the time series since it does not consider any constraints on the probability distribution [7]. Shannon entropy (ShEn) and conditional entropy (ConEn) are basis measures for evaluating the entropy. The ShEn and ConEn measure the amount of information and the rate of information production respectively [1]. Based on these measures, various entropy measures are introduced for evaluating the complexity of time series. For example, Letellier used recurrence plots to estimate ShEn [8]. Permutation entropy (PerEn) is a popular entropy measure which investigates the permutation pattern in time series [9]. Pincus introduced the approximate entropy (ApEn) measure which is a commonly used in the literature [10]. Sample entropy (SaEn) is another entropy measure which introduced by Richman and Moorman [11]. The ApEn and SaEn measures are based on ConEn. All these methods are based on the probability distribution and have some shortcomings such as sensitivity in short length time series [12], equality in time series [6] and lack of information related to the sample differences in amplitude

[9]. To overcome these difficulties, many researchers attempted to modify the methods. For example, Azami and Escudero introduced fluctuation-based dispersion entropy to deal with the fluctuations of time series [1]. Letellier used recurrent plots to evaluate Shannon entropy in time series with noise contamination. Watt and Politi investigated the efficiency of PE method and introduce some modifications to speed up the convergence of the method [13]. Molavipour et al used neural network to approximate the probabilities in mutual information formula which is based on ShEn [14]. Martinez-Garcia et al applied deep recurrent neural network to approximate the probability distribution of the system outputs [15].

In this paper, we propose a new technique for evaluating the complexity of a time series which has completely different structure than the current methods. Unlike the existed method, it computes the entropy directly without considering or approximating probability distributions. The proposed method is constructed based on LogNNNet which is an artificial neural network model [16]. It is possible to use LogNNNet for estimating the entropy of time series since the transformation of inputs are done by the time series which affects the classification accuracy. A more complex transformation of the input information which is done by the time series in the reservoir part results higher classification accuracy in LogNNNet. The measure of entropy is defined as the classification accuracy and denoted by NNetEn.

The model has some advantages compared with the existing entropy-based methods as follows

- It gives a unique algorithm for evaluating the complexity of time series with every given length.
- It has good performance in the time series with some equal values.
- It is simple to use.
- It outperforms than existing methods.

The rest of the paper is organized as follows. Section 2 is devoted to introduce preliminaries and discuss the proposed method. The numerical examples and results are given in Section 3. The discussion and some future works are given in Section 4.

2. Methods

2.1 LogNNNet model for entropy calculation

This paper uses the artificial neural network LogNNNet model to measure the complexity of nonlinear time series. The LogNNNet is a classification model which is applied on MNIST-10 database successfully [16]. Recently [17], the authors show that the accuracy of the classification is directly related to the degree of irregularity of the reservoir function. This paper applies the LogNNNet 784:25:10 model on the handwritten numbers MNIST-10 ($28 \times 28 = 784$ pixels image) dataset for calculating the entropy measure. The model consists two parts (see Fig. 1). The first part is the reservoir of the model which uses the matrix W_1 to transform the input vector Y into another vector S_h . The second part of the model used feedforward neural network to classify the input vector S_h into digits 0-9 at the output layer S_{out} . The proposed algorithm is as follows.

Step 1. The initial weights W_2 are set to 0.5 unlike the Ref. [16] which were set randomly. The constant initial weights ensure repeatable entropy results. The learning rate of back propagation method sets to 0.3 and the set of input images are transformed to an array of vectors Y using T-pattern-3 [16].

Step 2. The reservoir matrix W_1 is constructed using the given time series (see subsection 2.1.).

Step 3. Sets the number of training epochs.

Step 4. The process of training the LogNNet 784:25:10 network is carried out on a training set (60,000 MNIST-10 images).

Step 5. The process of testing the LogNNet 784:25:10 network is carried out on a test sample (10000 MNIST-10 images) and the classification accuracy is calculated.

Step 6. The classification accuracy is considered as the new entropy measure, denoted by NNetEn (see Eq. (1)).

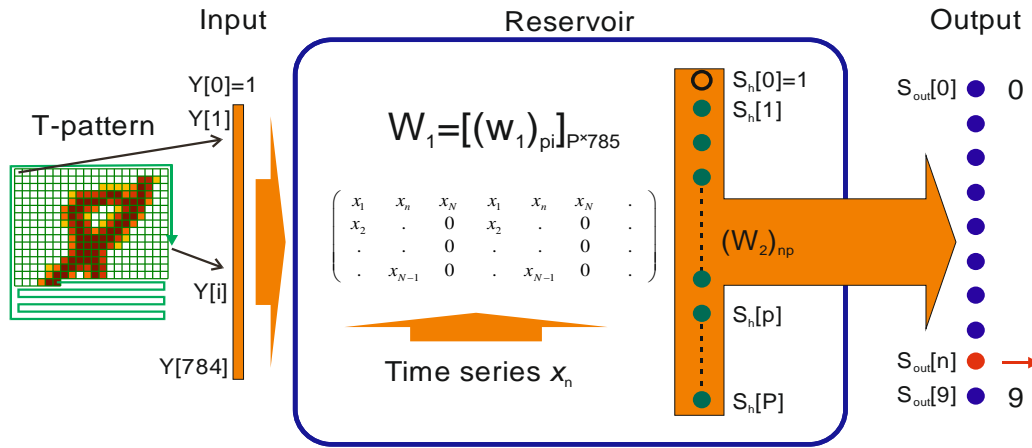

Fig. 1. The LogNNet model structure.

The value of NNetEn entropy is defined as follows:

$$\text{NNetEn} = \frac{\text{Classification accuracy}}{100\%} \quad (1)$$

The classification accuracy distributed in the range from 0 to 100%, and NNetEn has the values between 0 and 1.

The NNetEn is a valid entropy measure since it is directly related to the degree of complexity of the matrix W_1 . The matrix W_1 is used in the reservoir part of the model whose their elements are constructed by the time series. The more complex the transformation method of the input information by the time series in the reservoir, the higher the classification accuracy of LogNNet.

Based on Step 1, the matrix W_1 contains $P = 25$ rows and 785 columns. Thus, 19625 elements are required to construct the matrix W_1 . However, the length of the given time series is less than 19625 in many real world problems. Therefore, some filling methods are suggested to deal with this problem in the subsection 2.1.

2.1 Matrix filling methods

Suppose that we have a time series with N elements. If $N > 19625$, it is necessary to ignore $N-19625$ elements of time series and fill the matrix with the remained elements. This case occurs infrequency in real world applications. However, we suggest ignore the first elements as the transient period. Many mathematical and physical systems have the transient period before dynamics stabilizes. This also holds for discrete chaotic maps. Therefore, the first 1000 elements of chaotic discrete maps are ignored (see Section 3). If $N < 19625$, we offer six different filling methods based on row-by-row and column-by-column matrix fillings as follows. As an example, a reduced matrix W_l will be shown filled with the series $x_n = n$, where n varies from 1 to 9.

Method 1: Row-by-row filling with duplication

This method implies row-by-row filling of the matrix W_1 , with duplication of the row for subsequent elements, as shown in Fig. 2.

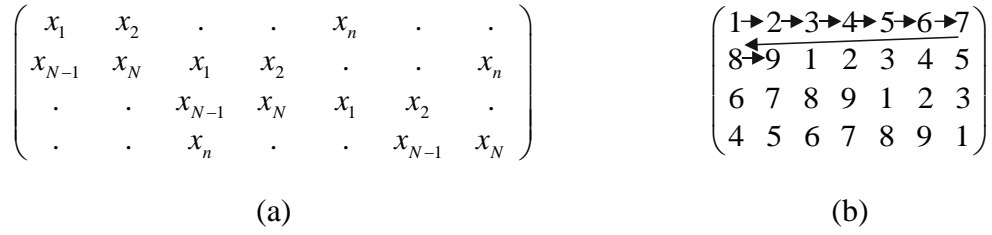

Figure 2. (a) The structure of matrix filling method 1; (b) An example of time series with 9 elements (b).

Method 2: Row-by-row filling with additional zero element.

The method is similar with row-by-row matrix filling method. We consider the zero values for the remaining elements in the matrix row if the row cannot fill with all elements of the given time series. A schematic description and an example of this method are given in Fig. 3.

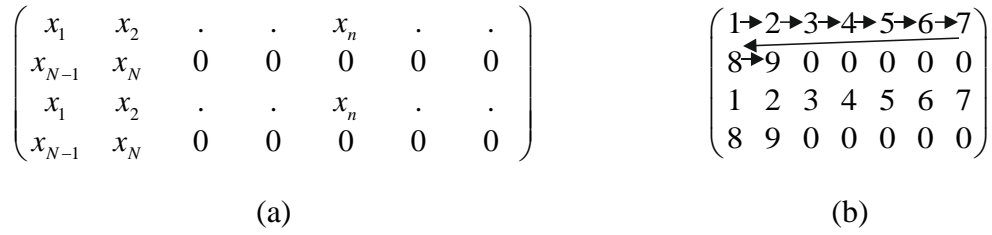

Fig. 3. (a) The structure of matrix filling method 2; (b) An example of time series with 9 elements.

Method 3: Row-by-row filling with time series stretching.

This method implies row-by-row matrix filling with stretching the time series to $N = 19625$. The stretching method constructs a new time series $\{z_n\}$ with $N = 19625$ elements where its elements are linear approximation between two adjacent points of the original time series $\{x_n\}$. The Fig. 4(a) shows a time series $\{x_n\}$ containing $N = 100$ values. The stretched time series $\{z_n\}$ is not unique. But, it gives almost same results if we consider time series as a record of dynamic process Fig. 4(b). Detailed arrangement of elements $\{z_n\}$ near x_{28} is shown in Fig. 4(c).

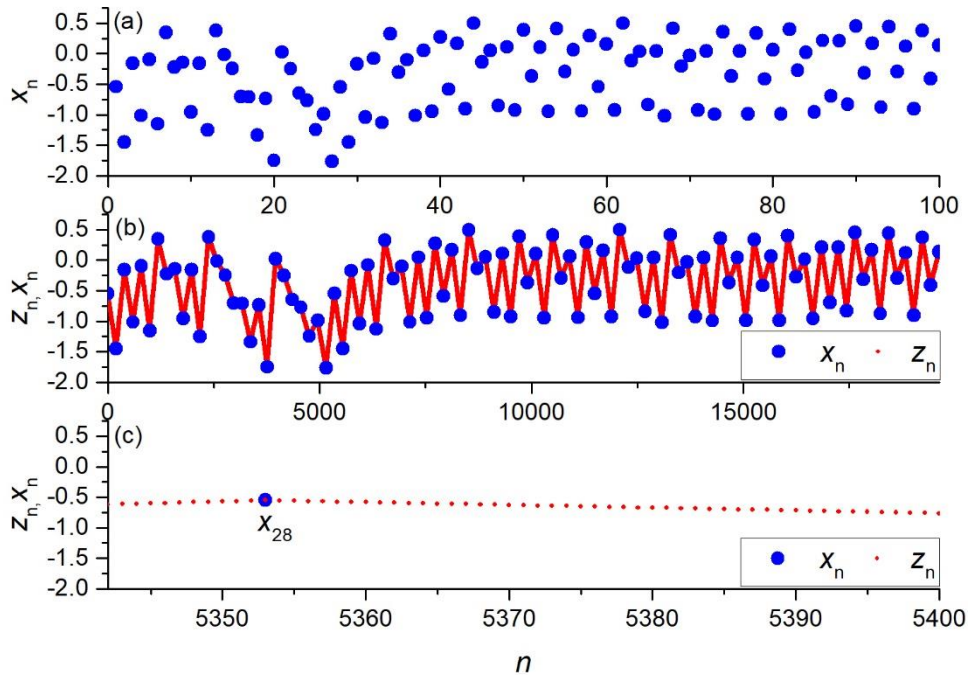

Fig. 4. (a) The time series $\{x_n\}$ with $N=100$ elements; (b) Stretching $\{x_n\}$ into the time series $\{z_n\}$ with $N=19625$ elements; (c) Detailed arrangement of elements $\{z_n\}$ near x_{28} .

Method 4: Column-by-column filling with duplication.

This method implies column-by-column filling of the matrix W1, with duplication of the columns for the subsequent elements, as shown in Fig. 5.

$$\begin{pmatrix} x_1 & x_n & x_N & \cdot & \cdot & \cdot & \cdot \\ x_2 & \cdot & x_1 & x_{N-1} & \cdot & \cdot & \cdot \\ \cdot & \cdot & x_2 & x_N & \cdot & \cdot & \cdot \\ \cdot & x_{N-1} & \cdot & \cdot & \cdot & \cdot & \cdot \end{pmatrix} \quad \begin{pmatrix} 1 & 5 & 9 & 4 & 8 & 3 & 7 \\ 2 & 6 & 1 & 5 & 9 & 4 & 8 \\ 3 & 7 & 2 & 6 & 1 & 5 & 9 \\ 4 & 8 & 3 & 7 & 2 & 6 & 1 \end{pmatrix}$$

(a) (b)

Fig. 5. (a) The structure of matrix filling method 4; (b) An example of time series with 9 elements.

Method 5: Column-by-column filling with zero elements

This method is similar to Method 2 where the column is considered instead of rows (see Fig. 6).

$$\begin{pmatrix} x_1 & x_n & x_N & x_1 & x_n & x_N & \cdot \\ x_2 & \cdot & 0 & x_2 & \cdot & 0 & \cdot \\ \cdot & \cdot & 0 & \cdot & \cdot & 0 & \cdot \\ \cdot & x_{N-1} & 0 & \cdot & x_{N-1} & 0 & \cdot \end{pmatrix} \quad \begin{pmatrix} 1 & 5 & 9 & 1 & 5 & 9 & 1 \\ 2 & 6 & 0 & 2 & 6 & 0 & 2 \\ 3 & 7 & 0 & 3 & 7 & 0 & 3 \\ 4 & 8 & 0 & 4 & 8 & 0 & 4 \end{pmatrix}$$

(a) (b)

Fig. 6. (a) The structure of matrix filling method 5; (b) An example of time series with 9 elements.

Method 6: Column-by-column filling with time series stretching

This method implies - column-by-column matrix filling, with stretching the time series to $N = 19625$ which is discussed in Method 3.

3. Numerical results

In this section, we will apply the proposed method to the following chaotic, random, periodic, binary and constant time series with different lengths to show efficiency and robustness of the proposed method.

I. Discrete chaotic maps:

As the transient period, the first 1000 elements are ignored. The NNNetEn measure is calculated for x_n where $n > 0$.

a) Logistic map:

$$x_{n+1} = r \cdot x_n \cdot (1 - x_n), \quad 1 \leq r \leq 4, \quad x_{.999} = 0.1, \quad (2)$$

b) Sine map:

$$x_{n+1} = r \cdot \sin(\pi \cdot x_n), \quad 0.7 \leq r \leq 2, \quad x_{.999} = 0.1, \quad (3)$$

c) Plank map:

$$x_{n+1} = \frac{r \cdot x_n^3}{1 + \exp(x_n)}, \quad 3 \leq r \leq 7, \quad x_{.999} = 4 \quad (4)$$

d) Henon map:

$$\begin{cases} x_{n+1} = 1 - r \cdot x_n^2 + y_n \\ y_{n+1} = r_1 \cdot x_n \end{cases}, \quad 0 \leq r \leq 1.4, \quad r_1 = 0.3, \quad x_{.999} = 0.1, \quad y_{.999} = 0.1 \quad (5)$$

II. Random discrete map:

$$x_n = \text{random} - 0.5 \quad (6)$$

III. Periodic discrete map:

$$x_n = A \cdot \sin\left(\frac{n \cdot 20\pi}{19625}\right) \quad (7)$$

IV. Binary discrete map:

$$x_n = n \bmod 2 \quad (8)$$

$$x_n = (1, 0, 1, 0, 1, 0, 1, 0, 1, \dots)$$

V. Constant discrete map:

$$x_n = A \quad (9)$$

The subsection 3.1 considers $N = 19625$ elements of the above discrete maps as the given time series and apply the proposed method to evaluate its entropy. The effect of epochs number is investigated in the subsection 3.2. The NNetEn is computed for some time series with different lengths in the subsection 3.3

3.1 Calculation of NNetEn entropy measure

In this subsection, we consider time series with $N = 19625$ elements. Obviously, the row matrix filling methods 1, 2, 3 give the same matrix. The same is true for methods 4, 5, 6 with column-wise filling. Therefore, we have only one graph for the methods 1-3 and one other graph for the methods 4-6. To train the matrix W_2 , we used the number of epochs equal to 100. In the next subsection, the influence of the epochs number on the value of NNetEn will be studied.

The dependence of NNetEn on the filling methods and the control parameter r in the chaotic time series Eqs. (2)-(5) are depicted in the Figs. 7-10.

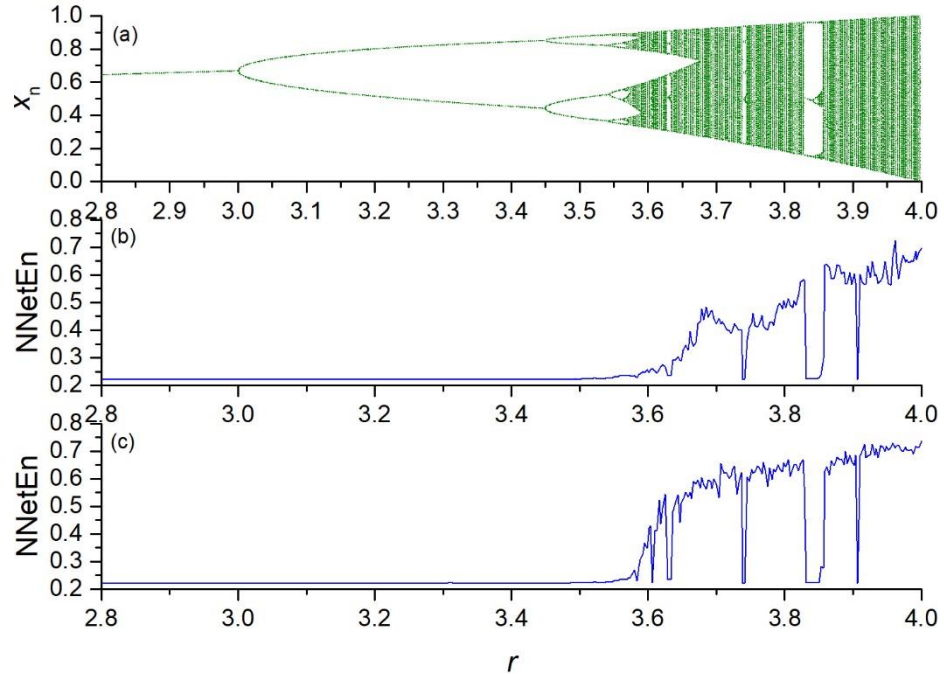

Fig. 7. (a) Bifurcation diagrams for logistic map (Eq. (2)); (b) The dependence of NNetEn on the parameter r using filling methods 1-3; (c) The dependence of NNetEn on the parameter r using filling methods 4-6.

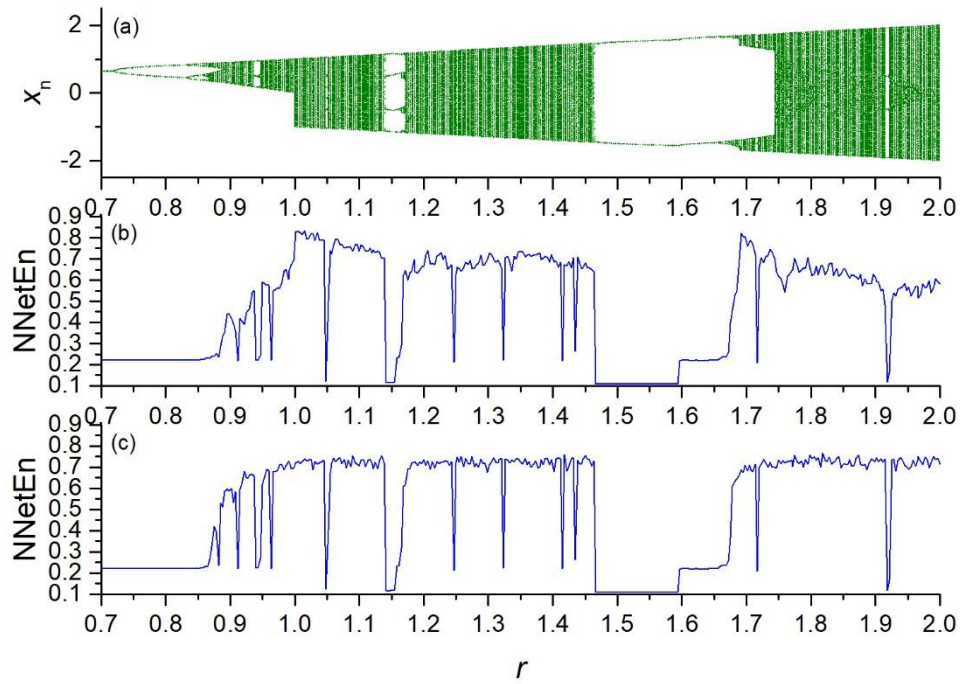

Fig. 8. (a) Bifurcation diagrams for sine map (Eq. (3)); (b) The dependence of NNetEn on the parameter r using filling methods 1-3; (c) The dependence of NNetEn on the parameter r using filling methods 4-6.

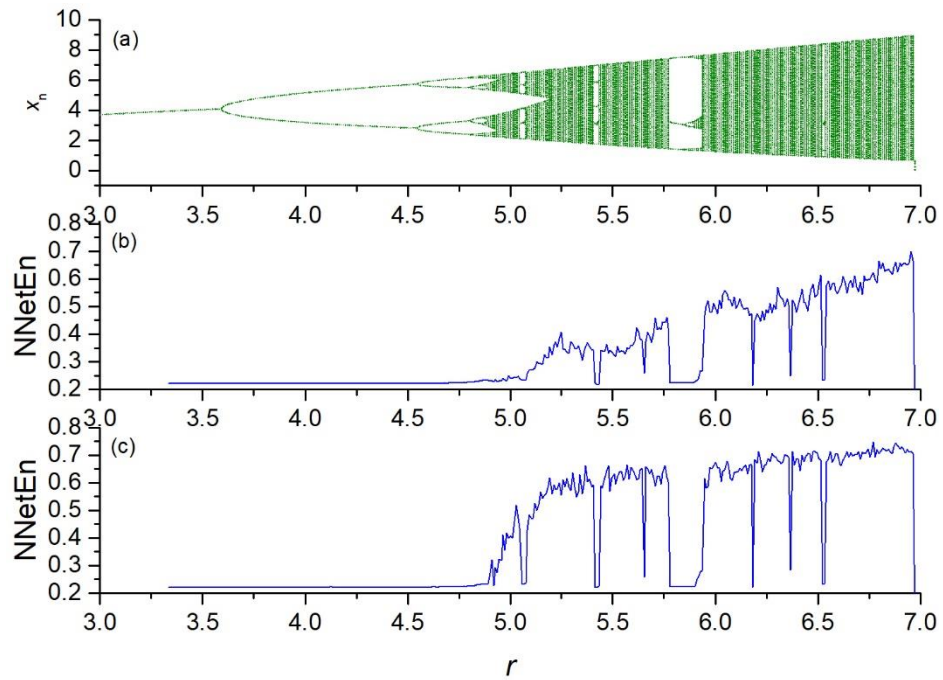

Fig. 9. (a) Bifurcation diagrams for Planck map (Eq. (4)); (b) The dependence of NNetEn on the parameter r using filling methods 1-3; (c) The dependence of NNetEn on the parameter r using filling methods 4-6.

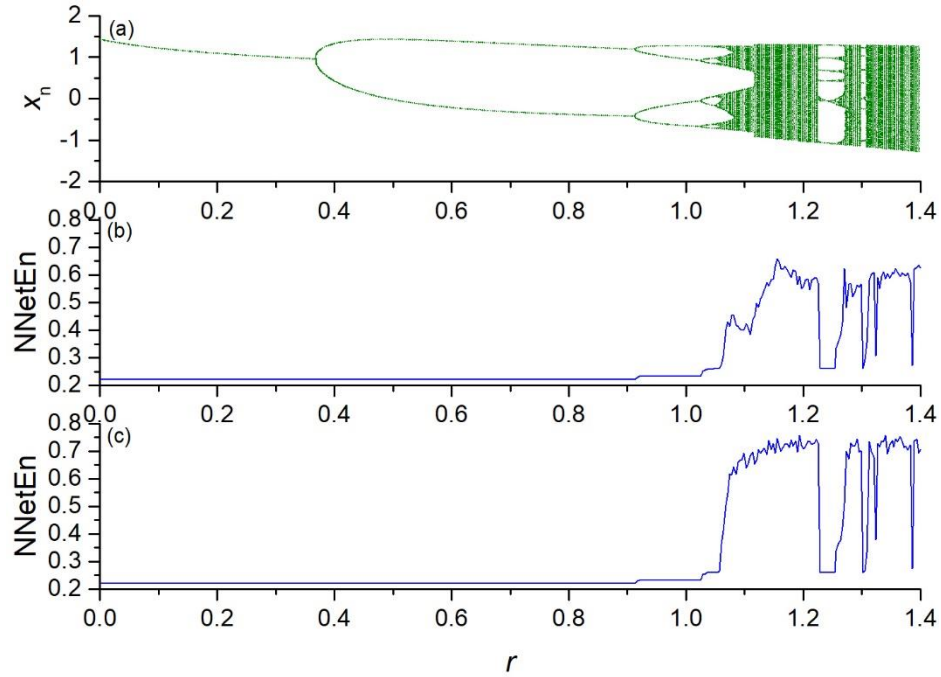

Fig. 10. (a) Bifurcation diagrams for Hennon map (Eq. (5)); (b) The dependence of NNetEn on the parameter r using filling methods 1-3; (c) The dependence of NNetEn on the parameter r using filling methods 4-6.

The Figs. 7-10 show that the NNetEn trend of the chaotic maps (Eqs. (2)-(5)) are compatible with their bifurcation diagrams. This is in line with the idea, that NNetEn is a valid measure for comparing the complexity of chaotic time series.

In our opinion, the filling methods 4-6 give more regular results, so Column-by-column filling is more preferable method.

For the random time series described by Eq. (6), the NNetEn measures are 0.727 and 0.744 for row-by-row and column-by-column matrix filling method respectively.

For the periodic time series (Eq. (7)), the NNetEn measure for different values of the parameter A is shown in the Fig. 11.

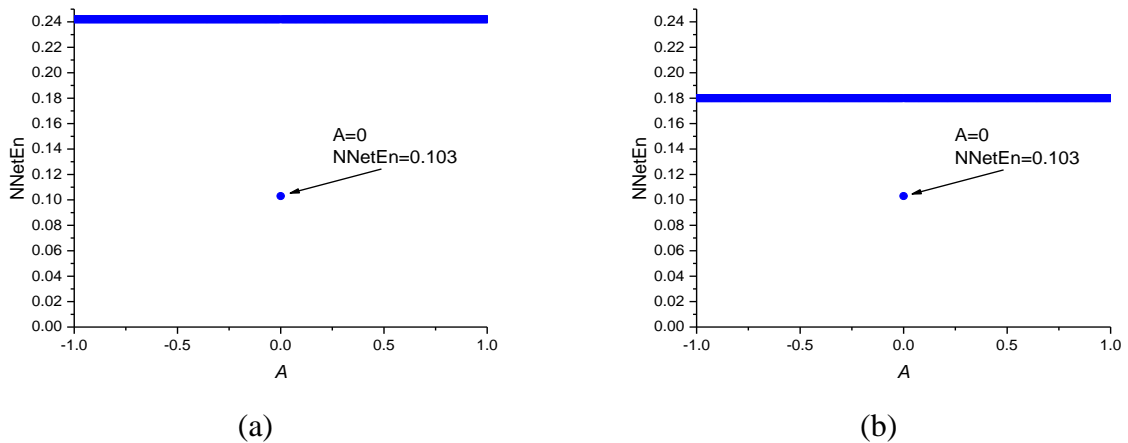

Fig. 11. The dependence of NNetEn on the parameter A in Eq. (7). The matrix filling methods 1-3 (a); The matrix filling methods 4-6 (b).

For the binary series described in (8), the NNetEn measure is 0.22 for all matrix filling methods. The NNetEn values for constant time series are depicted in Fig. 12. It can be seen that the entropy has the same value $NNetEn = 0.22$ for $|A| > 0$ and $NNetEn = 0.103$ for $A = 0$. Therefore, the lowest possible NNetEn value is 0.103.

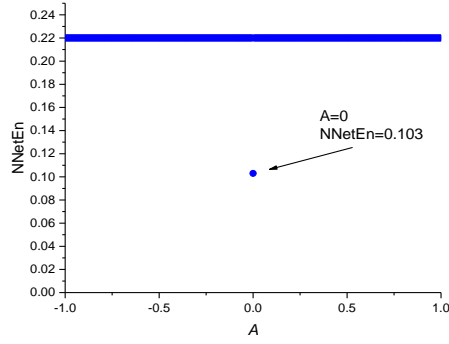

Fig. 12. The dependence of NNetEn on the parameter A constant time series (Eq. (9)).

A comparison between the values of NNetEn for chaotic, random, periodic and constant time series show that the value of NNetEn is increasing when the complexity of the time series are increasing. Therefore, there exist direct relations between the degree of complexity and NNetEn of time series. This confirms that NNetEn is suitable for comparing the degree of complexity of every given time series. Another good feature of this methods is that NNetEn is independent of signal amplitudes. Obviously, the entropy of the signal should not depend on the multiplication of the entire time series by a constant. This property holds in the proposed method (see Fig. 11 and Fig. 12).

3.2 The influence of the training epochs number on the NNetEn measure

To investigate the effect of training epochs on the NNetEn measure, we consider discrete logistic map with 1000 transient period time and $N = 19625$ elements. The results are given in Fig. 13.

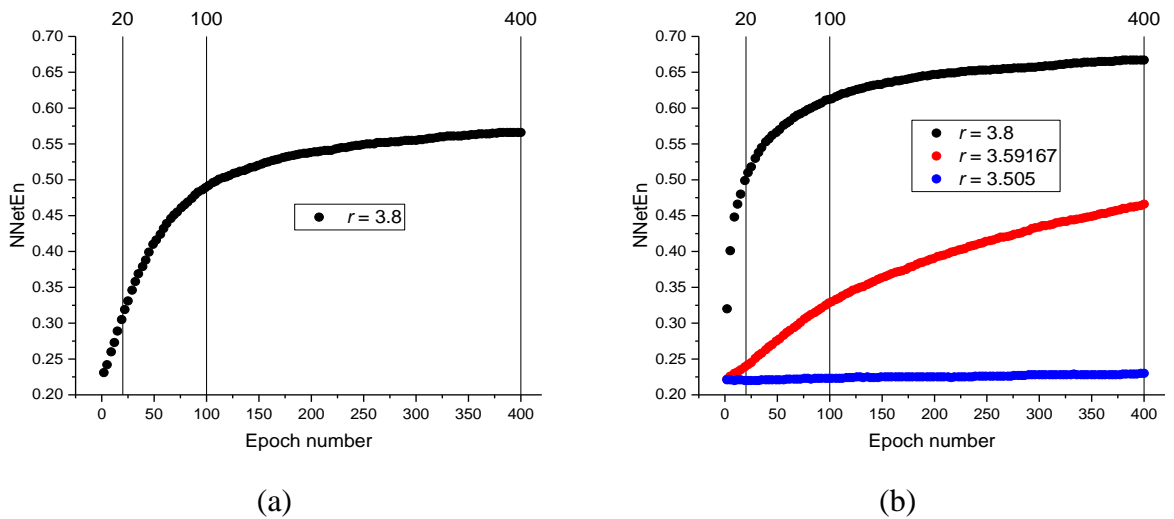

Fig. 13. The relation between NNetEn and the number of epochs in logistic map (Eq. (7)) at $r = 3.8$. (a) matrix filling methods 1-3; (b) Matrix filling methods 4-6.

This figure shows that the NNetEn gradually increases by increasing the number of epochs till a plateau reached in all matrix filling methods. The speed of reaching the plateau depends on the type of signal. For example, the velocity of reaching the plateau in $r = 3.59167$ is slower than $r = 3.8$ and $r = 3.505$. The Fig. 14(a) shows the dependence of NNetEn on the parameter r for different numbers of epochs. It can be seen that the trends are similar while they have different behaviors in detail. The Fig. 14(b) shows the behaviors of NNetEn with 100 epochs and 400 epochs are more similar than NNetEn with 20 epochs and 400 epochs. Therefore, we considered the 100 epochs which gives an appropriate approximation of the NNetEn with 400 epochs. This example shows that a very significant number of epochs is required for reaching the plateau in NNetEn

especially in chaotic time series. Therefore, it is necessary to indicate the number of epochs as a parameter of the model. We recommend using 100 or more epochs.

To identify the speed of NNetEn plateau convergence with respect to epochs number, the parameter $\delta_{Ep1/Ep2}$ is proposed as follows

$$\delta_{Ep1/Ep2} = \frac{\text{NNetEn}(Ep2 \text{ epoch}) - \text{NNetEn}(Ep1 \text{ epoch})}{\text{NNetEn}(Ep2 \text{ epoch})} \quad (10)$$

where $Ep1$ and $Ep2$ ($Ep1 < Ep2$) are the numbers of epochs used in calculating the entropy.

This parameter shows the rate of changes in NNetEn values when the number of epochs is decreased from $Ep2$ to $Ep1$. Figs. 14(c) shows the dependence of $\delta_{100/400}$ on the parameter r in the logistic map (Eq. (2)). It can be seen that the maximum $\delta_{100/400}$ occurs in $r = 3.59167$. This means the neural network has the lowest learning rate in $r = 3.59167$.

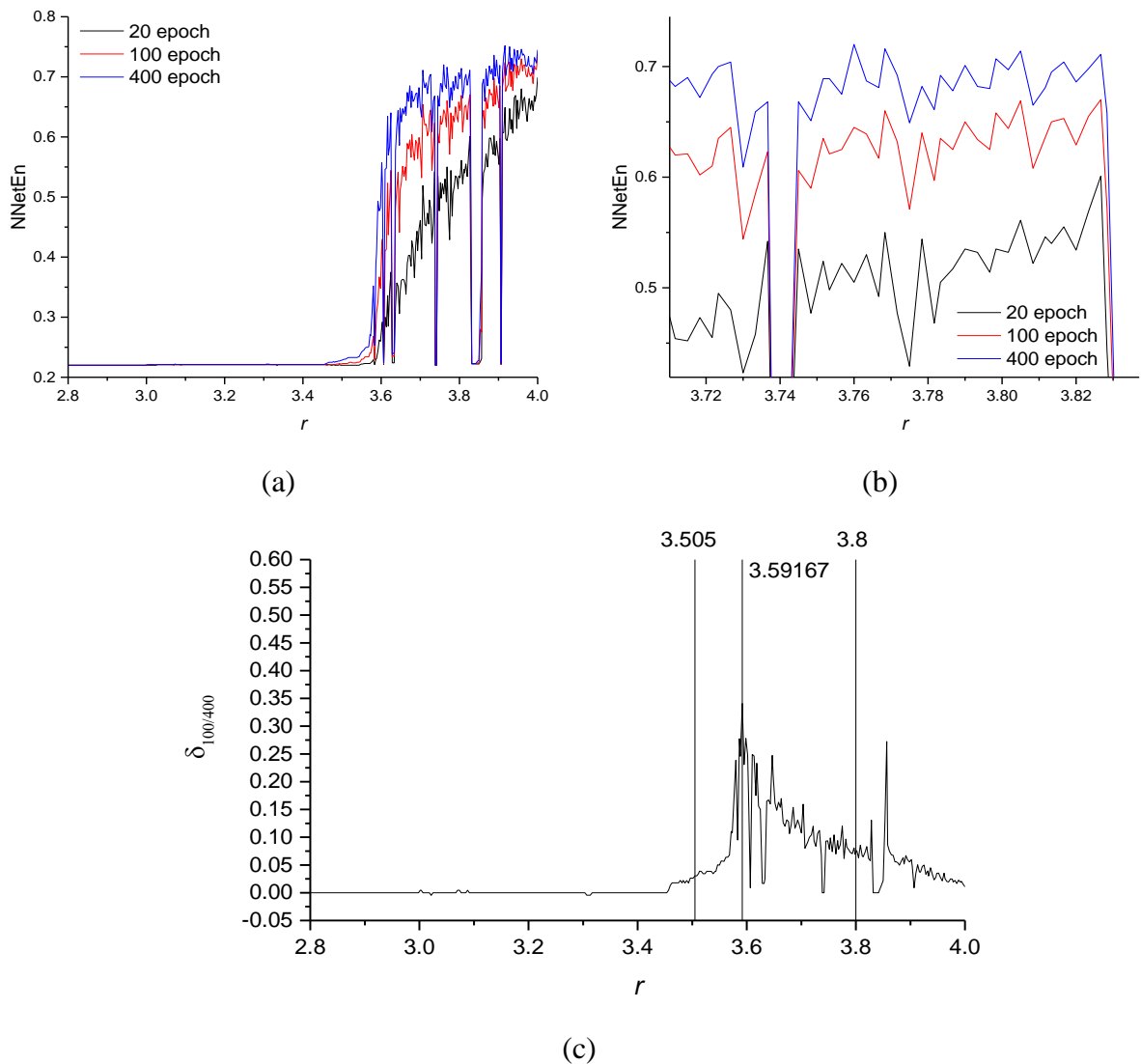

Fig. 14. (a) The dependence of NNetEn value on the parameter r in the logistic map (Eq. (2)) using the matrix fillings methods 4-6 and 20, 100 and 400 epochs numbers; (b) A zoom in subfigure (a) for r between 3.72 to 3.82; (c) The parameter $\delta_{100/400}$ with respect to the parameter r .

The parameter $\delta_{Ep1/Ep2}$ can be considered as a new characteristic of the input time series (see discussion section).

3.3 Calculation of NNetEn entropy with variation in the length of the time series N .

In real practice difficult to obtain time series with the number of elements $N = 19625$. Data obtained from financial markets [18], physical experiments [12,19] and biological or medical data [11,20] may have $N < 19625$ elements. Hence, we will not able to construct the matrix W_1 . To investigate the efficiency and stability the six matrix filling methods (see paragraph 2.1), these methods are applied on different types time series where the variation of the number of elements (N) is considered. The epochs number is set to 100 in this subsection.

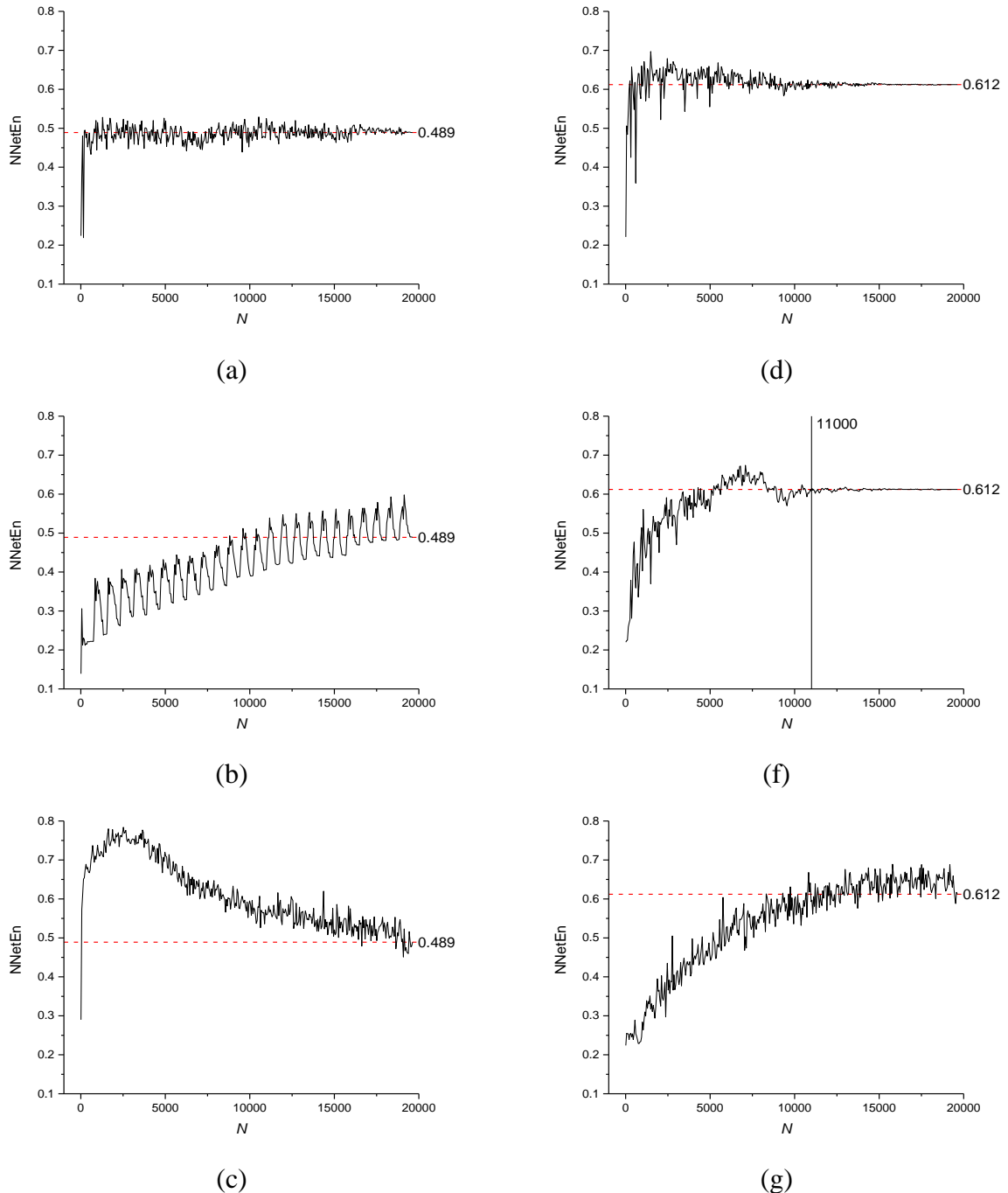

Fig. 15. The effect of time series length in NNetEn values for the logistic map using various matrix filling methods. (a) Method 1; (b) Method 2; (c) Method 3; (d) Method 4; (f) Method 5; (g) Method 6.

The NNetEn measures for chaotic logistic map with $r=3.8$ and various number of elements (N) are shown in Fig. 15 using different matrix filling methods. The dashed red line indicates the

reference level corresponding to NNetEn at $N = 19625$. In an ideal situation, a decrease in N below 19625 should not lead to a significant change in entropy relative to the reference level. The method 5 is most stable at $N \geq 11000$ since the NNetEn values practically coincide with the reference level. The method 1 is suitable for $N < 11000$ since it has less oscillations and deviations from the reference level.

The NNetEn measures for sine periodic map (Eq. (7)) and binary map (Eq. (8)) with various number of elements (N) are shown in Figs. 16 and 17 respectively.

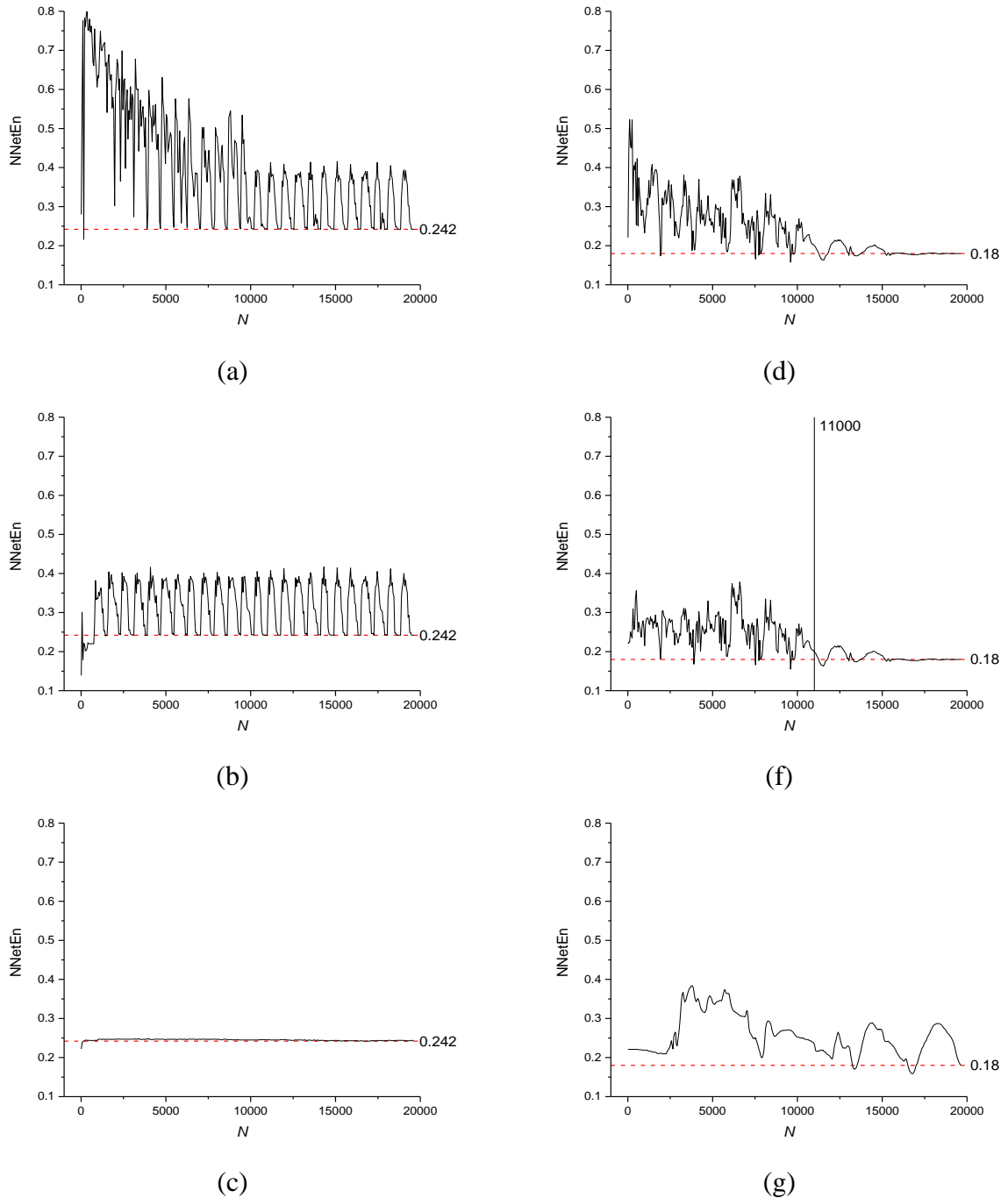

Fig. 16. The effect of time series length to NNetEn values in periodic time series (Eq. (7)) for various matrix filling methods. (a) Method 1; (b) Method 2; (c) Method 3; (d) Method 4; (e) Method 5; (f) Method 6.

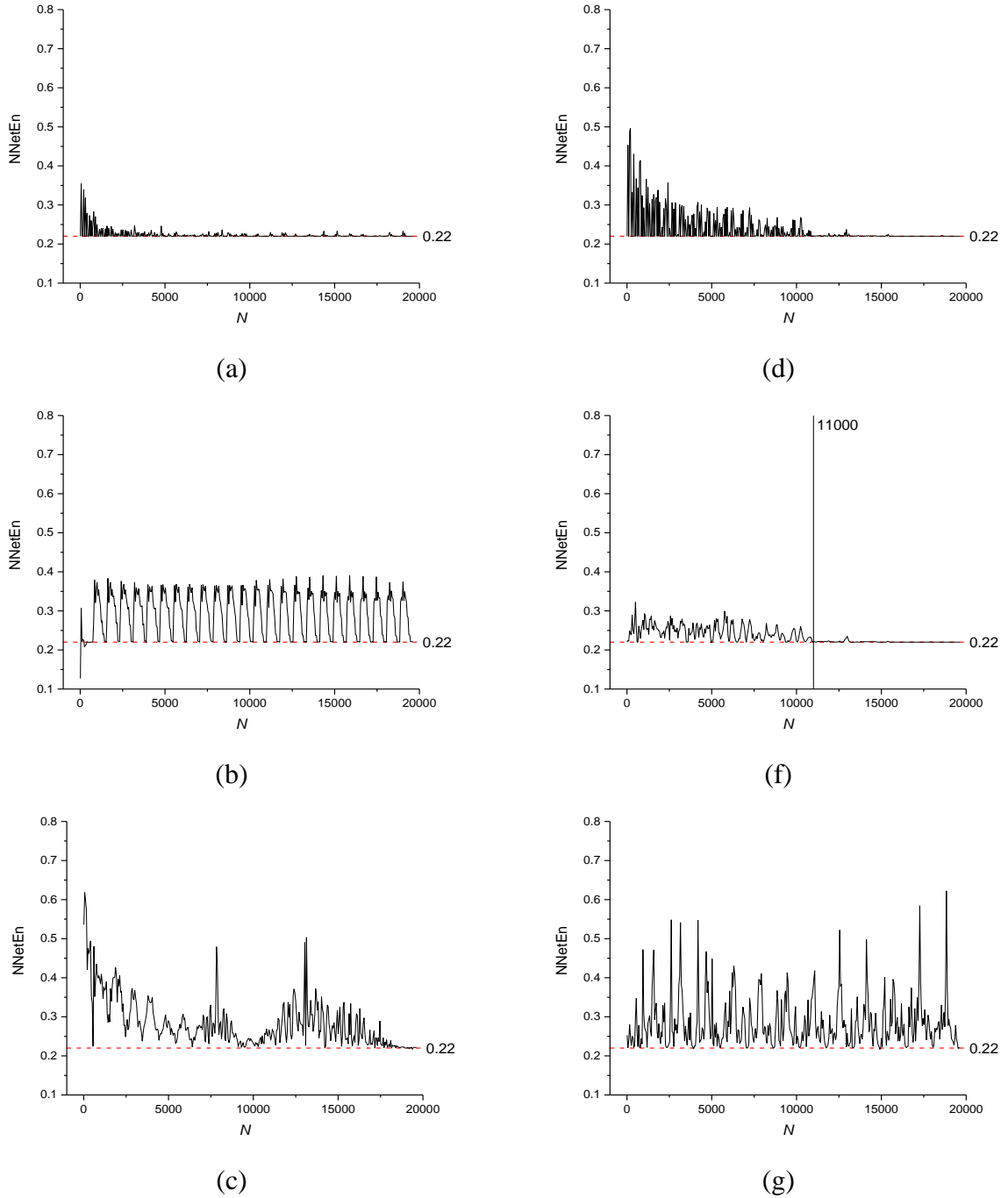

Fig. 17. The effect of time series length to NNetEn in binary time series (Eq. (8)) for various matrix filling methods. (a) Method 1; (b) Method 2; (c) Method 3; (d) Method 4; (e) Method 5; (f) Method 6; (g) Method 7.

Fig. 16 shows that the method 3 is the most suitable method for the periodic time series since it has no fluctuations. Fig. 17 shows that the method 5 gives most stable results for $N > 11000$ and the method 1 is suitable if the length of the time series is less than 11000.

3.3 A comparison between the NNetEn measure and some other entropy methods

A comparison between NNetEn and ApEn entropy measures for the logistic map are depicted in Fig. 18 ($N = 19625$). This graph also shows the labels $r_1 = 3.60666667$, $r_2 = 3.68833333$, $r_3 = 3.835$ and $r_4 = 3.94833333$. The variable rr and m are main parameters of ApEn [10]. The behavior of NNetEn and ApEn seems to be the same for different values of the parameter r . Nevertheless, one can see that the value of entropy is local minimum for NNetEn (method 5, epoch number 100) and ApEn ($rr = 0.025$, $m = 2$) in $r = r_1$ while ApEn ($rr = 0.1$, $m = 2$) reaches a local maximum in this point. This shows that ApEn is very sensitive in its parameters (rr and m). The proposed

method solves this problem, and the position of the minimum does not depend on the parameter of method (epoch number). In addition, the proposed method is compared with some other entropy measures as shown in Table 1. It can be seen that practically all entropies have increasing trend with r and the entropy at $r = r_1$ is less than the entropy at $r = r_4$. All entropies have minimum at $r = r_1$ and maximum at $r = r_4$. Thus, the entropy NNetEn gives similar results, like other known methods for calculating entropy, having the advantage of a small number of parameters and high computational stability, independent of the signal amplitude and the length of the time series.

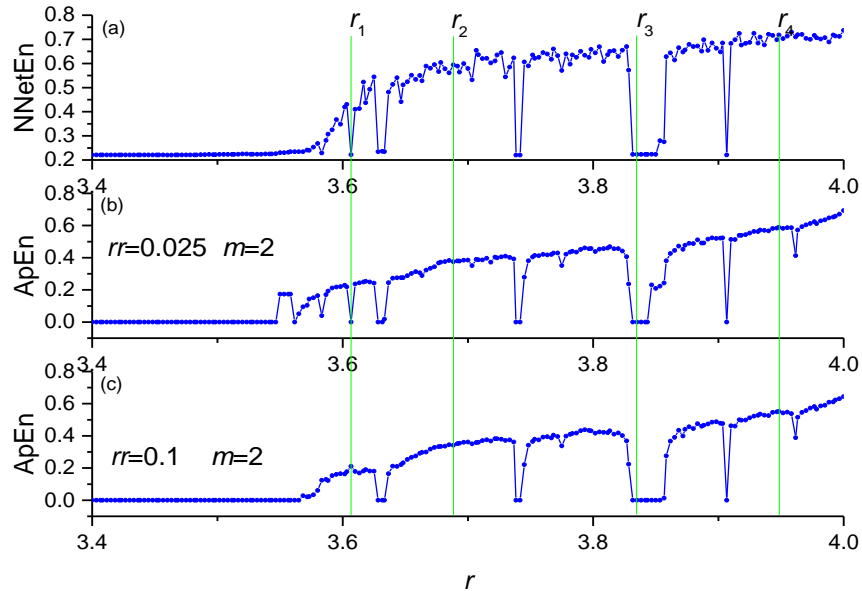

Fig. 18. A comparison between NNetEn and ApEn for the logistic mapping. (a) NNetEn (method 5, epoch number 100); (b) ApEn ($rr = 0.025, m = 2$); (c) ApEn ($rr = 0.1, m = 2$).

Table 1. Comparison between the NNetEn and some other entropy measures.

	$r_1 = 3.60666667$	$r_2 = 3.68833333$	$r_3 = 3.835$	$r_4 = 3.94833333$
NNetEn Entropy	0.222	0.594	0.223	0.718
ApEn [10], $rr = 0.025, m = 2$	0	0.374	0	0.588
ApEn [10], $rr = 0.1, m = 2$	0.210	0.341	0	0.552
Topological entropy [21]	1.16	1.21	0.61	1.21
SampEn [1]	0.067	0.287	0	0.49
PerEn [1]	0.45	0.53	0.347	0.71
DispEn [1]	0.45	0.649	0.308	0.683
Shannon entropy from recurrence plots [8]	0.85	1.79	0.1	2.29
Shannon entropy from symbolic dynamics [8]	2.45	4.81	1.15	6.97

4. Discussion and future works

Investigating the complexity of non-linear time series becomes a hot topic in recent years since it has many applications in practical applications. Many researchers are working in this subject and various entropy measures are introduced to calculate the complexity of the given time series. However, almost all existing methods are based on Shannon entropy or conditional probability which suffers of sensitivity on length of time series and their initial parameters. This paper proposes NNetEn entropy measure to overcome these difficulties. NNetEn is an estimation method based on MNIST-10 classification using LogNet 784:25:10 neural network, which shows that its calculation algorithm is completely different from the existed methods. NNetEn algorithm needs a reservoir matrix with 19625 elements filled with time series. Many practical applications use a time series with $N < 19625$ elements. Therefore, six matrix filling methods are suggested to reproduce the time series such that 19625 elements are reached.

Subfigures 15(b), 16(b) and 17(b) show that there exists modulation of entropy due to time series length changes in matrix fillings method 2. On these charts, we see 25 periodic maximums that arise due to the shift of the time series relative to 25 rows in the W_1 matrix.

Fig. 16(c) shows that the method 3 is the most appropriate method for the periodic time series. For the non-periodic time series, the methods 1 and 5 give best performance and less fluctuation of entropy than other methods. The method 5 is most stable at $N \geq 11000$, the NNetEn values practically coincide with the reference level. The method 1 is suitable for $N < 11000$, it has less oscillations and deviations from the reference level. We suggest to use the method 5 for the time series whose their lengths $N \geq 11000$ and the method 1 for $N < 11000$

In practice, when comparing time series, we recommend using time series of the same length and, if possible, $N \geq 11000$ and the method 5 of matrix filling.

When comparing time series of different lengths, it is preferable to use the method 5 for all cases.

The method is applied on constant, binary, periodic and various chaotic time series. The results show that the NNetEn is between 0.103 and 1. The lower limit of NNetEn is 0.1 since the minimum of the classification accuracy is 10%. This is achieved when the images of the digits are determined from 10 options randomly.

The results show that the NNetEn value converges on a plateau by increasing the number of epochs. The number of epochs is considered as the input parameter of the proposed method. The results show that the behaviors of NNetEn trends are approximately similar for the logistic map with epoch numbers 100 and 400. Therefore, we used 100 epochs in LogNet: and suggest to use at least 100 epochs in other examples.

In subsection 3.2, the parameter $\delta_{Ep1 / Ep2}$ is introduced to compare the effects of epoch numbers in NNetEn values. This parameter can be considered as a new characteristic of the input time series. We call this characteristic as the time series learning inertia. This parameter characterizes the speed of training in a network for the given time series. Small values of $\delta_{Ep1 / Ep2}$ correspond to the rapid attainment of a plateau for NNetEn by increasing the number of epochs. It should be noted that the parameter $\delta_{Ep1 / Ep2}$ may depends on the initial distribution of the matrix W_2 elements or on the learning rate of the backpropagation method. Fig. 14(c) shows that there exist some bursts at the border of the order-chaos regions. Thus, further study of the time series learning inertia for various signals and the study of transitions from order to chaos may become a topic for further research.

The proposed model has some advantages compared with the existed entropy based methods as follows

- It gives a unique algorithm for evaluating the complexity of time series with every given length.

- It has good performance in the time series with some equal values.
- It is simple to use.
- It outperforms than existing methods.

For example, the Ref. [1] introduced a method which depends on the embedding dimension m , time delay d and constant value c . Any changes in these values maybe lead to different results while the proposed method depends on the epochs number only and the results of different epochs are approximately same.

Extending the current work for the multivariable time series can be considered as another topic for the future work. It is also interesting to apply the methods of calculating NNetEn in practice when processing data from medical, physical, biological and geophysical experiments. The use of neural networks for calculating entropy and other characteristics of time series can become a promising scientific direction.

4. Conclusion

This paper proposed a new entropy measure called NNetEn for evaluation the degree of complexity in given time series. NNetEn is the first entropy measure which is based on artificial intelligence methods. The method modifies the structure of LogNet classification model such that the classification accuracy of MNIST-10 digits dataset indicates the degree of complexity of the given time series. The results of the proposed model are approximately compatible with the existing methods while its structure is completely different. The specific structure of NNetEn model leads to some superiorities than existing methods. For example, it overcome to some difficulties such as sensitivity to length and amplitude of time series. In addition, it has only one input parameter and simpler to use which are very important in practical applications.

References

- [1] Azami H, Escudero J. Amplitude- and fluctuation-based dispersion entropy. *Entropy* 2018;20:1–21. <https://doi.org/10.3390/e20030210>.
- [2] Yan B, He S, Sun K. Design of a network permutation entropy and its applications for chaotic time series and EEG signals. *Entropy* 2019;21:1–18. <https://doi.org/10.3390/e21090849>.
- [3] Benkabou SE, Benabdeslem K, Canitia B. Unsupervised outlier detection for time series by entropy and dynamic time warping. *Knowl Inf Syst* 2018;54:463–86. <https://doi.org/10.1007/s10115-017-1067-8>.
- [4] Ramírez-Rojas A, Telesca L, Angulo-Brown F. Entropy of geoelectrical time series in the natural time domain. *Nat Hazards Earth Syst Sci* 2011;11:219–25. <https://doi.org/10.5194/nhess-11-219-2011>.
- [5] Li Y, Fan Y. Complexity measure applied to the analysis EEC signals. *Annu Int Conf IEEE Eng Med Biol - Proc* 2005:4610–3. <https://doi.org/10.1109/iembs.2005.1615497>.

- [6] Zunino L, Olivares F, Scholkmann F, Rosso OA. Permutation entropy based time series analysis: Equalities in the input signal can lead to false conclusions. *Phys Lett Sect A Gen At Solid State Phys* 2017;381:1883–92. <https://doi.org/10.1016/j.physleta.2017.03.052>.
- [7] Yin Y, Shang P. Weighted permutation entropy based on different symbolic approaches for financial time series. *Phys A Stat Mech Its Appl* 2016;443:137–48. <https://doi.org/10.1016/j.physa.2015.09.067>.
- [8] Letellier C. Estimating the Shannon entropy: Recurrence plots versus symbolic dynamics. *Phys Rev Lett* 2006;96. <https://doi.org/10.1103/PhysRevLett.96.254102>.
- [9] Cuesta-Frau D. Permutation entropy: Influence of amplitude information on time series classification performance. *Math Biosci Eng* 2019;16:6842–57. <https://doi.org/10.3934/mbe.2019342>.
- [10] Pincus SM. Approximate entropy as a measure of system complexity. *Proc Natl Acad Sci* 1991;88:2297–301.
- [11] Richman JS, Moorman JR. Physiological time-series analysis using approximate entropy and sample entropy maturity in premature infants Physiological time-series analysis using approximate entropy and sample entropy. *Am J Physiol Hear Circ Physiol* 2000;278:H2039–49.
- [12] Keum J, Coulibaly P. Sensitivity of Entropy Method to Time Series Length in Hydrometric Network Design. *J Hydrol Eng* 2017;22:04017009. [https://doi.org/10.1061/\(asce\)he.1943-5584.0001508](https://doi.org/10.1061/(asce)he.1943-5584.0001508).
- [13] Watt SJ, Politi A. Permutation entropy revisited. *Chaos, Solitons and Fractals* 2019;120:95–9. <https://doi.org/10.1016/j.chaos.2018.12.039>.
- [14] Molavipour S, Ghourchian H, Bassi G, Skoglund M. Neural estimator of information for time-series data with dependency. *Entropy* 2021;23:1–28. <https://doi.org/10.3390/e23060641>.
- [15] Martinez-Garcia M, Zhang Y, Suzuki K, Zhang Y. Measuring system entropy with a deep recurrent neural network model. *IEEE Int Conf Ind Informatics* 2019;2019-July:1253–6. <https://doi.org/10.1109/INDIN41052.2019.8972068>.
- [16] Velichko A. Neural Network for Low-Memory IoT Devices and MNIST Image Recognition Using Kernels Based on Logistic Map. *Electronics* 2020;9:1432.
- [17] Heidari H, Velichko A. An improved LogNNet classifier for IoT application. *ArXiv Prepr* 2021:2105.14412.

- [18] Zhao X, Ji M, Zhang N, Shang P. Permutation transition entropy: Measuring the dynamical complexity of financial time series. *Chaos, Solitons and Fractals* 2020;139. <https://doi.org/10.1016/j.chaos.2020.109962>.
- [19] Litak G, Taccani R, Radu R, Urbanowicz K, Hołyst JA, Wendeker M, et al. Estimation of a noise level using coarse-grained entropy of experimental time series of internal pressure in a combustion engine. *Chaos, Solitons & Fractals* 2005;23:1695–701. <https://doi.org/10.1016/j.chaos.2004.06.057>.
- [20] Pan YH, Wang YH, Liang SF, Lee KT. Fast computation of sample entropy and approximate entropy in biomedicine. *Comput Methods Programs Biomed* 2011;104:382–96. <https://doi.org/10.1016/j.cmpb.2010.12.003>.
- [21] Saha LM, Prasad S, Yuasa M. Measuring Chaos: Topological Entropy and Correlation Dimension in Discrete Maps. *Res Inst Sci Technol* 2012;24:11–23.