

# How to make qubits speak

Bob Coecke, Giovanni de Felice, Konstantinos Meichanetzidis, Alexis Toumi

Cambridge Quantum Computing Ltd.  
Oxford University, Department of Computer Science

Invited contribution to:  
*“Quantum Computing in the Arts and Humanities”*

July 15, 2021

## Abstract

This is a story about making quantum computers speak, and doing so in a quantum-native, compositional and meaning-aware manner. Recently we did question-answering with an actual quantum computer. We explain what we did, stress that this was all done in terms of pictures, and provide many pointers to the related literature. In fact, besides natural language, many other things can be implemented in a quantum-native, compositional and meaning-aware manner, and we provide the reader with some indications of that broader pictorial landscape, including our account on the notion of compositionality. We also provide some guidance for the actual execution, so that the reader can give it a go as well.

## 1 Networks of words

What is a word?

In particular, what is the meaning of a word? This could be what you find in a dictionary. Then again, before there were dictionaries people also used words, and so did people that could not read. In fact, most words we know we didn’t look up in a dictionary. We probably learned them by hearing them used a lot. This idea of meaning is closer to how machines learn meanings of words today: they learn them from the context in which they are used, an idea coined by Wittgenstein as “meaning is use”, and expressed by Firth’s derived dictum [35]:

“You shall know a word by the company it keeps”.

What is a sentence?

In particular, what is the meaning of a sentence? A sentence is not just a “bag of words”,<sup>1</sup> but rather, a kind of network in which words interact in a particular fashion. In fact, in a very particular fashion, given that when we hear a sentence that we never heard before, provided we do understand the words that occur in it, then we surely also understand that sentence. That’s exactly why we don’t have dictionaries for sentences—besides the fact a ‘sentence dictionary’ would take up an entire library, if not more. There is an important academic question here:

---

<sup>1</sup>Here, ‘bag’ is a widely used technical term, referring to the fact that in many ‘natural language processing’ applications grammatical structure has been entirely ignored for many years [41].

- How do we deduce the meaning of a sentence given the meanings of its words?

We can also ask the converse question:

- Can we infer the meanings of words in sentences, from the meanings of sentences?

Both turn out to also be essential practical questions.

Some 10 years ago, in [26], BC Mehrnoosh Sadrzadeh and Steve Clark started to draw networks in order to address the first of these questions. These networks look like this:

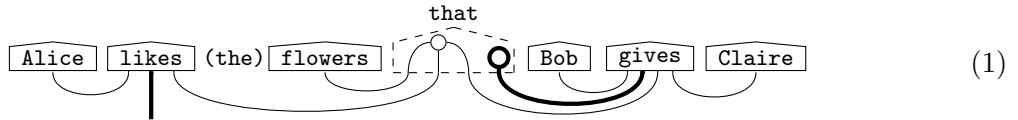

The usual technical term for these networks is “string diagram” (see e.g. [5]). These string diagrams provided a straight-forward manner for how meanings of words combine in order to produce the meaning of a sentence, even resulting in a cover-heading feature in *New Scientist*.<sup>2</sup>

In order to better see how these string diagrams do so, let’s consider a simpler example:



The idea here is that the boxes represent the meanings of words and that the wires are channels through which these meanings can be transmitted. So, in the example above, the subject *Alice* and the object *Bob* are both sent to the verb *hates*, and together they then make up the meaning of the sentence. This idea scales to much bigger sentences like the one depicted above, and even to large text made up of multiple sentences [18].

This flow of words in sentences can be traced back to work originally started in the 1930s by Adjukwicz [3] and later by Bar-Hillel [7], Chomsky [12, 13] and Lambek [43, 44], among others. What they did was unifying grammatical structures across different languages as a single mathematical structure. An overview of these developments from the perspective of string diagrams is in [16].

## 2 Language is quantum-native

One particularly interesting aspect of this graphical framework for linguistics was that the string diagrams were inherited from previous work that provided quantum theory with a network-like language [15]. This work was accumulated eventually in a 900-page book [23].

In summary, a direct correspondence was established between, on the one hand, the meanings of words and quantum states, and on the other hand, grammatical structures and quantum measurements. This is illustrated in Figure 1. Obviously this led to the question: Can one make quantum computers handle natural language? This was first proposed in a paper by Will Zeng and BC in 2016 [67], creating a new paradigm for natural language processing (NLP) in a quantum computing context.

The idea of making quantum computers process natural language is just not only incredibly cool but also a very natural thing to do for the reasons indicated above. More researchers started to take an interest, and at some point Intel supported a basic attempt to develop some of the ideas contained in [67] on their quantum simulator [57, 54].

<sup>2</sup><https://www.newscientist.com/article/mg20827903-200-quantum-links-let-computers-understand-language/>

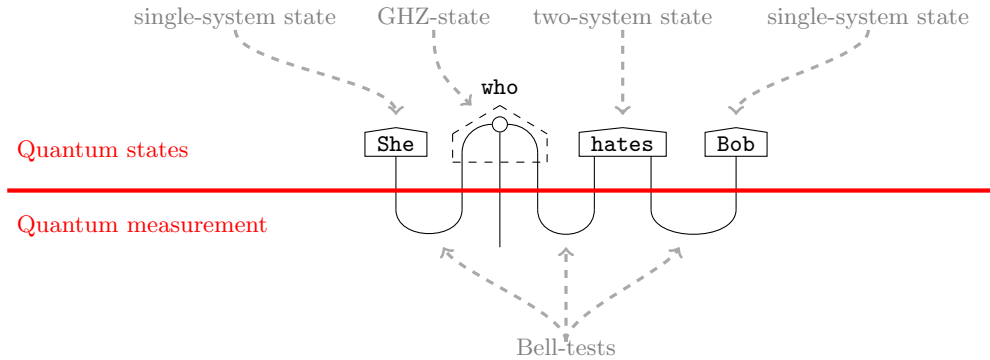

Figure 1: Illustration of how word meanings can be interpreted as quantum states, and grammatical structure in terms of quantum measurement.

However, there were some significant challenges to the proposal. Most importantly, there weren't any sufficiently capable quantum computers that could implement the NLP tasks proposed. Additionally, an assumption was made that one could encode word meanings on the quantum computer using quantum random access memory (QRAM) [39], which to this day, and despite theoretical progress and experimental proposals, remains a distant possibility.

### 3 Our new attempt

In the past year, we have been examining ways to use existing NISQ (= Noisy Intermediate Scale Quantum) devices, in the first instance one of IBM's quantum devices, for NLP.

The string diagrams as depicted above can't be interpreted directly by IBM's machine, which instead, needs something in the form of a 'quantum circuit'. Natural language when we map it to a 'quantum circuit skeleton' now looks like this [20]:

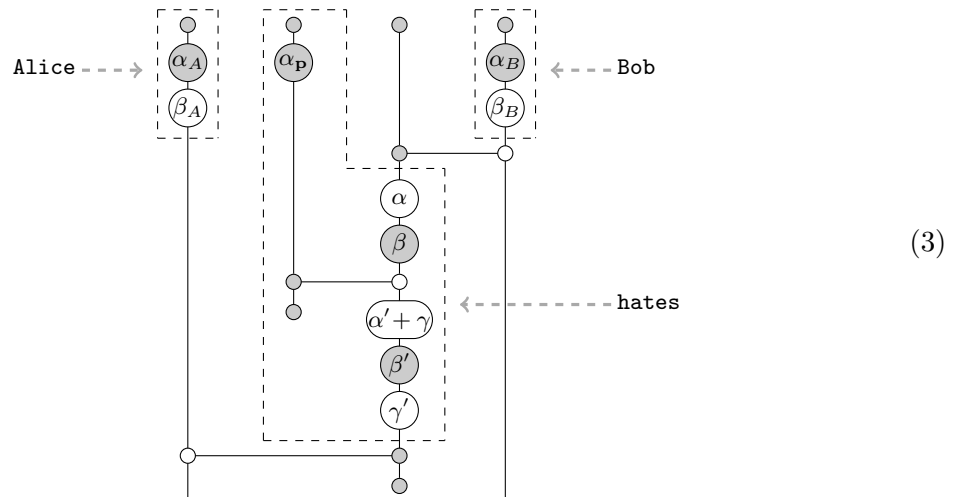

In this picture as well as in our experiments we used the 'ZX-calculus' [21] for drawing quantum circuits, which is again part of the same string diagram language of quantum theory—we give the translation of ZX-calculus circuit components in standard circuit gates in Figure 2. The

X-preparation	X-phase gate	Z-phase gate	CNOT gate	X-measurement
$\begin{pmatrix} 1 \\ 0 \end{pmatrix}$	$\begin{pmatrix} 1 & 0 \\ 0 & e^{i\alpha} \end{pmatrix}$	$H \circ \begin{pmatrix} 1 & 0 \\ 0 & e^{i\alpha} \end{pmatrix} \circ H$	$\begin{pmatrix} 1 & 0 & 0 & 0 \\ 0 & 1 & 0 & 0 \\ 0 & 0 & 0 & 1 \\ 0 & 0 & 1 & 0 \end{pmatrix}$	$\begin{pmatrix} 1 & 0 \end{pmatrix}$

Figure 2: Translation of ZX-calculus circuit components in standard circuit gates. For a short tutorial see [22], or for a more extensive ones see [23, 66].

building blocks of the ZX-language are these ‘spiders’:

$$\begin{array}{c} \dots \\ \curvearrowright \\ \alpha \\ \curvearrowleft \\ \dots \end{array} \quad \begin{array}{c} \dots \\ \curvearrowright \\ \alpha \\ \curvearrowleft \\ \dots \end{array} \tag{4}$$

and rules for computing and reasoning look as follows:

$$\begin{array}{c} \dots \\ \curvearrowright \\ \alpha \\ \dots \end{array} \begin{array}{c} \dots \\ \curvearrowright \\ \beta \\ \dots \end{array} = \begin{array}{c} \dots \\ \curvearrowright \\ \alpha + \beta \\ \dots \end{array} \quad \begin{array}{c} \dots \\ \curvearrowright \\ \alpha \\ \dots \end{array} = \begin{array}{c} \dots \\ \dots \\ \dots \end{array} \quad \begin{array}{c} \dots \\ \curvearrowright \\ \alpha \\ \dots \end{array} \begin{array}{c} \dots \\ \curvearrowright \\ \alpha \\ \dots \end{array} = \begin{array}{c} \dots \\ \dots \\ \dots \end{array} \tag{5}$$

So we are genuinely dealing with an entirely pictorial language, and in fact, recently it was shown in [40] that all the equations that can be derived using the usual quantum mechanical formalism, can also be derived using only pictures!

The key part of the passage from a sentence diagram representing grammatical structure like (2) to a quantum circuit uses the ZX-calculus in a fundamental way. For example, the fact that the CNOT-gate arises by sticking together two spiders as follows:

$$\begin{array}{c} \dots \\ \curvearrowright \\ \alpha \\ \dots \end{array} \begin{array}{c} \dots \\ \curvearrowright \\ \beta \\ \dots \end{array} = \begin{array}{c} \dots \\ \dots \\ \dots \end{array} \tag{6}$$

is essential. Using this decomposition, the circuit arises as follows from (2):

$$\begin{array}{c} \text{Alice} \quad \text{*hates*} \quad \text{Bob} \\ \dots \end{array} = \begin{array}{c} \text{Alice} \quad \text{*hates*} \quad \text{Bob} \\ \dots \end{array} \tag{7}$$

We could then also decide to reduce the number of qubits as follows:

$$\begin{array}{c} \text{Alice} \quad \text{*hates*} \quad \text{Bob} \\ \dots \end{array} = \begin{array}{c} \text{Alice} \quad \text{Bob} \\ \dots \end{array} \tag{8}$$

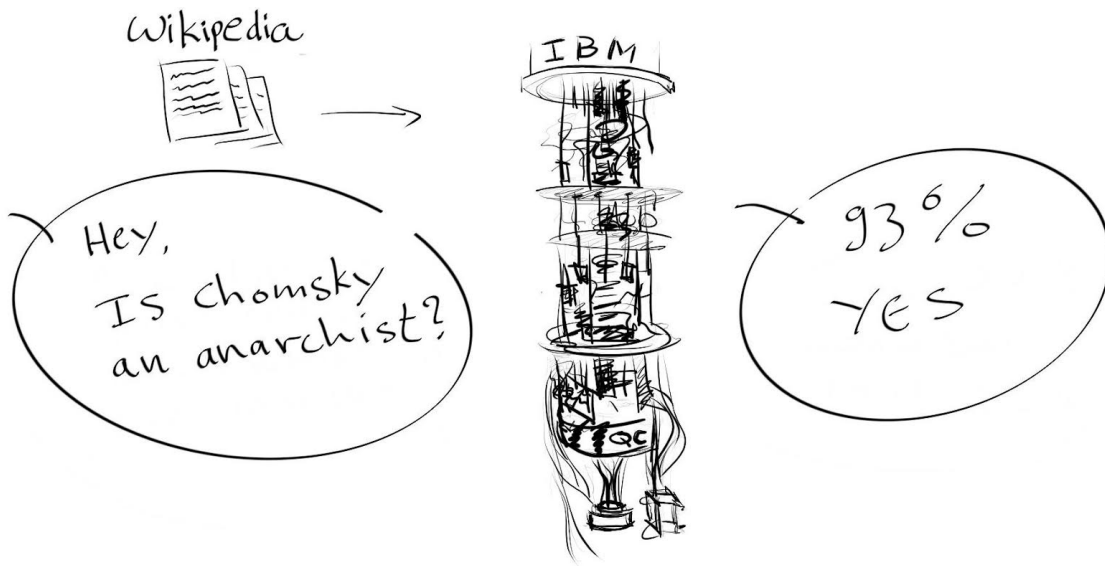

Figure 3: A quantum computer putting an end to social media disputes.

From this (3) arises when parametrising the word meanings by gates. A detailed discussion of the entire passage is in [20].

In the form (3), natural language can be implemented on NISQ devices, and of course, will still work well as these devices scale in terms of size and performance. Crucially, our solution provides a way forward in the absence of QRAM. By employing quantum machine learning we do not directly encode the meanings of words, but instead quantum gates—those in the circuit (3) carrying Greek letters—learn their meanings directly from text [51]. By way of analogy with classical machine learning, in quantum machine learning we can indeed use quantum circuits instead of classical neural networks in order to learn patterns from data [49, 9]. Interestingly, neural network architectures are the state-of-the-art in classical NLP, but the majority of methods do not take advantage of grammatical structures. In contrast, we saw that our approach to natural language naturally accommodates both grammar and meaning.

Using our framework, once the meanings of words and phrases are encoded as quantum gates, we are able to encode the meaning of grammatical sentences on quantum hardware. Posing a question to the quantum computer, constructed by the vocabulary and grammar the quantum computer has learned, it returns the answer—as illustrated in Figure 3.<sup>3</sup>

Naturally, we next turned our attention toward the design and execution of an experiment that is non-trivial, not least of all since our design is predicated on the program being scalable. This means that the dimension of the meaning space grows significantly with the number of qubits available whilst the size of the circuits dictated by the grammar does not grow too large with the size of the sentence.

## 4 The actual experiment

Once a quantum circuit is created from a sentence, it needs to be evaluated in order to compute the meaning of that sentence. We may choose to perform this evaluation on a classical com-

<sup>3</sup>Earlier theoretical work by our team towards question-answering includes [19, 31].

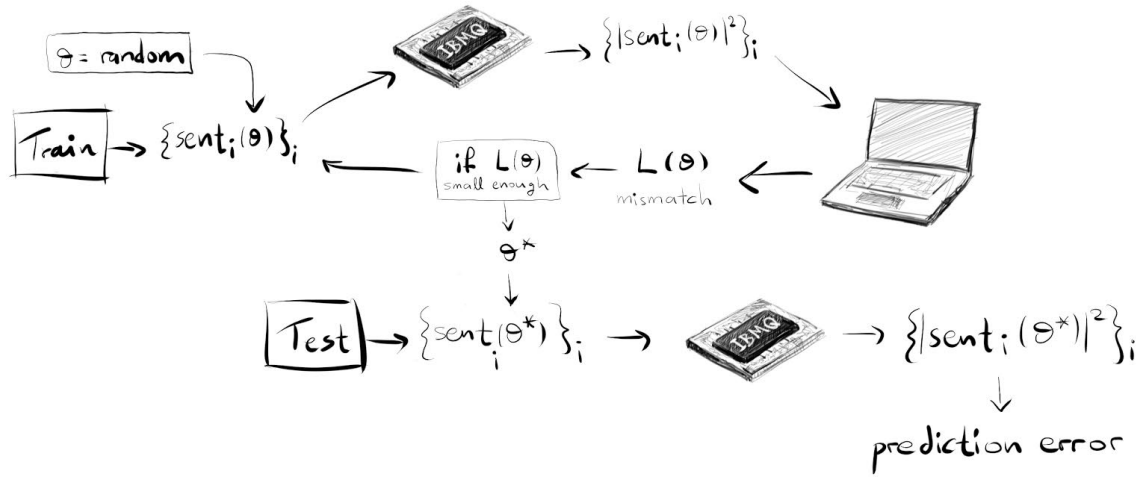

Figure 4: A schematic presentation of the actual experiment on IBM quantum hardware, depicting both the training and testing parts, with  $\theta = \{\alpha_A, \beta_A, \alpha_B, \beta_B, \alpha, \beta, \dots\}$ .

puter, where we employ state-of-the-art methods for performing the costly task of multiplying exponentially big matrices, or, we may choose to implement the circuit on a quantum computer. This is of course what we decided to do. A schematic presentation of the experiment on IBM quantum hardware is in Figure 4.

As we see in the quantum circuit (3), each of the parts of speech (subject, object, verb) is in the quantum circuit a function of some parameters. For example, there are sets of parameter values  $\alpha_A, \beta_A, \alpha_B, \beta_B, \alpha, \beta, \dots$  such that:

$$\begin{aligned} \text{subject}(\alpha_A, \beta_A) &= \text{Alice} \\ \text{object}(\alpha_B, \beta_B) &= \text{Bob} \\ \text{verb}(\alpha, \beta, \dots) &= \text{hates} \end{aligned}$$

The values are determined empirically by a text corpus and are then used to answer questions about the corpus. In order to ensure that our experiment can be executed effectively on near-term NISQ devices, but at the same time be complex enough to be interesting, we chose a vocabulary of a few words, for example:

$$\{\text{Alice, Bob, loves, hates, rich, silly}\}$$

and generated not some, but all grammatical sentences from their combinations. From these sentences, we created their corresponding parameterised circuits. Moreover, we interpret the language diagrams such that the sentence space is one-dimensional, i.e. just a number indicating the truth-value of the sentence:

$$0 \leq \text{sentence}(\alpha_A, \beta_A, \alpha_B, \beta_B, \alpha, \beta, \dots) \leq 1$$

A value close to 1 represents “true” and a value close to 0 indicates “false”.

The labeled toy corpus would look like:

$$\text{Corpus} = \{(\text{Alice loves Bob}, \text{false}), (\text{Bob is silly}, \text{true}), (\text{Alice is rich}, \text{true}), \dots\}$$

Now that we have our corpus of sentences we split the corpus:

$$\text{Corpus} = \text{Train} \cup \text{Test}$$

in a training set  $\text{Train}$  and a test set  $\text{Test}$ . Sentences in the training set  $\text{Train}$  are used to do supervised quantum machine learning in order to learn the parameters that result in the correct measurement of the truth-labels. In this way, the parameters for the circuits that prepare the meaning states for nouns  $\{\text{Alice}, \text{Bob}\}$ , verbs  $\{\text{is}, \text{loves}, \text{hates}\}$ , and adjectives  $\{\text{rich}, \text{silly}\}$ , are learned.

The scheme for learning the parameters for words in sentences in the training set is as follows. The circuit of a sentence in the training set is evaluated for the current set of parameters on the quantum computer. By sampling measurement outcomes we estimate:

$$|\text{sentence}(\alpha_A, \beta_A, \alpha_B, \beta_B, \alpha, \beta, \dots)|^2$$

This number is read by a classical computer that checks how well this matches the desired truth label of the sentence. If there is a mismatch, our system updates the parameters so that the quantum computer may evaluate an updated circuit. Iterating this procedure until the parameters converge and all truth labels are reproduced for the sentences in the training set.

After training, sentences in  $\text{Test}$  are used to estimate how well the truth labels of new sentences, i.e. not in  $\text{Train}$ , are inferred. These new sentences share the same vocabulary as the sentences used for training, but they are grammatically and semantically different.

Note that finding the optimal sequence of updates is, in general, a so-called ‘hard optimization problem’, so it is important that our quantum meaning space is well designed and allows the learning to be as tractable as possible. This design feature is critical.

With this learning framework, we can now ask questions of the quantum computer, as long as the questions are grammatical sentences expressed in terms of the vocabulary and grammar used during training. We are pleased to add that in our experiment, questions can, in fact, be posed as compositions of already learned sentences. For example, we can use the relative pronoun *who* [58] (which we model in terms of CNOT gates within a quantum circuit) and ask:

Does Bob *who* is silly love Alice *who* is rich?

This is the same as asking whether:

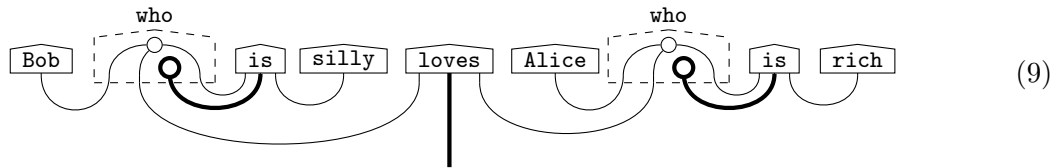

is *true*. This amounts to evaluating a bigger quantum circuit than the one that the model has been trained on. However, because the model was trained on the same grammar and vocabulary as used to express the question, we get the expected truth label, false in this case.

One critical enabling feature of our experiment is making computers understand the pictures that we have been drawing. For this we used GdF and AT’s DisCoPy Python library [32].

Another critical feature is effective and efficient compiling and optimization. In order to run a circuit on a quantum device, it needed to be compiled. Compiling entails morphing the circuit such that quantum operations are expressed in terms of device-native operations, as well as accommodating for the quantum processor’s restricted connectivity. For this task, we used Cambridge Quantum Computing’s quantum software development platform, t|ket> [62] which again crucially makes use of ZX-calculus.

## 5 QNLP

We’ve done it, it exists, so let’s give the kid a name: ‘quantum natural language processing’, or QNLP in short. A much more detailed account on QNLP as well as the data for a larger-scale experiment can be found in [20, 52, 47]. With the successful execution of QNLP on quantum hardware, and the great promise for the future, Cambridge Quantum Computing has now resourced an Oxford based team dedicated to QNLP, and structure-driven quantum AI more generally, evidently including each of us. Let’s single out a few special features of QNLP.

Firstly, as already indicated above, QNLP is quantum-native. What we mean by that is that the model of natural language that we employ is a quantum model [14]. Not just because we think that having a quantum model is particularly cool, but because it was effectively the case that the most economic manner for bringing language meaning and grammatical structure together was provided by the ‘categorical quantum mechanics’ framework [2, 15, 23].<sup>4</sup> The immediate consequence of this is that when we try to ‘simulate’ QNLP on a classical computer, it would be exponentially expensive, just as it is the case for simulation quantum systems on a classical computer. Hence, QNLP truly loves being on quantum hardware.

Secondly, it is fair to say that it is meaning-aware, at the very least, it is definitely more meaning-aware than the current deep learning based NLP implementations. Indeed, the language pictures clearly indicate how the meanings flow in a meaningful way. We say a bit more about this below in Section 9.

Thirdly, as already indicated in [67], there are many more advantages to using quantum computers, most notably, we get quantum speed-up for a large variety of NLP tasks, like question-answering. This space of opportunities is in fact still largely unexploited, and the mission of our QNLP team is to do just that, in as many possible manners as we can.

## 6 Beyond language

We are now well on the way to make qubits speak. But can we make them do other things as well? We are pretty sure we can, a first thing could be to make qubits represent all of the inputs that we get through our fleshy physical embodiment, like taste, smell, vision, hearing. The technical term for the kinds of spaces that represent these sensory modes is ‘conceptual spaces’. They were introduced by Peter Gärdenfors [36, 37]. There already are existing frameworks that represent the input of these senses in a manner that exactly matches our language diagrams, and hence allow for these sensory inputs to interact with each other [10].

These conceptual spaces are convex, and fit well with some other work within the framework of our natural language diagrams, namely on the use of the quantum mechanical concept of density matrices, which also form convex spaces [48, 8]. This additional convex structure allows one to bring many more linguistic features into play, like word ambiguity. For example, the

---

<sup>4</sup>Categorical quantum mechanics is really just a fancy name for doing quantum mechanics in terms of pictures.





Figure 5: Two close relatives with very different coats.

word **queen** is clearly ambiguous, as it can be a royal, a rock band, a bee, a chess piece, a playing card, etc. In order to represent that ambiguity, we simply add all the different meanings in order to form a density matrix [56]:

$$\begin{aligned}
 \rho_{\text{queen}} &= |\text{queen-royal}\rangle\langle\text{queen-royal}| \\
 &+ |\text{queen-band}\rangle\langle\text{queen-band}| \\
 &+ |\text{queen-bee}\rangle\langle\text{queen-bee}| \\
 &+ |\text{queen-chess}\rangle\langle\text{queen-chess}| \\
 &+ |\text{queen-card}\rangle\langle\text{queen-card}| \\
 &+ \dots
 \end{aligned}$$

Alternatively, these density matrices can also be used to express hierarchical relationships between words [6], for example, **lion**, **tiger** and **cheeta**, are examples of **big cat**, which further generalises to **mammal**, which generalises to **vertebrate**, etc. Using density matrices we encode this hierarchy as follows:

$$\begin{aligned}
 \rho_{\text{lion}} &= |0\rangle\langle 0| \\
 \rho_{\text{tiger}} &= |+\rangle\langle +| \\
 \rho_{\text{cheeta}} &= |-\rangle\langle -| \\
 \rho_{\text{big cat}} &= |0\rangle\langle 0| + |1\rangle\langle 1| \\
 \rho_{\text{mammal}} &= |0\rangle\langle 0| + |1\rangle\langle 1| + |2\rangle\langle 2| \\
 \rho_{\text{vertebrate}} &= |0\rangle\langle 0| + |1\rangle\langle 1| + |2\rangle\langle 2| + |3\rangle\langle 3|
 \end{aligned}$$

In [24, 45, 46, 33, 53] this use of density matrices in language is further elaborated upon.

## 7 String diagrams are everywhere

Sticking with the theme of big cats, what's the difference between a tiger and a lion? In particular, why does a tiger have stripes, while a lion doesn't. A more traditional scientist will tell you that these days we understand all of that perfectly well. Before, if we dissected these

animals, we found exactly the same organs. If we do some smaller scale animal chopping, we end up with cells that again have exactly the same structure. However, digging even further, and hitting the molecular level, we encounter DNA, and then we truly understand the difference.

Really? Some obscuro humongously large code that is impossible to grasp by any human ‘explains’ the difference? It explains as much the difference between these two animals as the codes of two computer programs written in terms of 0’s and 1’s explain the difference between accounting software and the operating system of your smart phone.

That said, most of the exact sciences have adopted this perspective of understanding things by breaking them down to smaller things, like elementary particles in particle physics, and the elements of a set in set-theory. In contrast, in the arts and humanities things really get their meanings by putting them in a context. For example, in the social sciences properties are mostly thought of in terms of behaviours, rather than by trying to build a map of the inside of someone’s brain, and most modern art has very little meaning without a context.

We think that we can all agree that for our tiger and our lion, what explains the difference is really the hunting process which each of them needs to do in order to survive, and their respective coats provide the best camouflage for doing so, given they hunt in very different environments. While of course these differences are encoded in the genes, it is the process of evolution that makes our tiger and our lion look as they do. The role of DNA in explaining the stripes of tigers is similar to the role of our parameters  $\alpha_A, \beta_A, \alpha_B, \dots$  in computing the meaning of sentences. Indeed, learning the optimal parameters is an evolution-like process that depends on the environment of the words, i.e. on the training data that we feed the machine.

So the two views explained above are really about either focussing on components vs. context, and the latter is very much in line with Wittgenstein’s “meaning is use”. We are saying all of this because the language diagrams that we saw above are the mathematical incarnation of this way of thinking, for example:

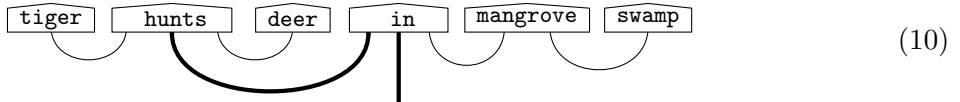

Indeed, this way of thinking requires a completely different kind of mathematics, be it in the form of our diagrams, or its symbolic counterpart, so-called monoidal categories.

This is not the place to go into this new kind of mathematics, but the interested reader may want to check out the book [23], which is probably the most comprehensive account on these language diagrams, and their communality with quantum theory. Shorter more informal accounts can be found in [17]. For the braver reader, the symbolic counterpart of all of this exists within the realm of category theory, and tensor categories in particular [25, 59]. Meanwhile, string diagrams have started to pop up in a wide variety of disciplines, for example, in computer science [1, 55], where they have been for a while, in engineering [11, 4], in economy and game theory [38, 30], and even in cognition [65, 61].

We believe that this is the kind of mathematics that would also serve the social sciences very well. As it is quite new, most mathematics that one finds in the social sciences is statistics, which, in all fairness, is what one uses in absence of anything better.

With new mathematics also come new software tools. For this we are using the new very flexible DisCoPy software [32] which we already mentioned above, and continues to be further developed by AT, GdF and collaborators. We’re inviting everyone to play around with this toolbox, and even better, help us out further developing DisCoPy—we may even reward you

with a pie. For ZX-calculus specifically there is now also the PyZX software [42], which communicates directly with DisCoPy. PyZX also helps us out with our QNLP experiments, by making the circuits that we feed into the quantum computer as simple as possible, a task for which ZX-calculus is now setting the state-of-the-art [34, 28, 29].

## 8 Compositionality

Above we saw how we can turn language diagrams into circuits. A typical thing about circuits is, of course, that you can compose different circuits together for forming bigger circuits. This is the principle of “compositionality”, and in fact, string diagrams themselves are a result of this way of thinking. We can now, once we moved to circuits, compose several sentences together in order to produce larger text:

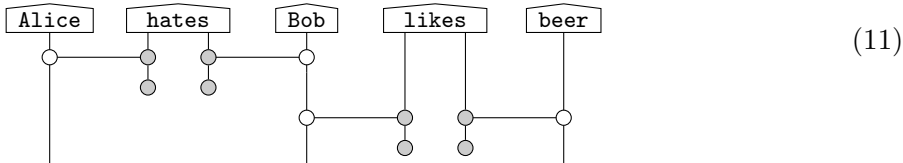

But why do we have to go to quantum circuits to do so? Indeed, it goes without saying that in absence of quantum circuits we can also compose sentences in order to form larger text, so there should be manner for doing so without having to dive in the realm of the quantum world.

This is indeed the case, when stopping halfway in the middle when passing from language diagrams to quantum circuits [18]. There we also find circuits that can be composed, and interestingly, some of the features specific to different languages (e.g. specific orderings of words like subject-verb-object in English) are gone [27]. So in a manner we end up with something that is more universal than language diagrams, and, for example, stands in a particularly close relationship with visual representations [18]. Here’s the language circuit:

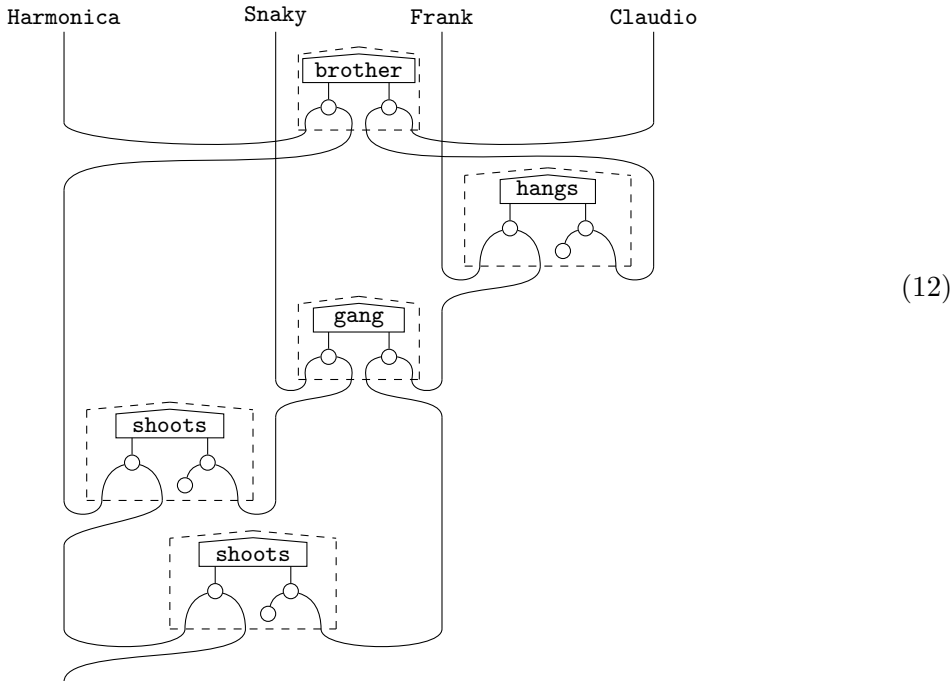

and here's the corresponding visual representation:

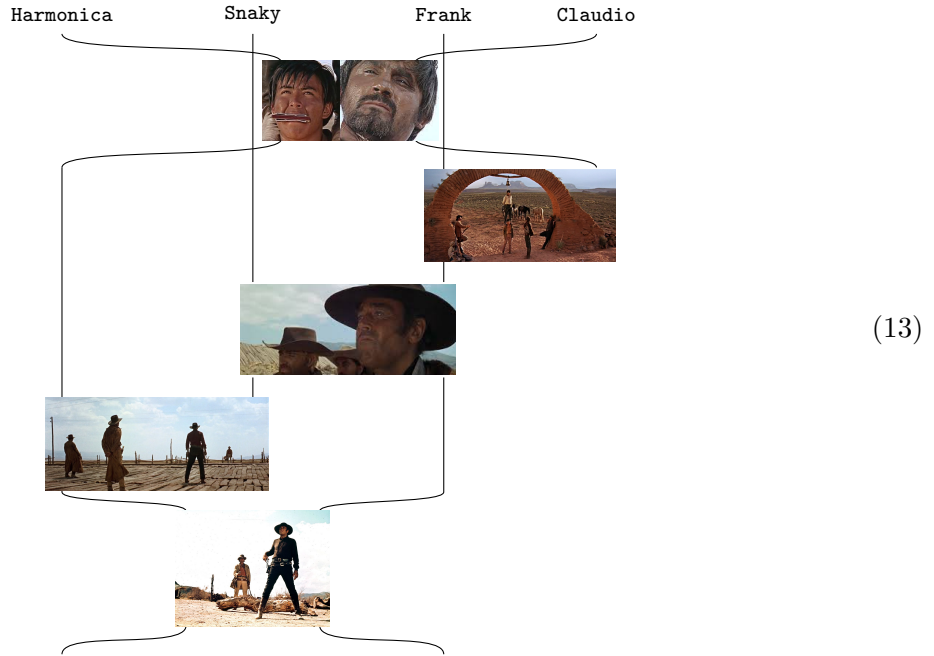

Maybe there is something deeper here. Maybe the origin of language should be looked for in the visual world, rather than in some symbolic abstract realm. The passage from these visual circuits to the more complex grammatical structure may actually boil down to forcing something that wants to live in two (or more) dimensions on a line, and force additional bureaucracy (or, bureau-crazy?) like the ordering of words, which ends up being different for different languages. Why forced into one-dimension? Since it seems to be hard for us humans to communicate verbally in any other way than in terms of one-dimensional strings of sounds.

In fact, the very success of string diagrams is that it allows things to live in two (or more) dimensions. Here's a demonstration of this fact. Consider the operations of parallel composition  $\otimes$  (a.k.a. 'while') and sequential composition  $\circ$  (a.k.a. 'after'). Typically, in textbooks, this structure is represented by one-dimensional strings of algebraic symbols, and then, equations are needed to express their interaction (a.k.a. bifunctionality [50]):

$$(g_1 \otimes g_2) \circ (f_1 \otimes f_2) = (g_1 \circ f_1) \otimes (g_2 \circ f_2)$$

On the other hand, representing it in terms of two-dimensional diagrams we have:

$$\left( \begin{array}{c} | \\ \boxed{g_1} \\ | \end{array} \otimes \begin{array}{c} | \\ \boxed{g_2} \\ | \end{array} \right) \circ \left( \begin{array}{c} | \\ \boxed{f_1} \\ | \end{array} \otimes \begin{array}{c} | \\ \boxed{f_2} \\ | \end{array} \right) = \left( \begin{array}{c} | \\ \boxed{g_1} \quad \boxed{g_2} \\ | \end{array} \right) \circ \left( \begin{array}{c} | \\ \boxed{f_1} \quad \boxed{f_2} \\ | \end{array} \right) = \begin{array}{c} | \quad | \\ \boxed{f_1} \quad \boxed{f_2} \\ | \quad | \\ \boxed{g_1} \quad \boxed{g_2} \\ | \quad | \end{array}$$

$$\left( \begin{array}{c} | \\ \boxed{g_1} \circ \boxed{f_1} \\ | \end{array} \right) \otimes \left( \begin{array}{c} | \\ \boxed{g_2} \circ \boxed{f_2} \\ | \end{array} \right) = \left( \begin{array}{c} | \\ \boxed{f_1} \\ | \end{array} \right) \otimes \left( \begin{array}{c} | \\ \boxed{f_2} \\ | \end{array} \right) = \begin{array}{c} | \quad | \\ \boxed{f_1} \quad \boxed{f_2} \\ | \quad | \\ \boxed{g_1} \quad \boxed{g_2} \\ | \quad | \end{array}$$

That is, by using the two-dimensional format of diagrams, the symbolic equation is always satisfied, so it is not needed anymore. In other words, the equation was a piece of bureaucracy due to the one dimensional symbolic representation.

## 9 Meaning-aware relational wholism

Let's end with a bit of philosophy, which puts our language diagrams within a broader context of different approaches that one may take towards machine learning. We'll again do this by means of a metaphor. Assume one wants to design a home. One way to do so would be to train a machine using many different images of homes, possibly with some indications of appreciation. Then, let the machine be creative and design a home based on all of that input.

And it comes up with an amazing design. But what did it really do? It kind of carved everything out of one big block of stuff, and there will be forks and plates on the table, chairs at the table, pictures on the wall, since that's where they were in all of the training images. However, the machine is unaware of what the use is of each of these objects, and in particular that there is a very special relationship between the plate and the fork, and also with the chair at the table (and less so with the picture on the wall), and even more so, that there is a person who happens to be not in the picture, but who wants to exploit this special relationship with respect to the food they are cooking in the kitchen.

On the other hand, our language diagrams, when applied to a broader context, can capture these relationships, in contrast to the black-box approach that is taken within machine learning:

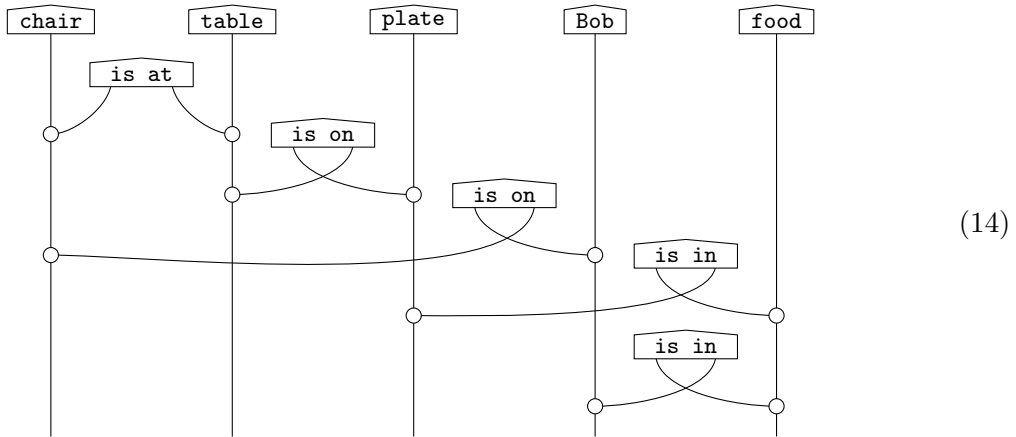

The kind of thinking encoded in our language diagrams, which is fundamentally wholistic while still aiming to grasp relationships between the parts, is what we mean by the title of this section.

What our language diagrams do is express how words interact with each other. Once we have established that structure, one thing that we can do is compute the meaning of a sentence from the meanings of words. The more interesting thing however, is to derive the meanings of words from the meaning of sentences. This is exactly what we did in our QNLP experiment: from the knowledge that the sentences in *Train* were true, we figured out the optimal parameters  $\alpha_A, \beta_A, \alpha_B, \beta_B, \alpha, \beta, \dots$  which determine the meanings of the words.

This is really what this paper was all about, instantiated in order to make qubits speak. After this philosophy interlude...

## 10 ...let's get playing!

First, we need some data to play with. For this we have two options: 1) we generate an artificial dataset by designing the grammar ourselves, this is the simplest option and the one we have implemented in [20] or 2) we take some real-world text data (e.g. every sentence from Alice in Wonderland) and use a parser to construct the diagrams automatically for us. In any case, we

begin our experiment with a collection of diagrams for sentences, with some annotation telling us whether each sentence is true or false (or whether or not it comes from Alice in Wonderland).

Next, we need to choose an ansatz for each type of word, i.e. an appropriate circuit shape. Instantaneous quantum polynomials (IQP) [60] are a reasonable choice, since they are shallow circuits but are still believed to be hard to simulate for classical computers. Once we've chosen the circuit shape for each type, this defines a *landscape*, the total number of parameters defining our model: the sum of the parameters defining each word. For each point in this landscape, i.e. for each combination of parameters, we can run the circuits corresponding to each sentence in our dataset and check how far away we are from the correct label. The sum of the distance between our model's prediction and the correct label is called the *loss function*, this is the objective that we want to minimise.

Once we have defined the landscape and the loss, we can feed them as input to the optimisation algorithm of our choice. The easiest choice, and the one we implemented in [20], is to pick a black box optimiser such as simultaneous perturbation stochastic approximation (SPSA) [63]. A more advanced solution is to go fully diagrammatic and compute the gradient of our loss directly from the shape of the diagrams for sentences [64]. When the process has converged to some (locally) optimal parameters, tadam! We have successfully trained our quantum natural language model. We may now evaluate it on some testing data, typically a subset of the sentences that we withhold from the training set. Note that crucially, even though our model has never seen these sentences during training, hopefully it has already learnt the meanings for the words, and it knows how to combine these meanings in new ways.

Thus, a typical QNLP experiment may be summarised as follows: 1) we draw the diagrams for each sentences, 2) we pick a circuit shape for each word type, 3) we define a loss function, 4) we find the optimal parameters and 5) we test the model's prediction. These five steps fit in a few lines of Python using the tools from the DisCoPy library, the result can then be presented in the form of a Jupyter notebook, see the documentation for plenty of examples:

<https://discopy.readthedocs.io/en/main/notebooks.qnlp.html>

Also, here is a more detailed tutorial as well:

<https://discopy.readthedocs.io/en/main/notebooks/qnlp-tutorial.html>

## 11 Outlook

So what's next? Well, as we speak the editor of this volume is himself getting to play, and obviously, we will also embark on a musical adventure. Evidently, we will also further develop QNLP bringing in more conceptual depth, for the specific case of language as well as towards broader AI features. Experimentally, we keep pushing along as hardware improves.

All together this is just the beginning of an adventure that, we hope, on the one hand, will create the next generation of AI, and on the other hand, will further the quest towards better understanding the human mind and its interaction with the world around us.

## References

- [1] S. Abramsky. Retracing some paths in process algebra. In *CONCUR'96: Concurrency Theory*, volume 1119 of *Lecture Notes in Computer Science*, pages 1–17. Springer, 1996.

- [2] S. Abramsky and B. Coecke. A categorical semantics of quantum protocols. In *Proceedings of the 19th Annual IEEE Symposium on Logic in Computer Science (LICS)*, pages 415–425, 2004. arXiv:quant-ph/0402130.
- [3] K. Adjukiewicz. Die syntaktische Konnexität. *Studia Philosophica*, 1935.
- [4] J. C. Baez and B. Fong. A compositional framework for passive linear networks. *arXiv:1504.05625*, 2015.
- [5] J. C. Baez and M. Stay. Physics, topology, logic and computation: a Rosetta stone. In B. Coecke, editor, *New Structures for Physics*, Lecture Notes in Physics, pages 95–172. Springer, 2011.
- [6] D. Bankova, B. Coecke, M. Lewis, and D. Marsden. Graded hyponymy for compositional distributional semantics. *Journal of Language Modelling*, 6(2):225–260, 2019.
- [7] Y. Bar-Hillel. A quasiarithmetic notation for syntactic description. *Language*, 29:47–58, 1953.
- [8] J. Barrett. Information processing in generalized probabilistic theories. *Physical Review A*, 75:032304, 2007.
- [9] M. Benedetti, E. Lloyd, S. Sack, and M. Fiorentini. Parameterized quantum circuits as machine learning models. *Quantum Science and Technology*, 4:043001, 2019.
- [10] J. Bolt, B. Coecke, F. Genovese, M. Lewis, D. Marsden, and R. Piedeleu. Interacting conceptual spaces I: Grammatical composition of concepts. In M. Kaipainen, A. Hautamäki, P. Gärdenfors, and F. Zenker, editors, *Concepts and their Applications*, Synthese Library, Studies in Epistemology, Logic, Methodology, and Philosophy of Science. Springer, 2018. to appear.
- [11] F. Bonchi, P. Sobocinski, and F. Zanasi. A categorical semantics of signal flow graphs. In *CONCUR'14: Concurrency Theory.*, volume 8704 of *Lecture Notes in Computer Science*, pages 435–450. Springer, 2014.
- [12] N. Chomsky. Tree models for the description of language. *I.R.E. Transactions on Information Theory*, IT-2:113–124, 1956.
- [13] N. Chomsky. *Syntactic Structures*. Mouton, 1957.
- [14] S. Clark, B. Coecke, E. Grefenstette, S. Pulman, and M. Sadrzadeh. A quantum teleportation inspired algorithm produces sentence meaning from word meaning and grammatical structure. *Malaysian Journal of Mathematical Sciences*, 8:15–25, 2014. arXiv:1305.0556.
- [15] B. Coecke. Kindergarten quantum mechanics. In A. Khrennikov, editor, *Quantum Theory: Reconsiderations of the Foundations III*, pages 81–98. AIP Press, 2005. arXiv:quant-ph/0510032.
- [16] B. Coecke. An alternative Gospel of structure: order, composition, processes. In C. Heunen, M. Sadrzadeh, and E. Grefenstette, editors, *Quantum Physics and Linguistics. A Compositional, Diagrammatic Discourse*, pages 1 – 22. Oxford University Press, 2013. arXiv:1307.4038.

- [17] B. Coecke. From quantum foundations via natural language meaning to a theory of everything. In S. B. Cooper and M. I. Soskova, editors, *The Incomputable: Journeys Beyond the Turing Barrier*, Theory and Applications of Computability, pages 63–80. Springer International Publishing, 2017. arXiv:1602.07618.
- [18] B. Coecke. The mathematics of text structure, 2019. arXiv:1904.03478.
- [19] B. Coecke, G. De Felice, D. Marsden, and A. Toumi. Towards compositional distributional discourse analysis. In M. Lewis, B. Coecke, J. Hedges, D. Kartsaklis, and D. Marsden, editors, Proc. of the 2018 Workshop on *Compositional Approaches in Physics, NLP, and Social Sciences*, volume 283 of *Electronic Proceedings in Theoretical Computer Science*, pages 1–12, 2018.
- [20] B. Coecke, G. de Felice, K. Meichanetzidis, and A. Toumi. Foundations for near-term quantum natural language processing, 2020. arXiv preprint arXiv:2012.03755.
- [21] B. Coecke and R. Duncan. Interacting quantum observables: categorical algebra and diagrammatics. *New Journal of Physics*, 13:043016, 2011. arXiv:quant-ph/09064725.
- [22] B. Coecke and R. Duncan. Tutorial: Graphical calculus for quantum circuits. In *International Workshop on Reversible Computation*, pages 1–13. Springer, 2012.
- [23] B. Coecke and A. Kissinger. *Picturing Quantum Processes. A First Course in Quantum Theory and Diagrammatic Reasoning*. Cambridge University Press, 2017.
- [24] B. Coecke and K. Meichanetzidis. Meaning updating of density matrices. *arXiv:2001.00862*, 2020.
- [25] B. Coecke and É. O. Paquette. Categories for the practicing physicist. In B. Coecke, editor, *New Structures for Physics*, Lecture Notes in Physics, pages 167–271. Springer, 2011. arXiv:0905.3010.
- [26] B. Coecke, M. Sadrzadeh, and S. Clark. Mathematical foundations for a compositional distributional model of meaning. In J. van Benthem, M. Moortgat, and W. Buszkowski, editors, *A Festschrift for Jim Lambek*, volume 36 of *Linguistic Analysis*, pages 345–384. 2010. arxiv:1003.4394.
- [27] B. Coecke and V. Wang. De-humanising grammar for improved machine use. *Draft paper*, 2020.
- [28] A. Cowtan, S. Dilkes, R. Duncan, W. Simmons, and S. Sivarajah. Phase gadget synthesis for shallow circuits. *arXiv preprint arXiv:1906.01734*, 2019.
- [29] N. de Beaudrap, X. Bian, and Q. Wang. Fast and effective techniques for t-count reduction via spider nest identities. In *15th Conference on the Theory of Quantum Computation, Communication and Cryptography (TQC 2020)*. Schloss Dagstuhl-Leibniz-Zentrum für Informatik, 2020. arXiv:2004.05164.
- [30] G. de Felice, E. Di Lavore, M. Román, and A. Toumi. Functorial language games for question answering. *arXiv preprint arXiv:2005.09439*, 2020.
- [31] G. de Felice, K. Meichanetzidis, and A. Toumi. Functorial question answering. *arXiv preprint arXiv:1905.07408*, 2019.



- [32] G. de Felice, A. Toumi, and B. Coecke. DisCoPy: Monoidal categories in python. *Accepted for ACT 2020*, 2020. arXiv preprint arXiv:2005.02975.
- [33] G. De las Cuevas, A. Klingler, M. Lewis, and T. Netzer. Cats climb entails mammals move: preserving hyponymy in compositional distributional semantics. *arXiv:2005.14134 [quant-ph]*, 2020.
- [34] R. Duncan, A. Kissinger, S. Pedrix, and J. van de Wetering. Graph-theoretic simplification of quantum circuits with the zx-calculus. *arXiv preprint arXiv:1902.03178*, 2019.
- [35] J. R. Firth. A Synopsis of Linguistic Theory, 1930-1955. *Studies in Linguistic Analysis*, pages 1–32, 1957.
- [36] P. Gärdenfors. *Conceptual spaces: the geometry of thought*. MIT Press, 2000.
- [37] P. Gärdenfors. *The Geometry of Meaning: Semantics Based on Conceptual Spaces*. MIT Press, 2014.
- [38] N. Ghani, J. Hedges, V. Winschel, and P. Zahn. Compositional game theory. In *Proceedings of the 33rd Annual ACM/IEEE Symposium on Logic in Computer Science*, pages 472–481. ACM, 2018.
- [39] V. Giovannetti, S. Lloyd, and L. Maccone. Quantum random access memory. *Physical review letters*, 100(16):160501, 2008.
- [40] A. Hadzihasanovic, K. F. Ng, and Q. Wang. Two complete axiomatisations of pure-state qubit quantum computing. In *Proceedings of the 33rd Annual ACM/IEEE Symposium on Logic in Computer Science*, pages 502–511. ACM, 2018.
- [41] Z. S. Harris. Distributional structure. *Word*, 10(2-3):146–162, 1954.
- [42] A. Kissinger and J. van de Wetering. Pyzx: Large scale automated diagrammatic reasoning. *arXiv preprint arXiv:1904.04735*, 2019.
- [43] J. Lambek. The mathematics of sentence structure. *American Mathematics Monthly*, 65, 1958.
- [44] J. Lambek. From word to sentence. *Polimetrica, Milan*, 2008.
- [45] M. Lewis. Compositional hyponymy with positive operators. In *Proceedings of Recent Advances in Natural Language Processing, Varna, Bulgaria*, pages 638–647, 2019.
- [46] M. Lewis. Towards negation in discocat, 2019. Proceedings of SemSpace 2019.
- [47] R. Lorenz, A. Pearson, K. Meichanetzidis, D. Kartsalkis, and B. Coecke. Qnlp in practice: Running compositional models of meaning on a quantum computer. *arXiv preprint arXiv:2102.12846*, 2021.
- [48] G. Ludwig. *An Axiomatic Basis of Quantum Mechanics: Volume 1, Derivation of Hilbert Space*. Springer-Verlag, Berlin Heidelberg, 1985.
- [49] Y. Ma, V. Tresp, L. Zhao, and Y. Wang. Variational quantum circuit model for knowledge graph embedding. *Advanced Quantum Technologies*, page 1800078, 2019.

- [50] S. Mac Lane. *Categories for the working mathematician*. Springer-verlag, 1998.
- [51] K. Meichanetzidis, S. Gogioso, G. de Felice, A. Toumi, N. Chiappori, and B. Coecke. Quantum natural language processing on near-term quantum computers. *Accepted for QPL 2020*, 2020. arXiv preprint arXiv:2005.04147.
- [52] K. Meichanetzidis, A. Toumi, G. de Felice, and B. Coecke. Grammar-aware question-answering on quantum computers. 2020. arXiv:2012.03756.
- [53] F. Meyer and M. Lewis. Modelling lexical ambiguity with density matrices. In *Proceedings of the 24th Conference on Computational Natural Language Learning*, pages 276–290, 2020. arXiv:2010.05670 [cs.CL].
- [54] L. J. O’Riordan, M. Doyle, F. Baruffa, and V. Kannan. A hybrid classical-quantum workflow for natural language processing. *arXiv preprint arXiv:2004.06800*, 2020.
- [55] D. Pavlovic. Monoidal computer I: Basic computability by string diagrams. *Information and computation*, 226:94–116, 2013.
- [56] R. Piedeleu, D. Kartsaklis, B. Coecke, and M. Sadrzadeh. Open system categorical quantum semantics in natural language processing. In *6th Conference on Algebra and Coalgebra in Computer Science (CALCO 2015)*. Schloss Dagstuhl-Leibniz-Zentrum fuer Informatik, 2015.
- [57] Intel News Release. *Intel to support the Irish Centre for High End Computing on new collaborative quantum computing project*, March 6, 2019. <https://newsroom.intel.ie/news-releases/intel-to-support-the-irish-centre-for-high-end-computing-on-new-collaborative-quantum-computing-project/>.
- [58] M. Sadrzadeh, S. Clark, and B. Coecke. The Frobenius anatomy of word meanings I: subject and object relative pronouns. *Journal of Logic and Computation*, 23:1293–1317, 2013. arXiv:1404.5278.
- [59] P. Selinger. A survey of graphical languages for monoidal categories. In B. Coecke, editor, *New Structures for Physics*, Lecture Notes in Physics, pages 275–337. Springer-Verlag, 2011. arXiv:0908.3347.
- [60] D. Shepherd and M. J. Bremner. Temporally unstructured quantum computation. *Proceedings of the Royal Society A: Mathematical, Physical and Engineering Sciences*, 465(2105):1413–1439, 2009.
- [61] C. M. Signorelli, Q. Wang, and I. Khan. A compositional model of consciousness based on consciousness-only. *arXiv preprint arXiv:2007.16138*, 2020.
- [62] S. Sivarajah, S. Dilkes, A. Cowtan, W. Simmons, A. Edgington, and R. Duncan.  $t|ket\rangle$ : A retargetable compiler for NISQ devices. *arXiv preprint arXiv:2003.10611*, 2020.
- [63] J. C. Spall et al. Multivariate stochastic approximation using a simultaneous perturbation gradient approximation. *IEEE transactions on automatic control*, 37(3):332–341, 1992.
- [64] A. Toumi, R. Yeung, and G. de Felice. Diagrammatic differentiation for quantum machine learning. *arXiv preprint arXiv:2103.07960*, 2021.

- [65] S Tull and J. Kleiner. Integrated information in process theories. *arXiv preprint arXiv:2002.07654*, 2020.
- [66] J. van de Wetering. ZX-calculus for the working quantum computer scientist. *arXiv:2012.13966*, 2020.
- [67] W. Zeng and B. Coecke. Quantum algorithms for compositional natural language processing. *Electronic Proceedings in Theoretical Computer Science*, 221, 2016. arXiv:1608.01406.