



Towards exact structural thresholds for parameterized complexity

Falko Hegerfeld  

Humboldt-Universität zu Berlin, Germany

Stefan Kratsch  

Humboldt-Universität zu Berlin, Germany

Abstract

Parameterized complexity seeks to optimally use input structure to obtain faster algorithms for NP-hard problems. This has been most successful for graphs of low treewidth, i.e., graphs decomposable by small separators: Many problems admit fast algorithms relative to treewidth and many of them are optimal under the Strong Exponential-Time Hypothesis (SETH). Fewer such results are known for more general structure such as low clique-width (decomposition by large and dense but structured separators) and more restrictive structure such as low deletion distance to some sparse graph class.

Despite these successes, such results remain “islands” within the realm of possible structure. Rather than adding more islands, we seek to determine the transitions between them, that is, we aim for structural thresholds where the complexity increases as input structure becomes more general. Going from deletion distance to treewidth, is a single deletion set to a graph with simple components enough to yield the same lower bound as for treewidth or does it take many disjoint separators? Going from treewidth to clique-width, how much more density entails the same complexity as clique-width? Conversely, what is the most restrictive structure that yields the same lower bound?

For treewidth, we obtain both refined and new lower bounds that apply already to graphs with a single separator X such that $G - X$ has treewidth at most $r = \mathcal{O}(1)$, while G has treewidth $|X| + \mathcal{O}(1)$. We rule out algorithms running in time $\mathcal{O}^*((r + 1 - \varepsilon)^k)$ for DELETION TO r -COLORABLE parameterized by $k = |X|$; this implies the same lower bound relative to treedepth and (hence) also to treewidth. It specializes to $\mathcal{O}^*((3 - \varepsilon)^k)$ for ODD CYCLE TRANSVERSAL where $\text{tw}(G - X) \leq r = 2$ is best possible. For clique-width, an extended version of the above reduction rules out time $\mathcal{O}^*((4 - \varepsilon)^k)$, where X is allowed to be a possibly large separator consisting of k (true) twinclasses, while the treewidth of $G - X$ remains r ; this is proved also for the more general DELETION TO r -COLORABLE and it implies the same lower bound relative to clique-width. Further results complement what is known for VERTEX COVER, DOMINATING SET and MAXIMUM CUT. All lower bounds are matched by existing and newly designed algorithms.

2012 ACM Subject Classification Theory of computation \rightarrow Parameterized complexity and exact algorithms; Mathematics of computing \rightarrow Graph algorithms

Keywords and phrases Parameterized complexity, lower bound, vertex cover, odd cycle transversal, SETH, modulator, treedepth, cliquewidth

Funding *Falko Hegerfeld*: Partially supported by DFG Emmy Noether-grant (KR 4286/1).

1 Introduction

The goal of parameterized complexity is to leverage input structure to obtain faster algorithms than in the worst case and to identify algorithmically useful structure. The most prominent structural graph parameter *treewidth* measures the size of *separators* decomposing the graph. Many problems admit fast algorithms relative to treewidth and we can often certify their optimality assuming the *Strong Exponential-Time Hypothesis* (SETH) [9, 13, 14, 46]. Such (conditional) *optimality results* allow us to conduct a precise study of the impact of structure on the running time, whereas otherwise the currently best running time might be an artifact due to the momentary lack of algorithmic tools and not inherent to the structure.

The structure captured by treewidth can be varied in several ways: In the *sparse setting*, we may restrict the interplay of separators and/or allow additional connected components from some graph class \mathcal{H} ; this yields notions such as treedepth as well as deletion resp. elimination distance to \mathcal{H} . In the *dense setting*, we may allow large and dense but structured separators; this yields e.g. clique-width and rank-width. Conceptually, the difference between parameters may be quite large: if the complexity of a problem changes between two parameters, then it is difficult to pinpoint which structural feature has led to the change in complexity.

We seek to delineate more *exact structural thresholds* between these parameters. This can be done by designing algorithms relative to more permissible parameters or by establishing the same lower bounds relative to more restrictive parameters. We focus on the latter approach in a fine-grained setting, i.e., all considered problems can be solved in time $\mathcal{O}^*(c^k)^1$ for some constant c and parameter k and we determine the precise value of the base c .

For parameters other than treewidth far fewer optimality results are known. In particular, to the best of our knowledge, the only known fine-grained optimality results for NP-hard problems relative to a deletion distance are for r -COLORING [38, 46], its generalization LIST HOMOMORPHISM [55], and isolated results on VERTEX COVER [36] and CONNECTED VERTEX COVER [11]. The crux is that other lower bound proofs deal with more complex problems (e.g., deletion of vertices, packing of subgraphs, etc.) by copying the same (type of) partial solution over many *noncrossing* separators; this addresses several obstacles but makes the approach unsuitable for deletion distance parameters (or even for treedepth). We show that a much broader range of problems may admit such improved lower bounds by giving the new tight lower bounds for *vertex deletion problems* such as VERTEX COVER and ODD CYCLE TRANSVERSAL relative to deletion distance parameters, in both sparse and dense settings.

Sparse Setting. Our main problem of study is DELETION TO r -COLORABLE, i.e., delete as few vertices as possible so that an r -colorable graph remains, which specializes to VERTEX COVER for $r = 1$ and to ODD CYCLE TRANSVERSAL for $r = 2$. The first parameterization which we study is the size $|X|$ of a *modulator* $X \subseteq V(G)$, or deletion distance, to treewidth r , i.e., $\text{tw}(G - X) \leq r$. Our main result in the sparse setting is the following.

► **Theorem 1.1.** *If there are $r \geq 2$, $\varepsilon > 0$ such that DELETION TO r -COLORABLE can be solved in time $\mathcal{O}^*((r+1-\varepsilon)^{|X|})$, where X is a modulator to treewidth r , then SETH is false.²*

The general construction for DELETION TO r -COLORABLE, $r \geq 2$, does not work for the case $r = 1$, i.e., VERTEX COVER, and we fill this gap by providing a simple ad-hoc construction for VERTEX COVER parameterized by a modulator to pathwidth 2.

¹ The \mathcal{O}^* -notation suppresses factors that are polynomial in the input size.

² We assume that an appropriate decomposition is given, thus strengthening the lower bounds.

► **Theorem 1.2.** *If there is an $\varepsilon > 0$ such that VERTEX COVER can be solved in time $\mathcal{O}^*((2 - \varepsilon)^{|X|})$, where X is a modulator to pathwidth 2, then SETH is false.*

These results improve the known lower bounds for VERTEX COVER and ODD CYCLE TRANSVERSAL parameterized by pathwidth and provide new tight lower bounds for $r \geq 3$ as a matching upper bound follows from generalizing the known algorithm for ODD CYCLE TRANSVERSAL parameterized by treewidth. Note that in Theorem 1.1 the treewidth bound r is the same as the bound r on the number of colors. This treewidth bound, at least for $r = 2$, and the pathwidth bound in Theorem 1.2 cannot be improved due to upper bounds obtained by Lokshtanov et al. [47] for VERTEX COVER and ODD CYCLE TRANSVERSAL parameterized by an odd cycle transversal or a feedback vertex set. Lokshtanov et al. [46] asked if the complexity of problems, other than r -COLORING (where a modulator to a single path is already sufficient [38]), relative to treewidth could already be explained with parameterization by feedback vertex set. As argued, this cannot be true for VERTEX COVER and ODD CYCLE TRANSVERSAL, so our results are essentially the next best explanation.

Furthermore, the previous two theorems also imply the same lower bound for parameterization by *treedepth*³, thus yielding the first tight lower bounds relative to treedepth for vertex selection problems and partially resolving a question of Jaffke and Jansen [38] regarding the complexity relative to treedepth for problems studied by Lokshtanov et al. [46].

► **Corollary 1.3.** *If there is an $r \geq 1$ and an $\varepsilon > 0$ such that DELETION TO r -COLORABLE can be solved in time $\mathcal{O}^*((r + 1 - \varepsilon)^{\text{td}(G)})$, then SETH is false.*

Dense Setting. Our results on deletion distances can actually be lifted to the *dense setting*. We do so by considering *twinclasses*, which are arguably the simplest form of dense structure. A twinclass is an equivalence class of the *twin*-relation, which says that two vertices u and v are twins if $N(u) \setminus \{v\} = N(v) \setminus \{u\}$, i.e., u and v have the same neighborhood outside of $\{u, v\}$. Given two distinct twinclasses, either all edges between them exist or none of them do. Contracting each twinclass yields the *quotient graph* G^q and we obtain *twinclass-variants* of the usual graph parameters treedepth, cutwidth, pathwidth, and treewidth by measuring these parameters on the quotient graph G^q , e.g., the *twinclass-pathwidth* of G is $\text{tc-pw}(G) = \text{pw}(G^q)$. The parameters twinclass-pathwidth and twinclass-treewidth have been studied before under the name *modular pathwidth* and *modular treewidth* [45, 50, 54]. Furthermore, we remark that the previously studied parameter *neighborhood diversity* satisfies $\text{nd}(G) = |V(G^q)|$ [44]. Relationships between parameters transfer to their twinclass-variants and twinclass-pathwidth is more restrictive than *linear-clique-width*. Similarly, we obtain *twinclass-modulators*, but we measure the complexity of the remaining components on the level of the original graph, i.e., a twinclass-modulator (TCM) \mathcal{X} to treewidth r is a family \mathcal{X} of twinclasses such that $\text{tw}(G - \bigcup_{X \in \mathcal{X}} X) \leq r$. We can now state our second main result, which, similarly to the sparse setting, also carries over to twinclass-treedepth.

► **Theorem 1.4.** *If there are $r \geq 2$, $\varepsilon > 0$ such that DELETION TO r -COLORABLE can be solved in time $\mathcal{O}^*((2^r - \varepsilon)^{|\mathcal{X}|})$, where \mathcal{X} is a TCM to treewidth r , then SETH is false.*

Additionally, it follows that if there are $r \geq 2$, $\varepsilon > 0$ such that DELETION TO r -COLORABLE can be solved in time $\mathcal{O}^((2^r - \varepsilon)^{\text{tc-td}(G)})$, then SETH is false.*

³ If $\text{tw}(G - X) \leq t$, then $\text{td}(G) \leq |X| + (t + 1) \log_2 |V|$, cf. Nešetřil and Ossona de Mendez [51], and $\mathcal{O}^*(c^{\text{td}(G)}) = \mathcal{O}^*(c^{|X|} |V|^{(t+1) \log_2 c}) = \mathcal{O}^*(c^{|X|})$.

Due to the inequalities $\text{cw}(G) \leq \text{tc-pw}(G) + 3$ and $\text{pw}(G) \leq \text{td}(G)$, cf. Lampis [45] and Nešetřil and Ossona de Mendez [51], we see that $\text{cw}(G) \leq \text{tc-td}(G) + 3$. Hence any $\mathcal{O}^*(c^{\text{cw}(G)})$ -time algorithm also implies a $\mathcal{O}^*(c^{\text{tc-td}(G)})$ -time algorithm. Thus, the following result, relying on standard techniques for dynamic programming on graph decompositions such as the (min, +)-cover product, yields a tight upper bound complementing the previous lower bounds.

► **Theorem 1.5.** *Given a k -clique-expression μ for G , DELETION TO r -COLORABLE on G can be solved in time $\mathcal{O}^*((2^r)^k)$.⁴*

There is no further lower bound result for VERTEX COVER, since $r + 1 = 2^r$ for $r = 1$ and hence Theorem 1.2 already yields a tight lower bound for the clique-width-parameterization.

Going into more detail, the twinclasses of the modulator in the construction for Theorem 1.4 are *true twinclasses*, i.e., each twinclass induces a clique, and moreover they are of size r (with a small exception). Intuitively, allowing for deletions, there are 2^r possible sets of at most r colors that can be assigned to a clique of size r , e.g., the empty set \emptyset corresponds to deleting the clique completely. Hence, our results essentially show that it is necessary and optimal to go through all of these color sets for each twinclass in the modulator.

In contrast, consider the situation for r -COLORING where Lampis [45] has obtained tight running times of $\mathcal{O}^*\left(\binom{r}{\lfloor r/2 \rfloor}^{\text{tc-tw}(G)}\right)$ when parameterized by twinclass-treewidth and of time $\mathcal{O}^*((2^r - 2)^{\text{cw}(G)})$ when parameterized by clique-width. Whereas the complexities for r -COLORING vary between the twinclass-setting and clique-width, this is not the case for DELETION TO r -COLORABLE. The base $\binom{r}{\lfloor r/2 \rfloor}$ is due to the fact that without deletions only color sets of the same size as the considered (true) twinclass can be attained and the most sets are possible when the size is $\lfloor r/2 \rfloor$. For clique-width, a *label class* may induce more complicated graphs than cliques or independent sets and the interaction between two label classes may also be more intricate. Lampis [45] shows that the extremal cases of color sets \emptyset and $[r] = \{1, \dots, r\}$ can be handled separately, thus yielding the base $2^r - 2$ for clique-width.

Additional results. As separate results, we obtain the following four results:

► **Theorem 1.6.** *Assuming the SETH, the following lower bounds hold:*

- *DOMINATING SET cannot be solved in time $\mathcal{O}^*((4 - \varepsilon)^{\text{tc-ctw}(G)})$ for any $\varepsilon > 0$.*
- *TOTAL DOMINATING SET cannot be solved in time $\mathcal{O}^*((4 - \varepsilon)^{\text{ctw}(G)})$ for any $\varepsilon > 0$.*
- *MAXIMUM CUT cannot be solved in time $\mathcal{O}^*((2 - \varepsilon)^{|X|})$ for any $\varepsilon > 0$, where X is a modulator to treewidth at most 2.*
- *K_r -FREE DELETION cannot be solved in time $\mathcal{O}^*((2 - \varepsilon)^{|X|})$ for any $\varepsilon > 0$ and $r \geq 3$, where X is a modulator to treewidth at most $r - 1$.*

The first result improves the parameterization of the tight lower bound for DOMINATING SET obtained by Katsikarelis et al. [41] from linear-clique-width to twinclass-cutwidth. We prove this by reducing TOTAL DOMINATING SET parameterized by cutwidth to DOMINATING SET parameterized by twinclass-cutwidth and providing a lower bound construction for TOTAL DOMINATING SET parameterized by cutwidth.

Lastly, the lower bound for VERTEX COVER, Theorem 1.2, also implies tight lower bounds for MAXIMUM CUT and K_r -FREE DELETION, which again imply the same lower bounds

⁴ Jacob et al. [37] have simultaneously proven this upper and lower bound for the special case of ODD CYCLE TRANSVERSAL, $r = 2$, parameterized by clique-width. Their construction also proves the lower bound for linear-clique-width, but not for the more restrictive twinclass-treewidth or twinclass-modulator like our construction.

parameterized by treedepth. The former also partially answers a question of Jaffke and Jansen [38], by being another problem considered by Lokshtanov et al. [46] whose running time cannot be improved when parameterizing by treedepth instead of treewidth.

Technical contribution. We start by recalling the standard approach of Lokshtanov et al. [46] to proving tight lower bounds for problems parameterized by pathwidth at a high level. Given a SATISFIABILITY instance σ , the variables are partitioned into t groups of constant size. For each variable group, a *group gadget* is constructed that can encode all assignments of this variable group into partial solutions of the considered target problem. The group gadget usually consists of a bundle of long path-like gadgets inducing a sequence of *disjoint* separators. Further gadgets attached to these separators decode the partial solutions and check whether the corresponding assignment satisfies some clause. Ideally, the path gadgets are designed so that a partial solution transitions through a well-defined sequence of states when viewed at consecutive separators. For most problems, the gadgets do not behave this nicely though. For example, in ODD CYCLE TRANSVERSAL it is locally always preferable to delete a vertex instead of not deleting it. Such behavior leads to undesired state changes called *cheats*, but for appropriate path gadgets there can only be a constant number of cheats on each path. By making the path gadgets long enough, one can then find a region containing no cheats where we can safely decode the partial solutions.

For problems such as r -COLORING, all states are equally constraining and such cheats do not occur, hence enabling us to prove the same lower bounds under more restrictive parameters such as feedback vertex set. But for *vertex deletion problems*, like ODD CYCLE TRANSVERSAL, these cheats do occur and pose a big issue when trying to compress the path gadgets into a single separator X , since deletions in X are highly favorable. On a single separator X such behavior means that one partial solution is *dominating* another and if we cannot control this behavior, then we lose the dominated partial solution for the purpose of encoding group assignments. Concretely, for ODD CYCLE TRANSVERSAL we obtain dominating partial solutions by deleting further vertices in the single separator X . The number of deletions is bounded from above by the *budget constraint*, but if we limit the number of deletions in X , then we do not have $3^{|X|}$ partial solutions anymore and the construction may not be able to attain the desired base in the running time.

To resolve this issue we expand upon a technique of Cygan et al. [11] and construct an instance with a slightly large parameter value, i.e., a slightly larger single separator X . Thus, we can limit the number of deletions and are still able to encode sufficiently many group assignments. More precisely, we consider only partial solutions with the same number of deletions in X , hence only pairwise non-dominating partial solutions remain. We construct a *structure gadget* to enforce a lower bound on the number of deletions in X . A positive side effect is that the remaining gadgets can also leverage the structure of the partial solutions.

In the dense setting and especially for a higher number r of colors, this issue is amplified. Here, we consider the states of twinclasses, instead of single vertices, in a partial solution. For a twinclass, there is a hierarchy of dominating states: any state that does not delete all vertices in the twinclass is dominated by a state that deletes further vertices in the twinclass. For DELETION TO r -COLORABLE, the maximum number of states is achieved on a true twinclass of size r and we can partition the states into *levels* based on the number of deletions they induce. Within each level, the states are pairwise non-dominating. Consequently, we restrict the family of partial solutions so that for every level the number of twinclasses with that level is fixed. This requires a considerably more involved construction of the structure gadget which now has to distinguish states based on their level.

Related work. There is a long line of work relative to treewidth [3, 9, 13, 14, 17, 18, 19, 23, 42, 46, 48, 49, 52, 53] and all of these lower bounds, except for the result by Egri et al. [19], already apply to pathwidth. In the sparse setting, there is further work on the parameterization by *cutwidth* [10, 29, 40, 48, 55, 57] and by feedback vertex set [46, 55]. We remark that the works of van Geffen et al. [57] and Piecyk and Rzażewski [55] show that previous lower bounds relative to pathwidth already hold for more restrictive parameterizations. In the dense setting, there are some results [35, 37, 41, 45] on parameterization by clique-width and these lower bounds already apply to linear-clique-width, but not to the more restrictive parameters considered here. The work by Iwata and Yoshida [35] also provides equivalences between different lower bounds and works under a weaker assumption than SETH, unfortunately their techniques blow up the modulator too much and are not applicable in our case. Finally, the complexity of r -COLORING and the more general homomorphism problems has been extensively studied [19, 23, 26, 38, 45, 52, 53, 55], with only two of these articles [26, 45] consider the dense setting. Jaffke and Jansen [38] closely study the complexity of r -COLORING parameterized by the deletion distance to various graph classes \mathcal{F} ; in particular, the base for treewidth can already be explained by deletion distance to a single path.

On the algorithmic side, the study of heterogeneous parameterizations has been gaining traction [4, 5, 20, 21, 22, 32, 39], yielding the notions of \mathcal{H} -treewidth and \mathcal{H} -elimination distance, which is a generalization of treedepth. Currently, only few of these works [20, 39] contain algorithmic results that are sufficiently optimized to apply to our fine-grained setting. Jansen et al. [39] show that VERTEX COVER can be solved in time $\mathcal{O}^*(2^k)$ and ODD CYCLE TRANSVERSAL in time $\mathcal{O}^*(3^k)$ when parameterized by bipartite-treewidth. Eiben et al. [20] show that MAXIMUM CUT can be solved in time $\mathcal{O}^*(2^k)$ when parameterized by \mathcal{R}_w -treewidth, where \mathcal{R}_w denotes the graphs of *rank-width* at most w .

Another line of work is on depth-parameters in the dense setting [6, 15, 24, 25, 27, 31, 43] such as *shrub-depth* and *sc-depth*. The algorithmic results relative to these parameters are largely concerned with meta-results so far [6, 27] and their relation to clique-width is not strong enough to preserve the complexity in our fine-grained setting.

Organization. We discuss the preliminaries and basic notation in Section 2. In Section 3, we give an outline of our two main results: the lower bound for DELETION TO r -COLORABLE in the sparse setting and the dense setting. The relationships between the considered parameters are discussed in Section 4. The algorithm for DELETION TO r -COLORABLE parameterized by clique-width is given in Section 5. Section 6 contains the detailed proofs of the main results. In Section 7 and Section 8 we present the additional results, i.e., the lower bounds for VERTEX COVER and DOMINATING SET. We conclude in Section 9. Appendix A contains the formal definitions of the considered problems.

2 Preliminaries

For a positive integer n , we define $[n] = \{1, \dots, n\}$. For a set S , we define the *power set* $\mathcal{P}(S) = \{T \subseteq S\}$ and for $0 \leq k \leq |S|$, we define $\binom{S}{k} = \{T \subseteq S : |T| = k\}$ and $\binom{S}{\leq k} = \{T \subseteq S : |T| \leq k\}$ and $\binom{S}{\geq k}$ analogously. For $0 \leq k \leq n$, we define $\binom{n}{\leq k} = |\binom{[n]}{\leq k}|$ and similarly $\binom{n}{\geq k}$. For a set family \mathcal{S} , we define $\bigcup(\mathcal{S}) = \bigcup_{S \in \mathcal{S}} S$. For a function $f: A \rightarrow C$ and subset $B \subseteq A$, we denote by $f|_B$ the *restriction* of f to B . For two functions $f, g: A \rightarrow B$, we write $f \equiv g$ if $f(a) = g(a)$ for all $a \in A$. For a boolean predicate p , we let $[p]$ denote the *Iverson bracket* of p , which is 1 if p is true and 0 if p is false.

We use common graph-theoretic notation and assume that the reader knows the essentials

of parameterized complexity. Let $G = (V, E)$ be an undirected graph. For a vertex set $X \subseteq V$, we denote by $G[X]$ the subgraph of G that is induced by X . The *open neighborhood* of a vertex v is given by $N(v) = \{u \in V : \{u, v\} \in E\}$, whereas the *closed neighborhood* is given by $N[v] = N(v) \cup \{v\}$. For sets $X \subseteq V$ we define $N[X] = \bigcup_{v \in X} N[v]$ and $N(X) = N[X] \setminus X$. For two disjoint vertex subsets $A, B \subseteq V$, adding a *join* between A and B means adding all edges between A and B . For a vertex set $X \subseteq V$, we define $\delta(X) = \{\{x, y\} \in E : x \in X, y \notin X\}$.

An r -*coloring* of a graph $G = (V, E)$ is a function $\varphi: V \rightarrow [r]$ such that $\varphi(u) \neq \varphi(v)$ for all $\{u, v\} \in E$. We say that G is r -*colorable* if there is an r -coloring of G . The *chromatic number* of G , denoted by $\chi(G)$, is the minimum r such that G is r -colorable.

Quotients and twins. Let Π be a partition of $V(G)$. The *quotient graph* G/Π is given by $V(G/\Pi) = \Pi$ and $E(G/\Pi) = \{\{B_1, B_2\} : \exists u \in B_1, v \in B_2 : \{u, v\} \in E(G)\}$. We say that two vertices u, v are *twins* if $N(u) \setminus \{v\} = N(v) \setminus \{u\}$. The equivalence classes of this relation are called *twinclasses*. More specifically, if $N(u) = N(v)$, then u and v are *false twins* and if $N[u] = N[v]$, then u and v are *true twins*. Every twinclass of size at least 2 consists of only false twins or only true twins. A false twinclass induces an independent set and a true twinclass induces a clique. Let $\Pi_{tc}(G)$ be the partition of $V(G)$ into twinclasses.

2.1 Graph Parameters

► **Definition 2.1.** A *tree/path decomposition* of a graph G consists of a tree/path \mathcal{T} and bags $\mathbb{B}_t \subseteq V(G)$ for all $t \in V(\mathcal{T})$, such that:

- $V(G) = \bigcup_{t \in V(\mathcal{T})} \mathbb{B}_t$.
- For every edge $\{u, v\} \in E(G)$, there is a node $t \in V(\mathcal{T})$ such that $\{u, v\} \subseteq \mathbb{B}_t$.
- For every $v \in V(G)$, the set $\{t \in V(\mathcal{T}) : v \in \mathbb{B}_t\}$ induces a connected subgraph of \mathcal{T} .

The *width* of a tree/path decomposition is equal to $\max_{t \in V(\mathcal{T})} |\mathbb{B}_t| - 1$. The *treewidth* of G , denoted $\text{tw}(G)$, is the minimum possible width of a tree decomposition of G . The *pathwidth* of G , denoted $\text{pw}(G)$, is the minimum possible width of a path decomposition of G .

Clique-Expressions and Clique-Width.

A *labeled graph* is a graph $G = (V, E)$ together with a *label function* $\text{lab}: V \rightarrow \mathbb{N} = \{1, 2, 3, \dots\}$. We say that a labeled graph is k -*labeled* if $\text{lab}(v) \leq k$ for all $v \in V$. We consider the following four operations on labeled graphs:

- the *introduce*-operation $\ell(v)$ which constructs a single-vertex graph whose unique vertex v has label ℓ ,
- the *union*-operation $G_1 \cup G_2$ which constructs the disjoint union of two labeled graphs G_1 and G_2 ,
- the *relabel*-operation $\rho_{i \rightarrow j}(G)$ changes the label of all vertices in G with label i to label j ,
- the *join*-operation $\eta_{i,j}(G)$, $i \neq j$, which adds an edge between every vertex in G with label i and every vertex in G with label j .

A valid expression that only consists of introduce-, union-, relabel-, and join-operations is called a *clique-expression*. The graph constructed by a clique-expression μ is denoted G_μ and the constructed label function is denoted $\text{lab}_\mu: V(G_\mu) \rightarrow \mathbb{N}$.

We associate to a clique-expression μ the syntax tree \mathcal{T}_μ in the natural way and to each node $t \in V(\mathcal{T}_\mu)$ the corresponding operation. For any node $t \in V(\mathcal{T}_\mu)$ the subtree rooted at t induces a *subexpression* μ_t . When a clique-expression μ is fixed, we define $G_t = G_{\mu_t}$, $V_t = V(G_t)$, and $\text{lab}_t = \text{lab}_{\mu_t}$ for any $v \in V(\mathcal{T}_\mu)$. Furthermore, we write $V_t^\ell = \text{lab}_t^{-1}(\ell)$ for the set of all vertices with label ℓ at node t .

We say that a clique-expression μ is a *k-clique-expression* or just *k-expression* if G_t is k -labeled for all $t \in V(\mathcal{T}_\mu)$. The *clique-width* of a graph G , denoted by $\text{cw}(G)$, is the minimum k such that there exists a k -expression μ with $G = G_\mu$. A clique-expression μ is *linear* if in every union-operation the second graph consists only of a single vertex. Accordingly, we also define the *linear-clique-width* of a graph G , denoted $\text{lin-cw}(G)$, by only considering linear clique-expressions.

Treewidth and Modulators.

We will construct graphs that have small treewidth except for one central part. This structure is captured by the concept of a (*vertex*) *modulator*. We say that $X \subseteq V(G)$ is a *modulator to treewidth/pathwidth r* for G if $\text{tw}(G - X) \leq r$ or $\text{pw}(G - X) \leq r$, respectively.

► **Definition 2.2.** An *elimination forest* of an undirected graph $G = (V, E)$ is a rooted forest $\mathcal{T} = (V, E_{\mathcal{T}})$ so that for every edge $\{u, v\} \in E$ either u is an ancestor or descendant of v in \mathcal{T} . The *depth* of a rooted forest is the largest number of nodes on a path from a root to a leaf. The *treewidth* of G , denoted $\text{td}(G)$, is the minimum depth over all elimination forests of G .

Cutwidth.

A *linear layout* of a graph $G = (V, E)$ with n vertices is a linear ordering of its vertices given by a bijection $\pi: V \rightarrow [n]$. The *cutwidth* of G with respect to π is

$$\text{ctw}_\pi(G) = \max_{i \in [n]} |\{\{u, v\} \in E : \pi(u) \leq i \wedge \pi(v) > i\}|.$$

The *cutwidth* $\text{ctw}(G)$ of G is the minimum cutwidth over all linear layouts of G .

Lifting to Twinclasses.

We define the *twinclass-treewidth*, *twinclass-pathwidth*, *twinclass-treewidth*, and *twinclass-cutwidth* of G by $\text{tc-tw}(G) = \text{tw}(G/\Pi_{\text{tc}}(G))$, $\text{tc-pw}(G) = \text{pw}(G/\Pi_{\text{tc}}(G))$, $\text{tc-td}(G) = \text{td}(G/\Pi_{\text{tc}}(G))$, and $\text{tc-ctw}(G) = \text{ctw}(G/\Pi_{\text{tc}}(G))$, respectively. The parameters twinclass-treewidth and twinclass-pathwidth have been considered before under the name modular treewidth and modular pathwidth [45, 50, 54]. We prefer to use the prefix twinclass instead of modular to distinguish from the case where one works with the quotient graph arising from the *modular partition* of G .

► **Definition 2.3.** Let $G = (V, E)$ be a graph. A *twinclass-modulator (TCM)* $\mathcal{X} \subseteq \Pi_{\text{tc}}(G)$ of G to treewidth r is a set of twinclasses of G such that $\text{tw}(G - \bigcup(\mathcal{X})) \leq r$. The *size* of a twinclass-modulator \mathcal{X} is $|\mathcal{X}|$, i.e., the number of twinclasses \mathcal{X} contains.

2.2 Strong Exponential-Time Hypothesis

For our lower bounds, we assume the *Strong Exponential-Time Hypothesis* (SETH) [34] which concerns the complexity of q -SATISFIABILITY, i.e., SATISFIABILITY where all clauses contain at most q literals. Let $c_q = \inf\{\delta : q\text{-SATISFIABILITY can be solved in time } \mathcal{O}(2^{\delta n})\}$ for all $q \geq 3$. The weaker *Exponential-Time Hypothesis* (ETH) of Impagliazzo and Paturi [33] posits that $c_3 > 0$, whereas the Strong Exponential-Time Hypothesis states that $\lim_{q \rightarrow \infty} c_q = 1$, i.e., for large enough clause size there is essentially no better algorithm than brute force.

When proving lower bounds based on SETH, we make use of the following equivalent formulations.

► **Theorem 2.4** ([11]). *The following statements are equivalent to SETH:*

1. *For all $\delta < 1$, there is a clause size q such that q -SATISFIABILITY cannot be solved in time $\mathcal{O}(2^{\delta n})$, where n is the number of variables.*
2. *For all $\delta < 1$, there is a set size q such that q -HITTING SET, i.e., all sets contain at most q elements, cannot be solved in time $\mathcal{O}(2^{\delta n})$, where n is the universe size.*

3 Outline of Main Result

We outline our two main results, i.e., tight lower bounds for DELETION TO r -COLORABLE parameterized by a (twinclass-)modulator to treewidth r . Conceptually, the constructions for the sparse setting and for the dense setting are similar. The most significant change is in the *structure gadget*, since we have to enforce a considerably more involved structure in the dense setting. We give an overview of both settings and go into more detail for the dense case.

We fix the number of colors $r \geq 2$. *Solutions* are functions $\varphi: V(G) \rightarrow [r] \cup \{\perp\}$ so that for every edge $\{u, v\} \in E(G)$ either $\varphi(u) = \varphi(v) = \perp$ or $\varphi(u) \neq \varphi(v)$. Hence, $\varphi^{-1}(\perp)$ is the set of deleted vertices, whereas $\varphi|_{V(G) \setminus \varphi^{-1}(\perp)}$ is an r -coloring of the remaining graph.

In both settings we want to simulate a *logical OR* constraint. For ODD CYCLE TRANSVERSAL, i.e. $r = 2$, we can use *odd cycles*. For $r \geq 3$, Theorem 3.1 provides an analogue, where a graph H is $(r + 1)$ -critical if $\chi(H) = r + 1$ and $\chi(H - v) = r$ for all $v \in V(H)$.

► **Theorem 3.1** (see Section 6.1). *There exists a family \mathcal{H}^r of $(r + 1)$ -critical graphs with treewidth r such that for every $s \in \mathbb{N}$, there exists a graph $H \in \mathcal{H}^r$ with $s \leq |V(H)| \leq s + r$.*

Setup. Given a q -SATISFIABILITY instance σ with n variables and m clauses, we start with the following standard step [46]: we partition the variables into $t = \lceil n/p_0 \rceil$ groups of size p_0 , where p_0 only depends on the running time base that we want to rule out. Furthermore, we pick an integer p depending on p_0 that represents the size of the groups in the graph.

3.1 Sparse Setting

Central vertices and solution structure. We construct a graph G that has a solution φ for DELETION TO r -COLORABLE with cost $|\varphi^{-1}(\perp)| \leq b$ if and only if σ is satisfiable. Converting from base $r + 1$ to base 2 implies that G should admit a modulator X to treewidth r of size roughly $n \log_{r+1}(2)$. Like Cygan et al. [11], we make the modulator slightly larger, thus picking a larger p . The modulator X consists of $t + 1$ vertex groups: the first t groups U_i , $i \in [t]$, are independent sets of size p each and correspond to the variable groups; the last group F is a clique of size r which simulates LIST COLORING constraints.

On each group U_i , we consider the set of partial solutions $\Phi_i = \{\varphi: U_i \rightarrow [r] \cup \{\perp\} : |\varphi^{-1}(\perp)| = p/(r + 1)\}$. By picking p large enough, Φ_i is sufficiently large to encode all assignments of the i -th variable group. Defining Φ_i in this way achieves two things: first, the solutions in Φ_i are pairwise non-dominating; secondly, this fixes the budget used on the modulator. The second point is important, because by also fixing the budget on the remaining graph via a vertex-disjoint packing \mathcal{P} of $(r + 1)$ -critical graphs, no vertex of F can be deleted, which allows us to simulate LIST COLORING constraints with the clique F .

Structure gadgets. The next step is to enforce that only the solutions in Φ_i can be attained on group U_i . By choosing the budget b appropriately, we obtain an upper bound on the number of deletions in U_i . To obtain a lower bound, we construct the *structure gadgets*. These are built by combining $(r + 1)$ -critical graphs with the *arrow gadget* of Lokshantov et

al. [46]. A (thin) arrow simply propagates a deletion from a vertex u to another vertex v ; else if u is not deleted, then v is not deleted and the arrow does not affect the remaining graph.

The structure gadget works as follows: if φ deletes less than $p/(r+1)$ vertices in group U_i , then there is a subset $S \subseteq U_i$ of size $|S| = (|U_i| - p/(r+1)) + 1$ that avoids all deletions in U_i . For every subset of this size, G contains a $(r+1)$ -critical graph $L_{i,S}$ with an arrow from every $u \in S$ to a private vertex v in $L_{i,S}$, hence simulating an OR on the vertices in S . Since S avoids all deletions of φ , no deletion is propagated to $L_{i,S}$ and φ must pay extra to resolve $L_{i,S}$. By copying each $L_{i,S}$ sufficiently often, we can ensure that the existence of a deletion-avoiding S implies that φ must exceed our budget constraint.

Decode and verify. The remaining construction decodes the partial solution on the modulator X and verifies if the corresponding truth assignment satisfies all clauses of σ . One could generalize the gadgets of Lokshtanov et al. [46] to higher r , but this leads to an involved construction with a worse bound on the treewidth of the remainder: for ODD CYCLE TRANSVERSAL the construction of Lokshtanov et al. has treewidth 4, whereas the simpler construction we use has only treewidth 2. More details will be presented in the dense case.

3.2 Dense Setting

We now have a twinclass-modulator \mathcal{X} to treewidth r instead of a basic modulator and this changes the possible states as follows. Whereas φ could assume $r+1$ different states on a single vertex u , i.e., one of the r colors or deleting the vertex, there are 2^r possible states on a true twinclass U of size r ; each corresponds to a possible value of $\varphi(U) \setminus \{\perp\} \subseteq [r]$. Since U is a true twinclass, no color is used multiple times and the exact mapping $\varphi|_U$ is irrelevant.

Central twinclasses and setup. The twinclass-modulator \mathcal{X} of the constructed graph G consists of $t+1$ groups and each group is a family of twinclasses. The first t groups \mathcal{U}_i , $i \in [t]$, correspond to the variable groups and each consists of p true twinclasses of size r that are pairwise non-adjacent. The last group contains the clique F .

Solution structure. Our family Φ_i of considered partial solutions on group \mathcal{U}_i should achieve the same two things as before. First, consider the structure of states of φ on a twinclass $U \in \mathcal{U}_i$ precisely: fix a state $C = \varphi(U) \setminus \{\perp\}$ and note that all states $C' \subsetneq C$ *dominate* C if we disregard the budget constraint, i.e., φ remains a solution if we replace C by C' . After arranging the states into *levels* according to the number ℓ of deleted vertices, there is no domination between states on the same level. This motivates the following definition.

► **Definition 3.2 (informal).** Given rationals $0 < c_\ell < 1$, $\ell \in \{0\} \cup [r]$, with $\sum_{\ell=0}^r c_\ell = 1$, the set Φ_i consists of solutions φ on the family of twinclasses \mathcal{U}_i such that for every $\ell \in \{0\} \cup [r]$ there are exactly $c_\ell \cdot |\mathcal{U}_i|$ twinclasses $U \in \mathcal{U}_i$ where φ deletes exactly ℓ vertices in U .

Essentially, we are only restricting how the deletions can be distributed inside the modulator; there are no restrictions on the used colors. This again fixes the budget used on the modulator, allowing us to simulate LIST COLORING constraints with the clique F . By picking $c_\ell = \binom{r}{\ell} 2^{-r}$, $\ell \in \{0\} \cup [r]$, we ensure that Φ_i contains the solutions on \mathcal{U}_i where all 2^r states appear the same number of times. This enables us to choose p small enough so that the time calculations work out and simultaneously large enough so that an injective mapping $\kappa_i: \{0, 1\}^{p_0} \rightarrow \Phi_i$, mapping truth assignments of the i -th variable group to solutions in Φ_i , exists.

Thick arrows and structure gadgets. To enforce the structure of Φ_i , we need a gadget to distinguish different number of deletions inside a twinclass. We can construct such a gadget $A_\ell(U, v)$, $\ell \in [r]$, also called *thick ℓ -arrow*. See Lemma 3.3 for the gadget's behavior.

► **Lemma 3.3** (informal). *Let U be a set of r true twins and v be a vertex that is not adjacent to U and $\ell \in [r]$. There is a gadget $A = A_\ell(U, v)$ of treewidth r with the following properties:*

- *Any solution φ must delete at least ℓ vertices in $A - U$.*
- *If a solution φ deletes exactly ℓ vertices in $A - U$, then φ can only delete v if φ deletes at least ℓ vertices in U .*

We proceed by constructing the *structure gadgets* which enforce that the partial solution on \mathcal{U}_i belongs to Φ_i . Let $c_{<\ell} = c_0 + \dots + c_{\ell-1}$ for all $\ell \in \{0\} \cup [r]$. For every group $i \in [t]$, number of deletions $\ell \in [r]$, set of twinclasses $\mathcal{S} \subseteq \mathcal{U}_i$ with $|\mathcal{S}| = c_{<\ell} \cdot p + 1$, we add an $(r+1)$ -critical graph $L_{i,\ell,\mathcal{S}} \in \mathcal{H}^r$ consisting of at least $|\mathcal{S}|$ vertices. For every $U \in \mathcal{S}$, we pick a private vertex v in $L_{i,\ell,\mathcal{S}}$ and add the thick ℓ -arrow $A_\ell(U, v)$. We create a large number of copies of each $L_{i,\ell,\mathcal{S}}$ and the incident thick arrows. This concludes the construction of the structure gadget.

The number of deletions in the central vertices is already bounded from above by the budget constraint. If too few deletions occur in the twinclasses of \mathcal{U}_i , then we can find an ℓ and an $\mathcal{S} \subseteq \mathcal{U}_i$ with $|\mathcal{S}| = c_{<\ell} \cdot p + 1$ such that less than ℓ vertices are deleted in each $U \in \mathcal{S}$. Hence, all thick ℓ -arrows leading to $L_{i,\ell,\mathcal{S}}$ and its copies cannot propagate deletions. To resolve all these $(r+1)$ -critical graphs, one extra vertex per copy must be deleted. Due to the large number of copies, this implies that we must violate our budget constraint.

Hence, for any $\mathcal{S} \subseteq \mathcal{U}_i$ with $|\mathcal{S}| = c_{<\ell} \cdot p + 1$ and any solution φ obeying the budget constraint there is at least one twinclass $U \in \mathcal{S}$ in which φ deletes at least ℓ vertices. Therefore, there are at least $(1 - c_{<\ell})p$ twinclasses in \mathcal{U}_i where φ deletes at least ℓ vertices. Since this holds for all $\ell \in \{0\} \cup [r]$ and the budget b is chosen appropriately, all inequalities have to be tight and the deletions inside \mathcal{U}_i follow the distribution imposed by Φ_i . The upcoming decoding gadgets will make use of this structure.

Color-set-gadgets and decoding gadgets. Next, we discuss the decoding part of the construction. Since gadgets cannot read the color of single vertices but only of a whole twinclass, we need *color-set-gadgets* to detect the colors used on a twinclass, cf. Lemma 3.4.

► **Lemma 3.4** (informal). *Let U be a set consisting of r true twins and v be a vertex that is not adjacent to U and let $C \subsetneq [r]$. There is a gadget $B = B_C(U, v)$ of treewidth r such that:*

- *Any solution φ deletes at least $(r - |C|) + 1$ vertices in $B - U$.*
- *If φ deletes exactly $(r - |C|) + 1$ vertices in $B - U$, then $\varphi(v) = \perp$ only if $\varphi(U) \setminus \{\perp\} \subseteq C$.*

To construct the color-set-gadgets we rely on the LIST COLORING constraints that are simulated with the central clique F . Note that the color-set-gadgets only check for set inclusion and not set equality. Using the structure of solutions in Φ_i however, the color-set-gadgets will still be sufficient to distinguish the solutions in Φ_i from each other.

By using a complete $(r+1)$ -partite graph with all sets of the partition being singletons except for one large independent set, we can simulate a logical AND, see Lemma 3.5.

► **Lemma 3.5** (informal). *Let n_Y be a positive integer. There is a gadget Y of treewidth r with a set of input vertices $V' \subseteq V(Y)$, $|V'| = n_Y$, and a vertex $\hat{y} \in V(Y) \setminus V'$ such that:*

- *Any solution φ has to delete at least one vertex in $Y - V'$.*
- *If φ deletes exactly one vertex in $Y - V'$, then $\varphi(\hat{y}) = \perp$ only if $\varphi(V') = \{\perp\}$.*

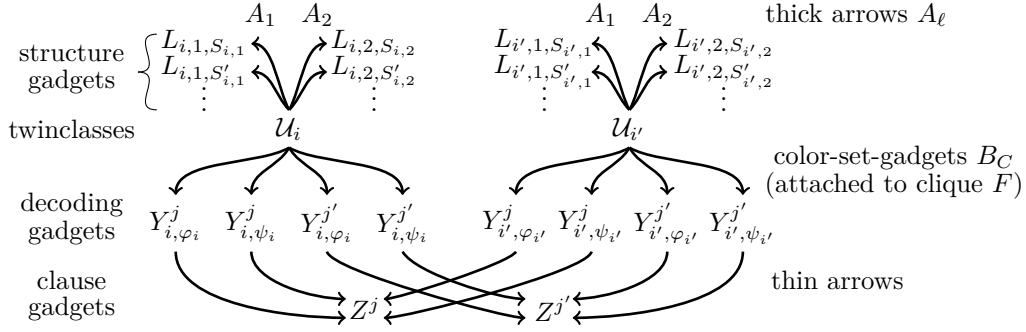

■ **Figure 1** An overview of the construction for the dense setting in case of $r = 2$. The arrows point in the direction that deletions are propagated by the corresponding gadget.

For the j -th clause, variable group $i \in [t]$, solution $\varphi_i \in \Phi_i$, we invoke Lemma 3.5 to create a gadget Y_{i, φ_i}^j for $n_Y = (1 - c_r)p = (1 - 2^{-r})p$ input vertices and with distinguished vertex \hat{y}_{i, φ_i}^j . For every twinclass $U \in \mathcal{U}_i$ with $\varphi_i(U) \neq [r]$, we pick a private input vertex v of Y_{i, φ_i}^j and add the color-set-gadget $B_{\varphi_i(U) \setminus \{\perp\}}(U, v)$. By Lemma 3.5, the vertex \hat{y}_{i, φ_i}^j can only be deleted if all input vertices of Y_{i, φ_i}^j are deleted. Due to Lemma 3.4 and the structure of Φ_i , this will only be the case if φ_i is the partial solution on \mathcal{U}_i .

Clause gadgets. For the j -th clause, we add an $(r + 1)$ -critical graph $Z^j \in \mathcal{H}^r$ consisting of at least $q2^{p_0}$ vertices. For every group $i \in [t]$ and solution $\varphi_i \in \Phi_i$ such that $\kappa_i^{-1}(\varphi_i)$ is a partial truth assignment satisfying the j -th clause, we pick a private vertex v in Z^j and add a thin arrow from \hat{y}_{i, φ_i}^j to v . The budget constraint will ensure that the only way to delete a vertex in Z^j is by propagating a deletion via a thin arrow from some \hat{y}_{i, φ_i}^j . By construction of the decoding and clause gadgets this is only possible if the partial solution on \mathcal{U}_i corresponds to a satisfying assignment of the j -th clause. This concludes the construction, cf. Figure 1.

Budget and packing. The budget $b = b_0 + \text{cost}_{\mathcal{P}}$ of the constructed instance (G, b) consists of two parts; $b_0 = trp/2$ is allocated to the central twinclasses and matches the number of deletions incurred by picking a partial solution $\varphi_i \in \Phi_i$ on \mathcal{U}_i for each group $i \in [t]$; the second part $\text{cost}_{\mathcal{P}}$ is due to a vertex-disjoint packing \mathcal{P} which we describe next. A part of each thin arrow in G is added to \mathcal{P} and for every thick arrow, color-set-gadget, or decoding gadget, we add the appropriate parts to \mathcal{P} given by Lemmas 3.3, 3.4, 3.5, respectively. Summing up the implied costs yields $\text{cost}_{\mathcal{P}}$. Hence, we know how the deletions are distributed throughout the various gadgets. In particular, this ensures that no vertex of the central clique F is deleted.

Theorem 1.4 follows by using these ideas and working out the remaining technical details.

4 Relations between Parameters

We discuss the relationships between the considered parameters and provide an equivalent definition for treewidth via a *search game* in this section.

► **Lemma 4.1** ([1], Chapter 6 of [51]). *For any graph G , we have that $\text{tw}(G) \leq \text{pw}(G) \leq \text{td}(G) - 1$, $\text{td}(G) \leq (\text{tw}(G) + 1) \log_2 |V(G)|$, $\text{tw}(G) \leq \text{pw}(G) \leq \text{ctw}(G)$, and $\text{td}(G) \leq \text{td}(G - v) + 1$ for any vertex $v \in V(G)$. These inequalities come with algorithms that can transform the appropriate decomposition in polynomial time.*

► **Corollary 4.2.** *For any graph $G = (V, E)$ and $c, r \in \mathbb{N}$, if there is a modulator $X \subseteq V$ to treewidth r , i.e., $\text{tw}(G - X) \leq r$, then we have that $\text{td}(G) \leq |X| + (r + 1) \log_2 |V|$. In particular, we have that $\mathcal{O}^*(c^{\text{td}(G)}) \leq \mathcal{O}^*(c^{|X|})$ for all $c \geq 1$. The decompositions can be transformed in polynomial time.*

Proof. Let X be a modulator to treewidth r for G . By Lemma 4.1, we see that $\text{td}(G - X) \leq (r + 1) \log_2 |V|$ for $G - X$. By repeatedly invoking the inequality $\text{td}(G) \leq \text{td}(G - v) + 1$ for $v \in X$, we obtain $\text{td}(G) \leq |X| + (r + 1) \log_2 |V|$. To see the claim regarding the \mathcal{O}^* -notation, we compute $\mathcal{O}^*(c^{\text{td}(G)}) = \mathcal{O}^*(c^{|X|} |V|^{(r+1) \log_2 c}) = \mathcal{O}^*(c^{|X|})$. ◀

► **Theorem 4.3.** *Let $G = (V, E)$ be a graph. We have the following two chains of inequalities:*

$$\begin{aligned} \text{cw}(G) &\leq \text{lin-cw}(G) \leq \text{tc-pw}(G) + 3 \leq \text{tc-td}(G) + 2 \leq \text{td}(G) + 2, \\ \text{cw}(G) &\leq \text{lin-cw}(G) \leq \text{tc-pw}(G) + 3 \leq \text{tc-ctw}(G) + 3 \leq \text{ctw}(G) + 3. \end{aligned}$$

Proof. Follows from [45, Lemma 2.1], Lemma 4.1 and the last inequalities in both rows follow from the fact that $G/\Pi_{\text{tc}}(G)$ is a subgraph of G and that treedepth and cutwidth are subgraph-monotone. ◀

► **Lemma 4.4.** *Suppose that G admits a TCM \mathcal{X} to treewidth r , then $\text{tc-td}(G) \leq |\mathcal{X}| + (r + 1) \log_2 |V(G/\Pi_{\text{tc}}(G))|$. In particular, we have for any $c \geq 1$ that $\mathcal{O}^*(c^{\text{tc-td}(G)}) \leq \mathcal{O}^*(c^{|\mathcal{X}|})$. The decompositions can be transformed in polynomial time.*

Proof. Since $G/\Pi_{\text{tc}}(G) - \mathcal{X}$ is an induced subgraph of $G - \bigcup(\mathcal{X})$, we see that $\text{tw}(G/\Pi_{\text{tc}}(G) - \mathcal{X}) \leq \text{tw}(G - \bigcup(\mathcal{X})) \leq r$. The remainder of the proof is analogous to Corollary 4.2 by working on the quotient graph $G/\Pi_{\text{tc}}(G)$. ◀

Search Games

To prove that the graphs in our lower bound constructions have small treewidth, it is easier to use a *search game* characterization instead of directly constructing a tree decomposition.

Cops and Robbers. The search game corresponding to treewidth is the *omniscient-cops-and-robber-game*. In this game $k + 1$ cops try to capture a robber on a graph G . The cops can occupy vertices of G and the robber can run at infinite speed along edges through vertices that are not occupied by cops. The cops and the robber are omniscient in that they know each others position at all times. At the start, the cops are placed on some vertices and the robber chooses a starting vertex for the escape. In every round some cops get into their helicopters and declare where they will land next. Before these cops land again, the robber may move to any other vertex that is reachable by a path that does not contain any non-airborne cop. Afterwards the cops land and the next round begins. The cops *win* if they have a *strategy* to capture the robber by landing on the robber's location after a finite number of rounds; otherwise the robber wins.

► **Theorem 4.5** ([56]). *A graph G has treewidth at most k if and only if $k + 1$ cops can win the omniscient-cops-and-robber-game on G .*

5 Algorithm for Deletion to r -Colorable

In this section we describe how to solve DELETION TO r -COLORABLE in time $\mathcal{O}^*((2^r)^k)$ given a k -expression μ for G . We perform bottom-up dynamic programming along the syntax tree \mathcal{T}_μ . We again view *solutions* to DELETION TO r -COLORABLE as functions $\varphi: V(G) \rightarrow [r] \cup \{\perp\}$ with the property discussed in the outline, cf. Section 3.

► **Theorem 5.1.** *Given a k -expression μ for G , DELETION TO r -COLORABLE on G can be solved in time $\mathcal{O}^*((2^r)^k)$.*

Proof. Let (G, b) be a DELETION TO r -COLORABLE instance and μ a k -expression for G . We can without loss of generality assume that μ consists of $\mathcal{O}(|V(G)|)$ union-operations and $\mathcal{O}(|V(G)|k^2)$ unary operations [8]. For every node $t \in V(\mathcal{T}_\mu)$ and label ℓ , we store the set of colors used on V_t^ℓ . After deleting the appropriate vertices, the remaining graph should be r -colorable, hence the possible color sets are precisely the subsets of $[r]$, where \emptyset indicates that all vertices are deleted. Since we use at most k labels at every node, this results in $(2^r)^k$ possible types of partial solutions at each node. If the work for each type is only polynomial, then the claimed running time immediately follows, since there are only a polynomial number of nodes in $V(\mathcal{T}_\mu)$.

For every $t \in V(\mathcal{T}_\mu)$, a function $f: [k] \rightarrow \mathcal{P}([r])$ is called a *signature* and the set of *partial solutions at t respecting f* is defined by

$$\mathcal{Q}_t(f) = \{\varphi: V_t \rightarrow [r] \cup \{\perp\} : \varphi \text{ induces an } r\text{-coloring of } G_t - \varphi^{-1}(\perp) \text{ and} \\ \varphi(V_t^\ell) \setminus \{\perp\} = f(\ell) \text{ for all } \ell \in [k]\}.$$

We want to compute the quantity $A_t(f) = \min\{|\varphi^{-1}(\perp)| : \varphi \in \mathcal{Q}_t(f)\}$, where $A_t(f) = \infty$ if $\mathcal{Q}_t(f) = \emptyset$. Let t_0 be the root node of the k -expression μ . The algorithm returns true if there is a t_0 -signature f such that $A_{t_0}(f) \leq b$ and otherwise the algorithm returns false.

Note that $f(\ell) = \emptyset$ implies $\varphi(V_t^\ell) = \{\perp\}$ for all $\varphi \in \mathcal{Q}_t(f)$, i.e., all vertices with label ℓ are deleted. Furthermore, the definition of $\mathcal{Q}_t(f)$ implies that $\mathcal{Q}_t(f) = \emptyset$ and $A_t(f) = \infty$ whenever $|f(\ell)| > |V_t^\ell|$ for some $\ell \in [k]$; we will not explicitly mention this edge case again in what follows and assume that the considered f satisfy $|f(\ell)| \leq |V_t^\ell|$ for all $\ell \in [k]$. We proceed by presenting the recurrences to compute $A_t(f)$ for all nodes t and signatures f and afterwards show the correctness of these recurrences.

Base case.

If $t = \ell(v)$ for some $\ell \in [k]$, then $A_t(f) = [f(\ell) = \emptyset]$, because the solution cost is 1 if v is deleted and 0 otherwise.

Relabel case.

If $t = \rho_{i \rightarrow j}(G_{t'})$ for some $i \neq j \in [k]$ and where t' is the child of t , then

$$A_t(f) = \min\{A_{t'}(f') : f'(\ell) = f(\ell) \text{ for all } \ell \in [k] \setminus \{i, j\} \text{ and } f'(i) \cup f'(j) = f(j)\}.$$

By assumption, f will always satisfy $f(i) = \emptyset$ here, since there are no vertices with label i in G_t . This recurrence goes over all ways how the colors $f(j)$ used for vertices with label j in G_t can be split among the vertices with label i and j in the previous graph $G_{t'}$. Observe that we are taking the minimum over at most $(2^r)^2 = \mathcal{O}(1)$ numbers on the right-hand side, hence this recurrence can be computed in polynomial time.

Join case.

If $t = \eta_{i,j}(G_{t'})$ for some $i \neq j \in [k]$, where t' is the child of t , and assuming without loss of generality that $V_{t'}^i \neq \emptyset$ and $V_{t'}^j \neq \emptyset$, then

$$A_t(f) = \begin{cases} A_{t'}(f) & \text{if } f(i) \cap f(j) = \emptyset, \\ \infty & \text{else.} \end{cases}$$

This recurrence filters out all partial solutions where the coloring properties are not satisfied at some newly added edge. This happens precisely when $f(i) \cap f(j) \neq \emptyset$, because then there exists an edge in the join between label i and j whose endpoints get the same color.

Union case.

If $t = G_{t_1} \cup G_{t_2}$ where t_1 and t_2 are the children of t , then

$$A_t(f) = \min\{A_{t_1}(f_1) + A_{t_2}(f_2) : f_1(\ell) \cup f_2(\ell) = f(\ell) \text{ for all } \ell \in [k]\}.$$

Here, we assume that $\infty + x = x + \infty = \infty + \infty = \infty$ for all $x \in \mathbb{N}$. This recurrence goes for each label $\ell \in [k]$ over all ways how the color set $f(\ell)$ can be split among the vertices with label ℓ in the first graph G_{t_1} and in the second graph G_{t_2} .

To compute this recurrence, we make use of the following fast cover product algorithm.

► **Lemma 5.2** ([12]). *For two functions $f, g: \mathcal{P}(U) \rightarrow \{-M, \dots, M\}$, given all $2^{|U|}$ values of f and g in the input, all the $2^{|U|}$ values of the cover product $f *_c g$ defined by*

$$(f *_c g)(X) = \min_{Y \cup Z = X} f(Y) + g(Z),$$

can be computed in time $2^{|U|}|U|^{\mathcal{O}(1)} \cdot \mathcal{O}(|M| \log |M| \log \log |M|)$.

Lemma 5.2 allows us to compute the recurrence for all f simultaneously in time $\mathcal{O}^*((2^r)^k)$: We interpret the signatures $f: [k] \rightarrow \mathcal{P}([r])$ as subsets of $[k] \times [r]$ in the following way: $S(f) = \{(i, c) : i \in [k], c \in f(i)\}$. Observe that $f_1(\ell) \cup f_2(\ell) = f(\ell)$ for all $\ell \in [k]$ is equivalent to $S(f_1) \cup S(f_2) = S(f)$. Now, A_t can be considered as a function $\mathcal{P}([k] \times [r]) \rightarrow [n+1]$ by replacing ∞ with $n+1$, since we have $A_t(f) \leq n$ whenever $\mathcal{Q}_t(f) \neq \emptyset$. The recurrence of the union case can then be considered as the $(\min, +)$ -cover product of A_{t_1} and A_{t_2} . By Lemma 5.2 with $U = [k] \times [r]$ and $M = n+1$, we can compute all values of A_t in time $2^{kr}(kr)^{\mathcal{O}(1)} \cdot \mathcal{O}(n \log n \log \log n) = \mathcal{O}^*((2^r)^k)$.

Correctness.

We prove the correctness by bottom-up induction along the syntax tree \mathcal{T}_μ . In the base case G_t only consists of the single vertex v and we can either delete v or assign some color to v . Together with the edge case handling, this is implemented by the formula for the base case.

For the relabel case, notice that $G_t = G_{t'}$, $V_t^i = \emptyset$, $V_t^j = V_{t'}^i \cup V_{t'}^j$, and $V_t^\ell = V_{t'}^\ell$ for all $\ell \in [k] \setminus \{i, j\}$. Let f' be a candidate in the recurrence of $A_t(f)$ and $\varphi' \in \mathcal{Q}_{t'}(f')$ be a minimizer in the definition of $A_{t'}(f')$, then we also have that $\varphi' \in \mathcal{Q}_t(f)$ since $\varphi'(V_t^j) \setminus \{\perp\} = (\varphi'(V_{t'}^i) \setminus \{\perp\}) \cup (\varphi'(V_{t'}^j) \setminus \{\perp\}) = f'(i) \cup f'(j) = f(j)$. Hence, the recurrence is an upper bound on $A_t(f)$.

In the other direction, let φ be a minimizer in the definition of $A_t(f)$ and consider f' with $f'(\ell) = \varphi(V_{t'}^\ell) \setminus \{\perp\}$ for all $\ell \in [k]$. Then f' satisfies $f'(i) \cup f'(j) = f(j)$ and $\varphi \in \mathcal{Q}_{t'}(f')$, so f' is also considered in the recurrence and the recurrence is a lower bound on $A_t(f)$.

For the join case, notice that for $\varphi \in \mathcal{Q}_{t'}(f) \supseteq \mathcal{Q}_t(f)$ it holds that $\varphi \in \mathcal{Q}_t(f)$ if and only if $\varphi(V_{t'}^i) \cap \varphi(V_{t'}^j) \subseteq \{\perp\}$ as otherwise φ cannot induce a coloring of $G_t - \varphi^{-1}(\perp)$.

For the union case, a feasible solution φ of G_t induces feasible solutions $\varphi_1 \equiv \varphi|_{V_{t_1}}$ of G_{t_1} and $\varphi_2 \equiv \varphi|_{V_{t_2}}$ of G_{t_2} such that $\varphi_1(V_{t_1}^\ell) \cup \varphi_2(V_{t_2}^\ell) = \varphi(V_t^\ell)$ for all $\ell \in [k]$ and vice versa. ◀

This algorithm has a straightforward extension that can also handle polynomially large vertex costs in running time $\mathcal{O}^*((2^r)^k)$. For even larger costs it is not clear how to compute the table entries for the union nodes quickly enough.

6 Lower Bound for Deletion to r -colorable

In this section, we prove two tight parameterized lower bounds for DELETION TO r -COLORABLE. Compared to the outline, Section 3, we present the lower bounds in reverse order, i.e., we first present the dense setting in Section 6.2 and then the sparse setting in Section 6.3. Since the constructions are so similar, this allows us to give the more complicated proof for the dense setting in full detail, while only discussing the changes needed for the sparse setting. Before presenting the lower bounds, we construct a family of $(r + 1)$ -critical graphs in Section 6.1 that will serve as important gadgets in both lower bound constructions.

6.1 Construction of Critical Graphs

We say that a graph G is t -critical if $\chi(G) = t$ and $\chi(G - v) = t - 1$ for all $v \in V(G)$. The odd cycles form a family of 3-critical graphs of treewidth 2 that contains graphs of arbitrarily large size. To obtain lower bounds for DELETION TO r -COLORABLE with $r > 2$ instead of ODD CYCLE TRANSVERSAL, we instead construct a family of $(r + 1)$ -critical graphs of treewidth r that contains graphs of arbitrarily large size.

► **Theorem 6.1.** *Let $r \geq 2$. There exists a family \mathcal{H}^r of graphs such that*

- H is $(r + 1)$ -critical for all $H \in \mathcal{H}^r$,
- $\text{pw}(H) = \text{tw}(H) = r$ for all $H \in \mathcal{H}^r$,
- for every $s \in \mathbb{N}$, there exists a graph $H \in \mathcal{H}^r$ with $s \leq |V(H)| \leq s + r$.

► **Definition 6.2** ([16, 30]). Given two graphs G and H and edges $\{v, w\} \in E(G)$ and $\{x, y\} \in E(H)$. We obtain a graph $G' = (V', E')$ by applying Hajós' construction, where $V' = (V(G) \cup V(H) \cup \{s\}) \setminus \{v, x\}$ and $E' = E(G - v) \cup E(H - x) \cup \{\{s, u\} : \{v, w\} \neq \{v, u\} \in E(G)\} \cup \{\{s, u\} : \{x, y\} \neq \{x, u\} \in E(H)\} \cup \{w, y\}$. That is, we remove the edges $\{v, w\}$ and $\{x, y\}$, identify v and x into a single vertex called s , and add the edge $\{w, y\}$.

► **Definition 6.3** ([16, 30]). Let $t \geq 3$. A graph $G = (V, E)$ is t -constructible if it can be constructed from the following operations, starting with the complete graph K_t :

- Let G and H be t -constructible graphs, then the graph obtained by applying Hajós' construction to G and H (wrt. edges $\{v, w\} \in E(G)$ and $\{x, y\} \in E(H)$ and identifying v and x) is t -constructible.
- Let G be a t -constructible graph and u and v two non-adjacent vertices in G . The graph formed by adding the edge $\{u, v\}$ to G and then contracting $\{u, v\}$ is t -constructible.

► **Lemma 6.4** ([16, 30]). *Every t -constructible graph G requires at least t colors, i.e. $\chi(G) \geq t$.*

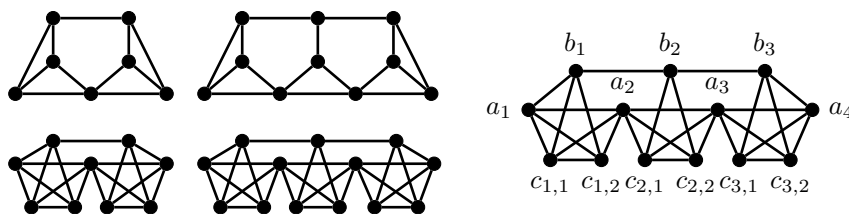

■ **Figure 2** The graphs $H_2^4, H_3^4, H_2^5, H_3^5$ and the vertex labels of H_3^5 .

We set $H_1^t = K_t$ with vertex labels $V(H_1^t) = \{a_1, a'_1, b_1, c_{1,1}, c_{1,2}, \dots, c_{1,t-3}\}$. For $\gamma \geq 2$, we obtain H_γ^t by performing Hajós' construction on $H_{\gamma-1}^t$ and K_t , where we label the vertices of K_t by $a_\gamma, a'_\gamma, b_\gamma, c_{\gamma,1}, c_{\gamma,2}, \dots, c_{\gamma,t-3}$, with respect to the edges $\{b_{\gamma-1}, a'_{\gamma-1}\} \in E(H_{\gamma-1}^t)$

and $\{a_\gamma, b_\gamma\} \in E(K_t)$ and identifying $a'_{\gamma-1}$ with a_γ . Having finished the construction, we will not require the a' -labels anymore, in H_γ^t we set $a_{\gamma+1} = a'_\gamma$, see Figure 2.

We define $\mathcal{H}^{t-1} = \{H_\gamma^t : \gamma \in \mathbb{N}\}$ for $t \geq 3$. Observe that for $t = 3$ we obtain exactly the odd cycles. We establish the following properties of the graphs H_γ^t which directly implies Theorem 6.1.

► **Lemma 6.5.** *The graphs H_γ^t , $t \geq 3$, $\gamma \in \mathbb{N}$, have the following properties:*

1. $|V(H_\gamma^t)| = (t-1)\gamma + 1$.
2. H_γ^t is t -critical.
3. $\text{pw}(H_\gamma^t) = \text{tw}(H_\gamma^t) = t-1$.

Proof. Property 1 can be easily shown by induction over γ . Now, we can prove that H_γ^t is t -critical. By Lemma 6.4 we have that $\chi(H_\gamma^t) \geq t$. Let $v \in V(H_\gamma^t)$ be arbitrary. We have to show that $\chi(H_\gamma^t - v) \leq t-1$. We distinguish whether v is labeled by a , b , or c , see Figure 3.

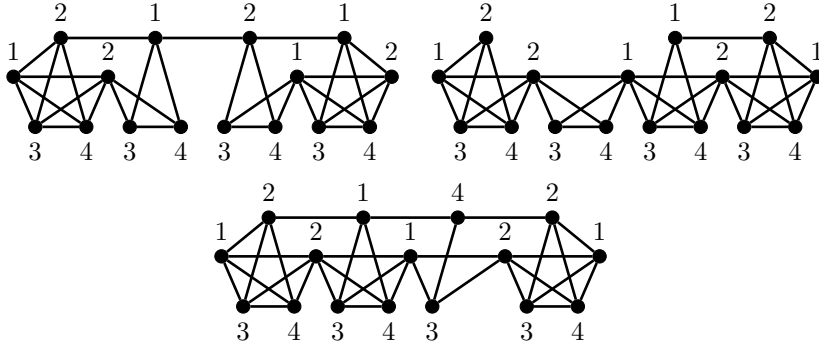

■ **Figure 3** The three coloring cases in the proof of Lemma 6.5 for the graph H_4^5 .

Case $v = a_i$, $i \in [\gamma + 1]$: We construct a proper $(t-1)$ -coloring $\varphi : V(H_\gamma^t - v) \rightarrow [t-1]$. For $\ell \in [\gamma]$, set $\varphi(b_\ell) = (\ell \bmod 2) + 1$. For $\ell \in [\gamma + 1]$, set $\varphi(a_\ell) = (\ell + 1 \bmod 2) + 1$ if $\ell < i$ and set $\varphi(a_\ell) = (\ell \bmod 2) + 1$ if $\ell > i$. For $\ell \in [\gamma]$ and $k \in [t-3]$, set $\varphi(c_{\ell,k}) = k + 2$. Now, for all $\ell \in [\gamma]$, the $(t-1)$ -clique induced by $a_\ell, a_{\ell+1}, c_{\ell,1}, \dots, c_{\ell,t-3}$ is colored properly and the graph induced by $N[b_\ell]$ is colored properly. Since these cover all edges, φ must be a proper coloring.

Case $v = b_i$, $i \in [\gamma]$: Again, we construct a proper $(t-1)$ -coloring φ . For $\ell \in [\gamma]$, set $\varphi(b_\ell) = (\ell \bmod 2) + 1$ if $\ell < i$ and set $\varphi(b_\ell) = (\ell + 1 \bmod 2) + 1$ if $\ell > i$. For $\ell \in [\gamma + 1]$, set $\varphi(a_\ell) = (\ell + 1 \bmod 2) + 1$. For $\ell \in [\gamma]$ and $k \in [t-3]$, set $\varphi(c_{\ell,k}) = k + 2$. Similarly to the previous case, φ must be a proper coloring.

Case $v = c_{i,k}$, $i \in [\gamma]$, $k \in [t-3]$: We construct a proper $(t-1)$ -coloring φ as follows. We set $\varphi(b_i) = k + 2$. For $\ell \in [\gamma] \setminus \{i\}$, set $\varphi(b_\ell) = (\ell \bmod 2) + 1$ if $\ell < i$ and set $\varphi(b_\ell) = (\ell + 1 \bmod 2) + 1$ if $\ell > i$. For $\ell \in [\gamma + 1]$, set $\varphi(a_\ell) = (\ell + 1 \bmod 2) + 1$. For $(\ell, k') \in ([\gamma] \times [t-3]) \setminus \{(i, k)\}$, set $\varphi(c_{\ell,k'}) = k' + 2$. Again, like in the previous cases, φ must be a proper coloring.

This shows that H_γ^t is t -critical. We proceed by showing that $\text{pw}(H_\gamma^t) = \text{tw}(H_\gamma^t) = t-1$. Note that by contracting all vertices in $V(H_\gamma^t) \setminus \{a_1, a_2, b_1, c_{1,1}, \dots, c_{1,t-3}\}$ into b_1 , we obtain K_t and hence $\text{pw}(G) \geq \text{tw}(G) \geq \text{tw}(K_t) = t-1$, as treewidth is a minor-monotone parameter. For the other direction, we construct a path decomposition \mathcal{T} of width $t-1$. Let \mathcal{T} be the path on $2\gamma-1$ vertices denoted by $w_1, \dots, w_{2\gamma-1}$. For $\ell \in [\gamma]$, we define the bag $\mathbb{B}_{w_{2\ell-1}} = \{a_\ell, a_{\ell+1}, b_\ell, c_{\ell,1}, c_{\ell,2}, \dots, c_{\ell,t-3}\}$ and for $\ell \in [\gamma-1]$, we define the bag $\mathbb{B}_{w_{2\ell}} = \{b_\ell, b_{\ell+1}, a_{\ell+1}\}$. This yields a path decomposition of width $t-1$ and hence establishes property 3. ◀

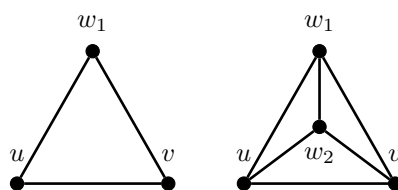

■ **Figure 4** A deletion edge between u and v for $r = 2$ and $r = 3$.

6.2 Dense Setting

We again view *solutions* to DELETION TO r -COLORABLE as functions $\varphi: V(G) \rightarrow [r] \cup \{\perp\}$ satisfying $\varphi(u) = \perp$ or $\varphi(v) = \perp$ or $\varphi(u) \neq \varphi(v)$ for every edge $\{u, v\} \in E(G)$.

We will prove a lower bound for DELETION TO r -COLORABLE parameterized by the size of a twinclass-modulator (TCM) to treewidth r . This implies a lower bound for parameterization by twinclass-treedepth due to Lemma 4.4. By Theorem 4.3, this further extends to lower bounds for parameterization by twinclass-pathwidth and clique-width. Hence, we will see that the running time of the algorithm from Theorem 5.1 is tight, unless SETH is false.

► **Theorem 6.6.** *If DELETION TO r -COLORABLE can be solved in time $\mathcal{O}^*((2^r - \varepsilon)^{|\mathcal{X}|})$ for some $r \geq 2$ and $\varepsilon > 0$, where \mathcal{X} is a TCM to treewidth r , then SETH is false.*

Assume that we can solve DELETION TO r -COLORABLE in time $\mathcal{O}^*((2^r - \varepsilon)^{|\mathcal{X}|})$ for some $r \geq 2$ and $\varepsilon > 0$. For all clause sizes q , we provide a reduction from q -SATISFIABILITY with n variables to DELETION TO r -COLORABLE with a TCM to treewidth r of size approximately $n \log_{2^r}(2) = n/r$ to convert from base 2^r to base 2. Combining this reduction with the assumed faster algorithm will imply a faster algorithm for q -SATISFIABILITY, thus violating SETH. From now on, we consider r to be fixed.

Before we begin with the actual construction, we describe several gadgets that will be important.

Deletion edges. Let u and v be two vertices. By adding a *deletion edge* between u and v , we mean adding $r - 1$ vertices w_1, \dots, w_{r-1} and edges so that $\{u, v, w_1, w_2, \dots, w_{r-1}\}$ is a clique of size $r + 1$, see Figure 4. The vertices w_1, \dots, w_{r-1} will not receive any further incident edges. Therefore, any solution to DELETION TO r -COLORABLE has to delete at least one vertex in this clique and we can assume that the deleted vertex is u or v .

Arrows. Our construction relies on being able to propagate deletions throughout the graph. This is done via so-called *arrows*. We distinguish between two types of arrows, namely *thin arrows* and *thick arrows*. Thin arrows arise already in the sparse setting of the lower bound construction of Lokshtanov et al. [46] for the restricted case of $r = 2$, i.e., ODD CYCLE TRANSVERSAL parameterized by pathwidth. A thin arrow simply propagates a deletion from a single vertex to another vertex. Whereas the newly introduced thick arrows propagate a deletion to a single vertex only if sufficiently many vertices have been deleted in some true twinclass of size r . The construction of thick arrows is described in the proof of Lemma 6.7.

Let us proceed with the construction of thin arrows. Given two single vertices u and v , adding a *thin arrow* from u to v means adding a new vertex w and a deletion edge between u and w and a deletion edge between w and v . We remark that, compared to the construction of Lokshtanov et al. [46], we have shortened the thin arrows. The construction of thin arrows is symmetric, but the direction will be important later for the description of a packing that

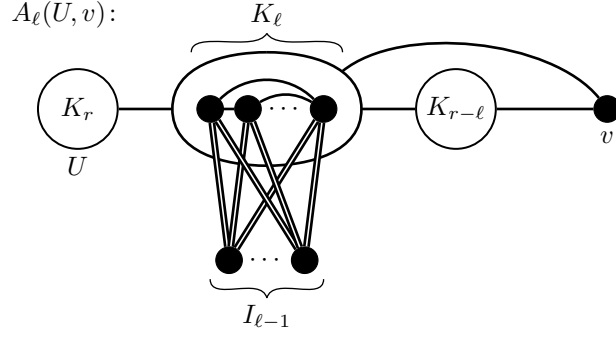

■ **Figure 5** The construction of a thick ℓ -arrow $A_\ell(U, v)$. The double-lined edges represent deletion edges. An edge attached to a circle or ellipse represents a *join*, i.e., a bundle of edges.

witnesses a lower bound on the required budget. The idea is that when u is not deleted, we delete w to resolve both incident deletion edges; when u is deleted, the first deletion edge is resolved and we can afford to delete v to resolve the second deletion edge. The former is called the *passive* solution of the thin arrow and the latter is the *active* solution. Using exchange arguments, one can see that it is sufficient to only consider solutions that on each thin arrow use either the passive solution or active solution.

► **Lemma 6.7.** *Let U be a set of r true twins and v be a vertex that is not adjacent to U and $\ell \in [r]$. There is a graph $A = A_\ell(U, v)$ with the following properties:*

- *Any solution φ satisfies $|V(A - U) \cap \varphi^{-1}(\perp)| \geq \ell$.*
- *If $|V(A - U) \cap \varphi^{-1}(\perp)| = \ell$, then $\varphi(v) = \perp$ implies that $|U \cap \varphi^{-1}(\perp)| \geq \ell$.*
- *Any solution $\tilde{\varphi}$ for $\tilde{G} = G[(V \setminus V(A)) \cup U \cup \{v\}]$ with $\tilde{\varphi}(v) \neq \perp$ or $|U \cap \tilde{\varphi}^{-1}(\perp)| \geq \ell$ can be extended to a solution φ for G with $|V(A - U) \cap \varphi^{-1}(\perp)| = \ell$.*
- *$\text{tw}(A - U) \leq r$ via a winning cops-and-robber-strategy starting with a cop on v .*

Proof. The graph $A = A_\ell(U, v)$ is constructed by adding a clique K_ℓ on ℓ vertices, a clique $K_{r-\ell}$ on $r - \ell$ vertices, an independent set $I_{\ell-1}$ on $\ell - 1$ vertices and adding all edges between U and K_ℓ , all edges between K_ℓ and $K_{r-\ell}$, all edges between K_ℓ and v , all edges between $K_{r-\ell}$ and v , and a deletion edge between each vertex of K_ℓ and each vertex of $I_{\ell-1}$, cf. Figure 5. Observe that the K_ℓ , $K_{r-\ell}$, and v together form a clique of size $r + 1$. Only U and v can have further incident edges.

We first show that any solution φ has to delete at least ℓ vertices in $A - U$. Suppose that no deletion occurs in K_ℓ , then $\ell - 1$ disjoint deletion edges between K_ℓ and $I_{\ell-1}$ remain and at least one deletion has to occur in $K_{r-\ell} \cup \{v\}$. On the other hand, suppose that $1 \leq d \leq \ell$ deletions occur in K_ℓ , then $\ell - d$ disjoint deletion edges between K_ℓ and $I_{\ell-1}$ remain. In either case, we must delete at least ℓ vertices.

Next, we argue that a solution φ deleting exactly ℓ vertices in $A - U$ cannot delete v if less than ℓ deletions occur in U . Suppose that $d < \ell$ deletions occur in U , then at least $\ell - d \geq 1$ deletions must occur in K_ℓ , because U and K_ℓ together form a clique of size $r + \ell$. Let $d' \geq 1$ be the number of deletions in K_ℓ , then like in the previous paragraph $\ell - d'$ disjoint deletion edges between K_ℓ and $I_{\ell-1}$ remain. Hence, we must already perform a total of ℓ deletions in K_ℓ and the deletion edges, so v cannot be deleted.

Consider any solution $\tilde{\varphi}$ for \tilde{G} . If $\tilde{\varphi}(v) \neq \perp$, then we can extend $\tilde{\varphi}$ to a solution φ for G by deleting K_ℓ completely. This deletes all edges between U and A and one endpoint of each deletion edge. The $K_{r-\ell}$ is only attached to v and can always be properly colored. We give

all vertices in $I_{\ell-1}$ the same color and the cliques attached to $I_{\ell-1}$ due to the deletion edges are all disjoint and of size $r-1$ each, so they can be properly colored as well. Hence, φ is a valid solution for G .

If $|U \cap \tilde{\varphi}^{-1}(\perp)| \geq \ell$ and $\tilde{\varphi}(v) = \perp$, then we can extend $\tilde{\varphi}$ to a solution φ for G by deleting $I_{\ell-1}$ completely. To K_ℓ we assign a subset of the colors $[r] \setminus \tilde{\varphi}(U)$, this is possible since at least ℓ deletions occur in U . The K_ℓ and $K_{r-\ell}$ together form a clique of size r that we can properly color. The cliques of the deletion edges are all disjoint as before and only attached to K_ℓ and have size $r-1$ each, hence they can also be properly colored. Hence, φ is a valid solution for G .

Finally, we argue that $\text{tw}(A-U) \leq r$ using the omniscient cops-and-robber-game. We begin by placing $r+1$ cops on $K_\ell \cup K_{r-\ell} \cup \{v\}$, then we remove the $r-\ell+1$ cops on $K_{r-\ell} \cup \{v\}$. Now, all remaining connected components correspond to a vertex of $I_{\ell-1}$. Fix the component the robber escaped to and place one cop on the corresponding vertex of $I_{\ell-1}$. Now, the robber must have escaped to the inside of some deletion edge between K_ℓ and $I_{\ell-1}$. We remove the $\ell-1$ cops from K_ℓ that are not on the endpoint of this deletion edge. Finally, we place $r-1$ cops on the remaining vertices of the deletion edge and capture the robber. Throughout the strategy, we have never placed more than $r+1$ cops simultaneously and hence the claimed treewidth bound holds by Theorem 4.5. \blacktriangleleft

Similarly to the thin arrows, we say that a thick ℓ -arrow $A_\ell(U, v)$ is *active* if the considered solution φ satisfies $|U \cap \varphi^{-1}(\perp)| \geq \ell$ and hence Lemma 6.7 allows us to assume that $\varphi(v) = \perp$; otherwise, we say that $A_\ell(U, v)$ is *passive*.

Construction setup. We will now begin with the construction of the DELETION TO r -COLORABLE instance. Consider a q -SATISFIABILITY instance σ with n variables and m clauses. We enumerate the clauses and simply refer to them by their number. Depending only on ε and r , we will choose an integer p_0 ; we will describe how to choose p_0 later. We partition the variables of σ into groups of size at most p_0 , resulting in $t = \lceil n/p_0 \rceil$ groups which will be indexed by i . Next, we choose the smallest integer p such that p is divisible by 2^r and $(2^r)^p \frac{(2^r-1)!}{2^{(2^r)}} p^{-(2^r)} \geq 2^{p_0}$.

Usually, a simple base conversion from a base that is a power of 2 to base 2 allows for a construction where the handling of groups is a lot less technical. Unfortunately, since we require the trick of Cygan et al. [11] that enlarges the groups, this is not possible here. We will now describe the construction of the DELETION TO r -COLORABLE instance $G = G(\sigma, r, p_0)$.

Central twinclasses. The central vertices of G will form the TCM to treewidth r . For each variable group $i \in [t]$, we create a set $\mathcal{U}_i \subseteq \Pi_{tc}(G)$ consisting of p true twinclasses of size r each; there are no edges between the different twinclasses. The partial solution induced by a solution φ of DELETION TO r -COLORABLE on the twinclasses in \mathcal{U}_i will correspond to a truth assignment for the i -th variable group.

Central clique. We create a clique $F = \{f_1, \dots, f_r\}$ on r vertices which also belongs to the central part. The vertices of F will not be twins; each vertex of F has its own twinclass. This concludes the construction of the central part which will form the modulator \mathcal{X} .

Our construction will ensure that no vertex of F can be deleted; we will prove so later. This allows us to use F to simulate LIST COLORING constraints, i.e., we can forbid specific colors at a vertex. To do so, we normalize the considered solutions by assuming that $\varphi(f_s) = s$ for all $s \in [r]$ and then no vertex v adjacent to some f_s can receive color s . We say that a solution φ is *normalized* if $F \cap \varphi^{-1}(\perp) = \emptyset$ and $\varphi(f_s) = s$ for all $s \in [r]$.

We mention here that in principle a twinclass-modulator could contain arbitrarily large twinclasses. In our case, every twinclass has size at most $r = \mathcal{O}(1)$, so the number $|\bigcup(\mathcal{X})|$ of vertices in \mathcal{X} is linear in the size $|\mathcal{X}|$ of \mathcal{X} .

Budget. The budget $b = \text{cost}_{\mathcal{P}} + trp/2$ for the DELETION TO r -COLORABLE instance is split into two parts. The first part $\text{cost}_{\mathcal{P}}$ is due to a vertex-disjoint packing \mathcal{P} of subgraphs that will be described later and the second part $trp/2$ is allocated to the vertices in the twinclass-modulator.

Partial solution structure. We want to ensure that under our budget restriction no vertex of F can be deleted, as otherwise the simulation of LIST COLORING constraints will not work. This entails that all considered solutions should perform the same number of deletions. On the gadgets that will be attached to the central vertices, this does not pose a big issue. However, it does on the central vertices: to obtain the desired lower bound, for each true twinclass $U \in \mathcal{U}$ and solution φ , it should in principle be possible for $\varphi(U)$ to attain every subset of $[r]$, so that we have 2^r states per twinclass. However, the number of deletions in U depends on $|\varphi(U)|$. We can partition the possible states into different *levels* depending on the number ℓ of deletions they incur in the true twinclass. A state can incur any number of deletions between 0 and r .

Using slightly larger groups like Cygan et al. [11] allows us to overcome these issues. By using slightly more twinclasses per variable group $i \in [t]$ than necessitated by the base conversion, we can consider solutions with a special structure on the central vertices. It is designed in such a way that all solutions obeying this structure incur the same number of deletions on the central vertices while still allowing all states to appear the same number of times. Due to the slight increase in the number of twinclasses, we can still encode sufficiently many truth assignments into such structured solutions.

For every $i \in [t]$, $U \in \mathcal{U}_i$, $C \subseteq [r]$, we fix some representative solution $\varphi_{i,U,C} : U \rightarrow [r] \cup \{\perp\}$ to DELETION TO r -COLORABLE on U with $\varphi_{i,U,C}(U) \setminus \{\perp\} = C$. The point of this is that we only distinguish between different solutions φ based on the sets $\varphi(U)$, $U \in \mathcal{U}_i$, and not based on the actual mappings $\varphi|_U$, $U \in \mathcal{U}_i$. Since there are exactly $\binom{r}{r-\ell} = \binom{r}{\ell}$ states that incur exactly ℓ deletions each and we want to allow for the possibility of all states appearing the same number of times, we arrive at the following definition for each group $i \in [t]$:

$$\begin{aligned} \Phi_i = \{ & \varphi : \bigcup(\mathcal{U}_i) \rightarrow [r] \cup \{\perp\} : \varphi \text{ is solution of DELETION TO } r\text{-COLORABLE on } \bigcup(\mathcal{U}_i) \\ & \left| \left\{ U \in \mathcal{U}_i : \varphi(U) \setminus \{\perp\} \in \binom{[r]}{\ell} \right\} \right| = \binom{r}{\ell} \frac{p}{2^r} \text{ for all } \ell = 0, \dots, r \text{ and} \\ & \text{with } \varphi|_U \equiv \varphi_{i,U,\varphi(U) \setminus \{\perp\}} \text{ for all } U \in \mathcal{U}_i \}. \end{aligned}$$

Informally, this means that we only consider partial solutions that pick a representative solution on each twinclass in \mathcal{U}_i and for every level $\ell \in \{0\} \cup [r]$, i.e., a possible number of deletions, there is a fixed number $\binom{r}{\ell} \frac{p}{2^r}$ of twinclasses in \mathcal{U}_i where the partial solution attains a state of level ℓ . Lemma 6.8 gives the total number of deletions for a partial solution $\varphi_i \in \Phi_i$ and Lemma 6.9 studies the size of Φ_i .

► **Lemma 6.8.** *If $\varphi \in \Phi_i$, then $|\varphi^{-1}(\perp)| = rp/2$.*

Proof.

$$|\varphi^{-1}(\perp)| = \sum_{\ell=0}^r (r-\ell) \binom{r}{\ell} \frac{p}{2^r} = \frac{p}{2^r} r \sum_{\ell=0}^{r-1} \binom{r-1}{\ell} = \frac{p}{2^r} r 2^{r-1} = rp/2. \quad \blacktriangleleft$$

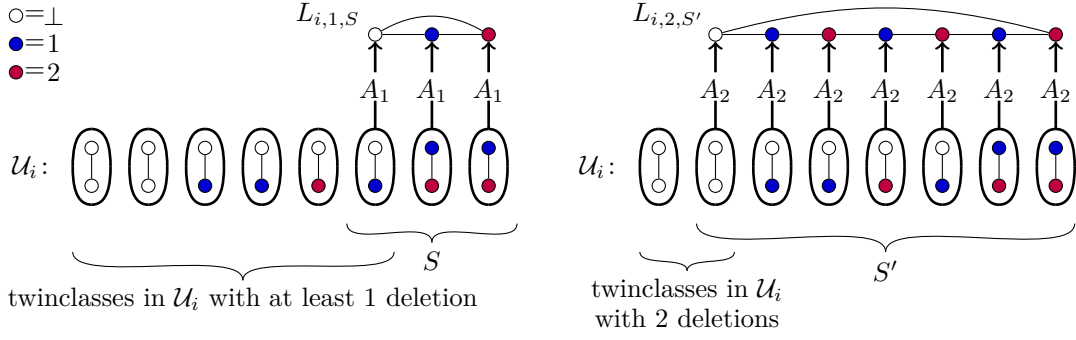

Figure 6 The construction of structure gadgets $L_{i,1,S}$ and $L_{i,2,S'}$ for the case of $r = 2$, i.e., ODD CYCLE TRANSVERSAL, and $p = 8$ and its connection to the central twinclasses. The large ellipses represent twinclasses and the arrows represent thick 1-arrows or thick 2-arrows. The depicted solution φ_i belongs to Φ_i and propagates a deletion to every attached structure gadget. Note that φ_i does not use each color set the same number of times.

► **Lemma 6.9.** *If $p \geq 2^r$, then we have that $|\Phi_i| \geq (2^r)^p \frac{(2^r-1)!}{2^{(2^r)}} p^{-(2^r)}$.*

Proof. Observe that

$$\left| \left\{ \varphi \in \Phi_i : |\{U \in \mathcal{U}_i : \varphi(U) \setminus \{\perp\} = C\}| = \frac{p}{2^r} \text{ for all } C \subseteq [r] \right\} \right| = \binom{p}{\frac{p}{2^r}, \dots, \frac{p}{2^r}} = x,$$

where x is the central multinomial coefficient. The central multinomial coefficient x is a maximum of the function $(c_1, \dots, c_{2^r}) \mapsto \binom{p}{c_1, \dots, c_{2^r}}$. Hence, x is a maximum term in the sum of the multinomial theorem, i.e., $(2^r)^p = \sum_{c_1 + \dots + c_{2^r} = p} \binom{p}{c_1, \dots, c_{2^r}}$. The number of terms in the sum of the multinomial theorem is the number of weak compositions of p into 2^r parts which is $\binom{p+2^r-1}{p}$. Bounding this term from above using $p \geq 2^r$, we obtain

$$\binom{p+2^r-1}{p} = \frac{1}{(2^r-1)!} (p+1) \cdots (p+2^r-1) \leq \frac{1}{(2^r-1)!} (2p)^{(2^r)} = \frac{2^{2^r}}{(2^r-1)!} p^{(2^r)}.$$

By the multinomial theorem, we hence obtain that

$$|\Phi_i| \geq x \geq (2^r)^p \frac{(2^r-1)!}{2^{(2^r)}} p^{-(2^r)}. \quad \blacktriangleleft$$

Hence, if we choose p as discussed previously, then we can pick for each group $i \in [t]$ an efficiently computable injective mapping $\kappa_i: \{0, 1\}^{p_0} \rightarrow \Phi_i$ that maps truth assignments of the i -th variable group to partial solutions on \mathcal{U}_i with the desired structure.

Structure gadgets. We proceed by constructing the *structure gadgets* to enforce that the partial solution on \mathcal{U}_i belongs to Φ_i . For every group $i \in [t]$, number of deletions $\ell \in [r]$, set of twinclasses $\mathcal{S} \subseteq \mathcal{U}_i$ with $|\mathcal{S}| = \binom{r}{r-\ell+1} \frac{p}{2^r} + 1$, we add an $(r+1)$ -critical graph $L_{i,\ell,\mathcal{S}} \in \mathcal{H}^r$ consisting of at least $|\mathcal{S}|$ vertices. For every $U \in \mathcal{S}$, we pick a private vertex v in $L_{i,\ell,\mathcal{S}}$ and add the thick ℓ -arrow $A_\ell(U, v)$. We create $1 + trp/2 = 1 + (b - \text{cost}_p)$ copies of $L_{i,\ell,\mathcal{S}}$ and the incident thick arrows. This concludes the construction of the structure gadget, cf. Figure 6.

Due to our budget constraint, no solution will be able to perform too many deletions in the central vertices. The idea of the structure gadget is that if a solution φ performs too few deletions in the twinclasses of \mathcal{U}_i , then we can find an ℓ and an $\mathcal{S} \subseteq \mathcal{U}_i$ with $|\mathcal{S}| = \binom{r}{r-\ell+1} \frac{p}{2^r} + 1$ such that φ deletes less than ℓ vertices in each $U \in \mathcal{S}$. Hence, all thick

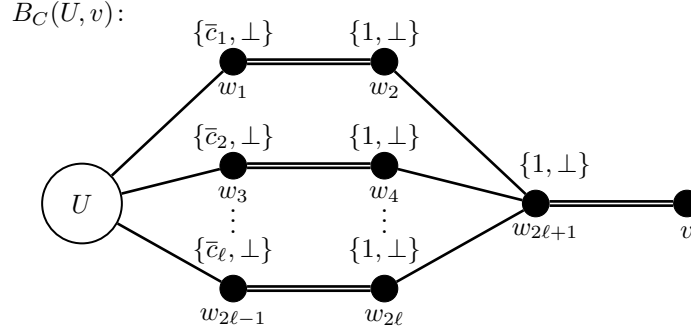

■ **Figure 7** The construction of a color-set-gadget $B_C(U, v)$ with $[r] \setminus C = \{\bar{c}_1, \dots, \bar{c}_\ell\}$. The double-lined edges represent deletion edges. An edge attached to a circle or ellipse represents a *join*, i.e., a bundle of edges. The sets depict the allowed states at a vertex.

ℓ -arrows leading to $L_{i,\ell,S}$ and its copies have to be passive. To resolve all these $(r+1)$ -critical graphs, we have to spend one extra unit of budget per copy which is not accounted for by the packing. Due to the large number of copies, this implies that we must violate our budget constraint.

Color-set-gadgets. The next step is to construct gadgets that can distinguish between the different partial solutions in Φ_i . To do so, these gadgets must be able to react not only based on the number of deletions inside a twinclass, but also based on the set of colors used for a twinclass. In Lemma 6.10, we construct *color-set-gadgets* $B_C(U, v)$ using LIST COLORING constraints simulated by the central clique F . Given a solution φ and a set of colors $C \subsetneq [r]$, the color-set-gadget $B_C(U, v)$ propagates a deletion to the vertex v when the set of colors $\varphi(U) \setminus \{\perp\}$ used on a set of true twins U is a subset of C , i.e., $\varphi(U) \setminus \{\perp\} \subseteq C$. We say that $B_C(U, v)$ is *active* if a deletion is propagated to v and *passive* otherwise.

► **Lemma 6.10.** *Let U be a set consisting of at most r true twins and v be a vertex that is not adjacent to U and let $C \subsetneq [r]$ with $|C| \leq |U|$. There is a graph $B = B_C(U, v)$ with the following properties:*

- Any solution φ , also unnormalized ones, satisfies $|V(B - U) \cap \varphi^{-1}(\perp)| \geq (r - |C|) + 1$.
- If φ is a normalized solution with $|V(B - U) \cap \varphi^{-1}(\perp)| = (r - |C|) + 1$, then $\varphi(v) = \perp$ implies that $\varphi(U) \setminus \{\perp\} \subseteq C$.
- Any normalized solution $\tilde{\varphi}$ for $\tilde{G} = G[(V \setminus V(B)) \cup U \cup \{v\}]$ with $\tilde{\varphi}(v) \neq \perp$ or $\tilde{\varphi}(U) \setminus \{\perp\} \subseteq C$ can be extended to a normalized solution φ for G with $|V(B - U) \cap \varphi^{-1}(\perp)| = (r - |C|) + 1$.
- $\text{tw}(B - U) \leq r$ via a winning cops-and-robber-strategy starting with a cop on v .

Proof. Let $[r] \setminus C = \{\bar{c}_1, \dots, \bar{c}_\ell\}$. We add $2\ell + 1$ vertices $w_1, \dots, w_{2\ell+1}$ and add all edges between w_{2i-1} , $i \in [\ell]$, and U , all edges between w_{2i} , $i \in [\ell]$, and $w_{2\ell+1}$, a deletion edge between $w_{2\ell+1}$ and v and a deletion edge between each pair w_{2i-1} and w_{2i} for $i \in [\ell]$. We also add all edges between $\{w_{2i} : i \in [\ell]\} \cup \{w_{2\ell+1}\}$ and $F \setminus \{f_1\}$. Finally, for each $i \in [\ell]$, vertex w_{2i-1} is adjacent to all vertices in $F \setminus \{f_{\bar{c}_i}\}$. Hence, considering a normalized solution, the vertices in $\{w_{2i} : i \in [\ell]\} \cup \{w_{2\ell+1}\}$ may only receive color 1 or be deleted and vertex w_{2i-1} , $i \in [\ell]$, may only receive color \bar{c}_i or be deleted. See Figure 7 for a depiction of the construction.

The lower bound on the number of deletions for possibly unnormalized solutions follows by noticing that $B - U$ contains $\ell + 1 = (r - |C|) + 1$ disjoint deletion edges.

Suppose that φ is a normalized solution with $|V(B-U) \cap \varphi^{-1}(\perp)| = \ell+1$ and $\varphi(U) \setminus \{\perp\} \not\subseteq C$, then there exists some $\bar{c}_i \in ([r] \setminus C) \cap \varphi(U)$. Due to the constraints enforced by F , we must have that $\varphi(w_{2i-1}) = \perp$ and $\varphi(w_{2i}) = 1$ by the bound on the number of deletions. This in turn forces $\varphi(w_{2\ell+1}) = \perp$ and hence v cannot be deleted without violating the deletion bound.

Suppose that $\tilde{\varphi}$ is a normalized solution of \tilde{G} with $\tilde{\varphi}(v) \neq \perp$, then we can extend to a normalized solution φ of G by deleting all vertices in $\{w_{2i-1} : i \in [\ell]\} \cup \{w_{2\ell+1}\}$. It is easy to see that the remainder can be colored correctly.

Suppose that $\tilde{\varphi}$ is a normalized solution of \tilde{G} with $\tilde{\varphi}(U) \setminus \{\perp\} \subseteq C$ and $\tilde{\varphi}(v) = \perp$. Since $([r] \setminus C) \cap \tilde{\varphi}(U) = \emptyset$, we can extend $\tilde{\varphi}$ to a normalized solution φ of G by setting $\varphi(w_{2i-1}) = \bar{c}_i$, $\varphi(w_{2i}) = \perp$ for all $i \in [\ell]$, and $\varphi(w_{2\ell+1}) = 1$. It is easy to see that the remainder can be colored correctly.

We argue that $\text{tw}(B-U) \leq r$ using the omniscient cops-and-robber-game. We begin by placing cops on v and $w_{2\ell+1}$. This splits the graph into $\ell+1$ connected components, one per deletion edge. We place two cops on the endpoints of the deletion edge the robber escaped to. If v or respectively $w_{2\ell+1}$ is not an endpoint of the considered deletion edge, then we remove the cop from v or respectively $w_{2\ell+1}$. Finally, we place $r-1$ cops on the vertices inside the deletion edge and capture the robber. This proves the treewidth bound by Theorem 4.5. ◀

In the case of $C = \emptyset$ one could also use a thick r -arrow from Lemma 6.7 instead. We will only invoke Lemma 6.10 with $|U| = r$ in the dense setting of the DELETION TO r -COLORABLE lower bound; we use the case $|U| = 1$ for the sparse version of the lower bound.

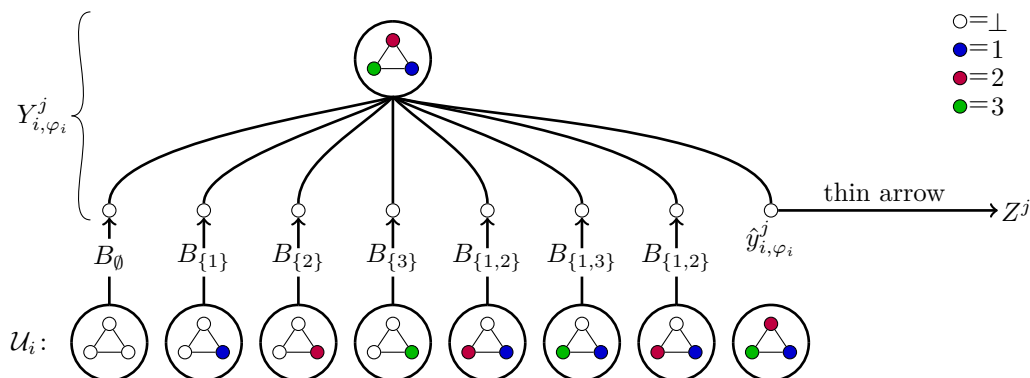

■ **Figure 8** The decoding gadget Y_{i, φ_i}^j and its connections to the central twinclasses and the clause gadget for the case $r = 3$ and $p = 8$. The large circles represent twinclasses and the arrows represent color-set-gadgets or thin arrows. The solution chosen on the central twinclasses is φ_i . Note that it is allowed that φ_i uses the same color set on several twinclasses in U_i .

Decoding gadgets. The color-set-gadgets allow us to construct *decoding gadgets* that can distinguish between the different partial solutions in Φ_i . While the color-set-gadgets only check for inclusion and not equality, this is nonetheless sufficient to distinguish solutions in Φ_i due to their structure.

We begin with the construction now. For the j -th clause, group $i \in [t]$, solution $\varphi_i \in \Phi_i$, we construct a gadget Y_{i, φ_i}^j as follows. The gadget Y_{i, φ_i}^j consists of a large independent set joined to a K_r , i.e., adding all edges between both sets. In other words, Y_{i, φ_i}^j is a complete $(r+1)$ -partite graph with one large independent set and all other independent sets in the partition are singletons. More precisely, the large independent set consists of $(1 - 2^{-r})p + 1$

vertices (recall that 2^r divides p). One of these vertices is distinguished and denoted by \hat{y}_{i,φ_i}^j . This concludes the construction, see Figure 8 for a depiction of the construction.

In particular, the K_r and \hat{y}_{i,φ_i}^j induce a complete graph of size $r+1$. Hence, any solution must delete at least one vertex in this complete graph and due to the budget constraint exactly one vertex has to be deleted. The distinguished vertex \hat{y}_{i,φ_i}^j can only be deleted if also all other vertices in the large independent set are deleted. By appropriately adding color-set-gadgets, we will ensure that this can only be achieved if φ_i is chosen on \mathcal{U}_i .

For the j -th clause, group $i \in [t]$, solution $\varphi_i \in \Phi_i$, twinclass $U \in \mathcal{U}_i$ with $\varphi_i(U) \neq [r]$, we pick a private vertex $v \neq \hat{y}_{i,\varphi_i}^j$ in the large independent set of Y_{i,φ_i}^j and add the color-set-gadget $B_{\varphi_i(U) \setminus \{\perp\}}(U, v)$ and denote this instance of the color-set-gadget by $W_{i,\varphi_i,U}^j$. We will see, using the properties of solutions in Φ_i , that if the solution on \mathcal{U}_i diverges from φ_i , then at least one $W_{i,\varphi_i,U}^j$ will be passive. Otherwise, all $W_{i,\varphi_i,U}^j$ will be active, allowing us to delete the vertex \hat{y}_{i,φ_i}^j in Y_{i,φ_i}^j .

Clause gadgets. For the j -th clause, we add an $(r+1)$ -critical graph, denoted $Z^j \in \mathcal{H}^r$, consisting of at least $q2^{p_0}$ vertices. For every group $i \in [t]$ and solution $\varphi_i \in \Phi_i$ such that $\kappa_i^{-1}(\varphi_i)$ is a partial truth assignment satisfying the j -th clause, we pick a private vertex v in Z^j and add a thin arrow from \hat{y}_{i,φ_i}^j to v . Since every clause consists of at most q literals, at most q groups can contain a literal of the j -th clause and every such group has at most 2^{p_0} assignments that satisfy the j -th clause, hence Z^j contains enough vertices so that we can always pick a private one. This concludes the construction of the clause gadget.

The idea of the clause gadget is that we can only afford to delete a vertex in Z^j if we have picked a partial solution on some \mathcal{U}_i that corresponds to a satisfying truth assignment of the j -th clause, which will propagate a deletion to Z^j via the decoding gadgets.

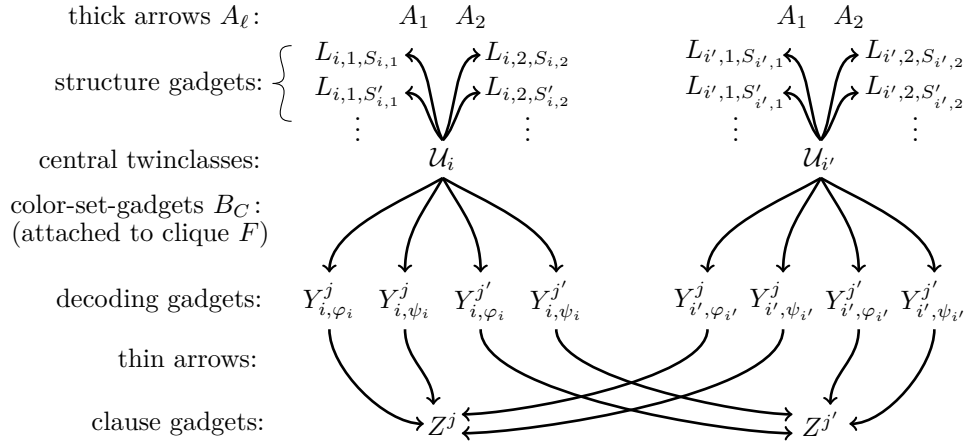

■ **Figure 9** An overview of the construction of the graph $G(\sigma, r, p_0)$ for the case $r = 2$.

Packing. We will now construct a packing \mathcal{P} of vertex-disjoint graphs that will fully explain the budget outside of the central vertices. For every thin arrow from u to v in the construction, we add the K_{r+1} induced by the deletion edge incident to v to the packing \mathcal{P} . For every thick ℓ -arrow $A_\ell(U, v)$ in the construction, we add $A_\ell(U, v) - U$ to the packing \mathcal{P} and by Lemma 6.7 these graphs require at least ℓ deletions each. For every color-set-gadget $B_C(U, v)$ in the construction, we add $B_C(U, v) - U$ to the packing \mathcal{P} and by Lemma 6.10 these graphs

require at least $(r - |C|) + 1$ deletions each. Finally, for every Y_{i,φ_i}^j , we add the K_{r+1} induced by \hat{y}_{i,φ_i}^j and the K_r of Y_{i,φ_i}^j to the packing \mathcal{P} . Let $\text{cost}_{\mathcal{P}}$ denote the cost of the packing \mathcal{P} .

Observe that no vertex will be the head of several arrows or color-set-gadgets in our construction, hence the graphs in \mathcal{P} are indeed vertex-disjoint. Furthermore, no graph in \mathcal{P} intersects the central vertices and the cost of \mathcal{P} is independent of the partial solution chosen on the central vertices. Finally, notice that the cost of $B_C(U, v) - U$ is fully explained by the $(r - |C|) + 1$ disjoint deletion edges and hence does not rely on any LIST COLORING constraints simulated by the central clique F .

This concludes the construction of $G = G(\sigma, r, p_0)$, cf. Figure 9. We proceed by showing the correctness of the reduction. From now on, we might omit the range of the indices for the sake of readability, but we keep the meaning of the indices consistent throughout. By i we denote a group of variables, φ_i denotes a partial solution in Φ_i , and U denotes a true twinclass in \mathcal{U}_i with $\varphi_i(U) \neq [r]$.

► **Theorem 6.11.** *Let σ be a q -SATISFIABILITY instance with n variables and m clauses. Let $G = G(\sigma, r, p_0)$ and \mathcal{P} be the graph and packing as constructed above and let $b = \text{cost}_{\mathcal{P}} + \text{trp}/2$. If σ has a satisfying assignment τ , then there is a solution φ of the DELETION TO r -COLORABLE instance (G, b) .*

Proof. We start with the construction of φ on the central vertices. We color the central clique F with $\varphi(f_s) = s$ for $s \in [r]$, i.e., φ will be a normalized solution. For each group i of variables, let $\tau_i \in \{0, 1\}^{p_0}$ be the partial truth assignment on group i induced by τ . For each group i , we set $\varphi|_{\bigcup(\mathcal{U}_i)} = \varphi_i := \kappa_i(\tau_i) \in \Phi_i$. By Lemma 6.8, this results in exactly $\text{trp}/2$ deletions. Hence, only the budget $\text{cost}_{\mathcal{P}}$ for the packing \mathcal{P} remains, so for every graph in \mathcal{P} we have to match the lower bound on the number of deletions for this graph.

Whenever we delete the tail u or head v of a thin arrow from u to v , then we use the active solution on this arrow; otherwise, we use the passive solution. Either type of solution results in exactly one deletion in the deletion edge incident to v which belongs to \mathcal{P} .

Similarly, for any thick ℓ -arrow $A_\ell(U, v)$, we extend to the solution with $|V(A_\ell(U, v) - U) \cap \varphi^{-1}(\perp)| = \ell$ as given by Lemma 6.7. If $|U \cap \varphi^{-1}(\perp)| \geq \ell$, then this solution is active and satisfies $\varphi(v) = \perp$.

For every color-set-gadget $B_C(U, v)$, we extend to the solution with $|V(B_C(U, v) - U) \cap \varphi^{-1}(\perp)| = (r - |C|) + 1$ as given by Lemma 6.10. If $\varphi(U) \setminus \{\perp\} \subseteq C$, then this solution is active and satisfies $\varphi(v) = \perp$.

For every decoding gadget Y_{i,φ_i}^j , we delete the distinguished vertex \hat{y}_{i,φ_i}^j . For every j -th clause, group i , and solution $\psi_i \in \Phi_i \setminus \{\varphi_i\}$, we pick one of the vertices in the K_r of Y_{i,ψ_i}^j and delete it. This deletes exactly one vertex in the K_{r+1} formed by \hat{y}_{i,φ_i}^j or \hat{y}_{i,ψ_i}^j and the K_r .

This concludes the description of the deletions; for each graph in the packing \mathcal{P} , we match the lower bound on the number of deletions for this graph. It remains to show that the remainder of G can be properly r -colored. This can be easily seen for the thin arrows. For thick ℓ -arrows $A_\ell(U, v)$ it follows from Lemma 6.7. For the color-set-gadgets $W_{i,\psi_i,U}^j$, where $\psi_i \in \Phi_i$, it follows from Lemma 6.10. It remains to handle the structure gadgets $L_{i,\ell,S}$, the decoding gadgets Y_{i,ψ_i}^j , $\psi_i \in \Phi_i$, and the clause gadgets Z^j .

By Lemma 6.7 and Lemma 6.10, we can appropriately extend solutions to $A_\ell(U, v)$ and $B_C(U, v)$ for every color choice on the vertex v . Hence, when handling the aforementioned gadgets, it does not matter how we color the undeleted vertices. It is sufficient to verify that enough deletions occur and that the remainder of the gadget can be r -colored.

Consider some group i , some $\ell \in [r]$, some $\mathcal{S} \subseteq \mathcal{U}_i$ with $|\mathcal{S}| = \binom{r}{\geq (r-\ell+1)} \frac{p}{2^r} + 1$, and some copy of $L_{i,\ell,S}$. Since $L_{i,\ell,S}$ is an $(r + 1)$ -critical graph that does not belong to

\mathcal{P} , we must perform at least one deletion in $L_{i,\ell,\mathcal{S}}$ and this deletion has to be propagated to $L_{i,\ell,\mathcal{S}}$ by some thick ℓ -arrow $A_\ell(U, v)$, $U \in \mathcal{U}_i$. Since $\varphi_i \in \Phi_i$, we have that $\left| \left\{ U \in \mathcal{U}_i : \varphi_i(U) \setminus \{\perp\} \in \binom{[r]}{\leq(r-\ell)} \right\} \right| = \binom{r}{\leq(r-\ell)} \frac{p}{2^r}$, i.e., there are exactly $\binom{r}{\leq(r-\ell)} \frac{p}{2^r}$ twinclasses in \mathcal{U}_i where φ_i deletes at least ℓ vertices in each. Due to $\binom{r}{\leq(r-\ell)} \frac{p}{2^r} + |\mathcal{S}| = p + 1 > p = |\mathcal{U}_i|$, there must be at least one twinclass $U \in \mathcal{S}$ with $\varphi_i(U) \setminus \{\perp\} \in \binom{[r]}{\leq(r-\ell)}$, i.e., where φ_i deletes at least ℓ vertices. Therefore, the thick ℓ -arrow $A_\ell(U, v)$ leading to this copy of $L_{i,\ell,\mathcal{S}}$ propagates a deletion to $L_{i,\ell,\mathcal{S}}$ by Lemma 6.7 and thereby resolves this $(r+1)$ -critical graph.

Consider some Y_{i,ψ_i}^j , where $\psi_i \in \Phi_i$, if $\psi_i \neq \varphi_i$, then one of the vertices in the K_r is deleted and this $(r+1)$ -partite graph is resolved. If $\psi_i = \varphi_i$, then we claim that the large independent set is fully deleted. In the construction of φ , we distributed a deletion to \hat{y}_{i,φ_i}^j . All other vertices v of the large independent set are hit by some $W_{i,\varphi_i,U}^j$, where $\varphi_i(U) \setminus \{\perp\} \neq [r]$. By Lemma 6.10, we see that $W_{i,\varphi_i,U}^j = B_{\varphi_i(U) \setminus \{\perp\}}(U, v)$ propagates a deletion to v due to Lemma 6.10. Due to $\varphi_i \in \Phi_i$, there are $\binom{r}{\leq(r-1)} \frac{p}{2^r} = (1 - 2^{-r})p$ twinclasses $U \in \mathcal{U}_i$ with $\varphi_i(U) \setminus \{\perp\} \neq [r]$, thus matching the size of the large independent set of Y_{i,φ_i}^j with the exception of \hat{y}_{i,φ_i}^j . This shows that the large independent set is fully deleted and the $(r+1)$ -partite graph Y_{i,φ_i}^j is resolved.

Finally, consider some Z^j , then there is some group i such that τ_i satisfies the j -th clause because τ is a satisfying assignment of σ . By construction $\varphi_i = \kappa_i(\tau_i)$ and the vertex \hat{y}_{i,φ_i}^j is deleted, so the thin arrow from \hat{y}_{i,φ_i}^j to Z^j is active and propagates a deletion to Z^j . Therefore, the $(r+1)$ -critical graph Z^j is resolved as well. \blacktriangleleft

► Theorem 6.12. *Let σ be a q -SATISFIABILITY instance with n variables and m clauses. Let $G = G(\sigma, r, p_0)$ be the graph as constructed above and let $b = \text{cost}_{\mathcal{P}} + \text{tr}p/2$. If φ is a solution of the DELETION TO r -COLORABLE instance (G, b) , then $|\varphi^{-1}(\perp)| = b$. Furthermore, there is a normalized solution ψ with $|\psi^{-1}(\perp)| = |\varphi^{-1}(\perp)| = b$ and $\psi|_{\bigcup \mathcal{U}_i} \in \Phi_i$ for all $i \in [t]$.*

Proof. As argued in the construction of \mathcal{P} , the packing \mathcal{P} forces φ to spend at least $\text{cost}_{\mathcal{P}}$ units of budget outside of the central vertices. We claim that for any group $i \in [t]$ and number of deletions $\ell \in [r]$, there must be at least $\binom{r}{\leq(r-\ell)} \frac{p}{2^r}$ twinclasses $U \in \mathcal{U}_i$ such that $|U \cap \varphi^{-1}(\perp)| \geq \ell$, i.e., φ deletes at least ℓ vertices in each of those U . We first define $\mathcal{S}_i^\ell(\varphi) = \{U \in \mathcal{U}_i : |U \cap \varphi^{-1}(\perp)| = \ell\}$ and $\mathcal{S}_i^{\geq \ell}(\varphi) = \mathcal{S}_i^\ell(\varphi) \cup \mathcal{S}_i^{\ell+1}(\varphi) \cup \dots \cup \mathcal{S}_i^r(\varphi)$ for all $i \in [t]$ and $\ell \in \{0\} \cup [r]$.

Suppose that there is some group i and some number of deletions $\ell \in [r]$ with $|\mathcal{S}_i^{\geq \ell}(\varphi)| < \binom{r}{\leq(r-\ell)} \frac{p}{2^r}$. Then there exists a family $\mathcal{S} \subseteq \mathcal{U}_i$ of twinclasses with $|\mathcal{S}| = \binom{r}{\geq(r-\ell+1)} \frac{p}{2^r} + 1$ and $\mathcal{S}_i^{\geq \ell}(\varphi) \cap \mathcal{S} = \emptyset$. Consider any copy of $L_{i,\ell,\mathcal{S}}$ and the thick ℓ -arrows $A_\ell(U, v)$ from $\mathcal{S} \subseteq \mathcal{U}_i$ to $L_{i,\ell,\mathcal{S}}$. Due to $\mathcal{S}_i^{\geq \ell}(\varphi) \cap \mathcal{S} = \emptyset$, the solution φ deletes at most $\ell - 1$ vertices in each $U \in \mathcal{S}$, and by Lemma 6.7 this implies that no vertex in the copy of $L_{i,\ell,\mathcal{S}}$ is deleted, unless we pay for at least one extra deletion not accounted for by the packing \mathcal{P} per copy of $L_{i,\ell,\mathcal{S}}$. However, since $L_{i,\ell,\mathcal{S}}$ is an $(r+1)$ -critical graph, we must delete at least one vertex in each copy. This would exceed our remaining budget, because there are $1 + \text{tr}p/2 > b - \text{cost}_{\mathcal{P}}$ copies of $L_{i,\ell,\mathcal{S}}$. Hence, we must have that $|\mathcal{S}_i^{\geq \ell}(\varphi)| \geq \binom{r}{\leq(r-\ell)} \frac{p}{2^r}$ for all groups $i \in [t]$ and deletions $\ell \in [r]$.

We will now argue that we must have $|\mathcal{S}_i^\ell(\varphi)| = \binom{r}{r-\ell} \frac{p}{2^r}$ for all $i \in [t]$ and $\ell \in [r]$ due to our budget constraint. Consider some group i , using the previous inequalities we can derive

the following bound on the total number of deletions performed on \mathcal{U}_i by φ :

$$\begin{aligned} \sum_{\ell=1}^r \ell |\mathcal{S}_i^\ell(\varphi)| &= r |\mathcal{S}_i^r(\varphi)| + \sum_{\ell=1}^{r-1} \ell (|\mathcal{S}_i^{\geq \ell}(\varphi)| - |\mathcal{S}_i^{\geq (\ell+1)}(\varphi)|) = \sum_{\ell=1}^r |\mathcal{S}_i^{\geq \ell}(\varphi)| \\ &\geq \sum_{\ell=1}^r \binom{r}{\leq (r-\ell)} \frac{p}{2^r} = \sum_{\ell=0}^{r-1} (r-\ell) \binom{r}{\ell} \frac{p}{2^r} = rp/2, \end{aligned}$$

where the last inequality follows from the computation in the proof of Lemma 6.8. Summing over the lower bound for all groups, we see that this uses up the whole remaining budget and hence the inequality must be tight for every group. Therefore, also $|\mathcal{S}_i^{\geq \ell}(\varphi)| = \binom{r}{\leq (r-\ell)} \frac{p}{2^r}$ and $|\mathcal{S}_i^\ell(\varphi)| = |\mathcal{S}_i^{\geq \ell}(\varphi)| - |\mathcal{S}_i^{\geq (\ell+1)}(\varphi)| = \binom{r}{r-\ell} \frac{p}{2^r}$ for all $i \in [t]$ and $\ell \in [r]$. Since $\sum_{\ell=0}^r |\mathcal{S}_i^\ell(\varphi)| = p$, this also implies that $|\mathcal{S}_i^0(\varphi)| = \binom{r}{r} \frac{p}{2^r} = \frac{p}{2^r}$ for all groups i .

No vertex of the central clique F can be deleted, because φ spends its whole budget on the packing \mathcal{P} and the families of twinclasses \mathcal{U}_i , $i \in [t]$. Hence, we can assume by permuting the colors that $\varphi(f_s) = s$, $s \in [r]$, i.e., φ is a normalized solution.

Finally, the equations $|\mathcal{S}_i^\ell(\varphi)| = \binom{r}{r-\ell} \frac{p}{2^r} = \binom{r}{\ell} \frac{p}{2^r}$, $i \in [t]$, $\ell \in \{0\} \cup [r]$, imply that for every group i there exists some $\psi_i \in \Phi_i$ with $\varphi(U) = \psi_i(U)$ for all $U \in \mathcal{U}_i$. Since all $U \in \mathcal{U}_i$ are twinclasses, exchanging $\varphi|_{\bigcup(\mathcal{U}_i)}$ with ψ_i for every group i still yields a solution ψ for DELETION TO r -COLORABLE with the desired properties. \blacktriangleleft

► Theorem 6.13. *Let σ be a q -SATISFIABILITY instance with n variables and m clauses. Let $G = G(\sigma, r, p_0)$ be the graph as constructed above and let $b = \text{cost}_{\mathcal{P}} + \text{tr}p/2$. If the DELETION TO r -COLORABLE instance (G, b) has a solution φ , then σ has a satisfying assignment τ .*

Proof. By Theorem 6.12, we know that $|\varphi^{-1}(\perp)| = b$ and can assume that φ is a normalized solution with $\varphi_i := \varphi|_{\bigcup(\mathcal{U}_i)} \in \Phi_i$ for all groups i . Hence, the deletions are fully explained by the packing \mathcal{P} and the properties of solutions in Φ_i .

For every thin arrow from u to v , thick ℓ -arrow $A_\ell(U, v)$, color-set-gadget $B_C(U, v)$, by Lemma 6.7 and Lemma 6.10, we can assume that φ chooses the active solution on this gadget if the appropriate condition at u or U is satisfied.

Consider the j -th clause and some group i , we begin by arguing that $\varphi(\hat{y}_{i,\psi_i}^j) = \perp$ only if $\psi_i = \varphi_i$. First, observe that \hat{y}_{i,ψ_i}^j may only be deleted if all other vertices of the large independent set in Y_{i,ψ_i}^j are deleted, otherwise Y_{i,ψ_i}^j as a complete $(r+1)$ -partite graph is not resolved or we exceed the packing budget on the complete graph induced by \hat{y}_{i,ψ_i}^j and the K_r . Consider some $\psi_i \in \Phi_i \setminus \{\varphi_i\}$. We will distinguish three cases.

1. Suppose that there is some $U \in \mathcal{U}_i$ such that $|\psi_i(U) \setminus \{\perp\}| < |\varphi_i(U) \setminus \{\perp\}|$. This implies that $\psi_i(U) \setminus \{\perp\} \neq [r]$, hence the gadget $W_{i,\psi_i,U}^j = B_{\psi_i(U) \setminus \{\perp\}}(U, v)$, where v is in the large independent set of Y_{i,ψ_i}^j , exists. The cardinality inequality also implies that $\varphi_i(U) \setminus \{\perp\} \not\subseteq \psi_i(U) \setminus \{\perp\}$, so by Lemma 6.10 and the budget being tight on the graphs of the packing \mathcal{P} , we see that v cannot be deleted. Hence, \hat{y}_{i,ψ_i}^j cannot be deleted either.
2. Suppose that there is some $U \in \mathcal{U}_i$ such that $|\psi_i(U) \setminus \{\perp\}| > |\varphi_i(U) \setminus \{\perp\}|$, then the first case must also apply for some $U' \in \mathcal{U}_i$, as otherwise ψ_i would perform too few deletions in \mathcal{U}_i and hence $\psi_i \notin \Phi_i$.
3. Since the first two cases do not apply, it follows that $|\psi_i(U) \setminus \{\perp\}| = |\varphi_i(U) \setminus \{\perp\}|$ for all $U \in \mathcal{U}_i$. Due to $\psi_i \neq \varphi_i$, there must be some $U \in \mathcal{U}_i$ such that $\psi_i(U) \setminus \{\perp\} \neq \varphi_i(U) \setminus \{\perp\}$. This implies that $\psi_i(U) \setminus \{\perp\} \neq [r]$ and hence the gadget $W_{i,\psi_i,U}^j = B_{\psi_i(U) \setminus \{\perp\}}(U, v)$, where v is in the large independent set of Y_{i,ψ_i}^j , exists. Since $|\psi_i(U) \setminus \{\perp\}| = |\varphi_i(U) \setminus \{\perp\}|$

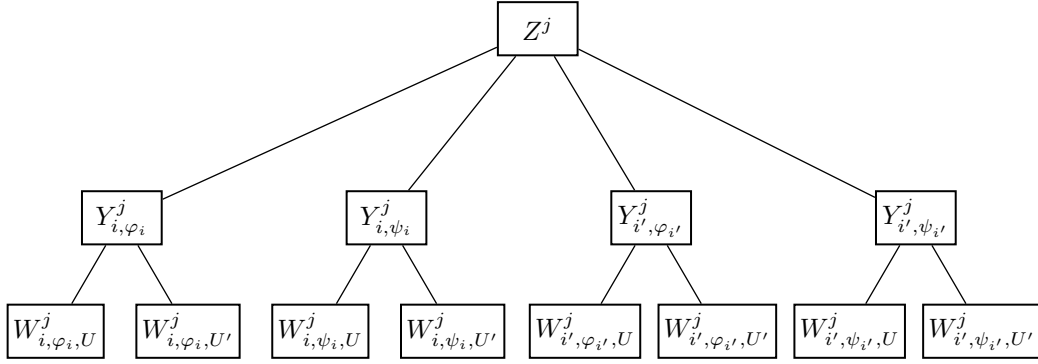

■ **Figure 10** A high-level overview of the component corresponding to the j -th clause after removing the TCM \mathcal{X} . The arrows leading to Z^j denote thin arrows.

and $\psi_i(U) \setminus \{\perp\} \neq \varphi_i(U) \setminus \{\perp\}$, we must have that $\varphi_i(U) \setminus \{\perp\} \not\subseteq \psi_i(U) \setminus \{\perp\}$, hence, as in the first case, v cannot be deleted and neither can \hat{y}_{i, ψ_i}^j .

This proves the claim regarding the deletion of \hat{y}_{i, ψ_i}^j .

Now, consider the gadget Z^j . To resolve Z^j , there has to be a thin arrow from some \hat{y}_{i, ψ_i}^j to Z^j that is active since Z^j is not part of the packing \mathcal{P} . By the previous claim, this implies that $\psi_i = \varphi_i$. Furthermore, by construction of G such a thin arrow only exists if the partial truth assignment $\tau_i = \kappa_i^{-1}(\varphi_i)$ satisfies the j -th clause. Note that the definition of τ_i is independent of the considered clause.

For some groups i , the partial solution φ_i might not be in the image of κ_i , in that case τ_i is an arbitrary partial truth assignment for the i -th variable group. By the previous argument, the truth assignment $\tau = \bigcup_{i=1}^t \tau_i$ must satisfy all clauses of σ . ◀

► **Theorem 6.14.** *Let $G = G(\sigma, r, p_0)$ be the graph as constructed above. The set $\mathcal{X} = (\bigcup_{i=1}^t \mathcal{U}_i) \cup \{\{f_s\} : s \in [r]\}$ is a TCM for G of size $tp + r$ to treewidth r , i.e., $|\mathcal{X}| = tp + r$ and $\text{tw}(G - \bigcup(\mathcal{X})) \leq r$.*

Proof. It follows from the construction of G that \mathcal{X} has size $\sum_{i=1}^t |\mathcal{U}_i| + |F| = tp + r$ and only consists of twinclasses. The fact that all sets in \mathcal{X} are twinclasses and not just sets of twins can be seen by considering the various color-set-gadgets $B_C(U, v)$ in the construction. It remains to argue that the treewidth of $G' := G - \bigcup(\mathcal{X})$ is at most r . We will show this by using the omniscient-cops-and-robber-game. The remaining graph G' consists of several connected components, namely one connected component per copy of $L_{i, \ell, \mathcal{S}}$ and one connected component for every clause. Observe that the heads of thick ℓ -arrows $A_\ell(U, v)$, of color-set-gadgets $B_C(U, v)$, of thin arrows, and also the tails of thin arrows consist of only a single vertex. So, if the robber escapes through one of these gadgets and there is no other path back, then a single cop suffices to prevent the robber from going back.

We begin by handling the connected components corresponding to a copy of $L_{i, \ell, \mathcal{S}}$. On a high level, these components look like stars; the center is $L_{i, \ell, \mathcal{S}}$ and for every $U \in \mathcal{S}$ the remainder $A_\ell(U, v) - U$ of a thick ℓ -arrow is attached to $L_{i, \ell, \mathcal{S}}$. By Theorem 6.1, $L_{i, \ell, \mathcal{S}}$ has pathwidth r . With $r + 1$ cops we sweep from left to right through the bags of the pathwidth decomposition of $L_{i, \ell, \mathcal{S}}$ until the robber escapes to one of the attached $A_\ell(U, v) - U$. When that happens we remove all cops, except the cop on the head v of the considered thick ℓ -arrow from $L_{i, \ell, \mathcal{S}}$. We can then capture the robber using the strategy given by Lemma 6.7.

Next, we handle the connected components corresponding to a clause. Figure 10 gives a high-level overview how these components look, notice that at this level there are no cycles.

Our strategy makes use of this hierarchy, we start at Z^j and chase the robber downwards, making sure that the robber cannot go back upwards. By Theorem 6.1, Z^j has pathwidth r . Again, we sweep with $r + 1$ cops from left to right through the bags of the pathwidth decomposition of Z^j , until the robber escapes through some thin arrow coming from some Y_{i,φ_i}^j . Then, we remove all cops except the one on the head of the thin arrow and place one cop on the tail \hat{y}_{i,φ_i}^j of the thin arrow. Either the robber escapes to the thin arrow, where we can capture it easily using $r - 1$ further cops or the robber escapes to Y_{i,φ_i}^j .

If the robber escapes to Y_{i,φ_i}^j , then we remove the cop from the head of the thin arrow and place r cops on the K_r in Y_{i,φ_i}^j . This leaves us with one connected component $W_{i,\varphi_i,U}^j = B_C(U, v)$ for each $U \in \mathcal{U}_i$ with $\varphi_i(U) \neq [r]$. Consider the connected component the robber escaped to and move the cop from \hat{y}_{i,φ_i}^j to v . Since there are still cops on the K_r in Y_{i,φ_i}^j , the robber cannot go back. We can now remove these cops on K_r and capture the robber using the strategy given by Lemma 6.10.

This concludes the strategy. Since we have never placed more than $r + 1$ cops simultaneously, we see by Theorem 4.5 that G' has treewidth at most r . \blacktriangleleft

Proof of Theorem 6.6. Suppose there is some $r \geq 2$ and $\varepsilon > 0$ such that DELETION TO r -COLORABLE can be solved in time $\mathcal{O}^*((2^r - \varepsilon)^{|\mathcal{X}|})$, where \mathcal{X} is a TCM to treewidth r . We will show that there exists a $\delta < 1$ such that for any clause size q , we can solve q -SATISFIABILITY in time $\mathcal{O}^*(2^{\delta n})$, where n is the number of variables. This contradicts SETH by Theorem 2.4 and hence implies the desired lower bound.

Given a q -SATISFIABILITY instance σ , we construct the graph $G = G(\sigma, r, p_0)$, where p_0 depends only on r and ε and will be chosen later. We can consider r , ε , and q as constants, hence also $p_0 = p_0(r, \varepsilon)$ and $p = p(p_0)$ are constant. First, we will argue that G has polynomial size. The number of vertices in the various gadgets can be estimated as follows, where we have an additional summand r for the $(r + 1)$ -critical graphs, since Theorem 6.1 only constructs them in increments of r :

- $|V(G[\bigcup(\mathcal{X})])| = \sum_{i=1}^t |\mathcal{U}_i| r + |F| = tpr + r = \lceil \frac{n}{p_0} \rceil pr + r = \mathcal{O}(n)$.
- $|V(L_{i,\ell,S})| \leq |\mathcal{S}| + r \leq |\mathcal{U}_i| + r = p + r = \mathcal{O}(1)$.
- $|V(Z^j)| \leq q2^{p_0} + r = \mathcal{O}(1)$.
- $|V(W_{i,\varphi_i,U}^j)| \leq (r + 1)^2 = \mathcal{O}(1)$.
- $|V(A_\ell(U, v))| \leq r^3 + 3r + 1 = \mathcal{O}(1)$.
- Every thin arrow consists of $2r + 1$ vertices.

Next, we bound how often each gadget appears:

- i can take on $t = \lceil \frac{n}{p_0} \rceil = \mathcal{O}(n)$ values.
- There are at most $\mathcal{O}(n^q)$ clauses, hence j can take on $\mathcal{O}(n^q)$ values.
- ℓ can take on $r = \mathcal{O}(1)$ values.
- For fixed i , $\mathcal{S} \subseteq \mathcal{U}_i$, so \mathcal{S} can take on $2^{|\mathcal{U}_i|} = 2^p = \mathcal{O}(1)$ values.
- We create $1 + tpr/2 = \mathcal{O}(n)$ copies of each $L_{i,\ell,S}$.
- For fixed i , $\varphi_i \in \Phi_i$ and $|\Phi_i| \leq (2^r)^p = \mathcal{O}(1)$.
- For fixed i , $U \in \mathcal{U}_i$, so U can take on $|\mathcal{U}_i| = p = \mathcal{O}(1)$ values.
- We create at most one (thin or thick) arrow per vertex in some Z^j or $L_{i,\ell,S}$.

Together, all these bounds show that G has polynomial size and following the construction of G , one can easily see that G can also be constructed in polynomial time. Furthermore, from the proof of Theorem 6.14 we can obtain a tree decomposition of $G' := G - \bigcup(\mathcal{X})$ of width r in polynomial time.

To analyze the running time resulting from applying the reduction and running the assumed algorithm for DELETION TO r -COLORABLE, we first bound p as follows:

$$p \leq \frac{p_0}{r} + 2^{r+1} \lceil \log_{2^r} (p_0/r) \rceil + 2^r + 1. \quad (1)$$

In the construction of $G = G(\sigma, r, p_0)$, we chose p as the smallest integer such that p is divisible by 2^r and such that the quantity from Lemma 6.9, which we denote by x , is larger than 2^{p_0} . The summand 2^r in (1) accounts for the divisibility. It remains to show that the second property is satisfied, for this we work with $p = \frac{p_0}{r} + 2^{r+1} \lceil \log_{2^r} (p_0/r) \rceil + 1$.

We first observe that $(2^r - 1)!/2^{(2^r)} \geq \frac{1}{4}$ for all $r \geq 2$. Hence, $x \geq (2^r)^p p^{-(2^r)}/4 =: x'$. Furthermore, observe that we have $2p_0/r \geq p$ for sufficiently large p_0 . We proceed by showing that $x' \geq 2^{p_0}$:

$$\begin{aligned} x' &\geq (2^r)^{\frac{p_0}{r} + 2^{r+1} \lceil \log_{2^r} (p_0/r) \rceil} p^{-(2^r)} \geq 2^{p_0} \left(\frac{p_0}{r}\right)^{(2^{r+1})} p^{-(2^r)} \geq 2^{p_0} \left(\frac{p_0}{r}\right)^{(2^{r+1})} \left(\frac{2p_0}{r}\right)^{-(2^r)} \\ &\geq 2^{p_0} (p_0/r)^{(2^r)} 2^{-(2^r)} \geq 2^{p_0}, \end{aligned}$$

where we use $p_0/r \geq 2$ for sufficiently large p_0 in the last inequality.

Running the assumed algorithm for DELETION TO r -COLORABLE on G decides, by Theorem 6.11 and Theorem 6.13, the satisfiability of σ . Since G can be constructed in polynomial time and has parameter value $|\mathcal{X}| = \lceil \frac{n}{p_0} \rceil p + r$ by Theorem 6.14, we can solve q -SATISFIABILITY in time

$$\begin{aligned} \mathcal{O}^*((2^r - \varepsilon)^{|\mathcal{X}|}) &= \mathcal{O}^*((2^r - \varepsilon)^{\lceil \frac{n}{p_0} \rceil p + r}) \leq \mathcal{O}^*((2^r - \varepsilon)^{\frac{n}{p_0} p}) \\ &\leq \mathcal{O}^*((2^r - \varepsilon)^{\frac{n}{r}} (2^r - \varepsilon)^{\frac{n}{p_0} (2^{r+1} \lceil \log_{2^r} (p_0/r) \rceil + 2^r + 2)}). \end{aligned}$$

We have that $\mathcal{O}^*((2^r - \varepsilon)^{\frac{n}{r}}) \leq \mathcal{O}^*(2^{\delta_1 n})$ for some $\delta_1 < 1$. It remains to upper bound the second factor, we will again use that p_0 can be chosen sufficiently large:

$$\begin{aligned} \mathcal{O}^*((2^r - \varepsilon)^{\frac{n}{p_0} (2^{r+1} \lceil \log_{2^r} (p_0/r) \rceil + 2^r + 2)}) &\leq \mathcal{O}^*((2^r - \varepsilon)^{2^{r+2} \frac{n}{p_0} \log_{2^r} (p_0/r)}) \\ &\leq \mathcal{O}^*((2^r - \varepsilon)^{2^{r+2} \frac{n}{p_0} \log_{2^r} (p_0)}) \leq \mathcal{O}^*\left(\left((2^r - \varepsilon)^{2^{r+2} \frac{\log_{2^r} (p_0)}{p_0}}\right)^n\right) \\ &\leq \mathcal{O}^*(2^{\delta_2 n}), \end{aligned}$$

where δ_2 can be chosen to be arbitrarily close to 0 by making p_0 sufficiently large. By choosing δ_2 small enough so that $\delta := \delta_1 + \delta_2 < 1$, we obtain that q -SATISFIABILITY can be solved in time $\mathcal{O}^*(2^{\delta n})$. Since the choice of p_0 is independent of q , this running time holds for all q and therefore SETH would be false. ◀

► **Corollary 6.15.** *If DELETION TO r -COLORABLE can be solved in time $\mathcal{O}^*((2^r - \varepsilon)^{\text{tc-td}(G)})$ for some $r \geq 2$ and $\varepsilon > 0$, then SETH is false.*

Proof. Follows from Theorem 6.6 and Lemma 4.4. ◀

6.3 Sparse Setting

We again view *solutions* to DELETION TO r -COLORABLE as functions $\varphi: V(G) \rightarrow [r] \cup \{\perp\}$ with the property discussed in the outline, cf. Section 3.

In this subsection, we show how to adapt the lower bound for the dense setting to the sparse setting. We will give the construction in full detail again, but since the principle of constructions is so similar we will only explain how to adapt the previous proofs. One can see that the lower bound is tight by a routine application of dynamic programming on tree decompositions.

► **Theorem 6.16.** *If DELETION TO r -COLORABLE can be solved in time $\mathcal{O}^*((r+1-\varepsilon)^{|X|})$ for some $r \geq 2$ and $\varepsilon > 0$, where X is a modulator to treewidth r , then SETH is false.*

The remainder of this section is devoted to proving Theorem 6.16. Assume that we can solve DELETION TO r -COLORABLE in time $\mathcal{O}^*((r+1-\varepsilon)^{|X|})$ for some $r \geq 2$ and $\varepsilon > 0$. We provide for all clause sizes q , a reduction from q -SATISFIABILITY with n variables to DELETION TO r -COLORABLE with a modulator to treewidth r of size approximately $n \log_{r+1}(2)$. Together with the assumed faster algorithm, this implies a faster algorithm for q -SATISFIABILITY, thus violating SETH. We will consider r to be fixed from now on.

Construction.

Consider a q -SATISFIABILITY instance σ with n variables and m clauses. We enumerate the clauses and refer to them by their number. We pick an integer p_0 which only depends on ε and r ; we will describe how to choose p_0 later. We partition the variables of σ into groups of size at most p_0 , resulting in $t = \lceil n/p_0 \rceil$ groups which will be indexed by i . Next, we choose the smallest integer p such that p is divisible by $r+1$ and $(r+1)^p \frac{p!r!}{(p+r)!} \geq 2^{p_0}$. We will now describe the construction of the DELETION TO r -COLORABLE instance $G = G(\sigma, r, p_0)$.

Comparison to dense setting. The principle behind construction is essentially the same as for the dense setting, cf. Section 6.2, but the gadgets can be simplified. The central twinclasses will simply be single vertices now. Hence, we will not have to distinguish between different numbers of deletions in a twinclass, instead we simply distinguish between whether a vertex is deleted or not. Most notably, this allows us to use thin arrows instead of thick ℓ -arrows and the structure of the considered partial solutions on the central vertices simplifies significantly. The remaining gadgets structurally stay the same, but their size may change.

Construction of central vertices. The central vertices of G form the modulator to treewidth r . For each variable group $i \in [t]$, we create an independent set U_i consisting of p vertices. Furthermore, we again have a central clique $F = \{f_s : s \in [r]\}$ consisting of r vertices that is used to simulate LIST COLORING constraints. A solution $\varphi: V \rightarrow [r] \cup \{\perp\}$ satisfying $\varphi^{-1}(\perp) \cap F = \emptyset$ and $\varphi(f_s) = s$ for all $s \in [r]$ is called a *normalized solution*.

As described in the outline, we only want to consider solutions that delete a fixed number of vertices per group U_i . By using slightly more vertices p than enforced by the base conversion, sufficiently many solutions remain if we define Φ_i as follows:

$$\Phi_i = \{\varphi: U_i \rightarrow [r] \cup \{\perp\} : |\varphi^{-1}(\perp)| = p/(r+1)\}$$

► **Lemma 6.17.** *We have that $|\Phi_i| \geq (r+1)^p \frac{p!r!}{(p+r)!}$ for all $i \in [t]$.*

Proof. Since $\{\varphi: U_i \rightarrow [r] : |\varphi^{-1}(c)| = p/(r+1) \text{ for all } c \in [r] \cup \{\perp\}\} \subseteq \Phi_i$, we see that $|\Phi_i| \geq \binom{p}{\frac{p}{r+1}, \dots, \frac{p}{r+1}} = x$, where x is the central multinomial coefficient. It can be seen that x is a maximum of the function $(c_1, \dots, c_{r+1}) \mapsto \binom{p}{c_1, \dots, c_{r+1}}$. The number of summands in the multinomial theorem $\sum_{c_1 + \dots + c_{r+1} = p} \binom{p}{c_1, \dots, c_{r+1}} = (r+1)^p$ is $\binom{p+r}{p} = \frac{(p+r)!}{p!r!}$, which corresponds to the number of weak compositions of p into $r+1$ parts, and x is one of them. Hence, we see that $|\Phi_i| \geq x \geq (r+1)^p \frac{p!r!}{(p+r)!}$. ◀

Hence, by the choice of p , we can pick for each group $i \in [t]$ an efficiently computable injective mapping $\kappa_i: \{0, 1\}^{p_0} \rightarrow \Phi_i$ that maps truth assignments of the i -th variable group to partial solutions on U_i with the desired structure.

Budget. The budget $b = |\mathcal{P}| + tp/(r+1)$ consists of two parts again. The first part $|\mathcal{P}|$ is allocated to a vertex-disjoint packing \mathcal{P} of $(r+1)$ -critical graphs and the second part $tp/(r+1)$ is allocated to the central vertices.

Enforcing structure on central vertices. For every group $i \in [t]$ and subset $S \subseteq U_i$ with $|S| = \frac{r}{r+1}p + 1$, we add an $(r+1)$ -critical graph, denoted $L_{i,S}$, consisting of at least $|S|$ vertices. For every $u \in S$, we pick a private vertex v in $L_{i,S}$ and add a thin arrow from u to v . We create $1 + tp/(r+1) = 1 + (b - |\mathcal{P}|)$ copies of $L_{i,S}$ and the incident arrows. This concludes the construction of the structure gadget.

Decoding gadgets. For the j -th clause, group $i \in [t]$, partial solution $\varphi_i \in \Phi_i$, we construct a decoding gadget Y_{i,φ_i}^j as follows. The gadget Y_{i,φ_i}^j consists of a large independent set joined to a K_r , i.e., adding all edges between both sets. In other words, Y_{i,φ_i}^j is a complete $(r+1)$ -partite graph with one large independent set and all other independent sets in the partition are singletons. The large independent set consists of $p+1$ vertices, where one of these vertices is distinguished and denoted by \hat{y}_{i,φ_i}^j . This concludes the construction of Y_{i,φ_i}^j .

For the j -th clause, group $i \in [t]$, partial solution $\varphi_i \in \Phi_i$, vertex $u \in U_i$, we pick a private vertex $v \neq \hat{y}_{i,\varphi_i}^j$ in the large independent set of Y_{i,φ_i}^j and add the decoding gadget $B_{\{\varphi_i(u)\} \setminus \{\perp\}}(\{u\}, v)$ and denote this instance of the decoding gadget by $W_{i,\varphi_i,u}^j$. Observe that in the dense setting we did not attach decoding gadgets to twinclasses U with $\varphi_i(U) \neq [r]$, whereas there is no such exception in the sparse setting.

Clause gadgets. For the j -th clause, we add an $(r+1)$ -critical graph, denoted Z^j , consisting of at least $q2^{p_0}$ vertices. For every group $i \in [t]$ and partial solution $\varphi_i \in \Phi_i$ such that $\kappa^{-1}(\varphi_i)$ is a partial truth assignment satisfying the j -th clause, we pick a private vertex v in Z^j and add a thin arrow from \hat{y}_{i,φ_i}^j to v . We ensured that Z^j is large enough so that we can always pick such a private vertex. This concludes the construction of $G(\sigma, r, p_0)$, cf. Figure 11.

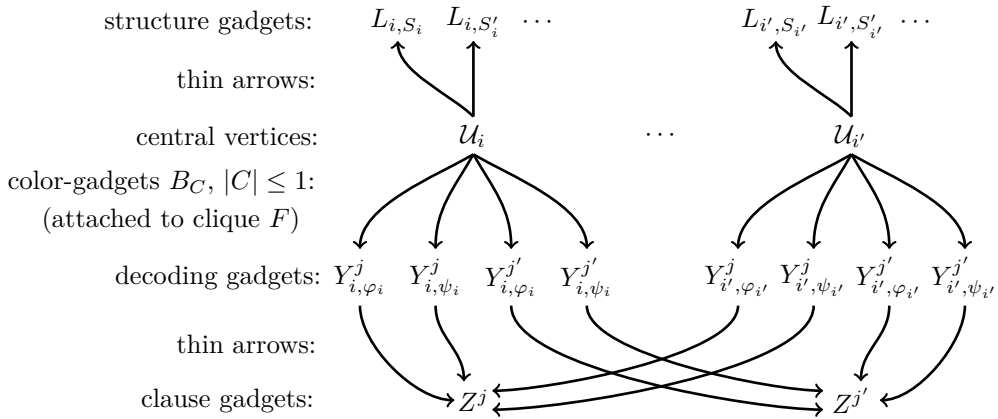

■ **Figure 11** An overview of the construction of the graph $G(\sigma, r, p_0)$ for the case $r = 2$.

Packing. We construct a vertex-disjoint packing \mathcal{P} of $(r+1)$ -critical graphs that fully explains the budget outside of the central vertices. For every thin arrow from u to v in the construction, we add the K_{r+1} induced by the deletion edge incident to the head v of the arrow to the packing \mathcal{P} . Every $B_{\{\varphi_i(u)\} \setminus \{\perp\}}(\{u\}, v)$ contains, depending on whether

$\varphi_i(u) \neq \perp$ or not, r or $r + 1$ disjoint K_{r+1} corresponding to deletion edges, one of them being incident to v , and we add all these K_{r+1} to the packing \mathcal{P} . Finally, for every Y_{i,φ_i}^j , we add the K_{r+1} induced by \hat{y}_{i,φ_i}^j and the K_r of Y_{i,φ_i}^j to the packing \mathcal{P} . Since, we have added only $(r + 1)$ -critical graphs to \mathcal{P} , the cost of \mathcal{P} is simply $|\mathcal{P}|$.

► **Theorem 6.18.** *Let σ be a q -SATISFIABILITY instance with n variables and m clauses. Let $G = G(\sigma, r, p_0)$ and \mathcal{P} be the graph and packing as constructed above and let $b = |\mathcal{P}| + tp/(r+1)$. If σ has a satisfying truth assignment τ , then there is a solution φ of the DELETION TO r -COLORABLE instance (G, b) .*

Proof sketch. The proof is very similar to the proof of Theorem 6.11. Let τ_i be the partial truth assignment of variable group i induced by τ . We set $\varphi|_{U_i} = \kappa_i(\tau_i) \in \Phi_i$ for all i and $\varphi(f_s) = s$ for all $s \in [r]$. By definition of Φ_i , only the budget $|\mathcal{P}|$ for the packing \mathcal{P} remains, hence on every graph in \mathcal{P} , we can perform exactly one deletion and nowhere else.

We propagate deletions along thin arrows and extend the solution across decoding gadgets $B_{\{\varphi_i(u)\} \setminus \{\perp\}}(\{u\}, v)$ as before. For every Y_{i,φ_i}^j , we delete the distinguished vertex \hat{y}_{i,φ_i}^j and for every j -th clause, group i , and solution $\varphi_i \neq \psi_i \in \Phi_i$, we pick one of the vertices in the K_r of Y_{i,φ_i}^j and delete it. This concludes the description of the deletions.

It remains to show that the remaining graph can be properly r -colored. Comparing to the proof of Theorem 6.11, the arguments change slightly for $L_{i,S}$ and Y_{i,ψ_i}^j . Consider some copy of some $L_{i,S}$, due to $|S| + |\varphi^{-1}(\perp) \cap U_i| = (\frac{r}{r+1}p + 1) + p/(r+1) = p + 1 > |U_i|$ there is a least one $u \in S$ with $\varphi(u) = \perp$. Therefore, the thin arrow from u to $L_{i,S}$ propagates a deletion to $L_{i,S}$ and this $(r + 1)$ -critical graph is resolved.

Consider some Y_{i,ψ_i}^j with $\psi_i \in \Phi_i$. If $\psi_i \neq \varphi_i$, the arguments works as in the proof of Theorem 6.11. If $\psi_i = \varphi_i$, then we claim that the large independent set of Y_{i,φ_i}^j is fully deleted. The large independent set has size $p + 1 = |U_i| + 1$. We distributed one deletion to \hat{y}_{i,φ_i}^j and all other vertices v in the large independent set are hit by some $W_{i,\varphi_i,u}^j$, $u \in U_i$. Since $\varphi_i(u) \in \{\varphi_i(u)\}$, we see that $W_{i,\varphi_i,u}^j = B_{\{\varphi_i(u)\} \setminus \{\perp\}}(\{u\}, v)$ propagates a deletion to v due to Lemma 6.10. So, the large independent set is indeed fully deleted and thereby the complete $(r + 1)$ -partite graph is resolved. ◀

► **Theorem 6.19.** *Let σ be a q -SATISFIABILITY instance with n variables and m clauses. Let $G = G(\sigma, r, p_0)$ and \mathcal{P} be the graph and packing as constructed above and let $b = |\mathcal{P}| + tp/(r+1)$. If φ is a solution of the DELETION TO r -COLORABLE instance (G, b) , then $|\varphi^{-1}(\perp)| = b$. Furthermore, there is a normalized solution ψ with $|\psi^{-1}(\perp)| = |\varphi^{-1}(\perp)| = b$ and $\psi|_{U_i} \in \Phi_i$ for all $i \in [t]$.*

Proof. Since the packing \mathcal{P} consists only of $(r + 1)$ -critical graphs, at least $|\mathcal{P}|$ deletions must be performed by φ on these graphs. The remainder of the deletions is performed on the central vertices. Suppose that there is some group $i \in [t]$ such that $|\varphi^{-1}(\perp) \cap U_i| < p/(r + 1)$, then there exists an $S \subseteq U_i$ with $|S| = \frac{r}{r+1}p + 1$ and $S \cap \varphi^{-1}(\perp) = \emptyset$. Consider some copy of the corresponding $L_{i,S}$ and notice that all thin arrows leading to $L_{i,S}$ are passive unless we pay for extra deletions. Since $L_{i,S}$ is an $(r + 1)$ -critical graph that does not belong to \mathcal{P} , we must perform one additional deletion per copy of $L_{i,S}$. There are $1 + tp/(r + 1) > b - |\mathcal{P}|$ copies of $L_{i,S}$, hence this would exceed the available budget. So, we can conclude that $|\varphi^{-1}(\perp) \cap U_i| \geq p/(r + 1)$ for all groups $i \in [t]$.

Together with $|\varphi^{-1}(\perp)| \leq b = |\mathcal{P}| + tp/(r + 1)$, we see that $|\varphi^{-1}(\perp)| = b$ and $|\varphi^{-1}(\perp) \cap U_i| = p/(r + 1)$ for all $i \in [t]$. Hence, φ cannot delete any vertex of the central clique F and by permuting the colors, we obtain the desired normalized solution ψ with $\psi|_{U_i} \in \Phi_i$. ◀

► **Theorem 6.20.** *Let σ be a q -SATISFIABILITY instance with n variables and m clauses. Let $G = G(\sigma, r, p_0)$ and \mathcal{P} be the graph and packing as constructed above and let $b = |\mathcal{P}| + tp/(r+1)$. If the DELETION TO r -COLORABLE instance (G, b) has a solution φ , then σ has a satisfying truth assignment τ .*

Proof sketch. This proof is very similar to the proof of Theorem 6.13. We first invoke Theorem 6.19, which implies that $|\varphi^{-1}(\perp)| = b$ and allows us to assume that φ is a normalized solution with $\varphi_i := \varphi|_{U_i} \in \Phi_i$. We only diverge from the proof of Theorem 6.13 when proving that $\varphi(\hat{y}_{i,\psi_i}^j) = \perp$ only if $\psi_i = \varphi_i$.

As before, \hat{y}_{i,ψ_i}^j may only be deleted if the large independent set of Y_{i,ψ_i}^j is fully deleted. Now, consider some $\psi_i \in \Phi_i \setminus \{\varphi_i\}$. We will distinguish two cases.

1. Suppose that $\psi_i^{-1}(\perp) \neq \varphi_i^{-1}(\perp)$. Due to $\varphi_i, \psi_i \in \Phi_i$, there exists some $u \in U_i$ with $\psi_i(u) = \perp$ and $\varphi_i(u) \neq \perp$. The associated $W_{i,\psi_i,u}^j = B_\emptyset(\{u\}, v)$ cannot propagate a deletion to v in this case by Lemma 6.10 and hence the large independent set of Y_{i,ψ_i}^j is not fully deleted.
2. Suppose that $\psi_i^{-1}(\perp) = \varphi_i^{-1}(\perp)$, then $\psi_i \neq \varphi_i$ implies that there exists some $u \in U_i \setminus \psi_i^{-1}(\perp) = U_i \setminus \varphi_i^{-1}(\perp)$ with $\psi_i(u) \neq \varphi_i(u)$. Again, the associated $W_{i,\psi_i,u}^j = B_{\{\psi_i(u)\}}(\{u\}, v)$ cannot propagate a deletion to v in this case by Lemma 6.10 and, again, the large independent set of Y_{i,ψ_i}^j is not fully deleted.

This proves the claim regarding the deletion of \hat{y}_{i,ψ_i}^j . ◀

► **Theorem 6.21.** *Let $G = G(\sigma, r, p_0)$ be the graph as constructed above. The set $X = \left(\bigcup_{i=1}^t U_i\right) \cup \{f_s : s \in [r]\}$ is a modulator for G of size $tp + r$ to treewidth r , i.e., $|X| = tp + r$ and $\text{tw}(G - X) \leq r$.*

Proof sketch. The proof is very similar to the proof of Theorem 6.14. The notable difference is that all thick arrows are replaced by thin arrows, but this does not affect the treewidth. The connected components corresponding to a clause have for the sake of the omniscient cops-and-robber-game the same structure as before, only the number of $W_{i,\varphi_i,u}^j$ incident to some Y_{i,φ_i}^j changes. ◀

Proof of Theorem 6.16. Suppose there is some $r \geq 2$ and $\varepsilon > 0$ such that DELETION TO r -COLORABLE can be solved in time $\mathcal{O}^*((r+1-\varepsilon)^{|X|})$, where X is a modulator to treewidth r . We will show that there exists a $\delta < 1$, such that for any q , we can solve q -SATISFIABILITY in time $\mathcal{O}^*(2^{\delta n})$ where n is the number of variables. This contradicts SETH and hence implies the desired lower bound.

Given a q -SATISFIABILITY instance σ , we construct the graph $G = G(\sigma, r, p_0)$, where p_0 depends only on r and ε and will be chosen later. We can consider r , ε , and q as constants, hence also $p_0 = p_0(r, \varepsilon)$ and $p = p(p_0)$ are constant. As in the proof of Theorem 6.6, we can again see that G has polynomial size and can be constructed in polynomial time. Furthermore, we can also obtain a tree decomposition of $G' := G - X$ from the proof of Theorem 6.21 in polynomial time.

In the construction of $G(\sigma, r, p_0)$, we chose p as the smallest integer that is divisible by $(r+1)$ and satisfies $(r+1)^p \frac{p!r!}{(p+r)!} \geq 2^{p_0}$. We let $\gamma = \lceil \log_{r+1}(2^{p_0}) \rceil$ and show that $p \leq \gamma + 3r \lceil \log_{r+1} \gamma \rceil + (r+1)$. The summand $(r+1)$ will ensure divisibility. We compute

that

$$\begin{aligned} (r+1)^p \frac{p!r!}{(p+r)!} &\geq (r+1)^p (2p)^{-r} = \frac{(r+1)^\gamma \gamma^{3r}}{2^r (\gamma + 3r \lceil \log_{r+1} \gamma \rceil + (r+1))^r} \geq \frac{(r+1)^\gamma \gamma^{3r}}{2^r (5r\gamma)^r} \\ &= (r+1)^\gamma \frac{\gamma^{2r}}{(10r)^r} \geq (r+1)^\gamma \geq 2^{p_0}, \end{aligned}$$

where we use throughout that p_0 and hence γ is sufficiently large.

Running the assumed algorithm for DELETION TO r -COLORABLE on G decides, by Theorem 6.11 and Theorem 6.13, the satisfiability of σ . Since G can be constructed in polynomial time, we can solve q -SATISFIABILITY in time

$$\begin{aligned} \mathcal{O}^*((r+1-\varepsilon)^{|X|}) &= \mathcal{O}^*((r+1-\varepsilon)^{\lceil \frac{n}{p_0} \rceil p+r}) \leq \mathcal{O}^*((r+1-\varepsilon)^{\frac{n}{p_0} p}) \\ &\leq \mathcal{O}^*((r+1-\varepsilon)^{\frac{n}{p_0} \log_{r+1}(2^{p_0})} (r+1-\varepsilon)^{\frac{n}{p_0} (3r \lceil \log_{r+1}(\gamma) \rceil + r+2)}). \end{aligned}$$

For the first factor, we see that

$$\mathcal{O}^*((r+1-\varepsilon)^{\frac{n}{p_0} \log_{r+1}(2^{p_0})}) = \mathcal{O}^*((r+1-\varepsilon)^{n \log_{r+1}(2)}) \leq \mathcal{O}^*(2^{\delta_1 n}),$$

where $\delta_1 < 1$. We bound the exponent in the second factor as follows

$$\begin{aligned} \frac{n}{p_0} (3r \lceil \log_{r+1}(\gamma) \rceil + r+2) &\leq \frac{n}{p_0} (6r \log_{r+1}(\gamma)) \leq \frac{n}{p_0} (6r \log_{r+1}(p_0^2)) \\ &= \frac{n}{p_0} (12r \log_{r+1}(p_0)) = 12rn \frac{\log_{r+1}(p_0)}{p_0}, \end{aligned}$$

where we use $\gamma \leq p_0^2$ in the second inequality. This bound shows that

$$\mathcal{O}^*((r+1-\varepsilon)^{\frac{n}{p_0} (3r \lceil \log_{r+1}(\gamma) \rceil + r+2)}) \leq \mathcal{O}^*\left(\left((r+1-\varepsilon)^{12r \frac{\log_{r+1}(p_0)}{p_0}}\right)^n\right) \leq \mathcal{O}^*(2^{\delta_2 n}),$$

where we can choose δ_2 arbitrarily close to 0 by making p_0 large enough.

By choosing δ_2 so that $\delta := \delta_1 + \delta_2 < 1$, we obtain that q -SATISFIABILITY can be solved in time $\mathcal{O}^*(2^{\delta n})$. Since the choice of p_0 is independent of q , we obtain this running time for all q and hence SETH has to be false. \blacktriangleleft

► Corollary 6.22. *If DELETION TO r -COLORABLE can be solved in time $\mathcal{O}^*((r+1-\varepsilon)^{\text{td}(G)})$ for some $r \geq 2$ and $\varepsilon > 0$, then SETH is false.*

Proof. Follows from Theorem 6.16 and Corollary 4.2. \blacktriangleleft

7 Lower Bound for Vertex Cover

In Section 7.1 we prove the lower bound for VERTEX COVER parameterized by a modulator to pathwidth 2 and in Section 7.2 we show that this lower bound also implies lower bounds for MAXIMUM CUT and K_r -FREE DELETION. Note that VERTEX COVER is just another name for DELETION TO 1-COLORABLE, but the case $r = 1$ is not covered by the previous lower bounds.

7.1 Lower Bound

This section is devoted to establishing the lower bound for VERTEX COVER when parameterized by a modulator to pathwidth 2, i.e., Theorem 7.1. For VERTEX COVER, we do not need to convert between different bases in the running time. By additionally reducing from q -HITTING SET instead of q -SATISFIABILITY, we obtain a significantly simplified reduction that does not require the trick of Cygan et al. [11]. We construct a graph so that each vertex in the modulator corresponds to an element in the universe of the q -HITTING SET instance. We construct gadgets of pathwidth at most 2 that simulate the q -HITTING SET constraints on the modulator. Using Theorem 2.4, this implies the desired lower bound for VERTEX COVER if SETH is true. VERTEX COVER can be solved in time $\mathcal{O}^*(2^{\text{cw}(G)})$ by an algorithm of Courcelle et al. [7] and by Corollary 4.2 and Theorem 4.3 this implies that the obtained lower bound is tight. So, in the exceptional case of VERTEX COVER, the complexity when parameterized by clique-width is already explained by the sparse setting and we do not need to consider twinclasses.

► **Theorem 7.1.** *If VERTEX COVER can be solved in time $\mathcal{O}^*((2 - \varepsilon)^{|X|})$ for some $\varepsilon > 0$, where X is a modulator to pathwidth at most 2, then SETH is false.*

Suppose that we can solve VERTEX COVER in time $\mathcal{O}^*((2 - \varepsilon)^{|X|})$ for some $\varepsilon > 0$. Fix an integer q and let $(U = \{u_1, \dots, u_n\}, \mathcal{F})$ be a q -HITTING SET instance with $|\mathcal{F}| = m$ sets of size at most q each, and budget t . The elements of the j -th set in \mathcal{F} , $j \in [m]$, are denoted by $\{u_1^j, u_2^j, \dots, u_{p_j}^j\}$, $p_j \leq q$. We will reduce (U, \mathcal{F}) to a VERTEX COVER instance $G = G(U, \mathcal{F})$ with budget b , which will be defined later, and which admits a modulator to pathwidth 2 of size n .

Construction. We create an independent set of n central vertices $W = \{w_1, \dots, w_n\}$. The vertices in W that are chosen by a vertex cover will correspond to the hitting set. For the j -th set $\{u_1^j, u_2^j, \dots, u_{p_j}^j\} \in \mathcal{F}$, $p_j \leq q$, we create a triangle path, denoted by P^j : The triangle path P^j consists of p_j vertices a_s^j , where $s \in [p_j]$, and $2p_j + 2$ vertices b_s^j , where $s \in [2p_j + 2]$, such that $a_s^j, b_{2s}^j, b_{2s+1}^j$ form a triangle for all $s \in [p_j]$ and $b_1^j, b_2^j, \dots, b_{2p_j+2}^j$ form a path, see Figure 12. We connect P^j to W by adding, for all $s \in [p_j]$, an edge between a_s^j and $w_{s'}$, where $s' \in [n]$ so that $u_{s'} = u_s^j$. The key property of the triangle path P^j is that it costs more to cover P^j if no vertex in $N(P^j) \subseteq W$ is inside the vertex cover. Since the budget constraint will be tight, this implies that a vertex cover has to take at least one vertex in each $N(P^j)$.

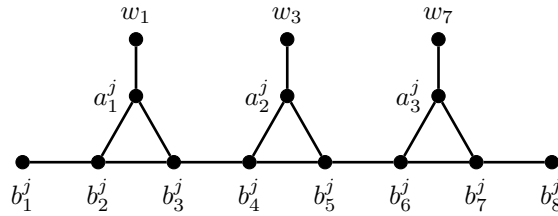

■ **Figure 12** The triangle path P^j , where the j -th set consists of u_1, u_3 , and u_7 .

► **Lemma 7.2.** *Let $j \in [m]$ and Y be a vertex cover of G , then $|Y \cap P^j| \geq 2p_j$ and:*

1. *If $Y \cap N(P^j) = \emptyset$, then $|Y \cap P^j| \geq 2p_j + 1$.*
2. *If $|Y \cap N(P^j)| \geq 1$, then there is a vertex cover Y' with $Y \setminus P^j = Y' \setminus P^j$ and $|Y' \cap P^j| \leq 2p_j$.*

Proof. Let Y be a vertex cover of G . Consider some P^j and notice that the triangles $\{a_s^j, b_{2s}^j, b_{2s+1}^j\}$, $s \in [p_j]$, are vertex-disjoint and any vertex cover has to contain at least 2 vertices in each triangle. Hence, $|Y \cap P^j| \geq 2p_j$ for all $j \in [m]$.

Now, suppose that $Y \cap N(P^j) = \emptyset$ for some $j \in [m]$. By assumption, the p_j edges between P^j and W are not covered by $Y \cap W$ and hence Y must contain $\{a_1^j, a_2^j, \dots, a_{p_j}^j\}$. Hence, Y contains all a -vertices of P^j and after removing these from P^j a path on $2p_j + 2$ vertices remains. Therefore, Y has to contain at least $p_j + 1$ vertices of this path. In total, Y contains at least $2p_j + 1$ vertices of P^j .

Lastly, suppose that Y is a vertex cover with $|Y \cap N(P^j)| \geq 1$ for some $j \in [m]$. Let $s^* \in [p_j]$ be the smallest integer such that the neighbor in W of $a_{s^*}^j$ belongs to Y . We define $Y'_P = \{a_s^j : s \in [p_j] \setminus \{s^*\}\} \cup \{b_{2s}^j : s \in [s^*]\} \cup \{b_{2s+1}^j : s \in [p_j] \setminus [s^* - 1]\}$ and claim that Y'_P is a vertex cover of $G[P^j]$. Notice that Y'_P contains 2 vertices in each triangle $\{a_s^j, b_{2s}^j, b_{2s+1}^j\}$, $s \in [p_j]$, and the edges $\{b_s^j, b_{s+1}^j\}$ are covered by the b^j with an even subscript if $s \leq 2s^*$ and otherwise by the b^j with an odd subscript. Hence, Y'_P is a vertex cover of $G[P^j]$. We define $Y' = (Y \setminus P^j) \cup Y'_P$. All edges between P^j and W are covered by $Y' \cap P^j$ except the edge incident to $a_{s^*}^j$ which is covered by $Y' \cap W$ by assumption. Therefore, Y' is a vertex cover of G with $Y \setminus P^j = Y' \setminus P^j$ and $|Y' \cap P^j| = |Y'_P| = (p_j - 1) + s^* + (p_j + 1 - s^*) = 2p_j$. \blacktriangleleft

► **Lemma 7.3.** *Let $q \in \mathbb{N}$ and (U, \mathcal{F}) be a q -HITTING SET instance with $|U| = n$ and $|\mathcal{F}| = m$. There is a hitting set for (U, \mathcal{F}) of size at most t if and only if $G = G(U, \mathcal{F})$ has a vertex cover of size at most $b = t + 2 \sum_{j \in [m]} p_j$.*

Proof. Let H be a hitting set of (U, \mathcal{F}) of size $|H| \leq t$. Let $Y_W = \{w_i \in W : u_i \in H\}$ and consider $Y = Y_W \cup \bigcup_{j=1}^m P^j$. The set Y is certainly a vertex cover of G and by applying the second part of Lemma 7.2 for every $j \in [m]$, which is possible since H was a hitting set, we obtain a vertex cover Y' with $Y' \cap W = Y_W$ and $|Y' \cap P^j| \leq 2p_j$ for all $j \in [m]$. Hence, Y' is a vertex cover of G of size at most $t + 2 \sum_{j \in [m]} p_j$.

For the other direction, let Y be a vertex cover of G of size at most $t + 2 \sum_{j \in [m]} p_j$. Due to Lemma 7.2, we have that $|Y \cap P^j| \geq 2p_j$ for all $j \in [m]$. Define $J_Y = \{j \in [m] : |Y \cap P^j| > 2p_j\}$ and $Y_W = Y \cap W$. The size constraint implies that $|J_Y| + |Y_W| \leq t$. If $J_Y = \emptyset$, then by the first part of Lemma 7.2 we must have that $Y \cap N(P^j) \neq \emptyset$ for all $j \in [m]$. By the construction of G this means that $H = \{u_i \in U : w_i \in Y_W\}$ must be a hitting set for (U, \mathcal{F}) of size at most t .

If $J_Y \neq \emptyset$, then take some $j \in J_Y$ and some $w_i \in N(P^j)$ and construct the vertex cover $Y' = Y \cup \{w_i\}$. By the second part of Lemma 7.2, there is a vertex cover Y'' with $Y'' \setminus P^j = Y' \setminus P^j$ and $|Y'' \cap P^j| \leq 2p_j$. This implies that $|Y''| = |Y| + 1 + |Y'' \cap P^j| - |Y \cap P^j| \leq |Y| + 1 + 2p_j - (2p_j + 1) = |Y|$ and $J_{Y''} = J_Y \setminus \{j\}$. We replace Y by Y'' and repeat this argument until $J_Y = \emptyset$ and then obtain the desired hitting set by the previous argument. \blacktriangleleft

► **Lemma 7.4.** *It holds that $\text{pw}(P^j) = \text{tw}(P^j) = 2$ for all $j \in [m]$.*

Proof. We construct a path decomposition \mathcal{T} for P^j of width 2. Let \mathcal{T} be a path on $2p_j + 1$ vertices $t_1, t_2, \dots, t_{2p_j+1}$. For $s \in [p_j + 1]$, define the bag $\mathbb{B}_{t_{2s-1}} = \{b_{2s-1}^j, b_{2s}^j\}$, and for $s \in [p_j]$ define bags $\mathbb{B}_{t_{2s}} = \{a_s^j, b_{2s}^j, b_{2s+1}^j\}$. Using these bags, \mathcal{T} is a path decomposition of width 2 for P^j . Since P^j is neither a linear forest nor a forest, we have that $\text{pw}(P^j) \geq 2$ and $\text{tw}(P^j) \geq 2$. \blacktriangleleft

Proof of Theorem 7.1. Suppose that VERTEX COVER can be solved in time $\mathcal{O}^*((2 - \varepsilon)^{|X|})$ for some $\varepsilon > 0$, where X is a modulator to pathwidth at most 2. We argue that we can then solve q -HITTING SET in time $\mathcal{O}^*((2 - \varepsilon)^n)$ for all q , thus violating SETH by Theorem 2.4.

Fix an arbitrary integer $q \geq 1$ and a q -HITTING SET instance (U, \mathcal{F}) with $|U| = n$ and $|\mathcal{F}| = m$. From (U, \mathcal{F}) construct the graph $G = G(U, \mathcal{F}) = (V, E)$ as described above in polynomial time. Let $X = W$, then $G - X$ is the disjoint union of the P^j , $j \in [m]$, and by Lemma 7.4 the pathwidth of $G - X$ is 2. So, X is a modulator to pathwidth at most 2 of size $|X| = |W| = n$. Running the VERTEX COVER algorithm on G with budget $b = t + 2 \sum_{j \in [m]} p_j$ and modulator X solves q -HITTING SET by Lemma 7.3. As the size of G is polynomial in $|U| = n$ and $|\mathcal{F}| = m$, the resulting running time is $\mathcal{O}^*((2 - \varepsilon)^n)$ and hence SETH must be false. \blacktriangleleft

► **Corollary 7.5.** *If VERTEX COVER can be solved in time $\mathcal{O}^*((2 - \varepsilon)^{\text{td}(G)})$ for some $\varepsilon > 0$, then SETH is false.*

Proof. Follows from Theorem 7.1 and Corollary 4.2 \blacktriangleleft

7.2 Further Consequences

► **Corollary 7.6.** *If MAXIMUM CUT can be solved in time $\mathcal{O}^*((2 - \varepsilon)^{|X|})$ for some $\varepsilon > 0$, where X is a modulator to treewidth at most 2, then SETH is false.*

Proof. We use a well-known reduction from VERTEX COVER to MAXIMUM CUT by Garey et al. [28]. Let $G = (V, E)$ be a graph. We construct another graph $G' = (V', E')$ as follows: The vertex set is given by $V' = V \cup \{x\} \cup \{e_u, e_v : e = \{u, v\} \in E\}$. The vertex x is adjacent to all $v \in V$ and for every edge $e = \{u, v\} \in E$, we add the five edges $\{x, e_u\}$, $\{x, e_v\}$, $\{e_u, e_v\}$, $\{e_u, u\}$, and $\{e_v, v\}$ to E' . Now, G contains a vertex cover of size at most $|V(G)| - b$ if and only if G' contains a cut of size at least $4|E(G)| + b$.

Let X be a modulator to treewidth at most 2 for G , i.e., $\text{tw}(G - X) \leq 2$. We claim that $X' = X \cup \{x\}$ is a modulator to treewidth at most 2 for G' , i.e., $\text{tw}(G' - X') \leq 2$. After removing X' only edges of the form $\{e_u, e_v\}$, $\{e_u, u\}$, and $\{e_v, v\}$ remain. Notice that $G' - X'$ can be obtained from $G - X$ by subdividing each edge twice, i.e., replacing each edge by a path of length 3. It is well-known that subdividing edges does not affect the treewidth, hence we have that $\text{tw}(G' - X') = \text{tw}(G - X) \leq 2$.

If we can solve MAXIMUM CUT in time $\mathcal{O}^*((2 - \varepsilon)^{|X|})$ for some $\varepsilon > 0$, where X is a modulator to treewidth at most 2, then we can also solve VERTEX COVER in time $\mathcal{O}^*((2 - \varepsilon)^{|X|})$ by using the discussed polynomial-time reduction and noting that any modulator to pathwidth at most 2 is also a modulator to treewidth at most 2. Hence, SETH must be false by Theorem 7.1. \blacktriangleleft

► **Corollary 7.7.** *If MAXIMUM CUT can be solved in time $\mathcal{O}^*((2 - \varepsilon)^{\text{td}(G)})$ for some $\varepsilon > 0$, then SETH is false.*

Proof. Follows from Corollary 7.6 and Corollary 4.2. \blacktriangleleft

► **Corollary 7.8.** *Let $r \geq 3$. If K_r -FREE DELETION can be solved in time $\mathcal{O}^*((2 - \varepsilon)^{|X|})$ for some $\varepsilon > 0$, where X is a modulator to treewidth at most $r - 1$, then SETH is false.*

Proof. Let $G = (V, E)$ be a VERTEX COVER instance. We construct $G' = (V', E')$ by using a classical trick and replacing each edge of G by a clique on r vertices which is just like the deletion edges for the DELETION TO r -COLORABLE lower bounds. It can be seen that G has a vertex cover of size at most b if and only if there is a set $Y \subseteq V'$, $|Y| \leq b$, such that $G' - Y$ is K_r -free.

If X is a modulator to treewidth at most 2 for G , i.e., $\text{tw}(G - X) \leq 2$, then we claim that X is also a modulator to treewidth at most $r - 1$ for G' . Let \mathcal{T} be a tree decomposition of

width 2 for $G - X$ with bags \mathbb{B}_t , $t \in V(\mathcal{T})$. We construct a tree decomposition \mathcal{T}' of width $r - 1$ for $G' - X$ as follows. We start with the tree decomposition \mathcal{T} of $G - X$. For every edge $e \in E(G - X)$ there is a $t \in V(\mathcal{T})$ such that $e \subseteq \mathbb{B}_t$ and to t we attach a degree-1 node t^* and the bag of t^* contains the r -clique that replaced edge e . Hence, every edge of $G' - X$ is captured in some bag of \mathcal{T}' and \mathcal{T}' is a tree decomposition of width $r - 1$.

Since the construction of G' can be performed in polynomial time and since the size of the modulator does not change, the result follows by Theorem 7.1. \blacktriangleleft

► **Corollary 7.9.** *Let $r \geq 3$. If K_r -FREE DELETION can be solved in time $\mathcal{O}^*((2 - \varepsilon)^{\text{td}(G)})$ for some $\varepsilon > 0$, then SETH is false.*

Proof. Follows from Corollary 7.8 and Corollary 4.2. \blacktriangleleft

The lower bounds obtained for VERTEX COVER, MAXIMUM CUT, and K_r -FREE DELETION are tight in the sense that we have algorithms with matching running time by straightforward dynamic programming on tree decompositions.

8 Lower Bound for Dominating Set

In the sparse setting, the optimal base, assuming SETH, for DOMINATING SET parameterized by treewidth is 3 based on results by Lokshtanov et al. [46] and van Rooij et al. [58]. Van Geffen et al. [57] have shown that base 3 is already optimal for the much more restrictive parameter cutwidth by slightly modifying the construction of Lokshtanov et al. [46].

For the dense setting, the optimal base for DOMINATING SET parameterized by clique-width is 4 based on results by Bodlaender et al. [2] and Katsikarelis et al. [41]. The lower bound of Katsikarelis et al., as is usual, already applies to the more restrictive linear-clique-width. We improve upon this lower bound by showing that similar to the sparse setting, already a simple dense variant of cutwidth, i.e. twinclass-cutwidth, requires base 4.

We provide a straightforward tight lower bound for DOMINATING SET parameterized by twinclass-cutwidth by observing that solving DOMINATING SET on G essentially means solving TOTAL DOMINATING SET on $G/\Pi_{tc}(G)$, assuming that there are no twinclasses of size 1, and providing a lower bound for TOTAL DOMINATING SET parameterized by cutwidth based on the methods of Lokshtanov et al. [46] and van Geffen et al. [57].

For the remainder of this section assume without loss of generality that G is connected and consists of at least two vertices. We define the graph G' by $V(G') = V(G) \cup \{v' : v \in V(G)\}$ and $E(G') = E(G) \cup \{\{u, v'\}, \{u', v\}, \{u', v'\} : \{u, v\} \in E(G)\}$, i.e., we obtain G' from G by creating a false twin of each vertex, hence G' has no twinclass of size 1.

► **Lemma 8.1.** *It holds that $\text{tc-ctw}(G') \leq \text{ctw}(G)$.*

Proof. We begin by showing that $u \neq v \in V(G)$ are twins in G' if and only if u and v are false twins in G . First, suppose that $\{u, v\} \in E(G)$. By construction of G' , this implies that $u' \in N_{G'}(v) \setminus N_{G'}(u)$ and hence u and v cannot be twins in G' in this case. If u and v are false twins in G' , then $N_G(u) = N_{G'}(u) \cap V(G) = N_{G'}(v) \cap V(G) = N_G(v)$, so u and v are false twins in G as well. If u and v are false twins in G , then $N_{G'}(u) = N_G(u) \cup \{w' : w \in N_G(u)\} = N_G(v) \cup \{w' : w \in N_G(v)\} = N_{G'}(v)$, so u and v are false twins in G' as well.

By construction of G' , the two vertices v and v' are false twins in G' for all $v \in V(G)$. Together with the previous argument and since the twin relation is an equivalence relation, this shows that every twinclass U' of G' has the form $U' = U \cup \{v' : v \in U\}$, where U is a false twinclass of G . For each false twinclass U of G , pick a vertex $v_U \in U$ and consider the map $\Pi_{tc}(G') \ni U' = U \cup \{v' : v \in U\} \mapsto v_U \in U \subseteq V(G)$. If U' and W' are adjacent

twinclasses of G' , then the vertices v_U and v_W have to be adjacent in G . Hence, we can view $G'/\Pi_{tc}(G')$ as a subgraph of G and see that $tc\text{-}ctw(G') = ctw(G'/\Pi_{tc}(G')) \leq ctw(G)$. ◀

► **Lemma 8.2.** *G' has a dominating set of size at most b if and only if G has a total dominating set of size at most b .*

Proof. \Rightarrow : Let X' be a dominating set of G' . If $|X' \cap \{v, v'\}| = 1$ for some $v \in V(G)$, then we can assume without loss of generality that $v \in X'$. Suppose that $|X' \cap \{v, v'\}| = 2$ for some $v \in V(G)$. If $X' \cap N_{G'}(v) = X' \cap N_{G'}(v') = \emptyset$, then choose some $w \in N_{G'}(v) \cap V(G) = N_{G'}(v') \cap V(G)$, which exists due to our assumptions about G , and consider $X'' = (X' \setminus \{v'\}) \cup \{w\}$. Otherwise, consider $X'' = X' \setminus \{v'\}$. In either case, $|X''| \leq |X'|$ and we claim that X'' is still a dominating set of G' . Only vertices inside $N_{G'}[v']$ may not be dominated anymore. The vertex v' is still dominated, because there is some $w \in X'' \cap N_{G'}(v) = X'' \cap N_{G'}(v')$. The vertices in $N_{G'}(v')$ are still dominated, because $v \in X''$ and $N_{G'}(v) = N_{G'}(v')$. Hence, X'' is a dominating set of G' .

By repeating this argument, we obtain a dominating set X of G' with $|X| \leq |X'|$ and $X \subseteq V(G)$. For every $v \in V(G)$, we have that $v' \notin X$ and hence, there exists some $w \in X \cap N_{G'}(v) = X \cap N_G(v) = X \cap N_G(v)$, where the last equality is due to $X \subseteq V(G)$. This shows that X is a total dominating set of G .

\Leftarrow : Let X be a total dominating set of G . We claim that X is also a dominating set of G' . As $G'[V(G)] = G$, any vertex in $V(G)$ is still dominated by X inside G' . Consider some vertex v' for some $v \in V(G)$. Since X is a total dominating set of G , there exists some $w \in X \cap N_G(v) = X \cap N_{G'}(v) = X \cap N_{G'}(v')$ and hence v' is dominated by X as well. So, X must be a dominating set of G' . ◀

► **Theorem 8.3.** *If there is an algorithm \mathcal{A} solving DOMINATING SET in time $\mathcal{O}^*((4 - \varepsilon)^{tc\text{-}ctw(G)})$ for some $\varepsilon > 0$, then there is an algorithm \mathcal{A}' solving TOTAL DOMINATING SET in time $\mathcal{O}^*((4 - \varepsilon)^{ctw(G)})$.*

Proof. Suppose \mathcal{A} is such an algorithm. The algorithm \mathcal{A}' first constructs G' in polynomial time, then runs \mathcal{A} on G' , which takes time $\mathcal{O}^*((4 - \varepsilon)^{tc\text{-}ctw(G')}) \leq \mathcal{O}^*((4 - \varepsilon)^{ctw(G)})$ by Lemma 8.1. Finally \mathcal{A}' returns the same answer as \mathcal{A} . The correctness of \mathcal{A}' follows from Lemma 8.2 and the running time of \mathcal{A}' is dominated by running \mathcal{A} on G' . ◀

We remark that an $\mathcal{O}^*(4^{tw(G)})$ -time algorithm for TOTAL DOMINATING SET is posed as an exercise in [12] which implies an $\mathcal{O}^*(4^{ctw(G)})$ -time algorithm by Lemma 4.1. It remains to show that TOTAL DOMINATING SET cannot be solved in time $\mathcal{O}^*((4 - \varepsilon)^{ctw(G)})$ for some $\varepsilon > 0$. We show this by adapting the lower bound construction for DOMINATING SET given by Lokshtanov et al. [46] and the observation of van Geffen et al. [57] that slightly changing the construction already yields the same lower bound parameterized by cutwidth. Since 4 is a power of two, some technicalities regarding the groups can be avoided, allowing for a simpler construction.

► **Theorem 8.4.** *There is no algorithm solving TOTAL DOMINATING SET in time $\mathcal{O}^*((4 - \varepsilon)^{ctw(G)})$ for some $\varepsilon > 0$, unless SETH is false.*

Construction. Let σ be a q -SATISFIABILITY instance with n variables and m clauses. We begin by describing how to construct a graph $G = G(\sigma)$ of cutwidth $n/2 + 4q + \mathcal{O}(1)$. We assume without loss of generality that σ has an even number of variables and partition the variables into pairs, so that pair $i \in [n/2]$ consists of variables x_{2i-1} and x_{2i} .

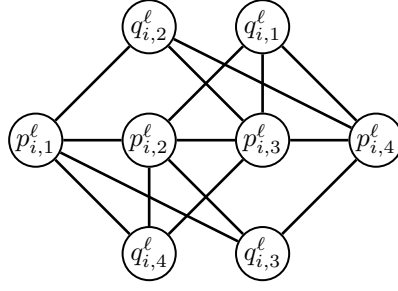

■ **Figure 13** The path segment P_i^ℓ and guards Q_i^ℓ .

For every pair $i \in [n/2]$, we create a path P_i consisting of $4m(3\frac{n}{2} + 1)$ vertices and partition the path into $m(3\frac{n}{2} + 1)$ segments consisting of four vertices. Segment $\ell \in [m(3\frac{n}{2} + 1)]$ consists of the vertices $P_i^\ell = \{p_{i,1}^\ell, p_{i,2}^\ell, p_{i,3}^\ell, p_{i,4}^\ell\}$. To each segment ℓ , we attach four *guard vertices* $Q_i^\ell = \{q_{i,1}^\ell, \dots, q_{i,4}^\ell\}$ such that $N(q_{i,j}^\ell) = P_i^\ell \setminus \{p_{i,j}^\ell\}$ for all $j \in [4]$, i.e., for every vertex on P_i^ℓ there is one guard that avoids this vertex and is only adjacent to all other vertices on P_i^ℓ , see Figure 13.

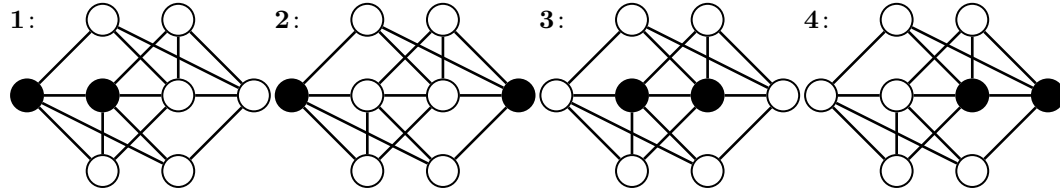

■ **Figure 14** The four states 1_i^ℓ , 2_i^ℓ , 3_i^ℓ , and 4_i^ℓ on the path segment P_i^ℓ . The filled vertices belong to the corresponding set.

Let $1_i^\ell = \{p_{i,1}^\ell, p_{i,2}^\ell\}$, $2_i^\ell = \{p_{i,1}^\ell, p_{i,4}^\ell\}$, $3_i^\ell = \{p_{i,2}^\ell, p_{i,3}^\ell\}$, $4_i^\ell = \{p_{i,3}^\ell, p_{i,4}^\ell\}$ and $\mathcal{S}_i^\ell = \{1_i^\ell, 2_i^\ell, 3_i^\ell, 4_i^\ell\}$, see Figure 14 for a depiction of these sets. For each segment P_i^ℓ , we introduce four *connector vertices* $\hat{z}_{i,S}^\ell$, $S \in \mathcal{S}_i^\ell$ and four *clique vertices* $z_{i,S}^\ell$, $S \in \mathcal{S}_i^\ell$, together with two *clique guards* $y_{i,1}^\ell$ and $y_{i,2}^\ell$. The connector vertex $\hat{z}_{i,S}^\ell$ is adjacent to $P_i^\ell \setminus S$ and the clique vertex $z_{i,S}^\ell$. The clique guards $y_{i,1}^\ell$ and $y_{i,2}^\ell$ are adjacent and the clique vertices $z_{i,S}^\ell$, $S \in \mathcal{S}_i^\ell$, together with $y_{i,1}^\ell$ form a clique.

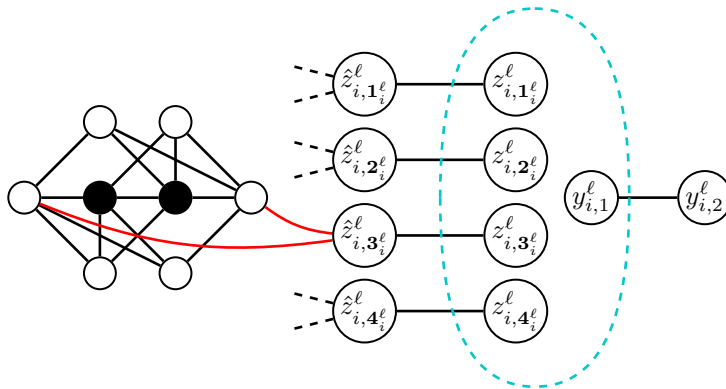

■ **Figure 15** The block gadget B_i^ℓ . The vertices in the dashed ellipse form a clique. The vertex $\hat{z}_{i,3}^\ell$ is adjacent to $P_i^\ell \setminus 3_i^\ell$.

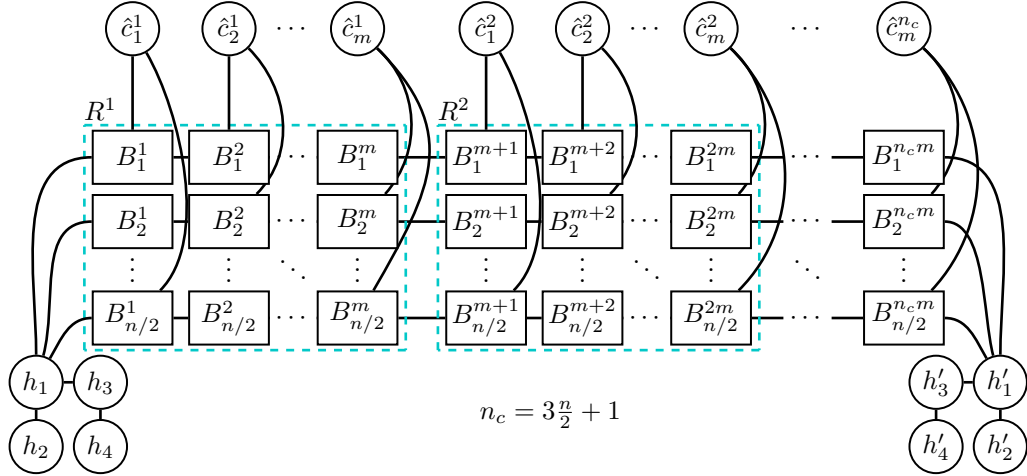

■ **Figure 16** G viewed as a matrix of block gadgets. The dashed rectangles delineate different regions.

We define $Z_i^\ell = \{z_{i,S}^\ell, \hat{z}_{i,S}^\ell : S \in \mathcal{S}_i^\ell\} \cup \{y_{i,1}^\ell, y_{i,2}^\ell\}$, $B_i^\ell = P_i^\ell \cup Q_i^\ell \cup Z_i^\ell$, and $R^\gamma = \bigcup_{i=1}^{n/2} \bigcup_{\ell=(\gamma-1)m+1}^m B_i^\ell$ for $\gamma \in [3 \frac{n}{2} + 1]$. The B_i^ℓ are called *blocks*; the R^γ are called *regions*. See Figure 15 for a depiction of a single block. Each region can be visualized as a matrix of blocks with $n/2$ rows and m columns and we have $3 \frac{n}{2} + 1$ regions in total. Furthermore, we say that $p_{i,1}^\ell$ is the *entry vertex* of B_i^ℓ and $p_{i,4}^\ell$ is the *exit vertex* of B_i^ℓ . Notice that there is a matching of size $n/2$ between the exit vertices of column ℓ and the entry vertices of column $\ell + 1$.

Let $\mathbf{states} = \{1, 2, 3, 4\}$ and fix a bijection $\kappa: \{0, 1\}^2 \rightarrow \mathbf{states}$ mapping truth assignments of a pair of variables to possible states on a path segment. For each clause C_j , $j \in [m]$, we introduce $3 \frac{n}{2} + 1$ *clause vertices* \hat{c}_j^γ , $\gamma \in [3 \frac{n}{2} + 1]$, one per region. The vertex \hat{c}_j^γ is adjacent to some vertices in the blocks $B_i^{(\gamma-1)m+j}$ for every $i \in [n/2]$. Namely, for every variable pair i consider the truth assignments of this pair that satisfy clause C_j and consider the states corresponding, via κ , to these truth assignments. Each of these states corresponds to some vertex $z_{i,S}^{(\gamma-1)m+j}$, $S \in \mathcal{S}_i^{(\gamma-1)m+j}$, which we make adjacent to \hat{c}_j^γ .

Finally, we introduce eight *endpoint guards* h_t, h'_t , $t \in [4]$, together with the edges $\{h_1, h_2\}$, $\{h_1, h_3\}$, $\{h_3, h_4\}$, $\{h'_1, h'_2\}$, $\{h'_1, h'_3\}$, $\{h'_3, h'_4\}$ and h_1 is made adjacent to $p_{i,1}^1$ for all $i \in [n/2]$ and h'_1 is made adjacent to $p_{i,4}^{m(3 \frac{n}{2} + 1)}$ for all $i \in [n/2]$. This concludes the construction of $G(\sigma)$. See Figure 16 for a depiction of the graph G as a matrix of blocks.

► **Lemma 8.5.** *If σ is satisfiable, then $G(\sigma)$ has a total dominating set of size at most $4m(3 \frac{n}{2} + 1) \frac{n}{2} + 4$.*

Proof. Let τ be a satisfying truth assignment of σ . Let τ_i be the restriction of τ to the i -th variable pair. We construct a total dominating set X of the desired size as follows. For every variable pair $i \in [n/2]$, we take in each block B_i^ℓ the vertices in $\kappa(\tau_i)^\ell \in \mathcal{S}_i^\ell$, the vertex $z_{i, \kappa(\tau_i)^\ell}^\ell$, and the clique guard $y_{i,1}^\ell$ for all $\ell \in [m(3 \frac{n}{2} + 1)]$. Additionally, we take the endpoint guards h_1, h_3, h'_1, h'_3 . This concludes the description of X and we see that $|X| = 4m(3 \frac{n}{2} + 1) \frac{n}{2} + 4$.

First, observe that X dominates all the endpoint guards h_t, h'_t , $t \in [4]$, and the endpoints of all P_i are dominated, since $h_1, h'_1 \in X$. Next, since X contains two vertices from each path segment P_i^ℓ , we see that X intersects the neighborhoods of all vertices in Q_i^ℓ and hence dominates them. On each path P_i , we are repeatedly taking two consecutive vertices with

a gap of two, except for possibly the ends of P_i . Hence, also all internal vertices of P_i are dominated.

Consider the vertices in the Z_i^ℓ next. Since $y_{i,1}^\ell \in X$, we see that $y_{i,2}^\ell$ and all $z_{i,S}^\ell$, $S \in \mathcal{S}_i^\ell$, are dominated. Additionally, since $z_{i,\kappa(\tau_i)^\ell}^\ell \in X$, also $y_{i,1}^\ell$ and $\hat{z}_{i,\kappa(\tau_i)^\ell}^\ell$ must be dominated. For $S \in \mathcal{S}_i^\ell \setminus \{\kappa(\tau_i)^\ell\}$, we see that $\hat{z}_{i,S}^\ell$ is dominated by some vertex on P_i^ℓ , because $N(\hat{z}_{i,S}^\ell) \cap X = (P_i^\ell \setminus S) \cap \kappa(\tau_i)^\ell \neq \emptyset$ by construction.

Finally, consider the clause vertices \hat{c}_j^γ . Since clause C_j is satisfied by τ , there is some variable pair i so that τ_i satisfies C_j . By construction of $G(\sigma)$ and X , we have that $z_{i,\kappa(\tau_i)^\ell}^{(\gamma-1)m+j} \in X$ and this vertex is adjacent to \hat{c}_j^γ , so \hat{c}_j^γ is dominated. This concludes the proof. \blacktriangleleft

For the reverse direction, we first study the structure of total dominating sets in $G(\sigma)$.

► **Lemma 8.6.** *Let X be a total dominating set of $G(\sigma)$, then for any block $B_i^\ell = P_i^\ell \cup Q_i^\ell \cup Z_i^\ell$, we have that $|X \cap P_i^\ell| \geq 2$, $|X \cap Z_i^\ell| \geq 2$, and $y_{i,1}^\ell \in X$. Moreover, if $|X \cap B_i^\ell| \leq 4$, then $X \cap P_i^\ell \in \mathcal{S}_i^\ell$ and $X \cap \{z_{i,S}^\ell : S \in \mathcal{S}_i^\ell\} = \{z_{i,X \cap P_i^\ell}^\ell\}$.*

Proof. Suppose that $|X \cap P_i^\ell| \leq 1$, then there is some $j \in [4]$ so that $N(q_{i,j}^\ell) \cap X = \emptyset$, hence X cannot be a total dominating set. Observe that $y_{i,2}^\ell$ is a degree-1 vertex, so X must contain its neighbor $y_{i,1}^\ell$. To dominate $y_{i,1}^\ell \in Z_i^\ell$, X must contain a vertex from $N(y_{i,1}^\ell) \subseteq Z_i^\ell$, recall that Z_i^ℓ also contains $y_{i,2}^\ell$.

Now, suppose that the second condition holds. Due to the first part of this lemma, we have that $|X \cap B_i^\ell| = 4$, in particular $|X \cap P_i^\ell| = 2$, $X \cap Q_i^\ell = \emptyset$, and $X \cap \{z_{i,S}^\ell : S \in \mathcal{S}_i^\ell\} = \emptyset$, because $N(y_{i,1}^\ell) \subseteq Z_i^\ell \setminus \{z_{i,S}^\ell : S \in \mathcal{S}_i^\ell\}$. Suppose that $X \cap P_i^\ell \notin \mathcal{S}_i^\ell$, then $X \cap P_i^\ell = \{p_{i,1}^\ell, p_{i,3}^\ell\}$ or $X \cap P_i^\ell = \{p_{i,2}^\ell, p_{i,4}^\ell\}$, but then $p_{i,3}^\ell$ or respectively $p_{i,2}^\ell$ is not dominated. By the established properties of X , the only neighbor of $\hat{z}_{i,X \cap P_i^\ell}^\ell$ that may be in X is $z_{i,X \cap P_i^\ell}^\ell$, hence to dominate $\hat{z}_{i,X \cap P_i^\ell}^\ell$ we must have $z_{i,X \cap P_i^\ell}^\ell \in X$. This concludes the proof. \blacktriangleleft

A total dominating set X of $G(\sigma)$ does not necessarily repeat the same state on all segments P_i^ℓ of a path P_i . We need to study how X transitions between different states on the same path. For this sake, we order the states according to their names, i.e. $\mathbf{1} < \mathbf{2} < \mathbf{3} < \mathbf{4}$, and every \mathcal{S}_i^ℓ inherits this ordering. If $\mathbf{s}_i^\ell \in \mathcal{S}_i^\ell = \{\mathbf{1}_i^\ell, \mathbf{2}_i^\ell, \mathbf{3}_i^\ell, \mathbf{4}_i^\ell\}$, then we let $\mathbf{s} \in \{\mathbf{1}, \mathbf{2}, \mathbf{3}, \mathbf{4}\}$ correspondingly.

► **Lemma 8.7.** *Suppose that X is a total dominating set of $G(\sigma)$ with $|X \cap B_i^\ell| \leq 4$ for all i and ℓ . If $\mathbf{s}_i^\ell = X \cap P_i^\ell$ is the state of X on P_i^ℓ and $\tilde{\mathbf{s}}_i^{\ell+1} = X \cap P_i^{\ell+1}$ is the state of X on $P_i^{\ell+1}$, then we must have that $\tilde{\mathbf{s}} \leq \mathbf{s}$.*

Proof. Suppose that $\tilde{\mathbf{s}} > \mathbf{s}$. This implies that $\mathbf{s} \neq \mathbf{4}$. If $\mathbf{s} \leq \mathbf{2}$, then $p_{i,4}^\ell$ must be dominated by $p_{i,1}^{\ell+1}$, so $\tilde{\mathbf{s}} \leq \mathbf{2}$ in this case, as the other states do not contain $p_{i,1}^{\ell+1}$. If $(\mathbf{s}, \tilde{\mathbf{s}}) = (\mathbf{1}, \mathbf{2})$ or $(\mathbf{s}, \tilde{\mathbf{s}}) = (\mathbf{3}, \mathbf{4})$, then $p_{i,1}^{\ell+1}$ is not dominated. This concludes the proof. \blacktriangleleft

► **Lemma 8.8.** *If $G(\sigma)$ has a total dominating size X of size at most $4m(3\frac{n}{2} + 1)\frac{n}{2} + 4$, then σ is satisfiable.*

Proof. Note that X contains the vertices h_1, h_3, h'_1, h'_3 due to the degree-1 neighbors. There are in total $m(3\frac{n}{2} + 1)\frac{n}{2}$ blocks B_i^ℓ and X has to contain at least four vertices in each block due to Lemma 8.6. This completely uses the budget for X and thus we have $|X \cap B_i^\ell| = 4$ for all i and ℓ . By Lemma 8.6, X assumes one of our desired states on each B_i^ℓ .

Using the notation of Lemma 8.7, we say that a *cheat* occurs if $\tilde{\mathbf{s}} < \mathbf{s}$. Due to Lemma 8.7, there can be at most 3 cheats on each P_i . Since there are $\frac{n}{2}$ paths, at most $3\frac{n}{2}$ regions can

be spoiled by cheats. Hence, there is at least one γ so that R^γ does not contain a cheat. Fix this γ for the remainder of the proof.

We will read off a satisfying truth assignment τ for σ from region R^γ . The truth assignment for variable pair i is given by $\tau_i = \kappa^{-1}(\mathbf{s})$, where $\mathbf{s}_i^{\gamma m} = X \cap P_i^{\gamma m} \in \mathcal{S}_i^{\gamma m}$. For a fixed variable pair $i \in [n/2]$, the total dominating set X will assume the same state on all blocks $B_i^{(\gamma-1)m+j}$, $j \in [m]$, since R^γ does not contain any cheats. The desired truth assignment is given by $\tau = \tau_1 \cup \dots \cup \tau_{n/2}$.

Consider some clause C_j and its associated clause vertex \hat{c}_j^γ in region R^γ . Let $\ell = (\gamma-1)m+j$. Since X dominates the clause vertex, there is some i so that $z_{i, X \cap P_i^\ell}^\ell \in X \cap N(\hat{c}_j^\gamma)$. By construction, this means that the state of X on P_i^ℓ corresponds to a satisfying truth assignment of clause C_j . By the previous paragraph this is the same state as the state of X on $P_i^{\gamma m}$ which in turn corresponds to τ_i , hence τ must satisfy clause C_j . Since the choice of C_j was arbitrary, it follows that σ is satisfiable. \blacktriangleleft

► **Lemma 8.9.** *The cutwidth of $G(\sigma)$ is at most $n/2 + 4q + \mathcal{O}(1)$.*

Proof. Consider the linear layout of $G(\sigma)$ that starts with the vertices h_4, h_3, h_2, h_1 . Then we go through $G(\sigma)$ column by column and for each column $\ell \in [m(3\frac{n}{2} + 1)]$, the linear layout first contains the clause vertex of the ℓ -th column, and then the vertices of $B_1^\ell, B_2^\ell, \dots, B_{n/2}^\ell$ in this order. Finally, the layout ends with the vertices h'_1, h'_2, h'_3, h'_4 .

Consider any vertex $v^* \in V(G(\sigma))$ and the edges crossing the cut that comes directly after v^* . If $v^* \in \{h_4, h_3, h_2, h'_1, h'_2, h'_3, h'_4\}$, then at most two edges cross the cut. If $v^* = h_1$, then $n/2$ edges cross the cut, namely those from h_1 to the block gadgets B_i^1 for all $i \in [n/2]$. Now, suppose that v^* is a vertex in column $\ell \in [m(3\frac{n}{2} + 1)]$.

If $v^* = \hat{c}_j^\gamma$ is the clause vertex in column $\ell = (\gamma-1)m+j$, then the cut consists of the edges between v^* and its neighbors and the $n/2$ matching edges between column $\ell-1$ and column ℓ (or the $n/2$ edges coming from h_1 if $\ell=1$). Since each clause has size at most q , the clause vertex \hat{c}_j^γ is adjacent to vertices in at most q different block gadgets. By construction, $v^* = \hat{c}_j^\gamma$ is adjacent to at most 4 vertices in each block gadget. Hence, this cut consists of at most $n/2 + 4q$ edges.

If $v^* \neq \hat{c}_j^\gamma$ is not the clause vertex in column $\ell = (\gamma-1)m+j$, then v^* lies in some block gadget B_i^ℓ with $i \in [n/2]$. By construction, every other block gadget is completely contained on one side of the cut, so the cut contains edges that are internal to at most one block gadget. Since each block gadget consists of a constant number of vertices, this will account for a constant number of edges. Furthermore, the cut contains at most $n/2$ matching edges, one for each group. More precisely, for the block gadgets of column ℓ that appear before B_i^ℓ in the layout, the edge from the exit vertex to the entry vertex of the next column is in the cut, and for the block gadgets of column ℓ that appear after B_i^ℓ , the edge to the previous column is in the cut. The block gadget B_i^ℓ has two edges to other columns that can be in the cut. Finally, the edges from block gadgets of column ℓ to \hat{c}_j^γ can be in the cut, but these are bounded by $4q$ as before. In total, the cut contains at most $n/2 + 4q + \mathcal{O}(1)$ edges. \blacktriangleleft

Proof of Theorem 8.4. Suppose there is an algorithm \mathcal{A} that solves TOTAL DOMINATING SET in time $\mathcal{O}^*((4-\varepsilon)^{\text{ctw}(G)})$ for some $\varepsilon > 0$. We show how to solve q -SATISFIABILITY in time $\mathcal{O}^*((2-\varepsilon')^n)$ for some $\varepsilon' > 0$ for all q , thus contradicting SETH by Theorem 2.4. Given a q -SATISFIABILITY instance σ , we construct $G(\sigma)$ in polynomial time and then run \mathcal{A} on $G(\sigma)$ and return its answer. This is correct by Lemma 8.5 and Lemma 8.8. Due to Lemma 8.9, the running time is $\mathcal{O}^*((4-\varepsilon)^{\text{ctw}(G(\sigma))}) \leq \mathcal{O}^*((4-\varepsilon)^{n/2+4q+\mathcal{O}(1)}) \leq \mathcal{O}^*((4-\varepsilon)^{n/2}) \leq \mathcal{O}^*((2-\varepsilon')^n)$ for some $\varepsilon' > 0$, where we use $q \in \mathcal{O}(1)$ in the second inequality. \blacktriangleleft

9 Conclusion

Our main results are the two lower bounds for DELETION TO r -COLORABLE, which apply also to parameterization by treewidth resp. cliquewidth but use much more restrictive structure; this greatly refines what was known for ODD CYCLE TRANSVERSAL, i.e. $r = 2$, and gives new tight bounds for $r \geq 3$. In particular, beyond the above-mentioned examples, these are further natural problems where a small modulator to a simple graph class (of constant treewidth) is as hard as small treewidth. Surprisingly perhaps, something even stronger holds for clique-width: To get the tight lower bound, a modulator with few (true) twinclasses suffices, i.e., we need neither a sequence of disjoint separators nor complex dense structure. For DOMINATING SET, only the latter was established: twinclass-cutwidth rather than cliquewidth suffices to take us from base 3 in the running time to base 4.

Such results bring several benefits: (1) Rather than e.g. getting only the isolated result of (conditional) complexity of a problem relative to treewidth, we get a much larger range of input structure that exhibits the same tight complexity. (2) At the same time, by aiming for maximally restricted lower bound structure, we get a much better understanding of what structure makes a given problem hard. This in turn helps to focus efforts at faster algorithms through (even) stronger structural restrictions on the input.

An immediate follow-up question is whether there are improved algorithms for DELETION TO r -COLORABLE when $G - X$ has treewidth less than r ; so far, this is known only for ODD CYCLE TRANSVERSAL, but we think such algorithms exist in general. We observe that any construction relying on $(r + 1)$ -critical graphs must have treewidth at least r , hence improving upon the treewidth of our construction requires a fundamentally different idea.

Similarly, is there a meaningful restriction of (linear) clique-width, for which Lampis' [45] lower bound for r -COLORING already holds? Much more broadly, what other classes of problems exhibit the same lower bound as for treewidth already relative to deletion distance to a sparse graph class? Are there problems where this jump in complexity happens later, say, for treedepth, for some elimination distance, or only for treewidth/pathwidth? E.g., what is the complexity of DOMINATING SET relative to deletion distances, and the complexity relative to treedepth may be an interesting stepping stone? Similarly, to what generality do we get the same lower bound as for clique-width already relative to, e.g., twinclass-pathwidth?

References

- 1 Hans L. Bodlaender. A partial k -arboretum of graphs with bounded treewidth. *Theor. Comput. Sci.*, 209(1-2):1–45, 1998. doi:10.1016/S0304-3975(97)00228-4.
- 2 Hans L. Bodlaender, Erik Jan van Leeuwen, Johan M. M. van Rooij, and Martin Vatshelle. Faster algorithms on branch and clique decompositions. In Petr Hlinený and Antonín Kucera, editors, *Mathematical Foundations of Computer Science 2010, 35th International Symposium, MFCS 2010, Brno, Czech Republic, August 23-27, 2010. Proceedings*, volume 6281 of *Lecture Notes in Computer Science*, pages 174–185. Springer, 2010. doi:10.1007/978-3-642-15155-2_17.
- 3 Glencora Borradaile and Hung Le. Optimal dynamic program for r -domination problems over tree decompositions. In Jiong Guo and Danny Hermelin, editors, *11th International Symposium on Parameterized and Exact Computation, IPEC 2016, August 24-26, 2016, Aarhus, Denmark*, volume 63 of *LIPICs*, pages 8:1–8:23. Schloss Dagstuhl - Leibniz-Zentrum fuer Informatik, 2016. doi:10.4230/LIPICs.IPEC.2016.8.
- 4 Jannis Bulian and Anuj Dawar. Graph isomorphism parameterized by elimination distance to bounded degree. *Algorithmica*, 75(2):363–382, 2016. doi:10.1007/s00453-015-0045-3.
- 5 Jannis Bulian and Anuj Dawar. Fixed-parameter tractable distances to sparse graph classes. *Algorithmica*, 79(1):139–158, 2017. doi:10.1007/s00453-016-0235-7.
- 6 Yijia Chen and Jörg Flum. Fo-definability of shrub-depth. In Maribel Fernández and Anca Muscholl, editors, *28th EACSL Annual Conference on Computer Science Logic, CSL 2020, January 13-16, 2020, Barcelona, Spain*, volume 152 of *LIPICs*, pages 15:1–15:16. Schloss Dagstuhl - Leibniz-Zentrum für Informatik, 2020. doi:10.4230/LIPICs.CSL.2020.15.
- 7 Bruno Courcelle, Johann A. Makowsky, and Udi Rotics. Linear time solvable optimization problems on graphs of bounded clique-width. *Theory Comput. Syst.*, 33(2):125–150, 2000. doi:10.1007/s002249910009.
- 8 Bruno Courcelle and Stephan Olariu. Upper bounds to the clique width of graphs. *Discret. Appl. Math.*, 101(1-3):77–114, 2000. doi:10.1016/S0166-218X(99)00184-5.
- 9 Radu Curticapean, Nathan Lindzey, and Jesper Nederlof. A tight lower bound for counting hamiltonian cycles via matrix rank. In Artur Czumaj, editor, *Proceedings of the Twenty-Ninth Annual ACM-SIAM Symposium on Discrete Algorithms, SODA 2018, New Orleans, LA, USA, January 7-10, 2018*, pages 1080–1099. SIAM, 2018. doi:10.1137/1.9781611975031.70.
- 10 Radu Curticapean and Dániel Marx. Tight conditional lower bounds for counting perfect matchings on graphs of bounded treewidth, cliquewidth, and genus. In Robert Krauthgamer, editor, *Proceedings of the Twenty-Seventh Annual ACM-SIAM Symposium on Discrete Algorithms, SODA 2016, Arlington, VA, USA, January 10-12, 2016*, pages 1650–1669. SIAM, 2016. doi:10.1137/1.9781611974331.ch113.
- 11 Marek Cygan, Holger Dell, Daniel Lokshtanov, Dániel Marx, Jesper Nederlof, Yoshio Okamoto, Ramamohan Paturi, Saket Saurabh, and Magnus Wahlström. On problems as hard as CNF-SAT. *ACM Trans. Algorithms*, 12(3):41:1–41:24, 2016. doi:10.1145/2925416.
- 12 Marek Cygan, Fedor V. Fomin, Lukasz Kowalik, Daniel Lokshtanov, Dániel Marx, Marcin Pilipczuk, Michał Pilipczuk, and Saket Saurabh. *Parameterized Algorithms*. Springer, 2015. doi:10.1007/978-3-319-21275-3.
- 13 Marek Cygan, Stefan Kratsch, and Jesper Nederlof. Fast hamiltonicity checking via bases of perfect matchings. *J. ACM*, 65(3):12:1–12:46, 2018. doi:10.1145/3148227.
- 14 Marek Cygan, Jesper Nederlof, Marcin Pilipczuk, Michał Pilipczuk, Johan M. M. van Rooij, and Jakub Onufry Wojtaszczyk. Solving connectivity problems parameterized by treewidth in single exponential time. *ACM Trans. Algorithms*, 18(2):17:1–17:31, 2022. doi:10.1145/3506707.
- 15 Matt DeVos, O-joung Kwon, and Sang-il Oum. Branch-depth: Generalizing tree-depth of graphs. *Eur. J. Comb.*, 90:103186, 2020. doi:10.1016/j.ejc.2020.103186.
- 16 Reinhard Diestel. *Graph Theory, 4th Edition*, volume 173 of *Graduate texts in mathematics*. Springer, 2012.

- 17 Louis Dublois, Michael Lampis, and Vangelis Th. Paschos. New algorithms for mixed dominating set. *Discret. Math. Theor. Comput. Sci.*, 23(1), 2021. URL: <http://dmtcs.episciences.org/7407>.
- 18 Louis Dublois, Michael Lampis, and Vangelis Th. Paschos. Upper dominating set: Tight algorithms for pathwidth and sub-exponential approximation. *Theor. Comput. Sci.*, 923:271–291, 2022. doi:10.1016/j.tcs.2022.05.013.
- 19 László Egri, Dániel Marx, and Pawel Rzazewski. Finding list homomorphisms from bounded-treewidth graphs to reflexive graphs: a complete complexity characterization. In Rolf Niedermeier and Brigitte Vallée, editors, *35th Symposium on Theoretical Aspects of Computer Science, STACS 2018, February 28 to March 3, 2018, Caen, France*, volume 96 of *LIPICs*, pages 27:1–27:15. Schloss Dagstuhl - Leibniz-Zentrum für Informatik, 2018. doi:10.4230/LIPICs.STACS.2018.27.
- 20 Eduard Eiben, Robert Ganian, Thekla Hamm, and O-joung Kwon. Measuring what matters: A hybrid approach to dynamic programming with treewidth. *J. Comput. Syst. Sci.*, 121:57–75, 2021. doi:10.1016/j.jcss.2021.04.005.
- 21 Eduard Eiben, Robert Ganian, and Stefan Szeider. Meta-kernelization using well-structured modulators. *Discret. Appl. Math.*, 248:153–167, 2018. doi:10.1016/j.dam.2017.09.018.
- 22 Eduard Eiben, Robert Ganian, and Stefan Szeider. Solving problems on graphs of high rank-width. *Algorithmica*, 80(2):742–771, 2018. doi:10.1007/s00453-017-0290-8.
- 23 Jacob Focke, Dániel Marx, and Pawel Rzazewski. Counting list homomorphisms from graphs of bounded treewidth: tight complexity bounds. In Joseph (Seffi) Naor and Niv Buchbinder, editors, *Proceedings of the 2022 ACM-SIAM Symposium on Discrete Algorithms, SODA 2022, Virtual Conference / Alexandria, VA, USA, January 9 - 12, 2022*, pages 431–458. SIAM, 2022. doi:10.1137/1.9781611977073.22.
- 24 Jakub Gajarský and Stephan Kreutzer. Computing shrub-depth decompositions. In Christophe Paul and Markus Bläser, editors, *37th International Symposium on Theoretical Aspects of Computer Science, STACS 2020, March 10-13, 2020, Montpellier, France*, volume 154 of *LIPICs*, pages 56:1–56:17. Schloss Dagstuhl - Leibniz-Zentrum für Informatik, 2020. doi:10.4230/LIPICs.STACS.2020.56.
- 25 Jakub Gajarský, Michael Lampis, and Sebastian Ordyniak. Parameterized algorithms for modular-width. In Gregory Z. Gutin and Stefan Szeider, editors, *Parameterized and Exact Computation - 8th International Symposium, IPEC 2013, Sophia Antipolis, France, September 4-6, 2013, Revised Selected Papers*, volume 8246 of *Lecture Notes in Computer Science*, pages 163–176. Springer, 2013. doi:10.1007/978-3-319-03898-8_15.
- 26 Robert Ganian, Thekla Hamm, Viktoriia Korchemna, Karolina Okrasa, and Kirill Simonov. The fine-grained complexity of graph homomorphism parameterized by clique-width. In Mikolaj Bojanczyk, Emanuela Merelli, and David P. Woodruff, editors, *49th International Colloquium on Automata, Languages, and Programming, ICALP 2022, July 4-8, 2022, Paris, France*, volume 229 of *LIPICs*, pages 66:1–66:20. Schloss Dagstuhl - Leibniz-Zentrum für Informatik, 2022. doi:10.4230/LIPICs.ICALP.2022.66.
- 27 Robert Ganian, Petr Hliněný, Jaroslav Nesetril, Jan Obdržálek, and Patrice Ossona de Mendez. Shrub-depth: Capturing height of dense graphs. *Log. Methods Comput. Sci.*, 15(1), 2019. doi:10.23638/LMCS-15(1:7)2019.
- 28 M. R. Garey, David S. Johnson, and Larry J. Stockmeyer. Some simplified np-complete graph problems. *Theor. Comput. Sci.*, 1(3):237–267, 1976. doi:10.1016/0304-3975(76)90059-1.
- 29 Carla Groenland, Isja Mannens, Jesper Nederlof, and Krisztina Szilágyi. Tight bounds for counting colorings and connected edge sets parameterized by cutwidth. In Petra Berenbrink and Benjamin Monmege, editors, *39th International Symposium on Theoretical Aspects of Computer Science, STACS 2022, March 15-18, 2022, Marseille, France (Virtual Conference)*, volume 219 of *LIPICs*, pages 36:1–36:20. Schloss Dagstuhl - Leibniz-Zentrum für Informatik, 2022. doi:10.4230/LIPICs.STACS.2022.36.

- 30 György Hajós. Über eine Konstruktion nicht n -färbbarer Graphen. *Wiss. Z. Martin Luther Univ. Halle-Wittenberg Math.-Natur. Reihe*, 10:116–117, 1961.
- 31 Petr Hliněný, O-joung Kwon, Jan Obdržálek, and Sebastian Ordyniak. Tree-depth and vertex-minors. *Eur. J. Comb.*, 56:46–56, 2016. doi:10.1016/j.ejc.2016.03.001.
- 32 Eva-Maria C. Hols, Stefan Kratsch, and Astrid Pieterse. Elimination distances, blocking sets, and kernels for vertex cover. In Christophe Paul and Markus Bläser, editors, *37th International Symposium on Theoretical Aspects of Computer Science, STACS 2020, March 10-13, 2020, Montpellier, France*, volume 154 of *LIPIcs*, pages 36:1–36:14. Schloss Dagstuhl - Leibniz-Zentrum für Informatik, 2020. doi:10.4230/LIPIcs.STACS.2020.36.
- 33 Russell Impagliazzo and Ramamohan Paturi. On the complexity of k -sat. *J. Comput. Syst. Sci.*, 62(2):367–375, 2001. doi:10.1006/jcss.2000.1727.
- 34 Russell Impagliazzo, Ramamohan Paturi, and Francis Zane. Which problems have strongly exponential complexity? *J. Comput. Syst. Sci.*, 63(4):512–530, 2001. doi:10.1006/jcss.2001.1774.
- 35 Yoichi Iwata and Yuichi Yoshida. On the equivalence among problems of bounded width. In Nikhil Bansal and Irene Finocchi, editors, *Algorithms - ESA 2015 - 23rd Annual European Symposium, Patras, Greece, September 14-16, 2015, Proceedings*, volume 9294 of *Lecture Notes in Computer Science*, pages 754–765. Springer, 2015. doi:10.1007/978-3-662-48350-3_63.
- 36 Ashwin Jacob, Fahad Panolan, Venkatesh Raman, and Vibha Sahlot. Structural parameterizations with modulator oblivion. *Algorithmica*, 84(8):2335–2357, 2022. doi:10.1007/s00453-022-00971-7.
- 37 Hugo Jacob, Thomas Bellitto, Oscar Defrain, and Marcin Pilipczuk. Close relatives (of feedback vertex set), revisited. In Petr A. Golovach and Meirav Zehavi, editors, *16th International Symposium on Parameterized and Exact Computation, IPEC 2021, September 8-10, 2021, Lisbon, Portugal*, volume 214 of *LIPIcs*, pages 21:1–21:15. Schloss Dagstuhl - Leibniz-Zentrum für Informatik, 2021. doi:10.4230/LIPIcs.IPEC.2021.21.
- 38 Lars Jaffke and Bart M.P. Jansen. Fine-grained parameterized complexity analysis of graph coloring problems. *Discrete Applied Mathematics*, 327:33–46, 2023. URL: <https://www.sciencedirect.com/science/article/pii/S0166218X22004346>, doi:<https://doi.org/10.1016/j.dam.2022.11.011>.
- 39 Bart M. P. Jansen, Jari J. H. de Kroon, and Michal Włodarczyk. Vertex deletion parameterized by elimination distance and even less. In Samir Khuller and Virginia Vassilevska Williams, editors, *STOC '21: 53rd Annual ACM SIGACT Symposium on Theory of Computing, Virtual Event, Italy, June 21-25, 2021*, pages 1757–1769. ACM, 2021. doi:10.1145/3406325.3451068.
- 40 Bart M. P. Jansen and Jesper Nederlof. Computing the chromatic number using graph decompositions via matrix rank. *Theor. Comput. Sci.*, 795:520–539, 2019. doi:10.1016/j.tcs.2019.08.006.
- 41 Ioannis Katsikarelis, Michael Lampis, and Vangelis Th. Paschos. Structural parameters, tight bounds, and approximation for (k, r) -center. *Discrete Applied Mathematics*, 264:90–117, 2019. doi:10.1016/j.dam.2018.11.002.
- 42 Ioannis Katsikarelis, Michael Lampis, and Vangelis Th. Paschos. Structurally parameterized d -scattered set. *Discret. Appl. Math.*, 308:168–186, 2022. doi:10.1016/j.dam.2020.03.052.
- 43 O-joung Kwon, Rose McCarty, Sang-il Oum, and Paul Wollan. Obstructions for bounded shrub-depth and rank-depth. *J. Comb. Theory, Ser. B*, 149:76–91, 2021. doi:10.1016/j.jctb.2021.01.005.
- 44 Michael Lampis. Algorithmic meta-theorems for restrictions of treewidth. *Algorithmica*, 64(1):19–37, 2012. doi:10.1007/s00453-011-9554-x.
- 45 Michael Lampis. Finer tight bounds for coloring on clique-width. *SIAM J. Discret. Math.*, 34(3):1538–1558, 2020. doi:10.1137/19M1280326.
- 46 Daniel Lokshtanov, Dániel Marx, and Saket Saurabh. Known algorithms on graphs of bounded treewidth are probably optimal. *ACM Trans. Algorithms*, 14(2):13:1–13:30, 2018. doi:10.1145/3170442.

- 47 Daniel Lokshantov, N. S. Narayanaswamy, Venkatesh Raman, M. S. Ramanujan, and Saket Saurabh. Faster parameterized algorithms using linear programming. *ACM Trans. Algorithms*, 11(2):15:1–15:31, 2014. doi:10.1145/2566616.
- 48 Dániel Marx, Govind S. Sankar, and Philipp Schepper. Degrees and gaps: Tight complexity results of general factor problems parameterized by treewidth and cutwidth. In Nikhil Bansal, Emanuela Merelli, and James Worrell, editors, *48th International Colloquium on Automata, Languages, and Programming, ICALP 2021, July 12-16, 2021, Glasgow, Scotland (Virtual Conference)*, volume 198 of *LIPICs*, pages 95:1–95:20. Schloss Dagstuhl - Leibniz-Zentrum für Informatik, 2021. doi:10.4230/LIPICs.ICALP.2021.95.
- 49 Dániel Marx, Govind S. Sankar, and Philipp Schepper. Anti-factor is FPT parameterized by treewidth and list size (but counting is hard). In Holger Dell and Jesper Nederlof, editors, *17th International Symposium on Parameterized and Exact Computation, IPEC 2022, September 7-9, 2022, Potsdam, Germany*, volume 249 of *LIPICs*, pages 22:1–22:23. Schloss Dagstuhl - Leibniz-Zentrum für Informatik, 2022. doi:10.4230/LIPICs.IPEC.2022.22.
- 50 Stefan Mengel. Parameterized compilation lower bounds for restricted CNF-formulas. In Nadia Creignou and Daniel Le Berre, editors, *Theory and Applications of Satisfiability Testing - SAT 2016 - 19th International Conference, Bordeaux, France, July 5-8, 2016, Proceedings*, volume 9710 of *Lecture Notes in Computer Science*, pages 3–12. Springer, 2016. doi:10.1007/978-3-319-40970-2_1.
- 51 Jaroslav Nešetřil and Patrice Ossona de Mendez. *Sparsity - Graphs, Structures, and Algorithms*, volume 28 of *Algorithms and combinatorics*. Springer, 2012. doi:10.1007/978-3-642-27875-4.
- 52 Karolina Okrasa, Marta Piecyk, and Pawel Rzazewski. Full complexity classification of the list homomorphism problem for bounded-treewidth graphs. In Fabrizio Grandoni, Grzegorz Herman, and Peter Sanders, editors, *28th Annual European Symposium on Algorithms, ESA 2020, September 7-9, 2020, Pisa, Italy (Virtual Conference)*, volume 173 of *LIPICs*, pages 74:1–74:24. Schloss Dagstuhl - Leibniz-Zentrum für Informatik, 2020. doi:10.4230/LIPICs.ESA.2020.74.
- 53 Karolina Okrasa and Pawel Rzazewski. Fine-grained complexity of the graph homomorphism problem for bounded-treewidth graphs. *SIAM J. Comput.*, 50(2):487–508, 2021. doi:10.1137/20M1320146.
- 54 Daniël Paulusma, Friedrich Slivovsky, and Stefan Szeider. Model counting for CNF formulas of bounded modular treewidth. *Algorithmica*, 76(1):168–194, 2016. doi:10.1007/s00453-015-0030-x.
- 55 Marta Piecyk and Pawel Rzazewski. Fine-grained complexity of the list homomorphism problem: Feedback vertex set and cutwidth. In Markus Bläser and Benjamin Monmege, editors, *38th International Symposium on Theoretical Aspects of Computer Science, STACS 2021, March 16-19, 2021, Saarbrücken, Germany (Virtual Conference)*, volume 187 of *LIPICs*, pages 56:1–56:17. Schloss Dagstuhl - Leibniz-Zentrum für Informatik, 2021. doi:10.4230/LIPICs.STACS.2021.56.
- 56 Paul D. Seymour and Robin Thomas. Graph searching and a min-max theorem for tree-width. *J. Comb. Theory, Ser. B*, 58(1):22–33, 1993. doi:10.1006/jctb.1993.1027.
- 57 Bas A. M. van Geffen, Bart M. P. Jansen, Arnoud A. W. M. de Kroon, and Rolf Morel. Lower bounds for dynamic programming on planar graphs of bounded cutwidth. *J. Graph Algorithms Appl.*, 24(3):461–482, 2020. doi:10.7155/jgaa.00542.
- 58 Johan M. M. van Rooij, Hans L. Bodlaender, and Peter Rossmanith. Dynamic programming on tree decompositions using generalised fast subset convolution. In Amos Fiat and Peter Sanders, editors, *Algorithms - ESA 2009, 17th Annual European Symposium, Copenhagen, Denmark, September 7-9, 2009. Proceedings*, volume 5757 of *Lecture Notes in Computer Science*, pages 566–577. Springer, 2009. doi:10.1007/978-3-642-04128-0_51.

A Problem Definitions

VERTEX COVER

Input: An undirected graph $G = (V, E)$ and an integer b .

Question: Is there a set $Y \subseteq V$, $|Y| \leq b$, such that $G - Y$ contains no edges, i.e., $\chi(G - Y) \leq 1$?

ODD CYCLE TRANSVERSAL

Input: An undirected graph $G = (V, E)$ and an integer b .

Question: Is there a set $Y \subseteq V$, $|Y| \leq b$, such that $G - Y$ is bipartite, i.e., $\chi(G - Y) \leq 2$?

DELETION TO r -COLORABLE

Input: An undirected graph $G = (V, E)$ and an integer b .

Question: Is there a set $Y \subseteq V$, $|Y| \leq b$, such that $\chi(G - Y) \leq r$?

SATISFIABILITY

Input: A boolean formula σ in conjunctive normal form.

Question: Is there a satisfying assignment τ for σ ?

q -SATISFIABILITY

Input: A boolean formula σ in conjunctive normal form with clauses of size at most q .

Question: Is there a satisfying assignment τ for σ ?

q -HITTING SET

Input: An universe U and a set family \mathcal{F} over U of sets of size at most q and an integer t .

Question: Is there a set $H \subseteq U$, $|H| \leq t$, such that $H \cap S \neq \emptyset$ for all $S \in \mathcal{F}$?

r -COLORING

Input: An undirected graph $G = (V, E)$.

Question: Is $\chi(G) \leq r$?

LIST r -COLORING

Input: An undirected graph $G = (V, E)$, lists $\Lambda(v) \subseteq [r]$ for all $v \in V$.

Question: Is there an r -Coloring $\varphi: V \rightarrow [r]$ of G such that $\varphi(v) \in \Lambda(v)$ for all $v \in V$?

MAXIMUM CUT**Input:** An undirected graph $G = (V, E)$ and an integer b .**Question:** Is there a set $Y \subseteq V$, such that $|\delta(Y)| \geq b$?

 H -FREE DELETION**Input:** An undirected graph $G = (V, E)$ and an integer b .**Question:** Is there a set $Y \subseteq V$, $|Y| \leq b$, such that $G - Y$ is H -free?

DOMINATING SET**Input:** An undirected graph $G = (V, E)$ and an integer b .**Question:** Is there a set $X \subseteq V$, $|X| \leq b$, such that $N[X] = V$?

TOTAL DOMINATING SET**Input:** An undirected graph $G = (V, E)$ and an integer b .**Question:** Is there a set $X \subseteq V$, $|X| \leq b$, such that $\bigcup_{v \in X} N(v) = V$?

 (b, r) -CENTER**Input:** An undirected graph $G = (V, E)$ and an integers b and r .**Question:** Is there a set $X \subseteq V$, $|X| \leq b$, such that every vertex $v \in V$ is at most at distance r to X ?
