



Online Handbook of Argumentation for AI

Volume 2

Edited by

Federico Castagna
Francesca Mosca
Jack Mumford
Ştefan Sarkadi
Andreas Xydis

June 2021

Preface

This volume contains revised versions of the papers selected for the second volume of the Online Handbook of Argumentation for AI (OHAAI). Previously, formal theories of argument and argument interaction have been proposed and studied, and this has led to the more recent study of computational models of argument. Argumentation, as a field within artificial intelligence (AI), is highly relevant for researchers interested in symbolic representations of knowledge and defeasible reasoning. The purpose of this handbook is to provide an open access and curated anthology for the argumentation research community. OHAAI is designed to serve as a research hub to keep track of the latest and upcoming PhD-driven research on the theory and application of argumentation in all areas related to AI. The handbook's goals are to:

1. Encourage collaboration and knowledge discovery between members of the argumentation community.
2. Provide a platform for PhD students to have their work published in a citable peer-reviewed venue.
3. Present an indication of the scope and quality of PhD research involving argumentation for AI.

The papers in this volume are those selected for inclusion in OHAAI Vol.2 following a back-and-forth peer-review process. The volume thus presents a strong representation of the contemporary state of the art research of argumentation in AI that has been strictly undertaken during PhD studies. Papers in this volume are listed alphabetically by author. We hope that you will enjoy reading this handbook.

Editors

Federico Castagna
Francesca Mosca
Jack Mumford
Ştefan Sarkadi
Andreas Xydis

June 2021

Acknowledgements

We thank the senior researchers in the area of Argumentation and Artificial Intelligence for their efforts in spreading the word about the OHAAI project with early-career researchers.

We are especially thankful to Henry Prakken and the COMMA 2020 organisers for providing us the opportunity to promote the OHAAI project at their conference.

We are also grateful to ArXiv for their willingness to publish this handbook.

Our sincere gratitude to Costanza Hardouin for her fantastic work in designing the OHAAI logo.

We owe many thanks to Sanjay Modgil for helping to form the motivation for the handbook, and to Elizabeth Black and Simon Parsons for their advice and guidance that enabled the OHAAI project to come to fruition.

Special thanks must go to the contributing authors: Andreas Brännström, Federico Castagna, Théo Duchatelle, Matt Foulis, Timotheus Kampik, Isabelle Kuhlmann, Lars Malmqvist, Mariela Morveli-Espinoza, Jack Mumford, Stipe Pandžić, Robin Schaefer, Luke Thorburn, Andreas Xydis, Antonio Yuste-Ginel, and Heng Zheng. Thank you for making the world of argumentation greater!

Contents

Strategic Argumentation to deal with Interactions between Intelligent Systems and Humans <i>Andreas Brännström</i>	2
Labelling procedures for Dialectical Classical Logic Argumentation <i>Federico Castagna</i>	7
Towards a Generic Logical Encoding for Argumentation <i>Théo Duchatelle</i>	12
Computational Approaches to Fallacy Detection in Natural Language Arguments <i>Matt Foulis</i>	17
Consistency Principles for Sequential Abstract Argumentation <i>Timotheus Kampik</i>	22
Towards Eliciting Attacks in Abstract Argumentation Frameworks <i>Isabelle Kuhlmann</i>	27
Approximate Solutions to Argumentation Frameworks with Graph Neural Networks <i>Lars Malmqvist</i>	32
On the Calculation of Rhetorical Arguments Strength for Persuasive Negotiation in Multi-agent Systems <i>Mariela Morveli-Espinoza</i>	37
Learning Defeat Relations from Data Using Neural Argumentation Networks (NANs) <i>Jack Mumford</i>	42
From the Logic of Proofs to the Logic of Arguments <i>Stipe Pandžić</i>	47
Building an Argument Mining Pipeline for Tweets <i>Robin Schaefer</i>	52
Towards Argument Embeddings <i>Luke Thorburn</i>	57
A Dialogue Framework for Enthymemes <i>Andreas Xydis</i>	62
On Some Formal Relations between Arguing and Believing <i>Antonio Yuste-Ginel</i>	67
Modeling Case-Based Reasoning with the Precedent Model Formalism: An Overview <i>Heng Zheng</i>	72

Strategic Argumentation to deal with Interactions between Intelligent Systems and Humans

Andreas Brännström

Department of Computing Science, Umeå University, Sweden

Abstract

Collaborative intelligence between humans and intelligent systems relies heavily on the skills of humans and intelligent systems for reaching agreements. This requires complex dialogue processes, which include human reasoning based on common sense and goal-oriented decision-making performed by the intelligent systems, considering the human's dynamic goals and changing beliefs. This project aims to approach these challenges by studying non-monotonic reasoning techniques in the setting of strategic interaction between intelligent systems and humans. To capture the underlying logic of human reasoning, cognitive theories in logical formalizations are explored, e.g., in abstract argumentation or answer set programming. These reasoning architectures will support the decision-making process of rational agents that aim to join a given dialogue-based interaction with humans. With a particular focus on applications of persuasive technology, we see strategic argumentation as a process of decision-making for changing mental states of human agents.

1 Introduction

The human mind is in constant change, shaped by dynamic goals and changing beliefs, influenced by values, norms, perceptions of the environment and reflections of past and future events [Paglieri, 2007]. Intelligent systems designed to collaborate with humans must be able to model the human's perspec-

tive of the world and account for the human's underlying reasoning and beliefs, in order to interact meaningfully. This project explores these challenges for providing human-aware strategic decision-making and theory of mind capabilities to intelligent systems in interaction with humans, with a particular focus on applications for human behavior-change. To model human reasoning, cognitive theories are formalized in logic-based computational architectures using non-monotonic reasoning techniques, e.g., abstract argumentation [Kowalski and Toni, 1996] or answer set programming [Gelfond and Kahl, 2014]. Interaction strategies will support the decision-making process of rational agents [Georgeff and Rao, 1991] that aim to join a given dialogue-based interaction with humans.

In ongoing work [Brännström et al., 2020], we model a rational intelligent agent that plans its actions for encouraging a human to act in a social virtual reality (VR) environment (see Figure 1 [Brännström et al., 2021]).



Figure 1: Virtual cafeteria environment.

This is an interactive aid for children with autism for practicing social situations that usually are perceived as stressful to these individuals. A virtual school cafeteria is modelled. In this environment, there are sounds of people eating and talking, and the space is populated by avatars representing people. A variety of social tasks are involved, such as entering the queue, picking food, and sitting down by a table.

In order to persuade the human user to execute specific actions, the agent adapts the virtual environment by adjusting motivators in the environment. The agent's model of the human is based on the theory of planned behavior (TPB) [Ajzen et al., 1991], a cognitive theory for explaining and predicting an individual's intention to engage in a behavior. These predictions are based on the individual's attitude (A), subjective norm (SN) and perceived behavioral control (PBC) in that behavior, aggregated from the human's underlying motivational beliefs about the behavior.

The agent observes the user's actions in the environment, reasons about them, and responds by appropriate adaptations of the environment to encourage human actions, such as entering the queue to pick food, or to proceed to find a table. The system's decision process can be based on argumentation, deliberating about pros and cons in relation to the user's actions and elicited mental states, following the theoretical cognitive framework of TPB. In such a way, the system makes decisions based on arguments in order to adapt the environment and make changes in its theory of mind of the user. Arguments can be seen as (1) actions of the user, (2) estimated mental states of the user, i.e., A, SN, and PBC, (3) observations of the environment, e.g., amount of people, and (4) adaptive actions to change the environment, executed by a planner agent. We see strategic argumentation as a process of decision-making for changing mental states of the human agent.

Such an interaction can be understood as a long-term interchange of arguments between rational agents, e.g., an artificial agent and a human agent. A long-term interaction is a game of incomplete knowledge in which goals and beliefs of human agents can be private, and future actions are uncertain

[Governatori et al., 2014]. Consequently, the rational agent has knowledge gaps about a human's behavior. The agent has to acquire additional knowledge, reason to draw conclusions that fill the gaps, to make joint plans with the human. This is a complex task as the mental model of the human is based on interpretations of observed behavior that can be partially observable, dynamically changing, and ambiguous. Furthermore, the human's plans and goals can change during the interaction. Thus, the human's mental state must be determined through an indirect reasoning process where indicators to behavior are inferred through models of human reasoning. The agent's actions must be planned in relation to the estimated human behavior by making alternative hypotheses about the human's dynamic goals, i.e., predict the actions that the human might perform in the future [Chakraborti, 2018]. For this reason, the agent must be able to model human reasoning and requires strategies for choosing suitable arguments in every state of the interaction. Most of the current dialogue-based frameworks only consider complete knowledge. In these approaches, the commitments of a dialogue are inferred at the end of the dialogue, e.g., by considering argumentation semantics [Dung, 1995]. Furthermore, the problem of identifying most suitable utterances in an ongoing dialogue game is not taken into consideration [Amgoud and Prade, 2004]. This means that agents usually have no strategies for deciding which actions to perform in a dialogue-based interaction.

Strategic argumentation takes place in multi-agent systems where agents aim to reach a common understanding for decision-making or for convincing other agents of specific beliefs or intentions. A rational agent can, by modelling another agent's reasoning and beliefs, conduct strategic argumentation techniques as a process of decision-making in the interaction. To approach agent modelling in terms of human reasoning, an overall challenge and aim of this project is to formalize theories from Cognitive Science into formal computational models that can be utilized by intelligent software agents in strategic interaction with humans.

2 Method

Based on cognitive theories, formal models are defined and placed in the setting of specific use-cases. In this process, qualitative research methods such as Grounded theory [Sbaraini et al., 2011] are conducted, involving participatory design methods with experts and users. Knowledge of the specific domain is acquired and a use-case specific theory is shaped that captures relevant aspects of the human domain. This process verifies relationships and principles in the specific domain that corresponds to relevant cognitive frameworks. This is an iterative process that integrates formal modelling with data-collection and qualitative analysis. Through the explicit data of specific use-cases we can define goals, values, norms, attitudes in terms of arguments and argumentation semantics. These results will help to define decision processes of rational agents which are integrated in dialogue system environments and evaluated in interaction with humans.

In a qualitative study with autism experts [Brännström et al., 2021], in relation to an ongoing project earlier presented in this paper, we found that the choice of motivation in a moment depends on an individual’s current motivational beliefs. By assuming that the current mental state of an individual can be sufficiently recognized, i.e., the attitude (A), subjective norm (SN), and perceived behavioral control (PBC), and valued in the scale negative (inhibiting behavior), medium (indifferent to behavior) and positive (promoting behavior), the experts were asked which source of motivation that is most influential in a moment depending on the person’s current mental state. E.g., if the person currently has a mental state where A is negative, SN is negative and PBC is negative, then which aspect should be prioritised to increase? If so, what about a similar case where A is medium? By following this approach, 27 states are specified, each state consisting of the variables A, SN, or PBC, in which each variable has a value of negative (N), medium (M), or positive (P). Following the experts’ suggestions, we can specify a state space with transition relations between states that represents a prioritised change of A, SN or PBC depending on the recognized mental state of the hu-

man. We can model these relations in terms of an argumentation graph in a rational agent’s decision process for changing human mental states (see Figure 2 [Brännström et al., 2021]).

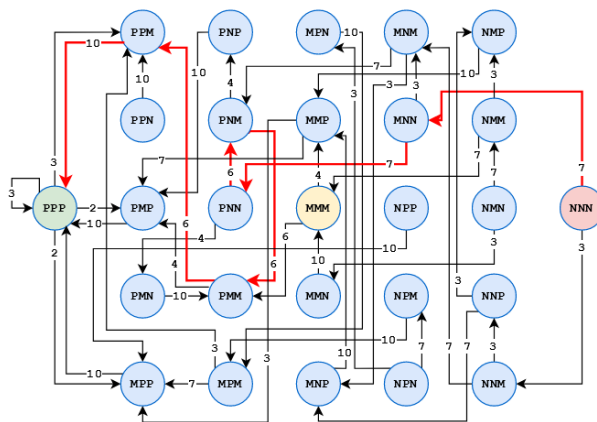

Figure 2: Motivation decision-system. This graph represents a system with states corresponding to human mental states in terms of TPB, i.e., the variables A, SN, and PBC, where each variable has the value of negative (N), medium (M) or positive (P). Transitions correspond to the most influential changes of motivation in a moment. The bold arrow (also in red) is the most prioritized path according to the experts.

In formal argumentation, a TPB model can be created as follows. We (roughly) have a value-based argumentation framework [Bench-Capon, 2003] $VAF = (AR, AT, V, val, P)$, where AR is a set of arguments, $AT \subseteq AR \times AR$ denotes the attack relation¹ on AR , V is a set of values, val is a function that maps elements of AR to elements of V , and P is a set of binary relations on V . For an argumentation-based TPB model, we then have $P = \langle Pref_{s_A}, Pref_{s_{SN}}, Pref_{s_{PBC}} \rangle$, where $Pref_{s_A}$ models attitude preferences, $Pref_{s_{SN}}$ models social norm preferences, and $Pref_{s_{PBC}}$ models behavioral control preferences². To model a dialogue, we then generate a sequence of expansions

¹Note that AT is irreflexive.

² $Pref_{s_A}, Pref_{s_{SN}}, Pref_{s_{PBC}}$ are transitive, irreflexive, and asymmetric.

of our argumentation-based TPB model, and resolve these expansions considering relational consistency principles like reference independence or cautious monotony [Kampik and Nieves, 2021] to ensure the conclusions inferred at different dialogue stages are, roughly speaking, aligned with each other.

3 Discussion

A fundamental issue in the process of a dialog-based interaction is to recognize the cause of an agreement or a disagreement in an ongoing dialogue. We can approach this by exploring theories regarding how human beliefs and attitudes are affected by alternative past and future choices and events, in psychology referred to as counterfactual thinking (CT) [Epstude and Roese, 2008]. A theory related to CT regards the occurrence of *cognitive dissonance* [Cooper, 2011] in a decision-maker. Cognitive dissonance refers to a situation involving conflicting attitudes, beliefs or behaviors. This produces a feeling of mental discomfort leading to an alteration in one of the attitudes, beliefs or behaviors to reduce the discomfort and restore balance. Cognitive dissonance makes an individual sensitive to: (a) changing their existing beliefs, (b) adding new beliefs, or (c) reducing importance of beliefs. When it comes to making decisions, we are usually not presented with one perfect option, which means we have to weigh one imperfect option against another. This creates dissonance. The dissonance may come up before or after a decision has been made, and in the latter case lead the person to rationalize why the choice was made; Making a choice does not automatically make the positive attributes of the other choice go away. Thus, the person is in this state sensitive to new beliefs to be convinced that the right decision was made. We hypothesize that a dissonance theoretical framework can be formalized by formal argumentation.

Reasoning about causality in a dialogue is close to the area of story understanding where humans form a comprehension model while reading a story and revise it as new information comes in. A related work proposes a system for automated narrative comprehension [Diakidoy et al., 2015], interest-

ing for the present study where we hypothesize that a narrative comprehension and generation dialogue-framework can be formalized by formal argumentation and formal dialogue games [Prakken, 2005].

4 Conclusion

Collaborative intelligence between humans and intelligent systems, e.g., persuasive systems for facilitating behavior-change, relies on the system’s ability of modelling the human’s reasoning, changing beliefs and dynamic goals, in order to form agreements. Approaching these challenges, the present project aims to formalize cognitive theories in order to capture human reasoning in formal computational models using non-monotonic reasoning techniques. Formal argumentation is applied as a process of decision-making for changing mental states of human agents in a strategic interaction.

Future work involves evaluating strategic reasoning processes in interactions between intelligent systems and humans. Computational soundness, theory of mind, as well as ethical implications and usefulness, of an agent’s strategic argumentation will be evaluated to further advance the models. We implement proof-of-concept prototypes of the systems aiming to validate and verify our approach in real use-cases, by considering functional and human requirements in line with ethics guidelines for responsible artificial intelligence [Dignum, 2019]. Evaluations are conducted in mixed-reality settings, i.e., virtual reality or augmented reality. Mixed-reality opens up new inspiring opportunities for human-system interaction which will be explored throughout this project.

Acknowledgements

The author thanks Juan Carlos Nieves, Virginia Dignum and Timotheus Kampik for guidance and valuable insights in this project. This work was partially funded by the Knut and Alice Wallenberg Foundation.

References

- [Ajzen et al., 1991] Ajzen, I. et al. (1991). The theory of planned behavior. *Organizational behavior and human decision processes*, 50(2):179–211.
- [Amgoud and Prade, 2004] Amgoud, L. and Prade, H. (2004). Reaching agreement through argumentation: A possibilistic approach. *KR*, 2004:175–182.
- [Bench-Capon, 2003] Bench-Capon, T. J. (2003). Persuasion in practical argument using value-based argumentation frameworks. *Journal of Logic and Computation*, 13(3):429–448.
- [Brännström et al., 2020] Brännström, A., Kampik, T., and Nieves, J. C. (2020). Towards human-aware epistemic planning for promoting behavior-change. In *Workshop on Epistemic Planning (EpiP)@ ICAPS, Online, October 26-30, 2020*.
- [Brännström et al., 2021] Brännström, A., Nieves, J. C., Kampik, T., Domellöf, E., Gu, L., and Liljeström, M. (2021). Human-aware planning in virtual reality for facilitating social behavior in autism. Manuscript submitted for publication.
- [Chakraborti, 2018] Chakraborti, T. (2018). *Foundations of Human-Aware Planning-A Tale of Three Models*. PhD thesis, Arizona State University.
- [Cooper, 2011] Cooper, J. (2011). Cognitive dissonance theory. *Handbook of theories of social psychology*, 1:377–398.
- [Diakidoy et al., 2015] Diakidoy, I.-A., Kakas, A., Michael, L., and Miller, R. (2015). Star: A system of argumentation for story comprehension and beyond. In *2015 AAAI Spring Symposium Series*.
- [Dignum, 2019] Dignum, V. (2019). *Responsible artificial intelligence: How to develop and use AI in a responsible way*. Springer Nature.
- [Dung, 1995] Dung, P. M. (1995). On the acceptability of arguments and its fundamental role in nonmonotonic reasoning, logic programming and n-person games. *Artificial intelligence*, 77(2):321–357.
- [Epstude and Roese, 2008] Epstude, K. and Roese, N. J. (2008). The functional theory of counterfactual thinking. *Personality and social psychology review*, 12(2):168–192.
- [Gelfond and Kahl, 2014] Gelfond, M. and Kahl, Y. (2014). *Knowledge representation, reasoning, and the design of intelligent agents: The answer-set programming approach*. Cambridge University Press.
- [Georgeff and Rao, 1991] Georgeff, M. and Rao, A. (1991). Modeling rational agents within a bdi-architecture. In *Proc. 2nd Int. Conf. on Knowledge Representation and Reasoning (KR’91)*. Morgan Kaufmann, pages 473–484. of.
- [Governatori et al., 2014] Governatori, G., Olivieri, F., Rotolo, A., Scannapieco, S., and Sartor, G. (2014). Two faces of strategic argumentation in the law. In *JURIX*, pages 81–90.
- [Kampik and Nieves, 2021] Kampik, T. and Nieves, J. C. (2021). Abstract argumentation and the rational man. *Journal of Logic and Computation*. exab003.
- [Kowalski and Toni, 1996] Kowalski, R. A. and Toni, F. (1996). Abstract argumentation. In *Logical Models of Legal Argumentation*, pages 119–140. Springer.
- [Paglieri, 2007] Paglieri, F. (2007). Changing minds: the role of beliefs in cognitive dynamics. *Synthese*, pages 163–166.
- [Prakken, 2005] Prakken, H. (2005). Coherence and flexibility in dialogue games for argumentation. *Journal of logic and computation*, 15(6):1009–1040.
- [Sbaraini et al., 2011] Sbaraini, A., Carter, S. M., Evans, R. W., and Blinkhorn, A. (2011). How to do a grounded theory study: a worked example of a study of dental practices. *BMC medical research methodology*, 11(1):128.

Labelling procedures for Dialectical Classical Logic Argumentation

Federico Castagna

Department of Informatics, King's College London, UK

Abstract

The 3-value (IN, OUT, UNDEC) labellings method is a well-known approach for evaluating the arguments of an argumentation framework (AF). Similarly to the extension-based approach, the labelling method assigns a status to each argument in the AF according to its acceptability.

Dialectical Classical logic Argumentation (Dialectical Cl-Arg) is a novel approach that provides real-world dialectical characterisations of Cl-Arg arguments by resource-bounded agents while preserving the rational criteria established by the rationality postulates.

This research combines both subjects and introduces labellings and labelling procedures for Dialectical Cl-Arg, highlighting the properties enjoyed by these labellings (called 'dialectical labellings') in comparison with the standard ones. Algorithms designed for dialectical labellings will benefit from such properties and the entailed efficiency improvements.

Another valid method for computing justified arguments is through the argument labelling approach based on the 3-value labellings: IN, OUT, UNDEC [Caminada, 2006]. Particularly, the label IN indicates that the argument is justified (under one of Dung's semantics), OUT indicates that the argument is overruled, and UNDEC indicates that the status of the argument is undecided (since there is not enough information to justify or overrule it). Argument labellings intuitively encode the extension-based approach and the *reinstatement* principle¹. Indeed, the correlations existing between argument labellings and argument extensions have been thoroughly investigated in the literature. For example, [Caminada and Gabbay, 2009] formally proved that *s-labellings are equivalent to s-extensions for $s \in \{\text{admissible, complete, grounded, preferred, semi-stable, stable}\}$* . Finally, employing the 3-value labellings method, many algorithms have been designed to address the main reasoning problems (i.e., enumeration, verification, sceptical and credulous acceptance of arguments) for a variety of semantics.

1 Introduction

Argumentation has been developed as a theory able to characterise the essence of non-monotonic reasoning through the dialectical interplay of arguments [Dung, 1995]. Intuitively, in order to determine if a piece of information is reliable, it suffices to show that the argument (in which the specific information is embedded) is justified under one of Dung's semantics. A way of doing this is to show the membership of the argument to an admissible extension (extension-based approach).

Notice that, although a plethora of works has successfully shown instantiations of Dung's abstract argumentation framework (AF) and reached different goals, none of these approaches managed to closely approximate the dialectical accuracy of an everyday real-world interplay of arguments. Nonetheless, some steps have been made in this direction, for instance,

¹The reinstatement principle can be summarized by the words of [Horty, 2001]: "Even certain defeated arguments should be regarded as justified, as long as the arguments defeating them are themselves defeated."

with the introduction of the rationality postulates for AF instantiations ([Caminada and Amgoud, 2007] and [Caminada et al., 2012]).

Stemming from a novel approach that provides real-world dialectical characterisations of AF by resource-bounded agents while preserving the rationality postulates ([D’Agostino and Modgil, 2018]), this paper will give a short description of how to handle labellings ‘dialectically’. The result yields labellings and labelling procedures for Dialectical Cl-Arg (fully-fledged developed as part of my PhD research). These *dialectical labellings* provide two main advantages: (1) procedural dialectical shortcuts in designing labelling algorithms; (2) a theoretical-accurate approximation of real-world uses of arguments by resource-bounded agents.

2 Method

This research made use of (a) the labelling method presented in [Modgil and Caminada, 2009] in order to develop dialectical labellings for (b) Dialectical Cl-Arg [D’Agostino and Modgil, 2018].

(a) This method describes the properties and the rules that determine the legality of the 3-value standard labellings approach, along with the main procedures involving them:

- A labelling \mathcal{L} of an AF can be seen as a tuple $(\text{in}(\mathcal{L}), \text{out}(\mathcal{L}), \text{undec}(\mathcal{L}))$ where each argument of the framework is labelled either IN, OUT or UNDEC. Notice that different semantics have different definitions in terms of \mathcal{L} . For example, an admissible labelling \mathcal{L} corresponds to a labelling without illegally IN and illegally OUT arguments.
- The core procedural aspect is based on the idea of gradually modifying the illegal labels assigned to the arguments of an AF. It begins with the all-IN labelling and proceeds with the performance of a *transition step* that will change an argument illegally IN to OUT (which,

in turn, will change to UNDEC if the step has made it illegally OUT). This procedure will then be iterated (generating, in this way, a *transition sequence*) until there will be no more illegally IN arguments. It can be shown that the result of a transition sequence constitutes an admissible labelling.

(b) Dialectical Cl-Arg builds a formalization, for Classical Logic Argumentation ², that considers real-world dialectical exchanges of arguments by resource-bounded agents. This entails:

- A new internal structure of the arguments is employed.
- Due to the limited availability of resources to real-world agents, only a subset of all the arguments of the AF will be taken into account (namely, *pdAF*) while still preserving satisfaction of the rationality postulates.
- The subset minimality and the consistency check on the premises, required by Cl-Arg, are computationally unfeasible for resource-bounded agents. This is why the properties of Dialectical Cl-Arg allow to eschew them while still preserving satisfaction of the rationality postulates.

3 Discussion

The development of the dialectical labelling approach requires adapting the results achieved in [Modgil and Caminada, 2009] without losing track of the unique features of Dialectical Cl-Arg. The most problematic of such features is the different internal structure of the arguments since it includes *suppositions*. To clarify, assume that $X = (\Delta, \Gamma, \alpha)$ is a Dialectical Cl-Arg argument, while $X' = (\Delta, \alpha)$ is a Cl-Arg argument. Δ and α are called, respectively, premises (Prem) and conclusion,

²Detailed descriptions of Classical Logic Argumentation can be found in [Besnard and Hunter, 2008] and [Gorogiannis and Hunter, 2011].

while Γ represents the suppositions (Supp). In general, when challenging the acceptability of an argument with respect to an admissible set \mathcal{S} (the so-called *dialectical defeat*³), the defeating argument can suppose premises from all the arguments in \mathcal{S} . Whereas, the argument that defends \mathcal{S} can only suppose the premises of the defeating argument. In terms of dialectical labellings, the set \mathcal{S} corresponds to the set of arguments labelled IN, as shown by the dialectical legal labelling definition:

Definition 1 (Dialectical legal labelling). *Let $d\mathcal{L}$ be a dialectical labelling for the pdAF $\langle AR, \text{defeats} \rangle$. Let also $X, Y \in AR$ and $\mathcal{S} = \text{in}(d\mathcal{L})$.*

- *X is dialectically legally IN iff X is dialectically labelled IN and for every Y that dialectically defeats X , i.e., $Y \Rightarrow_{\mathcal{S}} X$, it implies that Y is dialectically labelled OUT;*
- *X is dialectically legally OUT iff X is dialectically labelled OUT and there is at least one Y that dialectically defeats X , i.e., $Y \Rightarrow_{\{X\}} X$, such that Y is dialectically labelled IN;*
- *X is dialectically legally UNDEC iff X is dialectically labelled UNDEC and not every Y that dialectically defeats X , i.e., $Y \Rightarrow_{\{X\}} X$, is such that Y is dialectically labelled OUT, and there is no Y that dialectically defeats X such that Y is dialectically labelled IN.*

Observe that if a dialectically labelled argument X is not legally labelled, it is considered *illegally* labelled. Moreover, if X is illegally IN and is defeated by a legally IN or UNDEC argument, X is deemed as *super-illegally* IN.

Notice that Definition 1 implies that dialectical defeats can affect dialectical labellings and vice versa. As an example, consider Figure 1. Frame 2) depicts an argument X which is (changed to) legally OUT due to a dialectical defeat moved by an argument Y . To defeat X (frame 1), Y supposes premises from

³Indeed, the considered pdAFs are based on the defeat relation among arguments (defined by a strict partial ordering $<$ over the arguments of the framework) rather than the regular attack relation.

X and \mathcal{S} (where \mathcal{S} corresponds to $\text{in}(d\mathcal{L})$ according to Definition 1). However, if the supposed premises are no longer available to Y (because X is no longer a member of $\mathcal{S} = \text{in}(d\mathcal{L})$), the dialectical defeat will be ‘invalidated’, meaning that the legally OUT label of X will become illegal (frame 3). Although the addition of suppositions and the reference to a set \mathcal{S} complicate the formalisms of the labelling procedures, it also enables additional dialectical shortcuts, better approximating a real-world reasoning process. Similarly to transition sequences,

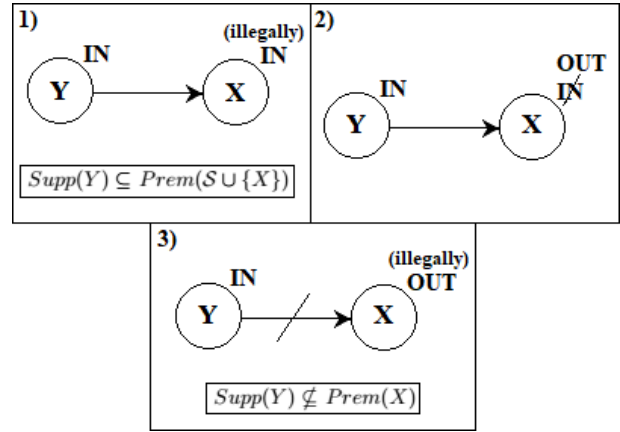

Figure 1: An example of how dialectical defeats can affect dialectical labellings and vice versa.

dialectical transition sequences procedurally generate admissible extension for Dialectical CI-Arg and are broadly employed as sub-routines for dialectical labelling algorithms.

Dialectical labellings properties

In the following, we are going to list the main features enjoyed by the dialectical labelling approach in comparison with the standard (non-dialectical) labellings. Among these, we will only consider the properties inherited from Dialectical CI-Arg deemed useful for this purpose (in particular, properties involving elementary⁴ and logically equivalent

⁴Elementary arguments are arguments of the kind $X = (\{\alpha\}, \emptyset, \alpha)$, where α is a classical logic well-formed-formula (wff).

arguments ⁵):

- (1) Set \mathcal{S} *The set of arguments dialectically IN corresponds to the admissible set \mathcal{S} targeted by the dialectical defeats. That is to say, $\text{in}(d\mathcal{L}) = \mathcal{S}$.*
- (2) $d\mathcal{L} = \text{all-IN}$ *Dialectical all-IN labellings have the special feature of always having at least one argument legally IN. Indeed, if $\text{pdAF} = \langle AR, \emptyset \rangle$ and AR is not empty, then there is (trivially) at least one legally IN argument. Otherwise, in case of conflicts, there is at least one unassailable argument which, being undefeated, is legally IN.*
- (3) Dialectically super-illegally IN arguments *In case of conflicts in a dialectical all-IN labelling, as stated in (2), Dialectical Cl-Arg properties ensure the presence of unassailable arguments that dialectically defeat the conflicting arguments. Such super-illegally IN conflicting arguments will always change their labels to dialectically legally OUT.*
- (4) Elementary arguments *In a complete $d\mathcal{L}$, for each argument dialectically legally labelled IN, all of its corresponding elementary arguments will be legally labelled IN too. The intuitive meaning is that it is illogical to defend an argument but not one of its premises.*
- (5) Logically equivalent arguments *In a complete $d\mathcal{L}$, for each argument X dialectically legally labelled IN, all of its corresponding logically equivalent arguments X' will be also legally labelled IN if $\text{Prem}(X') \subset \text{Prem}(X)$. The intuitive meaning is that it is illogical to defend an argument X but not X' where the premises in X' are a subset of the premises in X .*
- (6) Self-defeating arguments *Dialectical all-IN labellings will prevent self-defeating arguments to be members of any admissible extension by*

dialectically labelling them OUT (thanks to (3)). Indeed, no rational real-world agent would state an argument that defeats itself.

4 Conclusion

The introduced properties outline a 3-value labellings method composed of labels more aligned with the real-world uses of arguments by resource-bounded agents. In addition, algorithms that compute argument extensions by employing dialectical labellings may enhance their efficiency thanks to the described properties. Indeed, the entailed automatic assignment of labels reduces the search space of every such procedure (especially the ones involving dialectical transition sequences) improving, in this way, their efficiency. Unfortunately, the limited space prevented us to fully appreciate the extent of the formalism, which also includes dialectical labellings algorithms designed for Dung's grounded and preferred semantics.

The overall aim of my PhD is to investigate and develop proof theories and algorithms for Dialectical Cl-Arg. As part of my research, I have already explored dialectical argument games proof theories [Castagna, 2020], which approximate monological real-world reasoning processes, adapting them from the standard games presented in [Modgil and Caminada, 2009]. A natural extension of the work outlined in this paper is the generation of dialectical labellings algorithms (along with dialectical argument games) for computing stable ([Caminada and Wu, 2009]), semi-stable ([Caminada, 2007]) and ideal semantics ([Dung et al., 2007] [Caminada, 2011]). If time permits, another research path that will be pursued will involve the generalisation of the developed dialectical argument games to dialogues by following the guidelines of the already existing literature in the field (mainly [Prakken, 2005]). This generalisation would have the intriguing consequence of allowing the investigation to move from non-monotonic single-agent inferences to distributed non-monotonic reasoning processes.

⁵Logically equivalent arguments, say Y and Y' , are arguments that differ only for the epistemic disposition of their premises and suppositions. That is to say: $\text{Prem}(Y) \cup \text{Supp}(Y) = \text{Prem}(Y') \cup \text{Supp}(Y')$

Acknowledgements

I would like to thank S.Modgil and M.D'Agostino for their precious help and valuable suggestions: without them, this research could not have been possible.

References

- [Besnard and Hunter, 2008] Besnard, P. and Hunter, A. (2008). *Elements of argumentation*, volume 47. MIT press Cambridge.
- [Caminada, 2006] Caminada, M. (2006). On the issue of reinstatement in argumentation. In *European Workshop on Logics in Artificial Intelligence*, pages 111–123. Springer.
- [Caminada, 2007] Caminada, M. (2007). An algorithm for computing semi-stable semantics. In *European Conference on Symbolic and Quantitative Approaches to Reasoning and Uncertainty*, pages 222–234. Springer.
- [Caminada, 2011] Caminada, M. (2011). A labelling approach for ideal and stage semantics. *Argument and Computation*, 2(1):1–21.
- [Caminada and Amgoud, 2007] Caminada, M. and Amgoud, L. (2007). On the evaluation of argumentation formalisms. *Artificial Intelligence*, 171(5-6):286–310.
- [Caminada et al., 2012] Caminada, M., Carnielli, W., and Dunne, P. (2012). Semi-stable semantics. *Journal of Logic and Computation*, 22(5):1207–1254.
- [Caminada and Wu, 2009] Caminada, M. and Wu, Y. (2009). An argument game for stable semantics. *Logic Journal of IGPL*, 17(1):77–90.
- [Caminada and Gabbay, 2009] Caminada, M. W. and Gabbay, D. M. (2009). A logical account of formal argumentation. *Studia Logica*, 93(2):109–145.
- [Castagna, 2020] Castagna, F. (2020). Argument games for dialectical classical logic argumentation. *Online Handbook of Argumentation for AI*, page 2.
- [D'Agostino and Modgil, 2018] D'Agostino, M. and Modgil, S. (2018). Classical logic, argument and dialectic. *Artificial Intelligence*, 262:15–51.
- [Dung, 1995] Dung, P. M. (1995). On the acceptability of arguments and its fundamental role in nonmonotonic reasoning, logic programming and n-person games. *Artificial intelligence*, 77(2):321–357.
- [Dung et al., 2007] Dung, P. M., Mancarella, P., and Toni, F. (2007). Computing ideal sceptical argumentation. *Artificial Intelligence*, 171(10-15):642–674.
- [Gorogiannis and Hunter, 2011] Gorogiannis, N. and Hunter, A. (2011). Instantiating abstract argumentation with classical logic arguments: Postulates and properties. *Artificial Intelligence*, 175(9-10):1479–1497.
- [Horty, 2001] Horty, J. F. (2001). Argument construction and reinstatement in logics for defeasible reasoning. *Artificial intelligence and Law*, 9(1):1–28.
- [Modgil and Caminada, 2009] Modgil, S. and Caminada, M. (2009). Proof theories and algorithms for abstract argumentation frameworks. *Argumentation in artificial intelligence*, 105129.
- [Prakken, 2005] Prakken, H. (2005). Coherence and flexibility in dialogue games for argumentation. *Journal of logic and computation*, 15(6):1009–1040.

Towards a Generic Logical Encoding for Argumentation

Théo Duchatelle

IRIT, Université Paul Sabatier, Toulouse, France

Abstract

Several enrichments have been proposed for Dung abstract argumentation framework. These enrichments modify the standard setting by adding extra properties, thus changing the way arguments (and possibly other elements) are selected. The use of logical tools to encode and capture the original framework and some of its enrichments, have already been proposed. We extend these works by proposing a generic logical encoding which aims at being as modular as possible and which enables, by its genericity, not only to encompass the existing encodings, but also to define encodings for enriched frameworks that have not yet been studied through this scope.

1 Introduction

The formalism of abstract argumentation was introduced by [Dung, 1995]. This formalism models abstract entities which represent *arguments*, as well as an *attack* relation between them. The goal is then to select acceptable arguments in what are called *extensions*. Dung proposed several ways to select arguments such that a given extension satisfies some desirable properties; this is the notion of *semantics*.

Following Dung's paper, several works proposed to extend the initial framework. A first enrichment, developed in [Nielsen and Parsons, 2006] and pursued in [Flouris and Bikakis, 2019], is to consider coalitions of arguments: more than one argument attack another one together. [Boella et al., 2010, Nouioua and Risch, 2011, Oren and Norman, 2008] considered a second, positive, relation between the

arguments, the support relation. Relations which can target other relations directly are yet another enrichment: they are called higher-order relations [Baroni et al., 2011, Cayrol et al., 2017]. Other works have studied abstract argumentation using formal logic. Some of these works aim at giving a logical encoding of a framework and of its extensions under a given semantics (see [Besnard and Doutre, 2004, Walicki and Dyrkolbotn, 2012]). However, research in this area has mainly focused on specific frameworks, enriched or not. Other works, like Abstract Dialectical Frameworks, use logic to generalise argumentation frameworks (see [Brewka et al., 2018]).

The purpose of this paper is to propose a generic method of logical encoding for argumentation frameworks. This logical encoding should allow to retrieve the encodings which have already been defined previously. The aim is also to cover cases for which no logical encoding exists yet. By doing so, we wish to characterise in logical terms the core mechanisms common to all frameworks, no matter the number or nature of enrichments involved. In addition, such a generic encoding would provide solid foundations for the study of abstract argumentation at a general level using logical tools. The main principles of this approach are presented here by considering two enrichments: coalitions and higher-order relations. The encoding method is illustrated on frameworks which embed two, one, or none of these enrichments, using the *conflict-free* semantics. A preliminary full approach can be found in [Duchatelle, 2020]. This work is part of my PhD, whose overall goal is the study of AI systems able to provide explanations, using logic and argumentation.

2 Method

The definition of the generic logical encoding follows the *model checking* method of [Cayrol and Lagasque-Schiex, 2020]. It aims at verifying that a logical model satisfies some properties. The idea here is to build a logical base, that is, a set of logical formulas, which characterises the extensions of the framework under a given semantics. Each model of the logical base encodes an extension of the framework. The point is then to define the logical base so that (1) the extensions encoded by its models are indeed extensions of the framework under the given semantics and (2) for each extension of the framework under the semantics, there exists at least one model of the base that encodes it.

To encapsulate all the frameworks studied here, we use one that possesses both enrichments considered. It is defined as such: $\mathcal{A} = (\mathcal{A}, \mathcal{R}, s, t)$ where $\mathcal{A} \cap \mathcal{R} = \emptyset$, $s : \mathcal{R} \mapsto 2^{\mathcal{A}} \setminus \{\emptyset\}$ and $t : \mathcal{R} \mapsto \mathcal{A} \cup \mathcal{R}$. \mathcal{A} is the set of arguments, \mathcal{R} is the set of attacks¹, s and t map each attack to its source and target respectively. The source of an attack is understood as the argument(s) from which the attack originates, and the target as the argument being attacked. The case where all sources are singletons disables the coalitions, while the case where all targets are elements of \mathcal{A} disables the higher-order relations.

The logical language is first order logic with equality. To improve readability, bounded quantifiers will be used as such: $\forall x \in E \psi$ means $\forall x(E(x) \rightarrow \psi)$ and $\exists x \in E \psi$ means $\exists x(E(x) \wedge \psi)$. All formulas are relative to a given argumentation framework \mathcal{A} . Accordingly, we write $\mathfrak{L}_{\mathcal{A}}$ to denote the language. It does not use function symbols. The following predicates are used:

- $Arg(x)$ (x is an argument)
- $Att(x)$ (x is an attack)
- $Acc(x)$ (x is selected in the extension)
- $NAcc(x)$ (x cannot be selected)
- $S(\alpha, x)$ (x is in the source of α)

¹As they are named, attacks are separate abstract entities.

- $T(\alpha, x)$ (x is in the target of α)

Now, before we explain how a logical base is built, we make explicit how we retrieve the extensions of \mathcal{A} from a model. It is done using the predicate Acc . Let I be an interpretation over $\mathfrak{L}_{\mathcal{A}}$, S_I denotes the set of accepted arguments based on I . Suppose we have a logical base $\Sigma_{cf}(\mathcal{A})$ that is meant to express the *conflict-freeness* semantics. Then, given a set $S \subseteq \mathcal{A}$, we want the following property to hold:

Property 1 (Logical conflict-freeness). *S is conflict-free iff there exists a model I of $\Sigma_{cf}(\mathcal{A})$ such that $S = S_I$.*

Semantics in argumentation frameworks with higher-order relations are defined according to a set $S \subseteq \mathcal{A}$ and a set $\Gamma \subseteq \mathcal{R}^2$. Accordingly, for an interpretation I over $\mathfrak{L}_{\mathcal{A}}$, Γ_I denotes the set of accepted attacks based on I . We thus obtain the following property:

Property 2 (Logical higher-order conflict-freeness). *(S, Γ) is conflict-free iff there exists a model I of $\Sigma_{cf}(\mathcal{A})$ such that $S = S_I$ and $\Gamma = \Gamma_I$.*

Properties 1 and 2 represent the results that we want to obtain. They are used to prove that the formulas used to build a logical base are correct, i.e. indeed encode the desired semantics (*conflict-freeness* in this case).

We now turn to how a logical base is built so that such properties hold. Suppose that $\mathcal{A} = \{e_1, \dots, e_k\}$, $\mathcal{R} = \{e_{k+1}, \dots, e_l\}$ where $1 \leq k \leq l$. The following formulas encode the framework:

$$\text{for all } a \in \mathcal{A}, \quad Arg(a) \wedge \neg Att(a) \quad (1a)$$

$$\text{for all } \alpha \in \mathcal{R}, \quad \neg Arg(\alpha) \wedge Att(\alpha) \quad (1b)$$

$$\text{for all } e_i, e_j \in \mathcal{A} \cup \mathcal{R} \text{ s.t. } i \neq j, \quad \neg(e_i = e_j) \quad (1c)$$

$$\forall z (z = e_1 \vee \dots \vee z = e_l) \quad (1d)$$

$$\text{for all } \alpha \in \mathcal{R}, \left(\bigwedge_{y \in s(\alpha)} S(\alpha, y) \right) \wedge \left(\bigwedge_{z \in t(\alpha)} T(\alpha, z) \right) \quad (1e)$$

(1a) and (1b) encode respectively the arguments and the attacks of the framework (what is an argument is not an attack and vice-versa). (1c) and (1d)

²A couple (S, Γ) is called a *structure*.

say that each element of the framework is distinct and that all elements of the interpretation's domain refer to an element of the framework. (1e) encodes the sources and targets of the attacks.

Let us now define formulas that capture the semantics. As mentioned previously, we will evoke the case of *conflict-freeness*. The basic idea of *conflict-freeness* is that, for each attack, if its source is selected in the extension, then its target cannot be selected (otherwise a conflict would arise). However, its expression may vary from one argumentation framework to another depending on its potential enrichments. For example, let us consider an argumentation framework without coalitions. In this case, before defining the semantics for this framework, its encoding must be completed with (2). This axiom expresses that the source of each attack contains a single argument.

$$\begin{aligned} \forall \alpha \in Att(\forall a \in Arg(\forall b \in Arg[\\ (S(\alpha, a) \wedge S(\alpha, b) \rightarrow a = b])) \end{aligned} \quad (2)$$

Conflict-freeness is described by (3) when the framework contains no higher-order relations. The meaning of (3) is “if the source of an attack is selected to be in an extension, then its argument target is not”. Similarly, *conflict-freeness* is described by (4) when higher-order relations are present. The meaning of (4) is “if the source of an attack and the attack itself are selected, then its target is not”.

$$\begin{aligned} \forall \alpha \in Att((\forall a \in Arg[S(\alpha, a) \rightarrow Acc(a)]) \\ \rightarrow (\exists x \in Arg[T(\alpha, x) \wedge NAcc(x)])) \end{aligned} \quad (3a)$$

$$\forall x \in Arg(NAcc(x) \rightarrow \neg Acc(x)) \quad (3b)$$

$$\begin{aligned} \forall \alpha \in Att((\forall a \in Arg[S(\alpha, a) \rightarrow Acc(a)] \wedge Acc(\alpha)) \\ \rightarrow (\exists x \in Arg \cup Att[T(\alpha, x) \wedge NAcc(x)])) \end{aligned} \quad (4a)$$

$$\forall x \in Arg \cup Att(NAcc(x) \rightarrow \neg Acc(x)) \quad (4b)$$

Thus, in the case of frameworks without coalitions, $\{(1), (2), (3)\}$ is a logical base that satisfies the logical

conflict-freeness property and $\{(1), (2), (4)\}$ is a logical base that satisfies the logical higher-order conflict-freeness property. Let us make the following observation: while not being exactly the same, the syntactic structures of formulas (3) and (4) are still very similar. Our idea is to exploit these structural similarities in order to define one generic logical encoding.

The generic aspect of this logical encoding relies on the use of parameters. Because these parameters are not instantiated at the generic level, the encoding would encode the core mechanism of the semantics that are common to all types of argumentation frameworks. Then, to retrieve the expressions relative to each type of framework, one would only need to instantiate the parameters of the generic encoding.

In the case of (3) and (4), the difference lies on the premise of the first formula and on the boundary of the quantifiers in the conclusion of the first formula and in the second one. Let us then add two predicates, *Activable* and *Cand*, and use them to write a generic form of (3) and (4). (5) encodes the fundamental way of working of *conflict-freeness*: if an attack is “effective”, then its target cannot be selected in an extension. *Activable* can thus be understood as representing the condition for an attack to be “effective”. This condition is specific to each type of argumentation framework. For frameworks without higher-order relations, an attack is “effective” if and only if all the arguments of its source are selected. In the case of higher-order relations the attack itself must also be selected. As for *Cand*, it can be understood as representing the elements that can be part of an extension (arguments and attacks with higher-order relations, only arguments without).

$$\begin{aligned} \forall \alpha \in Att(Activable(\alpha) \\ \rightarrow (\exists x \in Cand[T(\alpha, x) \wedge NAcc(x)])) \end{aligned} \quad (5a)$$

$$\forall x \in Cand(NAcc(x) \rightarrow \neg Acc(x)) \quad (5b)$$

To retrieve (3) and (4), we use these instantiations.

$$\begin{aligned} \forall x(Activable(x) \leftrightarrow \\ \forall a \in Arg[S(x, a) \rightarrow Acc(a)]) \end{aligned} \quad (6a)$$

$$\forall x(Cand(x) \leftrightarrow Arg(x)) \quad (6b)$$

$$\forall x(Activable(x) \leftrightarrow (\forall a \in Arg[S(x, a) \rightarrow Acc(a)] \wedge Acc(x))) \quad (7a)$$

$$\forall x(Cand(x) \leftrightarrow (Arg(x) \vee Att(x))) \quad (7b)$$

$\{(1), (2), (5), (6)\}$ satisfies the logical conflict-freeness property and $\{(1), (2), (5), (7)\}$ satisfies the logical higher-order conflict-freeness property. Since it is (2) that constrains the absence of coalitions in the argumentation frameworks encoded with this method, it suffices to remove it from the logical base to consider frameworks with coalitions. Thus, in the case of frameworks with coalitions, $\{(1), (5), (6)\}$ satisfies the logical conflict-freeness property and $\{(1), (5), (7)\}$ satisfies the logical higher-order conflict-freeness property. This shows that frameworks with coalitions work fundamentally in the same way as frameworks without. In this respect, axiom (2) can be seen as a parameter of its own, inside the generic logical encoding.

3 Discussion

While only *conflict-freeness* was discussed in this paper, the method of generic logical encoding presented can be used to express the other usual semantics defined in [Dung, 1995], the *admissible*, *complete*, *preferred*, *grounded* and *stable* semantics. Moreover, the encoding is defined so that it can express these semantics for all types of argumentation frameworks obtainable with the combinations of the three enrichments presented in the introduction: coalitions, higher-order relations and the support relation.

It should however be pointed out that higher-order relations and the support relation have several interpretations. That is to say, there are several ways to modify the usual semantics once one of these enrichments is present in a framework. For now, only the interpretation of higher-order relations as RAF semantics, presented in [Cayrol et al., 2017], and the interpretation of the support relation as evidential support (see [Oren and Norman, 2008]) are taken into account. In this respect, the generic logical encoding encompasses the more specific logical encodings presented in [Cayrol and Lagasque-Schiex, 2020].

As future work, we wish to extend our generic logical encoding to include the missing interpretation of higher-order relations, namely the AFRA semantics, discussed in [Baroni et al., 2011]. Similarly, we wish to take into account the other interpretations of the support relation, namely the deductive support ([Boella et al., 2010]) and the support with necessities ([Nouioua and Risch, 2011]). While the AFRA semantics should fit into the work that has already been done, we have the intuition that the evidential support works in such a specific way that it will not be possible to express all three interpretations of the support relation using the same generic logical formulas. However, since the support with necessities and the deductive support are very closely linked, it should be possible to include both of them in the same generic logical theory. Works on Abstract Dialectical Frameworks have shown that some relations cannot be expressed using a two-valued logic in some cases. Abstract argumentation falls in these cases. Hence, there is certainly an underlying three-valued logic in our method, which should be investigated.

4 Conclusion

To conclude, we presented a method of generic logical encoding for abstract argumentation. The objective of this encoding is to factor as much as possible the selection mechanisms of the usual semantics that are common to a variety of argumentation frameworks, and to retrieve the cases of specific frameworks via the parameterization of these mechanisms. For now, the encoding encompasses the argumentation frameworks that can be defined using the combinations of three enrichments: coalitions, the RAF interpretation of higher-order relations and the evidential interpretation of the support relation.

Acknowledgements

I wish to thank my PhD supervisors, Ph. Besnard, M.-Ch. Lagasque-Schiex and S. Doutre for their advices and support, as well as the CIMI LabEx for supporting my PhD.

References

- [Baroni et al., 2011] Baroni, P., Cerutti, F., Giacomin, M., and Guida, G. (2011). AFRA: Argumentation framework with recursive attacks. *International Journal of Approximate Reasoning*, 52(1):19–37.
- [Besnard and Doutre, 2004] Besnard, P. and Doutre, S. (2004). Checking the acceptability of a set of arguments. In *NMR 2004*, Whistler, Canada, June 6-8, 2004, *Proceedings*, pages 59–64.
- [Boella et al., 2010] Boella, G., Gabbay, D. M., van der Torre, L. W. N., and Villata, S. (2010). Support in abstract argumentation. In *COMMA 2010*, volume 216 of *Frontiers in Artificial Intelligence and Applications*, pages 111–122, Desenzano del Garda, Italy. IOS Press.
- [Brewka et al., 2018] Brewka, G., Ellmauthaler, S., Strass, H., Wallner, J. P., and Woltran, S. (2018). Abstract dialectical frameworks. In Baroni, P., Gabbay, D., Giacomin, M., and van der Torre, L., editors, *Handbook of Formal Argumentation*, pages 237–286 (Chapter 5). College Publications.
- [Cayrol et al., 2017] Cayrol, C., Fandinno, J., Fariñas del Cerro, L., and Lagasque-Schiex, M.-C. (2017). Valid attacks in argumentation frameworks with recursive attacks. In *COMMON-SENSE 2017*, volume 2052 of *CEUR Workshop Proceedings*, London, UK. CEUR-WS.org.
- [Cayrol and Lagasque-Schiex, 2020] Cayrol, C. and Lagasque-Schiex, M.-C. (2020). Logical encoding of argumentation frameworks with higher-order attacks and evidential supports. *International Journal on Artificial Intelligence Tools*, 29(3-4):2060003:1–2060003:50.
- [Duchatelle, 2020] Duchatelle, T. (2020). Argumentation abstraite et logique. Master’s thesis, Université de Caen Normandie, France.
- [Dung, 1995] Dung, P. M. (1995). On the acceptability of arguments and its fundamental role in nonmonotonic reasoning, logic programming and n-person games. *Artificial Intelligence*, 77(2):321–357.
- [Flouris and Bikakis, 2019] Flouris, G. and Bikakis, A. (2019). A comprehensive study of argumentation frameworks with sets of attacking arguments. *International Journal of Approximate Reasoning*, 109:55–86.
- [Nielsen and Parsons, 2006] Nielsen, S. H. and Parsons, S. (2006). A generalization of Dung’s abstract framework for argumentation: Arguing with sets of attacking arguments. In *ArgMAS 2006*, volume 4766 of *Lecture Notes in Artificial Intelligence*, pages 54–73, Hakodate, Japan. Springer.
- [Nouioua and Risch, 2011] Nouioua, F. and Risch, V. (2011). Argumentation frameworks with necessities. In *SUM 2011*, volume 6929 of *Lecture Notes in Artificial Intelligence*, pages 163–176, Dayton, OH, USA. Springer.
- [Oren and Norman, 2008] Oren, N. and Norman, T. J. (2008). Semantics for evidence-based argumentation. In *COMMA 2008*, volume 172 of *Frontiers in Artificial Intelligence and Applications*, pages 276–284, Toulouse, France. IOS Press.
- [Walicki and Dyrkolbotn, 2012] Walicki, M. and Dyrkolbotn, S. K. (2012). Finding kernels or solving SAT. *J. Discrete Algorithms*, 10:146–164.

Computational Approaches to Fallacy Detection in Natural Language Arguments

Matt Foulis

Centre for Argument Technology, University of Dundee

Abstract

One way to improve the quality of an argument and the reasoning employed is to look at the ways in which it has fallen short or erred. Fallacy theory provides us with a set of guidelines to appraise an argument and discover the most common circumstances in which these errors occur.

The goal need not be, primarily, to criticise an argument and call it a day, but rather, to develop a starting point from which a sound argument can be developed. Additionally, an understanding of fallacies provides the audience of an argument with a set of tools to prevent them from being misled and to critically appraise the arguments presented.

This paper presents the goal of our research, namely, to employ fallacy theory in a computational context. More specifically, the work aims to: develop artificial intelligence models to automatically identify fallacies; and develop a computationally focused fallacy compendium to promote further work and collaboration in this field.

1 Introduction

First developed by Aristotle [Aristotle and Barnes, 1984], fallacy theory was for a long time sidelined in logic textbooks, often being relegated to an appendix or considered unworthy of study. Prior to his seminal work in the field, Hamblin viewed the treatment of fallacies as: “as de-based, worn-out and dogmatic a treatment as could

be imagined—incredibly tradition-bound, yet lacking in logic and historical sense alike” [Hamblin, 1970]. Post-Hamblin, there has been a renewed interest in fallacy theory with extensive work on topics such as classification, identification, and structure of the various fallacies. However, fallacies themselves are often viewed by the public through their association with internet debaters’ cries of ‘Straw man!’ or ‘Ad Hominem!’. Despite this, fallacy theory can provide a valuable framework for computational based work with user-facing outputs.

One current area of research in which fallacy theory can prove useful is the identification of fallacies in fake news and misinformation. Fake news has rapidly become a major political and societal problem with extensive research being carried out into its forms, creation, identification, and prevention. (See [Sharma et al., 2019] and [Zhou and Zafarani, 2020] for a survey of current techniques and approaches). Within fake news, fallacies such as *cherry picking*, *red herring*, and *straw man* are used in an effort to present misleading and incorrect arguments to the audience.

Misleading arguments are not only found within fake news, however. With so much of our engagement with arguments taking place on platforms such as social media, there is an opportunity for computational tools to analyse the data produced and provide assistance both with argument creation and an understanding of misleading or incorrect arguments. Advances in Argument Mining have demonstrated the benefits that computational solutions can provide in not only locating where an argu-

ment is within the text, but providing further insights and critical evaluation of the argument itself [Lawrence and Reed, 2020]. Whilst current argument mining techniques are valuable, there is an opportunity for automatic fallacy identification to tackle a different problem and provide important benefits to argument evaluation, analysis, and construction. Being able to automatically identify fallacies within a piece of text and present this information to a user would allow them to gain an understanding of why the argument is invalid or misleading and about the common ways in which this can occur. This knowledge could then inform their future interactions with arguments.

This paper will discuss how a focus on fallacies within a computational context can help with such tasks and outline the research planned for this work.

2 Method

One approach to understanding and dealing with fallacies is to consider them within the context of a dialogue. [Walton and Krabbe, 1995] argued that by looking at the shifts between dialogue types, it is possible to gain a better understanding of certain fallacies. If an *ad baculum* or ‘appeal to force’ argument is used in what started as a persuasion dialogue, this would be inappropriate and may be an indication that the argument is fallacious and an illicit shift of dialogue type has occurred.

As well as a shift between dialogue types, fallacies can also be identified as the breaking of a rule of the dialogue. The pragma-dialectic theory [Grootendorst and Van Eemeren, 1992] lays out the rules for an ‘ideal model for a critical discussion’ which aims to be a dialogue type for the resolution of an argument. [Visser et al., 2018] develop this model in a computational dialogue game as a demonstration of how such games could be used to prevent the use of fallacious arguments.

This understanding of fallacies as illicit shifts between dialogue types or as the breaking of a dialogue rule can inform the work in fallacy detection and analysis. Although many arguments may not be fallacious in the correct context, the move between

dialogue types shifts the argument from reasonable to fallacious.

This shift of dialogue type is often seen in fake news, in which fallacious arguments are used which shift the news report from a neutral statement of the facts, to a persuasion type dialogue. [Martino et al., 2020] demonstrate this with their work on the SEMEVAL shared task of identifying 18 different propaganda techniques in news articles. Many of these techniques such as *appeal to emotion* would be legitimate arguments in the right context, but when present in a news article they become fallacious and potentially misleading to a reader.

Whilst there is some overlap with work on fake news and propaganda detection, an approach focused on fallacies is worthwhile and could assist in both fake news detection and, more generally, in argumentative reasoning and evaluation. Making use of fallacy theory allows the wealth of theoretical work to be employed in a computational context.

Fallacies must first be identified so that they can be assessed and dealt with appropriately. Whilst fallacy identification has typically required human annotators with an understanding of fallacy types, recent advances in ML have demonstrated the possibility of achieving human-level results in complex tasks. For example, the tasks of language understanding and question answer identification using the BERT model [Devlin et al., 2019]. A goal of this research is, therefore, to develop artificial intelligence (AI) techniques that are capable of automatically identifying fallacies within natural language arguments.

To guide the approach taken in developing these AI techniques, consideration must be given to the type and structure of the fallacies to be identified. There exist many classifications of fallacies, however, these are typically formulated from a linguistic or logic-based perspective. Whilst there are several useful fallacy classifications, there is an opportunity for the development of a computer-based fallacy approach.

A second goal of the research, therefore, is the creation of a compendium of fallacies, based on existing fallacy theory, but with computational tasks such as automatic identification via Machine Learning methods in mind. The goal of this compendium is to create a ‘living document’ in which to describe fallacy

structure, provide examples and edge-cases, discuss linguistic and semantic indicators, and additional detection resources such as knowledge bases and context data and metadata.

A requirement of both the identification task and the compendium will be suitable datasets for the training and testing of AI techniques. One possibility is the extension of existing datasets such as US2016 from [Visser et al., 2020] and the Internet Argument Corpus v2 from [Walker et al., 2012]. These datasets could be further expanded to include labeling for both fallacies and dialogue types, including the shifts between them. Another approach involves the creation of a new dataset. Online crowd-sourcing facilities such as Amazon Mechanical Turk ¹ can allow large datasets to be created by participants based on selected criteria.

Once a suitable dataset is created, investigation into the development and testing of suitable artificial intelligence techniques can begin. As new techniques are discovered and incorporated from related fields and tasks, these can be incorporated into the fallacy compendium in an effort to promote collaborative work and progress in this task.

3 Discussion

This section presents an example of an argument type that can be classified as fallacious or not depending on the dialogue type and context. Knowing the intended dialogue type will allow us to understand if an argument has broken the rules of that type, indicating that a shift has occurred and that the argument is likely fallacious.

An appeal to emotion argument is one in which an attempt to manipulate the audience's emotions is made in an effort to bring about or support the conclusion. An example of this is *argumentum ad misericordiam* or appeal to pity. In some cases, such as a charity appeal for donations, an appeal to the audience's pity may be seen as an acceptable argumentative tactic. However, in other cases, an appeal to the emotions of the audience may be inappropriate for the dialogue type and therefore fallacious.

Let us consider an example of a political debate between two candidates for a local election. During the course of the debate, one of the participants argues:

- (1) "We must increase our foreign aid spending. There are people starving, do you not care about them?"

Whilst the conclusion of increasing foreign aid may be valid and the most appropriate course of action, the argument raised makes use of a fallacious appeal to the audience's emotion. This argument closely resembles that of a charity appeal for donations, but the difference in dialogue type indicates the fallaciousness of the argument. The dialogue begins as a debate type, which can be considered as a mixture of persuasion and eristic types. However, when presented with this appeal to emotion argument, a shift in the dialogue type can be identified, moving the dialogue from a debate, to that of a negotiation type dialogue. The goal of the speaker has moved from persuasion of the other party to ensuring their position or aim is pursued amongst the options available.

It should be noted that not all shifts in dialogue type are inherently illegitimate. There are cases where both parties may benefit from and pursue a negotiation after having initially begun the dialogue as a persuasion type. The problem, however, as Walton notes, is when the shift is illicit and one of the participants is not aware of the shift [Walton, 2010]. He argues, therefore, that the argument must at this point be evaluated based on the rules of the original dialogue type.

From our example, the importance of contextual information on our ability to perform this evaluation can be seen. This use of context has increased in argument mining tasks related to fallacy detection. [Lugini and Litman, 2020] demonstrated how including previous argumentative discourse units (ADU) from a conversation helped to improve a model's ability to correctly classify argument components. [Opitz and Frank, 2019] found that looking at context only whilst masking the content of argumentative units may in fact lead to improved prediction results. These examples demonstrate the use that dialogue context could have on the ability to detect and

¹Available at <https://www.mturk.com/>

classify fallacies.

In addition to providing AI models with this dialogical contextual information, features and indicators that describe the presence of the fallacious arguments can be developed. With this combination, the models will be able to recognise both the presence of the potentially fallacious argument, as well as a classification of fallaciousness based on the dialogue type. This understanding of context embedded into the model will allow more accurate classification to be made and improve the usefulness of the system.

4 Conclusion

In this paper, a plan of research which aims to make use of fallacy theory in a computational context has been discussed. By viewing fallacies as an illicit shift between dialogue types or as a breaking of the dialogue type's rule, this information can be used in combination with current and emerging artificial intelligence techniques to guide the work of automatic identification. Further discussed was a plan to develop a fallacy compendium to encourage collaboration and develop new approaches and methods in this field.

Acknowledgements

The author would like to thank Chris Reed and Elena Musi for their continued help and guidance. This work was funded in part thanks to ESRC grant no. ES/V003909/1.

References

- [Aristotle and Barnes, 1984] Aristotle and Barnes, J. (1984). *Sophistical Refutations*. Princeton University Press.
- [Devlin et al., 2019] Devlin, J., Chang, M.-W., Lee, K., and Toutanova, K. (2019). Bert: Pre-training of deep bidirectional transformers for language understanding.
- [Grootendorst and Van Eemeren, 1992] Grootendorst, F. v. E. and Van Eemeren, F. (1992). Argumentation, communication, and fallacies. a pragma-dialectical perspective.
- [Hamblin, 1970] Hamblin, C. L. (1970). *Fallacies*. Methuen London.
- [Lawrence and Reed, 2020] Lawrence, J. and Reed, C. (2020). Argument Mining: A Survey. *Computational Linguistics*, 45(4):765–818.
- [Lugini and Litman, 2020] Lugini, L. and Litman, D. (2020). Contextual argument component classification for class discussions. In *Proceedings of the 28th International Conference on Computational Linguistics*, pages 1475–1480.
- [Martino et al., 2020] Martino, G. D. S., Barrón-Cedeño, A., Wachsmuth, H., Petrov, R., and Nakov, P. (2020). Semeval-2020 task 11: Detection of propaganda techniques in news articles. Barcelona (online). International Committee for Computational Linguistics.
- [Opitz and Frank, 2019] Opitz, J. and Frank, A. (2019). Dissecting content and context in argumentative relation analysis.
- [Sharma et al., 2019] Sharma, K., Qian, F., Jiang, H., Ruchansky, N., Zhang, M., and Liu, Y. (2019). Combating Fake News: A Survey on Identification and Mitigation Techniques. *ACM Transactions on Intelligent Systems and Technology*, 10(3):1–42.
- [Visser et al., 2018] Visser, J., Budzynska, K., and Reed, C. (2018). A critical discussion game for prohibiting fallacies. *Logic and Logical Philosophy*, 27(4):491–515.
- [Visser et al., 2020] Visser, J., Konat, B., Duthie, R., Koszowy, M., Budzynska, K., and Reed, C. (2020). Argumentation in the 2016 us presidential elections: annotated corpora of television debates and social media reaction. *Language Resources and Evaluation*, 54(1):123–154.
- [Walker et al., 2012] Walker, M., Tree, J. F., Anand, P., Abbott, R., and King, J. (2012). A corpus

for research on deliberation and debate. In *Proceedings of the Eighth International Conference on Language Resources and Evaluation (LREC'12)*, pages 812–817, Istanbul, Turkey. European Language Resources Association (ELRA).

[Walton, 2010] Walton, D. (2010). *The Place of Emotion in Argument*. Pennsylvania State University Press.

[Walton and Krabbe, 1995] Walton, D. and Krabbe, E. (1995). *Commitment in Dialogue: Basic Concepts of Interpersonal Reasoning*. State University of New York Press.

[Zhou and Zafarani, 2020] Zhou, X. and Zafarani, R. (2020). A Survey of Fake News: Fundamental Theories, Detection Methods, and Opportunities. *ACM Computing Surveys*, 53(5):1–40.

Consistency Principles for Sequential Abstract Argumentation

Timotheus Kampik

Umeå University, Sweden

Abstract

This paper presents a principle-based perspective on ensuring consistency in sequential abstract argumentation, in which an abstract argumentation framework is iteratively *resolved* by determining its extensions and then (normally) *expanded* by adding new arguments and attacks (without changing attacks between existing arguments). As a starting point, we take *reference independence* – a key property in microeconomic theory – and derive an abstract argumentation principle from it to (roughly) stipulate that “if no new argument is accepted our conclusion remains the same”. Moreover, we introduce the cautious monotony principle, which can be colloquialized as “if no new argument attacks our conclusion we do not reject any part of this conclusion”. Cautious monotony is satisfied by many admissible set-based semantics and is not well-aligned with naive set-based semantics, whereas reference independence is satisfied by at least one of the naive set-based semantics (CF2 semantics), but is not well-aligned with the notion of admissibility.

1 Introduction

In the symbolic artificial intelligence community, formal argumentation has emerged as a popular approach to instill reasoning capabilities into intelligent systems. A foundational method of formal argumentation is *abstract argumentation* [Dung, 1995]. An abstract argumentation framework is a tuple of a set of atomic arguments and a binary relation (*attacks*) on these arguments. For example, when

we construct the argumentation framework $AF = (AR, AT) = (\{a, b\}, \{(a, b)\})$, we have the arguments a and b , and argument b is attacked by argument a . Arguments can be, for example, epistemic (let a denote the fact that it rains) or utilitarian (let b denote the action of leaving the house without an umbrella). To determine which sets of arguments in an argumentation framework can be considered valid conclusions, argumentation semantics have been defined. While it is clear that the only set of conclusions that results from the argumentation framework AF is $\{a\}$, determining conclusions is not trivial for cyclic argumentation frameworks. For example, in the argumentation framework $AF' = (AR', AT') = (\{a, b, c\}, \{(a, b), (b, c), (c, a)\})$, either no arguments ($\{\}$), or any of the sets $\{a\}$, $\{b\}$, or $\{c\}$ can be considered conclusions (depending on the semantics). Consequently, an argumentation semantics can return several argument sets that can potentially be considered valid for a given framework. Note that AF' is a *normal expansion* of AF (denoted by $AF \preceq_N AF'$), i.e., $AR \subseteq AR', AT \subseteq AT', \forall (a, b) \in AT' \setminus AT, a \in AR' \setminus AR \vee b \in AR' \setminus AR$. Given an argumentation framework $AF = (AR, AT)$, a set $S \subseteq AR$ is conflict-free, iff there is no attack between any arguments $a, b \in S$. A set $S \subseteq AR$ is admissible iff it is conflict-free and its arguments attack all arguments in AR that attack S ; a set is naive iff it is \subseteq -maximal among conflict-free subsets of AR . A set $S \subseteq AR$ is a preferred extension of AF iff it is \subseteq -maximal among all admissible sets in AF . Preferred semantics determines the preferred *extensions* of AF . Let us denote all preferred extensions of AF by $\sigma_{pref}(AF)$. Given the two example frameworks above, we have

$\sigma_{pref}(AF) = \{\{a\}\}$ and $\sigma_{pref}(AF') = \{\{\}\}$.

Many argumentation semantics exist, and it is often not clear which semantics is the most suitable one for a specific application scenario. Consequently, an important line of research on abstract argumentation is the identification of *argumentation principles* – formal properties of argumentation semantics – and the evaluation of argumentation semantics w.r.t. these principles [van der Torre and Vesic, 2017]. In our line of research, we add a new perspective to principle-based evaluation by introducing the *reference independence* principle, which serves as the point of departure for more research at the intersection of abstract argumentation and formal models of economic rationality. We derive this principle from the property of the same name that is a cornerstone of the *rational man* paradigm in microeconomic theory (see [Rubinstein, 1998]). Roughly speaking, when choosing items from a set S , a rational-decision maker’s choice $A^* \subseteq S$ implies that the decision-maker prefers A^* over all other sets in 2^S . When choosing from another set that potentially intersects with S , the implied preferences must be consistent.

Example 1. For instance, when we have an agent who can choose to consume items from a set containing tea and juice ($\{t, j\}$), her choice of juice ($\{j\}$) implies $\{j\}$ is preferred over all other sets in $2^{\{t, j\}}$. Let us assume that on another occasion, a third item – a donut – is present in the set, all other things being the same as before. Our agent chooses tea and a donut ($\{t, d\}$ from $\{t, j, d\}$). The choice implies that $\{t, d\}$ is preferred over all other sets in $2^{\{t, j, d\}}$, which is consistent with the previous choice. However, were she to choose tea ($\{t\}$ from $\{t, j, d\}$), the preference $\{t\}$ over $\{j\}$ would be inconsistent with the previously established preference $\{j\}$ over $\{t\}$.

Note that in our interpretation of the rational man model, the set of choice items does not necessarily need to refer to physical goods, but can also model courses of action, or beliefs that can be adopted or discarded. Our ambition to better integrate abstract argumentation and formal models of economic decision-making can be considered a natural continuation of work presented in the initial seminal paper on abstract argumentation, which applies argumen-

tation to the stable marriage problem of cooperative game theory [Dung, 1995].

Let us introduce and motivate the concept of reference independence in abstract argumentation with the help of a simple example.

Example 2. Let us assume the role of a strategy advisor (human or IT system) in a large corporation. We propose the launch of new products to a decision-maker who has the final say. At the moment, we are considering the launch of the products a' or b' . a' and b' are similar; however, studies show that a' is expected to outperform b' . We model this assessment as an argumentation framework $AF = (\{a, b\}, \{(a, b)\})$, where a means “launch a' ” and b means “launch b' ”. Let us assume we resolve AF using preferred semantics σ_{pref} , i.e., $\sigma_{pref}(AF) = \{\{a\}\}$. Consequently, we tell the decision-maker that she can launch a' .

Now, let us assume the decision-maker postpones her decision and asks us to come back some time later with an updated analysis. In the meantime, a new product c' is prototyped and evaluated in terms of market fit by our R&D department. According to the evaluation, the target consumer group typically prefers buying c' over a' , while they typically prefer b' over c' : $AF' = (\{a, b, c\}, \{(a, b), (b, c), (c, a)\})$. We again use preferred semantics, i.e., $\sigma_{pref}(AF') = \{\{\}\}$. However, it is clear that the decision-maker will question our sanity if we recommend her to launch no product now that more potential options are on the table¹. Indeed, the adjustment of our decision outcome from “ a' ” to “nothing” ($\{\}$) is inconsistent with the reference independence principle in microeconomic theory: the addition of the irrelevant alternatives $2^{AR'} \setminus 2^{AR}$ of argument sets we can potentially consider as acceptable makes us switch from accepting $\{a\}$ ($\{a\}$ is preferred over $\{\}$) to accepting $\{\}$ ($\{\}$ is preferred over $\{a\}$). Figure 1 depicts the example’s argumentation frameworks.

In this line of research we aim to address the problem the example highlights, while also exploring alternative ways to ensure consistency.

¹A better recommendation would be to delay the decision until more intelligence is gathered. Still, it makes sense to be able to make a somewhat reasonable decision at any point.

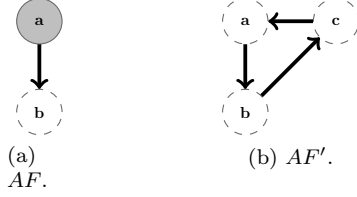

Figure 1: Reference dependence: $\sigma_{pref}(AF) = \{\{a\}\}$ and $\sigma_{pref}(AF') = \{\{\}\}$. The addition of the rejected argument c makes us discard the extension $\{a\}$ in favor of $\{\}$.

2 Consistency Principles

The motivation of the reference independence principle is to assess whether a decision-making outcome can be considered “reasonable”. In the domain of non-monotonic reasoning, the cautious monotony principle has been defined with a similar objective [Gabbay, 1985], but without making the connection to economic decision theory. In our work, we introduce these principles to abstract argumentation. We define *strong* and *weak* cautious monotony properties, similarly to the way C yras and Toni have defined cautious monotony in the context of *assumption-based argumentation* [C yras and Toni, 2015]. Let us have an argumentation semantics σ , two argumentation frameworks $AF = (AR, AT)$ and $AF' = (AR', AT')$, $AF \preceq_N AF'$, and their extensions $\sigma(AF)$ and $\sigma(AF')$. We can colloquially describe cautious monotony as follows. For each extension E in $\sigma(AF)$, we “adjust” AF' and get an AF'' in which all “new” attacks (that are in AF' , but not in AF) to E are removed.

- σ is **strongly cautiously monotonous** iff all extensions $E'' \in \sigma(AF'')$ contain E .
- σ is **(weakly) cautiously monotonous** iff there exists an extension $E'' \in \sigma(AF'')$ that contains E .

Let us highlight that other notions of *relaxed* monotony can be defined according to the same

scheme: “if condition c holds true then our inference is monotonic”. Somewhat analogously, we can describe reference independence as follows. Again, we have an argumentation semantics σ , two argumentation frameworks $AF = (AR, AT)$ and $AF' = (AR', AT')$, $AF \preceq_N AF'$, and their extensions $\sigma(AF)$ and $\sigma(AF')$.

- **Strong reference independence.** For each extension E in $\sigma(AF)$, the preferences over the argument sets in $2^{AR \cap AR'}$ implied by all extensions in $\sigma(AF')$ are consistent with the preferences implied by E .
- **(Weak) reference independence.** For each extension E in $\sigma(AF)$, the preferences over the argument sets in $2^{AR \cap AR'}$ implied by at least one extension in $\sigma(AF')$ are consistent with the preferences implied by E .

In [Kampik and Nieves, 2021a], we provide a comprehensive formal comparison of reference independence and other non-monotonic reasoning properties in the context of abstract argumentation. We also show that most (but not all) argumentation semantics are not weakly reference independent; a notable semantics that satisfies weak reference independence is CF2 semantics [Baroni et al., 2005]. By considering the argumentation frameworks $AF = (\{a\}, \{\})$ and $AF' = (\{a, b, c\}, \{(a, b), (b, c), (c, a)\})$ it is clear that any admissible set-based semantics σ_{adm} does not satisfy weak reference independence, assuming every σ_{adm} -extension always contains all unattacked arguments, from which it follows that $\sigma(AF) = \{\{a\}\}$ and $\sigma(AF') = \{\{\}\}$. In contrast, any naive set-based semantics σ_n whose extensions always contain all unattacked arguments do not satisfy weak cautious monotony, consider AF' and $AF'' = (\{a, b, c, d\}, \{(a, b), (b, c), (c, a), (d, a)\})$ and consequently $\sigma_n(AF') = \{\{a\}, \{b\}, \{c\}\}$ and $\sigma_n(AF'') = \{\{d, b\}\}$. Table 1 gives an overview of semantics that satisfy/violate weak reference independence and/or cautious monotony. See [Baroni et al., 2018] for the semantics definitions.

Table 1: Satisfaction of Weak Reference Independence (WRI) and Weak Cautious Monotony (WCM) by different argumentation semantics.

	WRI	WCM
Complete	X	✓
Preferred	X	✓
Stable	X	X
Grounded	X	✓
Semi-stable	X	✓
Ideal	X	✓
Eager	X	✓
Naive	✓	✓
Stage	X	X
CF2	✓	X
Stage2	X	X

3 Ensuring Consistency Principles

Strong reference independence is a property that is unrealistic to obtain, using only abstract argumentation. However, in *sequential* argumentation scenarios, we can draw inferences that resemble strong reference independence (*i.e.*, economically rational behavior) by making use of concepts introduced by Gabbay for the purpose of *loop-busting* [Gabbay, 2014]. We go back to Example 2, starting with $AF = (\{a, b\}, \{(a, b)\})$, which we resolve using preferred semantics as $\sigma_{pref}(AF) = \{\{a\}\}$. Because we have exactly one extension, we decide that $\{a\}$ is the set of valid arguments (*i.e.*, we recommend launching product a'). When resolving the expanded framework $AF' = (\{a, b, c\}, \{(a, b), (b, c), (c, a)\})$, $\sigma_{pref}(AF')$ returns $\{\{\}\}$. This implies inconsistent preferences with regards to how we have resolved AF (as explained in Example 1). Hence, we create an argumentation framework AF'_{an} , in which an *annihilator argument* is added to AF' , such that we have exactly one extension $E \in \sigma(AF'_{an})$ and $E \setminus \{an\}$ is an extension of AF' that implies consistent preferences with the extension $\{a\}$ we have previously determined for AF . For example, we can define AF'_{an} as $(\{a, b, c, an\}, \{(a, b), (b, c), (c, a), (an, c)\})$ so that $\sigma_{pref}(AF'_{an}) = \{\{a, an\}\}$. Given the only extension $E = \{a, an\}$, we have $E \setminus \{an\} = \{a\}$.

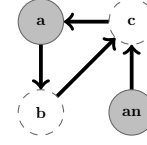

Figure 2: AF'_{an} . Solving the problem depicted in Figure 1. The annihilator approach enables us to achieve reference independence.

$E \setminus \{an\}$ is our final extension of AF' . Figure 2 depicts the argumentation AF'_{an} . In ongoing research, we work on defining formal approaches to ensure reference independence, as well as other non-monotonic reasoning principles, when resolving *sequences* of argumentation frameworks for semantics that do not fulfill these principles in general. We present an implementation of an argumentation reasoner that allows to ensure reference independence (and cautious monotony) in [Kampik and Gabbay, 2020]. In [Kampik and Nieves, 2021b], we provide an overview of how cautious monotony and reference independence can facilitate approximate agreements in argumentation scenarios, in which different agents may use different argumentation semantics.

4 Conclusion and Future Work

Future research can apply the reference independence principle to the proposed *ordering-based* semantics that intend to establish a preorder on the arguments in an argumentation framework [Skiba, 2020] and device additional relaxed monotony principles, for example based on the notion of the *burden of persuasion* in legal reasoning [Calegari et al., 2021]. On another research frontier, this line of work can potentially enable the introduction of formal argumentation as a model of economic decision-making to the microeconomics community.

Acknowledgements

This paper is a revision of *Economic Rationality and Abstract Argumentation* as presented in OHA AI Vol. 1. Thanks to D. Gabbay and J.C. Nieves. The work is supported by the Wallenberg AI, Autonomous Systems and Software Program funded by the Knut and Alice Wallenberg Foundation.

References

- [Baroni et al., 2018] Baroni, P., Caminada, M., and Giacomin, M. (2018). Abstract argumentation frameworks and their semantics. In Baroni, P., Gabbay, D., Massimiliano, G., and van der Torre, L., editors, *Handbook of Formal Argumentation. College Publications*, chapter 4, pages 159–236.
- [Baroni et al., 2005] Baroni, P., Giacomin, M., and Guida, G. (2005). Scc-recursiveness: a general schema for argumentation semantics. *Artificial Intelligence*, 168(1):162 – 210.
- [Calegari et al., 2021] Calegari, R., Riveret, R., and Sartor, G. (2021). The burden of persuasion in structured argumentation. In *Proceedings of the Nineteenth International Conference on Artificial Intelligence and Law, ICAIL '21*, New York, NY, USA. Association for Computing Machinery.
- [Čyras and Toni, 2015] Čyras, K. and Toni, F. (2015). Non-monotonic inference properties for assumption-based argumentation. In Black, E., Modgil, S., and Oren, N., editors, *Theory and Applications of Formal Argumentation*, pages 92–111, Cham. Springer International Publishing.
- [Dung, 1995] Dung, P. M. (1995). On the acceptability of arguments and its fundamental role in nonmonotonic reasoning, logic programming and n-person games. *Artificial Intelligence*, 77(2):321 – 357.
- [Gabbay, 2014] Gabbay, D. (2014). The handling of loops in argumentation networks. *Journal of Logic and Computation*, 26(4):1065–1147.
- [Gabbay, 1985] Gabbay, D. M. (1985). Theoretical foundations for non-monotonic reasoning in expert systems. In Apt, K. R., editor, *Logics and Models of Concurrent Systems*, pages 439–457, Berlin, Heidelberg. Springer Berlin Heidelberg.
- [Kampik and Gabbay, 2020] Kampik, T. and Gabbay, D. (2020). Towards diarg: An argumentation-based dialogue reasoning engine. In *SAFA@COMMA*.
- [Kampik and Nieves, 2021a] Kampik, T. and Nieves, J. C. (2021a). Abstract argumentation and the rational man. *Journal of Logic and Computation*. exab003.
- [Kampik and Nieves, 2021b] Kampik, T. and Nieves, J. C. (2021b). *Toward Consistent Agreement Approximation in Abstract Argumentation and Beyond*. International Foundation for Autonomous Agents and Multiagent Systems, Richland, SC.
- [Rubinstein, 1998] Rubinstein, A. (1998). *Modeling bounded rationality*. MIT Press.
- [Skiba, 2020] Skiba, K. (2020). Towards ordering sets of arguments. In *SSA@COMMA*, page 16.
- [van der Torre and Vesic, 2017] van der Torre, L. and Vesic, S. (2017). The principle-based approach to abstract argumentation semantics. *If-CoLog Journal of Logics and Their Applications*, 4(8).

Towards Eliciting Attacks in Abstract Argumentation Frameworks

Isabelle Kuhlmann

University of Koblenz-Landau, Germany

Abstract

We introduce the problem of argumentation framework elicitation by considering a scenario which involves an agent that possesses an argumentation framework that we aim to uncover. More precisely, we assume that the set of arguments is known, but the set of attacks between the arguments is not. Hence, we focus on the problem of eliciting attack relations in argumentation frameworks by means of asking the agent certain questions about the framework. This raises the question whether it is at all possible to gather enough information to find a solution. If this is indeed the case, the follow-up question involves the development of algorithms which can find solutions by utilizing as few questions as possible. This paper provides an overview of this new line of research and presents some preliminary insights.

1 Introduction

Argumentation is a concept that is deeply rooted in human nature and that can be considered a central element of our intelligence. As Phan Minh Dung stated in his seminal paper [Dung, 1995]: “The ability to engage in arguments is essential for humans to understand new problems, to perform scientific reasoning, to express, clarify and defend their opinions [...]” Consequently, a lot of research has been concerned with various approaches to model this concept in artificial intelligence as well. In the field of *abstract argumentation*, which this paper focuses on, most works are aimed at drawing meaningful conclusions from a given argumentation framework (AF).

However, the inverse problem of (re-)constructing an AF from given conclusions received only little attention (see e.g., [Niskanen et al., 2019, Riveret and Governatori, 2016, Kido and Liao, 2019]).

Consider a scenario where an agent possesses an AF and we want to *elicit* the attack relation of this framework by asking the agent a number of questions, given that the set of arguments is known. There is a multitude of questions which could be posed, however we first concentrate on the question whether a set of arguments is an extension of the AF wrt. a certain semantics. This scenario raises the question whether it is possible at all to elicit an argumentation framework and—if this is indeed the case—which questions need to be asked in order to do so. More precisely, the question regarding the possibility of AF elicitation leads to the task of developing practical algorithms. A possible application area regarding the previously described research is the field of *strategic argumentation* [Oren and Norman, 2009, Rienstra et al., 2013], where an agent aims at discovering an opponent’s knowledge.

Another field that is related to the problem of eliciting AFs is *preference elicitation* (see [Chen and Pu, 2004] for an overview). In preference elicitation, the aim is to uncover an agent’s preferences—this bears similarity to the goal of uncovering an agent’s AF in our scenario. Moreover, the problem of eliciting AFs is related to the problem of *learning* AFs [Niskanen et al., 2019, Riveret and Governatori, 2016], which is again related to the inverse argumentation problem [Kido and Liao, 2019]. However, the interactivity of

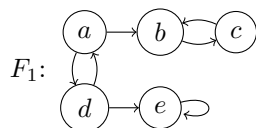

Figure 1: Example of an abstract argumentation framework.

choosing which information is asked for, i.e., which information the elicitation process is based on, is unique to our scenario.

The remainder of this paper is structured as follows. In the subsequent section, we will provide a brief overview of the required preliminaries. Some research questions arising from the previously described problem and how we plan to approach them are explained as well. In the third section, the planned methodologies as well as some existing results from the literature that are related to our problem of eliciting AFs are discussed. Section 4 concludes this work by giving a short summary.

2 Method

We consider abstract argumentation frameworks in the sense of Dung [Dung, 1995]. The general idea behind such frameworks is to model the relation between arguments as a graph. More specifically, arguments are represented as nodes and conflicts between arguments are represented as edges. In classical Dung-style AFs the edges are directed and indicate an attack relation. Thus, if there is an edge from argument a to argument b it means that a attacks b .

Definition 1. Formally, an abstract argumentation framework is a pair $F = (\text{Args}, R)$ with Args being a set of arguments and $R \subseteq \text{Args} \times \text{Args}$ an attack relation.

Figure 1 shows an exemplary AF, F_1 . Let $E \subseteq \text{Args}$. E is called *conflict-free* if there are no arguments $a, b \in E$ such that $(a, b) \in R$. We say $E \in \text{cf}(F)$ if E is conflict-free wrt. an AF F . Further, an argument $a \in \text{Args}$ is *defended* by E if $\forall b \in \text{Args}$ with $(b, a) \in R$, $\exists c \in E$ with $(c, b) \in R$. Semantics of an AF can be expressed by means of *extensions*.

Definition 2. Let $F = (\text{Args}, R)$ be an AF and $E \subseteq \text{Args}$.

- E is an *admissible* extension (i.e., $E \in \text{ad}(F)$) if $E \in \text{cf}(F)$ and each $a \in E$ is defended by E in F . With regard to the AF F_1 (see Figure 1), the admissible extensions are $\{\emptyset, \{a\}, \{c\}, \{d\}, \{a, c\}, \{b, d\}, \{c, d\}\}$.
- E is a *complete* extension (i.e., $E \in \text{co}(F)$) if $E \in \text{ad}(F)$ and for each $a \in \text{Args}$ defended by E in F , it holds that $a \in E$. The complete extensions of F_1 are $\{\emptyset, \{c\}, \{d\}, \{a, c\}, \{b, d\}, \{c, d\}\}$.
- E is a *grounded* extension (i.e., $E \in \text{gr}(F)$) if $E \in \text{co}(F)$ and for each $E' \in \text{co}(F)$, $E' \not\subseteq E$. An AF always possesses one uniquely defined grounded extension. The grounded extension of F_1 is the empty set.
- E is a *preferred* extension (i.e., $E \in \text{pr}(F)$) if $E \in \text{ad}(F)$ and for each $E' \in \text{ad}(F)$, $E \not\subseteq E'$. The preferred extensions of F_1 are $\{\{a, c\}, \{b, d\}, \{c, d\}\}$.
- E is a *stable* extension (i.e., $E \in \text{st}(F)$) if $E \in \text{cf}(F)$ and for each $a \in \text{Args} \setminus E$, $\exists b \in E$ with $(b, a) \in R$. It is possible that an AF does not possess any stable extensions. The stable extensions of F_1 are $\{b, d\}$ and $\{c, d\}$.

Although conflict-freeness is not commonly referred to as a semantics, we do so in order to simplify presentation.

In order to elicit an AF $F = (\text{Args}, R)$ known to the agent, we require information. We gather information by posing questions that the agent, acting as an oracle, answers. A first research goal is to find out whether it is even possible to uncover the attack relation in an AF in this manner or what the limitations are. Naturally, this raises the question what pieces of information we require (i.e., which questions we need to ask) to do so. An additional task is the development of algorithms for the elicitation process. Such algorithms should output a correct answer while ideally utilizing only a minimal number of questions.

We make the assumption that the set of arguments Args is known. There is a number of possible questions which are of syntactic nature, for instance “Are there self-attacks?”, “How many (odd) cycles does F contain?”, or “How many attacks does F contain in total?”. However, eliciting the exact AF is a rather challenging task. As the following example illustrates, asking a single question or a combination of two questions may significantly reduce the number of possible solutions, but may not yield a unique solution.

Example 1. Let $F_A = (\text{Args}_A, R_A)$ be the agent’s AF with $\text{Args}_A = \{a, b, c\}$. The first question we pose is: *Does F_A contain any self-attacks?* The agent answers *no*. From the possible range of AFs we can construct from Args_A we can now exclude all frameworks which comprise self-attacks. However, we are obviously not able to reconstruct F_A exactly, because there are various self-attack-free AFs that can be constructed from Args_A .

We now ask the additional question: *How many odd cycles does F_A contain?* The agent answers: 1. This answer allows us to further limit the range of possible solutions, because we learned that there must be an odd cycle which is not a self-attack. Thus, there must be a cycle involving all arguments a , b , and c . Nevertheless, we cannot determine F_A exactly, since we have no knowledge about the direction of the cycle nor about any additional attacks.

As a consequence, we defer the aim of finding an exact solution and aim at finding an *equivalent* solution instead. More precisely, we search for a solution that is equivalent to the original AF wrt. a semantics σ , as defined below.

Definition 3. Let $\sigma \in \{\text{ad}, \text{cf}, \text{co}, \text{gr}, \text{pr}, \text{st}\}$. Two AFs $F = (\text{Args}, R)$, $F' = (\text{Args}', R')$ are σ -equivalent if they possess the same σ -extensions, i.e., $\sigma(F) = \sigma(F')$.

Hence, as a first step in eliciting an equivalent AF, we focus on questions regarding an AF’s semantics. More specifically, we examine the question whether a set $E \in \text{Args}$ is an extension of F wrt. a semantics $\sigma \in \{\text{ad}, \text{cf}, \text{co}, \text{gr}, \text{pr}, \text{st}\}$. Posing this question wrt. an

individual semantics σ yields sufficient information to construct a σ -equivalent AF. The following naive procedure demonstrates how to construct a σ -equivalent AF F' from an original AF F :

1. We ask “Is $E \subseteq \text{Args}$ a σ -extension of F ?” wrt. every possible subset of arguments. As a result, we know all σ -extensions of F .
2. We construct all possible AFs from Args . For each possible AF G , we compute $\sigma(G)$ and check whether $\sigma(F) = \sigma(G)$. If this is the case, we found a solution and return the equivalent AF $F' := G$.

Consequently, by asking only one type of question, we can already elicit an equivalent AF. On the other hand, it is easy to see that the proposed algorithm is very inefficient and thus not practically applicable for bigger AFs. Our goal is to find more practical algorithms that do not only take the number of different questions into account, but also the number of times an individual question has to be asked. To achieve this, we require deeper insights into the characteristics of the different semantics. Existing literature on such characteristics [Besnard and Doutre, 2004] and on realizability [Dunne et al., 2015] provide a reasonable starting point for this. Furthermore, it is relevant to concentrate on the interplay between different semantics. For instance, if we find an ad-equivalent AF F' wrt. an original AF F , we also know that the two frameworks are pr-equivalent, because if $\text{ad}(F) = \text{ad}(F')$ then $\text{pr}(F) = \text{pr}(F')$ [Oikarinen and Woltran, 2011].

3 Discussion

The previous sections describe a new line of research which is concerned with the elicitation of attacks in argumentation frameworks. We introduce an interactive scenario in which the set of questions the elicitation procedure is based on underlies a selection process. Although we were able to gain some first insights, no work has been published yet.

To begin with, we examine the elicitation of σ -equivalent AFs. This problem can be solved, for in-

stance by the naive algorithm explained above. However, the problem of developing a practical procedure remains. To tackle this issue, we examine which questions we need to ask and how many times we need to ask them. Therefore, it is relevant how the different semantics are related to each other and which characteristics they possess in general.

Another point that should be considered when examining the σ -equivalence of AFs is the restriction to a subset of AFs. For instance, self-attack-free or (odd-)cycle-free AFs could exhibit some interesting properties in the context of elicitation.

In terms of future work, when equivalent AFs have been sufficiently studied and corresponding algorithms have been developed, the next logical step would be to tackle more challenging problems. In particular, we can study the elicitation of strongly equivalent AFs [Oikarinen and Woltran, 2011] or even the elicitation of the exact original framework.

4 Conclusion

In the course of this paper, we introduced the problem of eliciting attacks in argumentation frameworks. We regard a scenario with an agent who “knows” an AF and we want to uncover it by asking the agent a number of questions. Similar to the field of preference elicitation, where the goal is to uncover an agent’s preferences, the goal in AF elicitation is to uncover an agent’s AF. As the reconstruction of the exact AF is highly challenging, we first focus on eliciting frameworks that are equivalent wrt. a semantics σ . It should be emphasized that we consider an interactive scenario in which we can choose which questions about an existing AF should be asked, i.e., which pieces of information are taken into account when constructing an equivalent AF.

The newly introduced elicitation scenario raises the question whether it is possible at all to construct a σ -equivalent AF, given a set of questions. We showed that this is in fact possible by providing a naive algorithm. However, the need for practical algorithms to elicit σ -equivalent AFs remains. Thus, we research the characteristics of the different semantics and the connections between them in order to develop algo-

rithms which only require a minimal amount of questions.

Acknowledgements

I would like to thank Tjitze Rienstra for the inspiration for this line of research.

References

- [Besnard and Doutre, 2004] Besnard, P. and Doutre, S. (2004). Characterization of semantics for argument systems. In *KR*, pages 183–193.
- [Chen and Pu, 2004] Chen, L. and Pu, P. (2004). Survey of preference elicitation methods. Technical report. EPFL-REPORT-52659.
- [Dung, 1995] Dung, P. M. (1995). On the acceptability of arguments and its fundamental role in nonmonotonic reasoning, logic programming and n-person games. *Artificial intelligence*, 77(2):321–357.
- [Dunne et al., 2015] Dunne, P. E., Dvořák, W., Linsbichler, T., and Woltran, S. (2015). Characteristics of multiple viewpoints in abstract argumentation. *Artificial Intelligence*, 228:153–178.
- [Kido and Liao, 2019] Kido, H. and Liao, B. (2019). A bayesian approach to direct and inverse abstract argumentation problems. *CoRR*, abs/1909.04319.
- [Niskanen et al., 2019] Niskanen, A., Wallner, J., and Järvisalo, M. (2019). Synthesizing argumentation frameworks from examples. *Journal of Artificial Intelligence Research*, 66:503–554.
- [Oikarinen and Woltran, 2011] Oikarinen, E. and Woltran, S. (2011). Characterizing strong equivalence for argumentation frameworks. *Artificial intelligence*, 175(14-15):1985–2009.
- [Oren and Norman, 2009] Oren, N. and Norman, T. J. (2009). Arguing using opponent models. In *International Workshop on Argumentation in Multi-Agent Systems*, pages 160–174. Springer.

[Rienstra et al., 2013] Rienstra, T., Thimm, M., and Oren, N. (2013). Opponent models with uncertainty for strategic argumentation. In *IJCAI 2013, Proceedings of the 23rd International Joint Conference on Artificial Intelligence, Beijing, China, August 3-9, 2013*, pages 332–338.

[Riveret and Governatori, 2016] Riveret, R. and Governatori, G. (2016). On learning attacks in probabilistic abstract argumentation. In *Proceedings of the 2016 International Conference on Autonomous Agents & Multiagent Systems*, pages 653–661.

Approximate Solutions to Argumentation Frameworks with Graph Neural Networks

Lars Malmqvist

Department of Computer Science, University of York

Abstract

The research project presented in this article focuses on applying methods from Graph Neural Network research to the approximation of classic decision problems in Abstract Argumentation. It takes as its basis the four semantics described originally by Dung and other well-known semantics from the literature on Abstract Argumentation. The research addresses the problems of credulous and sceptical acceptance by applying a range of methods in the Graph Neural Network space to achieve up to 97% accuracy on the approximation of argument acceptability using a dataset taken from past ICCMA competitions. Further research is ongoing to improve these results and expand on their applicability.

1 Introduction

Abstract Argumentation is a formalism for non-monotonic reasoning that bases its representation on the modelling of conflict. It is typically represented in the form of a directed graph in which vertices represent arguments and edges a relation of attack. This gives rise to a range of reasoning problems that determine the acceptability of arguments or the joint acceptability of sets of arguments. The majority of these reasoning problems are known to be NP-hard [Charwat et al., 2015, Woltran, 2014].

The research's core problem is to merge particular research strands within deep learning with research on Abstract Argumentation. In particular, Graph

Neural Networks [Wu et al., 2020] of various types (e.g. Graph Convolutional Networks) are well suited to addressing the graph-structured problems encountered in Abstract Argumentation. That means finding ways of solving frameworks and queries that because of their size or graph topology are challenging for existing solvers to address. Finding an efficient way of learning to solve argumentation problems via machine learning is itself an unsolved problem.

The vast majority of solution approaches in Abstract Argumentation are exact and complete, often using reduction to some other formalism such as SAT [Cerutti et al., 2014] or ASP [Cerutti et al., 2017] to solve the problem. In general, SAT-based approaches have achieved the best solver performance, but this type of approach does not necessarily provide the easiest fit with real-world deployment scenarios and very large scale datasets. There has been some research into probabilistic methods [Thimm, 2018], which unfortunately is not directly comparable to this research because of differences in evaluation criteria and datasets, and a single feasibility study into using Graph Convolutional Networks (GCN) [Kuhlmann and Thimm, 2019] that had mixed results depending on the dataset under consideration.

There are, however, major benefits to approximate approaches such as Graph Neural Networks in this area that makes them worth considering in some cases. In particular, they have greatly superior run-time performance and are more easily integrated into heavily parallelised Cloud-based architectures, although this comes at the cost of large memory consumption and GPU support. The major contribu-

tion of this research is to show the viability of an approximate approach based on Graph Neural Networks. First, by showing that such an approach can achieve a reasonable degree of accuracy in predicting the acceptability status of arguments, and, second, by detailing a usable architecture for training deep learning models to solve problems in abstract argumentation that can serve as the starting point for further research.

2 Method

The research has so far focused on developing an approximate solver using an extension of Convolutional Graph Neural Networks [Wu et al., 2020]. Convolutional graph neural networks (CGNNs) draw on the popularity and success of traditional CNNs in particular in computer vision. However, there are different ways of defining the convolutional operation when applied to graphs, which gives rise to different types of CGNNs. The most common approach bases itself on the digital signal processing, where convolution is seen effectively as a noise removal operation. The difference between most variants in this approach including the seminal GCN architecture by Kipf and Welling [Kipf and Welling, 2019], ChebNet [Monti et al., 2017], and CaleyNet [Levie et al., 2019] consists mainly in how they represent, approximate and simplify the filter operations used in the convolution of the graph to achieve computational improvements. The second primary approach to CGNNs stays closer to the conventional CNN definition by considering convolution based on a node's spatial relationships [Wu et al., 2020]. That means spatial based methods in some way aggregates information from a node's neighbourhood. This approach can be seen, for instance, in the Message Passing Neural Network [Riba et al., 2018] that explicitly defines a framework for looking at graph convolution as a message-passing process.

The most successful architecture used to date in this research project builds and extends on the seminal approach introduced by Kipf and Welling [Kipf and Welling, 2019], but extends it in several areas. In the original formulation, the GCN consisted

of an input layer, two hidden layers with RELU nonlinearities inserted in between, and ending with an output layer. Node embeddings were generated using a propagation rule following a first-order approximation of spectral graph convolutions. The core components of the GCN architecture used in the paper summarising current results [Malmqvist et al., 2020] included the following elements, both incorporating and extending Kipf and Welling's method:

1. Graph Embeddings generated using DeepWalk [Perozzi et al., 2014], a random walk based method, fed as input features along with the adjacency matrix of the argumentation framework
2. An input layer receiving these inputs
3. 4 to 6 repeating blocks of a GCN layer [Kipf and Welling, 2019] and a Dropout layer [Srivastava et al., 2014]
4. Residual connections feeding the original features and the normalised adjacency matrix as additional input at each block
5. A Sigmoid output layer generating a probability for the acceptability of each argument in the framework

The model was trained using Adam [Kingma and Ba, 2015] with Binary Cross-Entropy as the loss function. The training regime used a combination of randomised training batches, dynamic rebalancing of the training data, and automated outlier exclusion to prevent overfitting and reach a high degree of accuracy.

3 Discussion

So far results have been published in a single article presented at SAFA2020 [Malmqvist et al., 2020]. The experiments in this paper were run against a dataset consisting of 900 argumentation frameworks selected from the ICCMA 2017¹ Benchmark datasets. The selection included frameworks from benchmark

¹<http://argumentationcompetition.org/2017/>

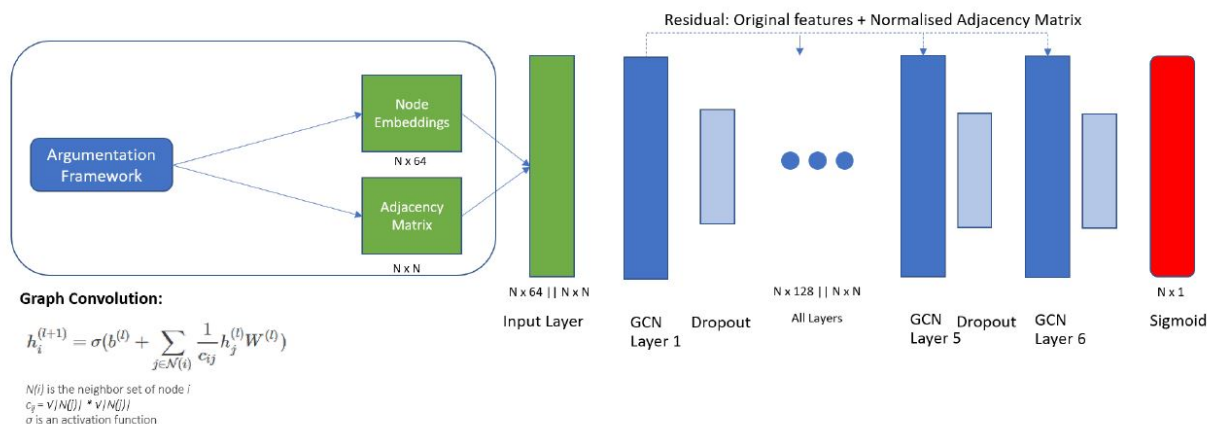

Figure 1: GCN Architecture Overview.

sets A, B, and C, including all five difficulty categories. Input frameworks contained up to 15,605 arguments and 6,250,500 attacks with an average number of arguments of 1,595 and an average number of attacks of 187,542. The dataset was divided into nine folds to facilitate the training process, and the neural net was trained sequentially on each fold. Training and validation sets were generated using a random mask, and 10% of graphs were held out as a test set for final evaluation.

The GCN model was evaluated using two separate tasks: credulous acceptability and sceptical acceptability under the preferred semantic. For an argument to be credulously acceptable in the context of a given argumentation framework, it must belong to one of the extensions of that argumentation framework; to be sceptically acceptable, it must belong to all. To be able to frame the problem for supervised learning, we generated ground truth solutions using the Pyglaf argumentation solver [Alviano, 2018] for all argumentation frameworks in the dataset. The models have only at this time been evaluated using the accuracy metric and other metrics would also be interesting to explore in the future.

All in all five different models were trained using different combinations of methods shown in Table 1.

The results for Credulous acceptability shown in Table 2 demonstrated the viability of a CGNN based

solver, although some improvement would be required in performance to make it usable in practice. The research also underlined that for approximate solvers the key problem is to find a way of achieving balanced performance between positive and negative instances of the decision problem. The great disparity in negative and positive instances in the training data, means that great care has to be taken during training to achieve this goal. The key contributions to GCN architecture that have been made so far in this research project have all been related to this goal. The same patterns was present to an even greater extent for sceptical acceptance as can be seen from Table3.

Future work will focus on two strands of extension. First, it will be necessary to improve the solver’s overall performance, in particular, to address the balancing problem better. Second, the approach here has only been applied to the preferred semantic. Extending this to all the semantics covered by the ICCMA competition is ongoing work in progress. It is possible that incorporating more semantic specific features into the machine learning approach will be required to achieve good results across all semantics.

Table 1: Models Trained

Model	Layers	Balanced	Randomised	Residuals
4-Layers Modified GCN	4	No	Yes	Yes
5-Layers Modified GCN	5	No	Yes	Yes
6-Layers Modified GCN	6	No	Yes	Yes
Mod GCN with Balanced Data	4	Yes	Yes	Yes
Mod GCN with Fixed Batches	4	No	No	Yes

Table 2: Results - Credulous Acceptability

Model	Accuracy		
	Overall	Yes	No
4-Layers Modified GCN	92,68%	69,33%	93,54%
5-Layers Modified GCN	92,26%	73,56%	92,95%
6-Layers Modified GCN	91,63%	71,81%	92,37%
Modified GCN with Balanced Data	81,20%	91,20%	71,00%
Modified GCN with Fixed Batches	96,40%	7,00%	99,70%
Kuhlmann and Thimm 2019 - Unbalanced	62,00%	10,00%	97,00%
Kuhlmann and Thimm 2019 - Balanced	63,00%	17,00%	93,00%

Table 3: Results - Sceptical Acceptability

Model	Accuracy		
	Overall	Yes	No
4-Layers Modified GCN	96,21%	24,04%	97,10%
5-Layers Modified GCN	96,20%	22,92%	97,11%
6-Layers Modified GCN	96,24%	22,69%	97,15%
Modified GCN with Balanced Data	97,15%	46,35%	94,39%
Modified GCN with Fixed Batches	98,44%	0,33%	99,66%

4 Conclusion

The research described here is part of an ongoing project that seeks to apply Deep Neural Network methods to Abstract Argumentation. Several other avenues are being explored including combining GNNs with Deep Reinforcement Learning, using approaches such as SATNet, and combining the outputs of the approximate solver with a classic SAT approach for verification or as an input heuristic. However, Graph Neural Networks is likely to remain the core method in any of these extended or augmented solution approaches.

References

- [Alviano, 2018] Alviano, M. (2018). The pyglaf argumentation reasoner. *OpenAccess Series in Informatics*, 58:2–5.
- [Cerutti et al., 2014] Cerutti, F., Dunne, P. E., Giacomini, M., and Vallati, M. (2014). Computing preferred extensions in abstract argumentation: A SAT-based approach. In *Lecture Notes in Computer Science (including subseries Lecture Notes in Artificial Intelligence and Lecture Notes in Bioinformatics)*, volume 8306 LNAI, pages 176–193.
- [Cerutti et al., 2017] Cerutti, F., Gaggl, S., Thimm, M., and Wallner, J. (2017). Foundations of implementations for formal argumentation. *If-CoLog Journal of Logics and their Applications*, 4(8):2623–2705.
- [Charwat et al., 2015] Charwat, G., Dvořák, W., Gaggl, S. A., Wallner, J. P., and Woltran, S. (2015). Methods for solving reasoning problems in abstract argumentation - A survey. *Artificial Intelligence*, 220:28–63.
- [Kingma and Ba, 2015] Kingma, D. P. and Ba, J. L. (2015). Adam: A method for stochastic optimization. In *ICLR 2015*, pages 1–15.
- [Kipf and Welling, 2019] Kipf, T. N. and Welling, M. (2019). Semi-supervised classification with graph

- convolutional networks. In *5th International Conference on Learning Representations, ICLR 2017 - Conference Track Proceedings*.
- [Kuhlmann and Thimm, 2019] Kuhlmann, I. and Thimm, M. (2019). Using Graph Convolutional Networks for Approximate Reasoning with Abstract Argumentation Frameworks: A Feasibility Study. *Lecture Notes in Computer Science (including subseries Lecture Notes in Artificial Intelligence and Lecture Notes in Bioinformatics)*, 11940 LNAI:24–37.
- [Levie et al., 2019] Levie, R., Monti, F., Bresson, X., and Bronstein, M. M. (2019). CayleyNets: Graph Convolutional Neural Networks with Complex Rational Spectral Filters. *IEEE Transactions on Signal Processing*, 67(1):97–109.
- [Malmqvist et al., 2020] Malmqvist, L., Yuan, T., Nightingale, P., and Manandhar, S. (2020). Determining the acceptability of abstract arguments with graph convolutional networks. *CEUR Workshop Proceedings*, 2672:47–56.
- [Monti et al., 2017] Monti, F., Boscaini, D., Masci, J., Rodolà, E., Svoboda, J., and Bronstein, M. M. (2017). Geometric deep learning on graphs and manifolds using mixture model CNNs. In *Proceedings - 30th IEEE Conference on Computer Vision and Pattern Recognition, CVPR 2017*, volume 2017-Janua, pages 5425–5434.
- [Perozzi et al., 2014] Perozzi, B., Al-Rfou, R., and Skiena, S. (2014). DeepWalk: Online learning of social representations. *Proceedings of the ACM SIGKDD International Conference on Knowledge Discovery and Data Mining*, pages 701–710.
- [Riba et al., 2018] Riba, P., Fischer, A., Lladós, J., and Fornés, A. (2018). Learning Graph Distances with Message Passing Neural Networks. In *Proceedings - International Conference on Pattern Recognition*, volume 2018-Augus, pages 2239–2244. IEEE.
- [Srivastava et al., 2014] Srivastava, N., Hinton, G., Krizhevsky, A., Sutskever, I., and Salakhutdinov, R. (2014). Dropout: A Simple Way to Prevent Neural Networks from Overfitting. *Journal of Machine Learning Research*, 15(56):1929–1958.
- [Thimm, 2018] Thimm, M. (2018). Stochastic local search algorithms for abstract argumentation under stable semantics. *Frontiers in Artificial Intelligence and Applications*, 305:169–180.
- [Woltran, 2014] Woltran, S. (2014). Abstract Argumentation – All Problems Solved ? In *ECAI 2014*, pages 1–93.
- [Wu et al., 2020] Wu, Z., Pan, S., Chen, F., Long, G., Zhang, C., and Yu, P. S. (2020). A Comprehensive Survey on Graph Neural Networks. *IEEE Transactions on Neural Networks and Learning Systems*, pages 1–21.

On the Calculation of Rhetorical Arguments Strength for Persuasive Negotiation in Multi-agent Systems

Mariela Morveli-Espinoza

Program in Electrical and Computer Engineering (CPGEI),
Federal University of Technology of Parana (UTFPR), Curitiba - Brazil

Abstract

Rhetorical arguments are used in negotiation dialogues when a proponent agent tries to persuade his opponent to accept a proposal more readily. When more than one argument is generated, the proponent must compare them in order to select the most adequate for his interests. A way of comparing them is by means of their strength values. Related work propose a calculation based only on the components of the rhetorical arguments, i.e., the importance of the opponent's goal and the certainty level of the beliefs that make up the argument. This work aims to propose a model for the calculation of the strength of rhetorical arguments, which is inspired on the pre-conditions of credibility and preferability stated by Guerini and Castelfranchi. Thus, we suggest the use of two new criteria to the strength calculation: the credibility of the proponent and the status of the opponent's goal in the goal processing cycle. The model is empirically evaluated and the results demonstrate that the proposed model is more efficient than previous works in terms of number of exchanged arguments and number of reached agreements.

1 Introduction

Negotiation is a key form of interaction, among agents, that is used for resolving conflicts and reaching agreements. Arguments used in negotiation dialogues are generally explanatory ones and al-

low agents to argue about their beliefs or other mental attitudes during the negotiation process [Rahwan et al., 2003]. Nevertheless, there are other types of arguments that may act as persuasive elements. These ones are called rhetorical arguments¹ and are the following:

- **Threats** carry out sanctions when the opponent does not accept the proposal sent by the proponent.
- **Rewards** are used when the proponent wants to entice an opponent to do a certain action by offering to do another action as a reward or by offering something that the opponent needs.
- **Appeals** try to persuade the opponent by offering a reward; however, this recompense is not a consequence of an action of the proponent. If the proponent does not have a recompense to offer, he can appeal to one goal of the opponent that does not need the proponent's intervention. Appeals can be seen as self-rewards [Amgoud and Prade, 2004].

Let us consider a scenario of a Consumer Complaint Website whose goal is to try to resolve a conflict between consumers and companies. In this scenario, a software agent (denoted by CONS) complains about a service on behalf of a human user and another

¹When an agent uses rhetorical arguments to back their proposals, the negotiation is called persuasive negotiation [Ramchurn et al., 2003].

software agent acts in behalf of a company (denoted by COMP), offers possible solutions. In the following example, the user of CONS missed an international flight due to a schedule change and he wants the airline company to reimburse him the total price of the ticket; however, the airline company only wants to refund the 20% of the total price of the ticket. At this point, CONS tries to force COMP to accept his proposal and decides to send a threat. The following are two threats that CONS can generate:

- th_1 : *You should refund the total price of the ticket, otherwise I will never buy a ticket in your company anymore, so you will not reach your financial goals.*
- th_2 : *You should refund the total price of the ticket, otherwise I will destroy your reputation in social networks, so you will not gain the award to the Best Airline Frequent Flier Loyalty Program (BAFFLP).*

The question is: which of these threats (arguments) will CONS choose to try to persuade COMP to accept his proposal? According to [Guerini and Castelfranchi, 2006], a rhetorical argument has to meet some pre-conditions in order for the proponent to reach a negotiation favorable to him; therefore, the chosen argument has to be in the set of arguments that meet such pre-conditions. However, before the proponent decides what argument to send, he needs to have a way of differentiating the arguments of that set. A way of doing it is by calculating their strengths [Ramchurn et al., 2003]. Thus, the research question of this work is: *What criteria should an agent take into account in order to calculate the strength of a rhetorical argument and how should this calculation be done?*

Some studies about rhetorical arguments strength take into account the importance of the opponent's goal and the certainty level of the beliefs that make up the argument [Amgoud and Prade, 2004, Amgoud and Prade, 2006]. However, there exist situations in which other criteria are needed in order to perform a more exact measurement of the arguments strength. To make this discussion more concrete, consider the following situations:

- CONS knows that “reaching the financial goals” (denoted by go_1) and “gaining the award to the BAFFLP” (denoted by go_2) are two goals of COMP –the opponent– that have the same importance. If CONS only considers the importance of the opponent's goal to calculate the strength of the threats built with these goals, he cannot decide which threat to send because all of them have the same strength. Thus, there exist the need of another criterion –related to the COMP's goals– that helps CONS to break the tie. In order to achieve a goal, it has to pass for some states before be considered achieved. For instance, assume that go_1 has already been achieved; hence, threatening this goal would not be useful for CONS. On the other hand, COMP has not achieved go_2 yet; hence, threatening it can make COMP lose the award; and consequently, he will not achieve go_2 .
- CONS has already threaten other companies before and rarely he has fulfilled his threats, and agent COMP knows about it. In this case, the strength of a threat sent by CONS is also influenced by his credibility.

In the first case, notice that besides importance, there is another criterion to evaluate the worth of an opponent's goal, because it does not matter how important a goal is if it is far from being achieved or if it is already achieved. In the second case, the credibility of the proponent should also be considered, since even when the an opponent's goal is very important and/or achievable, a low level of credibility could impact on the strength value of an argument. Thus, the new suggested criteria for the measurement of the strength of rhetorical arguments are the proponent's credibility and the status of the opponent's goal.

To determine the possible statuses of a goal, we base on the Belief-based Goal Processing (BBGP) model [Castelfranchi and Paglieri, 2007], a more refined and extended model than the BDI (beliefs-desires-intentions) model [Rao et al., 1995]. In the BBGP model, the status a goal can adopt are: (i) active (=desire), (ii) pursuable, (iii) chosen, and (iv) executive (=intention). A goal is closer to be achieved

when it is closer to the last status. Besides, we consider the cancelled status. A goal is cancelled when it is not pursued anymore.

2 Calculation Model

We start by analysing the pre-conditions for considering a rhetorical argument convincing. Then we detail the steps of the calculation model.

[Guerini and Castelfranchi, 2006] claim that a rhetorical argument can be considered **convincing** when it is both credible and preferable. Consequently, the rhetorical argument that will be sent to the opponent has to belong to the set of rhetorical arguments that meet such pre-conditions. Next, we analyze each pre-condition and establish how each of them will be evaluated.

In order to evaluate the **credibility** of the proponent, we take into account the following concepts:

(i) **The proponent’s reputation** is about how trustworthy the proponent is with respect to fulfil his threats, rewards, and appeals. The reputation value of a proponent agent P is represented by a real number: $REP(P) \in [0, 1]$.

(ii) **The opponent’s credibility threshold** is used to indicate the lowest value of the proponent’s reputation so that the opponent considers a rhetorical argument credible. Thus, the credibility threshold of an opponent agent O is represented by a real number: $THRES(O) \in [0, 1]$ where zero represents the minimum threshold value and one the maximum threshold value.

The proponent evaluates his credibility by comparing both values: P is credible if $REP(P) \geq THRES(O)$; otherwise, P is not credible.

The second pre-condition is the **preferability**. This pre-condition is based on the relation between the opponent’s goal and the action that the opponent is required to perform. Thus, the opponent’s goal must be more valuable for him (the opponent) than performing the required action. The criteria that will be evaluated in order to estimate the value of an opponent’s goal are:

(i) **Importance of the opponent’s goal:** It is related to how meaningful the goal is for the oppo-

nent. The value of the importance of a given goal go is a real number represented by $IMP(go) \in [0, 1]$. The more important a goal is for the opponent, the more threatenable, rewardable, or appealable this goal is.

(ii) **Effectiveness of the opponent’s goal:** It is related to the degree to which an opponent’s goal is successful for persuasion and it is based on the status of the goal in the goal processing cycle. A goal is close of be achieved when its status is chosen or executive and it is far of be achieved when its status is active or pursuable. Thus, depending on its status, a goal can be considered more or less threatenable, rewardable, or appealable. The effectiveness of an opponent’s goal go is represented by $EFF(go) \in \{0, 0.25, 0.5, 0.75, 1\}$ such that zero means that go is not effective at all and one means that go is completely effective.

Finally, the equation for calculating the value of go is: $WORTH(go) = \frac{IMP(go) + EFF(go)}{2}$.

The credibility value of P has a different impact on the calculation of the strength of the arguments because the higher the difference between the threshold value and the reputation value is, the higher the credibility of the proponent is. To calculate the “**accurate**” value of the credibility of P with respect to an opponent O , whose threshold is $THRES(O)$, we use: $ACCUR_CRED(P, O) = REP(P) - THRES(O)$. Thus, the strength of an argument A depends on the worth of the opponent’s goal and the “accurate” value of the proponent’s credibility: $STRENGTH(A) = WORTH(go) \times ACCUR_CRED(P, O)$.

Figure 1 depicts the steps of the proposed model in a work-flow fashion.

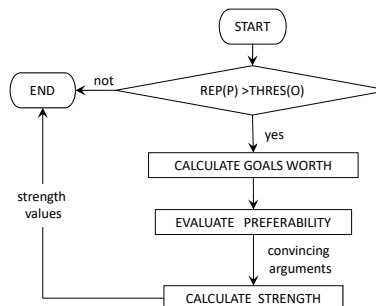

Figure 1: Proposed strength calculation model.

3 Results

In this section, we will present one of the four experiments that were carried out. In our experiment, a single simulation run involves 1000 separate negotiation encounters between two agents. For all the negotiations, the agents were paired against agents that use the same mechanism of strength calculation. We call “BBGP-based agents” the agents that use the strength calculation model proposed in this article and “IMP-based agents” the agents that use the strength evaluation model based on the importance of the opponent’s goal proposed in [Amgoud and Prade, 2004]. We performed negotiations where agents generate 10, 25, 50, and 100 rhetorical arguments. For each setting of number of arguments, the simulation was repeated 10 times. Finally, the experimental variables that were measured are: (i) the number of reached agreements and (ii) the number of exchanged rhetorical arguments.

Figures 2 and 3 show the behavior of the variables. For the results presented in this experiment, we used a reputation value of 0.8 for both agents and the thresholds are generated randomly in the interval [0, 1] before each negotiation encounter.

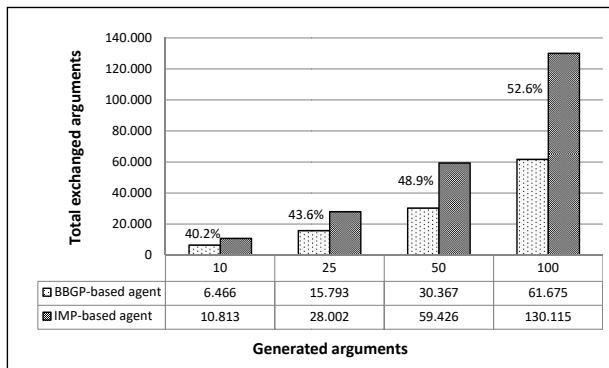

Figure 2: Comparison of the variable *number of exchanged arguments*. The labels of each group denote the percentage difference between both values represented by the bars.

In summary, we can notice that our mechanism fares better than the other mechanism. This means that when both the worth of the opponent’s goal and

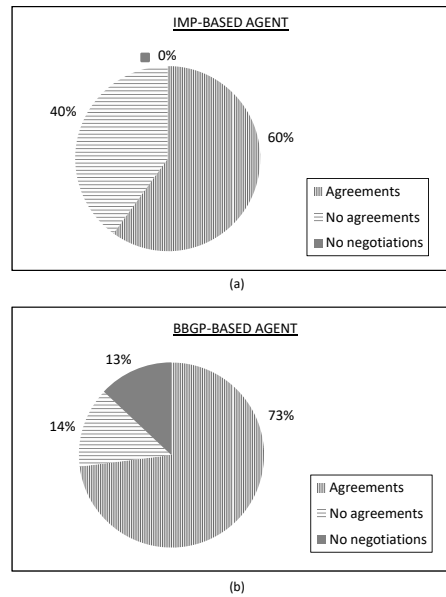

Figure 3: Percentage of negotiations that end in an agreement versus percentage of negotiations that do not end in an agreement. Recall that BBGP-based agents only engage in a negotiation when either both are credible or the proponent is credible.

the proponent’s credibility are taken into account, our proposal has better results than the approach based only on the importance of the opponent’s goal.

A more detailed and extended version of the model and the results can be found in [Morveli-Espinoza et al., 2020b] and [Morveli-Espinoza et al., 2020a].

4 Final Remarks

In this work, we proposed a model for the strength calculation of rhetorical arguments. We studied the pre-conditions for an argument to be considered convincing. Based on these pre-conditions, we have proposed a model for evaluating and measure the strength value of the rhetorical arguments. The experiment shows that our proposed model fares better than the calculation model that only takes into account the importance of the opponent’s goal.

In this approach, there is no model of the environment or the context where the negotiation occurs, especially in terms of organizational structure. We believe that this information can influence on the strength of the arguments and therefore on the persuasion power of the agents, specifically it can influence on the credibility of the agent. We can also consider that the information of the opponent is uncertain, which may directly impact on the strength calculation.

Acknowledgements

The author would like to thank her thesis advisor Prof. Cesar Augusto Tacla for his valuable suggestions and orientation. This work is fully founded by CAPES-Brazil.

References

- [Amgoud and Prade, 2004] Amgoud, L. and Prade, H. (2004). Threat, reward and explanatory arguments: generation and evaluation. In *Proceedings of the 4th Workshop on Computational Models of Natural Argument*, pages 73–76.
- [Amgoud and Prade, 2006] Amgoud, L. and Prade, H. (2006). Formal handling of threats and rewards in a negotiation dialogue. In *Argumentation in Multi-Agent Systems*, pages 88–103. Springer.
- [Castelfranchi and Paglieri, 2007] Castelfranchi, C. and Paglieri, F. (2007). The role of beliefs in goal dynamics: Prolegomena to a constructive theory of intentions. *Synthese*, 155(2):237–263.
- [Guerini and Castelfranchi, 2006] Guerini, M. and Castelfranchi, C. (2006). Promises and threats in persuasion. *6th Workshop on Computational Models of Natural Argument*, pages 14–21.
- [Morveli-Espinoza et al., 2020a] Morveli-Espinoza, M., Nieves, J. C., and Tacla, C. A. (2020a). Measuring the strength of rhetorical arguments. In *Multi-Agent Systems and Agreement Technologies (EUMAS'2020)*, pages 415–430. Springer.
- [Morveli-Espinoza et al., 2020b] Morveli-Espinoza, M., Nieves, J. C., and Tacla, C. A. (2020b). Measuring the strength of threats, rewards, and appeals in persuasive negotiation dialogues. *The Knowledge Engineering Review*, 35.
- [Rahwan et al., 2003] Rahwan, I., Ramchurn, S. D., Jennings, N. R., Mcburney, P., Parsons, S., and Sonenberg, L. (2003). Argumentation-based negotiation. *The Knowledge Engineering Review*, 18(04):343–375.
- [Ramchurn et al., 2003] Ramchurn, S. D., Jennings, N. R., and Sierra, C. (2003). Persuasive negotiation for autonomous agents: A rhetorical approach.
- [Rao et al., 1995] Rao, A. S., Georgeff, M. P., et al. (1995). Bdi agents: From theory to practice. In *ICMAS*, volume 95, pages 312–319.

Learning defeat relations from data using Neural Argumentation Networks (NANs)

Jack Mumford

Department of Informatics, King's College London, UK

E-mail: jack.mumford@kcl.ac.uk

Abstract

Neural Argumentation Networks (NANs) are artificial neural networks that learn according to abstract argumentation semantics to address the inverse argumentation problem. This paper describes the theory and application of translating complete argumentation semantics to NAN architectures and compares two distinct forms: 2-valued acceptability, and 3-valued acceptability. The σ -consistency problem is formally defined as a specific case of the inverse argumentation problem, where a solution defeat relation must be wholly consistent with a particular argumentation semantics and with a given input of argument labellings, with theoretical and experimental results described for both 2-valued and 3-valued variants of the problem. Attention is given to the more general noisy case of the inverse argumentation problem, with experimental results also provided for the 2-valued and 3-valued data types. Future work will extend to an array of argument relations including support and weighted approaches that could align with wider data sets and reasoning problems.

1 Introduction

Neural argumentation networks (NANs) [Mumford, 2020] are artificial neural networks (ANNs) that learn according to argumentation semantics. Argumentation, as a field within artificial intelligence, is highly relevant for researchers interested in symbolic representations of knowledge and defensible reasoning [Bench-Capon and Dunne, 2007,

Rahwan and Simari, 2009]. Abstract argumentation frameworks (AFs) [Dung, 1995] are comprised of three components: {arguments, defeat relation, labellings}. The vast majority of related research has focused on what is termed the forward argumentation problem, which takes arguments and a defeat relation as input and produces argument acceptability labellings as output. However, this work is focused on the inverse argumentation problem [Kido and Liao, 2019], which takes arguments and labellings as input and produces a defeat relation as output. The inverse problem captures an inductive process that enables the calculation of a defeat relation without examination of structure or context, which would be particularly problematic for enthymemes — arguments with missing structure in the form of unstated premises or claims.

AFs offer a graph-based approach that determines logically consistent argument positions solely via defeat relations between the arguments. The shared graphical nature of AFs and ANNs make their union a sensible choice when looking to automate the processing of the inverse argumentation problem. There exists a one-one mapping between NANs and AFs in which attacks in the framework are represented by weights in the network (and vice versa). When a NAN learns and adjusts its weights according to input argument acceptability data, it learns a defeat relation. Argument acceptability data is formed of a set of labellings T , with each argument labelled according to its acceptability within each labelling $L_i \in T$.

Let us consider an example application of case law, which provides a potential context where arguments and

their acceptability labels for any given case may be known but the relation between them is undefined.

Example 1. A toy case law example using six arguments is shown in Table 1. Look closer at arguments a and b , there is an intuitive conflict but nothing in the structures of the arguments allows an attack to be inferred. However, a data driven approach may provide labellings in which the acceptability statuses of a and b will reveal a conflict and corresponding attack direction (guaranteed if relevant key labellings [Riveret and Governatori, 2016] are input).

Node	Argument
a	Forensics link suspect to murder weapon
b	Crime scene contaminated
c	Suspect convicted
d	Forensics link suspect to victim
e	Property recovered from suspect
f	Suspect has alibi

Table 1: Toy example arguments for use within different cases that form argument labellings.

Figure 1 portrays a suggested solution defeat relation for the arguments listed in Table 1. It is the objective of the inverse argumentation problem to seek out such a solution defeat relation, or some approximate solution if learning under noisy conditions. Note that a symmetric solution defeat relation is depicted in Figure 1 but this is purely due to the predilections of the author, and a conceptual asymmetric solution could have been proffered with all the NAN theory applying just as well.

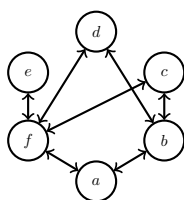

Figure 1: Conceptual AF representing the solution defeat relation between arguments $\{a, b, c, d, e, f\}$.

To date, all the work on NANs has used complete labelling semantics as the basis of the learning process, due to its superset relation with respect to the traditional major semantics [Baroni et al., 2011] and the intuition of representing the range of reasonable positions that are deterministic consequences of the defeat relation (which admissibility semantics does not guarantee).

In [Mumford, 2020], the broad theoretical and experimental contributions for the 2-valued and 3-valued attack

learning problems were outlined. The contribution of this paper is in outlining the advancements made:

1. Defining the σ -consistency problem.
2. Overhauling the experimental analysis to allow for partial labellings as input.

The remainder of the paper will outline these two contributions before discussing their relevance.

2 The σ -consistency problem

A special case of the inverse problem, the σ -consistency problem is only satisfied by a solution defeat relation R that is wholly consistent with input acceptability data for a given semantics σ . This special case is useful as a check that a given semantics is capable of expressing a defeat relation that would explain a set of extensions or labellings. The complexity of a σ -consistency problem with complete semantics (throughout the paper the ‘ σ -consistency problem’ refers only to complete semantics) depends on the type of input acceptability data, where 2-valued data is NP-complete and the 3-valued data can be processed within polynomial time complexity (both are solvable within quadratic space complexity). Note that it is beyond the scope of this paper to formally prove the complexities of the 2-valued and 3-valued σ -consistency problems. Definition 1 formalises the problems according to the reinstatement approach adopted in [Caminada, 2006], as well as the concept of a signature Σ_σ of a semantics σ in which Σ_σ gives the collection of all possible sets of extensions an AF can possess under semantics σ [Dunne et al., 2015].

Definition 1. (σ -consistency problem) Given a set of arguments A , a semantics σ , and a set of labellings T such that for each $L \in T$, $L : A \rightarrow \{\text{IN}, \text{NOTIN}, \text{OFF}\}$ for 2-valued data or for each $L \in T$, $L : A \rightarrow \{\text{IN}, \text{OUT}, \text{UNDEC}, \text{OFF}\}$ for 3-valued data; is there a defeat relation $R \subseteq A \times A$ consistent with T such that $\forall L : (L \in \Sigma_\sigma(S, R))$, where $S = A \setminus X$, and where X is the set of arguments labelled OFF?

An argument will be labelled OFF if it possesses no valid 2-valued or 3-valued label and does not affect the labelling of any other argument $a \in S : S \subset A$. In Example 1, it could be that $L(a) = \text{OFF}$ in a labelling that corresponds to a case without any murder, since there would

be no murder weapon. Hence a would not be a relevant argument to the case and would not affect the label of any other argument, and clearly cannot be labelled according to reinstatement principles as IN, UNDEC, or OUT. The OFF label allows us to build a corpus of arguments that will not generally be relevant to every labelling, but may be important in certain labellings within the wider data set.

3 Experimental results

Beyond theory, an experimental study of all relevant 3-valued and 2-valued NAN algorithms was performed with the use of data from the ICCMA2017 competition, which provided examples of AF s and associated argument extensions. The algorithms were trained on the argument labellings pertaining to the extension sets and the output defeat relations were compared to the ‘actual’ defeat relations from the original data to measure the defeat relation fidelity. Previous analysis had focused on extension-based data sets so that preferred, complete and grounded semantics could be compared as input types. The new analysis instead focused purely on complete semantics and adjusted the size and shape of the data set in terms of number of labellings and the proportion of arguments labelled OFF. Whilst the specifics of the various NAN algorithms are beyond the scope of this paper, online and offline algorithms were designed for 2-valued and 3-valued data types. The 3-valued input was also further divided in two types of algorithms: bulk algorithms where updates according to any given error are applied universally to all candidate weights in the NAN; gradualism algorithms that either incrementally update candidate weights, or select a candidate weight to update randomly or based on the shape of the data. The algorithms designed for noisy data were adapted from the 3-valued gradualism algorithms and the basic 2-valued algorithms.

It is possible to identify trends in defeat relation fidelity, measured by the Matthews Correlation Coefficient (MCC) score, across 2-valued vs 3-valued data types for the σ -consistency problem (Figure 2) and the alternative noisy data problem (Figure 4), as well as across different partial labelling proportions. Figure 3 indicates the trends in defeat relation fidelity as the number of labellings within a data set is increased. Due to space, in

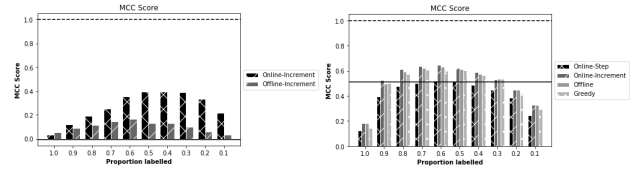

Figure 2: MCC score mean values over fixed-size input labellings varied by reinstatement labelling proportions (where the x-axis value represents the proportion of arguments in the labelling not labelled OFF). Left: 2-valued algorithms (benchmark: argumentation synthesis), right: 3-valued gradualism algorithms (benchmark: best result from bulk algorithms).

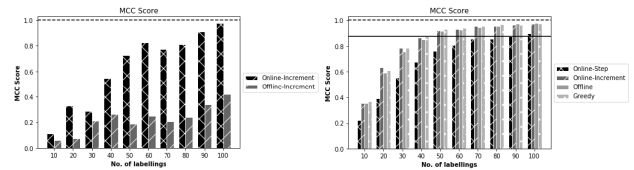

Figure 3: MCC score mean values over various-sized input labellings fixed at 0.5 proportion not labelled OFF (where the x-axis value represents the number of labellings in the data set). Left: 2-valued algorithms (benchmark: argumentation synthesis), right: 3-valued gradualism algorithms (benchmark: best result from bulk algorithms).

this paper, the analysis of the 3-valued bulk algorithms is omitted as their performance was superseded by that of the gradualism algorithms. Across all the plots a benchmark horizontal line provides context for the relative performances. Whilst time results were obtained, they are not included here, again for reasons of space. However, the benchmark argumentation synthesis implementation consistently required orders of magnitude higher time in order to derive a solution that could not be plotted alongside the 3-valued bulk and gradualism algorithms without losing perspective of the relative performances of the algorithms to one another. The 2-valued variants were more comparable to the argumentation synthesis benchmark, reflecting the NP-complete complexity of the associated σ -consistency problem. This trend continued for noisy data, with the 3-valued noisy algorithms being orders of magnitude quicker than the argumentation synthesis benchmark and the 2-valued noisy algorithms frequently requiring timeout stopping conditions. However, the timeouts of the benchmark were unable to result in intermediate solutions even after many hours of runtime, whereas even the 2-valued noisy algorithms could produce results after any arbitrary amount of runtime.

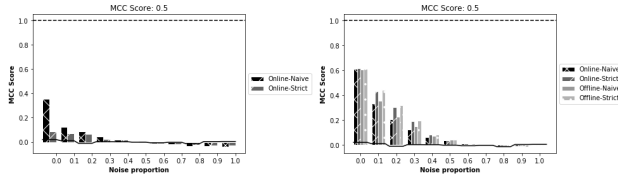

Figure 4: MCC score mean values over fixed-size input labellings fixed at 0.5 proportion not labelled OFF and varied by noise (where the x-axis value represents the proportion of noise in the argument labels). Left: 2-valued algorithms (benchmark: argumentation synthesis), right: 3-valued gradualism algorithms (benchmark: argumentation synthesis).

4 Discussion

The complexity of the σ -consistency problem, as portrayed in Table 2, is of particular interest when one considers the alternative complexity of solutions for noisy data, which in the case of argumentation synthesis [Niskanen et al., 2019] for complete semantics is conjectured to be NP-hard, regardless of whether the data input is 3-valued or 2-valued. This indicates that the nature of the σ -consistency problem is very different than for noisy alternatives. If one wants to ask whether a rational position exists that can fully capture a set of acceptability labellings, then algorithms and data aligned with the 3-valued σ -consistency problem should be sought.

Problem	Time complexity	Space complexity
3-valued	$O(n^2 T)$	$O(n^2)$
2-valued	NP-complete	$O(n^2)$

Table 2: Best-case complexities for the 3-valued and 2-valued σ -consistency problems, where n is the number of arguments and $|T|$ is the number of labellings. Proofs for these complexities is beyond the scope of this paper.

The experimental results further corroborate the intuition that 3-valued data is more desirable than the 2-valued variant. The MCC scores indicate that the 3-valued algorithms are able to conspicuously outperform the 2-valued algorithms in terms of defeat relation fidelity.

Of particular interest is the indication of an optimal size of partial labelling proportion, where around half of the arguments have a valid label. This observation appears to apply for 3-valued and 2-valued data, and across different data sets. Very high MCC scores were obtainable at these proportions, further increasing as the number of labellings in the data sets was able to grow. Combined with the relatively low time requirements, particularly when compared with the frequent timeout failures of the argumentation synthesis benchmark, these results are very promising for

the scalability of the approach for σ consistent as well as noisy solutions.

When compared with the benchmark, the advantages of the 3-valued data and associated algorithms in terms of efficiency and defeat relation fidelity were plain to see. However, the evaluation is limited since the benchmark was restricted to 2-valued data and could not process partial labellings, so a like-for-like comparison was not possible. Nonetheless, for the σ -consistency problem algorithms and the noisy variants, the limited like-for-like comparison strongly suggested the merits of the NAN approach, especially for 3-valued data.

5 Conclusion

This paper has expanded on the concept of neural argumentation networks (NANs) [Mumford, 2020] that address the problem of calculating a defeat relation based on consistency with input argument acceptability data. Two salient expansions were addressed:

1. Defined the σ -consistency problem, where an exactly consistent defeat relation is necessary.
2. Overhauled the experimental analysis to allow for partial labellings as input.

The advantages of reduced complexity and superior defeat relation fidelity derived from using 3-valued data, as opposed to 2-valued data, are apparent from theoretical and empirical results for the σ -consistency problem and for noisy solutions. The scalability and quality of the NAN approach is highlighted by the favourable comparison to the Max-Sat argumentation synthesis benchmark implementation.

The research is relevant in the scope that defeat relations are essential for the construction of argumentation frameworks. The NAN algorithms are proffered as a means of calculating such defeat relations when prior knowledge and extraction from the argument structure is not reliable. Further research is needed to examine the impact of the algorithms with real domains and to evaluate the effects of enriching the algorithms with alternative mechanisms such as support and weighted argumentation.

Acknowledgements

The research described by this short paper could not have been possible without their influence and/or contribution: E. Black, K. Mumford, S. Parsons and I. Sassoon.

References

- [Baroni et al., 2011] Baroni, P., Caminada, M., and Giacomin, M. (2011). An introduction to argumentation semantics. *Knowledge Engineering Review*, 26(4):365.
- [Bench-Capon and Dunne, 2007] Bench-Capon, T. J. and Dunne, P. E. (2007). Argumentation in artificial intelligence. *Artificial Intelligence*, 171(10-15):619–641.
- [Caminada, 2006] Caminada, M. (2006). On the issue of reinstatement in argumentation. In *European Workshop on Logics in Artificial Intelligence*, pages 111–123.
- [Dung, 1995] Dung, P. M. (1995). On the acceptability of arguments and its fundamental role in nonmonotonic reasoning, logic programming and n-person games. *Artificial Intelligence*, 77(2):321–357.
- [Dunne et al., 2015] Dunne, P. E., Dvořák, W., Linsbichler, T., and Woltran, S. (2015). Characteristics of multiple viewpoints in abstract argumentation. *Artificial Intelligence*, 228:153–178.
- [Kido and Liao, 2019] Kido, H. and Liao, B. (2019). A Bayesian approach to direct and inverse abstract argumentation problems. *arXiv preprint arXiv:1909.04319*.
- [Mumford, 2020] Mumford, J. (2020). Crafting neural argumentation networks. *Online Handbook of Argumentation for AI*, page 22.
- [Niskanen et al., 2019] Niskanen, A., Wallner, J., and Järvisalo, M. (2019). Synthesizing argumentation frameworks from examples. *Journal of Artificial Intelligence Research*, 66:503–554.
- [Rahwan and Simari, 2009] Rahwan, I. and Simari, G. R. (2009). *Argumentation in artificial intelligence*, volume 47. Springer.
- [Riveret and Governatori, 2016] Riveret, R. and Governatori, G. (2016). On learning attacks in probabilistic abstract argumentation. In *AAMAS*, pages 653–661.

From the Logic of Proofs to the Logic of Arguments

Stipe Pandžić

Theoretical Philosophy Group, Department of Philosophy and Religious Studies,
Utrecht University, The Netherlands

Abstract

This paper reports on the development of default justification logic. The logic was developed as a part of the PhD project [Pandžić, 2020b], with an aim to model defeasible arguments as formulas of the justification logic object-language. The resulting logic is unique for its potential to determine the acceptability of arguments by using only the definition(s) of logical consequence.

1 Introduction

The seminal work of Toulmin [Toulmin, 2003] gave rise to the idea that the use of formal logic in argumentation is limited to deductive arguments. Toulmin's work anticipated the trend that led to the development of "informal logic" with an aim to analyze non-deductive arguments in a natural language setting. The interest in formal methods for argumentation followed the emergence of artificial intelligence research, where Pollock's work [Pollock, 1987] on defeasible reasoning stands as a landmark.

Within this research venue, multiple formal systems have been proposed to advance the computational study of structured arguments. Among them are ABA [Bondarenko et al., 1997], deductive argumentation [Besnard and Hunter, 2001], DefLog [Verheij, 2003] and ASPIC+ [Prakken, 2010]. All the mentioned systems use logical tools to represent arguments with their internal structures (not only as atomic entities as done in [Dung, 1995]) to formalize the idea of opposition between arguments by providing a theory of argumentative attacks and to define

procedures that give those arguments that are undefeated. However, none of these argumentation formalisms counts as a logical system with a definition of logical consequence.

This paper reports on the logic of default justifications (or reasons) [Pandžić, 2018, Pandžić, 2019, Pandžić, 2020a, Pandžić, 2020b, Pandžić, 2021] that not only uses formal logic notions to model arguments, but rather is itself a full-fledged logic of arguments that manipulates structured arguments at a purely symbolic level. In default justification logic, structured arguments are formalized as object-level formulas of the logical system. The PhD project [Pandžić, 2020b] is centered around this logic that responds to Toulmin's anti-formalistic misgivings by providing a method to determine whether a non-deductive argument is acceptable or not through a normative system with logical consequence.

The next section outlines the underlying method by which we represent structured arguments, starting from a novel logical theory of default reasons. To be able to talk about reasons, we rely on a logical language that goes beyond propositions and represents reasons as a part of its syntax. Such a theory of reasons is one of the fundamental contributions of justification logics [Artemov, 1995, Artemov, 2001]. Justification logics tell us that a pattern of reasoning from starting premises can be captured by means of labels preceding statements and, thereby, forming *justification assertions*:

reason: conclusion.

This method enables us to develop a system that features reasons as logical entities *sui generis*, and we

will shortly describe it in more detail.

2 Method

We start by explaining the basics of justification logics [Artemov and Fitting, 2019]. Justification logics are modal-like logics, often included in the class of epistemic logics.¹ Informally, the idea of justification logics is to replace epistemic modalities “**K**” (“in all accessible alternatives...”) with explicit justifications “*t*” (“for the reason *t*...”) preceding a formula *F* so as to produce justification assertions $t : F$ informally read as “*F* is known for the reason *t*” or “*t* justifies *F*”. In this paper, we will only use two basic operations on reason terms *Application* (‘ \cdot ’) and *Sum* (‘+’). Application produces a reason term ($u \cdot t$) for a formula *G* which is a syntactic “imprint” of the *modus ponens* step from $F \rightarrow G$ and F to *G* for some labelled formulas $u : (F \rightarrow G)$ and $t : F$. Sum can be understood as a method to concatenate reasons in such a way that if *t* is a reason for *F*, then we can produce the reason term ($t + u$) which is also a reason for *F*.

Formally, the set of exactly all reason terms (polynomials) *Tm* is built from justification variables x_1, \dots, x_n, \dots and justification constants c_1, \dots, c_n, \dots using two operators (‘+’ and ‘ \cdot ’), according to the following grammar:

$$t ::= x \mid c \mid (t \cdot t) \mid (t + t).$$

Using the grammar of reason terms, we define the set *Fm* of justification logic formulas built according to the following grammar:

$$F ::= \top \mid P \mid (F \rightarrow F) \mid (F \vee F) \mid (F \wedge F) \mid \neg F \mid t : F,$$

where $P \in \mathcal{P}$ and \mathcal{P} is a countable set of atomic propositional formulas and $t \in Tm$.

We use the logic **JT** first introduced in [Brezhnev, 2001]. This is the weakest logic with non-defeasible and factive (truth-inducing) reasons, that is, with the axioms A2 and A3 below. This system is

¹Historically, the first justification logic was the logic of formal proofs in arithmetic **LP**, which was fully developed in [Artemov, 2001].

then generalized to model defeasible reasons. These are the axioms and rules of **JT**:

A0 All the instances of propositional logic tautologies from *Fm*

A1 $t : (F \rightarrow G) \rightarrow (u : F \rightarrow (t \cdot u) : G)$ (Application)

A2 $t : F \rightarrow (t + u) : F; \quad u : F \rightarrow (t + u) : F$ (Sum)

A3 $t : F \rightarrow F$ (Factivity)

The logic **JT** is equipped with the inference rules *Modus ponens* and *Iterated axiom necessitation*. Axiom necessitation rules ensure justification of basic logical postulates. Each axiom instance of A0-A3 is justified by a justification constant, and the iterated version ensures that such justified formulas are themselves justified by a justification constant.²

The interpretation \mathcal{I} for **JT** relies on two functions. Together with a standard *truth assignment* function for propositional formulas in \mathcal{P} , \mathcal{I} relies on a *reason assignment* $*(\cdot) : Tm \rightarrow 2^{Fm}$, which is a function mapping each term to a set of formulas from *Fm*. For an interpretation \mathcal{I} , \models is a truth relation on the set of formulas of **JT** with the following clause for a justification assertion $t : F \in Fm$: $\mathcal{I} \models t : F$ iff $F \in *(t)$. Thus, in the basic logic **JT**, the connection between a reason *t* and a formula *F* is given by means of a reason assignment function. But in our default semantics, whether *t* justifies *F* or not has to be decided on the basis of other available justifications that might defeat *t*. Instead of a fully specified function $*(\cdot)$, the main task of the logic of default reasons is to give a procedure to determine if *t* should be accepted as a justification for *F*.

We start by defining default theories and default rules with **JT** formulas. A default theory *T* is a pair (W, D) , where the set *W* is a finite set of **JT** formulas and *D* is a countable set of default rules. Each default rule is of the following form:

$$\delta = \frac{t : F :: (u \cdot t) : G}{(u \cdot t) : G}.$$

The informal reading of the default δ is: “If *t* is a reason justifying *F*, and it is consistent to assume that

²In justification logics, justifying logical truths usually takes into account multiple restrictions and conditions that we omit here [Artemov and Fitting, 2019, pp. 17-18].

$(u \cdot t)$ is a reason justifying G , then $(u \cdot t)$ is a defeasible reason justifying G .³ We can think about the strategy of introducing uncertain information via δ as analogous to the strategy of introducing uncertain information via Reiter’s default rules [Reiter, 1980]. The main difference is that Reiter’s defaults build on first-order formulas and our defaults build on justification assertions.

We exemplify the above defined notions of default rules and default reasons by means of (an extension of) an example taken from [Toulmin, 2003, p. 103].

Example Toulmin. Take S to be the proposition “Petersen is Swedish” and take R to be the proposition “Petersen is a Roman Catholic”. For some specific individual justifications p and q , δ' describes the default reasoning encoded by the term $(q \cdot p)$:

$$\delta' = \frac{p : S :: (q \cdot p) : \neg R}{(q \cdot p) : \neg R}.$$

Informally, δ' reads as follows: “If p is a reason justifying that Petersen is Swedish and it is consistent for you to assume that this gives you a reason $(q \cdot p)$ justifying that Petersen is not a Roman Catholic, then you have a defeasible reason $(q \cdot p)$ justifying that Petersen is not a Roman Catholic”. Were you then to learn that although Petersen is a Swede, “Petersen’s parents emigrated from Austria” (A), you would have an *undercutting defeater* (exclusionary reason) for $(q \cdot p)$:

$$\delta'' = \frac{r : A :: (s \cdot r) : \neg[q : (S \rightarrow \neg R)]}{(s \cdot r) : \neg[q : (S \rightarrow \neg R)]},$$

for some specific justifications s and r . The consequent of the rule δ'' is read as “you have a defeasible reason $(s \cdot r)$ denying that the reason q justifies that if Petersen is Swedish, then he is not a Roman Catholic”. Moreover, suppose that you recall that “Petersen went to Saint Eric’s Cathedral in Stockholm this Christmas” (C). This would give you an independent *rebutting defeater* and a reason to justifying that Petersen is a Roman Catholic. For some specific justifications t and u , we define:

$$\delta''' = \frac{t : C :: (u \cdot t) : R}{(u \cdot t) : R}.$$

³We impose three uniqueness criteria for the reason term u introduced by δ . See in [Pandžić, 2021, §3].

The example can be described by the default theory $T_1 = (W_1, D_1)$ with $W_1 = \{p : S, r : A, t : C\}$ and $D_1 = \{\delta', \delta'', \delta'''\}$.

The semantics for our default theories is inspired by Antoniou’s [Antoniou, 1997] operational semantics for Reiter’s default theories. Applicability of defaults is determined in the following way: for a set of deductively closed formulas Γ we say that a default rule $\delta = \frac{t:F::(u \cdot t):G}{(u \cdot t):G}$ is applicable to Γ iff $t : F \in \Gamma$ and $\neg(u \cdot t) : G \notin \Gamma$. Default consequents are brought together by applying sequences of defaults $\Pi = (\delta_0, \delta_1, \dots)$. In this way, we obtain the evidence base set $In(\Pi)$ that is defined as a deductive closure of the union $W \cup \{cons(\delta) \mid \delta \text{ occurs in } \Pi\}$. Intuitively, $In(\Pi)$ collects reason-based information that is yet to be determined as acceptable or unacceptable.

The focus of our semantics is on meaningful Π -sequences called “processes”. A sequence of default rules Π is a *process* of a default theory $T = (W, D)$ iff every k such that $\delta_k \in \Pi$ is *applicable* to the set $In(\Pi[k])$, where $\Pi[k]$ is the segment of Π listing all the rules whose application is considered before δ_k .

The richness of the language of justifications enables us to give a logical theory of the notions from structured argumentation. The function *warrant assignment* $\#(\cdot) : D \rightarrow Fm$ maps each default rule to a specific justified conditional as follows:

$$\#(\delta) = u : (F \rightarrow G),$$

where $\delta \in D$ and $\delta = \frac{t:F::(u \cdot t):G}{(u \cdot t):G}$. Inspired by Toulminan warrants, our warrants can be seen not only as specific formulas, but also as rules or the underlying principles of default generalizations.

This twofold nature of warrants is used to define the basic type of conflict between default reasons, namely, *undercutting*. A reason u undercuts reason t being a reason for a formula F in a set of **JT**-closed formulas $\Gamma \subseteq In(\Pi)$ iff $u : \neg[v : (G \rightarrow H)] \in \Gamma$, for some subterm u of t , and $v : (G \rightarrow H) = \#(\delta)$, for some δ that is applied to a process of T . In T_1 , the consequent of δ'' or, more precisely, the default reason $(s \cdot r)$ undercuts $(q \cdot p)$ as a reason for $\neg R$.

Using the definition of undercut, we can specify conflict-free sets of formulas. Formal details can be found in [Pandžić, 2021, p. 17], together with a proof

that each conflict-free set defined in terms of undercut is also rebuttal-free. In our logic, rebuttal ultimately results from rule inapplicability due to **JT** inconsistency. This is the case with the rebuttal between $(q \cdot p)$ and $(u \cdot t)$ in T_1 , which is induced by the contradiction between $\neg R$ and R .

The standard intuitions behind defending arguments are captured in the definition of acceptability. Informally, $t : F$ is acceptable w.r.t. a set of **JT** formulas whenever that set undercuts all the undercutters of t within a relevant evidence base set $In(\Pi)$.

We define multiple argumentation theory extensions for any default theory $T = (W, D)$ starting from *potential extensions* sets Γ that always contain formulas from W and, possibly, consequents of defaults for some process Π of T .

JT-Admissible Extension A potential extension set of **JT** formulas $\Gamma \subset In(\Pi)$ is a **JT**-admissible extension of a default theory $T = (W, D)$ iff Γ is conflict-free, each formula $t : F \in \Gamma$ is acceptable with respect to Γ and Π is closed.

JT-Preferred Extension A deductive closure of a **JT**-admissible extension Γ is a **JT**-preferred extension of T iff for any other **JT**-admissible extension Γ' , $\Gamma \not\subset \Gamma'$.

JT-Stable Extension A conflict-free deductive closure of a potential extension Γ is a **JT**-stable extension iff Γ undercuts all the default consequents outside its deductive closure, for all the defaults applied to any process of T .

Other standard extensions from argumentation theory and more detailed presentation of argumentation semantics in justification logic can be found in [Pandžić, 2020b, Ch. 2] and [Pandžić, 2021, § 3].

3 Discussion

A recapitulation of T_1 is given in Figure 1. According to the definitions from Section 2, we can confirm that **JT**-stable and **JT**-preferred extension of T_1 coincide in the deductive closure of $W_1 \cup \{(s \cdot r) : \neg[q : (S \rightarrow \neg R)], (u \cdot t) : R\}$. Note that the process $\Pi = (\delta', \delta'')$ includes a revision of acceptable reasons, because $(s \cdot r)$ undercuts $(q \cdot p)$.

The logic of arguments sketched here opens up a possibility to fully formalize Toulmin's argumentative

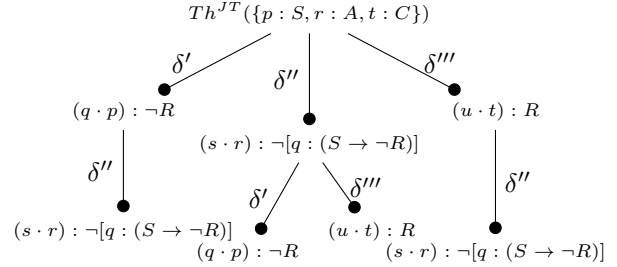

Figure 1: The process tree of T_1

schema (cf. [Pandžić, 2021, p. 16]). An important step to fully realize this is to use the first-order variant of justification logic [Fitting, 2014], instead of the propositional justification logic used here. This will enable a faithful formalization of Toulmin's warrants in the following format of default rules:

$$\frac{t_{\{x\}} : F :: (u \cdot t)_{\{x\}} : G}{(u \cdot t)_{\{x\}} : G},$$

where x in $t_{\{x\}} : F$ is a free variable throughout the derivation t . Such rules will act as default schemas that convey the generality of Toulmin's warrants.

4 Conclusion

Default justification logic is remarkable for its potential to model structured defeasible arguments as formulas of the object-language. In [Pandžić, 2020b, Ch. 3] and [Pandžić, 2021, § 4], a reader can find a method to translate between our default theories and abstract argumentation frameworks [Dung, 1995]. These methods embed our logic in the existing study of formal argumentation. Some aspects of this logic have not been mentioned here, e.g. the dynamics of default theories and *undermining* attacks as defined in [Pandžić, 2020a]. However, we at least sketch here how to “climb up” to the concepts of argumentation theory starting from a language initially proposed to represent formal proofs of mathematical statements. At the end of this paper, we indicate one of the most interesting open problems that is currently being investigated, namely, that of using first-order justification logic as a basic logic of default theories.

Acknowledgements

I am grateful to Allard Tamminga, Barteld Kooi and Rineke Verbrugge for their generous support throughout my PhD project and to the two OHAAI reviewers for their helpful suggestions on this paper. My PhD thesis was written with the support of the *Ammodo KNAW* project *Rational Dynamics and Reasoning* awarded to Barteld Kooi.

References

- [Antoniou, 1997] Antoniou, G. (1997). *Nonmonotonic Reasoning*. Cambridge, MA: MIT Press.
- [Artemov, 1995] Artemov, S. N. (1995). Operational modal logic. Technical Report MSI 95–29, Mathematical Sciences Institute, Cornell University.
- [Artemov, 2001] Artemov, S. N. (2001). Explicit provability and constructive semantics. *Bulletin of Symbolic Logic*, pages 1–36.
- [Artemov and Fitting, 2019] Artemov, S. N. and Fitting, M. (2019). *Justification Logic: Reasoning with Reasons*, volume 216 of *Cambridge tracts in mathematics*. Cambridge University Press.
- [Besnard and Hunter, 2001] Besnard, P. and Hunter, A. (2001). A logic-based theory of deductive arguments. *Artificial Intelligence*, 128(1-2):203–235.
- [Bondarenko et al., 1997] Bondarenko, A., Dung, P. M., Kowalski, R. A., and Toni, F. (1997). An abstract, argumentation-theoretic approach to default reasoning. *Artificial Intelligence*, 93(1-2):63–101.
- [Brezhnev, 2001] Brezhnev, V. (2001). On the logic of proofs. In Striegnitz, K., editor, *Proceedings of the Sixth ESSLLI Student Session, Helsinki*, pages 35–46.
- [Dung, 1995] Dung, P. M. (1995). On the acceptability of arguments and its fundamental role in nonmonotonic reasoning, logic programming and n-person games. *Artificial Intelligence*, 77(2):321–357.
- [Fitting, 2014] Fitting, M. (2014). Possible world semantics for first-order logic of proofs. *Annals of Pure and Applied Logic*, 165(1):225–240.
- [Pandžić, 2018] Pandžić, S. (2018). A logic of default justifications. In Fermé, E. and Villata, S., editors, *Nonmonotonic Reasoning, 17th International Workshop, NMR 2018*, pages 126–135.
- [Pandžić, 2019] Pandžić, S. (2019). Reifying default reasons in justification logic. In Beierle, C., Ragni, M., Stolzenburg, F., and Thimm, M., editors, *Proceedings of the KI 2019 Workshop on Formal and Cognitive Reasoning, DKB-KIK 2019*, volume 2445, pages 59–70. CEUR Workshop Proceedings.
- [Pandžić, 2020a] Pandžić, S. (2020a). On the dynamics of structured argumentation: Modeling changes in default justification logic. In Herzig, A. and Kontinen, J., editors, *Foundations of Information and Knowledge Systems, 11th International Symposium, FoIKS 2020*, volume 12012 of LNCS, pages 222–241. Springer.
- [Pandžić, 2020b] Pandžić, S. (2020b). *Reasoning with Defeasible Reasons*. PhD thesis, University of Groningen.
- [Pandžić, 2021] Pandžić, S. (2021). A logic of defeasible argumentation: Constructing arguments in justification logic. *Argument & Computation*, Prepress:1–45.
- [Pollock, 1987] Pollock, J. L. (1987). Defeasible reasoning. *Cognitive Science*, 11(4):481–518.
- [Prakken, 2010] Prakken, H. (2010). An abstract framework for argumentation with structured arguments. *Argument and Computation*, 1(2):93–124.
- [Reiter, 1980] Reiter, R. (1980). A logic for default reasoning. *Artificial Intelligence*, 13(1-2):81–132.
- [Toulmin, 2003] Toulmin, S. E. (1958/2003). *The Uses of Argument*. Cambridge University Press.
- [Verheij, 2003] Verheij, B. (2003). DefLog: On the logical interpretation of prima facie justified assumptions. *Journal of Logic and Computation*, 13(3):319–346.

Building an Argument Mining Pipeline for Tweets

Robin Schaefer

Applied Computational Linguistics
University of Potsdam, Germany

Abstract

The field of argument mining has grown notably in the recent decade. However, only little attention has been given to argumentation on social media. This paper presents first progress of a dissertation project on tweet-based argument mining. Specifically, we describe our argument model and argument mining pipeline. Further, we show first results both on argument corpus annotation, argument filtering and argument component detection and conclude with an outlook on planned future work.

1 Introduction

The field of argument mining (AM) [Stede and Schneider, 2018], which is situated at the interface of computational linguistics and computational argumentation, has grown notably in the recent decade. While the majority of research has focused on well-edited texts, less formal user-generated texts, e.g. from social media, have been investigated less frequently. Recent work, however, indicates that this is changing [Bauwelinck and Lefever, 2020, Lindahl, 2020, Schaefer and Stede, 2020].

In this paper, we present an ongoing dissertation project on tweet-based AM, which we motivate as follows: Twitter¹ is a microblogging platform that is frequently used for expressing views on a wide range of topics, including controversial issues like climate change [Veltri and Atanasova, 2017], which makes it an interesting data source for investigating AM on

user-generated data. Also, AM applications like argument ranking systems could provide insights on how users debate on Twitter. However, tweets tend to be relatively noisy due to language irregularities (e.g. typos) and social media conventions (e.g. hashtags) which form obstacles for AM systems trained on data from other domains [Šnajder, 2016].

Previous work² on tweet-based AM concentrated on the creation of annotated argument tweet corpora [Addaood and Bashir, 2016, Bosc et al., 2016a]. Additionally first attempts on AM sub-tasks, e.g. evidence detection, were presented [Addaood and Bashir, 2016, Bosc et al., 2016b, Dusmanu et al., 2017]. To date, however, no fully functional AM pipeline for tweets exists.

Developing an AM pipeline for tweets requires two-fold progress: 1. Argument components have to be modeled and annotated successfully; 2. An AM pipeline has to be developed. Creating new annotated corpora is of utmost importance, as so far limited annotated data resources restrict the potential of AM pipelines.

This paper is structured as follows: Section 2 presents our somewhat simplified argument model, i.e. the definitions of argument components. Section 3 describes the design of the AM pipeline and the methods that can be used to implement it. Section 4 discusses the already conducted work and presents first results (originally published in [Schaefer and Stede, 2020]). Section 5 concludes this paper with an outlook on planned future work.

¹<https://twitter.com/>

²For a recent review of the state of the art in tweet-based AM, see [Schaefer and Stede, 2021].

2 Argument Model

Not all tweets are written with an argumentative purpose. Also, if argumentation takes place it may have low complexity due to the constraint of 280 characters per tweet. This requires somewhat simplified argument component definitions. In general, we distinguish two basic components: *claim* and *evidence*. A claim is defined as a standpoint towards a topic, e.g. climate change. Evidence is described as a supportive or attacking statement with respect to the claim (e.g. [We have to limit CO2 emissions]_{claim}, [as too much CO2 has been shown to increase the greenhouse effect.]_{evidence} [Schaefer and Stede, 2020]). While traditionally a full argument requires at least one evidence unit in addition to a claim, we consider independent claims to be argumentative as well. This accounts for the reduced complexity of tweets. Evidence units, however, have to be linked to a claim. We refer to both components as *Argumentative Discourse Units* (ADU) [Peldszus and Stede, 2013].

We further decided on utilizing tweet pairs in a reply relation, which distinguishes this work from previous research. While the first tweet functions as context, only the subsequent tweet, the reply, is subject to actually mining argumentative structure, i.e. all presented annotation and AM results refer to the reply tweets. This design choice was based on the assumption that context could have a facilitating effect on argument annotation. Also it enabled us to further distinguish different evidence units with respect to the tweet the target claim occurs in: reply tweet, context tweet, or both. Finally, it accounts for the need of argumentation to be embedded in context.

3 Argument Mining Pipeline

AM is hardly considered as a single task. Instead successful AM requires a pipeline of components which focus on specific sub-tasks. The actual complexity of a given AM pipeline depends on its use case. For instance, while for some approaches mere claim detection may suffice, others may further require detection of relations between argument components. With re-

spect to tweet-based AM we consider the following tasks as relevant (see Figure 1): 1. (optional) corpus annotation³, 2. argument filtering (i.e. general argument detection) 3. ADU detection (claim and evidence detection), 4. relation detection, 5. output creation (argument ranking and graph building), and 6. argument quality assessment. To date, we have made first progress on corpus annotation, argument filtering and ADU detection.

Argument Filtering. Given that many tweets are not created with an argumentative purpose, the implementation of a general argument detector is crucial. We consider this component as a filter that separates the data into argumentative and non-argumentative tweets. Only the argumentative sub-corpus will be used in subsequent steps. As this is basically a binary classification task, a supervised classification algorithm, like Support Vector Machines (SVM) or eXtreme Gradient Boosting (XGBoost), may be used for training.

ADU Detection. Once argumentative tweets have been identified, the following component is responsible for detecting claim and evidence. These tasks may be treated in conjunction or independently. Depending on the purpose of the pipeline, it may be necessary to identify claim and evidence on the full tweet level or within tweets. For instance, an argument ranking application would likely require the detection of concrete ADU spans.

If claim and evidence detection is performed on the full tweet level, supervised classification, as for argument filtering, could be applied. For identifying ADU spans, sequence labeling approaches like Conditional Random Fields (CRF) are more appropriate.

Relation Detection. Relation detection (support vs attack) can be considered as another core task of AM. It can support ADU detection whenever ambiguity exists with respect to the relation between claim and evidence. Alternatively, relation detection may be applied to identify relations between full tweets [Bosc et al., 2016b].

³Corpus annotation itself is not part of the AM pipeline. However, it is a necessary task whenever supervised approaches are chosen and no suitable annotated data source exists.

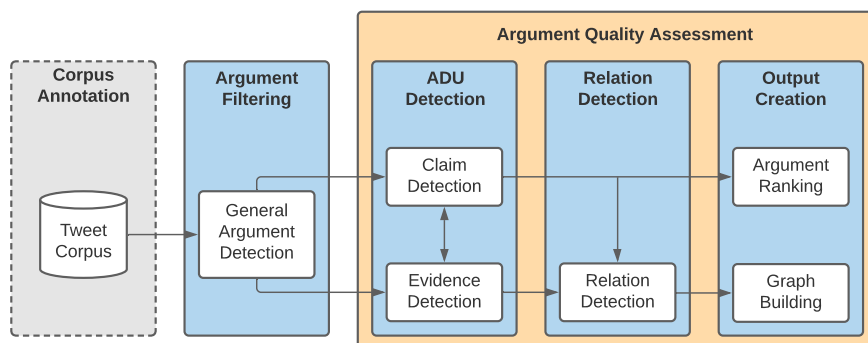

Figure 1: Argument Mining Pipeline (*Corpus Annotation* technically is not part of the pipeline itself. *ADU Detection*, *Relation Detection* and *Output Creation* can be subject to *Argument Quality Assessment*).

Being again a classification task, any classification algorithm could be applied. Still, more recent approaches like an LSTM-based neural network have been used as well [Bosc et al., 2016b].

Output Creation. When developing an AM pipeline it is reasonable to consider different target applications, i.e. to devise opportunities how potential users of the pipeline may benefit from it. One possible output solution is *graph building*. Given a tweet set the objective would be to detect argument components and relations and derive a full argumentative structure, which could be visualized as a graph. As tweets are short in nature this requires taking into account information across tweet boundaries. Furthermore, it is possible to build graphs with full tweets as nodes as was proposed by [Bosc et al., 2016b].

Another potential application is argument ranking, which can be understood as a way to summarize argumentation. While the focus probably lies on claims, evidence may be accounted for as well. Here, we consider relation detection as of less importance. An argument ranking mechanism could be used for identifying the most important or frequent positions uttered in a discussion.

Argument Quality Assessment. Finally argument quality assessment plays an important role in an AM pipeline for tweets. As Twitter was not conceived as an argumentative platform per se, it is fair to as-

sume that argumentation may be lacking some quality standards. First, although we accept single claims as argumentative units, we still regard arguments backed up by evidence as of higher quality. Second, evidence units themselves may be of different quality as well. For instance, [Addawood and Bashir, 2016] focused on the annotation and classification of several evidence types, e.g. news or expert opinion. Furthermore, argument quality assessment may revolve around fact recognition and source identification [Dusmanu et al., 2017].

Quality assessment may be applied to the following components: ADU detection, relation detection, and output creation (see Figure 1). For instance, depending on the respective evidence unit, support/attack can be of varying success which may have implications both for relation detection and graph building.

4 Results & Discussion

In this section we present and discuss first results both on the creation of an argumentative tweet corpus and the development of first versions of AM pipeline components. For more details the reader is referred to the original paper [Schaefer and Stede, 2020].

Corpus Annotation Results. To date we have conducted an annotation study with the objective of providing high quality ADU annotations

within tweets. Previous studies, in contrast, focused on annotations on the full tweet level [Addaood and Bashir, 2016, Bosc et al., 2016a].

Two expert annotators were presented with 300 German tweet pairs in a reply relation. Calculating inter-annotator agreement (IAA) using Cohen’s κ yielded the following scores: 0.38 (claim vs. evidence vs non-argumentative) and 0.45 (argumentative vs non-argumentative). We further derived full tweet annotations from the annotated ADU spans, which yielded the following Cohen’s κ scores per ADU type: 0.53 (argument, i.e. claim or evidence), 0.55 (claim), and 0.44 (evidence).

While the IAA scores surely leave room for improvement it is noteworthy that comparable annotation tasks led to similar results [Lindahl, 2020]. We attribute this to the relatively subjective nature of the task. Interestingly, scores for evidence annotation are reduced compared to the claim annotation results. We argue that this is related to our ADU definitions. Recall that evidence is always interpreted with respect to a claim. Thus, annotating evidence requires a more fine-grained decision which increases the task difficulty.

Approach	Target	F1 (weighted)
Classification	Argument	0.82
Classification	Claim	0.82
Classification	Evidence	0.59
Sequence Labeling	Argument	0.72
Sequence Labeling	Claim	0.59
Sequence Labeling	Evidence	0.75

Table 1: Classification & Sequence Labeling Results.

Argument Mining Results. So far our work focused on the development of general argument, claim and evidence detectors, i.e. on the first two steps of the pipeline. Note, however, that to date our models have not been trained as part of an actual pipeline, e.g. a claim detector has not been trained on a fully argumentative tweet set. We experimented with two approaches (supervised classification and sequence labeling) and used our full tweet annotations

and ADU span annotations, respectively. Classification results are yielded by XGBoost classifiers, while for sequence labeling we applied CRF. For feature extraction we fine-tuned pre-trained BERT embeddings [Devlin et al., 2019].

We trained first versions of a general argument detector using the respective target annotation layer of the data. Our models achieved promising F1 scores of 0.82 (classification) and 0.72 (sequence labeling). As noted previously, an argument detector does not require to be trained on ADU spans, if it is to be used as a simple filter component. Given that classification yielded better results, we propose to implement an argument filter based on supervised classification.

Furthermore we trained claim and evidence detectors using the annotated data. Again, we applied both classification and sequence labeling approaches. However, we consider sequence labeling, i.e. the detection of ADU spans, as more appropriate for a full AM pipeline. The claim detector model yielded F1 scores of 0.82 and 0.59 for classification and sequence labeling, respectively. Evidence detection showed a reverse pattern with F1 scores of 0.59 for classification and 0.75 for sequence labeling.

5 Conclusion

In this paper we presented first progress of a dissertation project on tweet-based AM. We designed an AM pipeline that consists of four dependent steps: argument filtering, ADU detection, relation detection, and output creation. So far, first results on argument filtering and ADU detection have been achieved. In addition, progress on argument annotation was made.

Currently we work on refining our annotation scheme to achieve more sophisticated IAA scores. We also investigate alternative ways to model argument components. Specifically, we are interested in identifying major claims, i.e. the central statement of a tweet. This may support the implementation of target applications like argument ranking. As the annotated sub-corpus is rather small, we plan to annotate more data with the revised annotation scheme.

With respect to the AM pipeline, in the near future we plan to improve the argument filter and ADU

detection components. This includes optimizing the used models and hyperparameters.

Acknowledgements

The author thanks Manfred Stede for his advice and support and Polina Krasilnikova for assisting with corpus annotation.

References

- [Addawood and Bashir, 2016] Addawood, A. and Bashir, M. (2016). “What is your evidence?” A study of controversial topics on social media. In *Proceedings of the Third Workshop on Argument Mining (ArgMining2016)*, pages 1–11, Berlin, Germany. Association for Computational Linguistics.
- [Bauwelinck and Lefever, 2020] Bauwelinck, N. and Lefever, E. (2020). Annotating topics, stance, argumentativeness and claims in Dutch social media comments: A pilot study. In *Proceedings of the 7th Workshop on Argument Mining*, pages 8–18, Online. Association for Computational Linguistics.
- [Bosc et al., 2016a] Bosc, T., Cabrio, E., and Villata, S. (2016a). DART: A dataset of arguments and their relations on Twitter. In *Proceedings of the Tenth International Conference on Language Resources and Evaluation (LREC’16)*, pages 1258–1263, Portorož, Slovenia. European Language Resources Association (ELRA).
- [Bosc et al., 2016b] Bosc, T., Cabrio, E., and Villata, S. (2016b). Tweeties squabbling: Positive and negative results in applying argument mining on social media. In *Computational Models of Argument - Proceedings of COMMA 2016, Potsdam, Germany, 12-16 September, 2016*, volume 287 of *Frontiers in Artificial Intelligence and Applications*, pages 21–32. IOS Press.
- [Devlin et al., 2019] Devlin, J., Chang, M.-W., Lee, K., and Toutanova, K. (2019). BERT: Pre-training of deep bidirectional transformers for language understanding. In *Proceedings of the 2019 Conference of the North American Chapter of the Association for Computational Linguistics: Human Language Technologies, Volume 1 (Long and Short Papers)*, pages 4171–4186, Minneapolis, Minnesota. Association for Computational Linguistics.
- [Dusmanu et al., 2017] Dusmanu, M., Cabrio, E., and Villata, S. (2017). Argument mining on Twitter: Arguments, facts and sources. In *Proceedings of the 2017 Conference on Empirical Methods in Natural Language Processing*, pages 2317–2322, Copenhagen, Denmark. Association for Computational Linguistics.
- [Lindahl, 2020] Lindahl, A. (2020). Annotating argumentation in Swedish social media. In *Proceedings of the 7th Workshop on Argument Mining*, pages 100–105, Online. Association for Computational Linguistics.
- [Peldszus and Stede, 2013] Peldszus, A. and Stede, M. (2013). From argument diagrams to argumentation mining in texts: A survey. *Int. J. Cogn. Inform. Nat. Intell.*, 7(1):1–31.
- [Schaefer and Stede, 2020] Schaefer, R. and Stede, M. (2020). Annotation and detection of arguments in tweets. In *Proceedings of the 7th Workshop on Argument Mining*, pages 53–58, Online. Association for Computational Linguistics.
- [Schaefer and Stede, 2021] Schaefer, R. and Stede, M. (2021). Argument mining on Twitter: A survey. *it - Information Technology*, 63(1).
- [Stede and Schneider, 2018] Stede, M. and Schneider, J. (2018). *Argumentation Mining*, volume 40 of *Synthesis Lectures in Human Language Technology*. Morgan & Claypool.
- [Veltri and Atanasova, 2017] Veltri, G. A. and Atanasova, D. (2017). Climate change on twitter: Content, media ecology and information sharing behaviour. *Public Understanding of Science*, 26(6):721–737.
- [Šnajder, 2016] Šnajder, J. (2016). Social media argumentation mining: The quest for deliberateness in raucousness.

Towards Argument Embeddings

Luke Thorburn

University of Melbourne, Australia

Abstract

Argument mining is a core natural language processing (NLP) task that provides a bridge between natural language and formal argumentation frameworks. Current research is constrained by available annotated corpora, which are small compared to those available for other NLP tasks. In light of recent empirical work suggesting the existence of scaling laws for neural language models, we argue that this constraint has led to insufficient regard for whether the architectures studied will scale well to larger models and datasets. We propose a new high-level architecture for end-to-end argument mining to serve as a blueprint for scalable argument mining systems, and introduce the concept of *argument embeddings*: representations of argument components that encode information about argumentative relations. Future work, including implementation and evaluation of the proposed model, is discussed.

1 Introduction

Argument mining—the automated extraction of the argumentative structure of text—is a core problem within the broader field of computational argumentation [Lawrence and Reed, 2020]. The development of reliable argument mining algorithms would create a link between existing corpora of non-fiction text and formal argumentation frameworks, enabling scalable evaluation of reasoning quality in information marketplaces (e.g. [van Gelder et al., 2019]) and the development of new tools for augmenting human reasoning. As a natural language processing (NLP) task, however, argument mining is relatively immature.

Existing corpora annotated for argumentation are small, on the order of 10^2 documents, and creating high-quality annotations is labour-intensive [Lawrence and Reed, 2020, Sec. 4]. Thus by necessity, argument mining research tends to focus on improving performance of relatively small models, rather than on scaling to larger models and training datasets. This is potentially shortsighted, as recent work elsewhere in NLP hints at the existence of scaling laws for the performance of neural models on NLP tasks [Kaplan et al., 2020, Hernandez et al., 2021], where the attainable test loss decreases predictably as model size and training data increase. If true, this suggests that efforts to improve the state-of-the-art in argument mining might best be directed towards scaling up the size of models and datasets used.

Such work will almost certainly require the creation of large, new datasets. But it also requires the development of model architectures that can best capitalise on increased scale as it becomes feasible. Desiderata for such architectures are listed below.

FLEXIBLE

Argument mining is variably defined [Wells, 2014]. The model should produce outputs sufficient for most conceptions of the task.

END-TO-END

All parameters in the model should be jointly trained, to avoid the compounding propagation of errors that occurs in pipeline approaches [Persing and Ng, 2016].

SEMI-SUPERVISED

As far as is possible, the model should benefit from transfer learning of unsupervised NLP tasks, which do not require costly annotated data.

CONTEXT-AWARE

The model should have access to relevant context.

EFFICIENT

Model training and inference should be as time and space efficient as possible.

Two of these desiderata merit further explanation.

By CONTEXT-AWARE, we mean that the model is not handicapped by limited access to the source document when performing argument mining sub-tasks. For example, in argument relation prediction, the task is to take two extracted phrases as input, and output the argumentative relation between them [Cocarascu et al., 2020]. Without further context, such as what text segued between the two phrases, this can be difficult even for human experts.

By FLEXIBLE, we mean that the model can produce outputs that constitute a solution to most variations on the task of argument mining. These include the positions of argument components within the source document, argument component classifications, and directed, typed relationships between argument components.

In this paper, we propose an additional output, argument embeddings¹, which are described in Section 2. Most current argument mining systems copy phrases verbatim (or almost verbatim) into the outputted argument maps. This is useful in contexts where it is important not to misrepresent the author. However, in practice this approach produces argument maps that are often inscrutable, due to the text fragments becoming ungrammatical when appearing *ex situ*, and there are many potential applications where argumentative ideas, rather than locutions, are the most relevant objects of analysis. Argument embeddings are a representation of such ideas.

To our knowledge, previous approaches to argument mining are not scalable, in that they do not satisfy the above desiderata. In Section 2 we introduce a new high-level architecture to serve as a blueprint for scalable argument mining systems, and in Sections 3 and 4 we discuss its implementation and evaluation.

¹Though more accurately described as argument *component* embeddings—being representations of propositions that serve as a premise, inference rule or conclusion—we use the phrase ‘argument embeddings’ for brevity.

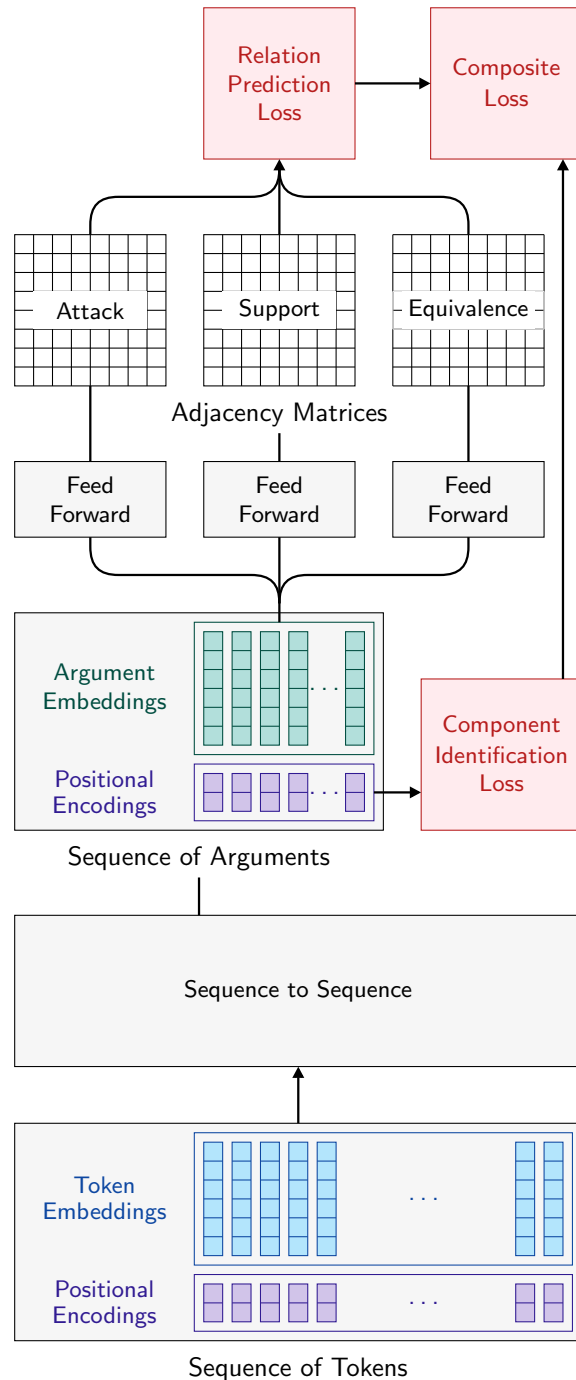

Figure 1: A schematic of the proposed architecture.

2 Method

A schematic of our proposed model architecture can be found in Figure 1. It consists of two modules, corresponding to the subtasks of argument component identification and argument relation prediction, which are jointly trained as a single neural network.

Argument component identification is framed as a sequence-to-sequence task, mapping a document (a sequence of tokens) to a sequence of arguments (or argument components) in the order they appear in the source document. Unlike previous work, which has treated this task as a sentence classification or IOB sequence tagging task [Ramshaw and Marcus, 1999], this approach is more abstractive, closer to a form of summarisation or translation. The outputted arguments have two elements, a positional encoding referring to their position in the source text, and an argument embedding—a type of sentence or paragraph embedding [Le and Mikolov, 2014] which is trained to encode information about their relations to other arguments (e.g. support, attack, equivalence). The goal of argument embeddings is to produce an object that captures the meaning of an argument, independent of the words used to express it (Figure 2).

To predict argument relations of each type, argument embeddings pass through a feed-forward network, and are then used to produce a probabilistic adjacency matrix by taking inner products between every pair and applying a sigmoid function. The model is trained using a composite loss metric produced by combining loss metrics for the two subtasks.

This architecture has potential to fulfil the desiderata listed in Section 1. It is end-to-end, and produces most expected output objects. An exception is argument component types, which could be extracted by adding a classifier on top of the argument embeddings. Both token and argument embeddings could benefit from unsupervised pre-training (in the latter case, using sentence embeddings). The argument embeddings are contextual, so the model can access relevant context when performing relation prediction. The largest inefficiency is likely the use of full adjacency matrices, which grow quadratically with the number of arguments, but there is scope to substitute a more efficient relation prediction module.

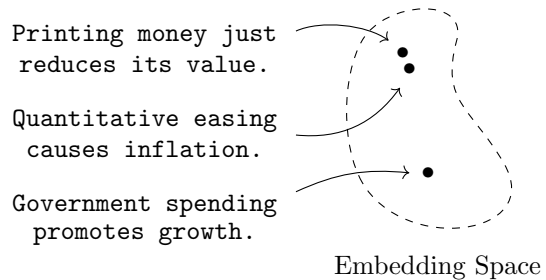

Figure 2: Visual intuition for argument embeddings. The first two claims have similar meanings, so will have similar relations with other argument components, and hence have similar embeddings.

3 Implementation

Implementation of the proposed architecture poses a number of practical challenges. Here we briefly² describe how three such challenges can be addressed, namely (i) how to extract positional information from the identified arguments, (ii) how to output adjacency matrices of arbitrary dimensionality, and (iii) how to define a loss metric for variable-size outputs.

Positional decoding

Argument mining, if understood as the task of converting a document into an argument map, does not require that the positions of the identified arguments within the source document be included in the model output. That said, most existing datasets rely on positional annotations for evaluation.

In our model, arguments are output as a sequence containing one element for each occurrence of an argument in the text. To compute a loss for the subtask of argument component identification, we require that the elements of the outputted sequence encode the position of the span of text to which they correspond.

In the context of transformer models, positional encoding has been used to augment inputted tokens with information about their position within the input sequence. [Vaswani et al., 2017] use positional

²Space constraints prevent a comprehensive technical discussion. Please contact the author for more details.

encoding based on trigonometric functions, which have a linearity property that makes it easy for the transformer to learn to attend by relative positions [Shiv and Quirk, 2019, Sec 2.1]. However, it is not straightforward to decode these representations back into integer positions.

To address this, we have developed a variant on their encoding that is easy to decode, whilst retaining the linearity property. This new encoding exploits a correspondence between trigonometric functions and cyclical patterns in the coefficients of binary expansions of integers.

The model will need to output two encodings for each argument—the start and end positions—which it could learn to copy from the input sequence.

Adjacency matrices

Efficiently considering all $2 \times \binom{n}{2}$ possible directed relationships among a set of n arguments is a recurring challenge in argument mining. Our model is structured such that an $n \times n$ adjacency-type matrix can be obtained from transformed argument embeddings via a single matrix multiplication.

More precisely, we assume the probability a given relationship exists can be computed by applying a sigmoid function to the inner product between transformed versions of the two relevant argument embeddings (which are contextual). If successful, this approach would allow relatively efficient generation of full adjacency-type matrices, whilst fulfilling the context-aware desideratum.

Loss for variable-size outputs

Another challenge is that the number of argument components identified by the model may not equal the number of argument components in the training data, which presents difficulties for computing the loss metric for both subtasks. A baseline solution is to truncate or pad the training data as appropriate in order to compute a loss. Further, we intend to explore loss metrics used for set prediction tasks, such as Chamfer loss [Zhang et al., 2019], which are designed to handle outputs of variable size.

4 Evaluation

Though this model is ultimately designed for training on large annotated corpora of real-world texts, in the short-term we intend to use synthetic corpora that describe arguments about simplified abstract worlds, similar to the “blocks world” used by the SHRDLU natural language understanding program [Winograd, 1971]. Semi-automated generation of such corpora is relatively quick, and the argumentative ideas represented can come close to exhausting those relevant to their domain.

Evaluation will focus on two areas: the feasibility of key design elements (such as the inclusion of positional encodings in the outputted argument sequence) and the broader usefulness of argument embeddings. Is it possible, for instance, to construct an embedding space in which...

- ...semantically similar argument units have similar embeddings, regardless of the locution used to express them?
- ...a plausible chain of reasoning between two propositions can be generated by tracing a geodesic between their embeddings?
- ...the direction of the difference vector between the embeddings of a premise and a conclusion indicates the argument scheme employed?

‘Arithmetic’ properties such as these could be used to improve the interpretability of argument mining systems. Further, as argument embeddings form a common representation of argumentative ideas, they might be decoded into self-contained locutions to produce grammatical, well-formed argument maps.

5 Conclusion

In this article, we described a high-level neural architecture for scalable argument mining, which is designed to learn argument embeddings: numerical representations of argument components that encode information about argument relations. Our next steps are to implement a model instance and evaluate its performance, the feasibility of key design elements, and the broader utility of argument embeddings.

Acknowledgements

This research was supported by the Hunt Lab for Intelligence Research at the University of Melbourne, and benefitted from conversations with Jacky Visser and Rory Duthie from the Centre for Argument Technology at the University of Dundee. Thank you also to the two anonymous reviewers for their constructive feedback.

References

- [Cocarascu et al., 2020] Cocarascu, O., Cabrio, E., Villata, S., and Toni, F. (2020). A dataset independent set of baselines for relation prediction in argument mining. *arXiv preprint arXiv:2003.04970*.
- [Hernandez et al., 2021] Hernandez, D., Kaplan, J., Henighan, T., and McCandlish, S. (2021). Scaling laws for transfer. *arXiv preprint arXiv:2102.01293*.
- [Kaplan et al., 2020] Kaplan, J., McCandlish, S., Henighan, T., Brown, T. B., Chess, B., Child, R., Gray, S., Radford, A., Wu, J., and Amodei, D. (2020). Scaling laws for neural language models. *arXiv preprint arXiv:2001.08361*.
- [Lawrence and Reed, 2020] Lawrence, J. and Reed, C. (2020). Argument mining: A survey. *Computational Linguistics*, 45(4):765–818.
- [Le and Mikolov, 2014] Le, Q. and Mikolov, T. (2014). Distributed representations of sentences and documents. In *International conference on machine learning*, pages 1188–1196. PMLR.
- [Persing and Ng, 2016] Persing, I. and Ng, V. (2016). End-to-end argumentation mining in student essays. In *Proceedings of the 2016 Conference of the North American Chapter of the Association for Computational Linguistics: Human Language Technologies*, pages 1384–1394.
- [Ramshaw and Marcus, 1999] Ramshaw, L. A. and Marcus, M. P. (1999). Text chunking using transformation-based learning. In *Natural language processing using very large corpora*, pages 157–176. Springer.
- [Shiv and Quirk, 2019] Shiv, V. L. and Quirk, C. (2019). Novel positional encodings to enable tree-based transformers. In *NeurIPS*, pages 12058–12068.
- [van Gelder et al., 2019] van Gelder, T., de Rozario, R., and Saletta, M. (2019). Crowdsourcing citizen intelligence. In *Proceedings of the Technology Surprise Forum, Safeguarding Australia 2019*. National Security College, The Australian National University, & Defence Science and Technology (DST) Group, Australian Department of Defence. (Eds.).
- [Vaswani et al., 2017] Vaswani, A., Shazeer, N., Parmar, N., Uszkoreit, J., Jones, L., Gomez, A. N., Kaiser, L., and Polosukhin, I. (2017). Attention is all you need. *arXiv preprint arXiv:1706.03762*.
- [Wells, 2014] Wells, S. (2014). Argument mining: Was ist das? *CMNA14*.
- [Winograd, 1971] Winograd, T. (1971). Procedures as a representation for data in a computer program for understanding natural language. Technical report, Massachusetts Institute of Technology.
- [Zhang et al., 2019] Zhang, Y., Hare, J., and Prügell-Bennett, A. (2019). Deep set prediction networks. *arXiv preprint arXiv:1906.06565*.

A dialogue framework for enthymemes

Andreas Xydis

Department of Informatics, King's College London, UK

Abstract

In the first volume of OHAAI I presented my motivation and objectives for my PhD work on enthymemes and, specifically, I discussed how some locutions can help in handling enthymemes during argumentation-based dialogues (referred to as *dialogues* from now on), expressing and enriching systems which capture limited scenarios on how a dialogue can unfold. In this paper I go one step further by examining how an argument framework with the enthymemes moved in a dialogue (referred to as *dialogue framework* from now on) can be instantiated and I explain why a dialogue framework is important for achieving my PhD goal.

fewer papers concentrate on dialogue systems which accommodate enthymemes, e.g. [Black and Hunter, 2007], [Dupin de Saint-Cyr, 2011], [Hosseini et al., 2017] and [Prakken, 2005]. The first, third and fourth one deal with the backward expansion of enthymemes, i.e. how to question a premise ϕ of an enthymeme and provide a justification for ϕ during the dialogue. The second one extends these works by dealing also with the forward expansion of enthymemes, i.e. how to challenge the conclusion of an enthymeme E' (which means that an agent receiving E' believes that E' 's conclusion is not the claim of the intended argument Y that the sender of E' implies based on E') and provide the missing information between the top nodes of E' and the claim of Y (the claim of Y might be included in this missing information).

1 Introduction

As analysed in [Xydis, 2020], enthymemes (i.e. arguments with an incomplete logical structure) are more representative of real life dialogues. So if we are to provide normative support for human-human debate and enable AIs and humans to jointly reason, we need to investigate how to process enthymemes during dialogues.

When agents communicate using enthymemes, misunderstandings can occur due to enthymemes' lack of structure. This is why there are some works on enthymemes that explore how agents can formalise these incomplete arguments based on some shared knowledge, and whether it is possible for an agent to decode an enthymeme incorrectly, i.e. to construct a complete argument X based on an enthymeme E that the agent received, but without X being the intended complete argument that the sender of E meant. Examples of such works are [Black and Hunter, 2012, Hosseini et al., 2014, Hunter, 2007, Panisson and Bordini, 2017]. However,

In our paper [Xydis et al., 2020], we introduce a dialogue system with novel locutions, witnessed in real-life dialogues, which extends [Black and Hunter, 2007], [Dupin de Saint-Cyr, 2011], [Hosseini et al., 2017] and [Prakken, 2005]. Particularly, we address the backward and forward expansions of enthymemes employed during dialogues as well as the misunderstandings that may occur due to the use of enthymemes in dialogues. Table 1 shows the locutions used in our system and their meaning.

After discussing the first part of my research in [Xydis, 2020] (i.e. the locutions needed to develop a dialogue system which handles enthymemes), in this paper I continue by demonstrating how a dialogue framework can be instantiated based on the elements of a move made during a dialogue so that I can, later on, argue regarding the acceptability of enthymemes under the classic semantics presented in [Dung, 1995]. The overall goal of my PhD is to prove that there are circumstances under which the status of enthymemes in the dialogue framework at any stage

Locution	Meaning
assert	Assert an enthymeme.
why	Question a particular element of a previous enthymeme, which is a request for the other participant to provide a backward expansion on that element.
because	Provide a backward expansion on a questioned element.
and-so	Request a forward expansion of a previous enthymeme.
hence ^x	Provide a forward expansion of a previous enthymeme.
w.d.y.t.i.m.b.	Check the other participant's understanding of an enthymeme by asking "what did you think I meant by ...".
assumed ^y	Provide their own interpretation of an enthymeme.
meant ^y	Correct the other participant's interpretation of an enthymeme.
agree ^y	Confirm the other participant's interpretation of an enthymeme.

Table 1: Table of locutions, with variants for $x \in \{eq, fw\}$ and $y \in \{eq, fw, bw\}$, where *eq* stands for equal, *fw* stands for forward expansion and *bw* stands for backward expansion.

in a dialogue will correspond with the status of these enthymemes in the Dung argument framework instantiated by the contents of all the moves made at that stage in the dialogue.

2 Method

In my research, arguments are formalised within the *ASPIC*⁺ framework [Modgil and Prakken, 2013] since it allows for the evaluation of arguments using Dung's theory [Dung, 1995], for accessing the internal structure of arguments and for accommodating other existing argumentation formalisms, e.g. deductive argumentation [Bondarenko et al., 1997] and ABA [Besnard and Hunter, 2008]. Additionally, the *ASPIC*⁺ framework allows one to define their own way of constructing arguments into a given logic, and so it en-

ables the use of argument-trees [Hosseini et al., 2014] which preserve the principles of *ASPIC*⁺ and based on which the structure of enthymemes is defined (see [Xydis et al., 2020] for details on how we structure enthymemes).

To develop a dialogue framework, which is used as a tool to decide the acceptability of enthymemes under the complete, preferred, grounded and stable semantics, I explored how a bipolar argument framework is constructed [Cayrol and Lagasque-Schiex, 2005]. The reason was to capture the supporting relationship that two enthymemes can have in the same way as arguments do in a bipolar argument framework. In other words, the backward expansion E' of an enthymeme E and the forward expansion E'' of E in a dialogue are perceived as E' supporting E and E supporting E'' , respectively.

Capturing attacking as well as supporting relationships between enthymemes in my framework will, ultimately, help me in defining acceptability of enthymemes during a dialogue, something that I need if I am to achieve my main PhD goal.

3 Discussion

In this section, I define a dialogue framework that accommodates enthymemes and show how one can construct this dialogue framework based on the elements of a move made during a dialogue.

3.1 Elements of the dialogue framework

In [Xydis et al., 2020], we define a move made in a dialogue d (conducted between two agents P and O) as $m = (s, l, c, re, t)$, where s is the *sender* of m , l is the *locution* of m , c is the *content* of m , re is the move to which m replies and t is the move that m targets. The *sender* of m can be either P or O and the *locution* of m can be one of the locutions depicted in Table 1. The *content* of m can be either an enthymeme or a pair (E, ϕ) , where E is an enthymeme and ϕ is a premise of E , or the emptyset (\emptyset). Lastly, the *reply* of m is either a move made previously in d or \emptyset , as is the *target* of m .

When an agent makes a move m , whose content is an enthymeme and whose locution is not w.d.y.t.i.m.b. or assumed, that targets another move n' it means that the

content of m' is moved as a defeat against the content of n' . So we need a set A which keeps track of the enthymemes moved during a dialogue and a set T that keeps track of the defeat relations between the enthymemes moved during a dialogue.

However, since enthymemes do not have a complete structure, the participants might be mistaken regarding defeats. For example, a participant of a dialogue might move an argument X against a previously moved enthymeme E because she assumes that E was obtained by removing parts of an argument Y which X defeats¹. However, E is expanded by an argument Z which is not defeated by X . Therefore, we allow to the participants of the dialogue to question premises of enthymemes as well as defeat relations between enthymemes. We do so by adding two sets Q_P and Q_T , respectively.

Finally, since a participant of a dialogue can question premises of enthymemes and defeat relations between enthymemes, we expect from her counterpart to answer these questions by providing backward expansions of enthymemes on their challenged premises and forward expansions of enthymemes that have been moved as defeats against other enthymemes, but their defeat relationship is questioned. So, we add a set S that keeps track of enthymemes for which a backward or forward expansion has been provided in the course of the dialogue. Essentially, S represents a binary support relation between enthymemes.

Following the above, we define a dialogue framework DF as a tuple which includes the sets A, T, S, Q_P, Q_T described earlier. Formally $DF = \langle A, T, S, Q_P, Q_T \rangle$.

3.2 Constructing the dialogue framework

Every time an agent moves an enthymeme E during a dialogue, E is added to the dialogue framework, i.e. to the set A . When a move $m = (s, l, c, re, t)$ targets another move $m' = (s', l', c', re', t')$, where c and c' are enthymemes, the defeat relationship between c and c' is added to the dialogue framework, i.e. to the set T (this does not happen when l is either w.d.y.t.i.m.b. or assumed).

If an agent P makes a why move, whose content is (E, ϕ) , then ϕ is added to the dialogue framework as a

¹Note that in *ASPIC*⁺ an attack from argument X to argument Y may succeed as a defeat, contingent on preferences defined over the argument X and the targeted sub-argument of Y , if X 's claim conflicts with an ordinary premise or the consequent or name of a defeasible rule in Y .

questioned premise of E , i.e. (E, ϕ) is added to Q_P . To remove (E, ϕ) from Q_P , the counterpart of P must reply with a because move, i.e. provide a backward expansion E' of E on ϕ . When this happens, a support relation between E' and E is added to the dialogue framework, i.e. the pair (E', E) is added to the set S .

An agent P can question the defeat relation (E, E'') in the dialogue framework, i.e. add (E, E'') to Q_T , if she makes an and-so or a w.d.y.t.i.m.b. move. To remove (E, E'') from Q_T , the counterpart of P needs to reply to an and-so move with a hence^{eq}, i.e. repeat E to show that the claim of her intended argument is part of E and there is no forward expansion of E that she needs to reveal. The pair (E, E'') can also be removed from Q_T if P replies to her counterpart's w.d.y.t.i.m.b. move with an assumed^{eq} and her counterpart replies with an agree^{eq} move, i.e. P was correct to assume that there is no backward or forward expansion of E'' that her counterpart implied and so the defeat relation (E, E'') should still stand.

If P replies to the and-so move with a hence^{fw} move whose content is E' , then a support relation between E and E' is added to the dialogue framework, i.e. (E, E') is added to S , since E' is a forward expansion of E . A defeat relation between E' and E'' is also added to the dialogue framework, i.e. (E', E'') is added to T . This is because as a forward expansion of E , E' may contain the claim of P 's intended argument.

Suppose that during a dialogue d an agent P asserts an enthymeme W , her counterpart O moves Z as a defeat against W , P moves U against Z and then O makes an and-so move to question the defeat relationship between U and Z . Then, P repeats U by making a hence^{eq} move and O answers with a w.d.y.t.i.m.b. move. P replies to the w.d.y.t.i.m.b. move with an assumed move, thus revealing what she understood based on Z . The content of the assumed move (call it Y) is added to the dialogue framework, but with no relationships to other enthymemes since O needs to either correct P or confirm that Y was correctly assumed based on Z . Note that Y can be either a backward expansion of Z on one of Z 's premises or a forward expansion of Z or Z itself (meaning that P understood nothing more than what O revealed with Z). The dialogue framework at this stage is depicted in Figure 1.i.

If O replies with a meant move, it means that P 's assumption based on Z was mistaken and so O moves what she really meant based on Z (call this an enthymeme X).

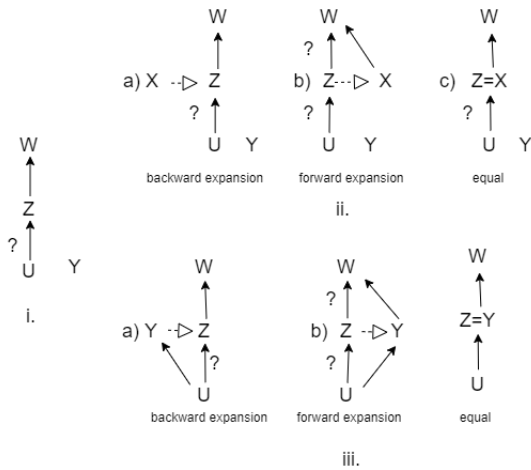

Figure 1: i. The dialogue framework after an assumed move with content Y . ii. The effect of a meant move on the dialogue framework when the content of meant is: a) a backward expansion Z , b) a forward expansion of Z , c) equal to Z iii. The effect of an agree move on the dialogue framework when the content of agree is: a) a backward expansion Z , b) a forward expansion of Z . Note that straight arrows depict defeats between two enthymemes, whereas the broken arrows depict support relations between enthymemes.

In case O corrects P 's assumption by revealing a backward expansion of Z , the effect on the dialogue framework is the same as the effect of a because move on the dialogue framework (see Figure 1.ii.a). In case O corrects P 's assumption by revealing a forward expansion of Z , the effect on the dialogue framework is the same as the effect of a hence^{fw} move on the dialogue framework (see Figure 1.ii.b). Lastly, if $X = Z$ nothing changes in the dialogue framework (see Figure 1.ii.c). On the other hand, if O replies with an agree move, it means that P 's assumption based on Z was correct and this is why Y (which was the content of the assumed move that P made) gets connected with the rest of the framework. If Y is a backward expansion of Z , the effect on the dialogue framework is the same as the effect of a because move on the dialogue framework (see Figure 1.iii.a). If Y is a forward expansion of Z , the effect on the dialogue framework is the same as the effect of a hence^{fw} move on the dialogue framework

(see Figure 1.iii.b). In both cases a new defeat relation between U and X is added to the dialogue framework, since X contains the element which conflicts with U and so it justifies why U was moved against Z (the case where $Y = Z$, i.e. the locution of the move is agree^{eq}, is described earlier in this section and you can see this case in Figure 1.iii.c).

4 Conclusion

In this paper it was explained how to instantiate a dialogue framework with enthymemes, based on the locutions of moves made during a dialogue. This work is the continuation of my previous paper [Xydis, 2020] where I describe the locutions shown in Table 1. For details on the protocol of the dialogue and how the characteristics of a move change based on each locution see [Xydis et al., 2020]. To the best of my knowledge there is no other work that focuses on the development of a dialogue framework generated from a dialogue system which handles the backward and forward expansion of enthymemes and how to resolve the misunderstandings that they cause (a notable exception is [Prakken, 2005], but this work only addresses backward expansion of enthymemes). The work presented here is a vital part of my research, since it constitutes the basic tool I need to decide regarding the acceptability of enthymemes during a dialogue. The next step of my research is to find out exactly under which circumstances the status of enthymemes in the dialogue framework at any stage in a dialogue will correspond with the status of these enthymemes in the Dung argument framework instantiated by the contents of all the moves made at that stage in the dialogue. So far, I know that I need to restrict the participants into being *honest*, making *relevant* moves, not making *unnecessary* moves and play 'logically perfectly' (see [Prakken, 2005]). The final step of my PhD is to prove my conjecture.

Acknowledgements

The research described in this paper would not be possible without the help of E. Black, C. Hampson and S. Modgil.

References

- [Besnard and Hunter, 2008] Besnard, P. and Hunter, A. (2008). *Elements of argumentation*, volume 47. MIT press Cambridge.
- [Black and Hunter, 2007] Black, E. and Hunter, A. (2007). A generative inquiry dialogue system. In *Proceedings of the 6th International Joint Conference on Autonomous Agents and Multiagent systems*, pages 1–8.
- [Black and Hunter, 2012] Black, E. and Hunter, A. (2012). A relevance-theoretic framework for constructing and deconstructing enthymemes. *Journal of Logic and Computation*, 22(1):55–78.
- [Bondarenko et al., 1997] Bondarenko, A., Dung, P. M., Kowalski, R. A., and Toni, F. (1997). An abstract, argumentation-theoretic approach to default reasoning. *Artificial intelligence*, 93(1-2):63–101.
- [Cayrol and Lagasquie-Schiex, 2005] Cayrol, C. and Lagasquie-Schiex, M. (2005). On the acceptability of arguments in bipolar argumentation frameworks. In *European Conference on Symbolic and Quantitative Approaches to Reasoning and Uncertainty*, pages 378–389.
- [Dung, 1995] Dung, P. M. (1995). On the acceptability of arguments and its fundamental role in nonmonotonic reasoning, logic programming and n-person games. *Artificial intelligence*, 77(2):321–357.
- [Dupin de Saint-Cyr, 2011] Dupin de Saint-Cyr, F. (2011). Handling enthymemes in time-limited persuasion dialogs. *Proceeding of International Conference on Scalable Uncertainty Management*, pages 149–162.
- [Hosseini et al., 2014] Hosseini, S. A., Modgil, S., and Rodrigues, O. (2014). Enthymeme construction in dialogues using shared knowledge. In *Proceedings of Computational Models of Argument*, pages 325–332.
- [Hosseini et al., 2017] Hosseini, S. A., Modgil, S., and Rodrigues, O. (2017). Dialogues incorporating enthymemes and modelling of other agents’ beliefs.
- [Hunter, 2007] Hunter, A. (2007). Real arguments are approximate arguments. In *AAAI*, volume 7, pages 66–71.
- [Modgil and Prakken, 2013] Modgil, S. and Prakken, H. (2013). A general account of argumentation with preferences. *Artificial Intelligence*, 195:361–397.
- [Panisson and Bordini, 2017] Panisson, A. R. and Bordini, R. H. (2017). Uttering only what is needed: Enthymemes in multi-agent systems. pages 1670–1672.
- [Prakken, 2005] Prakken, H. (2005). Coherence and flexibility in dialogue games for argumentation. *Journal of logic and computation*, 15(6):1009–1040.
- [Xydis, 2020] Xydis, A. (2020). Speech acts and enthymemes in argumentation-based dialogues. *Online Handbook of Argumentation for AI (OHA AI)*, 1:53–57.
- [Xydis et al., 2020] Xydis, A., Hampson, C., Modgil, S., and Black, E. (2020). Enthymemes in dialogues. *Computational Models of Argument: Proceedings of COMMA 2020*, 326:395–402.

On some formal relations between arguing and believing

Antonio Yuste-Ginel

Department of Philosophy. University of Málaga

Abstract

Arguing and believing are two central dimensions of human cognition that are taken into account when designing autonomous intelligent agents. Both dimensions are connected in several ways. In this paper, I summarize the central features of my PhD project, which consists in the formal study of some of these connections. Methodologically, the project combines tools imported from formal argumentation and (dynamic) epistemic logic.

1 Introduction

Humans hold beliefs in order to interact successfully with their environment, to coordinate their actions, and to be able to communicate. Moreover, humans use arguments to influence others' actions and beliefs, to reach reasonable agreements, and to jointly find the best solution for a given problem. Consequently, it is not surprising that many attempts to model artificial intelligent agents have taken into account argumentation and/or beliefs.

Both aspects of cognition are connected in the daily life of human beings. These connections happen in, at least, two different ways. First,

C1 belief formation, i.e., the process through which an individual comes to believe a certain proposition, takes as an input the set of arguments that she entertains and how strong she considers them to be.

As an example of C1, consider an individual that is forming her belief about this evening's weather. She

asks a colleague, who says "the sky looks cloudless". She also checks the weather forecast, that predicts 95% of rain. After assessing pros and cons, she comes to believe that it will rain. Second,

C2 argument evaluation (the process of determining the strength of an argument) is conditioned by the beliefs previously held by the agent.

As an example of C2, consider a suspect of a crime that is deciding to use either of two alibis in a trial. Suppose that the suspect believes that the court has good evidence to undermine his first alibi but not the second one. Then, it seems more likely that the suspect will disclose the second alibi during the trial (from now on, we shall refer to this example as the *alibis' example*).

Although both connections have been identified and studied from several perspectives, it seems fair to say that the problem is relatively unexplored in its formal aspects. The main objective of my PhD project is to investigate these relations through formal methods.

2 Method

The problem introduced above calls for a hybrid methodological approach, more specifically, a combination of a method for representing beliefs with one for representing argumentation.

Among the heterogeneous options for representing belief formally [Genin and Huber, 2021], epistemic logic with possible states semantics provides a qualitative model for arbitrarily nested beliefs in a multi-agent context (see e.g., [Fagin et al., 2004]).

The main semantic constructs here are **multi-agent epistemic models**, i.e., triples of the form $\mathcal{K} = (\mathcal{S}, \{\succsim_i \mid i \in \text{Ag}\}, \mathcal{V})$; where \mathcal{S} is a non-empty set of possible states; Ag is a finite, non-empty set of agents; each $\succsim_i \subseteq \mathcal{S} \times \mathcal{S}$ is an epistemic accessibility relation;¹ and $\mathcal{V} : \text{At} \rightarrow \wp(\mathcal{S})$, where At is a countable set of atomic propositions. Intuitively, $\mathcal{V}(p)$ denotes the set of states where p is true. These structures are described using a modal language \mathcal{L}_\square that extends the language of propositional logic with one modal operator \square_i for each agent $i \in \text{Ag}$, whose informal reading is “agent i believes that ...”. The new formulas are interpreted in pointed models (pairs of the form (model, state)) as follows: $\mathcal{K}, s \models \square_i \varphi$ iff $s \succsim_i s'$ implies $\mathcal{K}, s' \models \varphi$. In words, a sentence is believed at s iff it holds at every accessible state, providing the mentioned qualitative picture of (high-order) beliefs.

Epistemic logic has been extended to model dynamic phenomena (e.g., learning, communicating, or observing) within the research field known as *dynamic epistemic logic* (DEL) [van Ditmarsch et al., 2007]. Roughly sketched, DEL studies different kinds of operations on epistemic models and how these can be described through dynamic operators.

Regarding argumentation, there are many formalisms for representing arguments as well as interactions among them [Baroni et al., 2018, Part B]. The main tool used in this project are Dung’s argumentation frameworks (AFs) [Dung, 1995], i.e., directed graphs $(\mathcal{A}, \mathcal{R})$ where nodes are interpreted as arguments and edges as some kind of conflict relation among arguments (typically, an attack relation). In order to compute the set(s) of acceptable arguments, argumentation semantics are then applied over AFs. In all semantics studied in [Dung, 1995], a set of arguments is minimally required to be admissible, informally meaning that (i) it lacks internal conflicts and (ii) it attacks all its attackers. As an example, Figure 1 depicts an AF capturing the relevant arguments and conflicts of the alibis’ example. Node a stands for an argument claiming the suspect’s guilt,

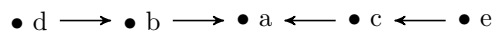

Figure 1: An AF.

b and c represent her two possible alibis, and d and e represent the (potential) counterarguments of the court. Note that, if all information was on the table, the suspect should be blamed guilty (a is acceptable under all standard semantics).

This brief analysis shows that abstract argumentation (i.e., leaving unspecified the nature and structure of arguments) provides the argumentative basis for analysing some readings of C2. Nevertheless, C1 seems to require some kind of arguments’ structure or, at least, some mechanism to meaningfully assign conclusions to arguments, since the objects of beliefs are typically considered to be sentences (and not arguments). Again, there is an important amount of options available in the literature. In this project we have used ASPIC⁺ [Modgil and Prakken, 2013], since it has been shown to be a comprehensive and flexible approach to structured argumentation.

Finally, we use the notion of awareness as a conceptual and technical bridge among both families of formalisms (argumentation and epistemic logic). An **awareness-epistemic model** adds an awareness function $\text{Aw} : (\mathcal{S} \times \text{Ag}) \rightarrow \wp(\mathcal{L}_\square)$ to the epistemic models defined above (see e.g., [Fagin et al., 2004, Chapter 9]). This kind of models were introduced as a means of avoiding the unwanted phenomenon of logical omniscience. We revisit them and vary the range of Aw , substituting $\wp(\mathcal{L}_\square)$ with $\wp(\mathcal{X})$ where \mathcal{X} is some kind of argumentative construct, e.g., (but not necessarily) a set of arguments. In the next section, we sketch how two instantiations of this idea have been used to deal with the problem presented in the introduction.

3 Results

Epistemic reasoning about AFs

It is not casual that in the alibis’ example we have an agent (the suspect) trying to convince another one (the court), as the first reading of C2 we focus on is:

¹Intuitively, $s \succsim_i s'$ means that i , situated at s , considers s' as a candidate for the actual world.

$C2'$ *rhetoric* argument evaluation (the process of determining the *persuasive power* of an argument within a discussion) is conditioned by the beliefs previously held by the agent.

In [Proietti and Yuste-Ginel, 2020], we gave a formal account of $C2'$ by extending one of the logics proposed in [Schwarzentruber et al., 2012] with argument communication operators. The idea of [Schwarzentruber et al., 2012] was to embed AFs into epistemic models, in a way such that each state of an epistemic model becomes an AF. There is a preliminary question though: what is the appropriate way to bring a finite set of agents Ag into the picture of abstract argumentation? This question arises because persuasion typically takes place in multi-agent scenarios. There are different possibilities to answer this question. The option of [Schwarzentruber et al., 2012] (shared by many other proposals), that we followed in our work, is to define multi-agent AFs as tuples $(A, R, \{A_i\}_{i \in \text{Ag}})$, where (A, R) is an AF, and where each $A_i \subseteq A$ represents the set of arguments that agent i is aware of. In this version of multi-agent AFs, awareness of conflicts is informally assumed to be sound and complete modulo awareness of arguments. Formally, this means that given $(A, R, \{A_i\}_{i \in \text{Ag}})$ the set of conflicts agent i is aware of is defined as $R_i := R \cap (A_i \times A_i)$. So, given a signature of arguments' names A together with a conflict relation R , an **epistemic model for abstract argumentation** can be seen as a tuple $(S, \{\rightarrow_i\}_{i \in \text{Ag}}, V, \text{Aw})$ where $\text{Aw} : (\text{Ag} \times S) \rightarrow \wp(A)$. If we assume that our set of propositional variables At comes equipped with awareness variables $\text{aw}_i(x)$ for each $i \in \text{Ag}$ and each $x \in A$, then epistemic models for abstract argumentation can be simply understood as epistemic models for a distinguished set of variables (because Aw is contained in V). As an illustration, Figure 2 depicts an epistemic model for the alibis' example, where ellipses represent the arguments that each agent is aware of at each state. Note that the suspect, agent 1, wrongly believes that s_1 is the actual state. Moreover, she thinks that the court (agent 2) can only counter-argue her alibi c with e , while it is actually the case that the court can counter-argue her alibi b with d (s_0).

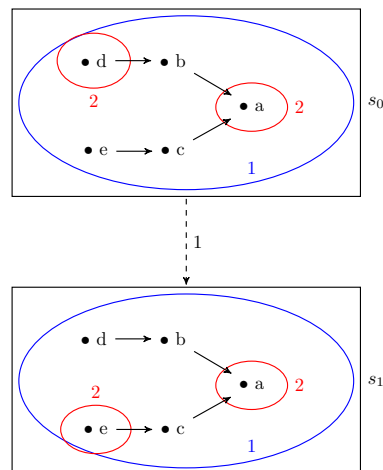

Figure 2: An epistemic model for the alibis' example.

What is still missing for a minimal formalization of $C2'$ is a notion of argument communication. In [Proietti and Yuste-Ginel, 2020], we proposed to treat it as a simple DEL action altering awareness sets. More precisely, the action $+_i x$ (informally meaning that i communicates x), if applied to an epistemic model \mathcal{K} , returns $\mathcal{K}^{+_i x}$ where x has been added to the awareness of every agent at every state (whenever i was actually aware of x before the action). We axiomatised such an action, providing axioms that describe its effects on epistemic models. In the resulting framework, we are able to distinguish actions that are actually persuasive from those that are merely thought to be persuasive by a given agent. We moreover provided some conditions under which the beliefs of an agent are safe, i.e., they are good enough to guarantee its communicative success, hence digging deeper in $C2'$.

In ongoing work, we have extended the setting of our first paper in several directions. First, designing a propositional language that is able to capture argumentation semantics and the notion of fine-grained justification status, something that was missing both in [Schwarzentruber et al., 2012] and our previous work. Second, systematically studying completeness theory w.r.t. restricted classes of models. Third, extending the dynamic apparatus with so-

called action models (see [van Ditmarsch et al., 2007, Chapter 6]) in order to capture much more subtle forms of argument communication. Fourth, showing that the resulting logic is expressive enough to subsume existing formalisms for qualitative uncertainty about AFs and argumentation dynamics, such as incomplete AFs [Baumeister et al., 2018] and control AFs [Dimopoulos et al., 2018].

Justified belief and argument strength

In the second main track of this PhD project, we turn our attention to C1: belief formation is conditioned by argument evaluation. Arguably, this thesis is one of the core intuitions underlying research in formal argumentation (including the seminal work [Dung, 1995]). Moreover, recent efforts made in the epistemic logic literature in order to include the heretofore missing justification component can be understood as broadly motivated by C1. These efforts have been accomplished through very heterogeneous methods, for instance, justification logic [Artemov and Fitting, 2016] or neighbourhood semantics [van Benthem et al., 2012]. There are works explicitly integrating some kind of argumentative mechanism within epistemic models, such as [Shi et al., 2017], which combines topological and argumentation semantics, or [Wáng and Li, 2021], which argues for a semantic notion of argument but abstracts away from the conflict relation.

Our main contribution here consists in two ideas. First, we point out that there is a specific interpretation of C2 that might be relevant for C1, namely,

C2'' when determining the relative strength of a set of arguments, arguments with believed premises should be considered stronger to arguments whose premises are not believed.

We developed this idea from a justification logic perspective in [Burrieza and Yuste-Ginel, 2019]. Interestingly, there exists a conceptual tension between C2'' and the notion of justified belief advocated in C1. In [Burrieza and Yuste-Ginel, 2020], we identified that tension and proposed a formal solution for it, philosophically inspired by foundationalist theories of

epistemic justification. This has been done by accommodating structured argumentation tools taken from ASPIC⁺ [Modgil and Prakken, 2013] within awareness-epistemic models. More concretely, we used awareness-epistemic models where the awareness function Aw assigns a set of ASPIC⁺ argument to the formalized agent (the set of arguments the agent is aware of). After that, a preference relation between arguments can be computed using the beliefs of the agent towards the premises of the argument she is aware of, giving a formal treatment of C2''. Departing from these preferences together with the usual attack relation among ASPIC⁺ arguments, we can obtain an argumentation framework from which a second kind of beliefs (argument-based beliefs) can be defined via standard argumentation semantics. This clearly accounts for a qualified reading of C1.

The resulting logic has a minimal character though, since argument-based beliefs satisfy two of the four rationality postulates established in [Caminada and Amgoud, 2007]. Therefore, an immediate line of work is studying whether any restrictions on the awareness set of the formalized agent may make him more rational, i.e., by satisfying more postulates.

4 Conclusion

The PhD project that this paper summarizes studies some of the formal connections between arguing and believing. The chosen method consists in combining argumentation and epistemic logic tools. This has crystallized in two main tracks of research, the first one is the study of epistemic models for abstract argumentation as well as their dynamics. The second one is constructing a (syntactically-oriented) alternative to the notion of justified belief within the recent epistemic logic literature.

Acknowledgements

I am really thankful to my PhD advisor, Alfredo Burrieza, as well as to my supervisors during my two research visits: Fernando R. Velázquez Quesada

(ILLC) and Andreas Herzig (IRIT), and to Carlo Proietti (ILC), with whom I have had the pleasure to work. I would also like to thank Alfredo and Carlo for commenting previous versions of this text. My research activity is supported by the predoctoral grant MECD-FPU 2016/04113.

References

- [Artemov and Fitting, 2016] Artemov, S. and Fitting, M. (2016). Justification logic. In Zalta, E. N., editor, *The Stanford Encyclopedia of Philosophy*. Metaphysics Research Lab, Stanford University.
- [Baroni et al., 2018] Baroni, P., Gabbay, D. M., Giacomini, M., and van der Torre, L. (2018). *Handbook of formal argumentation*. College Publications.
- [Baumeister et al., 2018] Baumeister, D., Neugebauer, D., Rothe, J., and Schadrack, H. (2018). Verification in incomplete argumentation frameworks. *Artificial Intelligence*, 264:1–26.
- [Burrieza and Yuste-Ginel, 2019] Burrieza, A. and Yuste-Ginel, A. (2019). Argument evaluation in multi-agent justification logics. *Logic Journal of the IGPL*. DOI:10.1093/jigpal/jzz046.
- [Burrieza and Yuste-Ginel, 2020] Burrieza, A. and Yuste-Ginel, A. (2020). Basic beliefs and argument-based beliefs in awareness epistemic logic with structured arguments. In *Proceedings of the COMMA 2020*, pages 123–134. IOS Press.
- [Caminada and Amgoud, 2007] Caminada, M. and Amgoud, L. (2007). On the evaluation of argumentation formalisms. *Artificial Intelligence*, 171(5–6):286–310.
- [Dimopoulos et al., 2018] Dimopoulos, Y., Maily, J.-G., and Moraitis, P. (2018). Control argumentation frameworks. In *Thirty-Second AAAI Conference on Artificial Intelligence*. AAAI Press.
- [Dung, 1995] Dung, P. M. (1995). On the acceptability of arguments and its fundamental role in nonmonotonic reasoning, logic programming and n-person games. *Artificial Intelligence*, 77(2):321–357.
- [Fagin et al., 2004] Fagin, R., Halpern, J. Y., Moses, Y., and Vardi, M. (2004). *Reasoning about knowledge*. MIT press.
- [Genin and Huber, 2021] Genin, K. and Huber, F. (2021). Formal Representations of Belief. In Zalta, E. N., editor, *The Stanford Encyclopedia of Philosophy*. Metaphysics Research Lab, Stanford University.
- [Modgil and Prakken, 2013] Modgil, S. and Prakken, H. (2013). A general account of argumentation with preferences. *Artificial Intelligence*, 195:361–397.
- [Proietti and Yuste-Ginel, 2020] Proietti, C. and Yuste-Ginel, A. (2020). Persuasive argumentation and epistemic attitudes. In Soares Barbosa, L. and Baltag, A., editors, *Dynamic Logic. New Trends and Applications*, volume 12005 of *LNCS*, pages 104–123. Springer.
- [Schwarzentruber et al., 2012] Schwarzentruber, F., Vesic, S., and Rienstra, T. (2012). Building an epistemic logic for argumentation. In Fariñas del Cerro, L., Herzig, A., and Mengin, J., editors, *Logics in Artificial Intelligence*, volume 7519 of *LNCS*, pages 359–371. Springer.
- [Shi et al., 2017] Shi, C., Smets, S., and Velázquez-Quesada, F. (2017). Argument-based belief in topological structures. In Lang, J., editor, *Proceedings TARK 2017. EPTCS*. Open Publishing Association.
- [van Benthem et al., 2012] van Benthem, J., Fernández-Duque, D., Pacuit, E., et al. (2012). Evidence logic: A new look at neighborhood structures. *Advances in modal logic*, 9:97–118.
- [van Ditmarsch et al., 2007] van Ditmarsch, H., van der Hoek, W., and Kooi, B. (2007). *Dynamic epistemic logic*. Springer.
- [Wáng and Li, 2021] Wáng, Y. N. and Li, X. (2021). A logic of knowledge based on abstract arguments. *Journal of Logic and Computation*. DOI:exab002.

Modeling Case-Based Reasoning with the Precedent Model Formalism: An Overview

Heng Zheng

Department of Artificial Intelligence, Bernoulli Institute,
University of Groningen, The Netherlands

Abstract

Research in artificial intelligence (AI) and law (e.g., case-based reasoning) is often associated with computational argumentation theory. This paper, as a preliminary work of my PhD research, summarizes an approach for modeling case-based reasoning with the precedent model formalism. By the proposed approach, we show that the validity of arguments in case-based reasoning can be described in a formal logical language. We also discuss the potential for analyzing other issues in AI and law with the formalism we present, such as the argument moves in case-based reasoning and the dynamics of case-based reasoning.

with a case study about Dutch tort law. One of the distinctive attributes of Verheij’s approach is the use of a formal logical language for the modeling of legal reasoning. In this paper, we extend the approach developed by Verheij with a more specific focus on precedents in case-based reasoning.

The approach we introduce in this paper, i.e., the precedent model formalism, based on Verheij’s approach, can be used for discussing the validity of arguments [Zheng et al., 2020a] and the comparison of precedents [Zheng et al., 2020b] in case-based reasoning with factors by following typical case-based reasoning systems, such as HYPO [Ashley, 1990] and CATO [Aleven, 1997].

1 Introduction

The paper we present here is a summary of [Zheng et al., 2020a], which aims for discussing the validity of arguments in case-based reasoning. The paper is a preliminary work of my PhD project, which is about modeling case-based reasoning with the formal argumentation theory that was first addressed by [Verheij, 2016a], in order to develop a hybrid AI system that combines data and knowledge. As we show in [Zheng et al., 2020a], artificial intelligence and law is a good application of argumentation theory (e.g., [Prakken and Sartor, 1998, Horty and Bench-Capon, 2012, Prakken et al., 2013]). In 2017, [Verheij, 2017] discusses the validity of arguments in legal reasoning

2 Method

We use a propositional logic language L generated from a set of propositional constants. We write \neg for negation, \wedge for conjunction, \vee for disjunction, \leftrightarrow for equivalence, \top for a tautology, and \perp for a contradiction. The associated classical, deductive, monotonic consequence relation is denoted \models .

We introduce our approach with an example from the trade secret law in the United States that has been discussed in [Ashley, 2017, Zheng et al., 2020a].

As shown in Figure 1, the *Mason* case¹ is considered as a current situation of which the result needs to

¹Mason v. Jack Daniel Distillery, 518 So.2d 130 (Ala.Civ.App.1987)

be decided based on the analysis of the given precedents, namely the *Yokana* case² and the *American Precision* case³.

HYPO considers cases as sets of factors. Each factor favors either the plaintiff or the defendant. For instance, Figure 1 shows that in HYPO, the *Yokana* case is represented by set {F7, F10, F16}. F7 favors for the plaintiff; both F10 and F16 favor for the defendant.

In the precedent model formalism, we consider precedents as consisting of factors and outcomes. Both *factors* and *outcomes* are literals. A literal is either a propositional constant or its negation. We use $F \subseteq L$ to represent a set of factors, $O \subseteq L$ to represent a set of outcomes. The sets F and O are disjoint and consist only of literals. If a propositional constant p is in F (or O), then $\neg p$ is also in F (respectively in O). For instance, Figure 1 shows that in the precedent model, the *Yokana* case is represented by sentence $F7 \wedge F10 \wedge F16 \wedge \neg\text{Pla}$.

Notice that our use of factors is related to but differs from factors in HYPO. Instead of sets, we represent the precedents as logical conjunctions of factors and outcomes. A factor in our formalism represents an element of a case, namely a factual circumstance. Its negation describes the opposite fact. For instance, if a factor φ is “A kills B”, then its negation $\neg\varphi$ is “A does not kill B”. If an outcome ω is “A is guilty”, its negation $\neg\omega$ is “A is not guilty”.

In the formalism, we consider both legal precedents and current situations as *precedents*. If a precedent contains an outcome, for instance, a legal precedent, then we say it is a *proper precedent*. If a precedent doesn’t have any outcome, then we say it is a *situation* that describes a current case. The outcomes of these situations need to be decided upon. A precedent is formally defined as follows [Zheng et al., 2020a]:

Definition 1 (Precedents) *A precedent is a logically consistent conjunction of distinct factors and outcomes $\pi = \varphi_0 \wedge \varphi_1 \wedge \dots \wedge \varphi_m \wedge \omega_0 \wedge \omega_1 \wedge \dots \wedge \omega_{n-1}$, where*

²Midland-Ross Corp. v. Yokana, 293 F.2d 411 (3rd Cir.1961)

³American Precision Vibrator Co. v. National Air Vibrator Co., 764 S.W.2d 274 (Tex.App.-Houston [1st Dist.] 1988)

m and n are non-negative integers. We say that $\varphi_0, \varphi_1, \dots, \varphi_m$ are the factors of π , $\omega_0, \omega_1, \dots, \omega_{n-1}$ are the outcomes of π . If $n = 0$, then we say that π is a situation with no outcomes, otherwise π is a proper precedent [Zheng et al., 2020a].

Example 1 We assume the set of outcomes $O = \{\text{Pla}, \neg\text{Pla}\}$. Pla stands for plaintiff wins the claim, $\neg\text{Pla}$ stands for defendant wins the claim.

The *Yokana* case shown in Figure 1 is represented as sentence $F7 \wedge F10 \wedge F16 \wedge \text{Pla}$, the *American Precision* case is represented as $F7 \wedge F16 \wedge F21 \wedge \neg\text{Pla}$. Both these two cases are proper precedent.

The *Mason* case is represented as $F1 \wedge F6 \wedge F15 \wedge F16 \wedge F21$, it is considered as a situation.

Notice that both m and n in the definition of precedents can be equal to 0. When $m = 0$, there is one single factor. When $n = 0$, the precedent has no outcome and the empty conjunction $\omega_0 \wedge \dots \wedge \omega_{n-1}$ is equivalent to \top .

Now we turn to precedent models, which can be considered as a special kind of case models introduced by [Verheij, 2016a]. Details of this account can be found in [Zheng et al., 2020a]. The precedent models are defined as:

Definition 2 (Precedent models) *A precedent model is a pair (P, \geq) where P is a set of precedents such that for all $\pi, \pi' \in P$ with $\pi \neq \pi'$, $\pi \wedge \pi' \models \perp$; and \geq is a total preorder over P .*

Example 2 Following Example 1, Figure 1 shows the precedent model (P, \geq) formed by the *Yokana* case and the *American Precision* case. As in HYPO, all legal precedents are with equal preference, therefore, in the precedent model, $\geq = P \times P$, which is the trivial preference relation where all precedents are equivalent. It is shown by the size of the boxes.

As customary, the asymmetric counterpart of \geq is denoted $>$. The symmetric counterpart of \geq is denoted \sim . Formally, \geq means ‘higher in the ordering than or equally high as’. When it is used for the sentences that expresses precedents in a precedent model, the ordering means preference.

One of the main contributions of HYPO-style case-based reasoning is *3-ply arguments*. They are used for illustrating the process of reasoning. As described in

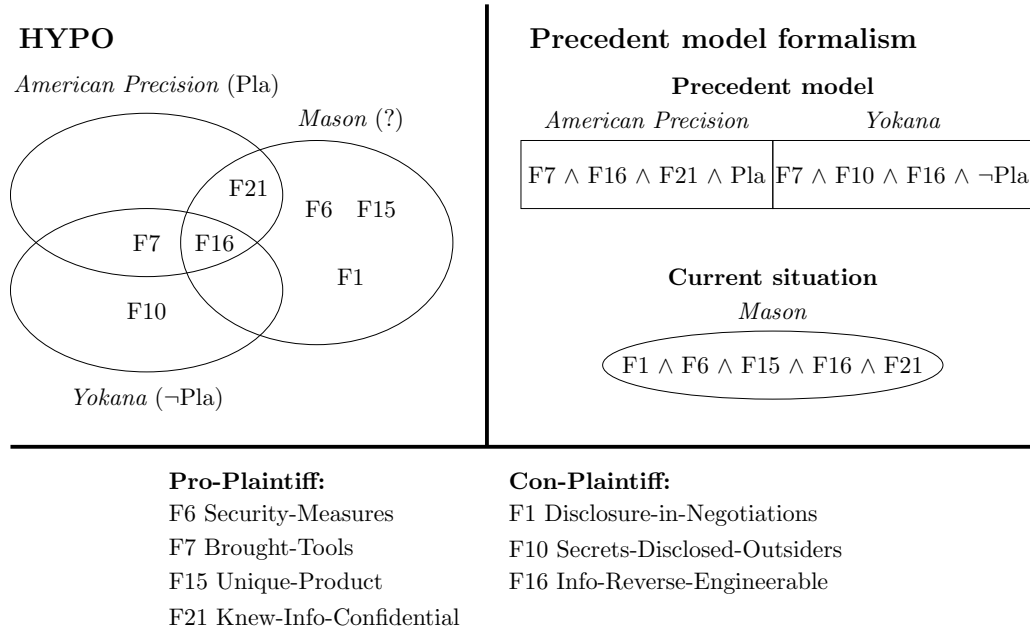

Figure 1: A Venn diagram [Ashley, 2017] and a precedent model [Zheng et al., 2020a] about the *Mason* problem

[Ashley, 2017], the 3-ply argument comprised:

1. A case cited by Side 1.
2. A response from Side 2.
3. A rebuttal from Side 1.

Example 3 In the *Mason* problem, a 3-ply argument in HYPO can be generated as follows:

1. The defendant uses set {F16} for analogizing the *Yokana* case with the *Mason* case.
2. The plaintiff uses set {F6, F10, F15, F21} to distinguish the *Yokana* case from *Mason*, and uses set {F16, F21} to cite the *American Precision* case as a counterexample of *Yokana*.
3. The defendant distinguishes *American Precision* with set {F1, F7}.

In our formalism, arguments and their validities in precedent models (first discussed in [Verheij, 2016a]) are shown as follows:

An *argument* from χ to ρ is a pair (χ, ρ) with χ and $\rho \in L$. For $\lambda \in L$, if $\chi \models \lambda$, λ is a *premise* of the

argument; if $\rho \models \lambda$, λ is a *conclusion*; if $\chi \wedge \rho \models \lambda$, λ is a *position* in the case made by the argument. We say that χ expresses the *full premise* of the argument, ρ the *full conclusion*, and $\chi \wedge \rho$ its *full position*, also referred to as the *case made* by the argument [Verheij, 2016a].

Arguments have three kinds of validities. As defined in [Verheij, 2016a, Zheng et al., 2020a]:

1. If an argument is logically implied by one of the precedents in a precedent model, then the argument is *coherently valid* in the precedent model;
2. If all precedents in a precedent model logically implying an argument’s full premise also logically imply its full conclusion, then the argument is *conclusively valid* in the precedent model;
3. If an argument’s conclusion is logically implied by a precedent which is the most preferred among the precedents that logically imply the argument’s full premise, then the argument is *presumptively valid* in the precedent model.

Example 4 We analyze the arguments discussed in Example 3 with the precedent model in Figure 1:

1. (F16, ¬Pla) The defendant’s argument for analogizing cases in the first ply. The argument is presumptively valid in the model.
2. (F10, Pla) and (F6 ∧ F15 ∧ F21, Pla) The plaintiff’s argument for distinguishing cases in the second ply. Both of the arguments are not coherent in the model.
3. (F16 ∧ F21, Pla) The plaintiff’s argument for citing a counterexample in the second ply. The argument is conclusively valid in the model.
4. (F1, ¬Pla) and (F7, ¬Pla) The defendant’s argument for distinguishing the counterexample in the third ply. (F1, ¬Pla) is not coherent in the model, while (F7, ¬Pla) is presumptively valid.

The example shows arguments for analogizing *Yokana* and *American Precision* with *Mason* are at least presumptively valid in the model, while most of the arguments for distinguishing them with the situation are incoherent, except for one of the arguments for distinguishing *American Precision* from *Mason*.

3 Discussion

As discussed in [Zheng et al., 2020a], unlike other case-based reasoning modeling approaches [Prakken and Sartor, 1998, Horty and Bench-Capon, 2012, Prakken et al., 2013], our method uses a standard formal logical language. The formalization of the validity of arguments in case-based reasoning can give a different perspective on argument moves. For instance, the argument (F16, ¬Pla) for citing *Yokana* is only presumptive in the model, while the argument (F16 ∧ F21, Pla) for citing its counterexample *American Precision* is conclusive. In a formal sense the latter argument is stronger.

As preliminary research of my PhD project, the paper describes a formal method for modeling the validity of arguments in case-based reasoning with factors. It shows the potential to further apply the formalism to analyze case-based reasoning. For the future development of my PhD research, we go beyond the

formal evaluation of arguments with the models, and further apply the formalism to case-based reasoning in AI and Law. For instance, in [Zheng et al., 2020b], we’ve already formally discussed precedent comparisons with the formalism.

The formalization can also be used for discussing the dynamics of case-based reasoning. As a high-relevant issue in AI and law and part of my PhD research project, the topic focuses on the precedential values in case-based reasoning, which has been discussed by many research (e.g., [Hafner and Berman, 2002, Henderson and Bench-Capon, 2019, Verheij, 2016b]). Our formalism can explain that after adding a precedent incorporating a groundbreaking decision, the previously incoherent argument can become coherent in the adapted model. For instance, the decision of the *Mason* case can be considered as groundbreaking. After it is decided, the validity of argument (F1 ∧ F6 ∧ F15 ∧ F16 ∧ F21, Pla) will shift from incoherent to coherent in the adapted model. Thereby our approach has the potential to formally analyze the dynamics of case-based reasoning.

4 Conclusion

In this paper, we summarize the idea of a preliminary work of my PhD research which formalizes the validity of arguments in case-based reasoning [Zheng et al., 2020a] based on a formal logical method developed by [Verheij, 2016a]. We show that the formalism has the potential to be used to formally model elements of case-based reasoning.

Since past cases can be considered as a kind of data, and valid arguments show patterns that hold in the data, the approach provides a step in the development of hybrid AI systems that combine structured knowledge grounded in data [Verheij, 2020]. In the future, we will continue to analyze more issues in artificial intelligence and law with the formal argumentative approach presented in this paper.

5 Acknowledgment

I thank my supervisors Bart Verheij and Davide Grossi for their valuable advice and help on the research described by this paper, which is supported by the Guangzhou Elite Project.

References

- [Aleven, 1997] Aleven, V. (1997). *Teaching case-based argumentation through a model and examples*. PhD thesis, University of Pittsburgh.
- [Ashley, 1990] Ashley, K. D. (1990). *Modeling Legal Arguments: Reasoning with Cases and Hypotheticals*. MIT Press, Cambridge.
- [Ashley, 2017] Ashley, K. D. (2017). *Artificial Intelligence and Legal Analytics: New Tools for Law Practice in the Digital Age*. Cambridge University Press, Cambridge.
- [Hafner and Berman, 2002] Hafner, C. and Berman, D. (2002). The role of context in case-based legal reasoning: teleological, temporal, and procedural. *Artificial Intelligence and Law*, 10(1):19–64.
- [Henderson and Bench-Capon, 2019] Henderson, J. and Bench-Capon, T. (2019). Describing the development of case law. In *Proceedings of the Seventeenth International Conference on Artificial Intelligence and Law*, ICAIL '19, page 32–41. Association for Computing Machinery, New York, NY, USA.
- [Horty and Bench-Capon, 2012] Horty, J. and Bench-Capon, T. (2012). A factor-based definition of precedential constraint. *Artificial Intelligence and Law*, 20(2):181–214.
- [Prakken and Sartor, 1998] Prakken, H. and Sartor, G. (1998). Modelling reasoning with precedents in a formal dialogue game. *Artificial Intelligence and Law*, 6(2-4):231–287.
- [Prakken et al., 2013] Prakken, H., Wyner, A., Bench-Capon, T., and Atkinson, K. (2013). A formalization of argumentation schemes for legal case-based reasoning in ASPIC+. *Journal of Logic and Computation*, 25(5):1141–1166.
- [Verheij, 2016a] Verheij, B. (2016a). Correct Grounded Reasoning with Presumptive Arguments. In Michael, L. and Kakas, A., editors, *15th European Conference on Logics in Artificial Intelligence, JELIA 2016. Larnaca, Cyprus, November 9–11, 2016. Proceedings (LNAI 10021)*, pages 481–496. Springer, Berlin.
- [Verheij, 2016b] Verheij, B. (2016b). Formalizing value-guided argumentation for ethical systems design. *Artificial Intelligence and Law*, 24(4):387–407.
- [Verheij, 2017] Verheij, B. (2017). Formalizing Arguments, Rules and Cases. In *Proceedings of the Sixteenth International Conference on Artificial Intelligence and Law*, ICAIL 2017, pages 199–208. ACM, New York.
- [Verheij, 2020] Verheij, B. (2020). Artificial Intelligence as Law. Presidential Address to the Seventeenth International Conference on Artificial Intelligence and Law. *Artificial Intelligence and Law*, 28(2):181–206.
- [Zheng et al., 2020a] Zheng, H., Grossi, D., and Verheij, B. (2020a). Case-Based Reasoning with Precedent Models: Preliminary Report. In Prakken, H., Bistarelli, S., Santini, F., and Tacicchi, C., editors, *Computational Models of Argument. Proceedings of COMMA 2020*, volume 326, pages 443–450. IOS Press, Amsterdam.
- [Zheng et al., 2020b] Zheng, H., Grossi, D., and Verheij, B. (2020b). Precedent Comparison in the Precedent Model Formalism: A Technical Note. In Villata, S., Harašta, J., and Kšemen, P., editors, *Legal Knowledge and Information Systems. JURIX 2020: The Thirty-third Annual Conference*, volume 334, pages 259 – 262. IOS Press, Amsterdam.