

# An Overview of Deep Learning Techniques for Epileptic Seizures Detection and Prediction Based on Neuroimaging Modalities: Methods, Challenges, and Future Works

Afshin Shoeibi<sup>a,b,\*</sup>, Navid Ghassemi<sup>a,b</sup>, Marjane Khodatars<sup>c</sup>, Mahboobeh Jafari<sup>d</sup>, Parisa Moridian<sup>e</sup>, Roohallah Alizadehsani<sup>f</sup>, Yinan Kong<sup>g</sup>, Juan Manuel Gorriz<sup>h</sup>, Javier Ramírez<sup>h</sup>, Abbas Khosravi<sup>f</sup>, Saeid Nahavandi<sup>f</sup>, U. Rajendra Acharya<sup>i,j,k</sup>

<sup>a</sup>*Faculty of Electrical Engineering, FPGA Lab, K. N. Toosi University of Technology, Tehran, Iran.*

<sup>b</sup>*Computer Engineering department, Ferdowsi University of Mashhad, Mashhad, Iran.*

<sup>c</sup>*Department of Medical Engineering, Mashhad Branch, Islamic Azad University, Mashhad, Iran.*

<sup>d</sup>*Electrical and Computer Engineering Faculty, Semnan University, Semnan, Iran.*

<sup>e</sup>*Faculty of Engineering, Science and Research Branch, Islamic Azad University, Tehran, Iran.*

<sup>f</sup>*Intelligent for Systems Research and Innovation (IISRI), Deakin University, Victoria 3217, Australia.*

<sup>g</sup>*School of Engineering, Macquarie University, Sydney 2109, Australia.*

<sup>h</sup>*Department of Signal Theory, Networking and Communications, Universidad de Granada, Spain.*

<sup>i</sup>*Ngee Ann Polytechnic, Singapore 599489, Singapore.*

<sup>j</sup>*Dept. of Biomedical Informatics and Medical Engineering, Asia University, Taichung, Taiwan.*

<sup>k</sup>*Dept. of Biomedical Engineering, School of Science and Technology, Singapore University of Social Sciences, Singapore.*

---

## Abstract

Since epilepsy happens due to abnormal activity in the brain, seizures can affect any process your brain handles. Some signs and symptoms of seizures include confusion, abnormal staring, and rapid, sudden, and uncontrollable hand movements. Epileptic seizure detection methods involve neurological exams, blood tests, neuropsychological tests, and neuroimaging modalities. Among these, neuroimaging modalities have received considerable attention from spe-

---

\*Corresponding author

*Email addresses:* afshin.shoeibi@gmail.com (Afshin Shoeibi), navidghassemi@mail.um.ac.ir (Navid Ghassemi), khodatars1marjane@gmail.com (Marjane Khodatars), mahbube.jafari@yahoo.com (Mahboobeh Jafari), parisamoridian@yahoo.com (Parisa Moridian), ralizadehsani@deakin.edu.au (Roohallah Alizadehsani), yinan.kong@mq.edu.au (Yinan Kong), gorriz@ugr.es (Juan Manuel Gorriz), javierrp@ugr.es (Javier Ramírez), abbas.khosravi@deakin.edu.au (Abbas Khosravi), saeid.nahavandi@deakin.edu.au (Saeid Nahavandi), Rajendra\_Udyavara\_ACHARYA@np.edu.sg (U. Rajendra Acharya)

cialist physicians. One method to facilitate the accurate and fast diagnosis of epileptic seizures is to employ computer-aided diagnosis systems (CADs) based on deep learning (DL) and neuroimaging modalities. This paper has studied a comprehensive overview of DL methods exploited for epileptic seizures detection and prediction using neuroimaging modalities. First, DL-based CADs for the epileptic seizures detection and prediction using neuroimaging modalities are discussed. Also, descriptions of various datasets, preprocessing algorithms, and DL models which have been used for epileptic seizures detection and prediction have been included. Then, research on rehabilitation tools has been presented, which contains brain-computer interface (BCI), implantable, cloud computing, internet of things (IoT), hardware implementation of DL techniques on field-programmable gate array (FPGA), etc. In the discussion section, a comparison has been carried out between research on epileptic seizure detection and prediction. The most important challenges in epileptic seizures detection and prediction using neuroimaging modalities and DL models have been expressed. In addition, future work proposal in the fields of datasets, DL, rehabilitation, and hardware models has been proposed. The final section is dedicated to the conclusion and incorporates the most significant findings in this field.

*Keywords:* Epileptic Seizures, Neuroimaging, Deep Learning, Detection, Prediction, Rehabilitation, Cloud-Computing.

---

## 1. Introduction

Epileptic seizures are a non-communicable disease and are one of the most prevalent disorders of the nervous system. Epileptic disorders usually occur with sudden attacks that result from abnormal activity of the cortical or membrane nerve in the brain (Iasemidis, 2003; Shoeb and Guttag, 2010; Tzallas et al., 2012; Subasi, 2005; Shoeb, 2009a). More than 60 million people worldwide have various types of epileptic seizures and suffer from them (Pachori and Bajaj, 2011; Siddiqui et al., 2020; Wong and Kuhlmann, 2020). Figure 1 displays the number of people with epileptic seizures in various parts of the world (Abramovici and Bagić, 2016). As shown in the figure, the number of people with this type of neurological disorder is greater in underdeveloped countries than in other countries (Abramovici and Bagić, 2016).

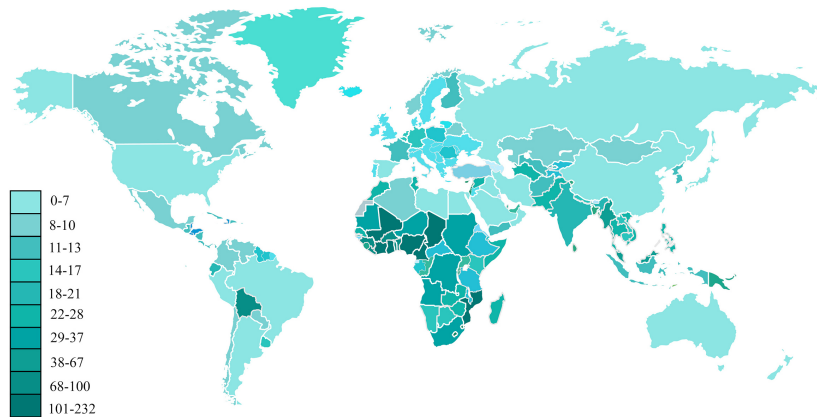

Figure 1: Graph of the number of people with epileptic seizures worldwide (Abramovici and Bagić, 2016).

Epilepsy is a rapid and early abnormality in the brain’s electrical activity, disrupting part or all of the human body (Duncan et al., 2006; Noachtar and Peters, 2009). Medical researchers have divided epileptic seizures into three categories: generalized (Hussein et al., 2018a; Gloor and Fariello, 1988), focal (Nair et al., 2020; Frauscher and Gotman, 2019), and epilepsy with unknown onset (Ngho and Parker, 2017), each of which has various types.

General epilepsy involves the whole brain and causes disruption of the activity of all neurons in the brain, eventually may lead to the impairment of all parts of the brain (Cerulli Irelli et al., 2020; Liu et al., 2017; Clarke et al., 2019). In partial epilepsy, a small group of neurons form a focal epilepsy and are confined to a hemisphere of the brain. 60% of patients with epilepsy have focal seizures that are mostly drug-resistant (Misiūnas et al., 2019; Boran et al., 2019; Pellegrino et al., 2018). The classification of epileptic seizure types is shown in Figure 2. In this figure, the classification of epileptic seizures before 2011 is depicted in darker color, and the classification of epileptic seizures from 2016 onwards is highlighted in lighter color. More information is available in reference (Ngho and Parker, 2017).

People with epileptic seizures may sometimes experience severe psycholog-

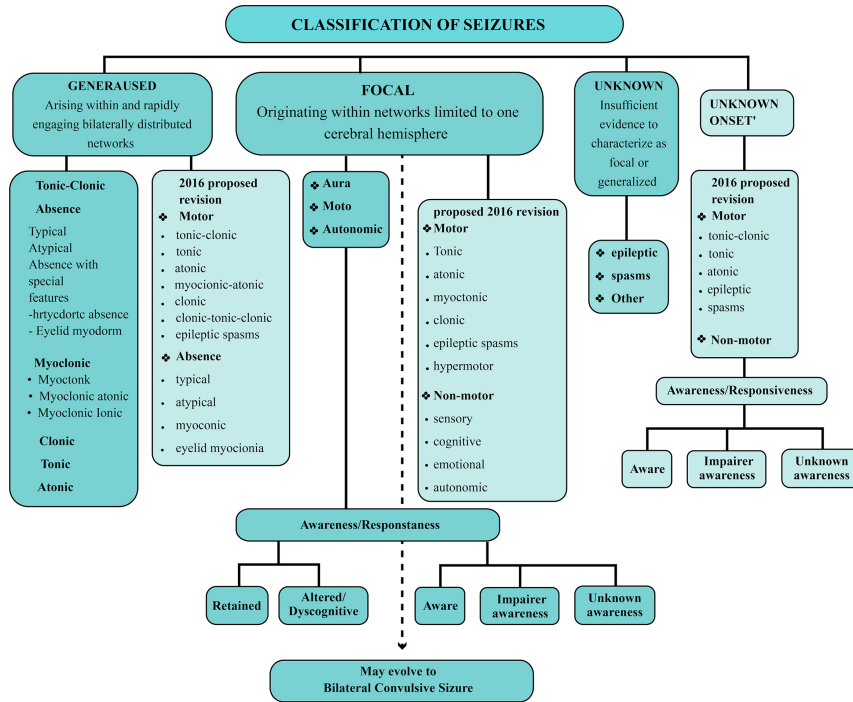

Figure 2: Showing different types of general and focal epileptic seizures (Ngoh and Parker, 2017).

ical trauma due to embarrassment and lack of proper social status (Sharma and Pachori, 2015; Gupta et al., 2020). Given the above, accurate and rapid diagnosis of these neurological disorders in the early stages is crucially pivotal.

Specialist physicians usually use functional and structural neuroimaging techniques to diagnose epileptic seizures. Electroencephalogram (EEG) (Yuan et al., 2018a; Fan and Chou, 2018), functional magnetic resonance imaging (fMRI) (Vaughan and Jackson, 2020; Garner et al., 2019), magnetoencephalography (MEG) (Colon et al., 2018; Rampp et al., 2019), electrocorticography (ECoG) (Mohammadpoory et al., 2019; Siddiqui et al., 2019), functional near-infrared spectroscopy (fNIRS) (Rosas-Romero et al., 2019; Guevara et al., 2020), positron emission tomography (PET) (Oldan et al., 2018; Wang et al., 2019), and SPECT (El Tahry et al., 2018) are the most substantial functional neuroimaging modalities. In contrast, structural MRI (sMRI) (Rüber et al., 2018; Xu et al., 2020b) and diffusion tensor imaging (DTI) (Bao et al., 2018; Chap-



man et al., 2005) are in the category of structural neuroimaging modalities. In figure 3, neuroimaging modalities for epileptic seizures detection are described.

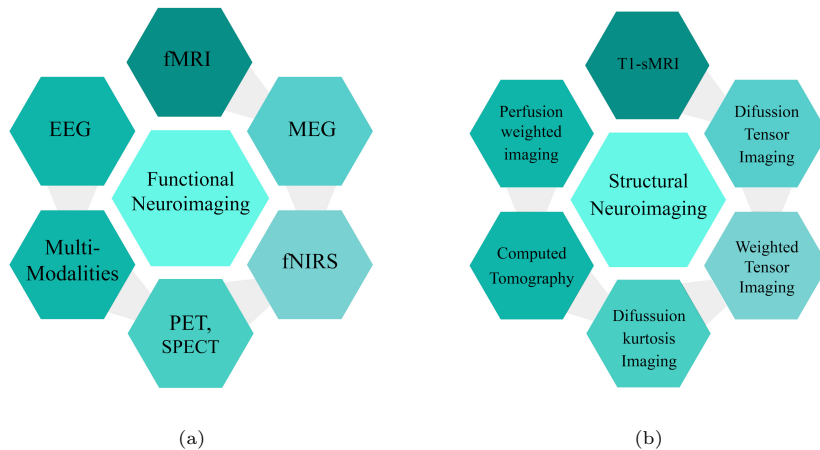

Figure 3: Neuroimaging modalities for epileptic seizures detection.

As shown in Figure 3, structural neuroimaging modalities include sMRI and DTI approaches. By using the sMRI modality, structural abnormalities and brain lesions caused by epileptic seizures can be identified (Woermann and Vollmar, 2009; Bell et al., 2009). Additionally, this modality can be used to identify the anatomical zone of the epileptogenic region that is responsible for the seizure, which is a pivotally significant step for presurgical evaluations of epilepsy (Woermann and Vollmar, 2009; Bell et al., 2009). sMRI is also employed after surgery to evaluate the success or failure of the epileptic region removal and to assess the need for reoperation (Woermann and Vollmar, 2009; Bell et al., 2009). Disadvantages of sMRI include its widespread unavailability, high cost, and the necessity for long-term scans.

The DTI modality provides information on the structural anatomy of the white matter tracts and makes it possible to investigate the microstructural status of the white matter. Although the advantages of applying DTI in the diagnosis of the lesions for epilepsy are still being examined, modeling and reconstructing hidden pathways in white matter is of utmost importance as a presurgical evaluation step (Zhang et al., 2020d).

In EEG modality, the measurement of voltage fluctuations produced by the ionic current of neurons in the brain is performed, indicating the bioelectric ac-

tivity of the brain and containing the physiological information of people with epileptic seizures (Acharya et al., 2013; Sharmila, 2018). The investigations reviewed in this paper demonstrates the effectiveness of EEG modality performance in diagnosing epileptic seizures. EEG incorporates two methods of non-invasive scalp (sEEG) (Saab and Gotman, 2005; Fergus et al., 2015) and intracranial (IEEG) recording (Liu et al., 2012; Aarabi et al., 2009). The sEEG method is widely used by specialist physicians and neurologists compared to IEEG due to its lower risks and more straightforward recording. Additionally, considering that these signal recordings are economically inexpensive and the fact that the frequency and rhythm of brain activity vary during seizures, EEG has become one of the foremost epileptic seizures diagnostic methods (Birjandtalab et al., 2017; Weng and Khorasani, 1996). Compared to EEG, ECoG, fNIRS, and MEG functional modalities are less effective in diagnosing epileptic seizures.

fMRI modality is another neuroimaging technique for epileptic seizures detection and includes two methods based on task (T-fMRI) (Gaillard et al., 2002) and resting state (rs-fMRI) (Centeno and Carmichael, 2014). fMRI is adapted to detect changes in regional blood flow and metabolism due to the activation of brain regions (Gaillard et al., 2002; Centeno and Carmichael, 2014). One of the fMRI applications in epilepsy is identifying ictal and interictal phenomena given rise to the localization of the focal seizures (Gaillard et al., 2002; Centeno and Carmichael, 2014). During seizures, brain function changes in the epileptogenic region, which can be detected using fMRI (Gaillard et al., 2002; Centeno and Carmichael, 2014). fMRI can also be exploited to assess brain function before surgery in patients with drug-resistant epilepsy (Gaillard et al., 2002; Centeno and Carmichael, 2014). One of the drawbacks of fMRI is that the patient has to be in the scanner for a long period to seizure occur and the scan to be completed.

Detecting epileptic seizures from neuroimaging modalities with all the benefits that are sometimes challenging. Epileptic seizure detection using neuroimaging modalities requires a considerable amount of recording data in order for the specialist doctors to make the appropriate decisions. Big data analysis of neuroimaging modalities in most cases beget incorrect epileptic seizures diagnosis by physicians. This is due to eye fatigue when interpreting many structural

or functional imaging modalities. Additionally, the presence of diverse noises in neuroimaging modalities is another cause of misdiagnosis. In order to conquer these dilemmas, CADs for epileptic seizures detection using neuroimaging modalities and AI are of considerable help to specialists in the epileptic seizures detection field.

So far, many research works have been conducted to diagnose epileptic seizures using AI. Until quite a few years ago, most examinations were performed in the field of conventional machine learning (Abbasi and Goldenholz, 2019; Rasheed et al., 2020). In traditional machine learning, the selection of the feature extraction, reduction and classification techniques is dependent on the characteristics of the data (Dey, 2016; Naik et al., 2020). However, in DL approaches, all these steps are fulfilled via integrated layers and automatically (Dash et al., 2020; Goodfellow et al., 2016). Various DL methods have promptly received a tremendous amount of attention from numerous experts in the brain signal processing domain (Wainberg et al., 2018). This has made the diagnosis of epileptic seizures based on functional and structural brain modalities along with DL techniques one of the most novel areas of research. In this paper, a complete review of conducted research in the epileptic seizures field from neuroimaging modalities along with DL methods, along with challenges and future work in this field has been presented.

In order to search for papers in the scope of diagnosis of epileptic seizures, various citation databases such as IEEE Xplore, ScienceDirect, SpringerLink, and Wiley have been exploited. In addition, Google Scholar has been used to find papers with the keywords "Epileptic Seizure," "EEG," "fMRI," "ECoG," "MEG," "fNIRS," "MRI," "PET" and "Deep Learning." The latest articles were reviewed by the authors on December 30th, 2020. The number of papers accepted each year in different citation sites for the diagnosis of epileptic seizures is illustrated in Figure 4.

In the following, the outline of this investigation is introduced. The second section concisely presents the DL networks exploited in diagnosing epileptic seizures. Recent CADs for epileptic seizures using DL techniques are examined in Section three. Several research works in the field of rehabilitation systems, cloud computing, and diagnostic epilepsy procedures using non-neural modali-

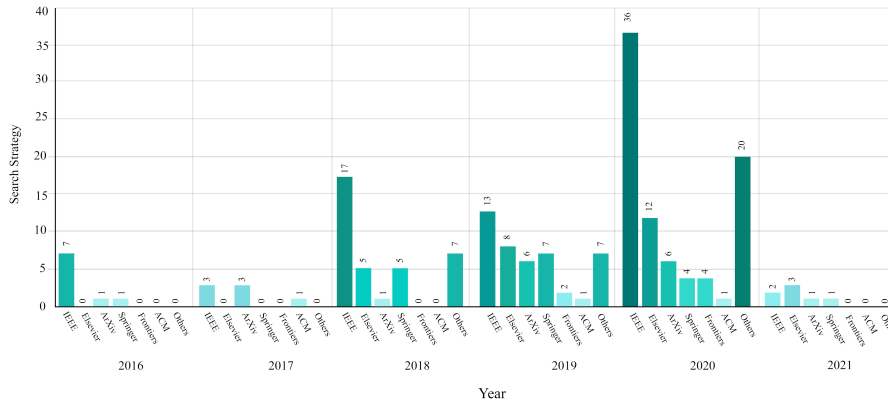

Figure 4: Number of papers published for automated detection of epileptic seizures using DL techniques.

ties are presented in the fourth section. The discussion is introduced in Section five. In the sixth section, the challenges in diagnosing epileptic seizures are fully described. Finally, conclusions and recommendations for future work are provided in the seventh section.

## 2. Epileptic Seizures Detection Using DL Techniques

In this section, DL networks used in the diagnosis of epileptic seizures are presented. Convolutional neural networks (CNNs) are the first category of DL architectures involving a variety of one-dimensional (1D), two-dimensional (2D), and three-dimensional (3D) models (Goodfellow et al., 2016; Sadeghi et al., 2021). These networks follow supervised learning and have three main layers: convolutional, pooling, and fully connected (FC) layers (Goodfellow et al., 2016). Recurrent neural networks (RNNs) are another paradigm of DL networks that are based on supervised learning widely applied in time series tasks (Goodfellow et al., 2016; Shoeibi et al., 2020). Autoencoders (AEs) models (Goodfellow et al., 2016; Burda et al., 2015) and deep belief networks (DBNs) (Goodfellow et al., 2016; Hinton, 2009) are other types of DL networks based on unsupervised learning. In addition to these models, improved methods from CNN named generative adversarial networks (GANs) (Goodfellow et al., 2014) architectures have been proposed for various applications that are based on unsupervised

learning. It should be pointed out that generative adversarial networks (GANs) architectures are adopted as supervised techniques in some issues (Goodfellow et al., 2014; Yi et al., 2019; Alizadehsani et al., 2021; Ghassemi et al., 2020). CNN-RNN and CNN-AE are two other categories of DL systems created by combining two different architectures (Chen et al., 2017a). The CNN-RNN and CNN-AE architectures follow supervised and unsupervised learning, respectively (Keren and Schuller, 2016). Details of the types of DL networks in the diagnosis of epileptic seizures are manifested in Figure 5.

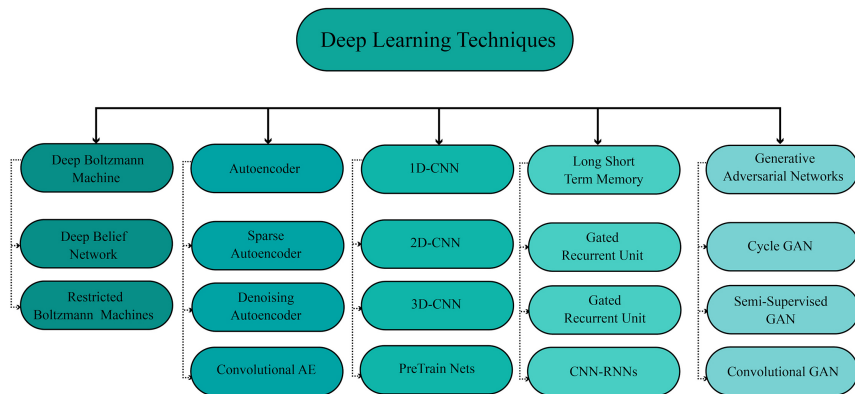

Figure 5: Illustration of various DL methods used for epileptic seizures detection.

### 3. CAD Based on DL techniques for Epileptic Seizures using Neuroimaging Modalities

Diagnosis of epileptic seizures from functional and structural neuroimaging modalities of the brain along with AI algorithms has a long history. Until recently, the diagnosis of epileptic seizures using CADs was based on conventional machine learning techniques that have been the subject of much research (Paul, 2018; Boonyakitanont et al., 2020a; Dhull et al., 2021; Mei et al., 2018). The most significant weaknesses of these systems were the process of selecting the best feature extraction and dimensional reduction algorithms (feature selection or reduction) using trial and error that required a considerable amount of knowledge in the AI fields (Mohammadpoor et al., 2016). To resolve these issues, from

2016 onwards, DL methods in CADs for epileptic seizures detection were considered and quickly replaced the conventional machine learning approaches. In CADs based-DL, the feature extraction and selection steps are accomplished entirely automatically. The CADs for epileptic seizures detection based on DL techniques are represented in figure 6.

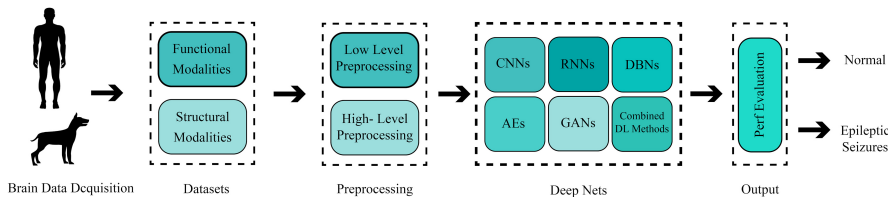

Figure 6: Illustration of block diagram for epileptic seizures detection using DL methods.

According to figure 6, a variety of structural and functional neuroimaging modalities are first considered as DL input. In the following, low-level and high-level preprocessing methods are applied to the input data. Then, feature extraction up to classification steps are performed by the desired DL networks (DL networks for epileptic seizures detection research papers are displayed in Appendix A). Finally, various evaluation parameters such as accuracy, sensitivity, and precision are calculated.

### 3.1. Epileptic Seizures Datasets

In this section, the most notable datasets on diagnosing epileptic seizures are reviewed, all of which are freely accessible. Without proper datasets, developing accurate and robust CADs is not possible. Several EEG datasets and an ECoG dataset are currently available to researchers freely; however, datasets on other neuroimaging modalities such as MRI have not yet been made freely available. Multiple EEG datasets, namely Freiburg (Ihle et al., 2012), CHB-MIT (Shoeb, 2009b), Kaggle (George et al., 2020), Bonn (Andrzejak et al., 2001), Flint-Hills (Assi et al., 2017), Bern-Barcelona (Andrzejak et al., 2012), Hanz Khas (Assi et al., 2017), and Zenodo (Stevenson et al., 2019) are the main ones for developing automatic systems for epileptic seizure detection. The signals forming each datapoint of these datasets are recorded either intracranial or from the scalp of humans or animals. Table 1 provides the supplementary information on each

dataset, and also, the types of EEG datasets for epileptic seizures diagnosis using DL are listed in table 2.

Table 1: List of popular epileptic seizure datasets.

Dataset	Number of Patient	Number of Seizures	Recording	Total Duration (hour)	Sampling Frequency (Hz)
Flint-Hills (Assi et al., 2017)	10	59	Continues intracranial ling term ECoG	1419	249
Hauz Khas (Assi et al., 2017)	10	NA	Scalp EEG (sEEG)	NA	200
Freiburg (Ihle et al., 2012)	21	87	Intracranial Electroencephalography (IEEG)	708	256
CHB-MIT (Shoeb, 2009b)	22	163	sEEG	844	256
Kaggle (George et al., 2020)	$\frac{5 \text{ Dogs}}{2 \text{ Patients}}$	48	IEEG	622	$\frac{400}{5000}$
Bonn (Andrzejak et al., 2001)	10	NA	Surface and IEEG	39m	173.61
Bern Barcelona (Andrzejak et al., 2012)	5	3750	IEEG	83	512
Zenodo (Stevenson et al., 2019)	79 Neonatal	460	sEEG	74m	256

### 3.2. Preprocessing

#### 3.2.1. EEG Preprocessing

Preprocessing is the first step in DL-based CADs for epileptic seizures detection. The presence of different artifacts in EEG signals always poses a severe challenge to physicians and neurologists in accurately diagnosing epileptic seizures. Artifacts from eye blinks, eye movements, muscle expansion and contraction, and municipal electricity noise are among the most important EEG data noises that should be eliminated from the signals in the preprocessing step (Shoka et al., 2019; Kim, 2018; Peng, 2019; Jiang et al., 2019b). In some cases, the presence of multiple artifacts begets loss of EEG signals' substantial information between various noises and makes it challenging to diagnose epileptic seizures. EEG signal preprocessing in the diagnosis of epileptic seizures is divided into two types of low-level and high-level approaches, which are explained following. Table 2 shows the low-level and high-level preprocessing techniques of EEG signals in epileptic diagnostic research.

#### A. Low Level EEG Preprocessing

In this section, low-level preprocessing methods are presented in the DL-based CADs for epileptic seizure detection. Low-level preprocessing in EEG signals involves noise removal, normalization, down-sampling, and segmentation. In order to remove noise from EEG signals, various types of low-pass, high-pass, and band-pass based Butterworth and or Chebyshev filters with different orders are widely employed (these filters are of finite impulse response (FIR) or Infinite impulse response (IIR) types) (Gao et al., 2009; Lai et al., 2018; Patro and Sahu, 2015). Raw EEG signals have variable voltage amplitude degrading the efficiency of CADs in diagnosing epileptic seizures. To obviate this problem, it is recommended to utilize different normalization methods such as Z-Score (Sayem et al., 2021). Storing and processing EEG signals requires a lot of memory space. By using down-sampling, EEG signals sampling frequency is decreased by half, which halves the storage space of EEG signals. Windowing or segmentation of EEG signals is the last part of low-level preprocessing. Segmentation assists in decomposing EEG data into more detailed sections to extract more significant information from each signal frame (Tuncer et al., 2020).

### **B. High Level EEG Preprocessing**

High-level preprocessing techniques play a pivotal role in enhancing the efficiency of CADs in diagnosing epileptic seizures. In this section, Data augmentation (DA) models are stated as the first category of high-level preprocessing (Lashgari et al., 2020; Hartmann et al., 2018). The deficiency of EEG signals usually causes overfitting of DL networks during training, and the exploiting of DA techniques is a proper approach to address this problem. Discrete wavelet transform (DWT) (Ocak, 2009), continuous wavelet transform (CWT) (Abibul-laeV et al., 2010), fast Fourier transform (FFT) (Polat and Güneş, 2007), and empirical mode decomposition (EMD) (Alam and Bhuiyan, 2013) are other high-level preprocessing techniques employed to eliminate noise and extract meaningful frequency bands from EEG signals. In addition, some improved FFT techniques such as short-time Fourier transform (STFT) to transform EEG signals to 2D images for application to CNNs have been investigated in research (Samiee et al., 2014). Also, some studies have selected independent component analysis (ICA)-based techniques to preprocess the EEG signals of epileptic



seizures and have achieved satisfactory results (LeVan et al., 2006). Feature extraction procedures have also been considered in research as a crucial step in high-level preprocessing (Shoeibi et al., 2021).

### **C. Medical Imaging Modalities Preprocessing**

Medical imaging modalities are another method of diagnosing epileptic seizures that possesses a special place among specialist physicians. In imaging techniques, applying preprocessing techniques is of great significance. According to Table 3, epileptic seizure detection using MRI modalities is more significant than other techniques. MRI neuroimaging modalities contain structural (sMRI) and functional (fMRI) techniques (Khodatars et al., 2020a). In sMRI modalities, the most important low-level preprocessing techniques include denoising, inhomogeneity correction, brain extraction, registration, intensity standardization, and re-orientation (Manjón, 2017; Park et al., 2019). Also, slice timing correction, motion correction, normalization, smoothing, and filtering are the most important low-level fMRI preprocessing methods (Jaber et al., 2019; Behroozi et al., 2011). Some of the high-level preprocessing methods that have been surveyed in investigations for sMRI and fMRI modalities are segmentation (Makropoulos et al., 2018) and functional connectivity matrix (FCM) (Luo et al., 2011), respectively. Other research has focused on using PET imaging modality for diagnosis (Jiang et al., 2019a; Shiri et al., 2019). ROI, normalization, Ordered subset expectation maximization (OSEM), and down-sampling are some of the PET modality preprocessing methods (Jiang et al., 2019a; Shiri et al., 2019).

### **D. Other Modalities Preprocessing**

fNIRS and ECoG are two other modalities for functional neuroimaging of the brain employed by researchers for epileptic seizures detection (Modir et al., 2017; Sirpal et al., 2019; Chen et al., 2017b). Essential preprocessing steps in these modalities are similar to those of EEG signals and include noise reduction, normalization, and windowing of signals.

#### *3.2.2. Review of Deep Learning Techniques*

In recent years, with the increased availability of large datasets, methodologies rooted in DL techniques are poised for making a significant improvement in the diagnosis of various neurological disorders, including epileptic seizures. The DL-based CAD systems enable physicians to make better-informed decisions

based on the recorded patient neuroimaging modalities. Figure 5 illustrates different types of DL architecture. It shows that CNNs (Goodfellow et al., 2016), GANs (Goodfellow et al., 2014), RNNs (Goodfellow et al., 2016), AEs (Goodfellow et al., 2016), DBNs (Hinton, 2009), CNN-AE (Chen et al., 2017a), and CNN-RNN (Keren and Schuller, 2016) are the main DL architectures used for epileptic seizures detection. Among those, 2D-CNN and 1D-CNN are the most widely used DL architecture in the field of epileptic seizures (Tables 2 and 3). This is due to the impressive achievements of CNNs architectures in other fields, including biomedical signal processing and medical imaging. In the rest of this section, we review the major DL network architectures and their variants.

### A. 1D and 2D-CNNs

The idea of using neural net like algorithms has been around for decades, yet many limitations have stopped them from being useful in machine learning. With the famous AlexNet paper (Goodfellow et al., 2016), neural nets have resurfaced once again in the past decade. Adding some knowledge to the network structure, i.e., the fact that patterns are presented in spatial localities, led to convolutional layers, and by fixing the convolutional filters, the decrement in parameters made it possible for networks to train properly (Goodfellow et al., 2016; Khodatars et al., 2020b; Sharifrazi et al., 2021). 2D-CNNs have been widely used since their first introduction, and their variant, 1D-CNNs, have also been applied vastly for signal processing tasks (Giudice et al., 2020; Bird et al., 2021). Figure 7 shows a general form of a 2D-CNN used for epileptic seizure detection.

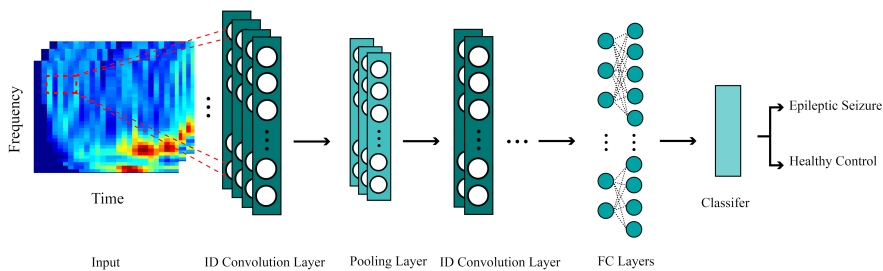

Figure 7: A typical 1D-CNN for epileptic seizure detection.

### B. Generative Adversarial Networks (GANs)

In 2014, Goodfellow et al. (Goodfellow et al., 2016) revolutionized the field of generative models by introducing Generative Adversarial Nets (GANs). The main contribution of GANs is their capability of generating high-quality images similar to the training dataset; GANs have been applied to signal (Hazra and Byun, 2020; Abdelfattah et al., 2018), image (Schlegl et al., 2019; Yang et al., 2017), and many other data types in the past years (Ghassemi et al., 2020). Given the quality of generated data, GANs can be used for data augmentation and model pre-training (Goodfellow et al., 2016), helping to overcome one of the main issues in biomedical machine learning, the limited size of datasets. The general GAN architecture is shown in Figure 8.

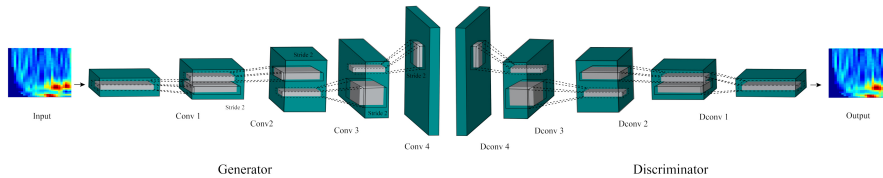

Figure 8: A typical GAN architecture for epileptic seizure detection.

### C. Pre-Train Networks

Deep neural nets usually have a tremendous amount of parameters; thus, they require enormous datasets for proper training. This is generally challenging in biomedical data processing due to small dataset sizes. However, one method used commonly to overcome this issue is to fine-tune previously trained networks. In this method, first, a DNN is trained on a big dataset, such as ImageNet, then the last layer, classifier, is removed. After that, as illustrated in figure 9, its weights are fine-tuned using the primary dataset, or it is merely used as a feature extractor (Goodfellow et al., 2016).

#### ALEXNET

As the first famous DL network, AlexNet is still the center of attention in many studies (Iandola et al., 2016). In this network, two new perspectives dropout, and local response normalization (LRN), are used to help the network learn better. Dropout is applied in two FC layers employed in the end. On the other hand, LRN, utilized in convolutional layers, can be employed in two different ways: Firstly, applying single channel or feature maps, where the same

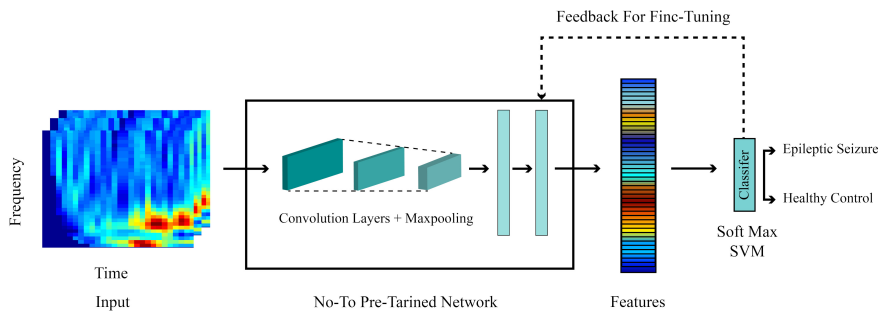

Figure 9: A typical deep pre-train network for epileptic seizure detection.

feature map normalizes depending on the neighborhood values and selects the  $N \times N$  patch. Secondly, LRN can be exploited across the channels or feature maps (Goodfellow et al., 2016; Iandola et al., 2016).

### VGG

Created by Visual Geometry Group in 2014, VGG is one of the pioneers of deep neural net structures; however, this famous structure is still extensively used and popular among researchers (Wang et al., 2015). Many argue that this is due to its straight forward design and also ease of applying this network for transfer learning (Wang et al., 2015). Two variants of VGG are mostly used for transfer learning, namely, VGG-16 and VGG-19 (number stands for the number of layers); also, they are applied in various fields, ranging from face recognition (Sun et al., 2015) to brain tumor classification (Sajjad et al., 2019).

### GOOGLENET

Different receptive fields, generated by various kernel sizes, form layers called "Inception layers," which are the building block of these networks. Operations generated by these receptive fields find correlation patterns in the novel feature map stack (Ballester and Araujo, 2016). In GoogLeNet, a stack of inception layers is used to enhance recognition accuracy. The difference between the final inception layer and the naïve inception layer is the inclusion of  $1 \times 1$  convolution kernels, which performs a dimensionality reduction, consequently reducing the computational cost. Another idea in GoogleNet is the gradient injection, which aims to overcome the gradient vanishing problem. GoogLeNet comprises a total of 22 layers that is greater than any previous network. However, GoogLeNet uses much fewer parameters compared to its predecessors VGG or AlexNet (Ballester

and Araujo, 2016; Goodfellow et al., 2016).

## RESNET

The idea behind ResNet was to overcome the issue of vanishing gradient by utilizing skip connections between blocks. This allowed the Residual nets to go deeper than regular networks; many varieties of these networks, with various sizes, such as 34, 50, and 152 have been created and applied in many tasks (Targ et al., 2016). ResNet’s main contribution was not the network or its state-of-the-art performance, but the network’s building blocks, and similar blocks have been widely used in many other deep NN structures; as an example, Res2Net is an image segmentation network with a similar design to ResNet.

### D. 3D-CNN

To overcome this, 3D-CNN was introduced. In 2D-CNN, many well-known structures such as VGG and GoogLeNet are available as a great starting point to construct the new structure upon them. However, creating 3D-CNNs can be challenging, considering there are not many famous 3D-CNN structures (Zhao et al., 2019; Kwak et al., 2020). Nevertheless, designed and trained properly, 3D-CNNs can find 3D patterns and achieve state-of-the-art performances. A typical 3D-CNN for epileptic seizure detection is shown in figure 10.

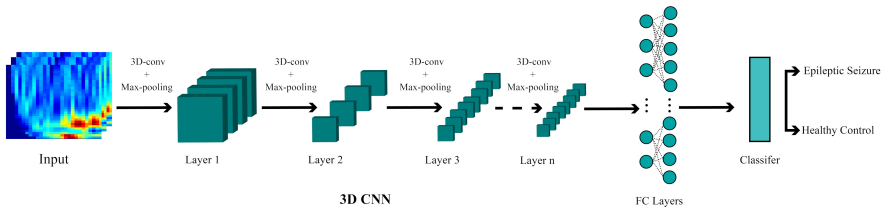

Figure 10: A typical 3D-CNN for epileptic seizure detection.

### E. Recurrent Neural Networks (RNNs)

Many data forms, such as signal, have embedded patterns that cannot be characterized by local or spatial patterns. To create a model suitable for these datasets, researchers have created recurrent neural nets that, as stressed by the name, use the same group of neurons with a recurring scheme to process these data properly. Few variants of these networks, such as LSTM (long short term memory) and GRU, are created to find local and global patterns efficiently (Li et al., 2018; Hsu et al., 1990). The standard type of these networks is usually

used as a baseline for creating models on signal processing and time-dependent datasets (Khalifa et al., 2020; Zihlmann et al., 2017). However, a combination of these networks with convolutional layers is popular among researchers aiming to reach high performances with more complex models. A typical RNN for epileptic seizure detection is shown in figure 11.

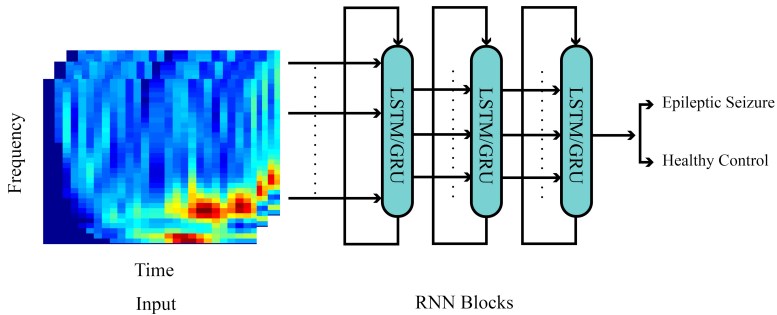

Figure 11: A typical RNN for epileptic seizure detection.

## F. Deep Belief Networks (DBNs)

Restricted Boltzmann Machine (RBM), the building block of Deep Boltzmann Machine (DBM), is an undirected graphical model (Hinton, 2009). The unrestricted Boltzmann machines are also similar; however, they may also have connections between the hidden units. DBNs are unsupervised probabilistic hybrid generative DL models comprising of latent and stochastic variables in multiple layers (Hinton, 2009). Moreover, a variation of DBN is called Convolutional DBN (CDBN), which is more suitable for images and signals, as it uses the spatial information of data (Krizhevsky and Hinton, 2010).

## G. Autoencoders

AEs were one of the first groups of neural networks with practical use in machine learning (Goodfellow et al., 2016). Even with new advancements in DL, AEs have never lost researchers' attention and are widely used for dimensionality reduction and representation learning. The main idea behind AE is to map data to a smaller latent space and then back to the starting space with a minimum loss, thus reaching a mechanism to preserve essential aspects of data while reducing its dimensionality. Nowadays, many variations of AEs have

been introduced with the goal of improving the base AE performance, such as stacked AE (SAE), denoising AE (DAE), and sparse AE (SpAE) (Sønderby et al., 2016; Bank et al., 2020; Holden et al., 2015). A typical AE for epileptic seizure detection is shown in figure 12.

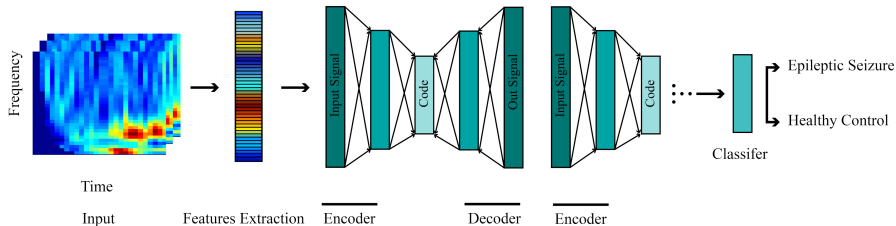

Figure 12: A typical AE for epileptic seizure detection.

## H. CNN-RNN

To combine RNNs and CNNs, researchers usually use convolutional layers in the first layers of the model to extract features and find local patterns, and they feed the output of these layers to RNNs to use their superiority for global pattern recognition (Keren and Schuller, 2016). The reasoning behind the noble performances of these models is a two-fold. First, convolutional layers empirically find local and spatial patterns considerably better than RNNs in signals. Second, adding convolutional layers allows RNN to see data with stride, hence finding more distanced patterns. By combining the output of convolutional layers and handcrafted features, CNN-RNNs are allowed to reach a state-of-the-art performance, in addition to learning a representation of data that overcomes handcrafted features' deficiencies (Keren and Schuller, 2016). A typical CNN-RNN for epileptic seizure detection is shown in figure 13.

## I. CNN-AE

Convolutional Autoencoder, or CNN-AE, is a DL based model that uses superiorities of convolutional layers to learn a representation of input unsupervised (Chen et al., 2017a). Base AEs are not suitable for raw representation learning, i.e., learn a representation of data without any added knowledge. This is due to the large number of learnable parameters that stops the network from learning anything useful. However, using convolutional layers, parameters are



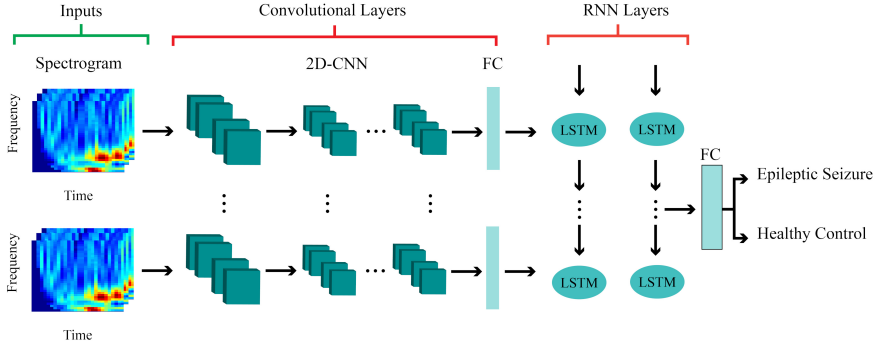

Figure 13: A typical CNN-RNN for epileptic seizure detection.

reduced dramatically, and networks can be appropriately trained (Chen et al., 2017a). A combination of this model with other ones, such as DAE, can lead to complex models with state-of-the-art performances (Li et al., 2015; Makhzani et al., 2015). A typical CNN-AE for epileptic seizure detection is shown in figure 14.

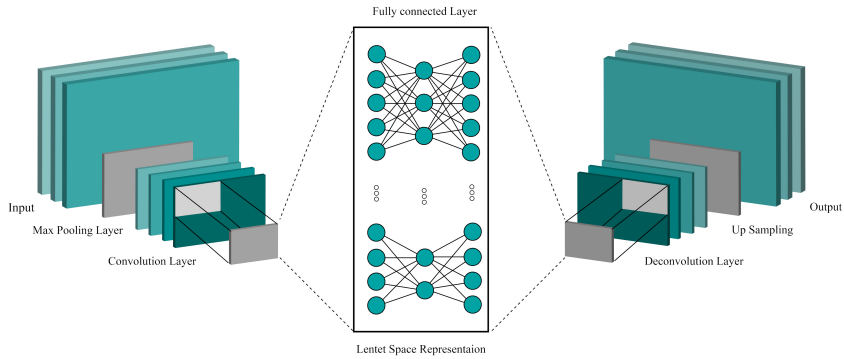

Figure 14: A typical CNN-AE for epileptic seizure detection.

### 3.2.3. Other Neuroimaging Modalities for Epileptic Seizure Detection

#### A. Medical Imaging

In the medical imaging literature, many researchers have focused on the application of fMRI, sMRI, and PET modalities for epileptic seizure detection using DL methods. sMRI and fMRI neuroimaging modalities are more popular than PET among physicians and neurologists for detecting epileptic seizures

(van Lanen et al., 2021; Ma et al., 2020). This has led to more research papers be conducted on fMRI and sMRI modalities for epileptic seizures detection. Therefore, we summarize the relevant works that leverage various PET and MRI-based modalities in table 3.

### **B. EEG-fMRI**

Multimodal neuroimaging techniques give physicians very detailed information about the type of neurological disorders and their location on the brain. As such, it is essential to use these modalities to identify the central location (focus) of epilepsy in the brain. EEG-fMRI is one of the best multimodal techniques for epileptic seizures detection (Gotman, 2008; Ebrahimzadeh et al., 2019). The modality of EEG-fMRI along with the ResNet network was investigated for epileptic seizures detection in (Hao et al., 2018). In the proposed ResNet architecture, the Softmax and Triplet functions are used for supervised classification, achieving 84.40% specificity.

### **C. EEG - fNIRS**

fNIRS uses infrared waves to monitor changes in blood oxygen levels in the brain, allowing imaging and analysis of active brain areas (Pouliot et al., 2012). In this method, using special electrodes on the scalp, variations in oxy-hemoglobin (HbO) and deoxy-hemoglobin (HbR) are measured, which can be helpful in diagnosing a variety of brain diseases. In (Mao et al., 2020), EEG-fNIRS combination modalities have been employed to detect epileptic seizures. The proposed LSTM-based based approach, with a Softmax classifier as the last layer, achieved 98.30% accuracy in their case study.

### **D. ECoG**

RaviPrakash et al. (RaviPrakash et al., 2020) introduced an algorithm based on DL for Electro-corticography based functional mapping (ECoG-FM) for eloquent language cortex identification. ECoG-FM's success rate is low compared to Electro-cortical Stimulation Mapping (ESM). The algorithm showed an improvement of 34% over the existing ECoG-FM method with an accuracy of approximately 89%. ECoG-FM method coupled with DL has the potential for state-of-the-art performances. This method can help the surgeons performing epilepsy surgery by removing the ESM hazards. Also, in part of the (Hosseini et al., 2017), an ECoG modality has been considered for the detection of epileptic

seizures. 2D-CNN and SVM were used for feature extraction and classification steps, respectively.

### **E. MEG**

MEG is a functional neuroimaging technique used to evaluate and analyze the structure of the brain to diagnose a variety of brain disorders. Due to its high operational costs, it is only used in exceptional cases. (Zheng et al., 2019) Proposed a new technique, EMS-Net, for detecting epileptic spikes from MEG modality, with satisfactory results.

## **4. Rehabilitation Systems Based DL Techniques**

In recent years, research in the field of design and construction of rehabilitation systems aimed at assisting people with a variety of neurological disorders has advanced significantly. Rehabilitation systems are of particular significance to assist patients. The major objective of these systems is to achieve real and accessible tools for different patients. These systems are important in two aspects: First, they continuously monitor the patient's condition and, in the occurrence of disease, perform some necessary work to improve the disease. In the second case, there is another category of these systems that constantly report the patient's vital signs to the specialist so that the patient is at lower risk of disease. In this section, various rehabilitation systems are presented to help patients with epileptic seizures. These tools include programs to diagnose epileptic seizures from non-medical modalities (Ahmedt-Aristizabal et al., 2018a; Achilles et al., 2018), Brain Computer Interface (BCI) systems (Hosseini et al., 2016), Implantable (Kiral-Kornek et al., 2018), and Cloud-Computing (Singh and Malhotra, 2018; Ali et al., 2020; Amin et al., 2019; Alhussein et al., 2018) are discussed below.

### *4.1. Non Neuroimaging Modality for Epileptic Seizure Detection*

In a study by Ahmedt et al. (Ahmedt-Aristizabal et al., 2018a), facial images have been used to diagnose epileptic seizures. To collect the dataset, epileptic patients were monitored for 2 to 7 days, and eventually, 16 patients with MTLE were randomly selected from the general data set by default. The DL architecture in this investigation is CNN-RNN and, the results reveal that they have achieved promising results.

#### *4.2. Brain Computer Interface*

BCI based on DL to detect epileptic seizures has been recommended in Hosseini et al.'s study (Hosseini et al., 2016). In the proposed technique, SSAE and Softmax methods have been exploited to perform feature extraction and classification steps, respectively. In this study, they achieved 94% accuracy.

#### *4.3. Implantable Based DL*

Kiral-Kornek et al. (Kiral-Kornek et al., 2018) proposed an online and wearable system in the body for epileptic seizures detection based on DL. The proposed system has low power consumption, long life, and high reliability. In the proposed approach system, the DL method is trained to distinguish pre-ictal signals from ictal and has a sensitivity of 69%.

#### *4.4. Cloud Computing Based DL for Epileptic Seizures Detection*

With the advancement of information technology, performing heavy computational tasks at different times and places becomes a necessity. There is also a need for people to be able to easily fulfill their heavy computing tasks without owning expensive hardware and software. Cloud computing plays an important role in allowing users to process various data and store information outside of personal computers. The advantages of cloud computing have led to its accelerated application in various medical fields. An overview of cloud computing to help diagnose epileptic seizures is exhibited in Figure 15. In the epileptic seizure detection field, research has been carried out using cloud computing, which we will describe below (Singh and Malhotra, 2018; Ali et al., 2020; Amin et al., 2019; Alhussein et al., 2018; Muhammad et al., 2018).

##### *4.4.1. Cloud System Design Based DL and Smartphone*

Singh et al. (Singh and Malhotra, 2018) developed a commercial product for epileptic seizures detection, which involves user and cloud sections. The user section includes EEG headset, smartphone, WiFi system or, 4G network. The cloud segment also contains the dataset and the SAE algorithm for classifying EEG signals. EEG signals are recorded via a 14-channel Bluetooth headset and then transmitted to the patient's smartphone. Then, Android-based software transmits the recorded data to the cloud via WiFi or 4G internet connection. If

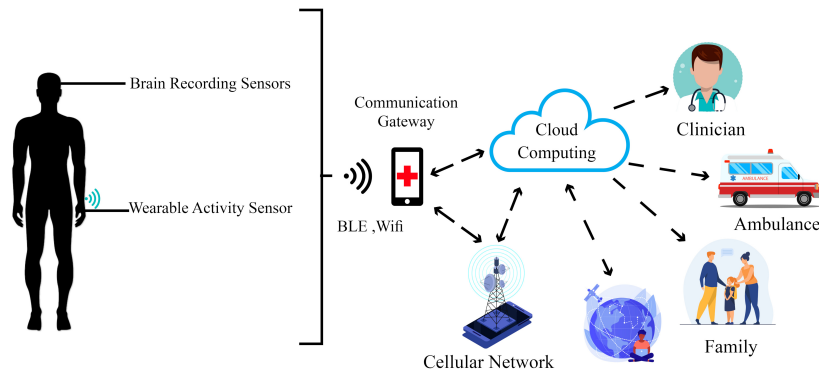

Figure 15: Cloud computing in helping patients with epileptic seizures.

the output of the classifier is pre-ictal, an alarm message containing the patient's geographical location is sent by the alarm system to the patient's telephone, family members' telephone, and the nearest hospital.

#### 4.4.2. Cloud System Based DL and Mobile Edge Computing

Ali et al. (Ali et al., 2020) used the combination of DL with mobile edge computing to detect epileptic seizures. The objective of Edge Computing is to lessen the communication load of the cloud server and the edge device, which is specifically the main focus of this article. The proposed design assumes that the data has already been recorded and provided to the edge device, which is mobile. Next, receiving the raw data by mobile phone, they are partially processed and then sent to the cloud. Other processes continue to epileptic seizures detection in the cloud, and then the result is sent to the mobile phone.

#### 4.4.3. IoT Based Healthcare

An IoT-based healthcare framework and DL to help patients with epileptic seizures are introduced in (Amin et al., 2019; Alhussein et al., 2018). In (Amin et al., 2019), the function of two adopted cloud systems is employed, one of which sends EEG signals, and the other sends other vital information such as movements and emotions. With the cognitive module, the patient's vital signs are supervised online and then fed to the CNN network input. Finally, patient status and EEG signal analysis results are shared with medical providers. In the recommended approach, emergency help is provided if the patient is in critical

condition.

#### 4.4.4. Mobile Multimedia Framework

In a study by Muhammad et al. (Muhammad et al., 2018), a technique based on mobile multimedia healthcare was proposed to help patients with epileptic seizures. In the proposed method, DL and the CHB-MIT dataset are utilized to detect epileptic seizures. Finally, the algorithms adopted are implemented on a module. Experimental results show the achievement of 99.02% accuracy and 92.35% sensitivity parameters.

## 5. Discussion

Today, many people worldwide suffer from epileptic seizures, and their daily activities are faced with serious challenges. So far, numerous clinical and screening procedures have been proposed to treat and diagnose epileptic seizures. Among the screening methods, EEG, fMRI, sMRI, and PET modalities are more important for epileptic seizures detection for physicians than other techniques. Applying DL techniques and neuroimaging modalities are crucially significant in epileptic seizure detection. In this paper, conducted researches on the diagnosis of epileptic seizures using DL methods are studied. Also, in the papers reviewed, practical applications in this field have been mentioned.

Diagnosis of epileptic seizures based on EEG modalities as well as medical imaging techniques are summarized in Tables 2 and 3. These tables provide each research information, including dataset, modality, preprocessing techniques, DL network input, DL network, classification algorithm, K-Fold evaluation, and finally, various evaluation parameters.

The most important datasets available used for diagnosing epileptic seizures are provided in Table 1. It is observable that the majority of them take advantage of EEG modalities. The total number of datasets utilized in epileptic seizure investigations is shown in Figure 16. As can be observed, the Bonn dataset is the most widely used by researchers. This is because this database is preprocessed and can be easily employed for research.

Different neuroimaging modalities are applied to diagnose epileptic seizures. Detailed information on the types of neural modalities for diagnosing epilep-



Figure 16: Number of studies published for epileptic seizures detection using different datasets.

tic seizures is given in the diagram 17. According to diagram 17, the sEEG modality has dedicated to itself the highest use in the research. This is due to the non-invasive nature of the sEEG modality, which exposes patients to fewer risks. Moreover, according to Figure 17, IEEG modality is considered the second epileptic seizures detection approach.

Numerous tools have been proposed to implement a variety of DL architectures, the main objective of which is to facilitate the simulation of these networks. Matlab, Keras, TensorFlow, PyTorch, Caffe, and Theano are the most well-known tools for the implementation of DL networks (Peng et al., 2016; Nguyen et al., 2012). The number of times each DL tool is used for epileptic seizure detection is illustrated in Figure 18. The TensorFlow and Keras libraries are widely applied due to their continuous updating, high flexibility, and ease of use in implementing CADs epileptic seizures.

In tables 2 and 3, the DL network types are discussed for epileptic seizures detection based on neuroimaging modalities. A variety of CNN models in various medical applications, especially the diagnosis of epileptic seizures, have reached promising results. Figure 19 display the total number of DL techniques for epileptic seizures detection.

Also, figure 19 shows the number of annual researches on the utilization of DL networks for epileptic seizures detection. Based on Figure 19, the researchers

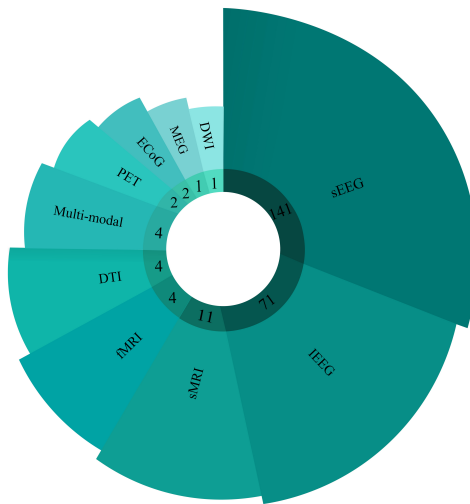

Figure 17: Number of studies published for epileptic seizures detection using different neuroimaging modalities.

have concentrated on different models of 2D-CNN and 1D-CNN. CNN architectures discover local spatial dependencies well; thus, these networks can be used to extract the necessary patterns from various modalities, including EEG signals. Furthermore, the patterns that CNNs learn are unchanged from relocation, and on the other hand, they can well train the hierarchy of feature space. In this article, not only the type of DL network in each research is discussed, but also in the table 4, the implementation details of DL networks in each research are mentioned.

Classification algorithms are the last part of the DL network. Figure 20 shows the number of classification algorithms used in DL networks based on Tables 2 and 3. As can be seen, the Softmax algorithm (Zeng et al., 2014) is the most popular in DL applications as a classification approach. Regarding the superiority of Softmax compared to other classifiers such as SVM (Noble, 2006), we can remark its easy derivability, which makes it possible to apply it in the backpropagation algorithm. Also, compared to gradient descent methods, such as exploiting Sigmoid for classification purposes, Softmax provides better performance due to the weights normalization between different classes.



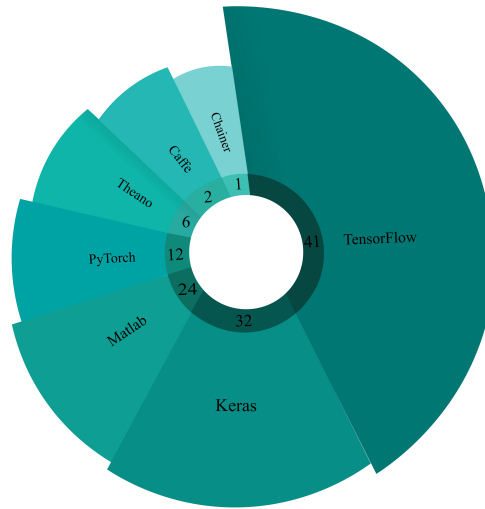

Figure 18: Number of DL tools used for epileptic seizures detection based on the published papers.

## 6. Challenges

In this section, the challenges in epileptic seizures diagnosis using DL techniques have been described. The most important challenges concerning datasets, DL methods, and hardware resources are explained in detail below.

Available datasets for diagnosing epileptic seizures are mostly EEG type. However, available datasets from other functional and structural neural modalities have not been provided for investigations until now. For example, the fNIRS modality is one of the most inexpensive and most accurate procedures to diagnose a variety of neurological disorders (Tak and Ye, 2014; Peng et al., 2014). The lack of available fNIRS datasets for the diagnosis of epileptic seizures has given rise to confined research in this field. Additionally, sMRI and fMRI modalities are recognized as some of the most significant and accurate tools for diagnosing brain disorders (Del Gaizo et al., 2017; Bharath et al., 2019). So far, no dataset on sMRI or fMRI modalities has been made freely available to researchers for epileptic seizures detection. Multimodality techniques such as EEG-fMRI or EEG-fNIRS have been investigated in the diagnosis of mental and neural disorders and, noteworthy results have been achieved (Zijlmans et al., 2007; Kowalczyk et al., 2020; Peng et al., 2016; Nguyen et al., 2012). In

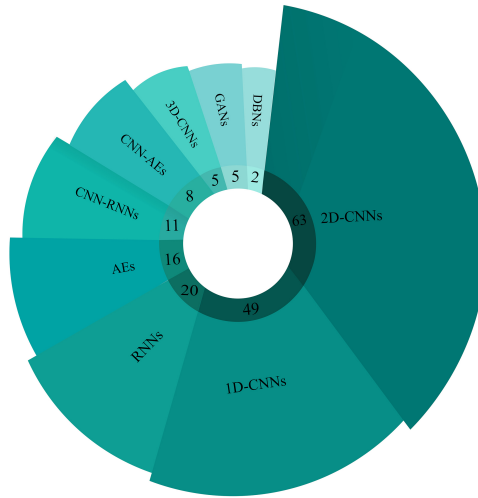

Figure 19: Number of DL architectures used for epileptic seizures detection based on published papers.

order to diagnose epileptic seizures using multimodality approaches, insufficient research has been performed, the main reason being the deficiency of available and free datasets.

Available EEG datasets commonly follow two approaches to distinguishing seizures from normal or when they occur. However, there are different types of epileptic seizures, and diagnosing their type is a troublesome task for physicians. Therefore, contributing datasets with functional or structural neuronal modalities to diagnose different types of epileptic seizures is profoundly felt.

Regarding the utilization of DL models for epileptic seizures detection, several challenges must be examined before implementing these models for clinical applications. The first challenge of this category is the extensiveness and differences of seizure patterns in signals. This issue leads to collect very large datasets to make these models more robust to new patterns or a more feasible solution to apply few-shot learning techniques to improve these models' robustness. Another challenge is to investigate the transferability of the model implemented on various datasets. Various studies have succeeded in achieving very high accuracy on particular datasets, but before adopting these models in real-world applications, their performance requires to be evaluated with a different distribution of the training data. The final challenge in this scope is the lack of

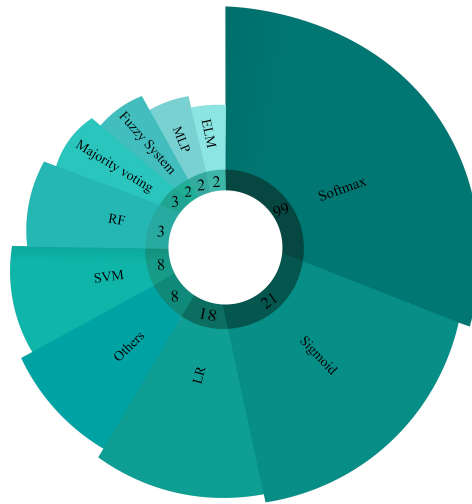

Figure 20: Illustration of the number of various classifier algorithms used in DL networks for automated detection of epileptic seizures.

networks with a dedicated structure for diagnosing epileptic seizures performing as a benchmark. In the image processing field, networks such as VGG and AlexNet have served as benchmarks and, in addition to providing researchers with a highly effective evaluation tool, allowing them to easily track their work to evolve and improve on previous work, while most of the networks used in this field are modified derivatives of networks presented for ImageNet and not specifically designed to diagnose epileptic seizures.

The following challenges category refers to the presentation of rehabilitation systems in the diagnosis of epileptic seizures with the help of DL. Unfortunately, much concentration has not been carried out on designing rehabilitation systems like BCI. In some research papers, cloud computing technologies, IoT and, Healthcare have been studied to address the difficulties of patients with epileptic seizures using neuroimaging modalities. The most substantial research challenges in this field are the deficiency of multimodality datasets for these systems' better performance.

Furthermore, dedicated hardware design platforms for this research have not been yielded till then, which is another challenge. To date, most researchers have developed the hardware implementation of conventional machine learning algorithms to detect epileptic seizures timely. This issue has led to these hardware

circuits can not be employed for epileptic seizures detection seriously. Hardware implementation of DL algorithms to diagnose epileptic seizures can give specialist physicians the hope that they can accurately and real-time diagnose epileptic seizures and their type. Hardware implementation of DL algorithms on field-programmable gate array (FPGA), application-specific integrated circuit (ASIC), etc. can address many difficulties and challenges for medical professionals. However, when designing hardware based on DL, a number of existing challenges can be addressed, such as reducing hardware resources, minimizing power consumption, and so on.

## 7. Conclusion and Future Works

Early detection of epileptic seizures is of particular importance to specialist physicians, and research in this field has grown significantly in recent years. In this paper, a comprehensive review of the diagnosis of epileptic seizures using neuroimaging modalities coupled with DL methods has been performed. In the discussion section, it was observed that sEEG datasets are most applied in epileptic seizures detection. In another section, it was perceived that different models of DL have been employed to diagnose this type of neurological disorder, among which CNNs have the highest number of studies. In most investigations, small datasets have often been used to diagnose epileptic seizures alongside pre-train deep networks. To improve the performance of these DL networks, it is better to provide a comprehensive dataset of medical signals. This enhances the performance of pre-train deep networks for diagnosing epileptic seizures. Increasing the efficiency and accuracy of CAD systems in epileptic seizures detection is of particular significance, but aforementioned, the data deficiency is a serious challenge. Another novel field for research is applying Zero-Shot learning techniques, which can result in promising results for the implementation of real epileptic seizure detection systems.

In another part of the paper, the types of hardware and applied programs for detecting epileptic seizures were presented. Cloud Computing, IoT, Healthcare, and wearable implants have recently been introduced coupled with DL techniques to aid people with epileptic seizures, and it is encouraging that more applied research will be conducted in the near future. Lack of adequate hard-

ware resources is another reason hardening the practical implementation of these systems. For future work, it is expected that CADs based on DL will be implemented on a variety of dedicated hardware such as FPGA and ASIC for epileptic seizures detection.

Responsive neurostimulation (RNS) and vagus nerve stimulation (VNS) diagnostic systems are a type of invasive implants that can be implanted in the human body and are programmed to detect and neutralize the onset of epileptic seizures (Fisher, 2012; Skarpaas et al., 2019). These systems still have open problems in accurately diagnosing epileptic seizures. Enhancing the accuracy of RNS and VNS based diagnosis and treatment systems based on DL techniques can be noteworthy as one of the future tasks.

Another procedure of diagnosis and prediction is from other vital human signals such as the heart. Designing and manufacturing invasive and non-invasive implants based on other vital signals of the human body along with DL methods is another recommendation for future work.

In addition to other future directions, the use of more sophisticated methods in deep neural networks can itself be a path for future works. The use of deep metric (Schroff et al., 2015) methods to increase the informativeness of learned representations, few-shot learning (Sung et al., 2018) methods and scalable networks (Tan and Le, 2019) for small dataset tasks, and newer data augmentation methods such as simple copy-paste (Ghiasi et al., 2020) can all be investigated.

Table 2: Summary of DL methods employed for automated detection of epileptic seizures.

Work	Dataset	Modality	Preprocessing		Input Network	Deep Tools	Network	K-fold	Classifier	Performance Criteria (%)			
			Low Level	High Level						ACC	Sens	Spec	F1-S
(Antoniades et al., 2016)	Clinical	IEEG	Standard Preprocessing	Spectrogram	2D Spectrograms	NA	2D-CNN	–	LR	87.51	–	–	–
(Qin et al., 2020b)	CHB-MIT	sEEG	Segmentation	STFT	2D Spectrograms	PyTorch	2D-CNN	–	ELM	95.65	95.85	–	–
(Park et al., 2018)	SNUH	sEEG	Segmentation, Filtering	DA	Preprocessed Data	NA	1D with 2D-CNN	–	Sigmoid	90.58	89.20	91.90	–
	CHB-MIT	sEEG											
(Tjepkema-Cloostermans et al., 2018)	Clinical	sEEG	Filtering, Down-Sampling	–	the preprocessed 2 s epochs	Keras Theano	2D-CNN	–	Softmax	–	47.40	98.00	–
(Avcu et al., 2019)	Clinical	sEEG	Down Sampling, Z-Normalization	DA	Preprocessed Data	Keras	SeizNet	–	NA	–	95.80	–	–
(Zhan and Hu, 2020)	Freiburg	IEEG	–	Fourier Transform (FT), Wavelet Transform (DWT)	Spectrograms, Time Domain Signal, and Time Frequency Signal	NA	DCNN	NA	Multi-view Fuzzy Clustering	97.38	96.26	–	–
(Nejedly et al., 2019)	Clinical	IEEG	Z-Normalization	STFT	Raw IEEG Signals Spectrogram Images	PyTorch	CNN	–	Softmax	–	79.00	–	–
(Hossain et al., 2019)	CHB-MIT	sEEG	–	Visualization	Raw EEG as 2D Array	PyTorch	2D-CNN	–	Softmax	98.05	90	91.65	–
(Mao et al., 2020)	UCI	sEEG	–	CWT	2D Scalograms	MATLAB	2D-CNN	–	Softmax	72.49	–	–	–
(Zuo et al., 2019)	Clinical	IEEG	Filtering, Normalization	Visualization	Input Images 4*1,024 Pixels in Size	NA	2D-CNN	10	Softmax	87.65 90.83	83.23 77.04	79.36 72.27	– –
(Asif et al., 2019)	TUH	sEEG	–	DivSpec	3D Visual Representation	PyTorch	SeizureNet	5	Softmax	–	–	–	90
(Iešmantas and Alzbutas, 2020)	TUH	sEEG	Feature Extraction	–	Pattern Matrices	TensorFlow	2D-CNN	10	Softmax	74	68	67	–
(Zeng et al., 2021)	Bonn	sEEG and IEEG	Filtering, Segmentation using FNSW	Conversion Module (GRP Transformation)	2D-GRPs	TensorFlow	GRP-DNet	10	Majority Voting	100	–	–	–
(San-Segundo et al., 2019)	Bern Barcelona	IEEG	Filtering	EMD, FWT, FT	Raw IEEG Signals	Keras	2D-CNN	5	Sigmoid	99.80	–	–	–
	Clinical	sEEG			IMFs				Softmax				
					Wavelet Coefficients								
					Module Values								
(Sui et al., 2019)	Bern Barcelona	IEEG	Z-Normalization	STFT	2D Spectrograms	TensorFlow	2D-CNN	10	Softmax	91.80	–	–	–
(Chatzichristos et al., 2020)	TUH	sEEG	Multi-Channel Subspace Filters	IC Label	Raw EEG Signals	NA	Multiple Attention-Gated U-Net	10	Bi-LSTM + FC Layer	–	–	–	–
					Subspace Filtering								
					ICLabel								
(Covert et al., 2019)	Clinical	sEEG	–	STFT	2D Spectrograms	NA	TGCN	–	Sigmoid	92.80	–	–	–
(Akut, 2019)	Bonn	sEEG and IEEG	–	DWT	Wavelet Coefficients	NA	2D-CNN	–	Sigmoid	100	100	100	–

(Türk and Özerdem, 2019)	Bonn	sEEG and IEEG	–	CWT	2D Scalograms	Keras	2D-CNN	10	Softmax	100	100	100	–
(Liu and Woodson, 2019)	Bonn	sEEG and IEEG	Filtering	–	Black and White Plots of The Amplitude Scaled Wave Files	MATLAB	2D-CNN	–	Softmax	99.60	–	–	–
(Tian et al., 2019)	CHB-MIT	sEEG	Over Sampling Method	FFT, WPD	Time Domain	MATLAB	2D-CNN	5	MV-TSK-FS	98.33	96.66	99.14	–
					Frequency Domain	TensorFlow	3D-CNN						
(Bouaziz et al., 2019)	CHB-MIT	sEEG	Segmentation	Spatial Representation by Producing A Set of Intensity Images	2D Data	NA	2D-CNN	–	Softmax	99.49	–	–	99.49
(Prasanth et al., 2020)	Clinical	sEEG	Down-Sampling, Filtering, Artifact Rejection Based on Noise Statistics, Decomposition, Segmentation	–	Combination of Raw EEG and Frequency Sub-Bands	NA	1D-CNN, 2D-CNN	5	NA				
(Ansari et al., 2019)	Clinical	sEEG	–	Different Methods	2D Data	MATLAB	2D-CNN	10	Sigmoid RF	89.00	82.00	90.00	–
(Cao et al., 2019)	CHB-MIT	sEEG	–	Sub-band Mean Amplitude of Spectrum (MAS) Map of Multi-channel EEGs	MAS Map Image	NA	SCNN (4 CNNs)	5	AWF fusion scheme, KELM classification	99.33	–	–	–
	Clinical									98.86	–	–	–
(Taqi et al., 2017)	Bern Barcelona	IEEG	NA	–	2D Data	Caffe	AlexNet	–	Softmax	100	–	–	–
							GoogleNet						
							LeNet						
(Emami et al., 2019b)	Clinical	sEEG	Filtering, Segmentation	Visualization	2D Data	Chainer	2D-CNN	–	Softmax	80	–	–	–
(Bizopoulos et al., 2019)	UCI	sEEG	–	Signal2Image	2D Data	PyTorch	2D one-layer CNN	–	DenseNet	85.30	–	–	–
(Thanaraj et al., 2020)	Bern Barcelona	IEEG	Segmentation	GASF, DA	GASF Images	MATLAB	Different Pre-Train Networks	–	Softmax	92.00	–	–	–
			–	Textural Features Extraction from the GASF Images, PSO Feature Selection	Different Features	Keras	Deep ANN						
						TensorFlow							

(Zhang et al., 2020a)	CHB-MIT	sEEG	Segmentation, Resizing	STFT	2D Spectrograms	NA	VGG-16 VGG-19 ResNet-50	-	Softmax	98.26	-	-	-
(Cho and Jang, 2020)	Clinical	IEEG	Segmentation, Down-Sampling, Raw EEG time series	Periodogram, STFT Gray Image, Black and White Image of Raw EEG Waveform, Concatenation of 3 Black and White images	Raw EEG Signals	TensorFlow	2D-CNN	10	NA	99.90	96.70	99.90	-
					Periodogram								
					2D Spectrograms								
					40 X 250 Image of EEG Signals								
					40 X 750 Image of EEG Signals		LSTM						
(Liu et al., 2020a)	Freiburg	IEEG	Segmentation, Normalization	DWT, S-Transform Spectrogram	2D Spectrograms	MATLAB	2D-CNN	10	Softmax	98.12	97.01	98.12	-
(Bouallegue et al., 2020)	Bonn, CHB-MIT	sEEG	Segmentation	Filter EEG using FastICA Network, Feature Extraction using GRU	Matrix of Size 16 x 400	Keras, TensorFlow	2D-CNN	10	Softmax	100	-	-	-
		IEEG											
(Raghu et al., 2020)	TUH	sEEG	Filtering	STFT	2D Spectrograms	MATLAB	Inception-V3	10	SVM	88.3	-	-	-
(Li et al., 2020a)	Bonn	sEEG and IEEG	Segmentation, Resampling, Transformation into 20 Common Channels, Baseline Removal and Detrending, Filtering	-	Spectral-Temporal Features	PyTorch	CE-stSENet	5	MLP	99.80	-	-	-
	TUSZ	sEEG											
	CHB-MIT	sEEG											
(Usman et al., 2020)	CHB-MIT	sEEG	Filtering, Segmentation	STFT	2D Spectrograms	MATLAB	2D-CNN	-	SVM	-	92.7	90.8	-
(Ilakiyaselvan et al., 2020)	Bonn	sEEG and IEEG	Filtering, Segmentation	RPS representation	RPS Images	Caffe	AlexNet	10	Softmax	98.5	100	97.83	-
(Bhagat et al., 2020)	CHB-MIT	sEEG	-	Converting 1D EEG Data into 2D EEG Images	224x224 Images	NA	ResNet-50	-	Softmax	94.98	-	-	-
(George et al., 2020)	CHB-MIT	sEEG	-	Backpropagation Auto Stack Encoder (BP-ASE)	-	NA	ResNet	-	Softmax	99.4	99	96	96.8



(Gao et al., 2020b)	CHB-MIT	sEEG	Segmentation	DWT Threshold Denoising Method, PSD Analysis, PSDED	PSDED	NA	Inception-ResNet-v2	-	Softmax	92.60	92.60	97.10	-
							Inception-v3						
							ResNet152						
(Singh et al., 2020)	Bonn	sEEG and IEEG	Filtering, Segmentation	DWT	Features from 2D Data	NA	2D-CNN	-	Softmax	97.74	-	-	-
(Bhattacharjee, 2020)	Bonn	sEEG and IEEG	-	Bi-Linear Interpolation, Concatenation of DWT and Power Spectrum Band	2D Data	NA	Multi Column CNN	-	Softmax	99.99	-	-	-
(Lian et al., 2020)	Bonn	sEEG and IEEG	Filtering	-	Raw EEG Signals	NA	Combination of 1D-CNN and 2D-CNN	10	Softmax	99.3	99.5	99.6	-
(Madhavan et al., 2019)	Bern-Barcelona	IEEG	-	FSST, WSST	Time-Frequency Matrix	PyTorch	2D-CNN	5	Softmax	99.94	99.94	99.94	-
(Sakai et al., 2020)	Clinical	sEEG	Filtering, Segmentation	-	EEG Signals Segment	Keras	ScalpNet	-	Sigmoid	99.9	-	-	94.4
(Hussein et al., 2020)	Clinical	IEEG	Segmentation	CWT	2D Scalograms	NA	SDCN	-	Sigmoid	92.80	88.45	-	-
	Clinical	IEEG								88.30	89.52	-	-
(Kaya, 2020)	Bonn	sEEG and IEEG	Normalization	CWT, mRMR Algorithm	2D Scalograms	NA	Combination of AlexNet and VGG16	10	KNN	98.78	99.15	-	98.46
(Shankar et al., 2020)	Bonn	sEEG and IEEG	Noise Removal, Instantaneous Power Calculation, Segmentation	Gramian Angular Summation Field (GASF) and Gramian Angular Difference field (GADF)	2D Data	NA	2D-CNN	-	Sigmoid	98	99	98.9	-
(Rashed-Al-Mahfuz et al., 2021)	Bonn	sEEG and IEEG	Segmentation	STFT and CWT, RGB Representation, DA	2D Data (Spectrogram, Scalogram)	Keras	FT-VGG16	-	Softmax	99.21	99.04	99.38	-

(Hu et al., 2020a)	CHB-MIT and the iNeuro	sEEG	Filtering, Segmentation	Mean Amplitude Spectrum (MAS), Mean Power Spectral Density (MPSD), and Wavelet Packet Features (WPFs)	Fused into a Single Image	-	AlexNet, VGG-19, Inception-v3, ResNet152, Inception-ResNet-v2	-	Softmax	98.97	-	-	-
							Hierarchical Neural Network (HNN)						
(Glory et al., 2020)	Bonn	sEEG and IEEG	-	DWT, Nonlinear, and Entropy-based features	Different Features	Keras, TensorFlow	Hybridizes Adaptive Haar Wavelet-based Binary Grasshopper Optimization Algorithm and Deep Neural Network (AHW-BGOA-DNN)	10	Softmax	-	-	-	-
	Bern	IEEG											
	CHB-MIT	sEEG											
(MohanBabu et al., 2020)	CHB-MIT	sEEG	Filtering, Differentiating	Hilbert Transform, Segmentation, Phase-Synchronization Measures, Graph Model	643 × 5 and up to 643 × 50	Keras, TensorFlow	Optimized Deep Learning Network Model (ODLN)	-	Softmax	-	100	-	-
(You et al., 2020)	Clinical	sEEG	Reviewed Separately by 2 Epileptologists, Filtering	Segmentation, STFT, Normalization, Rescaling, Stack 3 Images to form a Data Structure	2D Spectrograms	TensorFlow	AnoGAN	-	Combination of Anomaly Loss and a Gram Matrix	-	96.6	-	-
(Truong et al., 2019)	CHB-MIT	sEEG	Segmentation	STFT	2D Spectrograms	TensorFlow	DCGAN	-	Softmax	77.68	-	-	-
	EPILEPSIAE	sEEG											
	Freiburg	IEEG											

(Pascual et al., 2019)	EPILEPSIAE	sEEG	Segmentation	DWT, Power and Non-Linearity per Electrode Features Extraction	Non-Seizure (inter-ictal) EEG Samples	NA	Conditional GAN	-	RF	-	-	-	-
(Torfi and Fox, 2020)	UCI	sEEG	NA	Different Methods	Matrix	NA	CorGAN	-	Softmax	-	-	-	21
(Sharan and Berkovsky, 2020)	CHB-MIT	sEEG	Segmentation, Filtering	FFT and WT	135×1×54 with FFT and 132×1×54 with WT	NA	1D-CNN	10	Softmax	97.25	97.25	97.25	-
(Hu et al., 2020b)	CHB-MIT and iNeuro	sEEG	Filtering, Decomposition	Feature Extraction (MAS, MPSD, WPFs)	Multiple Fused EEG Features	NA	Different Pre-Train Nets	NA	Hierarchical Neural Network (HNN)	98.97	-	-	-
(Ullah et al., 2018)	Bonn	sEEG and IEEG	-	DA	EEG Signals Segment	TensorFlow	P-1D-CNN	10	Majority Voting	99.1	-	-	-
(Acharya et al., 2018)	Bonn	sEEG and IEEG	Z- Normalization	-	Normalized EEG Signals	MATLAB	1D-CNN	10	Softmax	88.67	95	90	-
(Wang et al., 2020b)	Berne-Barcelona	EEG	NA	-	Raw EEG Signals	NA	Time-ResNeXt	-	Softmax	91.5	-	-	-
(Page et al., 2016)	CHB-MIT	sEEG	Filtering	DA	EEG Signals Segment	NA	MPCNN	-	Softmax	96	100	-	-
(Zhang et al., 2020b)	Bonn	sEEG and IEEG	Normalization	-	Raw EEG Signals	Keras	Multi-Scale Non-Local (MNL) Network	10	Softmax				
(O'Shea et al., 2017a)	Clinical	sEEG	Down-Sampling, Filtering	-	EEG Signals Segment	Keras	1D-FCNN	5	Softmax	97.1	-	-	-
(Thomas et al., 2020b)	Clinical	sEEG	Filtering, Down Sampling, Artifact Rejection Based on Noise Statistics, Segmentation	-	EEG Signals Segment	TensorFlow	1D-CNN	5	Softmax	-	80	-	-
(O'Shea et al., 2017b)	Clinical	sEEG	Filtering	-	Raw EEG Signals	Theano Lasagne	1D-CNN	-	Binary LR	94.70	-	-	-
(Yildirim et al., 2018)	TUH	EEG	Segmentation, Normalization, and Standardization	-	EEG Signals Segment	Keras	1D-CNN	-	Softmax	79.34	-	79.64	78.92
(Zhao and Wang, 2020)	Bonn	sEEG and IEEG	Normalization	-	Raw EEG Signals	Keras, TensorFlow	SeizureNet	10	Softmax	98.5	97	100	-

(Akyol, 2020)	Bonn	sEEG and IEEG	Normalization	-	Raw EEG Signals	Keras, TensorFlow	Stacked Ensemble based DNN Modeling	10	Meta Learner	97.17	93.11	98.18	-
(Thomas et al., 2018)	MGH Epileptic Dataset	sEEG	Filtering, Down Sampling	CAR montage	Raw EEG Signals	TensorFlow	1D-CNN	4	SVM	83.86	-	-	-
(Uyttenhove et al., 2020)	TUH	sEEG	Filtering, Segmentation	-	EEG Signals Segment	NA	Tiny-Visual Geometry Group (T-VGG)	5	NA	70.38	-	82.98	-
(Boonyakitanont et al., 2019)	CHB-MIT	sEEG	Segmentation, Normalization	-	Raw Multi-Channel EEG Signals	NA	1D-CNN	10	NA	99.07	66.76	99.63	65.69
(Chen et al., 2018)	Bonn	sEEG and IEEG	DWT, Segmentation, Normalization	-	Preprocessed EEG Signals	NA	1D-CNN	5	Sigmoid	97.27	-	-	-
(Zhang et al., 2020e)	TUSZ	sEEG	Montage Selection, Segmentation	Denoising, Normalization, DWT, SMOTE	4 Wavelet Coefficient Packages	PyTorch	DWT-Net	5	Softmax	-	25.24	97.05	-
(Zhang et al., 2018)	Bonn	sEEG and IEEG	Normalization	-	Raw EEG Signals	NA	1D-TCNN	-	NA	100	100	100	100
(Zhao et al., 2020a)	CHB-MIT and Another Dataset	sEEG	NA	-	Raw EEG Signals	Keras, TensorFlow	Binary Single-Dimensional Convolutional Neural Network (BSDCNN)	-	Sigmoid	-	94.69	-	-
(Daoud et al., 2018)	Bonn	sEEG and IEEG	-	EMD Feature Extraction	IMFs of EMD	NA	1D-CNN	10	Softmax	100	100	100	100
(Daoud et al., 2020)	CHB-MIT	sEEG	EEG Channel Selection	-	Raw EEG signals	NA	DCNN	-	NA	96.1	97.41	94.8	-
(Lu and Triesch, 2019)	Bonn	sEEG and IEEG	Filtering, Z-Normalization	-	Raw EEG signals	TensorFlow	1D-CNN	-	Softmax	99.00	-	-	-
										91.80	-	-	-
(Craley et al., 2019)	CHB-MIT	sEEG	Filtering	-	Raw EEG signals	PyTorch	1D-PGM-CNN	5	Softmax	80.00	-	-	67.00
	JHH	sEEG											
(Wei et al., 2019)	CHB-MIT	sEEG	-	MIDS, WGANs	5s length EEG Signals	NA	1D-CNN	-	Softmax	-	74.08	92.46	-
(Qin et al., 2020a)	Bonn	sEEG and IEEG	NA	-	Raw EEG signals	TensorFlow	1D-CNN	10	Softmax	98.67	99	98	-
(Meisel et al., 2019)	Clinical	Multi Modal Wristband Sensor Data	Segmentation Down Sampling	-	Raw EEG signals	NA	1D-CNN	4	Sigmoid	71.4	-	-	-

(Zhang et al., 2020c)	TUH	sEEG	EEG Decomposition to Seizure and Patient Components	-	Latten Seizure and Patient Representation	NA	CNN	14	Sigmoid	80.5	97.4	88.1	-
(Yuvaraj et al., 2018)	CHB-MIT	sEEG	Filtering, Segmentation	-	EEG Signals Segment	TensorFlow	1D-CNN	4	Softmax	-	86.29	-	-
(Abou Jaoude et al., 2020)	Clinical	IEEG	Down Sampling, Filtering	DA	1 Second Epoch from a Single FO-EEG Bipolar Channel	Keras TensorFlow MATLAB	CNN-BP	5	Sigmoid	99.60	84.00	-	-
(Fukumori et al., 2019)	Clinical	sEEG	Filtering	DWT	Raw EEG signals Coefficients Sub-bands D6, D5, D4	NA	1D-CNN LSTM GRU	-	Sigmoid RF SVM	96.10	-	-	-
(Guha et al., 2020)	UC Irvine Machine Learning Repository Bonn	sEEG sEEG and IEEG	Normalization	Feature Extraction, Data Cleaning	NA	TensorFlow	DNN	-	NA	80.00	-	-	71.00
(Kaziha and Bonny, 2020)	CHB-MIT	sEEG	Segmentation	-	EEG Signals Segment	Keras	1D-CNN	5	Sigmoid	96.74	82.35	100	-
(Truong et al., 2020)	EPILEPSIAE	sEEG	NA	-	n×59×114	NA	Bayesian Convolutional Neural Network (BCNN)	-	Softmax	-	-	-	-
(Zhao et al., 2020c)	Bern-Barcelona	IEEG	Filtering	DA	Augmented EEG Signals	NA	1D-CNN	10	NA	89.28	-	-	-
(Boonyakitanont et al., 2020b)	CHB-MIT	sEEG	Segmentation	-	EEG Signals Segment	NA	1D-CNN	-	Onset-offset Detection Method	99.72	72.78	99.82	64.4
(Khalilpour et al., 2020)	CHB-MIT	sEEG	Segmentation, Normalization	-	EEG Signals Segment	NA	1D-CNN	-	Softmax	97	98.5	98.47	-
(Zhao et al., 2020b)	Bonn	sEEG and IEEG	Segmentation, Normalization	-	EEG Signals Segment	Keras TensorFlow	1D-CNN	10	Softmax	99.52 98.06	-	-	-
(Abiyev et al., 2020)	Bonn	sEEG and IEEG	Normalization	-	Raw EEG signals	Keras TensorFlow	1D-CNN	10	Softmax	98.67	97.67	98.83	-
(Pisano et al., 2020)	Clinical	sEEG	Segmentation, Standard Thresholding, Filtering	DA	Augmented EEG Signals	MATLAB	1D-CNN	-	Softmax	96.39	93.2	96.81	-
(Lu et al., 2020)	Clinical (Mice)	IEEG	Filtering, Segmentation	CAM	EEG Signals Segment	MATLAB TensorFlow	DNN	7	Softmax	73.00	-	-	78.00

(Xu et al., 2020c)	Kaggle CHB-MIT	IEEG sEEG	Segmentation	–	EEG Signals Segment	Keras TensorFlow	CNN	–	Softmax	98.80	98.80	–	–
(Lin et al., 2020)	Clinical	sEEG	Filtering, Normalization, Segmentation, Resampling Strategies	–	EEG Signals Segment	NA	Deep ConvNet	10	Softmax	80	70	90	77.77
(Jana et al., 2020)	CHB-MIT	sEEG	Filtering, Segmentation	Spectrogram Generation	2D Spectrograms	Keras TensorFlow	1D-CNN	–	Softmax	77.57	75.59	79.54	–
(Gao et al., 2020a)	Bonn	sEEG and IEEG	Segmentation	ApEn and RQA Features	Feature Vectors	MATLAB	1D-CNN	–	Softmax	99.26	98.84	99.35	–
(Thomas et al., 2020a)	CHB-MIT	sEEG	Segmentation, Resample, Rescale	–	Raw EEG signals	TensorFlow, Keras	1D-CNN	–	NA	84.1	–	–	–
(Vance et al., 2020)	Clinical	sEEG	Sequence Generation, Resampling	Online Augmentations	Sequence Length of 10 Seconds	TensorFlow, Keras	1D-CNN	–	Sigmoid	77	60.6	82.8	–
(Liu and Richardson, 2020)	CHB-MIT	sEEG	Segmentation	–	Raw EEG signals	TensorFlow	1D-CNN LSTM	10	Weighted Majority Vot- ing (WMV)	89.21 90.94	89.50 91.53	94.86 95.75	– –
(Vidyaratne et al., 2016)	CHB-MIT	sEEG	Filtering	Montage Mapping	2D Grid	MATLAB	DRNN	–	MLP	–	100	–	–
(Hussein et al., 2018c)	Bonn	sEEG and IEEG	Filtering, Segmentation	–	EEG Signals Segment	Keras TensorFlow MATLAB	LSTM	10	Softmax	100	100	100	–
(Ahmedt-Aristizabal et al., 2018b)	Bonn	sEEG and IEEG	Segmentation	–	Raw EEG signals	Keras	LSTM	10	Sigmoid	95.54	–	–	–
(Yao et al., 2019b)	CHB-MIT	sEEG	Segmentation	–	EEG Signals Segment	NA	IndRNN	10	NA	87	87.3	86.7	87.07
(Verma and Janghel, 2021)	Bonn	sEEG and IEEG	–	DWT	Wavelet Coefficients	Keras	RNN	NA	LR	98.5	–	–	–
(Hussein et al., 2019)	Bonn	sEEG and IEEG	Filtering, Segmentation	DA	Augmented EEG Signals	TensorFlow Keras	LSTM	10	Softmax	100	100	100	–
(Jaafar and Mohammadi, 2019)	Freiburg	IEEG	Normalization, Filtering, Shuffling, Segmenting and Reshaping	–	EEG Signals Segment	NA	LSTM	5	Softmax	97.75	–	–	–
(Hu et al., 2020c)	CHB-MIT	sEEG	Segmentation	Local Mean Decomposition (LMD), 10 Statistical Features Extraction	Feature Vectors	Python	Bi-LSTM	NA	Softmax	–	93.61	91.85	–
(Yao et al., 2019a)	CHB-MIT	sEEG	Segmentation	–	EEG Signals Segment	NA	ADIndRNN	10	NA	88.7	88.8	88.6	88.71

(Talathi, 2017)	Bonn	sEEG and IEEG	–	Auto-Correlation	EEG Signals Segment	Keras	GRU	–	LR	98	–	–	–
(Roy et al., 2019)	TUH	EEG	–	TCP	Raw EEG signals	NA	ChronoNet	–	Softmax	86.57	–	–	–
(Hussein et al., 2018b)	Bonn	sEEG and IEEG	Filtering	–	EEG Signals Segment	NA	LSTM	–	Softmax	100	100	100	–
(Geng et al., 2020)	Freiburg	IEEG	Segmentation	DA, Stockwell Transform	2D Spectrograms	TensorFlow MATLAB	Bi-LSTM	–	Softmax	98.91	98.08	98.91	–
(Fraivan and Alkhodari, 2020)	Bern-Barcelona	IEEG	Normalization, Filtering	–	EEG Signals Segment	MATLAB	Bi-LSTM	10	Softmax	99.6	99.55	99.65	–
(Hu and Yuan, 2019)	Bonn	sEEG and IEEG	Filtering	Linear Feature Extraction	Linear Features	MATLAB	Bi-LSTM	–	Softmax	98.56	100	97.14	–
(Abbasi et al., 2019)	Bonn	sEEG and IEEG	Segmentation, Normalization, Standardization	DCT, Hurst Exponent and ARMA Features Extraction	Feature Vectors	NA	LSTM	–	Softmax	99.17	98.88	99.45	–
(Yao et al., 2021)	CHB-MIT	sEEG	Segmentation	–	EEG Signals Segment	–	Attention Bi-LSTM	10	Softmax	87.8	87.3	88.3	87.74
(Patan and Rutkowski, 2021)	Clinical	sEEG	Segmentation	–	EEG Signals Segment	MATLAB	LSTM	–	Softmax	97.9	–	–	–
(Rajaguru and Prabhakar, 2018)	Clinical	EEG	Segmentation	–	EEG Signals Segment	NA	AE with EM-PCA	–	GA	93.92	96.11	91.73	–
(Sharathappriyaa et al., 2018)	Bonn	sEEG and IEEG	Filtering	HWPT, FD	Feature Vectors	MATLAB	AE	–	Softmax	98.67	98.18	100	–
(Emami et al., 2019a)	Clinical	sEEG	Down Sampling, Filtering, Normalization	–	EEG Signals Segment	TensorFlow	AE	–	Sigmoid	–	100	–	–
(Yuan et al., 2017)	CHB-MIT	sEEG	–	STFT	2D Spectrograms	NA	SSDA	–	Softmax	93.82	–	–	–
(Qiu et al., 2018)	Bonn	sEEG and IEEG	Segmentation, Z-Normalization, Standardization	–	EEG Signals Segment	MATLAB	DSAE	–	LR	100	100	100	–
(Golmohammadi et al., 2019)	TUH	sEEG	–	Different Methods	A Vector of 6 Posterior Probabilities	Theano	SDA	–	LR	–	90	–	–
(Yan et al., 2016)	Bonn	sEEG and IEEG	Filtering	–	Raw EEG signals	NA	SAE	–	SVM	100	100	100	–
(Lin et al., 2016)	Bonn	sEEG and IEEG	Segmentation, Normalization	–	EEG Signals Segment	NA	SSAE	–	Softmax	100	100	100	–
(Yuan et al., 2019)	CHB-MIT	sEEG	Segmentation	Scalogram	2D Scalograms	Theano	Wave2Vec	–	Softmax	93.92	–	–	96.05
(Gasparini et al., 2018)	Clinical	EEG	Filtering	CWT, Feature Extraction	Feature Vectors	NA	SAE	–	Softmax	86.5	88.8	90.7	–

(Karim et al., 2018a)	Bonn	sEEG and IEEG	–	Taguchi Method	Raw EEG signals	NA	SSAE	–	Softmax	99.8	–	–	–
(Karim et al., 2019)	Clinical	EEG	–	Dimension Reduction, ESD	Feature Vectors	NA	DSAEs	–	Softmax	100	–	–	–
(Karim et al., 2018b)	Bonn	sEEG and IEEG	–	DWT	Feature Vectors	NA	SAE	–	Softmax	96	–	–	–
(Yuan et al., 2018c)	CHB-MIT	sEEG	–	Different Methods	2D Spectrograms	NA	SAEs	–	Softmax	96.61	–	–	97.85
(Sharma et al., 2020)	Bonn	sEEG and IEEG	–	Raw EEG Signals in to 2D Space using the Third-Order Cumulant	ToC Coefficients	NA	SAE	–	Softmax	100	100	100	–
(Siddharth et al., 2020)	Bern-Barcelona	IEEG	Standard Preprocessing	FBSE-EWT	Raw EEG signals	NA	SAE	5	SVM	100	100	100	–
(Le et al., 2018)	Clinical	EEG	–	DWT	Waveform Features	MATLAB	DBN	–	NA	–	87.35	97.89	–
(Turner et al., 2017)	Clinical	EEG	Normalization, Standardization	Feature Extraction	Feature Vectors	Theano	DBN	–	LR	85	–	–	–
(Tang et al., 2020)	CHB-MIT	sEEG	Segmentation	Decomposition, Multi-View Feature Extraction	3 Feature Sets (Local Fractal Spectrum, Relative Band Energy, Synchronization Modularity)	NA	Multi-View CNN-GRU	–	Softmax	–	94.5	–	–
(Thodoroff et al., 2016)	CHB-MIT	sEEG	–	Image Based Representation	2D Data	NA	2D CNN-LSTM	–	NA	–	–	–	–
(Saqib et al., 2020)	TUSZ		Resampling, Filtering, Segmentation	DA	1000×21	NA	2D CNN-LSTM	–	Softmax	–	86	–	65.1
(Choi et al., 2019)	CHB-MIT SNUH	sEEG	–	STFT, 2D-mapping	2D Spectrograms	NA	3D-CNN-Bi GRU	–	NA	99.40	89.00	99.50	–
(Liang et al., 2020)	CHB-MIT	sEEG	–	Converted Into a Series of Two Seconds Waveform Images	EEG Signals Segment	NA	LRCN	–	Softmax	99	84	99	–
(Roy et al., 2018)	TUH	sEEG	Various Preprocessing Technique	–	EEG Signals Segment	NA	1D-CNN-RNN	–	Softmax	70.39	–	–	–
(Golmohammadi et al., 2017)	TUH Clinical	sEEG	Segmentation, Filtering	Feature Extraction, left to right channel independent GMM-HMM, PCA, IPCA	EEG Signals Segment (210 frames of EEGs)	NA	CNN-LSTM	–	Different Activation Functions	–	39.09	76.84	–



(Li et al., 2020b)	Bonn	sEEG and IEEG	Segmentation, Resizing	-	EEG Signals Segment	Keras	FC-NLSTM	10	Softmax	100	100	100	-
	Freiburg CHB-MIT	IEEG sEEG				TensorFlow							
(Liu et al., 2020b)	UCI	sEEG	Segmentation	-	EEG Signals Segment	NA	C-LSTM	-	Softmax	98.8	100	-	100
(Yang et al., 2021)	Clinical	Long-Term Video-EEG Monitoring	Segmentation, Resizing	-	224 x 224-Pixel Resolutions	Keras, TensorFlow	CNN-LSTM	-	Sigmoid	-	88	92	-
(Xu et al., 2020a)	UCI	sEEG	Normalization	-	Raw EEG signals	-	1D CNN-LSTM	-	Softmax	99.39	-	-	98.59
(Yuan et al., 2018b)	CHB-MIT	sEEG	-	DA, STFT	2D Spectrograms	PyTorch	CNN-AE	5	Softmax	94.37	-	-	85.34
(Wen and Zhang, 2018)	Bonn	sEEG and IEEG	Channel Selection	-	Raw EEG signals	NA	CNN-AE	10	Different Methods	92.00	-	-	-
	CHB-MIT	sEEG						5					
(Abdelhameed et al., 2018)	Bonn	sEEG and IEEG	Segmentation	-	EEG Signals Segment	NA	1D-CNN-AE	-	MLP/LSTM/ Bi-LSTM	100	100	100	-
(Antoniades et al., 2018)	Clinical	sEEG	-	Mapping	EEG Signals Segment	Theano	ASAE-CNN	-	LR	68.00	67.00	68.00	68.00
(Yuan and Jia, 2019)	CHB-MIT	sEEG	-	STFT	2D Spectrograms	PyTorch	AAE-CNN						
(Daoud and Bayoumi, 2019)	Bonn	sEEG and IEEG	Segmentation, Filtering, Normalization	DA	EEG Signals Segment	NA	DCAE	10	MLP	96.00	93.00	99.00	-
	Bern Barcelona	IEEG					DCVAE						
(Shoeibi et al., 2021)	Bonn	sEEG and IEEG	Filtering, Segmentation	Feature Extraction (Time, Statistical, Non-Linear), Feature Selection (Fisher Feature Scoring Algorithm)	Feature Vectors (20 Most Important Features)	TensorFlow	CNN-AE	-	Softmax	99.53	-	-	-
(Takahashi et al., 2020)	Clinical	sEEG	Filtering, Segmentation	-	EEG Signals Segment	-	CNN-AE	-	Softmax	99.6	-	-	52.6

Table 3: Summary of related works done using medical imaging methods and DL.

Work	Dataset	Modalities	Preprocessing	Preprocessing Toolbox	Input Network	DNN	DNN toolbox	Classifier	K-fold	Performance criteria (%)			
										Acc	Sens	Spec	F1-S
(Dev et al., 2019)	SCTIMST	MRI	Noise Reduction with BM3D Algorithm, Skull-Stripping, FCD Lesion Segmentation	FSL	256 × 256 Image Size	FCN	Keras TensorFlow	Sigmoid	5	-	-	-	-
(Gill et al., 2018)	Clinical	MRI	Different Methods	NA	3D Patches	Two-Stage CNNx Cascade	NA	Softmax	5	-	87	90	-
(Hao et al., 2018)	Clinical	EEG-fMRI	Filtering, ICA, BCG, GLM, MCS	Brain Vision Analyzer Software	IEDs	ResNet	NA	Triplet	-	-	84.40	-	
(Hosseini et al., 2017)	Clinical	EEG/ECOG rs-fMRI	Different Methods	NA	Preprocessed EEG and fMRI Data	2D-CNN	NA	SVM					
(Yan et al., 2018)	Clinical	MRI	Scaling Down	NA	Raw MRI Data	3D-CNN	NA	Softmax	5	98.8	-	-	-
(Gleichgerrcht et al., 2018)	Clinical	MRI	Preprocessing the Connectivity Matrix, Construction of The SZ And SZF Binary Masks, Applying Masks to Reduce Dimensionality of Input Connectivity Matrix	NA	SZ and SZF Binary Masks	2D-CNN	NA	Softmax	-	-	-	-	-
(Jiang et al., 2019a)	Clinical	PET	ROI, Normalization, AAL, CNNI, Down-sampling, NNI (3D images)	NA	2D ROI 3D ROI	2D-ResNet 50	TensorFlow	Sigmoid	-	98.22	97.27	98.86	-
						2D-VGG 16							
						2D-Inception V3	Keras						
						3D-SVGG-C3D							
(Shiri et al., 2019)	Clinical	PET	OSEM, DA Radionics Features	NA	Non-Attenuation-Corrected (NAC) 2D PET Image Slices	Deep-DAC	TensorFlow	Tanh	-	-	-	-	-
(Wang et al., 2020a)	Clinical	MRI	Bias Field Correction, Skull-Stripping, Intensity Normalization, Patch Extraction, DA	NA	Patches	CNN	MATLAB	Softmax	-	88	90	85	-
(Shakeri et al., 2016)	a Rolandic Epilepsy (RE) study	MRI	Resizing, DA	NA	Single 2D Slice	FCN	MATLAB	Softmax	-	-	-	-	-
(Figini et al., 2020)	HCP Dataset	MRI	Simulated LF Images from HF References	NA	Paired HF and Simulated LF Images	Aniso-U-Net	NA	-	-	-	-	-	-
(Pominova et al., 2018)	Clinical	sMRI, rs-fMRI	Resizing, Denoising	SPM, FSL	3D Scans	VoxCNN-B	NA	Softmax	5	-	-	-	-

(Xu et al., 2019)	Clinical	DWI, fMRI	Different Methods	SPM, FSL	DWI Streamline Coordinate	DCNN-CL-ATT	PyTorch	Softmax	-	-	-	-	-
(Torres-Velázquez et al., 2020)	ECP Project	sMRI, rs-fMRI and task-fMRI, PDC data	Minimal Pre-Processing Pipelines For The Human Connectome Project (HCP) Version 3.4.0	FSL	sMRI Features, rs-fMRI and task-fMRI Based ROI Correlation Matrices, and PDC	Multi-Channel Deep Neural Network (mDNN)	Keras	Output Layer	10	72.86	-	-	-
(Rebsamen et al., 2020)	Inselspital	MRI	Ground Truth Generation using FreeSurfer, Skull-Stripping, Re-Sampled and Cropped, Re-Scaled, DA	FreeSurfer	Preprocessed MRI	3D-CNN	TensorFlow	-	-	-	-	-	-
(Si et al., 2020)	Clinical	Diffusion MRI	Standard Preprocessing, Generate The Connectivity Matrix using HARDI and (NODDI) Methods	MRICro, MRtrix3, DSI studio, NODDI toolbox	Connectivity-Strength Based Weight ICVF	Inception_ResNet_v2	NA	Softmax	-	75.2	-	-	-
(Huang et al., 2020)	Clinical	MRI	Series of Standard Preprocessing Procedures, Hippocampus Mask, FA, MD, and MK of Hippocampus	SPM8, MATLAB R2017a	FA, MD, and MK Slice-Level	VGG16	-	SVM	5	90.8	89.29	93.5	-
(Lee et al., 2020)	Clinical	DWI	Series of Different Preprocessing Procedures	FreeSurfer, FSL, MRtrix3 package, ANTs package, QuickBundles package	14 ESM	DCNN	PyTorch	Softmax	-	92	-	-	99.3

Table 4: Details for DL Networks for Epileptic Seizures Detection.

Work	Networks	Network Details	Classifier	Optimizer	Loss Function
(Antoniades et al., 2016)	2D-CNN	1 Conv Layer + 1 FC Layer 2 Conv Layers + 1 FC Layer	LR	NA	NA
(Qin et al., 2020b)	2D-CNN	3 Conv Layers + 3 Max Pooling Layers + 3 BN Layers + 1 FC Layer + ReLU activation function	ELM	NA	NA
(Park et al., 2018)	Combination of 1D-CNN and 2D-CNN	6 1D Conv Layers + 3 2D Conv Layers + 3 Max Pooling Layers + 2 FC Layers	Sigmoid	Sum-Squared Error	Proposed Loss Function
(Tjepkema-Cloostermans et al., 2018)	2D-CNN	6 Conv Layers + 6 Dropout Layers + 3 Max Pooling Layers + 2 FC Layers	Softmax	Adam	Categorical Cross Entropy (CCE)

(Avcu et al., 2019)	SeizNet	4 Conv Layers + 4 Max Pooling Layers + 5 Dropout Layers + 4 BN Layers + 1 FC Layer	Dense Layer	Adam	Binary Cross Entropy (BCE)
(Zhan and Hu, 2020)	DCNN	4 Conv Layers + 4 FC Layers	Multiview Fuzzy Clustering Method	NA	NA
(Nejedly et al., 2019)	CNN	6 Conv Layers + 6 BN Layers + 3 Dropout Layers + 3 FC Layers	Softmax	Adam	CE
(Hossain et al., 2019)	2D-CNN	4 Conv layers + 2 Max Pooling Layers + 4 BN Layers + 1 Dropout Layer	Softmax	Minibatch SGD	NA
(Mao et al., 2020)	2D-CNN	3 Conv layers + 3 pooling layers + ReLU activation function	Softmax	NA	NA
(Zuo et al., 2019)	2D-CNN	4 Conv Layers + 4 BN Layers + 3 Max Pooling Layers + 1 Dropout Layer + 2 FC Layers	Softmax	Minibatch SGD	CE
(Asif et al., 2019)	SeizureNet	52 Conv Layers + 5 Pooling Layers + 51 BN Layers + 24 Dropout Layers	Softmax	Adam	Proposed Loss Function
(Iešmantas and Alzbutas, 2020)	2D-CNN	1 Conv Layer + 1 subsampling Layer+ 1 FC layer	Softmax	Adam	CE
(Zeng et al., 2021)	GRP-DNet	DenseNet: 1 Conv Layer + 3 Dense Blocks + 2 Transition Layers + 3 Global Average Pooling Layers + 1 FC Layer	Softmax	Adam	CE
(San-Segundo et al., 2019)	2D-CNN	2 Conv Layers + 1 Max Pooling Layer +4 Dropout Layers + 2 FC Layers	Softmax	Root-Mean Square Propagation Method	CCE
			Sigmoid		
(Sui et al., 2019)	2D-CNN	5 Conv Layers + 5 Max Pooling Layers + 5 FC Layers	Softmax	NA	NA
(Chatzichristos et al., 2020)	Attention-Gated U-Net	15 Conv Layers + 6 Max Pooling Layers + 5 Average Pooling Layers + 6 Up Sampling Layers + 5 Gating Signals + 5 Attention Gates	Bi-LSTM + FC Layer		Regular Cross-Entropy, Weighted Cross-Entropy
(Covert et al., 2019)	TGCN	4 STC Layers + 5 Pooling Layers + 4 BN Layers + 2 FC Layers + 1 Dropout Layer	Sigmoid	SGD	CE
		8 STC Layers + 5 Pooling Layers + 4 BN Layers + 2 FC Layers + 1 Dropout Layer			
		12 STC Layers + 5 Pooling Layers + 4 BN Layers + 2 FC Layers + 1 Dropout Layer			
		16 STC Layers + 5 Pooling Layers + 4 BN Layers + 2 FC Layers + 1 Dropout Layer			
(Akut, 2019)	2D-CNN	4 Conv Layers + 2 Max Pooling Layers+ 8 BN Layers + 4 Dropout Layers + 4 FC Layers	Softmax	NA	NA
(Türk and Özerdem, 2019)	2D-CNN	2 Conv Layers + 2 Max Pooling Layers	Softmax	Adadelata	NA
(Liu and Woodson, 2019)	2D-CNN	3 Conv Layers + 3 BN Layers + 2 Max Pooling Layers + 1 FC Layer	Softmax	NA	NA
(Tian et al., 2019)	2D-CNN	4 Conv Layers + 3 FC Layers	MV-TSK-FS	NA	CE
		2 Conv Layers + 3 FC Layers			
	3D-CNN	4 Conv Layers + 4 FC Layers			
(Bouaziz et al., 2019)	2D-CNN	3 Conv Layers + 2 Max Pooling Layers + 1 FC Layer	Softmax	SGD	
(Prasanth et al., 2020)	1D-CNN, 2D-CNN	NA	NA	NA	NA
(Ansari et al., 2019)	2D-CNN	7 Conv Layers + 8 Pooling Layers + 2 FC Layers	Sigmoid	NA	NA
		5 Conv Layers + 8 Pooling Layers	RF		
(Cao et al., 2019)	SCNN	2 Conv Layers + 2 Max Pooling Layers + 1 Dropout Layer + 2 FC Layers	KELM	SGD	NA

(Taqi et al., 2017)	GoogleNet	Standard Network	Softmax	NA	CE
	AlexNet				
	LeNet				
(Emami et al., 2019b)	2D-CNN	VGG-16	Softmax	Adam	NA
(Bizopoulos et al., 2019)	2D-CNN	Standard Networks	Softmax	NA	NA
	1D-CNN				
(Thanaraj et al., 2020)	AlexNet, VGG-16, VGG-19	Standard Network	Softmax	NA	NA
	Custom CNN	3 Conv Layers, 1 BN Layer + 1 Max-Pooling Layer + 2 FC Layers	Softmax		
(Zhang et al., 2020a)	VGG-16	Standard Network + 2 Trainable FC Layers	Softmax	SGD	Softmax Cross Entropy (SCE)
	VGG-19				
	ResNet-50				
(Cho and Jang, 2020)	2D-CNN	2 Conv Layers + 2 Max Pooling Layers + 2 FC Layers + 2 Dropout Layers	Output Layer	Adam	NA
	1D-CNN	2 Conv Layers + 2 Max Pooling Layers + 2 FC Layers + 2 Dropout Layers			
	LSTM	1 LSTM Layer + 1 Pooling Layer + 1 FC Layer			
(Liu et al., 2020a)	2D-CNN	4 Conv Layers + 4 BN Layers + 3 Max Pooling Layers + 1 FC Layer + 2 Dropout Layers	Softmax	Adam	CE
(Bouallegue et al., 2020)	2D-CNN	Conv Layers + Max Pooling Layers + FC Layers + Dropout Layer + ReLU Activation Function	Softmax	Adam	MSE
	RNN-GRU	2 GRU Layers + 1 FC Layer + ReLU Activation Function	NA		
(Raghu et al., 2020)	Inception-V3	Standard Network + Final Three Layers Replaced	SVM	SGDM, RMSProp, Adam	NA
(Li et al., 2020a)	CE-stSENet	Proposed Architecture	MLP	Adam	CE
(Usman et al., 2020)	2D-CNN	3 Conv Layers + 3 BN Layers + 3 Max Pooling Layers + 1 Dropout Layer	SVM	NA	NA
(Ilakiyaselvan et al., 2020)	AlexNet	Standard Network	Softmax	SGD	CE
(Bhagat et al., 2020)	ResNet-50	Modified	Softmax	Adam	Categorical CE
(George et al., 2020)	ResNet	Standard Network	Softmax	NA	NA
(Gao et al., 2020b)	Inception-ResNet-v2	Standard Network + 2 FC Layers	Softmax	NA	OHEM
	Inception-v3				
	ResNet152				
(Singh et al., 2020)	2D-CNN	2 Conv Layers + 2 BN Layers + 1 Max-Pooling Layer + 1 FC Layer	Softmax	SGD	NA
(Bhattacharjee, 2020)	Multi Column CNN	-	Softmax	NA	NA
(Lian et al., 2020)	Combination of 1D-CNN and 2D-CNN	2 1D-Conv Layers + 3 2D-Conv Layers + 1 FC Layer	Softmax	NA	SLF

(Madhavan et al., 2019)	2D-CNN	5 Conv Layers + 5 Pooling Layers + 5 FC Layers	Softmax	SGD	CE
(Sakai et al., 2020)	ScalpNet	11 Conv Layers + 10 Dropout Layers + 1 FC Layer	Sigmoid	NA	Focal Loss
(Hussein et al., 2020)	SDCN	6 SDC Blocks+ 2 FC Layers	Sigmoid	Adam	BCE
(Kaya, 2020)	Combination of AlexNet and VGG16	Standard Networks	KNN	NA	NA
(Shankar et al., 2020)	2D-CNN	3 Conv Layers + 4 BN Layers + 1 Dropout Layer + 3 Max Pooling Layers + 1 FC Layer	Sigmoid	SGD	BCE
(Rashed-Al-Mahfuz et al., 2021)	FT-VGG16	Fine-tuning VGG16	Softmax	RMSprop	-
(Hu et al., 2020a)	Different Pre-Train Nets	Standard Versions	Softmax	Mini-Batch Gradient Descent (MBGD)	CE
	HNN	3 Cascaded Learning Blocks			
(Glory et al., 2020)	AHW-BGOA-DNN	NA	Softmax	Adaptive Optimization, SGD with CLRA	CCE
(MohanBabu et al., 2020)	ODLN	2 ODLN Layers + 2 Dropout Layers + Avg Pooling Layer	Softmax	Adam	CCE
(You et al., 2020)	AnoGAN	Generator: 4 Transposed Conv Layers + 4 BN layers, Discriminator: 4 Conv Layers+ 4 BN Layers	Combination of Anomaly Loss and a Gram matrix	SGD	Sigmoid Cross Entropy (SCE)
				Adam	
(Truong et al., 2019)	DCGAN	Generator: FC Layer+ Reshape Layer+ 3 de-Conv Layers, Discriminator: 3 Conv Layers + Flatten Layer+ FC Layer, Classifier: 2 FC Layers + 2 Dropout Layers	Softmax	Adam	NA
(Pascual et al., 2019)	conditional GAN	Generator: 8 Conv Layers + 8 Max Pooling Layers + 8 de-Conv Layers + 8 Dilations Layers, Discriminator: 8 Conv Layers + 8 Max Pooling Layers + 8 de-Conv Layers + 8 Dilations Layers + 1 FC Layer	RF	Adam	LSGAN
(Torfi and Fox, 2020)	CorGAN	CorGAN with Proposed Layers		NA	BCE
(Sharan and Berkovsky, 2020)	1D-CNN	3 Conv Layers + 3 Max Pooling Layers + 1 FC Layer + ReLU Activation Function	Softmax	Adam	
(Hu et al., 2020b)	Different Pre-Train Nets	Modified models		7-Layer HNN	Mini-Batch Gradient Descent (MBGD)
(Ullah et al., 2018)	P-1D-CNN	3 Conv Layers + 3 BN Layers + 1 Dropout Layer + 2 FC Layers	majority voting	Adam	CE
(Acharya et al., 2018)	1D-CNN	5 Conv Layers + 5 Max Pooling Layers + 2 FC Layers	Softmax	NA	NA
(Wang et al., 2020b)	Time-ResNeXt	Not Reported	Softmax	Adam	CE
(Page et al., 2016)	MPCNN	1-3 pairs of Conv and Max Pooling Layers + 1-3 FC Layers + Dropout	Softmax	NA	NA
(Zhang et al., 2020b)	MNLN	3 Conv Layers + 3 BN Layers + 2 Max Pooling Layers + 1 Signal Pooling Layer + 1 Multi-Scale Non-Local Layer + 2 FC Layers + RELU Activation Function	Softmax	Adam	CE
(O'Shea et al., 2017a)	1D-FCNN	6 Conv Layers + 1 BN Layer + 3 Pooling Layers	Softmax	SGD	CCE

(Thomas et al., 2020b)	1D-CNN	2 Conv Layers + Max Pooling Layer + 2 FC Layers + Dropout Layer + ReLU Activation Function	Softmax	Adam	CE
(O'Shea et al., 2017b)	1D-CNN	3 Conv Layers + 1 FC Layer + 1 Dropout Layer	Binary LR	SGD	BCE
(Yildirim et al., 2018)	1D-CNN	10 Conv Layers + 5 Max Pooling Layers + 2 Dropout Layers + 1 BN Layer + 1 FC Layer	Softmax	Adam	CCE
(Zhao and Wang, 2020)	SeizureNet	10 Conv Layers + 10 BN Layers + 6 Max Pooling Layers + 1 FC Layer + 1 Dropout Layer + ReLU Activation Function	Softmax	Adam	Binary CE
(Akyol, 2020)	Stacked Ensemble based DNN modeling	3 Hidden Layers + ReLU Activation Function	Meta Learner	Adam	NA
(Thomas et al., 2018)	1D-CNN	1 Conv Layer + 1 Pooling Layer + 1 FC Layer + 1 Dropout Layer	SVM	Adam	NA
(Uyttenhove et al., 2020)	T-VGG	6 Conv Layers + 6 BN Layers + 3 Max Pooling Layers + 1 FC Layer + ReLU Activation Function	Output Layer	Adam	Binary Cross-Entropy
(Boonyakitantont et al., 2019)	1D-CNN	11 Conv Layers + 5 BN Layers + 5 Max Pooling Layers + 3 Dropout Layers + 8 FC Layers	NA	NA	NA
(Chen et al., 2018)	1D-CNN	1 Conv Layer + 1 Max Pooling Layer + 1 FC Layer	Sigmoid	Adam	CE
(Zhang et al., 2020e)	DWT-Net	8 2D-Conv Layers + 8 1D-Conv Layers + 4 Max Pooling Layers + 4 Dropout Layers + Concatenation + 3D- Conv Layer + Max Pooling Layer + 2 FC Layers + ReLU Activation Function	Softmax	Adam	Weighted Cross-Entropy
(Zhang et al., 2018)	1D-TCNN	NA	NA	NA	NA
(Zhao et al., 2020a)	BSDCNN	5 Conv Blocks + 5 BN Layers + 2 FC Layers	Sigmoid	NA	NA
(Daoud et al., 2018)	1D-CNN	5 Conv Layers + 5 Max Pooling Layers + 1 FC Layer	Softmax	Gradient Descent Algorithm	BCE
(Daoud et al., 2020)	DCNN	4 Conv Layers + 3 Max Pooling Layers + 4 BN Layers + RELU Activation Function	NA	NA	NA
(Lu and Triesch, 2019)	1D-CNN with Residual connections	5 Conv Layers + 3 Max Pooling Layers + 3 BN Layers + 4 Dropout Layers + 1 FC Layer	Softmax	Adam	NA
(Craley et al., 2019)	1D-PGM-CNN	4 Conv Layers + 4 Max Pooling Layers + 1 FC Layer	Softmax	Adam	CE
(Wei et al., 2019)	1D-CNN	5 Conv Layers + 5 Max Pooling Layers + 3 Dropout Layers + 1 FC Layer	Softmax	Adam	NA
(Qin et al., 2020a)	1D-CNN	3 Conv Layers + 2 Dilated Conv Layers + 3 Max Pooling Layers + 3 FC Layers + 3 Dropout Layers + ReLU Activation Function	Softmax	Adam	CE
(Meisel et al., 2019)	1D-CNN	4 Conv Layers + 2 Pooling Layers + 3 Dropout Layers	Sigmoid	NA	NA

(Zhang et al., 2020c)	CNN	1 Conv Layer + 1 Max Pooling Layer + ReLU Activation Function + de-Conv Layer	-	Adam	MSE
		4 Conv Layers + 4 Max Pooling Layers + 2 FC Layers + 1 Dropout Layer + Attention Mechanism	Sigmoid		CE Multi-Class CE
(Yuvaraj et al., 2018)	1D-CNN	5 Conv Layers + 5 Pooling Layers + 1 FC Layer	Softmax	Adam	CE
(Abou Jaoude et al., 2020)	CNN-BP	3 Conv Layers + 3 Max Pooling Layers + 3 Dropout Layers + 1 GC Layers	Sigmoid	Adam	Log (CE)
(Fukumori et al., 2019)	LSTM GRU	Reshape Layer + 4 LSTM/GRU + 1 FC Layer	Sigmoid	NA	NA
	1D-CNN	Primary Conv Layer + 4 Conv Layers + 4 Max Pooling Layers + 1 FC Layer	Sigmoid	NA	NA
(Guha et al., 2020)	DNN	5 Hidden Layers	NA	NA	NA
(Kaziha and Bonny, 2020)	1D-CNN	5 Conv Layers + 5 BN Layers + 5 Avg Pooling Layers + 2 FC Layers	Sigmoid	RMSprop	NA
(Truong et al., 2020)	BCNN	3 Conv Blocks + 2 FC Layers	Softmax	ELBO	Negative of ELBO
(Zhao et al., 2020c)	1D-CNN	4 Conv Layers + 3 Max Pooling Layers + 1 FC Layer	NA	NA	NA
(Boonyakitantont et al., 2020b)	1D-CNN	14 Conv Layers + 7 BN Layers + 7 Max Pooling Layers + 2 Dropout Layers + 2 FC Layers	Onset-offset Detection Method	NA	NA
(Khalilpour et al., 2020)	1D-CNN	2 Conv Layers + 2 Pooling Layers + 1 Dropout Layer + 1 FC Layer	Softmax	NA	NA
(Zhao et al., 2020b)	1D-CNN	3 Conv Layers + 3 BN Layers + 5 Dropout Layers + 3 Max Pooling Layers + 2 FC Layers	Softmax	Adam	CE
(Abiyev et al., 2020)	1D-CNN	8 Conv Layers + 4 Pooling Layers + 1 Dropout Layer + 2 FC Layers	Softmax	RMSprop	Proposed Loss Function
(Pisano et al., 2020)	1D-CNN	4 Convolutional Units + 2 Pooling Layers + 1 FC Layer	Softmax	SGD	NA
(Lu et al., 2020)	DNN	16 Blocks with Residual Connections	Softmax	NA	NA
(Xu et al., 2020c)	CNN	5 Conv Layers + 5 Max Pooling Layers + 1 Dropout Layer + 2 FC Layers	Softmax	Adam	BCE
(Lin et al., 2020)	Deep ConvNet	5 Conv Layers + 5 Max Pooling Layers + 2 BN Layers + 2 FC Layers	Softmax	NA	NA
(Jana et al., 2020)	1D-CNN	3 Conv Layers + 3 BN Layers + 2 Pooling Layers + 1 Dropout Layer	Softmax	NA	NA
(Gao et al., 2020a)	1D-CNN	2 Conv Layers + 2 Subsampling Layers + 2 FC Layers	Gaussian Connection	Adam	BCE
(Thomas et al., 2020a)	1D-CNN	2 Conv Layers + 1 Max Pooling Layer + 2 FC Layers	NA	Adam	NA
(Vance et al., 2020)	1D-CNN	2 Conv Layers + 1 BN Layer + 1 DownSampling Layer + 5 Pre-Activation Residual Blocks + 1 MaxGlobal Pooling Layer	Sigmoid	SGD	BCE
(Liu and Richardson, 2020)	LSTM	1 Conv Layer + 1 Max Pooling Layer + 1 Dropout Layer + Bi LSTM Layer + 3 FC Layers	Sliding WMV	NA	NA
	1D-CNN	3 Conv Layers + 3 Max Pooling Layers + 2 Dropout Layers + 3 FC Layers			



(Vidyaratne et al., 2016)	DRNN	DRNN Layers	MLP with 2 Layers	Jacobian free Unscented Kalman filter- based parameter optimization method	NA
(Hussein et al., 2018c)	LSTM	1 LSTM Layer + 1 Time Distributed Dense Layer + 1 Average Pooling Layer	Softmax	Adam	CCE
(Ahmedt-Aristizabal et al., 2018b)	LSTM	1 LSTM Layer + 1 Dropout Layer + 1 FC Layer	Sigmoid	Adam	BCE
		2 LSTM Layers + 2 Dropout Layers + 2 FC Layers			
(Yao et al., 2019b)	1D-CNN	5 Conv Layers + 5 Max Pooling Layers + 3 FC Layers	NA	Adam	NA
	IndRNN	15 IndRNN Layers+ 15 BN Layers + 15 Max Pooling Layers + 1 Average Pooling + 2 FC Layers	NA	Adam	NA
	LSTM	1 LSTM Layer + 1 Time Distributed Computing Layer + 1 Average Pooling layer + 1 FC Layer	NA	Adam	NA
(Verma and Janghel, 2021)	RNN	2 GRU Layers + 1 FC Layer	LR	NA	NA
(Hussein et al., 2019)	LSTM	1 LSTM Layer + 1 Time Distributed FC Layer + 1 Average Pooling Layer	Softmax	Adam	CCE
(Jaafar and Mohammadi, 2019)	LSTM	1 LSTM Layer + 1 Time Distributed FC Layer	Softmax	NA	NA
(Hu et al., 2020c)	Bi-LSTM	Bi-LSTM Layer + dropout Layer	Softmax	Adam	Cross Entropy
(Yao et al., 2019a)	ADIndRNN	Attention Layer + 9 IndRNN Layers + 9 BN Layers+3 Max Pooling Layers+ 1 Avg Pooling Layers + 2 FC Layers	NA	Adam	NA
(Talathi, 2017)	GRU	2 GRU Layers + 1 Time Distributed FC Layer	LR	Adam	NA
(Roy et al., 2019)	GRU	4 GRU Layers	Softmax	Adam	NA
	C-RNN	3 Conv Layers + 4 GRU Layers			
	IC-RNN	9 Conv Layers + 4 GRU Layers			
	C-DRNN	3 Conv Layers + 4 GRU Layers			
	ChronoNet	9 Conv Layers + 4 GRU Layers			
(Hussein et al., 2018b)	LSTM	1 LSTM Layer + 1 FC Layer + 1 Max Pooling Layer	Softmax	SGD	CE
(Geng et al., 2020)	Bi-LSTM	1 Bi-LSTM Layer	Softmax	Adam	NA
(Fraivan and Alkhodari, 2020)	Bi-LSTM	1 LSTM Layer + 2 FC Layers	Softmax	Adam	NA
(Hu and Yuan, 2019)	Bi-LSTM	Bi-LSTM Layer	Softmax	Adagrad	NA
(Abbasi et al., 2019)	LSTM	2 LSTM Layers + 2 Dropout Layers + FC Layer	Softmax	Adam	NA
(Yao et al., 2021)	Attention Bi-LSTM	Attention Layer + Bi LSTM Layer + Time-Distributed Fully-Connected Layer + Global Average Pooling Layer + Fully Connected Layer	Softmax	RMSprop	NA
(Patan and Rutkowski, 2021)	LSTM	4 LSTM layers + 4 dropout layers + 1 FC Layer	Softmax	Adam	NA
(Rajaguru and Prabhakar, 2018)	MAE	NA	GA	NA	NA
(Sharathappriyaa et al., 2018)	AE	2 Hidden Layers	Softmax	NA	MSE

(Emami et al., 2019a)	AE	1-layer AE consisting of an Encoder and a Decoder	Sigmoid	Adam	L2 Loss function
(Yuan et al., 2017)	SSDA	2 hidden layers (intra channel) & 3 hidden layer (cross channel) + 2 FC layers	Softmax	NA	CE
(Qiu et al., 2018)	DSAE	1 Hidden Layer	LR	SGD	NA
(Golmohammadi et al., 2019)	SPSW-SDA	Each Model has 3 Hidden Layers	LR	Mini Batch SGD	Cross Entropy
	6W-SDA				
	EYEM-SDA				
(Yan et al., 2016)	SAE	Single Layer	SVM	Batch Gradient Descent	NA
(Lin et al., 2016)	SSAE	3 Hidden Layers	Softmax	L-BFGS	Proposed Loss Function
(Yuan et al., 2019)	Wave2Vec	SAE Layer	Softmax	Adadelata	CE
	SSDAE	2 Hidden Layers	Softmax		
(Gasparini et al., 2018)	SAE	2 Hidden Layers	Softmax	NA	NA
(Karim et al., 2018a)	SSAE	2 Autoencoders	Softmax	Taguchi Method	
(Karim et al., 2019)	DSAEs	2 Autoencoders	Softmax	NA	MSE
(Karim et al., 2018b)	SAE	2 Autoencoders	Softmax	NA	NA
(Yuan et al., 2018c)	SAEs	2 Layers	Softmax	Adam	CE
(Sharma et al., 2020)	SAE	2 Hidden Layers	Softmax	NA	Proposed Loss Function
(Siddharth et al., 2020)	SAE	2 Hidden Layers	SVM	Proposed Optimization	NA
(Le et al., 2018)	DBN	1 Input Layer + 3 Hidden Layers + 1 Output Layer	NA	NA	NA
(Turner et al., 2017)	DBN	1 Input Layer + 2 Hidden Layers + 1 Output Layer	LR	NA	NA
(Tang et al., 2020)	MV CNN-GRU	9 Conv Layers + 9 BN Layers + 6 Max Pooling Layers + ReLU Activation Function + Attention Layer + GRU Layer + 1 FC Layer	Softmax	NA	CE
(Thodoroff et al., 2016)	2D-CNN-LSTM	4 Conv Layers + 2 Pooling Layers + 1 LSTM Layer + 1FC Layer	NA	RMSProp	Gradient Descent (GD)
(Saqib et al., 2020)	2D CNN-LSTM	6 Conv Layer + 6 Max Pooling Layers + 6 BN Layers + ReLU activation function + LSTM Layer + FC Layer + Dropout Layer	Softmax	Adam	NA
(Choi et al., 2019)	3D-CNN-BiGRU	-	NA	Adam	NA
(Liang et al., 2020)	LRCN	10 Conv layers + 5 Max-pooling layers + 1 LSTM Layer	Softmax	Adam	NA
(Roy et al., 2018)	2D-CNN	3 Conv Layers + 3 Max Pooling Layers + 1 FC Layer	Softmax	Adam	NA
	1D-CNN	5 Conv Layers			
	1D-CNN-RNN	3 Conv Layers + 3 GRU Layers			
	TCNN-RNN	3 Conv Layers + 3 Max Pooling + 2 GRU + FC Layers			

(Golmohammadi et al., 2017)	2D-CNN-BiLSTM	3 2D-Conv Layers + 3 2D-Max Pooling layers + 1D-Conv Layer + 1D-Max Pooling Layer + 2 Bi-LSTM	Sigmoid	Adam	MSE
	LSTM	1 LSTM Layer	LR	MSGD	CE
	SdA	3 Hidden Layers	Sigmoid	NA	NA
(Li et al., 2020b)	FC-NLSTM	3 Conv Layers + 2 Pooling Layers + 1 NLSTM Layer + 1 FC Layer	Softmax	Adam	CCE
(Liu et al., 2020b)	C-LSTM	2 Conv Layers + 2 BN Layers + 2 Dropout Layers + 1 LSTM Layer + 2 FC Layers	Softmax	Adam	NA
(Yang et al., 2021)	CNN-LSTM	3 Conv Layers + 3 BN Layers + 2 Max Pooling Layers + 4 Dropout Layers + 3 FC Layers + 1 LSTM Layer	Sigmoid	Adam	BCE
(Xu et al., 2020a)	1D CNN-LSTM	4 Conv Layers + 1 Pooling Layer + 1 Dropout Layer + 2 LSTM Layers + 3 FC Layers	Softmax	NA	NA
(Yuan et al., 2018b)	CNN-AE	Encoder: 2 Conv Layers + 2 Pooling Layers, Decoder: 2 de-Conv Layers + 2 Unpooling Layers	Softmax	Adadelata	CE
(Wen and Zhang, 2018)	CNN-AE	Encoder: 3 Conv Layers + 3 Pooling Layers + 1 FC Layer, Decoder: 1 FC Layer + 4 de-Conv Layers + 3 de-Pooling Layers	Different Classifiers	Adam	Proposed Loss Function
(Abdelhameed et al., 2018)	1D-CNN-AE	8 Conv Layers + 3 Max Pooling Layers + 12 BN Layers + 3 Up sampling Layers	LSTM	Adam	BCE
			Bi-LSTM		
			MLP	Adadelata	MSE
(Antoniades et al., 2018)	CNN-ASAE	4 Conv Layers + 2 FC layers + 2 ASAE Hidden layers	LR	SGD	CE
	CNN-AAE	4 Conv Layers + 2 FC layers + 1 AAE Hidden layer			
(Yuan and Jia, 2019)	CNN-AE	16 Conv Layers + 15 Pooling Layers	Softmax	Adadelata	CE
(Daoud and Bayoumi, 2019)	DCAE	Encoder: 2 Conv Layers + 2 Pooling Layers + 2BN Layers, Decoder: 2 de-Conv Layers + 2 Upsamplign Layers + 2 BN Layers	MLP	RMSprop	MSE
	DCVAE	Encoder: 4 Conv Layers + 4 Pooling Layers + 4 BN Layers 2 FC Layers, Probabilistic Model Parameter Layer Decoder: 2 FC Layers + 4 de-Conv Layers + 4 Upsampling Layers + 4 BN Layers	K-means clustering	RMSprop	BCE
(Shoeibi et al., 2021)	CNN-AE	5 Conv Layers + 4 Pooling Layers + 3 BN Layers + 1 Dropout Layer	Softmax	Adadelata, SGD	NA
(Takahashi et al., 2020)	CNN-AE	1 AE Layer + VGG16	Softmax	NA	NA
(Dev et al., 2019)	FCN	15 Conv Layers + 7 BN Layers + 3 Max Pooling Layers + 3 de-Conv Layers+ 1 Dropout Layer	Sigmoid	Adam	Combination of BCE and the Dice Loss
(Gill et al., 2018)	Two-Stage CNNx Cascade	3 Conv Layers + 2 BN Layers + 3 Max Pooling Layers + 1 Dropout Layer	Softmax	Adadelata	BCE
(Hao et al., 2018)	ResNet	29 Conv Layers + 1 Dropout Layer + 1 FC Layer	Softmax	NA	NA
			Triplet		
(Hosseini et al., 2017)	2D-CNN	NA	SVM	NA	NA
(Yan et al., 2018)	2D-CNN	5 Conv Layers + 3 Max Pooling Layers + 1 BN Layer + 1 FC Layer	Softmax	Adam	NA
	3D-CNN	5 Conv Layers + 3 Max Pooling Layers + 1 BN Layer + 1 FC Layer			

(Gleichgerrcht et al., 2018)	2D-CNN	Proposed Architecture	NA	NA	NA
(Jiang et al., 2019a)	Combination of ResNet50, VGG16, Inception-V3, SVGG-C3D	VGG16 + Global Average Pooling 2D Layer	Different DL Layers	RMSprop	CE
		ResNet50 + Global Average Pooling 2D Layer			
		Inception-V3 + Global Average Pooling 2D Layer			
		SVGG-C3D + Global Average Pooling 2D Layer			
(Shiri et al., 2019)	Deep-DAC	9 Conv Layers + 11 BN Layers + 3 Max Pooling Layers +3 De-Conv Layers + 3 Dropout Layers	Tanh	Adam	MSE
(Wang et al., 2020a)	CNN	5 Convolutional Layers + 5 BN Layers + 1 Max Pooling Layer + 1 Dropout Layer + 2 FC Layers	Softmax	SGDM	CE
(Shakeri et al., 2016)	FCN	7 Conv Layers + 7 holes + 5 Pooling Layers + 4 Dropout (0.5)	Softmax	SGD	Softmax loss
(Figini et al., 2020)	Aniso-U-Net	Proposed U-Net Architecture	-	-	mean voxel-wise square error (MVWSE)
(Pominova et al., 2018)	VoxCNN-B	4 Volumetric Convolutional Blocks + 4 Max Pooling Layers + 2 FC Layers + 1 Dropout Layer	Softmax	Adam	CE
(Xu et al., 2019)	DCNN-CL-ATT	1 Conv Layer + 1 BN Layer + 1 Max Pooling Layer + 4 ResBlocks + 1 Avg Pooling + 1 FC Layer + Dropout Layers + 4 Attention Units	Softmax	Adam	Focal loss, Center loss
(Torres-Velázquez et al., 2020)	mDNN	5 Parallel Neural Network Blocks + 1 Additional Neural Network Block + 2 Concatenation Blocks	Output Layer	Adam	BCE
(Rebsamen et al., 2020)	3D-CNN	3 Conv Layers + 3 Max Pooling Layers + 2 Dropout (0.4) + 3 FC Layers + ReLU Activation Function	-	Adam	MSE
(Si et al., 2020)	Inception_ResNet_v2	Modified Version	Softmax	Adam	CE
(Huang et al., 2020)	CNN	VGG16	SVM	NA	NA
(Lee et al., 2020)	DCNN	ResNet 18	Softmax	Adam	Proposed Loss

## References

- Aarabi, A., Fazel-Rezai, R., and Aghakhani, Y. (2009). A fuzzy rule-based system for epileptic seizure detection in intracranial eeg. *Clinical Neurophysiology*, 120(9):1648–1657.
- Abbasi, B. and Goldenholz, D. M. (2019). Machine learning applications in epilepsy. *Epilepsia*, 60(10):2037–2047.
- Abbasi, M. U., Rashad, A., Basalamah, A., and Tariq, M. (2019). Detection of epilepsy seizures in neo-natal eeg using lstm architecture. *IEEE Access*, 7:179074–179085.
- Abdelfattah, S. M., Abdelrahman, G. M., and Wang, M. (2018). Augmenting the size of eeg datasets using generative adversarial networks. In *2018 International Joint Conference on Neural Networks (IJCNN)*, pages 1–6. IEEE.
- Abdelhameed, A. M., Daoud, H. G., and Bayoumi, M. (2018). Epileptic seizure detection using deep convolutional autoencoder. In *2018 IEEE International Workshop on Signal Processing Systems (SiPS)*, pages 223–228. IEEE.
- Abibullaev, B., Seo, H. D., and Kim, M. S. (2010). Epileptic spike detection using continuous wavelet transforms and artificial neural networks. *International journal of wavelets, multiresolution and information processing*, 8(01):33–48.
- Abiyev, R., Arslan, M., Idoko, J. B., Sekeroglu, B., and Ilhan, A. (2020). Identification of epileptic eeg signals using convolutional neural networks. *Applied Sciences*, 10(12):4089.
- Abou Jaoude, M., Jing, J., Sun, H., Jacobs, C. S., Pellerin, K. R., Westover, M. B., Cash, S. S., and Lam, A. D. (2020). Detection of mesial temporal lobe epileptiform discharges on intracranial electrodes using deep learning. *Clinical Neurophysiology*, 131(1):133–141.
- Abramovici, S. and Bagić, A. (2016). Epidemiology of epilepsy. *Handbook of clinical neurology*, 138:159–171.

- Acharya, U. R., Oh, S. L., Hagiwara, Y., Tan, J. H., and Adeli, H. (2018). Deep convolutional neural network for the automated detection and diagnosis of seizure using eeg signals. *Computers in biology and medicine*, 100:270–278.
- Acharya, U. R., Sree, S. V., Swapna, G., Martis, R. J., and Suri, J. S. (2013). Automated eeg analysis of epilepsy: a review. *Knowledge-Based Systems*, 45:147–165.
- Achilles, F., Tombari, F., Belagiannis, V., Loesch, A. M., Noachtar, S., and Navab, N. (2018). Convolutional neural networks for real-time epileptic seizure detection. *Computer Methods in Biomechanics and Biomedical Engineering: Imaging & Visualization*, 6(3):264–269.
- Ahmedt-Aristizabal, D., Fookes, C., Nguyen, K., Denman, S., Sridharan, S., and Dionisio, S. (2018a). Deep facial analysis: A new phase i epilepsy evaluation using computer vision. *Epilepsy & Behavior*, 82:17–24.
- Ahmedt-Aristizabal, D., Fookes, C., Nguyen, K., and Sridharan, S. (2018b). Deep classification of epileptic signals. In *2018 40th Annual International Conference of the IEEE Engineering in Medicine and Biology Society (EMBC)*, pages 332–335. IEEE.
- Akut, R. (2019). Wavelet based deep learning approach for epilepsy detection. *Health information science and systems*, 7(1):1–9.
- Akyol, K. (2020). Stacking ensemble based deep neural networks modeling for effective epileptic seizure detection. *Expert Systems with Applications*, 148:113239.
- Alam, S. S. and Bhuiyan, M. I. H. (2013). Detection of seizure and epilepsy using higher order statistics in the emd domain. *IEEE journal of biomedical and health informatics*, 17(2):312–318.
- Allhussein, M., Muhammad, G., Hossain, M. S., and Amin, S. U. (2018). Cognitive iot-cloud integration for smart healthcare: case study for epileptic seizure detection and monitoring. *Mobile Networks and Applications*, 23(6):1624–1635.

- Ali, Z. S., Subramanian, N., and Erbad, A. (2020). Smart health monitoring for seizure detection using mobile edge computing. In *2020 International Wireless Communications and Mobile Computing (IWCMC)*, pages 1903–1908. IEEE.
- Alizadehsani, R., Sharifrazi, D., Izadi, N. H., Joloudari, J. H., Shoeibi, A., Gorriz, J. M., Hussain, S., Arco, J. E., Sani, Z. A., Khozeimeh, F., et al. (2021). Uncertainty-aware semi-supervised method using large unlabelled and limited labeled covid-19 data. *arXiv preprint arXiv:2102.06388*.
- Amin, S. U., Hossain, M. S., Muhammad, G., Alhussein, M., and Rahman, M. A. (2019). Cognitive smart healthcare for pathology detection and monitoring. *IEEE Access*, 7:10745–10753.
- Andrzejak, R. G., Lehnertz, K., Mormann, F., Rieke, C., David, P., and Elger, C. E. (2001). Indications of nonlinear deterministic and finite-dimensional structures in time series of brain electrical activity: Dependence on recording region and brain state. *Physical Review E*, 64(6):061907.
- Andrzejak, R. G., Schindler, K., and Rummel, C. (2012). Nonrandomness, nonlinear dependence, and nonstationarity of electroencephalographic recordings from epilepsy patients. *Physical Review E*, 86(4):046206.
- Ansari, A. H., Cherian, P. J., Caicedo, A., Naulaers, G., De Vos, M., and Van Huffel, S. (2019). Neonatal seizure detection using deep convolutional neural networks. *International journal of neural systems*, 29(04):1850011.
- Antoniades, A., Spyrou, L., Martin-Lopez, D., Valentin, A., Alarcon, G., Sanei, S., and Took, C. C. (2018). Deep neural architectures for mapping scalp to intracranial eeg. *International journal of neural systems*, 28(08):1850009.
- Antoniades, A., Spyrou, L., Took, C. C., and Sanei, S. (2016). Deep learning for epileptic intracranial eeg data. In *2016 IEEE 26th International Workshop on Machine Learning for Signal Processing (MLSP)*, pages 1–6. IEEE.
- Asif, U., Roy, S., Tang, J., and Harrer, S. (2019). SeizureNet: a deep convolutional neural network for accurate seizure type classification and seizure detection. *arXiv preprint arXiv:1903.03232*.

- Assi, E. B., Nguyen, D. K., Rihana, S., and Sawan, M. (2017). Towards accurate prediction of epileptic seizures: A review. *Biomedical Signal Processing and Control*, 34:144–157.
- Avcu, M. T., Zhang, Z., and Chan, D. W. S. (2019). Seizure detection using least eeg channels by deep convolutional neural network. In *ICASSP 2019-2019 IEEE international conference on acoustics, speech and signal processing (ICASSP)*, pages 1120–1124. IEEE.
- Ballester, P. and Araujo, R. (2016). On the performance of googlenet and alexnet applied to sketches. In *Proceedings of the AAAI Conference on Artificial Intelligence*, volume 30.
- Bank, D., Koenigstein, N., and Giryes, R. (2020). Autoencoders. *arXiv preprint arXiv:2003.05991*.
- Bao, Y., He, R., Zeng, Q., Zhu, P., Zheng, R., and Xu, H. (2018). Investigation of microstructural abnormalities in white and gray matter around hippocampus with diffusion tensor imaging (dti) in temporal lobe epilepsy (tle). *Epilepsy & Behavior*, 83:44–49.
- Behroozi, M., Daliri, M. R., and Boyaci, H. (2011). Statistical analysis methods for the fmri data. *Basic and Clinical Neuroscience*, 2(4):67–74.
- Bell, M. L., Rao, S., So, E. L., Trenerry, M., Kazemi, N., Matt Stead, S., Cascino, G., Marsh, R., Meyer, F. B., Watson, R. E., et al. (2009). Epilepsy surgery outcomes in temporal lobe epilepsy with a normal mri. *Epilepsia*, 50(9):2053–2060.
- Bhagat, P. N., Ramesh, K., Matcha, V. G. R., and Patil, S. (2020). Robust prior stage epileptic seizure diagnosis system using resnet and backpropagation techniques. *International Journal*, 8(5).
- Bharath, R. D., Panda, R., Raj, J., Bhardwaj, S., Sinha, S., Chaitanya, G., Raghavendra, K., Mundlamuri, R. C., Arimappamagan, A., Rao, M. B., et al. (2019). Machine learning identifies “rsfmri epilepsy networks” in temporal lobe epilepsy. *European radiology*, 29(7):3496–3505.



- Bhattacharjee, I. (2020). Epileptic seizure detection using multicolumn convolutional neural network. In *2020 7th International Conference on Computing for Sustainable Global Development (INDIACom)*, pages 58–63. IEEE.
- Bird, J. J., Faria, D. R., Manso, L. J., Ayrosa, P. P., and Ekart, A. (2021). A study on cnn image classification of eeg signals represented in 2d and 3d. *Journal of Neural Engineering*, 18(2):026005.
- Birjandtalab, J., Pouyan, M. B., Cogan, D., Nourani, M., and Harvey, J. (2017). Automated seizure detection using limited-channel eeg and non-linear dimension reduction. *Computers in biology and medicine*, 82:49–58.
- Bizopoulos, P., Lambrou, G. I., and Koutsouris, D. (2019). Signal2image modules in deep neural networks for eeg classification. In *2019 41st Annual International Conference of the IEEE Engineering in Medicine and Biology Society (EMBC)*, pages 702–705. IEEE.
- Boonyakitanont, P., Lek-uthai, A., Chomtho, K., and Songsiri, J. (2019). A comparison of deep neural networks for seizure detection in eeg signals. *bioRxiv*, page 702654.
- Boonyakitanont, P., Lek-Uthai, A., Chomtho, K., and Songsiri, J. (2020a). A review of feature extraction and performance evaluation in epileptic seizure detection using eeg. *Biomedical Signal Processing and Control*, 57:101702.
- Boonyakitanont, P., Lek-uthai, A., and Songsiri, J. (2020b). Automatic epileptic seizure onset-offset detection based on cnn in scalp eeg. In *ICASSP 2020-2020 IEEE International Conference on Acoustics, Speech and Signal Processing (ICASSP)*, pages 1225–1229. IEEE.
- Boran, E., Sarnthein, J., Krayenbühl, N., Ramantani, G., and Fedele, T. (2019). High-frequency oscillations in scalp eeg mirror seizure frequency in pediatric focal epilepsy. *Scientific reports*, 9(1):1–10.
- Bouallegue, G., Djemal, R., Alshebeili, S. A., and Aldhalaan, H. (2020). A dynamic filtering df-rnn deep-learning-based approach for eeg-based neurological disorders diagnosis. *IEEE Access*, 8:206992–207007.

- Bouaziz, B., Chaari, L., Batatia, H., and Quintero-Rincón, A. (2019). Epileptic seizure detection using a convolutional neural network. In *Digital Health Approach for Predictive, Preventive, Personalised and Participatory Medicine*, pages 79–86. Springer.
- Burda, Y., Grosse, R., and Salakhutdinov, R. (2015). Importance weighted autoencoders. *arXiv preprint arXiv:1509.00519*.
- Cao, J., Zhu, J., Hu, W., and Kummert, A. (2019). Epileptic signal classification with deep eeg features by stacked cnns. *IEEE Transactions on Cognitive and Developmental Systems*, 12(4):709–722.
- Centeno, M. and Carmichael, D. W. (2014). Network connectivity in epilepsy: resting state fmri and eeg–fmri contributions. *Frontiers in neurology*, 5:93.
- Cerulli Irelli, E., Morano, A., Cocchi, E., Casciato, S., Fanella, M., Albini, M., Avorio, F., Basili, L. M., Fisco, G., Barone, F. A., et al. (2020). Doing without valproate in women of childbearing potential with idiopathic generalized epilepsy: Implications on seizure outcome. *Epilepsia*, 61(1):107–114.
- Chapman, K., Wyllie, E., Najm, I., Ruggieri, P., Bingaman, W., Lüders, J., Kotagal, P., Lachhwani, D., Dinner, D., and Lüders, H. (2005). Seizure outcome after epilepsy surgery in patients with normal preoperative mri. *Journal of Neurology, Neurosurgery & Psychiatry*, 76(5):710–713.
- Chatzichristos, C., Dan, J., Narayanan, A. M., Seeuws, N., Vandecasteele, K., De Vos, M., Bertrand, A., and Van Huffel, S. (2020). Epileptic seizure detection in eeg via fusion of multi-view attention-gated u-net deep neural networks. In *Proceedings of the IEEE Signal Processing in Medicine and Biology Symposium (SPMB)*, page 7.
- Chen, M., Shi, X., Zhang, Y., Wu, D., and Guizani, M. (2017a). Deep features learning for medical image analysis with convolutional autoencoder neural network. *IEEE Transactions on Big Data*.
- Chen, X., Ji, J., Ji, T., and Li, P. (2018). Cost-sensitive deep active learning for epileptic seizure detection. In *Proceedings of the 2018 ACM International*

*Conference on Bioinformatics, Computational Biology, and Health Informatics*, pages 226–235.

Chen, Z., Huang, L., Shen, Y., Wang, J., Zhao, R., and Dai, J. (2017b). A new algorithm for classification of ictal and pre-ictal epilepsy ecog using mi and svm. In *2017 International Conference on Signals and Systems (ICSigSys)*, pages 212–216. IEEE.

Cho, K.-O. and Jang, H.-J. (2020). Comparison of different input modalities and network structures for deep learning-based seizure detection. *Scientific reports*, 10(1):1–11.

Choi, G., Park, C., Kim, J., Cho, K., Kim, T.-J., Bae, H., Min, K., Jung, K.-Y., and Chong, J. (2019). A novel multi-scale 3d cnn with deep neural network for epileptic seizure detection. In *2019 IEEE International Conference on Consumer Electronics (ICCE)*, pages 1–2. IEEE.

Clarke, S., Karoly, P. J., Nurse, E., Seneviratne, U., Taylor, J., Knight-Sadler, R., Kerr, R., Moore, B., Hennessy, P., Mendis, D., et al. (2019). Computer-assisted eeg diagnostic review for idiopathic generalized epilepsy. *Epilepsy & Behavior*, page 106556.

Colon, A., van Osch, M., Buijs, M., Grond, J., Hillebrand, A., Schijns, O., Wagner, G., Ossenblok, P., Hofman, P., Buchem, M., et al. (2018). Meg-guided analysis of 7t-mri in patients with epilepsy. *Seizure*, 60:29–38.

Covert, I. C., Krishnan, B., Najm, I., Zhan, J., Shore, M., Hixson, J., and Po, M. J. (2019). Temporal graph convolutional networks for automatic seizure detection. In *Machine Learning for Healthcare Conference*, pages 160–180. PMLR.

Craley, J., Johnson, E., and Venkataraman, A. (2019). Integrating convolutional neural networks and probabilistic graphical modeling for epileptic seizure detection in multichannel eeg. In *International Conference on Information Processing in Medical Imaging*, pages 291–303. Springer.

Daoud, H. and Bayoumi, M. (2019). Deep learning approach for epileptic focus localization. *IEEE transactions on biomedical circuits and systems*, 14(2):209–220.

- Daoud, H., Williams, P., and Bayoumi, M. (2020). Iot based efficient epileptic seizure prediction system using deep learning. In *2020 IEEE 6th World Forum on Internet of Things (WF-IoT)*, pages 1–6. IEEE.
- Daoud, H. G., Abdelhameed, A. M., and Bayoumi, M. (2018). Automatic epileptic seizure detection based on empirical mode decomposition and deep neural network. In *2018 IEEE 14th International Colloquium on Signal Processing & Its Applications (CSPA)*, pages 182–186. IEEE.
- Dash, S., Acharya, B. R., Mittal, M., Abraham, A., and Kelemen, A. G. (2020). *Deep learning techniques for biomedical and health informatics*. Springer.
- Del Gaizo, J., Mofrad, N., Jensen, J. H., Clark, D., Glenn, R., Helpert, J., and Bonilha, L. (2017). Using machine learning to classify temporal lobe epilepsy based on diffusion mri. *Brain and behavior*, 7(10):e00801.
- Dev, K. B., Jogi, P. S., Niyas, S., Vinayagamani, S., Kesavadas, C., and Rajan, J. (2019). Automatic detection and localization of focal cortical dysplasia lesions in mri using fully convolutional neural network. *Biomedical Signal Processing and Control*, 52:218–225.
- Dey, N. (2016). *Classification and clustering in biomedical signal processing*. IGI global.
- Dhull, S. K., Singh, K. K., et al. (2021). A review on automatic epilepsy detection from eeg signals. In *Advances in Communication and Computational Technology*, pages 1441–1454. Springer.
- Duncan, J. S., Sander, J. W., Sisodiya, S. M., and Walker, M. C. (2006). Adult epilepsy. *The Lancet*, 367(9516):1087–1100.
- Ebrahimzadeh, E., Shams, M., Fayaz, F., Rajabion, L., Mirbagheri, M., Araabi, B. N., and Soltanian-Zadeh, H. (2019). Quantitative determination of concordance in localizing epileptic focus by component-based eeg-fmri. *Computer methods and programs in biomedicine*, 177:231–241.
- El Tahry, R., Wang, Z. I., Thandar, A., Podkorytova, I., Krishnan, B., Tousseyn, S., Guiyun, W., Burgess, R. C., and Alexopoulos, A. V. (2018). Magnetoen-

- cephalography and ictal spect in patients with failed epilepsy surgery. *Clinical Neurophysiology*, 129(8):1651–1657.
- Emami, A., Kunii, N., Matsuo, T., Shinozaki, T., Kawai, K., and Takahashi, H. (2019a). Autoencoding of long-term scalp electroencephalogram to detect epileptic seizure for diagnosis support system. *Computers in biology and medicine*, 110:227–233.
- Emami, A., Kunii, N., Matsuo, T., Shinozaki, T., Kawai, K., and Takahashi, H. (2019b). Seizure detection by convolutional neural network-based analysis of scalp electroencephalography plot images. *NeuroImage: Clinical*, 22:101684.
- Fan, M. and Chou, C.-A. (2018). Detecting abnormal pattern of epileptic seizures via temporal synchronization of eeg signals. *IEEE Transactions on Biomedical Engineering*, 66(3):601–608.
- Fergus, P., Hignett, D., Hussain, A., Al-Jumeily, D., and Abdel-Aziz, K. (2015). Automatic epileptic seizure detection using scalp eeg and advanced artificial intelligence techniques. *BioMed research international*, 2015.
- Figini, M., Lin, H., Ogbole, G., Arco, F. D., Blumberg, S. B., Carmichael, D. W., Tanno, R., Kaden, E., Brown, B. J., Lagunju, I., et al. (2020). Image quality transfer enhances contrast and resolution of low-field brain mri in african paediatric epilepsy patients. *arXiv preprint arXiv:2003.07216*.
- Fisher, R. S. (2012). Therapeutic devices for epilepsy. *Annals of neurology*, 71(2):157–168.
- Fraiwani, L. and Alkhodari, M. (2020). Classification of focal and non-focal epileptic patients using single channel eeg and long short-term memory learning system. *IEEE Access*, 8:77255–77262.
- Frauscher, B. and Gotman, J. (2019). Sleep, oscillations, interictal discharges, and seizures in human focal epilepsy. *Neurobiology of disease*, 127:545–553.
- Fukumori, K., Nguyen, H. T. T., Yoshida, N., and Tanaka, T. (2019). Fully data-driven convolutional filters with deep learning models for epileptic spike detection. In *ICASSP 2019-2019 IEEE international conference on acoustics, speech and signal processing (ICASSP)*, pages 2772–2776. IEEE.

- Gaillard, W. D., Balsamo, L., Xu, B., Grandin, C., Braniecki, S., Papero, P., Weinstein, S., Conry, J., Pearl, P., Sachs, B., et al. (2002). Language dominance in partial epilepsy patients identified with an fmri reading task. *Neurology*, 59(2):256–265.
- Gao, J., Sultan, H., Hu, J., and Tung, W.-W. (2009). Denoising nonlinear time series by adaptive filtering and wavelet shrinkage: a comparison. *IEEE signal processing letters*, 17(3):237–240.
- Gao, X., Yan, X., Gao, P., Gao, X., and Zhang, S. (2020a). Automatic detection of epileptic seizure based on approximate entropy, recurrence quantification analysis and convolutional neural networks. *Artificial intelligence in medicine*, 102:101711.
- Gao, Y., Gao, B., Chen, Q., Liu, J., and Zhang, Y. (2020b). Deep convolutional neural network-based epileptic electroencephalogram (eeg) signal classification. *Frontiers in neurology*, 11.
- Garner, R., La Rocca, M., Barisano, G., Toga, A. W., Duncan, D., and Vespa, P. (2019). A machine learning model to predict seizure susceptibility from resting-state fmri connectivity. In *2019 Spring Simulation Conference (SpringSim)*, pages 1–11. IEEE.
- Gasparini, S., Campolo, M., Ieracitano, C., Mammone, N., Ferlazzo, E., Sueri, C., Tripodi, G. G., Aguglia, U., and Morabito, F. C. (2018). Information theoretic-based interpretation of a deep neural network approach in diagnosing psychogenic non-epileptic seizures. *Entropy*, 20(2):43.
- Geng, M., Zhou, W., Liu, G., Li, C., and Zhang, Y. (2020). Epileptic seizure detection based on stockwell transform and bidirectional long short-term memory. *Ieee Transactions on Neural Systems and Rehabilitation Engineering*, 28(3):573–580.
- George, F., Joseph, A., Baby, B., John, A., John, T., Deepak, M., Nithin, G., and Sathidevi, P. (2020). Epileptic seizure prediction using eeg images. In *2020 International Conference on Communication and Signal Processing (ICCSP)*, pages 1595–1598. IEEE.

- Ghassemi, N., Shoeibi, A., and Rouhani, M. (2020). Deep neural network with generative adversarial networks pre-training for brain tumor classification based on mr images. *Biomedical Signal Processing and Control*, 57:101678.
- Ghiasi, G., Cui, Y., Srinivas, A., Qian, R., Lin, T.-Y., Cubuk, E. D., Le, Q. V., and Zoph, B. (2020). Simple copy-paste is a strong data augmentation method for instance segmentation. *arXiv preprint arXiv:2012.07177*.
- Gill, R. S., Hong, S.-J., Fadaie, F., Caldairou, B., Bernhardt, B. C., Barba, C., Brandt, A., Coelho, V. C., d’Incerti, L., Lenge, M., et al. (2018). Deep convolutional networks for automated detection of epileptogenic brain malformations. In *International Conference on Medical Image Computing and Computer-Assisted Intervention*, pages 490–497. Springer.
- Giudice, M. L., Varone, G., Ieracitano, C., Mammone, N., Bruna, A. R., Tomaselli, V., and Morabito, F. C. (2020). 1d convolutional neural network approach to classify voluntary eye blinks in eeg signals for bci applications. In *2020 International Joint Conference on Neural Networks (IJCNN)*, pages 1–7. IEEE.
- Gleichgerricht, E., Munsell, B., Bhatia, S., Vandergrift III, W. A., Rorden, C., McDonald, C., Edwards, J., Kuzniecky, R., and Bonilha, L. (2018). Deep learning applied to whole-brain connectome to determine seizure control after epilepsy surgery. *Epilepsia*, 59(9):1643–1654.
- Gloor, P. and Fariello, R. (1988). Generalized epilepsy: some of its cellular mechanisms differ from those of focal epilepsy. *Trends in neurosciences*, 11(2):63–68.
- Glory, H. A., Vigneswaran, C., Jagtap, S. S., Shruthi, R., Hariharan, G., and Sriram, V. S. (2020). Ahw-bgoa-dnn: a novel deep learning model for epileptic seizure detection. *Neural Computing and Applications*, pages 1–29.
- Golmohammadi, M., Harati Nejad Torbati, A. H., Lopez de Diego, S., Obeid, I., and Picone, J. (2019). Automatic analysis of eegs using big data and hybrid deep learning architectures. *Frontiers in human neuroscience*, 13:76.

- Golmohammadi, M., Ziyabari, S., Shah, V., de Diego, S. L., Obeid, I., and Picone, J. (2017). Deep architectures for automated seizure detection in scalp eegs. *arXiv preprint arXiv:1712.09776*.
- Goodfellow, I., Bengio, Y., Courville, A., and Bengio, Y. (2016). *Deep learning*, volume 1. MIT press Cambridge.
- Goodfellow, I. J., Pouget-Abadie, J., Mirza, M., Xu, B., Warde-Farley, D., Ozair, S., Courville, A., and Bengio, Y. (2014). Generative adversarial networks. *arXiv preprint arXiv:1406.2661*.
- Gotman, J. (2008). Epileptic networks studied with eeg-fmri. *Epilepsia*, 49:42–51.
- Guevara, E., Flores-Castro, J.-A., Peng, K., Nguyen, D. K., Lesage, F., Pouliot, P., and Rosas-Romero, R. (2020). Prediction of epileptic seizures using fnirs and machine learning. *Journal of Intelligent & Fuzzy Systems*, 38(2):2055–2068.
- Guha, A., Ghosh, S., Roy, A., and Chatterjee, S. (2020). Epileptic seizure recognition using deep neural network. In *Emerging Technology in Modelling and Graphics*, pages 21–28. Springer.
- Gupta, V., Bhattacharyya, A., and Pachori, R. B. (2020). Automated identification of epileptic seizures from eeg signals using fbse-ewt method. In *Biomedical Signal Processing*, pages 157–179. Springer.
- Hao, Y., Khoo, H. M., von Ellenrieder, N., Zazubovits, N., and Gotman, J. (2018). Deepied: An epileptic discharge detector for eeg-fmri based on deep learning. *NeuroImage: Clinical*, 17:962–975.
- Hartmann, K. G., Schirrmester, R. T., and Ball, T. (2018). Eeg-gan: Generative adversarial networks for electroencephalographic (eeg) brain signals. *arXiv preprint arXiv:1806.01875*.
- Hazra, D. and Byun, Y.-C. (2020). Synsiggan: Generative adversarial networks for synthetic biomedical signal generation. *Biology*, 9(12):441.
- Hinton, G. E. (2009). Deep belief networks. *Scholarpedia*, 4(5):5947.



- Holden, D., Saito, J., Komura, T., and Joyce, T. (2015). Learning motion manifolds with convolutional autoencoders. In *SIGGRAPH Asia 2015 Technical Briefs*, pages 1–4.
- Hossain, M. S., Amin, S. U., Alsulaiman, M., and Muhammad, G. (2019). Applying deep learning for epilepsy seizure detection and brain mapping visualization. *ACM Transactions on Multimedia Computing, Communications, and Applications (TOMM)*, 15(1s):1–17.
- Hosseini, M.-P., Soltanian-Zadeh, H., Elisevich, K., and Pompili, D. (2016). Cloud-based deep learning of big eeg data for epileptic seizure prediction. In *2016 IEEE global conference on signal and information processing (Global-SIP)*, pages 1151–1155. IEEE.
- Hosseini, M.-P., Tran, T. X., Pompili, D., Elisevich, K., and Soltanian-Zadeh, H. (2017). Deep learning with edge computing for localization of epileptogenicity using multimodal rs-fmri and eeg big data. In *2017 IEEE international conference on autonomic computing (ICAC)*, pages 83–92. IEEE.
- Hsu, K.-Y., Li, H.-Y., and Psaltis, D. (1990). Holographic implementation of a fully connected neural network. *Proceedings of the IEEE*, 78(10):1637–1645.
- Hu, D., Cao, J., Lai, X., Wang, Y., Wang, S., and Ding, Y. (2020a). Epileptic state classification by fusing hand-crafted and deep learning eeg features. *IEEE Transactions on Circuits and Systems II: Express Briefs*.
- Hu, D., Cao, J., Lai, X., Wang, Y., Wang, S., and Ding, Y. (2020b). Epileptic state classification by fusing hand-crafted and deep learning eeg features. *IEEE Transactions on Circuits and Systems II: Express Briefs*.
- Hu, X. and Yuan, Q. (2019). Epileptic eeg identification based on deep bi-lstm network. In *2019 IEEE 11th International Conference on Advanced Infocomm Technology (ICAIT)*, pages 63–66. IEEE.
- Hu, X., Yuan, S., Xu, F., Leng, Y., Yuan, K., and Yuan, Q. (2020c). Scalp eeg classification using deep bi-lstm network for seizure detection. *Computers in Biology and Medicine*, 124:103919.

- Huang, J., Xu, J., Kang, L., and Zhang, T. (2020). Identifying epilepsy based on deep learning using dki images. *Frontiers in Human Neuroscience*, 14:465.
- Hussein, A. F., Arunkumar, N., Gomes, C., Alzubaidi, A. K., Habash, Q. A., Santamaria-Granados, L., Mendoza-Moreno, J. F., and Ramirez-Gonzalez, G. (2018a). Focal and non-focal epilepsy localization: A review. *IEEE Access*, 6:49306–49324.
- Hussein, R., Lee, S., Ward, R., and McKeown, M. J. (2020). Epileptic seizure prediction: A semi-dilated convolutional neural network architecture. *arXiv preprint arXiv:2007.11716*.
- Hussein, R., Palangi, H., Wang, Z. J., and Ward, R. (2018b). Robust detection of epileptic seizures using deep neural networks. In *2018 IEEE International Conference on Acoustics, Speech and Signal Processing (ICASSP)*, pages 2546–2550. IEEE.
- Hussein, R., Palangi, H., Ward, R., and Wang, Z. J. (2018c). Epileptic seizure detection: A deep learning approach. *arXiv preprint arXiv:1803.09848*.
- Hussein, R., Palangi, H., Ward, R. K., and Wang, Z. J. (2019). Optimized deep neural network architecture for robust detection of epileptic seizures using eeg signals. *Clinical Neurophysiology*, 130(1):25–37.
- Iandola, F. N., Han, S., Moskewicz, M. W., Ashraf, K., Dally, W. J., and Keutzer, K. (2016). Squeezenet: Alexnet-level accuracy with 50x fewer parameters and 0.5 mb model size. *arXiv preprint arXiv:1602.07360*.
- Iasemidis, L. D. (2003). Epileptic seizure prediction and control. *IEEE Transactions on Biomedical Engineering*, 50(5):549–558.
- Ieřmantas, T. and Alzbutas, R. (2020). Convolutional neural network for detection and classification of seizures in clinical data. *Medical & Biological Engineering & Computing*, 58(9):1919–1932.
- Ihle, M., Feldwisch-Drentrup, H., Teixeira, C. A., Witon, A., Schelter, B., Timmer, J., and Schulze-Bonhage, A. (2012). Epilepsiae—a european epilepsy database. *Computer methods and programs in biomedicine*, 106(3):127–138.

- Ilakiyaselvan, N., Khan, A. N., and Shahina, A. (2020). Deep learning approach to detect seizure using reconstructed phase space images. *Journal of Biomedical Research*, 34(3):240.
- Jaafar, S. T. and Mohammadi, M. (2019). Epileptic seizure detection using deep learning approach. *UHD Journal of Science and Technology*, 3(2):41–50.
- Jaber, H. A., Aljobouri, H. K., Çankaya, İ., Koçak, O. M., and Algin, O. (2019). Preparing fmri data for postprocessing: Conversion modalities, preprocessing pipeline, and parametric and nonparametric approaches. *IEEE Access*, 7:122864–122877.
- Jana, G. C., Sharma, R., and Agrawal, A. (2020). A 1d-cnn-spectrogram based approach for seizure detection from eeg signal. *Procedia Computer Science*, 167:403–412.
- Jiang, H., Gao, F., Duan, X., Bai, Z., Wang, Z., Ma, X., and Chen, Y.-W. (2019a). Transfer learning and fusion model for classification of epileptic pet images. In *Innovation in Medicine and Healthcare Systems, and Multimedia*, pages 71–79. Springer.
- Jiang, X., Bian, G.-B., and Tian, Z. (2019b). Removal of artifacts from eeg signals: a review. *Sensors*, 19(5):987.
- Karim, A. M., Güzel, M. S., Tolun, M. R., Kaya, H., and Çelebi, F. V. (2018a). A new generalized deep learning framework combining sparse autoencoder and taguchi method for novel data classification and processing. *Mathematical Problems in Engineering*, 2018.
- Karim, A. M., Güzel, M. S., Tolun, M. R., Kaya, H., and Çelebi, F. V. (2019). A new framework using deep auto-encoder and energy spectral density for medical waveform data classification and processing. *Biocybernetics and Biomedical Engineering*, 39(1):148–159.
- Karim, A. M., Karal, Ö., and Çelebi, F. (2018b). A new automatic epilepsy serious detection method by using deep learning based on discrete wavelet transform. *no*, 4:15–18.

- Kaya, D. (2020). The mrmr-cnn based influential support decision system approach to classify eeg signals. *Measurement*, 156:107602.
- Kaziha, O. and Bonny, T. (2020). A convolutional neural network for seizure detection. In *2020 Advances in Science and Engineering Technology International Conferences (ASET)*, pages 1–5. IEEE.
- Keren, G. and Schuller, B. (2016). Convolutional rnn: an enhanced model for extracting features from sequential data. In *2016 International Joint Conference on Neural Networks (IJCNN)*, pages 3412–3419. IEEE.
- Khalifa, Y., Mandic, D., and Sejdić, E. (2020). A review of hidden markov models and recurrent neural networks for event detection and localization in biomedical signals. *Information Fusion*.
- Khalilpour, S., Ranjbar, A., Menhaj, M. B., and Sandooghdar, A. (2020). Application of 1-d cnn to predict epileptic seizures using eeg records. In *2020 6th International Conference on Web Research (ICWR)*, pages 314–318. IEEE.
- Khodatars, M., Shoeibi, A., Ghassemi, N., Jafari, M., Khadem, A., Sadeghi, D., Moridian, P., Hussain, S., Alizadehsani, R., Zare, A., et al. (2020a). Deep learning for neuroimaging-based diagnosis and rehabilitation of autism spectrum disorder: A review. *arXiv preprint arXiv:2007.01285*.
- Khodatars, M., Shoeibi, A., Ghassemi, N., Jafari, M., Khadem, A., Sadeghi, D., Moridian, P., Hussain, S., Alizadehsani, R., Zare, A., et al. (2020b). Deep learning for neuroimaging-based diagnosis and rehabilitation of autism spectrum disorder: A review. *arXiv preprint arXiv:2007.01285*.
- Kim, S.-P. (2018). Preprocessing of eeg. In *Computational EEG Analysis*, pages 15–33. Springer.
- Kiral-Kornek, I., Roy, S., Nurse, E., Mashford, B., Karoly, P., Carroll, T., Payne, D., Saha, S., Baldassano, S., O’Brien, T., et al. (2018). Epileptic seizure prediction using big data and deep learning: toward a mobile system. *EBioMedicine*, 27:103–111.
- Kowalczyk, M. A., Omidvarnia, A., Abbott, D. F., Tailby, C., Vaughan, D. N., and Jackson, G. D. (2020). Clinical benefit of presurgical eeg-fmri in difficult-

- to-localize focal epilepsy: A single-institution retrospective review. *Epilepsia*, 61(1):49–60.
- Krizhevsky, A. and Hinton, G. (2010). Convolutional deep belief networks on cifar-10. *Unpublished manuscript*, 40(7):1–9.
- Kwak, Y., Kong, K., Song, W.-J., Min, B.-K., and Kim, S.-E. (2020). Multilevel feature fusion with 3d convolutional neural network for eeg-based workload estimation. *IEEE Access*, 8:16009–16021.
- Lai, C. Q., Ibrahim, H., Abdullah, M. Z., Abdullah, J. M., Suandi, S. A., and Azman, A. (2018). Artifacts and noise removal for electroencephalogram (eeg): A literature review. In *2018 IEEE Symposium on Computer Applications & Industrial Electronics (ISCAIE)*, pages 326–332. IEEE.
- Lashgari, E., Liang, D., and Maoz, U. (2020). Data augmentation for deep-learning-based electroencephalography. *Journal of Neuroscience Methods*, page 108885.
- Le, T. X., Le, T. T., Dinh, V. V., Tran, Q. L., Nguyen, L. T., and Nguyen, D. T. (2018). Deep learning for epileptic spike detection. *VNU Journal of Science: Computer Science and Communication Engineering*, 33(2):1–13.
- Lee, M.-H., O’Hara, N., Sonoda, M., Kuroda, N., Juhasz, C., Asano, E., Dong, M., and Jeong, J.-W. (2020). Novel deep learning network analysis of electrical stimulation mapping-driven diffusion mri tractography to improve pre-operative evaluation of pediatric epilepsy. *IEEE Transactions on Biomedical Engineering*, 67(11):3151–3162.
- LeVan, P., Urrestarazu, E., and Gotman, J. (2006). A system for automatic artifact removal in ictal scalp eeg based on independent component analysis and bayesian classification. *Clinical neurophysiology*, 117(4):912–927.
- Li, J., Li, B., Xu, J., Xiong, R., and Gao, W. (2018). Fully connected network-based intra prediction for image coding. *IEEE Transactions on Image Processing*, 27(7):3236–3247.

- Li, S., Kawale, J., and Fu, Y. (2015). Deep collaborative filtering via marginalized denoising auto-encoder. In *Proceedings of the 24th ACM international on conference on information and knowledge management*, pages 811–820.
- Li, Y., Liu, Y., Cui, W.-G., Guo, Y.-Z., Huang, H., and Hu, Z.-Y. (2020a). Epileptic seizure detection in eeg signals using a unified temporal-spectral squeeze-and-excitation network. *IEEE Transactions on Neural Systems and Rehabilitation Engineering*, 28(4):782–794.
- Li, Y., Yu, Z., Chen, Y., Yang, C., Li, Y., Allen Li, X., and Li, B. (2020b). Automatic seizure detection using fully convolutional nested lstm. *International journal of neural systems*, 30(04):2050019.
- Lian, J., Zhang, Y., Luo, R., Han, G., Jia, W., and Li, C. (2020). Pair-wise matching of eeg signals for epileptic identification via convolutional neural network. *IEEE Access*, 8:40008–40017.
- Liang, W., Pei, H., Cai, Q., and Wang, Y. (2020). Scalp eeg epileptogenic zone recognition and localization based on long-term recurrent convolutional network. *Neurocomputing*, 396:569–576.
- Lin, L.-C., Ouyang, C.-S., Wu, R.-C., Yang, R.-C., and Chiang, C.-T. (2020). Alternative diagnosis of epilepsy in children without epileptiform discharges using deep convolutional neural networks. *International journal of neural systems*, 30(05):1850060.
- Lin, Q., Ye, S.-q., Huang, X.-m., Li, S.-y., Zhang, M.-z., Xue, Y., and Chen, W.-S. (2016). Classification of epileptic eeg signals with stacked sparse autoencoder based on deep learning. In *International Conference on Intelligent Computing*, pages 802–810. Springer.
- Liu, F., Wang, Y., Li, M., Wang, W., Li, R., Zhang, Z., Lu, G., and Chen, H. (2017). Dynamic functional network connectivity in idiopathic generalized epilepsy with generalized tonic-clonic seizure. *Human brain mapping*, 38(2):957–973.
- Liu, G., Zhou, W., and Geng, M. (2020a). Automatic seizure detection based on s-transform and deep convolutional neural network. *International journal of neural systems*, 30(04):1950024.

- Liu, J. and Woodson, B. (2019). Deep learning classification for epilepsy detection using a single channel electroencephalography (eeg). In *Proceedings of the 2019 3rd International Conference on Deep Learning Technologies*, pages 23–26.
- Liu, X. and Richardson, A. G. (2020). Embedded deep learning for neural implants. *arXiv preprint arXiv:2012.00307*.
- Liu, Y., Huang, Y.-X., Zhang, X., Qi, W., Guo, J., Hu, Y., Zhang, L., and Su, H. (2020b). Deep c-lstm neural network for epileptic seizure and tumor detection using high-dimension eeg signals. *IEEE Access*, 8:37495–37504.
- Liu, Y., Zhou, W., Yuan, Q., and Chen, S. (2012). Automatic seizure detection using wavelet transform and svm in long-term intracranial eeg. *IEEE transactions on neural systems and rehabilitation engineering*, 20(6):749–755.
- Lu, D., Bauer, S., Neubert, V., Costard, L. S., Rosenow, F., and Triesch, J. (2020). Staging epileptogenesis with deep neural networks. In *Proceedings of the 11th ACM International Conference on Bioinformatics, Computational Biology and Health Informatics*, pages 1–10.
- Lu, D. and Triesch, J. (2019). Residual deep convolutional neural network for eeg signal classification in epilepsy. *arXiv preprint arXiv:1903.08100*.
- Luo, C., Li, Q., Lai, Y., Xia, Y., Qin, Y., Liao, W., Li, S., Zhou, D., Yao, D., and Gong, Q. (2011). Altered functional connectivity in default mode network in absence epilepsy: a resting-state fmri study. *Human brain mapping*, 32(3):438–449.
- Ma, K., Zhang, X., Zhang, H., Yan, X., Gao, A., Song, C., Wang, S., Lian, Y., and Cheng, J. (2020). Mean apparent propagator-mri: a new diffusion model which improves temporal lobe epilepsy lateralization. *European journal of radiology*, 126:108914.
- Madhavan, S., Tripathy, R. K., and Pachori, R. B. (2019). Time-frequency domain deep convolutional neural network for the classification of focal and non-focal eeg signals. *IEEE Sensors Journal*, 20(6):3078–3086.

- Makhzani, A., Shlens, J., Jaitly, N., Goodfellow, I., and Frey, B. (2015). Adversarial autoencoders. *arXiv preprint arXiv:1511.05644*.
- Makropoulos, A., Counsell, S. J., and Rueckert, D. (2018). A review on automatic fetal and neonatal brain mri segmentation. *NeuroImage*, 170:231–248.
- Manjón, J. V. (2017). Mri preprocessing. In *Imaging Biomarkers*, pages 53–63. Springer.
- Mao, W., Fathurrahman, H., Lee, Y., and Chang, T. (2020). Eeg dataset classification using cnn method. In *Journal of Physics: Conference Series*, volume 1456, page 012017. IOP Publishing.
- Mei, Z., Zhao, X., Chen, H., and Chen, W. (2018). Bio-signal complexity analysis in epileptic seizure monitoring: A topic review. *Sensors*, 18(6):1720.
- Meisel, C., Atrache, R. E., Jackson, M., Schubach, S., Ufongene, C., and Loddenkemper, T. (2019). Deep learning from wristband sensor data: towards wearable, non-invasive seizure forecasting. *arXiv preprint arXiv:1906.00511*.
- Misiūnas, A. V. M., Meškauskas, T., and Samaitienė, R. (2019). Algorithm for automatic eeg classification according to the epilepsy type: Benign focal childhood epilepsy and structural focal epilepsy. *Biomedical signal processing and control*, 48:118–127.
- Modir, A., Khalilzadeh, M. A., and Gorji, A. (2017). Detection of focal epileptic seizure using nirs signal based on discrete wavelet transform. *International Clinical Neuroscience Journal*, 4(4):134.
- Mohammadpoor, M., Shoeibi, A., Shojaee, H., et al. (2016). A hierarchical classification method for breast tumor detection. *Iranian Journal of Medical Physics*, 13(4):261–268.
- Mohammadpoory, Z., Nasrolahzadeh, M., Mahmoodian, N., Sayyah, M., and Haddadnia, J. (2019). Complex network based models of ecog signals for detection of induced epileptic seizures in rats. *Cognitive neurodynamics*, 13(4):325–339.



- MohanBabu, G., Anupallavi, S., and Ashokkumar, S. (2020). An optimized deep learning network model for eeg based seizure classification using synchronization and functional connectivity measures. *Journal of Ambient Intelligence and Humanized Computing*, pages 1–13.
- Muhammad, G., Masud, M., Amin, S. U., Alrobaea, R., and Alhamid, M. F. (2018). Automatic seizure detection in a mobile multimedia framework. *IEEE Access*, 6:45372–45383.
- Naik, G., Chai, R., Su, S., Rong, S., and Nguyen, H. T. (2020). Comparison of independence of triceps brachii and biceps brachii between paretic and non-paretic side during different mvcs—a case study. In *Biomedical Signal Processing*, pages 71–79. Springer.
- Nair, D. R., Laxer, K. D., Weber, P. B., Murro, A. M., Park, Y. D., Barkley, G. L., Smith, B. J., Gwinn, R. P., Doherty, M. J., Noe, K. H., et al. (2020). Nine-year prospective efficacy and safety of brain-responsive neurostimulation for focal epilepsy. *Neurology*, 95(9):e1244–e1256.
- Nejedly, P., Kremen, V., Sladky, V., Nasser, M., Guragain, H., Klimes, P., Cimbalknik, J., Varatharajah, Y., Brinkmann, B. H., and Worrell, G. A. (2019). Deep-learning for seizure forecasting in canines with epilepsy. *Journal of neural engineering*, 16(3):036031.
- Ngoh, A. and Parker, A. P. (2017). New developments in epilepsy management. *Paediatrics and Child Health*, 27(6):281–286.
- Nguyen, D. K., Tremblay, J., Pouliot, P., Vannasing, P., Florea, O., Carmant, L., Lepore, F., Sawan, M., Lesage, F., and Lassonde, M. (2012). Non-invasive continuous eeg-fnirs recording of temporal lobe seizures. *Epilepsy research*, 99(1-2):112–126.
- Noachtar, S. and Peters, A. S. (2009). Semiology of epileptic seizures: a critical review. *Epilepsy & Behavior*, 15(1):2–9.
- Noble, W. S. (2006). What is a support vector machine? *Nature biotechnology*, 24(12):1565–1567.

- Ocak, H. (2009). Automatic detection of epileptic seizures in eeg using discrete wavelet transform and approximate entropy. *Expert Systems with Applications*, 36(2):2027–2036.
- Oldan, J. D., Shin, H. W., Khandani, A. H., Zamora, C., Benefield, T., and Jewells, V. (2018). Subsequent experience in hybrid pet-mri for evaluation of refractory focal onset epilepsy. *Seizure*, 61:128–134.
- O’Shea, A., Lightbody, G., Boylan, G., and Temko, A. (2017a). Neonatal seizure detection using convolutional neural networks. In *2017 IEEE 27th International Workshop on Machine Learning for Signal Processing (MLSP)*, pages 1–6. IEEE.
- O’Shea, A., Lightbody, G., Boylan, G., and Temko, A. (2017b). Neonatal seizure detection using convolutional neural networks. In *2017 IEEE 27th International Workshop on Machine Learning for Signal Processing (MLSP)*, pages 1–6. IEEE.
- Pachori, R. B. and Bajaj, V. (2011). Analysis of normal and epileptic seizure eeg signals using empirical mode decomposition. *Computer methods and programs in biomedicine*, 104(3):373–381.
- Page, A., Shea, C., and Mohsenin, T. (2016). Wearable seizure detection using convolutional neural networks with transfer learning. In *2016 IEEE International Symposium on Circuits and Systems (ISCAS)*, pages 1086–1089. IEEE.
- Park, B.-y., Byeon, K., and Park, H. (2019). Funp (fusion of neuroimaging preprocessing) pipelines: a fully automated preprocessing software for functional magnetic resonance imaging. *Frontiers in neuroinformatics*, 13:5.
- Park, C., Choi, G., Kim, J., Kim, S., Kim, T.-J., Min, K., Jung, K.-Y., and Chong, J. (2018). Epileptic seizure detection for multi-channel eeg with deep convolutional neural network. In *2018 International Conference on Electronics, Information, and Communication (ICEIC)*, pages 1–5. IEEE.
- Pascual, D., Aminifar, A., Atienza, D., Ryvlin, P., and Wattenhofer, R. (2019). Synthetic epileptic brain activities using gans. In *Machine Learning for Health (ML4H) at the 33rd Conf. on Neural Information Processing Systems*.

- Patan, K. and Rutkowski, G. (2021). Application of deep learning to seizure classification. In *Advances in Diagnostics of Processes and Systems*, pages 157–172. Springer.
- Patro, S. and Sahu, K. K. (2015). Normalization: A preprocessing stage. *arXiv preprint arXiv:1503.06462*.
- Paul, Y. (2018). Various epileptic seizure detection techniques using biomedical signals: a review. *Brain informatics*, 5(2):1–19.
- Pellegrino, G., Mecarelli, O., Pulitano, P., Tombini, M., Ricci, L., Lanzone, J., Brienza, M., Davassi, C., Di Lazzaro, V., and Assenza, G. (2018). Eslicarbazepine acetate modulates eeg activity and connectivity in focal epilepsy. *Frontiers in neurology*, 9:1054.
- Peng, K., Nguyen, D. K., Tayah, T., Vannasing, P., Tremblay, J., Sawan, M., Lassonde, M., Lesage, F., and Pouliot, P. (2014). fnirs-eeg study of focal interictal epileptiform discharges. *Epilepsy research*, 108(3):491–505.
- Peng, K., Nguyen, D. K., Vannasing, P., Tremblay, J., Lesage, F., and Pouliot, P. (2016). Using patient-specific hemodynamic response function in epileptic spike analysis of human epilepsy: a study based on eeg–fnirs. *NeuroImage*, 126:239–255.
- Peng, W. (2019). Eeg preprocessing and denoising. In *EEG Signal Processing and Feature Extraction*, pages 71–87. Springer.
- Pisano, F., Sias, G., Fanni, A., Cannas, B., Dourado, A., Pisano, B., and Teixeira, C. A. (2020). Convolutional neural network for seizure detection of nocturnal frontal lobe epilepsy. *Complexity*, 2020.
- Polat, K. and Güneş, S. (2007). Classification of epileptiform eeg using a hybrid system based on decision tree classifier and fast fourier transform. *Applied Mathematics and Computation*, 187(2):1017–1026.
- Pominova, M., Artemov, A., Sharaev, M., Kondrateva, E., Bernstein, A., and Burnaev, E. (2018). Voxelwise 3d convolutional and recurrent neural networks for epilepsy and depression diagnostics from structural and functional mri

- data. In *2018 IEEE International Conference on Data Mining Workshops (ICDMW)*, pages 299–307. IEEE.
- Pouliot, P., Tremblay, J., Robert, M., Vannasing, P., Lepore, F., Lassonde, M., Sawan, M., Nguyen, D. K., and Lesage, F. (2012). Nonlinear hemodynamic responses in human epilepsy: a multimodal analysis with fnirs-eeg and fmri-eeg. *Journal of neuroscience methods*, 204(2):326–340.
- Prasanth, T., Thomas, J., Yuvaraj, R., Jing, J., Cash, S. S., Chaudhari, R., Leng, T. Y., Rathakrishnan, R., Rohit, S., Saini, V., et al. (2020). Deep learning for interictal epileptiform spike detection from scalp eeg frequency sub bands. In *2020 42nd Annual International Conference of the IEEE Engineering in Medicine & Biology Society (EMBC)*, pages 3703–3706. IEEE.
- Qin, H., Deng, B., Wang, J., Yi, G., Wang, R., and Zhang, Z. (2020a). Deep multi-scale feature fusion convolutional neural network for automatic epilepsy detection using eeg signals. In *2020 39th Chinese Control Conference (CCC)*, pages 7061–7066. IEEE.
- Qin, Y., Zheng, H., Chen, W., Qin, Q., Han, C., and Che, Y. (2020b). Patient-specific seizure prediction with scalp eeg using convolutional neural network and extreme learning machine. In *2020 39th Chinese Control Conference (CCC)*, pages 7622–7625. IEEE.
- Qiu, Y., Zhou, W., Yu, N., and Du, P. (2018). Denoising sparse autoencoder-based ictal eeg classification. *IEEE Transactions on Neural Systems and Rehabilitation Engineering*, 26(9):1717–1726.
- Raghu, S., Sriraam, N., Temel, Y., Rao, S. V., and Kubben, P. L. (2020). Eeg based multi-class seizure type classification using convolutional neural network and transfer learning. *Neural Networks*, 124:202–212.
- Rajaguru, H. and Prabhakar, S. K. (2018). Multilayer autoencoders and em-pca with genetic algorithm for epilepsy classification from eeg. In *2018 Second International Conference on Electronics, Communication and Aerospace Technology (ICECA)*, pages 353–358. IEEE.

- Rampp, S., Stefan, H., Wu, X., Kaltenhäuser, M., Maess, B., Schmitt, F. C., Wolters, C. H., Hamer, H., Kasper, B. S., Schwab, S., et al. (2019). Magnetoencephalography for epileptic focus localization in a series of 1000 cases. *Brain*, 142(10):3059–3071.
- Rashed-Al-Mahfuz, M., Moni, M. A., Uddin, S., Alyami, S. A., Summers, M. A., and Eapen, V. (2021). A deep convolutional neural network method to detect seizures and characteristic frequencies using epileptic electroencephalogram (eeg) data. *IEEE Journal of Translational Engineering in Health and Medicine*, 9:1–12.
- Rasheed, K., Qayyum, A., Qadir, J., Sivathamboo, S., Kwan, P., Kuhlmann, L., O’Brien, T., and Razi, A. (2020). Machine learning for predicting epileptic seizures using eeg signals: A review. *IEEE Reviews in Biomedical Engineering*.
- RaviPrakash, H., Korostenskaja, M., Castillo, E. M., Lee, K. H., Salinas, C. M., Baumgartner, J., Anwar, S. M., Spampinato, C., and Bagci, U. (2020). Deep learning provides exceptional accuracy to ecog-based functional language mapping for epilepsy surgery. *Frontiers in Neuroscience*, 14:409.
- Rebsamen, M., Suter, Y., Wiest, R., Reyes, M., and Rummel, C. (2020). Brain morphometry estimation: From hours to seconds using deep learning. *Frontiers in neurology*, 11:244.
- Rosas-Romero, R., Guevara, E., Peng, K., Nguyen, D. K., Lesage, F., Pouliot, P., and Lima-Saad, W.-E. (2019). Prediction of epileptic seizures with convolutional neural networks and functional near-infrared spectroscopy signals. *Computers in biology and medicine*, 111:103355.
- Roy, S., Kiral-Kornek, I., and Harrer, S. (2018). Deep learning enabled automatic abnormal eeg identification. In *2018 40th Annual International Conference of the IEEE Engineering in Medicine and Biology Society (EMBC)*, pages 2756–2759. IEEE.
- Roy, S., Kiral-Kornek, I., and Harrer, S. (2019). Chrononet: a deep recurrent neural network for abnormal eeg identification. In *Conference on Artificial Intelligence in Medicine in Europe*, pages 47–56. Springer.

- Rüber, T., David, B., and Elger, C. E. (2018). Mri in epilepsy: clinical standard and evolution. *Current opinion in neurology*, 31(2):223–231.
- Saab, M. and Gotman, J. (2005). A system to detect the onset of epileptic seizures in scalp eeg. *Clinical Neurophysiology*, 116(2):427–442.
- Sadeghi, D., Shoeibi, A., Ghassemi, N., Moridian, P., Khadem, A., Alizadehsani, R., Teshnehlab, M., Gorriz, J. M., and Nahavandi, S. (2021). An overview on artificial intelligence techniques for diagnosis of schizophrenia based on magnetic resonance imaging modalities: Methods, challenges, and future works. *arXiv preprint arXiv:2103.03081*.
- Sajjad, M., Khan, S., Muhammad, K., Wu, W., Ullah, A., and Baik, S. W. (2019). Multi-grade brain tumor classification using deep cnn with extensive data augmentation. *Journal of computational science*, 30:174–182.
- Sakai, T., Shoji, T., Yoshida, N., Fukumori, K., Tanaka, Y., and Tanaka, T. (2020). Scalpnet: Detection of spatiotemporal abnormal intervals in epileptic eeg using convolutional neural networks. In *ICASSP 2020-2020 IEEE International Conference on Acoustics, Speech and Signal Processing (ICASSP)*, pages 1244–1248. IEEE.
- Samiee, K., Kovacs, P., and Gabbouj, M. (2014). Epileptic seizure classification of eeg time-series using rational discrete short-time fourier transform. *IEEE transactions on Biomedical Engineering*, 62(2):541–552.
- San-Segundo, R., Gil-Martín, M., D’Haro-Enriquez, L. F., and Pardo, J. M. (2019). Classification of epileptic eeg recordings using signal transforms and convolutional neural networks. *Computers in biology and medicine*, 109:148–158.
- Saqib, M., Zhu, Y., Wang, M., and Beaulieu-Jones, B. (2020). Regularization of deep neural networks for eeg seizure detection to mitigate overfitting. In *2020 IEEE 44th Annual Computers, Software, and Applications Conference (COMPSAC)*, pages 664–673. IEEE.
- Sayem, M. A., Sarker, M. S. R., Ahad, M. A. R., and Ahmed, M. U. (2021). Automatic epileptic seizures detection and eeg signals classification based on

- multi-domain feature extraction and multiscale entropy analysis. In *Signal Processing Techniques for Computational Health Informatics*, pages 315–334. Springer.
- Schlegl, T., Seeböck, P., Waldstein, S. M., Langs, G., and Schmidt-Erfurth, U. (2019). f-anogan: Fast unsupervised anomaly detection with generative adversarial networks. *Medical image analysis*, 54:30–44.
- Schroff, F., Kalenichenko, D., and Philbin, J. (2015). Facenet: A unified embedding for face recognition and clustering. In *Proceedings of the IEEE conference on computer vision and pattern recognition*, pages 815–823.
- Shakeri, M., Tsogkas, S., Ferrante, E., Lippe, S., Kadoury, S., Paragios, N., and Kokkinos, I. (2016). Sub-cortical brain structure segmentation using f-cnn’s. In *2016 IEEE 13th International Symposium on Biomedical Imaging (ISBI)*, pages 269–272. IEEE.
- Shankar, A., Khaing, H. K., Dandapat, S., and Barma, S. (2020). Epileptic seizure classification based on gramian angular field transformation and deep learning. In *2020 IEEE Applied Signal Processing Conference (ASPCON)*, pages 147–151. IEEE.
- Sharan, R. V. and Berkovsky, S. (2020). Epileptic seizure detection using multi-channel eeg wavelet power spectra and 1-d convolutional neural networks. In *2020 42nd Annual International Conference of the IEEE Engineering in Medicine & Biology Society (EMBC)*, pages 545–548. IEEE.
- Sharathappriyaa, V., Gautham, S., and Lavanya, R. (2018). Auto-encoder based automated epilepsy diagnosis. In *2018 International Conference on Advances in Computing, Communications and Informatics (ICACCI)*, pages 976–982. IEEE.
- Sharifrazi, D., Alizadehsani, R., Roshanzamir, M., Joloudari, J. H., Shoeibi, A., Jafari, M., Hussain, S., Sani, Z. A., Hasanzadeh, F., Khozeimeh, F., et al. (2021). Fusion of convolution neural network, support vector machine and sobel filter for accurate detection of covid-19 patients using x-ray images. *Biomedical Signal Processing and Control*, page 102622.

- Sharma, R. and Pachori, R. B. (2015). Classification of epileptic seizures in eeg signals based on phase space representation of intrinsic mode functions. *Expert Systems with Applications*, 42(3):1106–1117.
- Sharma, R., Pachori, R. B., and Sircar, P. (2020). Seizures classification based on higher order statistics and deep neural network. *Biomedical Signal Processing and Control*, 59:101921.
- Sharmila, A. (2018). Epilepsy detection from eeg signals: a review. *Journal of medical engineering & technology*, 42(5):368–380.
- Shiri, I., Ghafarian, P., Geramifar, P., Leung, K. H.-Y., Ghelichoghli, M., Oveisi, M., Rahmim, A., and Ay, M. R. (2019). Direct attenuation correction of brain pet images using only emission data via a deep convolutional encoder-decoder (deep-dac). *European radiology*, 29(12):6867–6879.
- Shoeb, A. H. (2009a). *Application of machine learning to epileptic seizure onset detection and treatment*. PhD thesis, Massachusetts Institute of Technology.
- Shoeb, A. H. (2009b). *Application of machine learning to epileptic seizure onset detection and treatment*. PhD thesis, Massachusetts Institute of Technology.
- Shoeb, A. H. and Guttag, J. V. (2010). Application of machine learning to epileptic seizure detection. In *Proceedings of the 27th International Conference on Machine Learning (ICML-10)*, pages 975–982.
- Shoeibi, A., Ghassemi, N., Alizadehsani, R., Rouhani, M., Hosseini-Nejad, H., Khosravi, A., Panahiazar, M., and Nahavandi, S. (2021). A comprehensive comparison of handcrafted features and convolutional autoencoders for epileptic seizures detection in eeg signals. *Expert Systems with Applications*, 163:113788.
- Shoeibi, A., Khodatars, M., Alizadehsani, R., Ghassemi, N., Jafari, M., Moridian, P., Khadem, A., Sadeghi, D., Hussain, S., Zare, A., et al. (2020). Automated detection and forecasting of covid-19 using deep learning techniques: A review. *arXiv preprint arXiv:2007.10785*.



- Shoka, A., Dessouky, M., El-Sherbeny, A., and El-Sayed, A. (2019). Literature review on eeg preprocessing, feature extraction, and classifications techniques. *Menoufia J. Electron. Eng. Res*, 28(1):292–299.
- Si, X., Zhang, X., Zhou, Y., Sun, Y., Jin, W., Yin, S., Zhao, X., Li, Q., and Ming, D. (2020). Automated detection of juvenile myoclonic epilepsy using cnn based transfer learning in diffusion mri. In *2020 42nd Annual International Conference of the IEEE Engineering in Medicine & Biology Society (EMBC)*, pages 1679–1682. IEEE.
- Siddharth, T., Gajbhiye, P., Tripathy, R. K., and Pachori, R. B. (2020). Eeg-based detection of focal seizure area using fbse-ewt rhythm and sae-svm network. *IEEE Sensors Journal*, 20(19):11421–11428.
- Siddiqui, M. K., Islam, M. Z., and Kabir, M. A. (2019). A novel quick seizure detection and localization through brain data mining on ecog dataset. *Neural Computing and Applications*, 31(9):5595–5608.
- Siddiqui, M. K., Morales-Menendez, R., Huang, X., and Hussain, N. (2020). A review of epileptic seizure detection using machine learning classifiers. *Brain informatics*, 7:1–18.
- Singh, A., Pusarla, N., Sharma, S., and Kumar, T. (2020). Cnn-based epilepsy detection using image like features of eeg signals. In *2020 International Conference on Electrical and Electronics Engineering (ICE3)*, pages 280–284. IEEE.
- Singh, K. and Malhotra, J. (2018). Stacked autoencoders based deep learning approach for automatic epileptic seizure detection. In *2018 First International Conference on Secure Cyber Computing and Communication (IC-SCCC)*, pages 249–254. IEEE.
- Sirpal, P., Kassab, A., Pouliot, P., Nguyen, D. K., and Lesage, F. (2019). fnirs improves seizure detection in multimodal eeg-fnirs recordings. *Journal of biomedical optics*, 24(5):051408.
- Skarpaas, T. L., Jarosiewicz, B., and Morrell, M. J. (2019). Brain-responsive neurostimulation for epilepsy (rns® system). *Epilepsy research*, 153:68–70.

- Sønderby, C. K., Raiko, T., Maaløe, L., Sønderby, S. K., and Winther, O. (2016). Ladder variational autoencoders. *arXiv preprint arXiv:1602.02282*.
- Stevenson, N., Tapani, K., Lauronen, L., and Vanhatalo, S. (2019). A dataset of neonatal eeg recordings with seizure annotations. *Scientific data*, 6(1):1–8.
- Subasi, A. (2005). Epileptic seizure detection using dynamic wavelet network. *Expert Systems with Applications*, 29(2):343–355.
- Sui, L., Zhao, X., Zhao, Q., Tanaka, T., and Cao, J. (2019). Localization of epileptic foci by using convolutional neural network based on ieeg. In *IFIP International Conference on Artificial Intelligence Applications and Innovations*, pages 331–339. Springer.
- Sun, Y., Liang, D., Wang, X., and Tang, X. (2015). Deepid3: Face recognition with very deep neural networks. *arXiv preprint arXiv:1502.00873*.
- Sung, F., Yang, Y., Zhang, L., Xiang, T., Torr, P. H., and Hospedales, T. M. (2018). Learning to compare: Relation network for few-shot learning. In *Proceedings of the IEEE conference on computer vision and pattern recognition*, pages 1199–1208.
- Tak, S. and Ye, J. C. (2014). Statistical analysis of fnirs data: a comprehensive review. *Neuroimage*, 85:72–91.
- Takahashi, H., Emami, A., Shinozaki, T., Kunii, N., Matsuo, T., and Kawai, K. (2020). Convolutional neural network with autoencoder-assisted multi-class labelling for seizure detection based on scalp electroencephalography. *Computers in Biology and Medicine*, 125:104016.
- Talathi, S. S. (2017). Deep recurrent neural networks for seizure detection and early seizure detection systems. *arXiv preprint arXiv:1706.03283*.
- Tan, M. and Le, Q. (2019). Efficientnet: Rethinking model scaling for convolutional neural networks. In *International Conference on Machine Learning*, pages 6105–6114. PMLR.
- Tang, L., Xie, N., Zhao, M., and Wu, X. (2020). Seizure prediction using multi-view features and improved convolutional gated recurrent network. *IEEE Access*, 8:172352–172361.

- Taqi, A. M., Al-Azzo, F., Mariofanna, M., and Al-Saadi, J. M. (2017). Classification and discrimination of focal and non-focal eeg signals based on deep neural network. In *2017 international conference on current research in computer science and information technology (ICCCIT)*, pages 86–92. IEEE.
- Targ, S., Almeida, D., and Lyman, K. (2016). Resnet in resnet: Generalizing residual architectures. *arXiv preprint arXiv:1603.08029*.
- Thanaraj, K. P., Parvathavarthini, B., Tanik, U. J., Rajinikanth, V., Kadry, S., and Kamalanand, K. (2020). Implementation of deep neural networks to classify eeg signals using gramian angular summation field for epilepsy diagnosis. *arXiv preprint arXiv:2003.04534*.
- Thodoroff, P., Pineau, J., and Lim, A. (2016). Learning robust features using deep learning for automatic seizure detection. In *Machine learning for healthcare conference*, pages 178–190. PMLR.
- Thomas, A. H., Aminifar, A., and Atienza, D. (2020a). Noise-resilient and interpretable epileptic seizure detection. In *2020 IEEE International Symposium on Circuits and Systems (ISCAS)*, pages 1–5. IEEE.
- Thomas, J., Comoretto, L., Jin, J., Dauwels, J., Cash, S. S., and Westover, M. B. (2018). Eeg classification via convolutional neural network-based interictal epileptiform event detection. In *2018 40th Annual International Conference of the IEEE Engineering in Medicine and Biology Society (EMBC)*, pages 3148–3151. IEEE.
- Thomas, J., Jin, J., Thangavel, P., Bagheri, E., Yuvaraj, R., Dauwels, J., Rathakrishnan, R., Halford, J. J., Cash, S. S., and Westover, B. (2020b). Automated detection of interictal epileptiform discharges from scalp electroencephalograms by convolutional neural networks. *International journal of neural systems*, 30(11):2050030.
- Tian, X., Deng, Z., Ying, W., Choi, K.-S., Wu, D., Qin, B., Wang, J., Shen, H., and Wang, S. (2019). Deep multi-view feature learning for eeg-based epileptic seizure detection. *IEEE Transactions on Neural Systems and Rehabilitation Engineering*, 27(10):1962–1972.

- Tjepkema-Cloostermans, M. C., de Carvalho, R. C., and van Putten, M. J. (2018). Deep learning for detection of focal epileptiform discharges from scalp eeg recordings. *Clinical neurophysiology*, 129(10):2191–2196.
- Torfi, A. and Fox, E. A. (2020). Corgan: Correlation-capturing convolutional generative adversarial networks for generating synthetic healthcare records. *arXiv e-prints*, pages arXiv–2001.
- Torres-Velázquez, M., Hwang, G., Cook, C. J., Hermann, B., Prabhakaran, V., Meyerand, M. E., and McMillan, A. B. (2020). Multi-channel deep neural network for temporal lobe epilepsy classification using multimodal mri data. In *2020 IEEE 17th International Symposium on Biomedical Imaging Workshops (ISBI Workshops)*, pages 1–4. IEEE.
- Truong, N. D., Kuhlmann, L., Bonyadi, M. R., Querlioz, D., Zhou, L., and Kavehei, O. (2019). Epileptic seizure forecasting with generative adversarial networks. *IEEE Access*, 7:143999–144009.
- Truong, N. D., Yang, Y., Maher, C., Nikpour, A., and Kavehei, O. (2020). Epileptic seizure forecasting: Probabilistic seizure-risk assessment and data-fusion. *arXiv preprint arXiv:2005.07196*.
- Tuncer, T., Dogan, S., Ertam, F., and Subasi, A. (2020). A novel ensemble local graph structure based feature extraction network for eeg signal analysis. *Biomedical Signal Processing and Control*, 61:102006.
- Türk, Ö. and Özerdem, M. S. (2019). Epilepsy detection by using scalogram based convolutional neural network from eeg signals. *Brain sciences*, 9(5):115.
- Turner, J., Page, A., Mohsenin, T., and Oates, T. (2017). Deep belief networks used on high resolution multichannel electroencephalography data for seizure detection. *arXiv preprint arXiv:1708.08430*.
- Tzallas, A. T., Tsipouras, M. G., Tsalikakis, D. G., Karvounis, E. C., Astrakas, L., Konitsiotis, S., and Tzaphlidou, M. (2012). Automated epileptic seizure detection methods: a review study. *Epilepsy-histological, electroencephalographic and psychological aspects*, pages 75–98.

- Ullah, I., Hussain, M., Aboalsamh, H., et al. (2018). An automated system for epilepsy detection using eeg brain signals based on deep learning approach. *Expert Systems with Applications*, 107:61–71.
- Usman, S. M., Khalid, S., and Aslam, M. H. (2020). Epileptic seizures prediction using deep learning techniques. *Ieee Access*, 8:39998–40007.
- Uyttenhove, T., Maes, A., Van Steenkiste, T., Deschrijver, D., and Dhaene, T. (2020). Interpretable epilepsy detection in routine, interictal eeg data using deep learning. In *Machine Learning for Health*, pages 355–366. PMLR.
- van Lanen, R., Colon, A., Wiggins, C., Hoeberigs, M., Hoogland, G., Roebroek, A., Ivanov, D., Poser, B., Rouhl, R., Hofman, P., et al. (2021). Ultra-high field magnetic resonance imaging in human epilepsy: A systematic review. *NeuroImage: Clinical*, page 102602.
- Vance, C., Kim, Y., Zhang, G., Lhatoo, S., Tao, S., Cui, L., Li, X., and Jiang, X. (2020). Learning to detect the onset of slow activity after a generalized tonic-clonic seizure. *BMC Medical Informatics and Decision Making*, 20(12):1–8.
- Vaughan, D. N. and Jackson, G. D. (2020). Imaging epileptic seizures using fmri. In *fMRI*, pages 193–216. Springer.
- Verma, A. and Janghel, R. R. (2021). Epileptic seizure detection using deep recurrent neural networks in eeg signals. In *Advances in Biomedical Engineering and Technology*, pages 189–198. Springer.
- Vidyaratne, L., Glandon, A., Alam, M., and Iftekharruddin, K. M. (2016). Deep recurrent neural network for seizure detection. In *2016 International Joint Conference on Neural Networks (IJCNN)*, pages 1202–1207. IEEE.
- Wainberg, M., Merico, D., DeLong, A., and Frey, B. J. (2018). Deep learning in biomedicine. *Nature biotechnology*, 36(9):829–838.
- Wang, H., Ahmed, S. N., and Mandal, M. (2020a). Automated detection of focal cortical dysplasia using a deep convolutional neural network. *Computerized Medical Imaging and Graphics*, 79:101662.
- Wang, L., Guo, S., Huang, W., and Qiao, Y. (2015). Places205-vggnet models for scene recognition. *arXiv preprint arXiv:1508.01667*.

- Wang, S., Wang, S., Zhang, S., and Wang, Y. (2020b). Time-resnext for epilepsy recognition based on eeg signals in wireless networks. *EURASIP Journal on Wireless Communications and Networking*, 2020(1):1–12.
- Wang, X., Hu, W., McGonigal, A., Zhang, C., Sang, L., Zhao, B., Sun, T., Wang, F., Zhang, J.-g., Shao, X., et al. (2019). Electroclinical features of insulo-opercular epilepsy: an seeg and pet study. *Annals of clinical and translational neurology*, 6(7):1165–1177.
- Wei, Z., Zou, J., Zhang, J., and Xu, J. (2019). Automatic epileptic eeg detection using convolutional neural network with improvements in time-domain. *Biomedical Signal Processing and Control*, 53:101551.
- Wen, T. and Zhang, Z. (2018). Deep convolution neural network and autoencoders-based unsupervised feature learning of eeg signals. *IEEE Access*, 6:25399–25410.
- Weng, W. and Khorasani, K. (1996). An adaptive structure neural networks with application to eeg automatic seizure detection. *Neural Networks*, 9(7):1223–1240.
- Woermann, F. G. and Vollmar, C. (2009). Clinical mri in children and adults with focal epilepsy: a critical review. *Epilepsy & Behavior*, 15(1):40–49.
- Wong, S. and Kuhlmann, L. (2020). Computationally efficient epileptic seizure prediction based on extremely randomised trees. In *Proceedings of the Australasian Computer Science Week Multiconference*, pages 1–3.
- Xu, G., Ren, T., Chen, Y., and Che, W. (2020a). A one-dimensional cnn-lstm model for epileptic seizure recognition using eeg signal analysis. *Frontiers in Neuroscience*, 14:1253.
- Xu, H., Dong, M., Lee, M.-H., O’Hara, N., Asano, E., and Jeong, J.-W. (2019). Objective detection of eloquent axonal pathways to minimize postoperative deficits in pediatric epilepsy surgery using diffusion tractography and convolutional neural networks. *IEEE transactions on medical imaging*, 38(8):1910–1922.

- Xu, H., Zhu, H., Luo, L., and Zhang, R. (2020b). Altered gray matter volume in mri-negative focal to bilateral tonic-clonic seizures. *Acta Neurologica Belgica*, pages 1–9.
- Xu, Y., Yang, J., Zhao, S., Wu, H., and Sawan, M. (2020c). An end-to-end deep learning approach for epileptic seizure prediction. In *2020 2nd IEEE International Conference on Artificial Intelligence Circuits and Systems (AICAS)*, pages 266–270. IEEE.
- Yan, B., Wang, Y., Li, Y., Gong, Y., Guan, L., and Yu, S. (2016). An eeg signal classification method based on sparse auto-encoders and support vector machine. In *2016 IEEE/CIC International Conference on Communications in China (ICCC)*, pages 1–6. IEEE.
- Yan, M., Liu, L., Chen, S., and Pan, Y. (2018). A deep learning method for prediction of benign epilepsy with centrotemporal spikes. In *International Symposium on Bioinformatics Research and Applications*, pages 253–258. Springer.
- Yang, G., Yu, S., Dong, H., Slabaugh, G., Dragotti, P. L., Ye, X., Liu, F., Arridge, S., Keegan, J., Guo, Y., et al. (2017). Dagan: Deep de-aliasing generative adversarial networks for fast compressed sensing mri reconstruction. *IEEE transactions on medical imaging*, 37(6):1310–1321.
- Yang, Y., Sarkis, R., El Atrache, R., Loddenkemper, T., and Meisel, C. (2021). Video-based detection of generalized tonic-clonic seizures using deep learning. *IEEE Journal of Biomedical and Health Informatics*.
- Yao, X., Cheng, Q., and Zhang, G.-Q. (2019a). Automated classification of seizures against nonseizures: A deep learning approach. *arXiv preprint arXiv:1906.02745*.
- Yao, X., Cheng, Q., and Zhang, G.-Q. (2019b). A novel independent rnn approach to classification of seizures against non-seizures. *arXiv preprint arXiv:1903.09326*.
- Yao, X., Li, X., Ye, Q., Huang, Y., Cheng, Q., and Zhang, G.-Q. (2021). A robust deep learning approach for automatic classification of seizures against non-seizures. *Biomedical Signal Processing and Control*, 64:102215.

- Yi, X., Walia, E., and Babyn, P. (2019). Generative adversarial network in medical imaging: A review. *Medical image analysis*, 58:101552.
- Yıldırım, Ö., Baloglu, U. B., and Acharya, U. R. (2018). A deep convolutional neural network model for automated identification of abnormal eeg signals. *Neural Computing and Applications*, pages 1–12.
- You, S., Cho, B. H., Yook, S., Kim, J. Y., Shon, Y.-M., Seo, D.-W., and Kim, I. Y. (2020). Unsupervised automatic seizure detection for focal-onset seizures recorded with behind-the-ear eeg using an anomaly-detecting generative adversarial network. *Computer methods and programs in biomedicine*, 193:105472.
- Yuan, Y. and Jia, K. (2019). Fusionatt: deep fusional attention networks for multi-channel biomedical signals. *Sensors*, 19(11):2429.
- Yuan, Y., Xun, G., Jia, K., and Zhang, A. (2017). A multi-view deep learning method for epileptic seizure detection using short-time fourier transform. In *Proceedings of the 8th ACM International Conference on Bioinformatics, Computational Biology, and Health Informatics*, pages 213–222.
- Yuan, Y., Xun, G., Jia, K., and Zhang, A. (2018a). A multi-context learning approach for eeg epileptic seizure detection. *BMC systems biology*, 12(6):47–57.
- Yuan, Y., Xun, G., Jia, K., and Zhang, A. (2018b). A multi-view deep learning framework for eeg seizure detection. *IEEE journal of biomedical and health informatics*, 23(1):83–94.
- Yuan, Y., Xun, G., Ma, F., Suo, Q., Xue, H., Jia, K., and Zhang, A. (2018c). A novel channel-aware attention framework for multi-channel eeg seizure detection via multi-view deep learning. In *2018 IEEE EMBS International Conference on Biomedical & Health Informatics (BHI)*, pages 206–209. IEEE.
- Yuan, Y., Xun, G., Suo, Q., Jia, K., and Zhang, A. (2019). Wave2vec: Deep representation learning for clinical temporal data. *Neurocomputing*, 324:31–42.



- Yuvaraj, R., Thomas, J., Kluge, T., and Dauwels, J. (2018). A deep learning scheme for automatic seizure detection from long-term scalp eeg. In *2018 52nd Asilomar Conference on Signals, Systems, and Computers*, pages 368–372. IEEE.
- Zeng, M., Zhang, X., Zhao, C., Lu, X., and Meng, Q. (2021). Grp-dnet: A gray recurrence plot-based densely connected convolutional network for classification of epileptiform eeg. *Journal of Neuroscience Methods*, 347:108953.
- Zeng, R., Wu, J., Shao, Z., Senhadji, L., and Shu, H. (2014). Quaternion softmax classifier. *Electronics letters*, 50(25):1929–1931.
- Zhan, Q. and Hu, W. (2020). An epilepsy detection method using multiview clustering algorithm and deep features. *Computational and Mathematical Methods in Medicine*, 2020.
- Zhang, B., Wang, W., Xiao, Y., Xiao, S., Chen, S., Chen, S., Xu, G., and Che, W. (2020a). Cross-subject seizure detection in eegs using deep transfer learning. *Computational and Mathematical Methods in Medicine*, 2020.
- Zhang, G., Le Yang, B. L., Lu, Y., Liu, Q., Zhao, W., Ren, T., Zhou, J., Wang, S.-H., and Che, W. (2020b). Mnl-network: A multi-scale non-local network for epilepsy detection from eeg signals. *Frontiers in Neuroscience*, 14.
- Zhang, J., Wu, H., Su, W., Wang, X., Yang, M., and Wu, J. (2018). A new approach for classification of epilepsy eeg signals based on temporal convolutional neural networks. In *2018 11th International Symposium on Computational Intelligence and Design (ISCID)*, volume 2, pages 80–84. IEEE.
- Zhang, X., Yao, L., Dong, M., Liu, Z., Zhang, Y., and Li, Y. (2020c). Adversarial representation learning for robust patient-independent epileptic seizure detection. *IEEE journal of biomedical and health informatics*, 24(10):2852–2859.
- Zhang, Y., Jiang, L., Zhang, D., Wang, L., Fei, X., Liu, X., Fu, X., Niu, C., Wang, Y., and Qian, R. (2020d). Thalamocortical structural connectivity abnormalities in drug-resistant generalized epilepsy: A diffusion tensor imaging study. *Brain research*, 1727:146558.

- Zhang, Z., Ren, Y., Sabor, N., Pan, J., Luo, X., Li, Y., Chen, Y., and Wang, G. (2020e). Dwt-net: Seizure detection system with structured eeg montage and multiple feature extractor in convolution neural network. *Journal of Sensors*, 2020.
- Zhao, S., Yang, J., Xu, Y., and Sawan, M. (2020a). Binary single-dimensional convolutional neural network for seizure prediction. In *2020 IEEE International Symposium on Circuits and Systems (ISCAS)*, pages 1–5. IEEE.
- Zhao, W. and Wang, W. (2020). Seizurenet: a model for robust detection of epileptic seizures based on convolutional neural network. *Cognitive Computation and Systems*, 2(3):119–124.
- Zhao, W., Zhao, W., Wang, W., Jiang, X., Zhang, X., Peng, Y., Zhang, B., and Zhang, G. (2020b). A novel deep neural network for robust detection of seizures using eeg signals. *Computational and mathematical methods in medicine*, 2020.
- Zhao, X., Solé-Casals, J., Li, B., Huang, Z., Wang, A., Cao, J., Tanaka, T., and Zhao, Q. (2020c). Classification of epileptic i EEG signals by CNN and data augmentation. In *ICASSP 2020-2020 IEEE International Conference on Acoustics, Speech and Signal Processing (ICASSP)*, pages 926–930. IEEE.
- Zhao, X., Zhang, H., Zhu, G., You, F., Kuang, S., and Sun, L. (2019). A multi-branch 3d convolutional neural network for EEG-based motor imagery classification. *IEEE Transactions on Neural Systems and Rehabilitation Engineering*, 27(10):2164–2177.
- Zheng, L., Liao, P., Luo, S., Sheng, J., Teng, P., Luan, G., and Gao, J.-H. (2019). Ems-net: A deep learning method for autodetecting epileptic magnetoencephalography spikes. *IEEE transactions on medical imaging*, 39(6):1833–1844.
- Zihlmann, M., Perekrestenko, D., and Tschannen, M. (2017). Convolutional recurrent neural networks for electrocardiogram classification. In *2017 Computing in Cardiology (CinC)*, pages 1–4. IEEE.

Zijlmans, M., Huiskamp, G., Hersevoort, M., Seppenwoolde, J.-H., van Huffelen, A. C., and Leijten, F. S. (2007). Eeg-fmri in the preoperative work-up for epilepsy surgery. *Brain*, 130(9):2343–2353.

Zuo, R., Wei, J., Li, X., Li, C., Zhao, C., Ren, Z., Liang, Y., Geng, X., Jiang, C., Yang, X., et al. (2019). Automated detection of high-frequency oscillations in epilepsy based on a convolutional neural network. *Frontiers in computational neuroscience*, 13:6.