

SalientSleepNet: Multimodal Salient Wave Detection Network for Sleep Staging

Ziyu Jia^{1,2}, Youfang Lin^{1,2,3}, Jing Wang^{1,2,3*}, Xuehui Wang¹, Peiyi Xie¹ and Yingbin Zhang¹

¹School of Computer and Information Technology, Beijing Jiaotong University, Beijing, China

²Beijing Key Laboratory of Traffic Data Analysis and Mining, Beijing, China

³CAAC Key Laboratory of Intelligent Passenger Service of Civil Aviation, Beijing, China

{ziyuja, yflin, wj, xuehuiwang, peiyixie, yingbinzhang}@bjtu.edu.cn

Abstract

Sleep staging is fundamental for sleep assessment and disease diagnosis. Although previous attempts to classify sleep stages have achieved high classification performance, several challenges remain open: 1) How to effectively extract salient waves in multimodal sleep data; 2) How to capture the multi-scale transition rules among sleep stages; 3) How to adaptively seize the key role of specific modality for sleep staging. To address these challenges, we propose SalientSleepNet, a multimodal salient wave detection network for sleep staging. Specifically, SalientSleepNet is a temporal fully convolutional network based on the U²-Net architecture that is originally proposed for salient object detection in computer vision. It is mainly composed of two independent U²-like streams to extract the salient features from multimodal data, respectively. Meanwhile, the multi-scale extraction module is designed to capture multi-scale transition rules among sleep stages. Besides, the multimodal attention module is proposed to adaptively capture valuable information from multimodal data for the specific sleep stage. Experiments on the two datasets demonstrate that SalientSleepNet outperforms the state-of-the-art baselines. It is worth noting that this model has the least amount of parameters compared with the existing deep neural network models.

1 Introduction

Sleep staging is important for the assessment of sleep quality and the diagnosis of sleep disorders. To determine sleep stages, sleep experts use electrical activity recorded from sensors attached to different parts of the body. The recorded signals from these sensors are called polysomnography (PSG), consisting of electroencephalogram (EEG), electrooculogram (EOG), and other physiological signals. These recorded signals are divided into 30s sleep epochs and sleep experts classify them into five different sleep stages (W, N1, N2, N3, and REM) according to the American Academy of

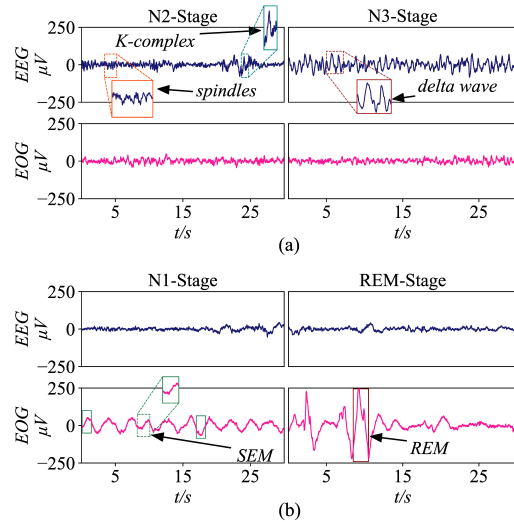

Figure 1: Salient waves in EEG and EOG signals. (a) Spindle wave and K-complex are in N2 stage. Delta wave is in N3 stage. (b) Slow eye movement (SEM) wave is in N1 stage. Rapid eye movement (REM) wave is in REM stage.

Sleep Medicine (AASM) sleep standard [Iber *et al.*, 2007]. However, this manual approach is labor-intensive and time-consuming due to the need for PSG recordings from several sensors attached to subjects over several nights. Therefore, many researchers attempt to develop automatic sleep staging methods.

To automate sleep staging, some deep learning methods are applied to achieve state-of-the-art performance [Phan *et al.*, 2019; Perslev *et al.*, 2019; Supratak and Guo, 2020]. However, there are several challenges remain open:

1) *The salient waves are directly captured from the raw signals.* According to the AASM sleep standard, different sleep stages usually have different salient waves in physiological signals. For example, Figure 1 shows that the salient waves of N2 stage are spindle waves and K-complex waves, while the salient wave of N3 stage is delta waves. Most of the existing works use feature extraction to indirectly capture salient waves [Phan *et al.*, 2019; Phan *et al.*, 2020; Chriskos *et al.*, 2019; Hassan and Bhuiyan, 2016]. For example, the time-frequency features of the signals can reflect the

*corresponding author

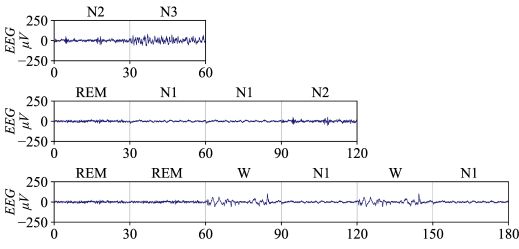

Figure 2: Different scales of sleep transition rules in AASM sleep standard. Short scale: $N2 - N3$; Middle scale: $REM - N1 - N1 - N2$; Long scale: $REM - REM - W - N1 - W - N1$.

saliency wave features to a certain extent. The raw physiological signals are converted into time-frequency images as input to deep learning models for sleep staging [Phan *et al.*, 2020; Hassan and Bhuiyan, 2016]. Although the above methods indirectly capture signal wave features, manually extracted features not only require prior knowledge but may also cause partial information loss.

2) *Multi-scale sleep transition rules are utilized effectively.* During sleep, the human brain undergoes a series of changes among different sleep stages. These changing patterns are summarized as transition rules in the sleep standard. Experts often determine the current sleep stage based on these rules, combined with its neighboring sleep stages. Figure 2 shows the sleep transition rules have multi-scale characteristics in the AASM standard. To capture sleep transition rules, some mixed models including RNNs are usually used [Supratak *et al.*, 2017; Supratak and Guo, 2020; Mousavi *et al.*, 2019; Phan *et al.*, 2020]. However, most of the existing works ignore to explicitly capture the multi-scale characteristics of sleep transition rules. In addition, these recurrent models are difficult to tune and optimize. It has been found that for many tasks RNNs models can be replaced by feed-forward systems (such as CNN variants) without sacrificing accuracy [Bai *et al.*, 2018].

3) *Different modalities have different contributions to distinguish the sleep stages.* Figure 1 shows that the EEG waves in the REM and N1 stages are similar. However, the EOG waves in the two stages are quite different. Hence, the contribution of EOG signals to classify REM and N1 stages is greater than that of the EEG signals. On the contrary, the classification of N2 and N3 stages is mainly according to the salient waves in EEG signals. Therefore, when identifying different sleep stages, the required modalities are different. To utilize these multimodal signals, researchers usually pay attention to the multimodal complementarity and merge the multimodal features through concatenate operations [Chambon *et al.*, 2018; Sokolovsky *et al.*, 2019; Phan *et al.*, 2019; Phan *et al.*, 2020]. This ignores that the contribution of each modality to the identification of specific sleep stages is different.

To address the above challenges, we propose a novel deep learning model called SalientSleepNet, a sleep staging model based on multimodal sleep data (EEG signals and EOG signals). Different from many previous works, the SalientSleepNet can simultaneously capture the salient features of multi-

modal data and multi-scale sleep transition rules from the raw signals.

Overall, the main contributions of the SalientSleepNet for sleep staging are summarized as follows:

- We develop the U^2 -structure stream, which is composed of multiple nested U-units, to detect the salient waves in physiological signals. It is inspired by the popular U^2 -Net originally proposed in computer vision.
- We design a multi-scale extraction module to capture sleep transition rules. It is composed of multiple dilated convolutions with different receptive fields for capturing multi-scale rules.
- We propose a multimodal attention module to adaptively capture valuable information from different multimodal data for the specific sleep stage.
- Experimental results show that the SalientSleepNet achieves state-of-the-art performance. In addition, our model parameters are the least compared with existing deep neural networks for sleep staging.

2 Related Work

In recent years, time series analysis has attracted the attention of many researchers [Jia *et al.*, 2020b; Jia *et al.*, 2019; Jia *et al.*, 2020a]. Sleep signal as a typical physiological time series helps to diagnose sleep disorders. In earlier research, machine learning methods are utilized to classify sleep stages. However, these methods rely on hand-engineered features that require a lot of prior knowledge. Therefore, the researchers have turned to use deep learning methods for automatic sleep staging [Jia *et al.*, 2020c; Jia *et al.*, 2021; Cai *et al.*, 2020].

At present, deep learning methods based on CNN or RNN have been widely used in sleep staging. For example, DeepSleepNet [Supratak *et al.*, 2017] utilizes CNN to extract time-invariant features, and Bi-directional Long Short-Term Memory (BiLSTM) to learn the transition rules among sleep stages. SleepEEGNet [Mousavi *et al.*, 2019] can extract time-invariant features from the raw signals and capture long short-term context dependencies. XSleepNet [Phan *et al.*, 2020] presents a sequence-to-sequence sleep staging model that is capable of learning a joint representation from both raw signals and time-frequency images effectively. In addition, to lighten the existing models such as DeepSleepNet, TinySleepNet is proposed [Supratak and Guo, 2020] for sleep staging. SleepUtime [Perslev *et al.*, 2019] is a fully feed-forward deep learning approach to physiological time-series segmentation. It maps sequential inputs of arbitrary length to class label sequences on a freely chosen temporal scale.

The existing models achieve high performance for sleep staging. Unfortunately, these deep learning methods cannot effectively detect and fuse the salient waves in raw multimodal signals. In addition, the multi-scale transition rules among sleep stages cannot be captured explicitly.

3 Preliminaries

The proposed model processes a sequence of sleep epochs and outputs a predicted label sequence. Each sleep epoch

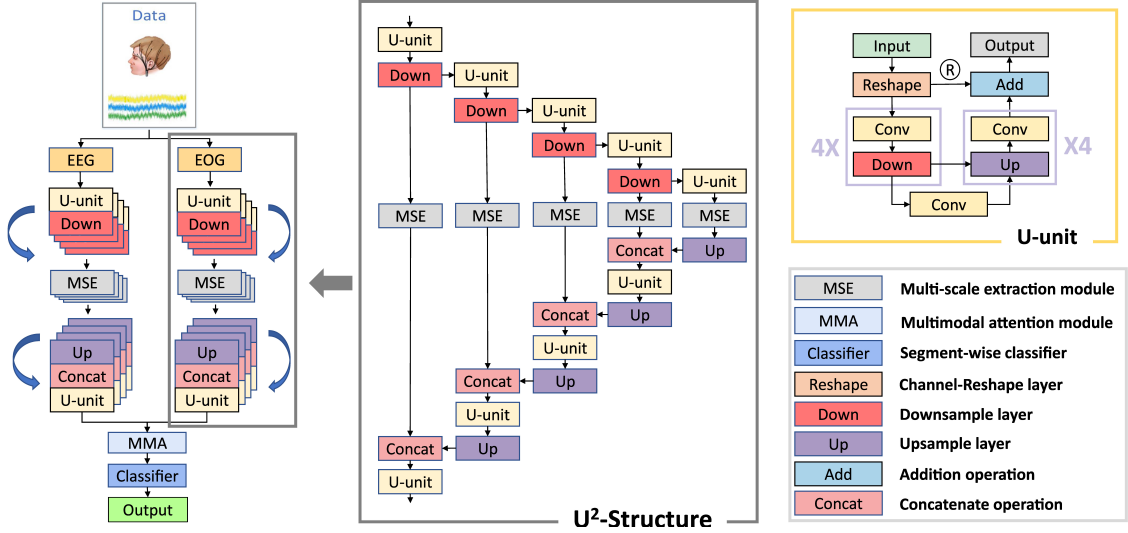

Figure 3: An overview architecture of SalientSleepNet. It composed of two-stream U^2 -structure, multi-scale feature extraction module, multimodal attention module, and the segment-wise classifier. The two-stream U^2 -structure extract salient wave features in EEG and EOG signal independently. Each U^2 -structure is composed of multiple nested U-units. U-unit has depth $l = 4$. \textcircled{R} : the residual connection in U-unit.

is defined as $x \in \mathbb{R}^{n \times C}$, where n is the number of sampling points in an epoch, and C denotes the channels of sleep epoch (i.e. an EEG channel and an EOG channel in this work).

The input sequence of sleep epochs is defined as $S = \{x_1, x_2, \dots, x_L\}$, where x_i denotes a sleep epoch ($i \in [1, 2, \dots, L]$) and L is the number of sleep epochs.

The sleep staging problem is defined as: learning a mapping function F based on multimodal salient wave detection network which maps sleep epoch sequence S into the corresponding sequence of sleep stages \hat{Y} , where $\hat{Y} = \{\hat{y}_1, \hat{y}_2, \dots, \hat{y}_L\}$ and \hat{y}_i is the classification result of x_i . Following the AASM manual, each $\hat{y}_i \in \{0, 1, 2, 3, 4\}$ matching with the five sleep stages W, N1, N2, N3, and REM, respectively.

4 Multimodal Salient Wave Detection Network for Sleep Staging

The overall architecture of SalientSleepNet is shown in Figure 3. We summarize five key ideas of SalientSleepNet: 1) Develop a two-stream U^2 -structure to capture the salient waves in EEG and EOG modalities. 2) Design a multi-scale extraction module by dilated convolution with different scales of receptive fields to learn the multi-scale sleep transition rules explicitly. 3) Propose a multimodal attention module to fuse the outputs from EEG and EOG streams and strengthen the features of different modalities which make greater contribution to identify certain sleep stage. 4) Improve the traditional pixel-wise (point-wise) classifier in computer vision into a segment-wise classifier for sleep signals. 5) Employ a bottleneck layer to reduce the computational cost to make the overall model lightweight.

4.1 Two-Stream U^2 -Structure

Human experts classify the sleep stage mainly based on the salient waves in EEG and EOG signals such as spindle waves, K-complexes, and sawtooth waves [Iber *et al.*, 2007]. Existing sleep staging models extract salient wave features indirectly by converting raw signals into time-frequency images. This may cause information loss and require prior knowledge.

To capture the salient waves in raw EEG and EOG signals directly, we design a two-stream U^2 -structure to capture the features of different signals as shown in Figure 3. Specifically, The EEG signals and EOG signals are input into two independent U^2 -structures to learn the distinctive features. Each U^2 -structure is an encoder-decoder structure and is composed of multiple nested U-units. This is inspired by U^2 -Net in salient object detection of images [Qin *et al.*, 2020]. Specifically, each U-unit has three components: a channel-reshape layer, a U-like structure, and a residual connection:

1. Given a 1D feature map X , the channel-reshape layer transforms it into an intermediate feature map to control the channel number of the U-unit:

$$X_m = \text{Reshape}(X), \quad (1)$$

where Reshape denotes the channel-reshape operation and X_m denotes the intermediate feature map.

2. The U-like structure encodes and decodes the intermediate feature map and obtains X'_m :

$$X'_m = U_l(X_m), \quad (2)$$

where U_l denotes the U-like structure with depth of l ($l = 4$ in our model).

3. The residual connection [He *et al.*, 2016] fuses feature map X_m and X'_m with addition operation to reduce the

degradation problem in the deep network:

$$X_m'' = X_m + X_m', \quad (3)$$

where X_m'' is the output of the U-unit.

Multiple U-units make up the U²-structure. Specifically, there are 5 U-units in the encoder and 4 U-units in the decoder for each U²-structure.

4.2 Multi-scale Extraction Module

Sleep transition rules is important for sleep staging. The transition rules have the characteristics of multiple scales: short scale, middle scale, and long scale. Previous works use the RNN to learn the sleep transition rules. However, the RNN models are difficult to tune and optimize [Bai *et al.*, 2018].

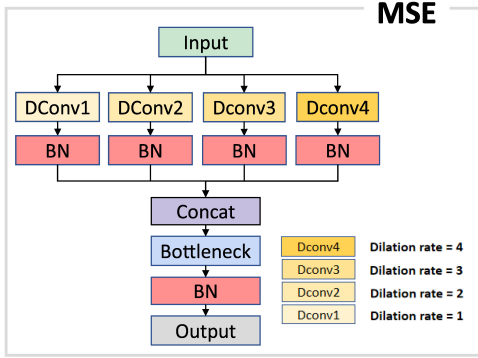

Figure 4: The structure of Multi-Scale Extraction module (MSE) which captures multi-scale transition rules of sleep epoch sequence. Dconv r is the r -th dilation convolution with dilation rate r . Bottleneck: Bottleneck layer which reduce the channel of feature map. Concat: Concatenate operation; BN: Batch normalization.

To solve the above problems, we design a Multi-Scale Extraction module (MSE) to capture multi-scale sleep transition rules explicitly, as shown in Figure 4. The MSE has dilated convolutions with different dilation rates to capture features in different scales of receptive fields [Yu and Koltun, 2015]. Specifically, we employ 4 dilated convolutions with dilation rates from 1 to 4 to transform the same input feature map. Then, the feature maps learned from different scales of receptive fields are concatenated to obtain a multi-scale feature map, which is defined as:

$$X_d^r = DConv_r(X_m''), r \in [1, 2, 3, 4], \quad (4)$$

$$X_{ms} = Concat(X_d^1, X_d^2, X_d^3, X_d^4), \quad (5)$$

where X_m'' is the input feature map, $DConv_r$ is the dilated convolution with dilation rate r , X_d^r is the output of dilated convolution $DConv_r$, and X_{ms} is the multi-scale feature map.

Besides, to reduce the parameters of our model, we apply a bottleneck layer [He *et al.*, 2016] between the encoder and decoder (i.e. implemented in MSE). It reduces the channels of the concatenated feature map which makes the model lightweight and composed of two convolution operations. The bottleneck layer is defined as:

$$X_b = Bottleneck(X_{ms}), \quad (6)$$

where *Bottleneck* is the operation of bottleneck layers and X_b is the final multi-scale feature map with channel reduction operation obtained from the MSE. X_b has C_{out} channels and $C_{out} = C_{in}/rate$, where C_{in} is the channel number of X_{ms} and $rate$ is the down-sampling rate of bottleneck layer.

4.3 Multimodal Attention Module

Different modalities have distinctive features which contribute to classifying specific sleep stage. However, existing models ignore that different modalities have different contributions to identify certain sleep stage.

To strengthen the features of different modalities which have greater contribution to classify specific sleep stage in an adaptive approach, we propose a MultiModal Attention module (MMA). As shown in Figure 5, The MMA has two main components: The modality fusion component for fusing the feature maps from two streams and the channel-wise attention component [Hu *et al.*, 2018] for strengthening the most important features in an implicit way for certain sleep stage.

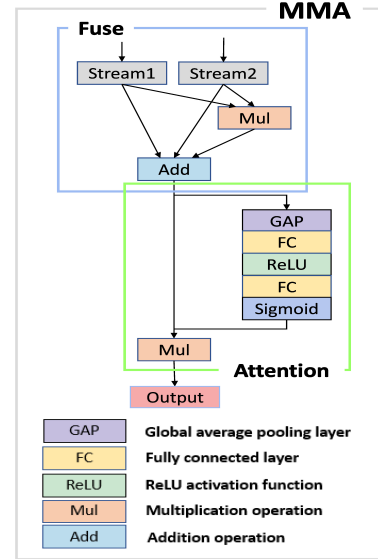

Figure 5: The structure of MultiModal Attention module (MMA) which adaptively capture the important features of different modalities for certain sleep stage.

1. Inspired by the fusion method of [Fu *et al.*, 2020], the modality fusion component is defined as:

$$X_{fuse} = X_{EEG} + X_{EOG} + (X_{EEG} \odot X_{EOG}), \quad (7)$$

where X_{fuse} is the fused feature map and \odot is the element-wise multiplication. X_{EEG} and X_{EOG} are the feature maps learned from EEG and EOG streams, respectively.

2. The X_{fuse} is input into the channel-wise attention component to strengthen the important channels of the fused feature map:

$$X_{att} = \sigma(FC_2(\delta(FC_1(GAP(X_{fuse}))))), \quad (8)$$

$$X'_{att} = X_{fuse} \odot X_{att}, \quad (9)$$

where GAP denotes the global average pooling operation, FC_i denotes i -th fully connected layers, δ is the ReLU activation function, σ is the sigmoid activation function, X_{att} is the intermediate feature map, and X'_{att} is the output of this component.

4.4 Segment-wise Classification

Existing salient object detection models in computer vision are pixel-wise (point-wise) classification [Qin *et al.*, 2020]. These models can not be applied directly to physiological signal segment-wise classification.

Hence, we design a segment-wise classifier which maps the pixel-wise feature map to a segment-wise predict label sequence. Specifically, an average pooling layer is applied to reduce the size of 1D feature map from $X'_{att} \in \mathbb{R}^{L'}$ to $X_{pool} \in \mathbb{R}^L$, where $L' = L * n$, L is the number of sleep epochs, n represents the number of sampling points in an epoch. Then, a convolution layer with Softmax activation is used to reduce the channel dimension of X_{pool} and map vectors to predict label sequence \hat{Y} . Figure A.1 in Appendix shows the structure of the segment-wise classifier.

5 Experiments

We evaluate the performance of SalientSleepNet on Sleep-EDF-39 and Sleep-EDF-153 datasets [Kemp *et al.*, 2000; Goldberger *et al.*, 2000].

5.1 Datasets and Preprocessing

Sleep-EDF-39 consists of 42308 sleep epochs from 20 healthy subjects (10 males and 10 females) aged 25-34. Each subject contains two day-night PSG recordings except subject 13 whose one recording is lost due to device failure. *Sleep-EDF-153* consists of 195479 sleep epochs from 78 healthy subjects aged 25-101. Similar to Sleep-EDF-39, each subject contains two day-night PSG recordings except subjects 13, 36, and 52 whose one recording is lost due to device failure.

For a fair comparison with other methods, we use the same preprocessing and data for all models. Specifically, each 30s epoch of the recordings is labeled into one of six categories {W, N1, N2, N3, N4, REM}. We merge N3 and N4 stages into a single N3 stage according to the latest AASM sleep standard [Iber *et al.*, 2007] and remove before and after in-bed epochs for only in-bed recordings are used as recommended in [Imtiaz and Rodriguez-Villegas, 2014]. We adopt Fpz-Cz EEG and ROC-LOC EOG channels in this study. All signals have a sampling rate of 100 Hz.

5.2 Baseline Methods

We compare the SalientSleepNet with the following baselines:

- SVM [Hearst *et al.*, 1998]: Support Vector Machines uses a Gaussian kernel function for sleep staging.
- RF [Breiman, 2001]: Random Forests are an ensemble learning method for sleep staging.
- DeepSleepNet [Supratak *et al.*, 2017]: DeepSleepNet utilizes CNN to extract time-invariant features and BiLSTM to learn the transition rules among sleep stages.

- SeqSleepNet [Phan *et al.*, 2019]: SeqSleepNet is composed of parallel filterbank layers for preprocessing the time-frequency images and bidirectional RNN to encode sleep sequential information.
- SleepEEGNet [Mousavi *et al.*, 2019]: SleepEEGNet extract time-invariant features from the sleep signals and capture long short-term context dependencies
- SleepUtime [Perslev *et al.*, 2019]: SleepUtime maps sequential inputs of arbitrary length to sequences of class labels on a freely chosen temporal scale.
- TinySleepNet [Supratak and Guo, 2020]: TinySleepNet is a mixed model of CNN and unidirectional RNN.

5.3 Experiment Settings

We implement the SalientSleepNet based on the TensorFlow framework. Our model is trained by Adam optimizer with learning rate $\eta = 10^{-3}$. The training epoch is 60 and batch size is 8. The input sleep epoch sequence length L is 20. Besides, the down-sampling rate of the bottleneck layer *rate* is 4. We apply 20-fold cross-validation to evaluate the cross-subject performance of SalientSleepNet. Other hyperparameters are given in Table A.3 in Appendix and our code is publicly available at <https://github.com/ziyujia/SalientSleepNet>.

5.4 Experiment Results

We compare SalientSleepNet with other seven baseline methods on two publicly available datasets as shown in Table 1. The results show that SalientSleepNet achieves the best overall performance compared with other baseline methods.

The traditional machine learning models (SVM and RF) can't capture various features. Some mixed deep learning models such as DeepSleepNet, SeqSleepNet, and TinySleepNet combine CNN to learn the features in sleep epochs and RNN to capture transition rules between sleep epochs. Therefore, These models achieve better performance than traditional machine learning models.

Although the mixed models can achieve high accuracy, these models are difficult to tune and optimize. In addition, existing models do not make full use of salient wave features in different modalities and some models require time-frequency images as inputs which may cause partial information loss. Different from previous works, our model can simultaneously capture the salient features of multimodal data and multi-scale sleep transition rules from the raw signals. In addition, our model strengthens the contribution of different modalities features to classify different sleep stages. Therefore, SalientSleepNet achieves better overall performance than other baseline methods. It is worth noting that the N1 stage usually has the smallest sample number and is easy to confuse with REM stage. However, our model improves the F1-score for N1 stage to a certain extent. Besides, our model has the minimum parameters compared with other deep learning models.

We visualize the point-wise outputs of U²-structure as shown in Figure 6. It illustrates that our model can detect salient waves in multimodal signals to a certain extent. For example, in EEG signals, the sleep spindle wave and K-complex are in N2 stage. The delta wave appears in N3

Method	Parameters	Sleep-EDF-39 dataset							Sleep-EDF-153 dataset						
		Overall results		F1-score for each class					Overall results		F1-score for each class				
		F1-score	Accuracy	Wake	N1	N2	N3	REM	F1-score	Accuracy	Wake	N1	N2	N3	REM
SVM	<0.1M	63.7	76.1	71.6	13.6	85.1	76.5	71.8	57.8	71.2	80.3	13.5	79.5	57.1	58.7
RF	<0.1M	67.6	78.1	74.9	22.5	86.3	80.8	73.3	62.4	72.7	81.6	23.2	80.6	65.8	60.8
DeepSleepNet	21M	76.9	82.0	85.0	47.0	86.0	85.0	82.0	75.3	78.5	91.0	47.0	81.0	69.0	79.0
SeqSleepNet	–	79.7	86.0	91.9	47.8	87.2	85.7	86.2	78.2	83.8	92.8	48.9	85.4	78.6	85.1
SleepEEGNet	2.1M	79.7	84.3	89.2	52.2	86.8	85.1	85.0	77.0	82.8	90.3	44.6	85.7	81.6	82.9
SleepUtime	1.1M	79.0	–	87.0	52.0	86.0	85.0	82.0	76.0	–	92.0	51.0	84.0	75.0	80.0
TinySleepNet	1.3M	80.5	85.4	90.1	51.4	88.5	88.3	84.3	78.1	83.1	92.8	51.0	85.3	81.1	80.3
SalientSleepNet	0.9M	83.0	87.5	92.3	56.2	89.9	87.2	89.2	79.5	84.1	93.3	54.2	85.8	78.3	85.8

Table 1: Performance comparison of the state-of-the-art approaches on Sleep-EDF-39 and Sleep-EDF-153 datasets. "–" indicates the corresponding value not provided in the baseline models.

stage. Besides, in EOG signals, the slow eye movement wave and rapid eye movement wave exist in N1 stage and REM stage, respectively. Overall, our model can detect these salient waves, which makes this model interpretable to a certain extent.

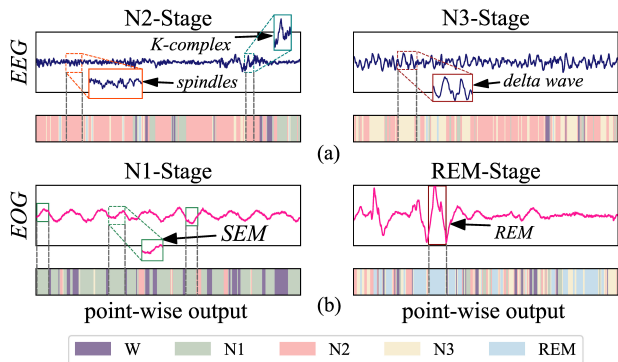

Figure 6: Salient waves detected by SalientSleepNet. (a) The detected salient waves in EEG signals for N2 and N3 stages. (b) The detected salient waves in EOG signals for N1 and REM stages.

5.5 Ablation Experiment

To evaluate the effectiveness of each module in our model, we design several variant models:

- U structure (basic): This model is a two-stream U structure without nested U-units, MSE, and MMA. The feature maps obtained from two streams are concatenated for sleep staging.
- U^2 structure: The nested U-units are applied to the basic model.
- U^2 structure+MSE: This model adds the multi-scale extraction modules based on U^2 structure.
- U^2 structure+MSE+MMA (SalientSleepNet): This model adds the multimodal attention module instead of a simple concatenate operation based on U^2 +MSE model.

Figure 7 presents the U^2 -structure obviously improves the performance of basic model, because it captures more diverse

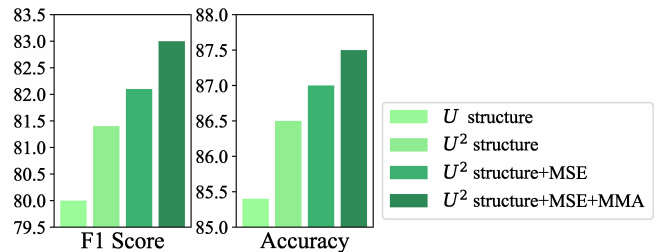

Figure 7: The results of ablation experiment.

salient waves. Then, the structure with MSE learns the multi-scales features which improve the performance. In addition, the MMA is added to adaptive capture the important features of different modalities for certain sleep stage.

Besides, to evaluate the effectiveness of the bottleneck layer in reducing model parameters, we removed this layer in MSE. Compared with the model without bottleneck layer which has 1,128,865 parameters, SalientSleepNet only has 948,795 parameters. The bottleneck layer reduces the number of parameters in the model by 16%. It allows our model to keep the smallest size while achieving the best performance than other baseline methods at the same time.

6 Conclusion

In this paper, we propose a multimodal salient wave detection network for sleep staging. Our work is the first attempt to borrow the U^2 -Net from the visual saliency detection domain to sleep staging. SalientSleepNet can not only effectively detect and fuse the salient waves in multimodal data, but also extract multi-scale transition rules among sleep stages. Experiment results show that SalientSleepNet achieves state-of-the-art performance. The parameters of our model are the least among the existing deep learning models. In addition, the proposed model is a general-framework for multimodal physiological time series.

Acknowledgments

This work was supported by the Fundamental Research Funds for the Central Universities (Grant No.2020YJS025) and the China Scholarship Council (Grant No.202007090056).

References

- [Bai *et al.*, 2018] S. Bai, J. Z. Kolter, and V. Koltun. An empirical evaluation of generic convolutional and recurrent networks for sequence modeling. *arXiv preprint arXiv:1803.01271*, 2018.
- [Breiman, 2001] L. Breiman. Random forests. *Machine learning*, 45(1):5–32, 2001.
- [Cai *et al.*, 2020] X. Cai, Z. Jia, M. Tang, and G. Zheng. Brainsleepnet: Learning multivariate eeg representation for automatic sleep staging. In *BIBM*, pages 976–979. IEEE, 2020.
- [Chambon *et al.*, 2018] S. Chambon, M. N. Galtier, P. J. Arnal, G. Wainrib, and A. Gramfort. A deep learning architecture for temporal sleep stage classification using multivariate and multimodal time series. *TNSRE*, 26(4):758–769, 2018.
- [Chriskos *et al.*, 2019] P. Chriskos, C. A. Frantzidis, P. T. Gkivogkli, P. D. Bamidis, and C. Kourtidou-Papadeli. Automatic sleep staging employing convolutional neural networks and cortical connectivity images. *TNNLS*, 31(1):113–123, 2019.
- [Fu *et al.*, 2020] K. Fu, D. P. Fan, G. P. Ji, and Q. Zhao. JI-dcf: Joint learning and densely-cooperative fusion framework for rgb-d salient object detection. In *CVPR*, pages 3052–3062, 2020.
- [Goldberger *et al.*, 2000] A. L. Goldberger, L. AN Amaral, L. Glass, J. M. Hausdorff, P. Ch Ivanov, R. G. Mark, J. E. Mietus, G. B. Moody, C. K. Peng, and H. E. Stanley. Physiobank, physiotookit, and physionet: components of a new research resource for complex physiologic signals. *circulation*, 101(23):e215–e220, 2000.
- [Hassan and Bhuiyan, 2016] A. R. Hassan and M. I. H. Bhuiyan. A decision support system for automatic sleep staging from eeg signals using tunable q-factor wavelet transform and spectral features. *Journal of neuroscience methods*, 271:107–118, 2016.
- [He *et al.*, 2016] K. He, X. Zhang, S. Ren, and J. Sun. Deep residual learning for image recognition. In *CVPR*, pages 770–778, 2016.
- [Hearst *et al.*, 1998] M. A. Hearst, S. T. Dumais, E. Osuna, J. Platt, and B. Scholkopf. Support vector machines. *IEEE Intelligent Systems and their applications*, 13(4):18–28, 1998.
- [Hu *et al.*, 2018] J. Hu, L. Shen, and G. Sun. Squeeze-and-excitation networks. In *CVPR*, pages 7132–7141, 2018.
- [Iber *et al.*, 2007] C. Iber, S. Ancoli-Israel, A. L. Chesson, S. F. Quan, et al. *The AASM manual for the scoring of sleep and associated events: rules, terminology and technical specifications*, volume 1. American academy of sleep medicine Westchester, IL, 2007.
- [Imtiaz and Rodriguez-Villegas, 2014] S. A. Imtiaz and E. Rodriguez-Villegas. Recommendations for performance assessment of automatic sleep staging algorithms. In *2014 36th Annual International Conference of the IEEE Engineering in Medicine and Biology Society*, pages 5044–5047. IEEE, 2014.
- [Jia *et al.*, 2019] Z. Jia, Y. Lin, Z. Jiao, Y. Ma, and J. Wang. Detecting causality in multivariate time series via non-uniform embedding. *Entropy*, 21(12):1233, 2019.
- [Jia *et al.*, 2020a] Z. Jia, Y. Lin, X. Cai, H. Chen, H. Gou, and J. Wang. Sst-emotionnet: Spatial-spectral-temporal based attention 3d dense network for eeg emotion recognition. In *ACM MM*, pages 2909–2917, 2020.
- [Jia *et al.*, 2020b] Z. Jia, Y. Lin, Y. Liu, Z. Jiao, and J. Wang. Refined nonuniform embedding for coupling detection in multivariate time series. *Physical Review E*, 101(6):062113, 2020.
- [Jia *et al.*, 2020c] Z. Jia, Y. Lin, J. Wang, R. Zhou, X. Ning, Y. He, and Y. Zhao. Graphsleepnet: Adaptive spatial-temporal graph convolutional networks for sleep stage classification. In *IJCAI*, pages 1324–1330, 2020.
- [Jia *et al.*, 2021] Z. Jia, X. Cai, G. Zheng, J. Wang, and Y. Lin. Sleepprintnet: A multivariate multimodal neural network based on physiological time-series for automatic sleep staging. *TAI*, 2021.
- [Kemp *et al.*, 2000] B. Kemp, A. H. Zwiderman, B. Tuk, H. AC Kamphuisen, and J. JL Obery. Analysis of a sleep-dependent neuronal feedback loop: the slow-wave microcontinuity of the eeg. *TBME*, 47(9):1185–1194, 2000.
- [Mousavi *et al.*, 2019] S. Mousavi, F. Afghah, and U R. Acharya. Sleeppeegnet: Automated sleep stage scoring with sequence to sequence deep learning approach. *PloS one*, 14(5):e0216456, 2019.
- [Perslev *et al.*, 2019] M. Perslev, M. Jensen, S. Darkner, P. J. Jennum, and C. Igel. U-time: A fully convolutional network for time series segmentation applied to sleep staging. In *NIPS*, pages 4415–4426, 2019.
- [Phan *et al.*, 2019] H. Phan, F. Andreotti, N. Cooray, O. Y Chén, and M. De Vos. Seqsleepnet: end-to-end hierarchical recurrent neural network for sequence-to-sequence automatic sleep staging. *TNSRE*, 27(3):400–410, 2019.
- [Phan *et al.*, 2020] H. Phan, O. Y Chén, P. Koch, A. Mertins, and M. De Vos. Xsleepnet: Multi-view sequential model for automatic sleep staging. *arXiv preprint arXiv:2007.05492*, 2020.
- [Qin *et al.*, 2020] X. Qin, Z. Zhang, C. Huang, M. Dehghan, O. R. Zaiane, and M. Jagersand. U2-net: Going deeper with nested u-structure for salient object detection. *Pattern Recognition*, 106:107404, 2020.
- [Sokolovsky *et al.*, 2019] M. Sokolovsky, F. Guerrero, S. Paisarnsriromsuk, C. Ruiz, and S. A. Alvarez. Deep learning for automated feature discovery and classification of sleep stages. *TCBB*, 2019.
- [Supratak and Guo, 2020] A. Supratak and Y. Guo. Tinsleepnet: An efficient deep learning model for sleep stage scoring based on raw single-channel eeg. In *EMBC*, pages 641–644. IEEE, 2020.
- [Supratak *et al.*, 2017] A. Supratak, H. Dong, C. Wu, and Y. Guo. Deepsleepnet: A model for automatic sleep stage scoring based on raw single-channel eeg. *TNSRE*, 25(11):1998–2008, 2017.
- [Yu and Koltun, 2015] F. Yu and V. Koltun. Multi-scale context aggregation by dilated convolutions. *arXiv preprint arXiv:1511.07122*, 2015.

Appendix

Table A. 1: The description of all sleeps stages and their salient waves.

Name	Encoding	Description
Non-REM 1	N1	Short, light sleep stage comprising about 5%-10% of a night's sleep. Dominated by theta waves (4-7 Hz EEG signals). Slow eye movements in W→N1 transition. Some EMG activity, but lower than wake.
Non-REM 2	N2	Comprises 40%-50% of a normal night's sleep. EEG displays theta-waves like N1, but intercepted by so-called K-complexes and/or sleep spindles (short bursts of 13-16Hz EEG signal).
Non-REM 3	N3	Comprises about 20%-25% of a typical night's sleep. High amplitude, slow 0.3-3 Hz EEG signals. Low EMG activity.
REM	REM	Rapid-eye-movements may occur. Displays both theta waves and alpha (like wake), but typically 1-2 Hz slower. EMG significantly reduced. Dreaming may occur this stage, which comprises 20%-25% of the night's sleep.
Wake	W	Spans wakefulness to drowsiness. Consists of at least 50% alpha waves (8-13 Hz EEG signals). Rapid and reading eye movements. Eye blinks may occur.

Table A. 2: Sample number and sample proportion in Sleep-EDF-39 and Sleep-EDF-153 datasets.

Label	Sleep-EDF-39		Sleep-EDF-153	
	Number	Proportion	Number	proportion
W	8285	19.58%	65951	33.74%
N1	2804	6.63%	21522	11.01%
N2	17799	42.07%	69132	35.37%
N3	5703	13.48%	13039	6.67%
REM	7717	18.24%	25835	13.22%
total	42308	100.00%	195479	100.00%

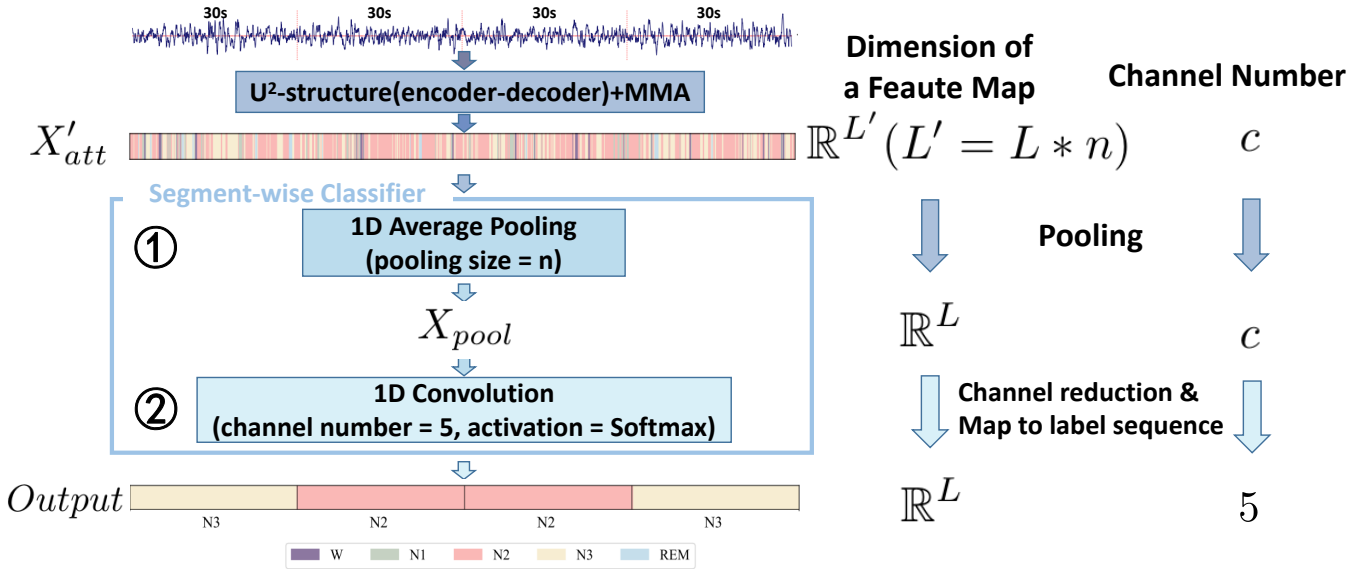

Figure A. 1: The operation of the segment-wise classifier(SWC) which serves as a trainable link between the intermediate representation defined by the encoder-decoder network and the label space. SWC drives the encoder-decoder network to detect salient waves. Specifically, ① X'_{att} is input to an average pooling layer with pooling size n , which reduces the length of X'_{att} to L and forms X_{pool} . ② We follow the output format of the fully convolutional architecture. A convolution layer with Softmax activation are used to reduce the channel dimension and map vectors to \hat{Y} .

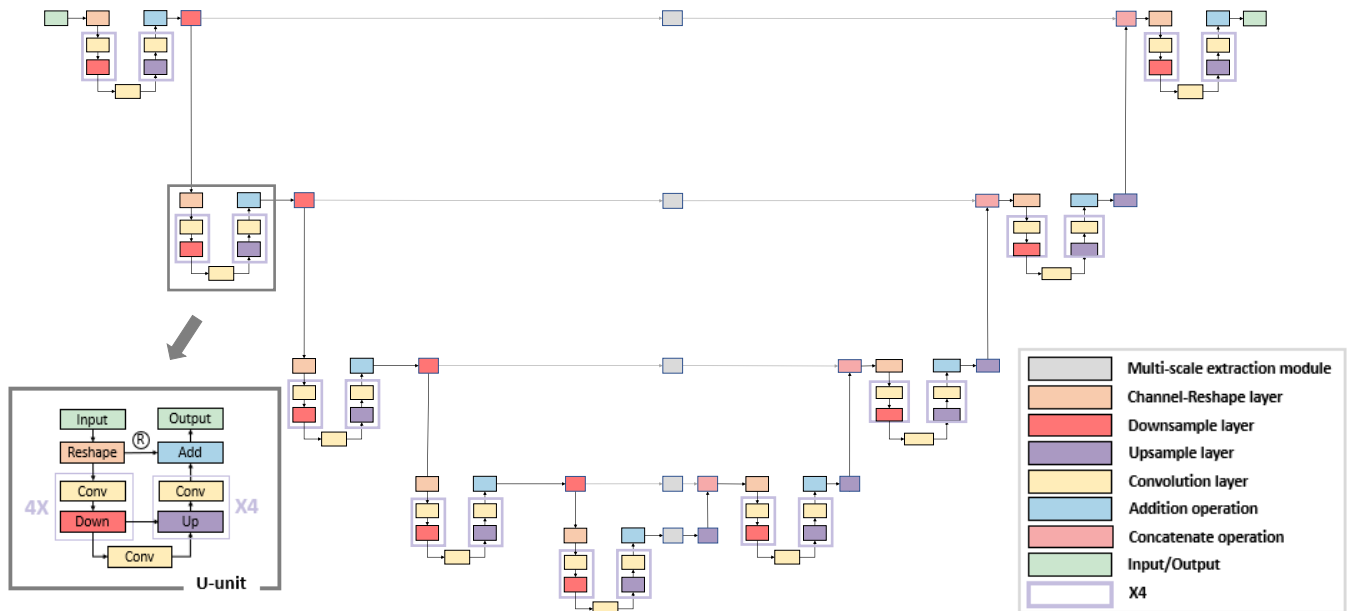

Figure A. 2: The overview of U²-structure.

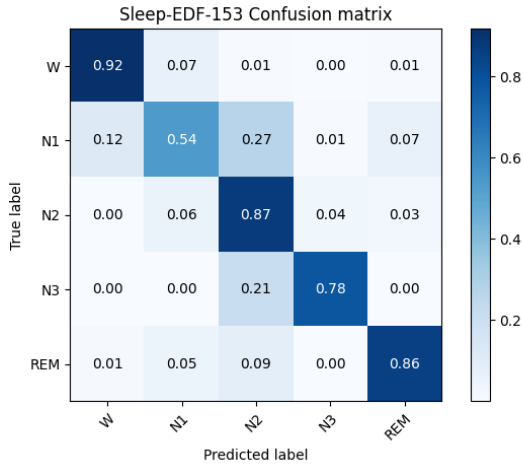
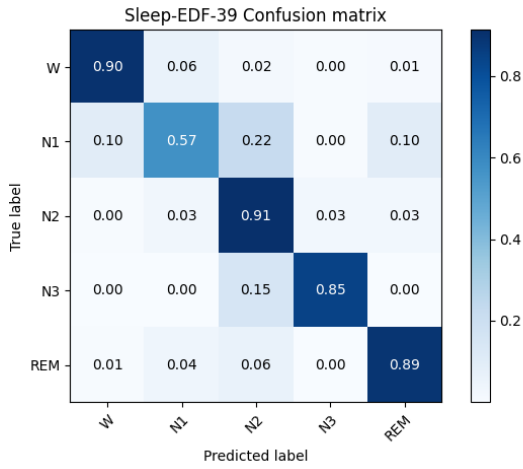

Table A. 3: The hyperparameters used for all datasets.

Parameter	Value
Optimizer	Adam
Learning rate	0.001
β_1	0.9
β_2	0.999
ϵ	1×10^{-8}
Loss function weight	{1.0, 1.80, 1.0, 1.20, 1.25}
Regularization	True
Input dim	3000
Window Size	20
Depth	4
Up-sampling	bilinear
Activations	ReLU
Conv.filters	{16, 32, 64, 128, 256}
Conv.kernel size	5
Max-pool kernel size	10, 8, 6, 4
Padding	same
Batch Normalization	True
Parameters	0.9×10^6
Batch size	8
Training epochs	60
EarlyStopping patience	5

Figure A. 3: The confusion matrix for Sleep-EDF-39 and Sleep-EDF-153 datasets.