CodeNet: A Large-Scale AI for Code Dataset for Learning a Diversity of Coding Tasks

Ruchir Puri¹, David S. Kung¹, Geert Janssen¹, Wei Zhang¹,
Giacomo Domeniconi¹, Vladimir Zolotov¹, Julian Dolby¹, Jie Chen^{2,1},
Mihir Choudhury¹, Lindsey Decker¹, Veronika Thost^{2,1}, Luca Buratti¹,
Saurabh Pujar¹, Shyam Ramji¹, Ulrich Finkler¹, Susan Malaika³, Frederick Reiss¹

¹IBM Research

²MIT-IBM Watson AI Lab

³IBM Worldwide Ecosystems

Abstract

Over the last several decades, software has been woven into the fabric of every aspect of our society. As software development surges and code infrastructure of enterprise applications ages, it is now more critical than ever to increase software development productivity and modernize legacy applications. Advances in deep learning and machine learning algorithms have enabled breakthroughs in computer vision, speech recognition, natural language processing and beyond, motivating researchers to leverage AI techniques to improve software development efficiency. Thus, the fast-emerging research area of “AI for Code” has garnered new interest and gathered momentum. In this paper, we present a large-scale dataset *CodeNet*, consisting of over 14 million code samples and about 500 million lines of code in 55 different programming languages, which is aimed at teaching AI to code. In addition to its large scale, CodeNet has a rich set of high-quality annotations to benchmark and help accelerate research in AI techniques for a variety of critical coding tasks, including code similarity and classification, code translation between a large variety of programming languages, and code performance (runtime and memory) improvement techniques. Additionally, CodeNet provides sample input and output test sets for 98.5% of the code samples, which can be used as an oracle for determining code correctness and potentially guide reinforcement learning for code quality improvements. As a usability feature, we provide several pre-processing tools in CodeNet to transform source code into representations that can be readily used as inputs into machine learning models. Results of code classification and code similarity experiments using the CodeNet dataset are provided as a reference. We hope that the scale, diversity and rich, high-quality annotations of CodeNet will offer unprecedented research opportunities at the intersection of AI and Software Engineering.

1 Introduction

There is a growing trend towards leveraging AI for building tools that support software engineering and development [1, 2]. AI can manipulate and generate computer code, but can it do so with high quality? Many researchers are fascinated by this possibility, encouraged by AI successes in other domains and tantalized by the vision of computers programming computers. Some recent deep-learning models [3, 4] for code have received a lot of publicity: trained on vast amounts of data and using novel architectures with billions of parameters, they sometimes generate surprisingly plausible code.

Given the success of non-AI tools for code, why should we consider AI to augment or possibly replace them? Firstly, AI can help refine and re-tune the heuristics used by traditional coding tools. Secondly, based on the training data from past experience, AI can help prioritize when there is more than one sound answer [5]. Thirdly, an AI-based tool may handle incomplete or invalid code more robustly, thus expanding its scope. Finally, AI can incorporate signals usually ignored by traditional tools for code, such as the natural language in identifiers or comments.

In the enterprise environment, developers often face code written by large teams over many years and geographies. Developers must manipulate such code to modernize it, fix bugs, improve its performance, evolve it when requirements change, make it more secure, and/or comply with regulations. These tasks are challenging, and it is crucial to provide tool support for developers to be more productive at performing them. It is well known that the latest advancements in deep learning algorithms rely on best-of-breed datasets, such as ImageNet, to create increasingly complex and powerful models. In this paper, we present "CodeNet", a first-of-its-kind dataset in scale, diversity, and quality, to accelerate the algorithmic advances in AI for Code.

To promote widespread adoption of CodeNet, we will be launching contests involving use cases based on the dataset. The first contest [6] will focus on diversity, inclusion and spurring interest among aspiring data scientists. We are partnering with the Global Women in Data Science organization (with presence in over 50 countries) founded by Stanford University [7] and targeting teams with at least fifty percent women. We are planning follow-up contests that target experienced AI practitioners.

The rest of the paper is organized as follows. Section 2 introduces the CodeNet dataset. Related datasets are discussed in Section 3, and the differentiation of CodeNet with respect to these related datasets is elaborated in Section 4. Section 5 describes how CodeNet was curated and Section 6 enumerates the usability features of CodeNet with several pre-processing tools to transform source codes into representations that can be readily used as inputs into machine learning models. Section 7 discusses the upcoming CodeNet contest and Section 8 describes important baseline experiments with the CodeNet dataset. Section 9 presents further uses of the CodeNet dataset and Section 10 concludes the paper.

2 The CodeNet Dataset

The CodeNet dataset consists of a large collection of code samples with extensive metadata. It also contains documented tools to transform code samples into intermediate representations and to access the dataset and make tailored selections. Our goal is to provide the community with a large, high-quality curated dataset that can be used to advance AI techniques for source code.

CodeNet is derived from the data available on two online judge websites: AIZU [8] and AtCoder [9]. Online judge websites pose programming problems in the form of courses and contests. The dataset consists of submissions to these problems, which are judged by an automated review process for correctness. Problem descriptions, submission outcomes, and associated metadata are available via various REST APIs.

Scale and Statistics. CodeNet contains a total of 13,916,868 submissions, divided into 4053 problems. Among the submissions, 53.6% (7,460,588) are accepted (compilable and pass the prescribed tests), 29.5% are marked with wrong answer, and the remaining rejected due to their failure to meet run time or memory requirements. To our knowledge, this is the largest dataset so far among similar kinds. Submissions are in 55 different languages; 95% of them are coded in C++, Python, Java, C, Ruby, and C#. C++ is the most common language, with 8,008,527 submissions (57% of the total), of which 4,353,049 are accepted. With the abundance of code samples, users can extract large benchmark datasets that are customized to their downstream use. See Figure 1 for a summary.

Diversity. The problems in CodeNet are mainly pedagogical and range from elementary exercises to sophisticated problems that require advanced algorithms. The submitters range from beginners to experienced coders. Some submissions are correct while others contain different types of errors, accordingly labeled. The submissions are in many different languages.

Code Samples. Each code sample is a single file and includes inputting the test cases and printing out the computed results. The file name uses standard extensions that denote the programming language, e.g., .py for Python. The majority of code samples contain only one function, although submissions to more complex problems might have several functions.

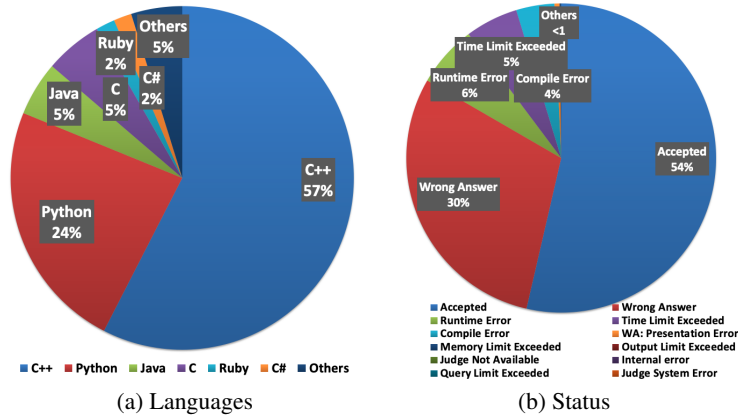

Figure 1: Percentage of submissions per language (left) and per status (right).

Metadata. The metadata enables data queries and selections among the large collection of problems, languages, and source files. The metadata is organized in a two level hierarchy. The first is the dataset level, which describes all problems. The second is the problem level, which details all the submissions to a single problem. Metadata and data are separated in the dataset structure.

At the dataset level, a single CSV file lists all problems and their origins, along with the CPU time and memory limits set for them. Additionally, every problem has an HTML file with a detailed description of the problem, the requirements and constraints, and the IO examples.

At the problem level, every problem has a CSV file. The metadata for each submission is summarized in Table 2 below, which lists the fields contained in each CSV file as well as the corresponding descriptions.

2.1 How to read the CodeNet dataset

The data and metadata are organized in a rigorous directory structure. The top level Project_CodeNet directory contains several sub-directories: data, metadata, problem_descriptions, and derived. The code samples or submissions reside under the data directory. The data directory is organized as (problem_id)/(language)/(submission), so the file path data/p00023/C++/s006384060.cpp denotes a submission to problem p00023 in C++ with id s006384060. Detailed statement of the problems can be found in problem_descriptions/(problem_id).html. The meta data for the dataset is contained in the metadata directory. metadata/problem_list.csv contains metadata for all the problems in the dataset, which is summarized in Table 1. metadata/(problem_id).csv contains the metadata for all the submissions to problem problem_id, which is described in Table 2. Each submission comes with cpu time, memory usage and status with possible values described in Table 3. The derived directory contains information derived from the dataset, such as near-duplicate information for submissions to specific languages, token sequences for code samples, and information on identical problems.

Table 1: Metadata at the dataset level

name of column	data type	unit	description
id	string	none	unique anonymized id of the problem
name	string	none	short name of the problem
dataset	string	none	original dataset, AIZU or AtCoder
time_limit	int	millisecond	maximum time allowed for a submission
memory_limit	int	KB	maximum memory allowed for a submission
rating	int	none	rating, i.e., difficulty of the problem
tags	string	none	list of tags separated by " "; not used
complexity	string	none	degree of difficulty of the problem; not used

Table 2: Metadata at the problem level

name of column	data type	unit	description
submission_id	string	none	unique anonymized id of the submission
problem_id	string	none	anonymized id of the problem
user_id	string	none	anonymized user id of the submission
date	int	seconds	date and time of submission in the Unix timestamp format (seconds since the epoch)
language	string	none	mapped language of the submission (ex: C++14 ->C++)
original_language	string	none	original language specification
filename_ext	string	none	extension of the filename that indicates the programming language used
status	string	none	acceptance status, or error type
cpu_time	int	millisecond	execution time
memory	int	KB	memory used
code_size	int	bytes	size of the submission source code in bytes
accuracy	string	none	number of tests passed; *Only for AIZU

Table 3: All the possible status values

status	abbreviation	numeric code
Compile Error	CE	0
Wrong Answer	WA	1
Time Limit Exceeded	TLE	2
Memory Limit Exceeded	MLE	3
Accepted	AC	4
Judge Not Available	JNA	5
Output Limit Exceeded	OLE	6
Runtime Error	RE	7
WA: Presentation Error	PE	8
Waiting for Judging	WJ	
Waiting for Re-judging	WR	
Internal Error	IE	
Judge System Error		

Table 4 summarizes the metadata available for each code submission to a problem. Figure 2 gives the distributions of problems based on number of submissions received.

Table 4: Submission metadata.

column	unit/example	description
submission_id	s[0-9]{9}	anonymized id of submission
problem_id	p[0-9]{5}	anonymized id of problem
user_id	u[0-9]{9}	anonymized user id
date	seconds	date and time of submission
language	C++	consolidated programming language
original_language	C++14	original language
filename_ext	.cpp	filename extension
status	Accepted	acceptance status, or error type
cpu_time	millisecond	execution time
memory	kilobytes	memory used
code_size	bytes	source file size
accuracy	4/4	passed tests (AIZU only)

Limitations. All code samples in CodeNet may not be extensively commented, and these comments may be in multitude of languages. Therefore, AI techniques that rely on learning from preponderance of comments in the code may face challenges. The code samples are solutions to high-school and

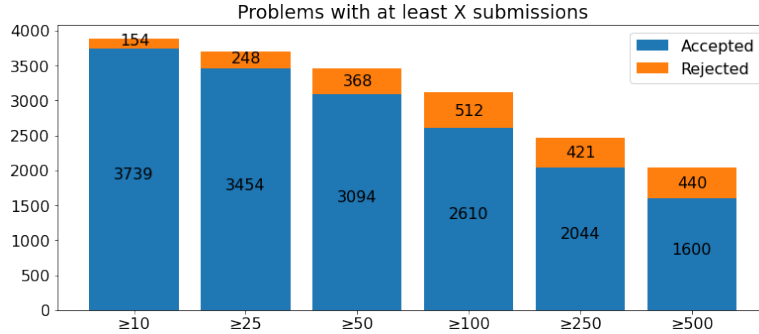

Figure 2: Number of problems providing at least X submissions. The bars show both the numbers of accepted submissions (blue) and rejected submissions (orange).

beginning college level programming problems. This dataset is not suitable for users looking for code with enterprise API’s and advanced design patterns.

3 Related Datasets

A wide variety of datasets for source code exist, with many targeting one or a small number of tasks. Such tasks include clone detection, vulnerability detection [10, 11], cloze test [12], code completion [13, 14], code repair [15], code-to-code translation, natural language code search [16], text-to-code generation [17], and code summarization [16]. A detailed discussion of several of these tasks and their respective datasets is available in CodeXGLUE [18], which is a collection of existing datasets. CodeNet, on the other hand, is a new dataset curated from scratch, that aims to support a broad set of use cases. Popular datasets of a similar kind are POJ-104 [19] (which is incorporated as part of CodeXGLUE as well) and GCJ [20] (derived from Google Code Jam). We compare CodeNet to these datasets in the following.

3.1 POJ-104

POJ-104 was collected from a pedagogical online judge system. The code samples are submissions to 104 programming problems. With 500 submissions to each problem, there is a total of 52,000 code samples in the dataset. This dataset has been used by many authors for code classification [19] and code similarity [21].

POJ-104 is faced with several limitations.

1. The code samples are in C and C++, but the two languages are not distinguished. Although they are closely related, mixing them leads to parsing errors and a reduction of useful code samples [21].
2. Useful metadata such as the results of the judging system (acceptance, error types etc.) are missing. Therefore, for certain applications where compilability or code correctness is important, additional pre-processing efforts are needed and useful code samples are reduced [21]. The dataset does not contain the problem statement, although some example problems are described in [22], and information on how to execute the code samples is absent.
3. Some problems are identical (e.g., problems 26 and 62), and some submissions are near duplicates of each other, although the percentage of such cases is low compared to other datasets.

3.2 GCJ

GCJ [20] was collected from the submissions to the Google Code Jam competitions from 2008 to 2020. Similar to CodeNet, the submissions cover a wide variety of programming languages, with C++, Java, Python, and C being the predominant ones. The C++ subset has been extracted into a POJ-104-like benchmark and used in some publications. This benchmark dataset, GCJ-297 [23], has 297 problems and approximately 280K submissions. The number of submissions is imbalanced among problems.

GCJ is advantageous over POJ-104 in size and language diversity, but we believe that an even larger dataset such as CodeNet can better serve the community. GCJ contains neither metadata nor information on identical problems and near duplicates.

4 CodeNet Differentiation

Table 5: Related datasets comparison

	CodeNet	GCJ	POJ
Total number of problems	4053	332	104
Number of programming languages	55	20	2
Total number of code samples	13,916,828	2,430,000	52,000
C++/C subset data size (code samples)	8,008,527	280,000	52,000
Percentage of problems with test data	51%	0%	0%
Task: Memory Consumption Prediction	Yes	No	No
Task: Runtime Performance Comparison	Yes	No	No
Task: Error Prediction	Yes	No	No
Task: Near duplicate prediction	Yes	No	No

A high quality code dataset has certain desired properties. We constructed CodeNet according to these requirements. In the following, we discuss how CodeNet differentiates itself from the existing datasets along these lines. Table 5 is a comparison with related datasets.

Large scale. A useful dataset should contain a large number and variety of data samples to expose the realistic and complex landscape of data distributions one meets in practice. CodeNet is the largest dataset in its class - it has approximately 10 times more code samples than GCJ and its C++ benchmark is approximately 10 times larger than POJ-104.

Rich annotation. For the dataset class in question, it is important to include information beyond which problem a code sample solves to enable a wide range of applications and use cases. It is useful to know whether a code sample solves the problem correctly, and if not, the error category (e.g., compilation error, runtime error, and out-of-memory error). Since the source code is supposed to solve a programming problem, it is advantageous to know the problem statement and have a sample input for execution and a sample output for validation. All such extra information is part of CodeNet but absent in GCJ and POJ-104.

Clean samples. For effective machine learning, the data samples are expected to be independent and identically distributed (iid); otherwise, the resulting performance metric could be significantly inflated [24]. The existence of duplicate and/or near duplicate code samples makes the iid assumption dubious. Hence, it is crucial to identify the near duplicates. The presence of identical problems in the dataset poses an even bigger issue. In CodeNet, we analyzed the code samples for (near) duplication and used clustering to find identical problems. This information is made available as part of the dataset release but it is absent in GCJ and POJ-104.

5 Construction of CodeNet

5.1 Collection of Code Samples

The CodeNet dataset contains problems, submissions, and metadata, scraped from the AIZU and AtCoder online judging systems. For AIZU, we used the provided REST APIs to download all the metadata. For AtCoder, due to the absence of a REST API, we scraped the problems, submissions, and metadata directly from the web pages. We considered only public and non-empty submissions that did not contain errors or inconsistencies in the metadata. We manually merged the information from the two sources and adopted a unified format to create a single dataset.

5.2 Cleansing

Because data are collected from different sources, we apply a consistent character encoding (UTF-8) on all raw data files. Additionally, we remove byte-order marks and use Unix-style line-feeds as the line ending.

As indicated in section 4, we identify near-duplicates. We follow Allamanis [24] and use Jaccard similarity [25] as a metric to score code pairs. Each code sample is tokenized and stored as a bag-of-tokens multiset. In our case, we keep all tokens except comments and preprocessor directives. We compute the set and multiset Jaccard indices and respectively use 0.9 and 0.8 as the near-duplicate thresholds.

Besides similar code samples, identical problems are also likely because they have been gathered over many decades. We go through the problem description files (in HTML format) and apply `fdupes` to extract identical problem pairs. Additionally, using the near-duplicate information calculated for code samples, we consider a problem pair to be a potential duplicate when the number of near-duplicate code pairs exceeds a threshold. Clustering of duplicate problems is illustrated by the graphs in Figure 3, where each node denotes a problem and an edge between two nodes is labeled by the number of near-duplicate code pairs. Each connected graph is then a cluster of potential duplicate problems and we manually inspect the problem descriptions to verify the correctness of this duplicate detection.

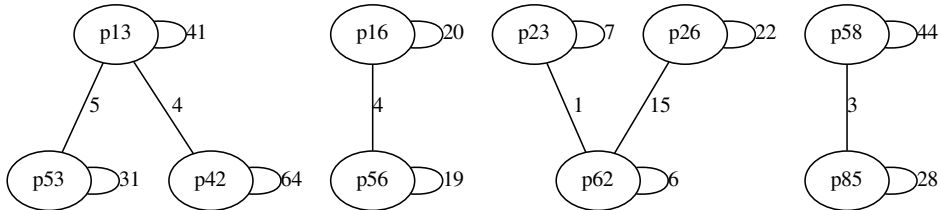

Figure 3: An example of a near-duplicate problem graph.

5.3 Benchmark Datasets

CodeNet has a rich set of code samples, and the user can assemble a customized benchmark according to his/her need. Following POJ-104, we extracted benchmark datasets from CodeNet in C++, Python, and Java. The benchmark characteristics are shown in Table 6. For the C++ benchmarks, the number of problems and their solutions are chosen to make the benchmark challenging. The benchmarks are filtered in the following ways. Each code sample is “unique” in the sense that it is not a near-duplicate of another code sample. The same is true of each problem. Samples with a large fraction of dead code are excluded. Each code sample has successfully passed through the tokenizer, the SPT generator, and the graph generator, all described in the next section. This step is to ensure that proper processing can be done to convert a code sample to a machine learning model input.

6 Code Representation and Tools

Machine learning with source code requires proper abstractions of the code. The abstractions are instantiated as representations in specific formats. As a usability feature, we provide several pre-processing tools to transform source codes into representations that can readily be used as inputs into machine learning models. They are described as follows.

Tokenizer. We offer fast C implementations of tokenizers for C, C++, Java, Python, and JavaScript. Additionally, the parse-tree generator described next can also produce token streams for C, C++, Java, and Python and can easily be extended to more languages.

Simplified Parse Tree (SPT) Simplified parse trees are derived from parse trees generated using ANTLR4 [26]. We traverse the ANTLR4 parse tree and remove internal nodes that only have one child. By doing so, we maintain the essential structure of the parse tree while pruning out unnecessary parser production rules. Finally, we adopt Aroma’s [27] naming convention: leaf nodes are named by

their literal strings and internal nodes are named by a concatenation of their children’s names (only reserved words are kept while others are replaced by a hash mark #). We produce features for each node: (1) node type (token or parsing rule); (2) token type (e.g., an identifier), when applicable; (3) parsing rule type (e.g., an expression), when applicable; and (4) whether it is a reserved word. We adopt an extensible JSON graph schema so that edges can be augmented with types when needed. Currently, we support generating SPTs for four languages: C, C++, Java, and Python. Table 6 summarizes the SPT statistics for the four benchmarks.

Table 6: Benchmark statistics.

	C++1000	C++1400	Python800	Java250
#problems	1,000	1,400	800	250
#samples	500,000	420,000	240,000	75,000
#SPT-nodes	188,449,294	198,258,050	55,744,550	25,449,640
#SPT-edges	187,949,294	197,838,050	55,504,550	25,374,640

Code graphs. We augment the tool chain with a code graph generator using WALA [28], a general framework for program analysis. The backbone of a code graph is a system dependence graph, which is an inter-procedural graph of program instructions (e.g. call, read) expressing control flow and data flow information as edges. We also generate inter-procedural control flow graphs, which are control flow graphs of all the methods in the program, stitched together to connect call sites with target methods. Our code graph tool currently supports only Java and Python, but we plan to support more languages such as Javascript.

7 CodeNet Challenge

The launch of CodeNet was well received by the AI community and the media, with coverage from Forbes[29], VentureBeat[30], ZDNet[31] and others. Within a short span of 3 months, our github received 1000 stars and has been forked over 119 times. Our vision is to use CodeNet as an umbrella to curate AI for code datasets for widespread adoption and to drive innovation in AI for code. To leverage the momentum of CodeNet, we will be launching CodeNet challenges to create excitement in the AI community. The first contest [6] is mainly pedagogical and targets aspiring data scientists. In addition, we are partnering with the Global Women in Data Science organization (with presence in over 50 countries) founded by Stanford University [7] to emphasize diversity and inclusion (teams must have at least fifty percent women). We will organize workshops to introduce the topic, code similarity, and provide educational materials. This contest will be kicked off in late September and the winner will be announced in early December, around the NeurIPS2021 time frame. The conclusion of the first contest will be followed by a contest that will target experienced AI practitioners. Potential contest topics will revolve around practical and compelling use cases such as code language translation, code repair, code performance improvement, and code memory reduction.

8 Experiments with the CodeNet Dataset

In this section, we report the results of a code classification task, a similarity task, a generalization task, and a token inference task, using the four benchmark datasets (see Table 6) extracted from CodeNet. For this paper, these experiments are not meant to achieve the best-of-breed results using the state of the art. Our intention is to provide a set of baseline results as a reference. The experiments are typically performed on a Xeon machine using P100 or V100 GPUs. Code and scripts for these experiments are in the model-experiments folder of the CodeNet repository [32].

8.1 Code Classification

In the classification task, each problem corresponds to a class: a code sample belongs to a class if it is a submission to the corresponding problem. For each experiment, 20% of the code samples are used for testing, while the rest are split in 4:1 for training and validation, respectively. We experiment with a diverse set of machine learning methods: bag of tokens, sequence of tokens, BERT model, and graph neural networks (GNNs).

1. **MLP with bag of tokens.** A code sample is represented by a vector of relative frequencies of token occurrences. Only operator and keyword tokens are used. The model is a 3-layer multilayer perceptron (MLP).
2. **CNN with token sequence.** We use the same set of tokens as above but retain their order to form a sequence. All sequences have the same length under zero padding. The classification model is a convolutional neural network (CNN) with an initial token embedding layer.
3. **C-BERT with token sequence.** Treating a code sample as a piece of natural language text, we build a C-BERT model [33] through pretraining on 10K top starred Github projects written in C. We use the Clang C tokenizer and Sentencepiece to tokenize each code sample. The pretrained model is fine-tuned on each benchmark.
4. **GNN with SPT.** Based on the parse tree representation, we use graph convolutional networks (GCN) [34] and graph isomorphism networks (GIN) [35] as well as their variants as the prediction model. The variant adds a virtual node to the graph to enhance graph message passing [36].
5. **GNN with Code Graph.** We also apply GCN on the code graph representation of the code.

Table 7: Classification accuracy (in %).

	Java250	Python800	C++1000	C++1400
MLP w/ bag of tokens	71.00±0.29	67.80±0.15	68.26±0.21	64.50±0.13
CNN w/ token sequence	89.52±0.59	87.46±0.25	93.96±0.18	93.71±0.18
C-BERT	97.40±0.19	97.09±0.18	93.79±0.01	91.83±0.06
GNN (GCN)	92.70±0.25	93.82±0.16	95.76±0.12	95.26±0.13
GNN (GCN-V)	93.02±0.81	94.30±0.15	96.09±0.17	95.73±0.07
GNN (GIN)	93.26±0.23	94.17±0.19	96.34±0.15	95.95±0.13
GNN (GIN-V)	92.77±0.66	94.54±0.12	96.64±0.10	96.36±0.10
Code Graph+GCN	94.10±.001	87.80±.007	N/A	N/A

Table 7 summarizes the classification accuracy for all models on all benchmarks. Despite the simplicity of bag of tokens, it achieves well over 60% accuracy. Maintaining token ordering, CNN with token sequence offers significant improvement, reaching approximately 90% across all benchmarks.

More complex neural models sometimes further improve the prediction performance, as witnessed by C-BERT, which reaches approximately 97% for both Java and Python. It is interesting to note that even though C-BERT is pre-trained with C programs, its performance on the two C++ benchmarks is less impressive. We speculate that such a lower performance is related to programming practices. For C++, it is common to have identical program construction, such as declaration of constants (e.g., pi and epsilon) and data structures, appear across C++ submissions to different problems, but such a practice is rare in Java and Python.

Overall, the GNN models exhibit competitive performance. They are consistently the top performers, if not the best. The code graph representation slightly improves over the SPT representation on Java, but performs less well on Python.

Further details of each model, along with the experiment environment, are given below.

8.1.1 Details of Experiments on Code Classification

MLP with Bag of Tokens

One of the simplest representations of a code sample is a bag of tokens. Here, the code sample is represented by a vector of relative frequencies of token occurrences in the source code. The vector is computed by the following steps:

1. Convert a given source code into a sequence of tokens using a tokenizer (i.e., lexical analyzer).
2. From this sequence, remove the tokens considered not useful for code classification.
3. Count the number of each token type in the reduced sequence and form a vector of counts.
4. Normalize the vector with respect to L2 norm.

We do not use all tokens available in the grammar of the programming language. Only some operators and keywords are used. All identifiers, comments and literals are ignored. We also ignore some

operators and many keywords that in our opinion provide no significant information on the algorithm the source code implements.

The vector representing a bag of tokens has the same length for every code sample, which makes it convenient for processing with a neural network. The vector is usually short, which makes training of a neural network fast. However, in a bag-of-tokens representation, information about the number of occurrences and position of each token is lost. Hence, the accuracy of a classifier using a bag-of-tokens representation is rather limited.

Table 8 provides results of code classification of all four benchmarks. The columns give the benchmark name, the test accuracy, the number of training epochs, the run time of each epoch, and the number of token types considered. All networks are implemented using Keras API of TensorFlow machine learning tool. Training is performed on a single V100 GPU, using Adam optimizer with learning rate $1e-3$, and batches of 32 samples. In each experiment, 20% of the samples are used for testing, while the rest are split in 4:1 for training and validation, respectively.

Table 8: Code classification by MLP with bag of tokens.

Benchmark dataset	Accuracy %	Number epochs	Run time sec/epoch	Number tokens
Java250	71.00 ± 0.29	30	2	81
Python800	67.80 ± 0.15	22	7	71
C++1000	68.26 ± 0.21	20	14	56
C++1400	64.50 ± 0.13	17	12	56

Figure 4 shows the neural network used for solving the classification problem for the C++1400 benchmark. The neural networks used for classification of other benchmarks are similar to this one. As we see in Table 8 their performance is quite similar.

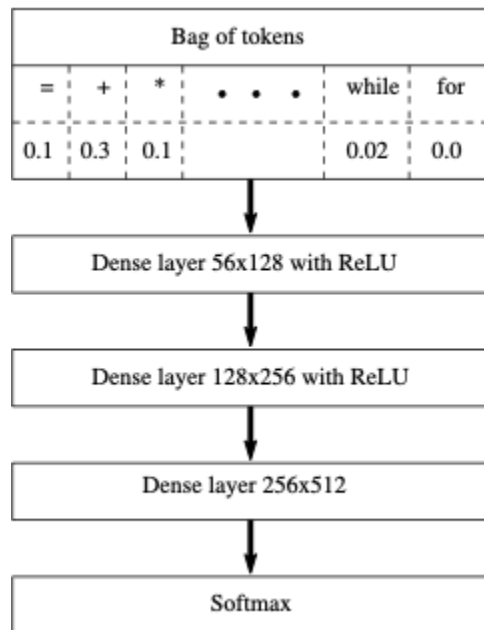

Figure 4: MLP architecture for code classification.

From Table 8 we see that training is rather fast, the reason being that the network is simple. In spite of simplicity, this neural network performs very well. The $64.50 \pm 0.13\%$ test accuracy for C++1400 benchmark dataset is significantly better than the potential 0.071% accuracy of random guess. It indicates that the relative frequencies of source code tokens provide sufficient information for classifying code.

CNN with Token Sequence

The sequence-of-tokens representation retains more information of a code sample than the bag-of-

tokens representation. For our experiments on code classification, we use the same set of tokens that is used in the above bag-of-tokens approach. Similarly, we omit all comments and identifiers.

Table 9: Code classification by CNN with token sequence.

Benchmark dataset	Accuracy %%	Number epochs	Run time sec/epoch	Number tokens
Java250	89.52±0.59	810	10	81
Python800	87.46±0.25	504	26	71
C++1000	93.96±0.18	235	59	56
C++1400	93.71±0.18	334	60	56

Table 9 shows results of code classification on all four benchmarks by using the sequence-of-tokens representation. The columns give the benchmark name, the test accuracy, the number of training epochs, the run time of each epoch, and the number of token types considered. All networks are implemented using Keras API of TensorFlow machine learning tool. The training is performed on four V100 GPUs, using Adam optimizer in data parallel mode with learning rate 1e-3, and batches of 512 samples. In each experiment, 20% of the samples are used for testing, while the rest are split in 4:1 for training and validation, respectively.

We have experimented with several types of neural networks. Figure 5 shows the neural network we choose for the C++1400 benchmark. It is a multi-layer convolutional neural network. It uses categorical encoding of source code tokens. For batching, the sequences of tokens are padded with zeros.

Using this network we get a test accuracy 93.71±0.18% for C++1400 benchmark dataset, which is significantly better than the accuracy shown by the bag-of-tokens approach. The neural networks used for classification of other benchmarks are similar to the one shown in Figure 5. As we see in Table 9, their performance is similar.

C-BERT with Token Sequence

The sequence-of-tokens representation can be used with other neural networks of increasing capacity. We build a C-BERT model (a transformer model introduced in [33]) by pre-training on 10,000 top starred GitHub open source projects written in C, where we use Clang C tokenizer and Sentencepiece to tokenize the pre-training data. The C-BERT model is then fine tuned on each classification benchmark. Additionally, we experiment with the POJ-104 dataset, which contains code examples in C and C++.

C-BERT achieves appealing results on binary classification and vulnerability detection with C source code [10, 37]. However, it has not been used on multiclass classification tasks or with other languages such as C++, Java, and Python. Because we use sub-word tokenization and different programming languages share common tokens, we could apply the C-BERT model directly on the benchmarks.

After pretraining, we fine tune the model for five epochs on each benchmark, with a batch size 32 and learning rate 2e-5. The fine-tuning was done on two V100 GPUs and it took 30 minutes to four hours, depending on the size of the dataset. The sub-word vocabulary size is 5,000. Contexts larger than 512 tokens were truncated.

Table 10 summarizes the accuracies C-BERT achieves on the four CodeNet benchmarks as well as the POJ-104 dataset. C-BERT achieves high accuracy and performs the best on Java and Python.

Table 10: C-BERT results (accuracy, in %) for code classification.

	POJ-104	C++1000	C++1400	Java250	Python800
C-BERT	98.41±0.01	93.79±0.01	91.83±0.06	97.40±0.19	97.09±0.18

The relatively low performance on C++ benchmarks is possibly related to the idiosyncrasies of the dataset and certain programming practices. Manual inspection suggests that lack of detailed variable names in C++ hurts the performance of the model, in problems appearing similar and having similar solutions. Removing one of the similar problems improves the model performance on the other problem. Moreover, one programming practice which could potentially confuse the models is that certain C++ users copied common constants (e.g., pi and epsilon) and data structures (e.g., enums) to all solutions they submitted. In many cases, these duplicate contents were not even used. We did not observe such practices in Python and Java.

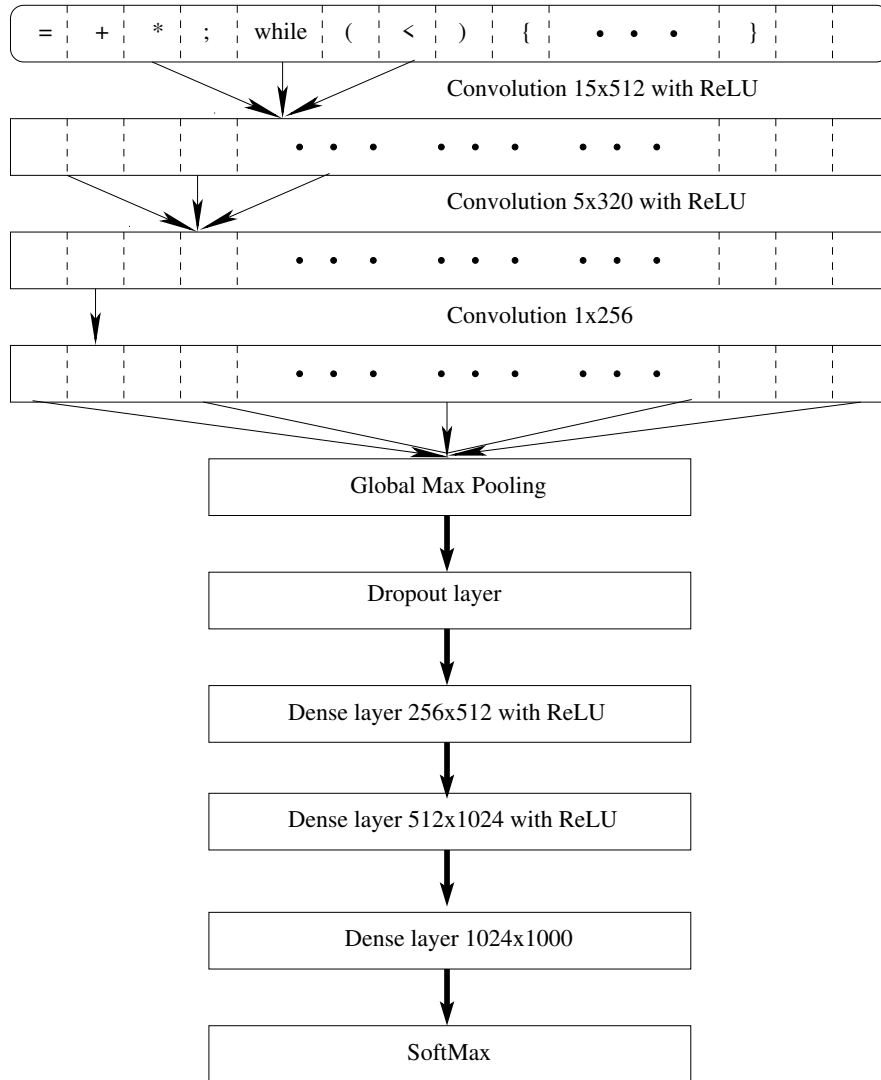

Figure 5: CNN architecture for code classification.

GNN with SPT

We experiment with four types of GNNs with SPT-based graph representations of the source code: the Graph Convolutional Network (GCN) [34], the Graph Isomorphism Network (GIN) [35], and a virtual-node-included variant for each (denoted by -V). The variant adds a virtual node to the graph to enhance graph message passing [36]. We use the Adam optimizer with learning rate $1e-3$ for training. All GNN models have five layers. We have experimented with more than 5 layers (i.e., 8 and 10), however deeper GNNs do not improve performance, as deeper GNNs might suffer from the over-smoothing problem (i.e., node features become less distinguishable after many rounds of message passing) [38].

We conduct 6/2/2 random split for each of the 4 benchmarks: i.e., 60% training data, 20% testing data, and 20% validation data. We run five folds for each benchmark with early stop "patience" set 20 (i.e., stop only when validation loss has not decreased in the past 20 epochs). Our model training typically converges within 200 epochs in a 1-fold run. We modified OGB [39] code-base with PyTorch Geometric [40] back-end over PyTorch 1.6.0 [41] to run our experiments. The experiments are conducted on one NVIDIA V100 GPU. For large benchmarks such as C++1000 and C++1400, it takes about 1 week to finish a 5-fold run. We summarize model accuracy, training time over 5-folds, and training epochs over 5-folds in Table 11. As we can see, adding a virtual node improves GNN performance (both GCN and GIN). Overall, GIN and its variants work better than GCN and its

variants, likely due to the fact that GIN theoretically generalizes the Weisfeiler-Lehman Isomorphism Test and achieves maximum expressive power among GNNs [42].

For the detailed model, hyper-parameter setup, data splits and etc, please refer to https://github.com/IBM/Project_CodeNet/tree/main/model-experiments/gnn-based-experiments.

Table 11: GNN (SPT) results for code classification. Each task trains over 5-folds with early stopping patience parameter set as 20. We record test accuracy (with standard deviation), total training time over 5 folds, and total training epochs over 5 folds.

	Java250	Python800	C++1000	C++1400
GCN	92.70±0.25 10.55 hrs 411 epochs	93.82±0.16 14.50 hrs 219 epochs	95.76±0.12 47.96 hrs 228 epochs	95.26±0.13 67.34 hrs 310 epochs
GCN-V	93.02±0.81 12.50 hrs 419 epochs	94.30 ±0.15 23.02 hrs 325 epochs	96.09±0.17 61.55 hrs 287 epochs	95.73±0.07 71.85 hrs 358 epochs
GIN	93.26±0.23 19.80 hrs 513 epochs	94.17±0.19 41.67 hrs 496 epochs	96.34±0.15 116.67 hrs 441 epochs	95.95±0.13 133.50 hrs 502 epochs
GIN-V	92.77±0.66 26.25 hrs 656 epochs	94.54±0.12 51.67 hrs 570 epochs	96.64±0.10 142.25 hrs 496 epochs	96.36±0.10 208.47 hrs 678 epochs

8.2 Code Similarity

In the similarity task, two pieces of code samples are considered similar if they solve the same problem (type-4 similarity in [43]). Note that textual similarity does not guarantee similarity in functionality. For example, programs that differ by only one token might behave very differently; hence, they are not considered similar. For the token-based experiments, we treat the problem as binary classification. We use the same training, validation and testing split as in classification. Code pairs are randomly sampled within each subset. The number of similar pairs is the same as dissimilar ones. For the SPT representation, we experiment with several popular techniques, including AROMA [27], MISIM [21], and GMN [44]. The following contains more details about the models and methods.

1. **MLP with bag of tokens.** This model is the same as the one for code classification, except that the input is a concatenation of the two bag-of-tokens vectors from each program.
2. **Siamese network with token sequence.** The token sequence is the same as the one for code classification. The model is a Siamese network with two CNNs with shared weights.
3. **SPT with handcrafted feature extraction:** The method AROMA [27] uses normalized SPT node names and handcrafted rules to extract feature vectors for each SPT. Then, similarity is computed as a dot product of the extracted feature vectors.
4. **GNN with SPT:** With the same SPT, on the other hand, MISIM [21] uses a graph neural network to extract high-level features, and uses the cosine similarity of the extracted features to compute similarity. Additionally, we apply graph matching network (GMN) [44], which uses a cross-graph attention mechanism to learn pair-wise structural similarity of graphs, on the SPT pairs to predict similarity. The implementation is adapted from [45].

Table 12: Similarity accuracy (in %).

	Java250	Python800	C++1000	C++1400
MLP w/ bag of tokens	81.80±0.06	86.61±0.08	85.82±0.05	86.54±0.07
Siamese w/ token sequence	89.70±0.18	94.67±0.12	96.19±0.08	96.56±0.07

Table 12 summarizes the classification accuracy for the first two models. The performance of bag of tokens is modest, considering that the problem is a binary classification with perfectly balanced classes. On the other hand, the Siamese model significantly outperforms bag of tokens, as expected.

Table 13 summarizes the MAP@R [46] score for two SPT-based approaches with solutions for 50% problems used for training, 25% for validation, and 25% for test. MISIM GNN model is trained for

Table 13: Similarity MAP@R score.

	Java250	Python800	C++1000	C++1400
Rule-based w/ SPT (AROMA)	0.19	0.19	0.17	0.15
GNN w/ SPT (MISIM)	0.64±0.007	0.65±0.003	0.78±0.005	0.77±0.002

1000 epochs. AROMA results in a relatively low score because the feature extraction is rule-based and no model is learned, whereas MISIM uses a neural network to extract features through supervised training.

Table 14: Similarity MAP@R score on Java250.

	(p4, s5)	(p3, s300)	(p10, s300)
GNN w/ SPT (MISIM, structure only)	0.472±0.023	0.194±0.010	0.096±0.009
GNN w/ SPT (GMN, structure only)	0.679±0.056	0.432±0.035	0.256±0.015
GNN w/ SPT (GMN + MISIM node attributes)	0.985±0.015	0.794±0.036	0.780±0.026

Exploring further into the Java250 benchmark, Table 14 summarizes the MAP@R score with a variety of test sets: (p4, s5), (p3, s300), and (p10, s300), indicating 4, 3, and 10 problems with 5, 300 and 300 solutions each respectively. Across all test sets, GMN outperforms MISIM if both are trained with only the SPT structure; when combined with MISIM node attributes, GMN further improves the score significantly.

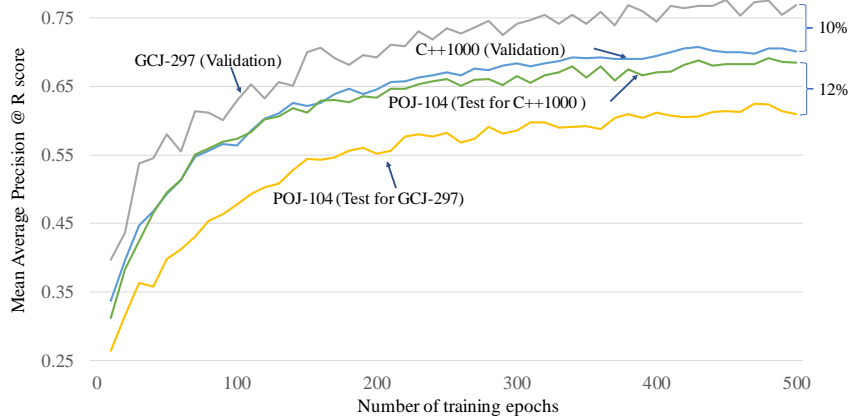

Figure 6: Test score on POJ-104 is 12% higher when a model is trained on C++1000 as compared to a model trained on GJJ-297, even though the validation score for GJJ-297 model is 10% higher than the validation score for C++1000 model.

Further details of each model, along with the experiment environment, are given below.

8.2.1 Details of Experiments on Code Similarity

MLP with Bag of Tokens

For experiments on code similarity analysis, we use the same bag of tokens as for code classification. The input to the neural network is constructed by concatenating two bags of tokens, one for each source code file.

Table 15 provides results of code similarity analysis on all four benchmarks. The columns give the benchmark name, the test accuracy, the number of training epochs, the number of samples in each epoch, the run time of each epoch, the number of token types considered, and the number of test samples. All networks are implemented using Keras API of TensorFlow machine learning tool. The training is performed on a single V100 GPU, using Adam optimizer with learning rate 1e-3, and batches of 256 samples.

Table 15: Similarity analysis by MLP with bag of tokens.

Benchmark dataset	Accuracy %	Number epochs	Size of epoch	Run time sec/epoch	Number tokens	N test samples
Java250	81.80±0.06	20	4,096,000	21	81	512,000
Python800	86.61±0.08	94	4,096,000	24	71	512,000
C++1000	85.82±0.05	64	4,096,000	21	56	512,000
C++1400	86.54±0.07	64	4,096,000	22	56	512,000

Figure 7 shows the neural network used for code similarity analysis on the C++1400 benchmark. The neural networks used for code similarity analysis on other benchmarks are similar to this one. As we see in Table 15, their accuracy is similar.

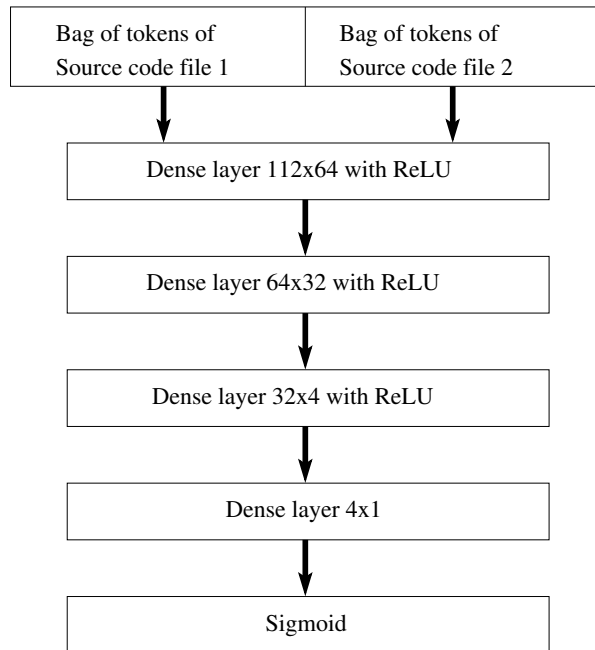

Figure 7: MLP architecture for similarity analysis.

As we see in Table 15, the model accuracy is rather modest (<87%) for all benchmark datasets, which is not very high for a binary classification problem of a fully balanced dataset. Obviously, the bag of tokens is too primitive and misses many important details necessary for identifying similarity.

Siamese Network with Token Sequence

For experiments on code similarity, we use the same sequence of tokens as for code classification. The neural network has two inputs, one for each source code file. After experimenting with various neural network architectures, we select the siamese network for its good performance.

Table 16 provides results of code similarity analysis on all four benchmarks. The columns give the benchmark name, the test accuracy, the number of training epochs, the number of samples in each epoch, the run time of each epoch, the number of token types considered, and the number of test samples. All networks are implemented using Keras API of TensorFlow machine learning tool. The training is performed on four V100 GPUs, using Adam optimizer in data parallel mode with learning rate 1e-3, and batches of 512 samples.

The neural network for the C++1400 benchmark is depicted in Figure 8. The siamese parts of the network have the same structure and share all their weights. If the inputs are identical, so are the outputs. Therefore, by construction, the network guarantees detecting similarity of identical source code samples. The outputs of the siamese parts are compared by computing the absolute difference.

Table 16: Similarity analysis by Siamese network with token sequence.

Benchmark dataset	Accuracy %%	Number epochs	Size of epoch	Run time sec/epoch	Number tokens	N test samples
Java250	89.70±0.18	29	51,200	114	75	512,000
Python800	94.67±0.12	110	64,000	89	71	512,000
C++1000	96.19±0.08	123	64,000	89	56	512,000
C++1400	96.56±0.07	144	64,000	96	56	512,000

The network shows $96.56\pm 0.07\%$ test accuracy for C++1400 benchmark dataset. We consider this a good result, especially considering that the token sequence ignores all identifiers, comments, and many keywords. The neural networks used for code similarity analysis of other benchmarks are similar to the one shown in Figure 8. As we see in Table 16, their accuracy is quite similar.

SPT-based experiments

Following MISIM [21], the train, validation, and test datasets for the SPT-based experiments draw from entirely different problems. In our experiments, we use 50% problems for training, 25% for validation, and 25% for test. The train, validation, and test split used for the experiments can be found at [47]. Similarity scores in Table 13 and Table 14 report mean and standard deviation of MAP@R [46] values evaluated with models trained using five random seeds. The models are trained on a Xeon(R) CPU E5-2680 v4, 2.4GHz, 256 GiB memory using a NVIDIA V100 GPU. The SPTs used in these experiments have nodes annotated with attributes derived by combining SPT features (refer to Section 6), following the context-aware semantic structure (CASS) proposed in [21].

AROMA experiments are performed using the implementation of MISIM given in the further details section below [23] and the input (SPTs) used for these experiments can be found at [47]. Due to the high memory requirement for computing MAP@R on the test set of CodeNet benchmarks, we had to reduce the feature set of AROMA. We estimate that AROMA results can improve by 10–25% when all features are used. AROMA is rule-based and no training is involved, hence we don’t report mean and standard deviation in Table 13. For each of the four datasets – Java250, Python800, C++1000, C++1400 – MISIM’s GNN model is trained for a total of 1000 epochs at a learning rate of 0.001 with Adam optimizer. Each epoch consists of 1000 iterations, and in each iteration, 16 problems and 5 solutions per problem are randomly sampled, and all solution pairs are used for training as in [21]. MISIM results for the four languages can be reproduced by downloading the MISIM code and scripts [23] and using the provided CASS files [47] as input.

For the GMN experiments (row 2 and row 3 in Table 14), we adapt the implementation in [45] of the GMN model [44] using SPTs [47] as graphs. We follow the recommendations in [44] for the model configuration, as they produce the best and stable results in our experiments. Specifically, we use 5 layers of propagation with weight sharing across layers, dot-product similarity for the cross-graph attention mechanism, and GRU layer to update node embeddings from the propagation scheme. For GMN training, given the large set of SPT pairs, we adopt an approach similar to [21] of randomly sampling 16 problems with 5 solutions each. We use triplet loss with approximate hamming similarity [44] for each sample, which is formed using a similar pair combined with a dissimilar SPT. After every 100 iterations with a batch size of 64, another set of 16 problems and 5 solutions are sampled randomly for a total of 150,000 iterations (1500 sampled sets). GMN results could improve further with more training iterations. We use Adam optimizer with a learning rate of $1e-4$ for training.

The first two rows of Table 14 compare similarity models trained on SPT graph structure only. The first row in the table adapts the MISIM GNN model by masking the node labels to allow the model to learn structural features only. The second row uses the GMN [44] model with cross-graph attention-based matching for structural similarity using a node vector dimension of 32 and graph representation dimension of 128.

For the GMN+MISIM node attributes experiment, row 3 in Table 14, we allow the GMN model to learn features based on both node attributes and the SPT structure. Accordingly, we replace the node encoder in the GMN, an MLP, with an embedding layer, for generating node feature vectors. We explore different node feature vector dimensions, such as 64, 100, 128, and found 100 to produce good results for the given number of training iterations. All other parameter settings remain the same as the structure only GMN experiments from row 2 of Table 14. The GMN results can be reproduced using the Java250 CASS files available at [47].

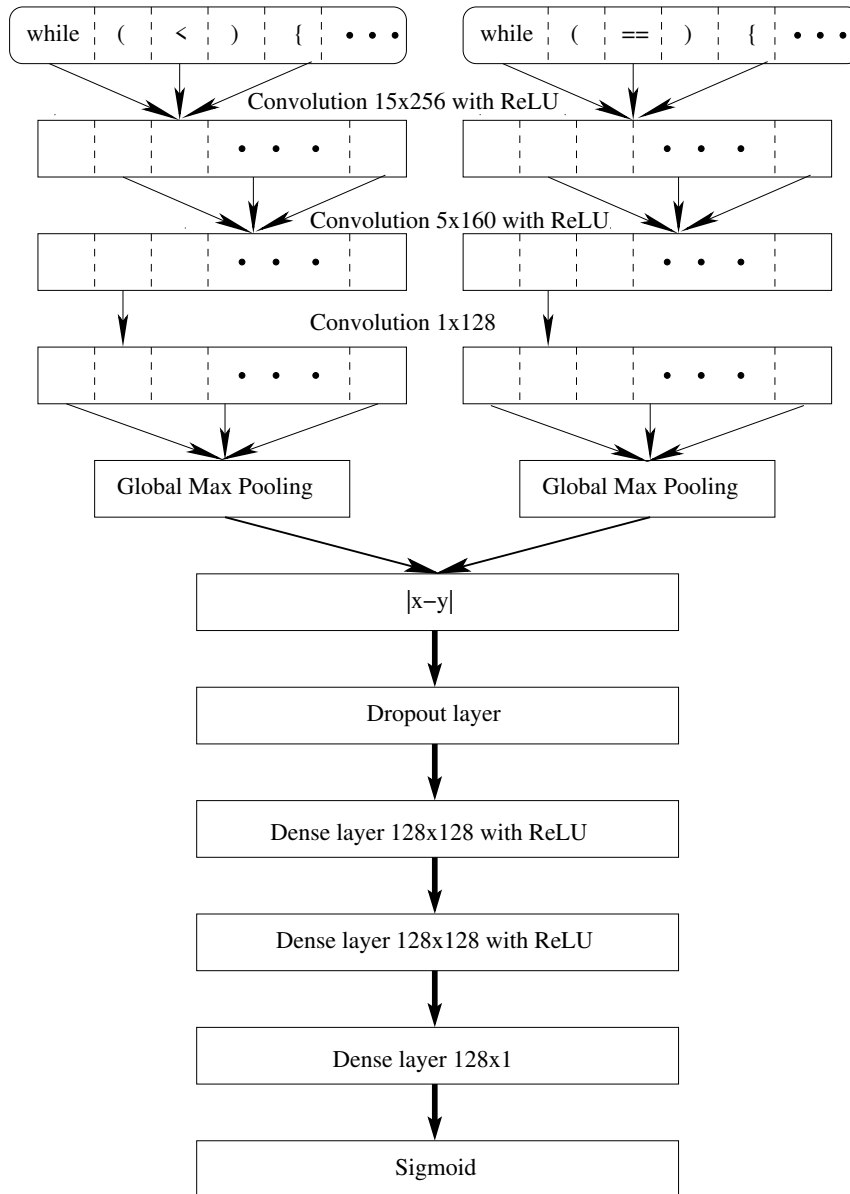

Figure 8: Siamese architecture for similarity analysis.

MAP@R score [46] is computationally expensive for GMN models because an embedding has to be computed for all SPT pairs in the test set, and hence Table 14 reports results on smaller sampled test sets.

Details of MLM Experiment

Here we show how a masked language model (MLM) can be trained with CodeNet. We closely follow the approach by Ankur Singh, documented in the blog [48]. The goal of the model is to infer the correct token for an arbitrary masked-out location in the source text. We assume that in every text, precisely one token is randomly masked. The original token at such position is then the golden label.

From each of the 1000 C++1000 problems, we randomly select 100 samples for training and another 100 for testing. Each C++ source file is tokenized into a vocabulary of 442 distinct tokens as categorized in Table 17. For example, `while` is a keyword and `strlen` is a function literal.

This code snippet:

Table 17: Token categories used for MLM.

Type	Count	Description
the keyword	95	all C++20 reserved words
the function	280	function names in common header files
the identifier	42	standard identifiers, like stderr, etc.
the punctuator	16	small set of punctuation symbols
# or ##	2	the C pre-processor symbols
0, 1	2	special case for these frequent constants
the token class	5	identifier, number, operator, character, string

```
for (i = 0; i < strlen(s); i++) {}
```

will be tokenized to:

```
for ( id = 0 ; id < strlen ( id ) ; id operator ) { }
```

The tokenized source files are read into a pandas dataframe and processed by the Keras Text Vectorization layer, to extract a vocabulary and encode all token lines into vocabulary indices, including the special “[mask]” token. Each sample has a fixed token length of 256. The average number of tokens per sample across the training set is 474. Short samples are padded with 0 and those that are too large are simply truncated.

The model is trained with 100,000 samples in batches of 32 over five epochs, with a learning rate of 0.001 using the Adam optimizer. We evaluate the trained model on a test set of 100,000 samples. Each sample is pre-processed in the same way as the training samples and one token (never a padding) is arbitrarily replaced by the “[mask]” symbol. Then, a prediction is generated and the top 1 and top 5 results are compared with the expected value. The achieved accuracies are top-1: 0.9104 (stddev: 0.002) and top-5: 0.9935 (stddev: 0.0005).

8.3 Generalization Across Datasets

Models trained on the CodeNet benchmark datasets can benefit greatly from their high quality. To demonstrate this, we compare C++1000 to one of the largest publicly available datasets of its kind, GCJ-297 [23]. For the purpose of this comparison, we train the same MISIM model on C++1000 and GCJ-297 and test the two trained models on a third, independent dataset - POJ-104. The result of this comparison is plotted in Figure 6.

The x -axis of this plot is the number of training epochs used and the y -axis is the MAP@R score. The MISIM model for both datasets is trained for 500 epochs and the MAP@R score for validation and test is computed after every ten epochs. There are a total of four curves - a validation and a test curve for GCJ-297 and a validation and a test curve for C++1000.

The training curves show that a 10% higher validation score can be achieved with GCJ-297 compared to C++1000. However, when tested on POJ-104, the model trained on GCJ-297 achieves a 12% lower score compared to the model trained on C++1000. We believe C++1000 has better generalization than GCJ-297 mainly for two reasons: i) high data bias in GCJ-297 because the top 20 problems with the most number of submissions account for 50% of all submissions and ii) cleaning and de-duplication of submissions in CodeNet dataset (as described in Section 5.2).

8.4 Masked Language Modelling for Token Inference

A task such as code completion relies on the ability to predict a token at a certain position in a sequence. To accomplish this we can build a masked language model (MLM) using a technique that randomly masks out tokens in an input sequence and aims to correctly predict them in an as-yet-unseen test set. We train a popular BERT-like attention model on the C++1000 CodeNet benchmark after tokenization to a vocabulary of over 400 tokens and obtain a top-1 prediction accuracy of 0.9104 (stddev: 0.002) and a top-5 accuracy of 0.9935 (stddev: 0.0005).

9 Further Uses of CodeNet

The rich metadata and language diversity open CodeNet to a plethora of use cases. The problem-submission relationship in CodeNet corresponds to type-4 similarity [43] and can be used for code search and clone detection. The code samples in CodeNet are labeled with their acceptance status so we can readily extract pairs of buggy and fixed code for code repair [49, 50]. A large number of code samples come with inputs so that we can execute the code to extract the CPU run time and memory footprint, which can be used for regression studies and prediction.

CodeNet may also be used for program translation, given its wealth of programs written in a multitude of languages. Translation between two programming languages is born out of a practical need to port legacy codebases to modern languages in order to increase accessibility and lower maintenance costs. With the help of neural networks, machine translation models developed for natural languages [51] were adapted to programming languages, producing pivotal success [4]. One considerable challenge of neural machine translation is that model training depends on large, parallel corpora that are expensive to curate [52], especially for low-resource languages (e.g., legacy code). Recently, monolingual approaches [53, 4] were developed to mitigate the reliance on parallel data, paving ways to build models for languages with little translation. Compared with current popular data sets (e.g., [4, 54]), CodeNet covers a much richer set of languages with ample training instances.

10 Conclusion

Artificial intelligence has made great strides in understanding human language. Computer scientists have been fascinated by the possibility and tantalized by the vision of computers (AI) programming computers. In this paper, we presented "CodeNet", a first-of-its-kind very large-scale, diverse and high-quality dataset to accelerate the algorithmic advances in AI for Code. This dataset is not only unique in its scale, but also in the diversity of coding tasks it can help benchmark: from code similarity and classification for advances in code recommendation algorithms, and code translation between a large variety of programming languages, to advances in code performance improvement techniques. We hope that the scale, diversity and rich, high-quality annotations of CodeNet will offer unprecedented research opportunities at the intersection of AI and Software Engineering.

11 Acknowledgements

We would like to acknowledge AIZU and AtCoder for making the code submissions publicly available. We would like to thank the IBM Data Asset eXchange team for providing a platform to host the CodeNet dataset. We would like to thank the Women in Data Science team at Stanford University and the IBM Call for Code team for their collaboration in launching the CodeNet challenge.

12 Bibliography

- [1] Miltiadis Allamanis, Earl T Barr, Premkumar Devanbu, and Charles Sutton. A survey of machine learning for big code and naturalness. *ACM Computing Surveys (CSUR)*, 51(4):1–37, 2018.
- [2] Yanming Yang, Xin Xia, David Lo, and John Grundy. A survey on deep learning for software engineering. *arXiv preprint arXiv:2011.14597*, 2020.
- [3] Mark Chen, Jerry Tworek, Heewoo Jun, Qiming Yuan, Henrique Ponde de Oliveira Pinto, Jared Kaplan, Harri Edwards, Yuri Burda, Nicholas Joseph, Greg Brockman, Alex Ray, Raul Puri, Gretchen Krueger, Michael Petrov, Heidy Khlaaf, Girish Sastry, Pamela Mishkin, Brooke Chan, Scott Gray, Nick Ryder, Mikhail Pavlov, Alethea Power, Lukasz Kaiser, Mohammad Bavarian, Clemens Winter, Philippe Tillet, Felipe Petroski Such, Dave Cummings, Matthias Plappert, Fotios Chantzis, Elizabeth Barnes, Ariel Herbert-Voss, William Hebggen Guss, Alex Nichol, Alex Paino, Nikolas Tezak, Jie Tang, Igor Babuschkin, Suchir Balaji, Shantanu Jain, William Saunders, Christopher Hesse, Andrew N. Carr, Jan Leike, Josh Achiam, Vedant Misra, Evan Morikawa, Alec Radford, Matthew Knight, Miles Brundage, Mira Murati, Katie Mayer, Peter Welinder, Bob McGrew, Dario Amodei, Sam McCandlish, Ilya Sutskever, and Wojciech Zaremba. Evaluating large language models trained on code, 2021.

- [4] Marie-Anne Lachaux, Baptiste Roziere, Lowik Chaussoot, and Guillaume Lample. Unsupervised translation of programming languages. In *NeurIPS*, 2020.
- [5] Zheng Wang and Michael O’Boyle. Machine learning in compiler optimization. *Proceedings of the IEEE*, 106(11):1879–1901, 2018.
- [6] <http://ibm.biz/cfcsc-codenet>.
- [7] Women in data science. <https://widsconference.org/>.
- [8] Yutaka Watanobe. Aizu online judge. <https://onlinejudge.u-aizu.ac.jp>.
- [9] Atcoder. <https://atcoder.jp/>.
- [10] Yunhui Zheng, Saurabh Pujar, Burn Lewis, Luca Buratti, Edward Epstein, Bo Yang, Jim Laredo, Alessandro Morari, and Zhong Su. D2a: A dataset built for ai-based vulnerability detection methods using differential analysis. In *Proceedings of the ACM/IEEE 43rd International Conference on Software Engineering: Software Engineering in Practice, ICSE-SEIP ’21*, New York, NY, USA, 2021. Association for Computing Machinery.
- [11] Yaqin Zhou, Shangqing Liu, Jingkai Siow, Xiaoning Du, and Yang Liu. Devign: Effective vulnerability identification by learning comprehensive program semantics via graph neural networks. In *Advances in Neural Information Processing Systems*, pages 10197–10207. NeurIPS Foundation, 2019.
- [12] Zhangyin Feng, Daya Guo, Duyu Tang, Nan Duan, Xiaocheng Feng, Ming Gong, Linjun Shou, Bing Qin, Ting Liu, and Daxin Jiang. Codebert: A pre-trained model for programming and natural languages. *arXiv preprint arXiv:2002.08155v4*, 2020.
- [13] Miltiadis Allamanis and Charles Sutton. Mining source code repositories at massive scale using language modeling. In *10th Working Conference on Mining Software Repositories (MSR)*, page 207–216. IEEE, 2013.
- [14] Veselin Raychev, Pavol Bielek, and Martin Vechev. Probabilistic model for code with decision trees. *ACM SIGPLAN Notices*, 2016.
- [15] Michele Tufano, Cody Watson, Gabriele Bavota, Massimiliano Di Penta, Martin White, and Denys Poshyvanyk. An empirical study on learning bug-fixing patches in the wild via neural machine translation. In *ACM Transactions on Software Engineering and Methodology (TOSEM)*, pages 1–29, 2019.
- [16] Hamel Husain, Ho-Hsiang Wu, Tiferet Gazit, Miltiadis Allamanis, and Marc Brockschmidt. Codesearchnet challenge: Evaluating the state of semantic code search. *arXiv preprint arXiv:1909.09436v3*, 2019.
- [17] Srinivasan Iyer, Ioannis Konostas, Alvin Cheung, and Luke Zettlemoyer. Mapping language to code in programmatic context. *arXiv preprint arXiv:1808.09588*, 2018.
- [18] Shuai Lu, Daya Guo, Shuo Ren, Junjie Huang, Alexey Svyatkovskiy, Ambrosio Blanco, Colin Clement, Dawn Drain, Daxin Jiang, Duyu Tang, Ge Li, Lidong Zhou, Linjun Shou, Long Zhou, Michele Tufano, Ming Gong, Ming Zhou, Nan Duan, Neel Sundaresan, Shao Kun Deng, Shengyu Fu, and Shujie Liu. Codexglue: A machine learning benchmark dataset for code understanding and generation, 2021.
- [19] Tal Ben-Nun, Alice Shoshana Jakobovits, and Torsten Hoeffler. Neural code comprehension: A learnable representation of code semantics. In S. Bengio, H. Wallach, H. Larochelle, K. Grauman, N. Cesa-Bianchi, and R. Garnett, editors, *Advances in Neural Information Processing Systems 31*, pages 3588–3600. Curran Associates, Inc., 2018.
- [20] Farhan Ullah, Hamad Naeem, Sohail Jabbar, Shehzad Khalid, Muhammad Ahsan Latif, Fadi Al-turjman, and Leonardo Mostarda. Cyber security threats detection in internet of things using deep learning approach. *IEEE Access*, 7:124379–124389, 2019.
- [21] Fangke Ye, Shengtian Zhou, Anand Venkat, Ryan Marcus, Nesime Tatbul, Jesmin Jahan Tithi, Niranjana Hasabnis, Paul Petersen, Mattson. Timothy, Tim Kraska, Pradeep Dubey, Vivek Sarkar, and Justin Gottschlich. Misim: A novel code similarity system, 2021.
- [22] <https://sites.google.com/site/treebasedcnn/home/problemdescription>.
- [23] gcj-dataset. https://openreview.net/attachment?id=AZ4vmLoJft&name=supplementary_material.

- [24] Miltiadis Allamanis. The adverse effects of code duplication in machine learning models of code. In *Proceedings of the 2019 ACM SIGPLAN International Symposium on New Ideas, New Paradigms, and Reflections on Programming and Software*, Onward! 2019, page 143–153, New York, NY, USA, 2019. Association for Computing Machinery.
- [25] Wikipedia. Jaccard index — Wikipedia, the free encyclopedia. https://en.wikipedia.org/wiki/Jaccard_index, 2020.
- [26] Terence Parr. *The Definitive ANTLR 4 Reference*. Pragmatic Bookshelf, 2nd edition, 2013.
- [27] Sifei Luan, Di Yang, Celeste Barnaby, Koushik Sen, and Satish Chandra. Aroma: code recommendation via structural code search. *Proceedings of the ACM on Programming Languages*, 3(OOPSLA):1–28, Oct 2019.
- [28] IBM T.J. Watson Research Center. Wala. <https://github.com/wala/WALA>, 2021.
- [29] Forbes on codenet. <https://www.forbes.com/sites/moorinsights/2021/06/04/ibm-codenet-artificial-intelligence-that-can-program-computers-and-solve-a-100-billion-legacy-code-problem/?sh=343813636cdc>.
- [30] Venturebeat on codenet. <https://venturebeat.com/2021/05/10/ibms-codenet-dataset-aims-to-train-ai-to-tackle-programming-challenges/>.
- [31] Zdnet on codenet. <https://www.zdnet.com/article/ibm-launches-autosql-watson-orchestrate-codenet-enterprise-ai-tools-at-think/>.
- [32] Project codenet repository. https://github.com/IBM/Project_CodeNet.
- [33] Luca Buratti, Saurabh Pujar, Mihaela Bornea, Scott McCarley, Yunhui Zheng, Gaetano Rossiello, Alessandro Morari, Jim Laredo, Veronika Thost, Yufan Zhuang, and Giacomo Domeniconi. Exploring software naturalness through neural language models, 2020.
- [34] Thomas N. Kipf and Max Welling. Semi-supervised classification with graph convolutional networks. In *ICLR*, 2017.
- [35] Keyulu Xu, Weihua Hu, Jure Leskovec, and Stefanie Jegelka. How powerful are graph neural networks? In *ICLR*, 2019.
- [36] Veronika Thost and Jie Chen. Directed acyclic graph neural networks. In *ICLR*, 2021.
- [37] Shuai Lu, Daya Guo, Shuo Ren, Junjie Huang, Alexey Svyatkovskiy, Ambrosio Blanco, Colin B. Clement, Dawn Drain, Daxin Jiang, Duyu Tang, Ge Li, Lidong Zhou, Linjun Shou, Long Zhou, Michele Tufano, Ming Gong, Ming Zhou, Nan Duan, Neel Sundaresan, Shao Kun Deng, Shengyu Fu, and Shujie Liu. Codexglue: A machine learning benchmark dataset for code understanding and generation. *CoRR*, abs/2102.04664, 2021.
- [38] Qimai Li, Zhichao Han, and Xiao-Ming Wu. Deeper insights into graph convolutional networks for semi-supervised learning, 2018.
- [39] Weihua Hu, Matthias Fey, Marinka Zitnik, Yuxiao Dong, Hongyu Ren, Bowen Liu, Michele Catasta, and Jure Leskovec. Open graph benchmark: Datasets for machine learning on graphs. *arXiv preprint arXiv:2005.00687*, 2020.
- [40] Matthias Fey and Jan E. Lenssen. Fast graph representation learning with PyTorch Geometric. In *ICLR Workshop on Representation Learning on Graphs and Manifolds*, 2019.
- [41] Adam Paszke, Sam Gross, Francisco Massa, Adam Lerer, James Bradbury, Gregory Chanan, Trevor Killeen, Zeming Lin, Natalia Gimelshein, Luca Antiga, Alban Desmaison, Andreas Kopf, Edward Yang, Zachary DeVito, Martin Raison, Alykhan Tejani, Sasank Chilamkurthy, Benoit Steiner, Lu Fang, Junjie Bai, and Soumith Chintala. Pytorch: An imperative style, high-performance deep learning library. In H. Wallach, H. Larochelle, A. Beygelzimer, F. d'Alché-Buc, E. Fox, and R. Garnett, editors, *Advances in Neural Information Processing Systems 32*, pages 8024–8035. Curran Associates, Inc., 2019.
- [42] Keyulu Xu, Weihua Hu, Jure Leskovec, and Stefanie Jegelka. How powerful are graph neural networks?, 2019.
- [43] Hitesh Sajani. *Large-Scale Code Clone Detection*. PhD thesis, University of California, Irvine, 2016.
- [44] Yujia Li, Chenjie Gu, Thomas Dullien, Oriol Vinyals, and Pushmeet Kohli. Graph matching network for learning the similarity of graph structured objects. In *International Conference on Machine Learning (ICML)*, 2019.

- [45] Graph-matching-networks. <https://github.com/Lin-Yijie/Graph-Matching-Networks>.
- [46] Kevin Musgrave, Serge J. Belongie, and Ser-Nam Lim. A metric learning reality check. *CoRR*, abs/2003.08505, 2020.
- [47] Codenet dataset. <https://developer.ibm.com/exchanges/data/all/project-codenet>.
- [48] Ankur Singh. "end-to-end masked language modeling with bert". https://keras.io/examples/nlp/masked_language_modeling.
- [49] Zimin Chen, Steve Kommrusch, Michele Tufano, Louis-Noël Pouchet, Denys Poshyvanyk, and Martin Monperrus. Sequencer: Sequence-to-sequence learning for end-to-end program repair. *IEEE Transaction on Software Engineering*, 2019.
- [50] Michihiro Yasunaga and Percy Liang. Break-it-fix-it: Unsupervised learning for program repair. In *International Conference on Machine Learning (ICML)*, 2021.
- [51] Yonghui Wu, Mike Schuster, Zhifeng Chen, Quoc V. Le, Mohammad Norouzi, Wolfgang Macherey, Maxim Krikun, Yuan Cao, Qin Gao, Klaus Macherey, Jeff Klingner, Apurva Shah, Melvin Johnson, Xiaobing Liu, Łukasz Kaiser, Stephan Gouws, Yoshikiyo Kato, Taku Kudo, Hideto Kazawa, Keith Stevens, George Kurian, Nishant Patil, Wei Wang, Cliff Young, Jason Smith, Jason Riesa, Alex Rudnick, Oriol Vinyals, Greg Corrado, Macduff Hughes, and Jeffrey Dean. Google’s neural machine translation system: Bridging the gap between human and machine translation. Preprint arXiv:1609.08144, 2016.
- [52] Xinyun Chen, Chang Liu, and Dawn Song. Tree-to-tree neural networks for program translation. In *NeurIPS*, 2018.
- [53] Guillaume Lample, Alexis Conneau, Ludovic Denoyer, and Marc’Aurelio Ranzato. Unsupervised machine translation using monolingual corpora only. In *ICLR*, 2018.
- [54] Shuai Lu, Daya Guo, Shuo Ren, Junjie Huang, Alexey Svyatkovskiy, Ambrosio Blanco, Colin Clement, Dawn Drain, Daxin Jiang, Duyu Tang, Ge Li, Lidong Zhou, Linjun Shou, Long Zhou, Michele Tufano, Ming Gong, Ming Zhou, Nan Duan, Neel Sundaresan, Shao Kun Deng, Shengyu Fu, and Shujie Liu. CodeXGLUE: A machine learning benchmark dataset for code understanding and generation. Preprint arXiv:2102.04664, 2021.