

Towards a Denotational Semantics for Proofs in Constructive Modal Logic

Matteo Acclavio Davide Catta Lutz Straßburger

Abstract

In this paper we provide two new semantics for proofs in the constructive modal logics CK and CD.

The first semantics is given by extending the syntax of combinatorial proofs for propositional intuitionistic logic, in which proofs are factorised in a linear fragment (arena net) and a parallel weakening-contraction fragment (skew fibration). In particular we provide an encoding of modal formulas by means of directed graphs (modal arenas), and an encoding of linear proofs as modal arenas equipped with vertex partitions satisfying topological criteria.

The second semantics is given by means of winning innocent strategies of a two-player game over modal arenas. This is given by extending the Heijltjes-Hughes-Straßburger correspondence between intuitionistic combinatorial proofs and winning innocent strategies in a Hyland-Ong arena. Using our first result, we provide a characterisation of winning strategies for games on a modal arena corresponding to proofs with modalities.

1 Introduction

Semantics is the area of logic concerned with specifying the meaning of the logical constructs. We distinguish between two main kind of semantic approach to logic. The first, the model-theoretic approach, is concerned with specifying the meaning of formulas in terms of truth in some model. The second, the denotational semantic approach, is concerned with specifying the meaning of proofs of the logic under a compositional point of view. Proofs are interpreted as mathematical objects called denotation, and the meaning of composed proofs is obtained by composing denotations.

Modal logics are extensions of classical logic making use of *modalities* to qualify the truth of a judgement. According with the interpretation of such modalities, modal logics find applications, for example, in knowledge representation [40], artificial intelligence [33] and verification [21]. More precisely, modal logics are obtained by extending classical logic with a modality operator \Box (together with its dual operator \Diamond), which are usually interpreted as *necessity* (respectively *possibility*).

When we move from the classical to the intuitionistic setting we are forced to make some choices since there are many different flavours of “intuitionistic modal logics” (see, e.g., [15, 36, 35, 37, 9, 13]). This range of possible extensions of the intuitionistic logic depends on the fact that the classical k-axiom $\Box(A \supset B) \supset (\Box A \supset \Box B)$

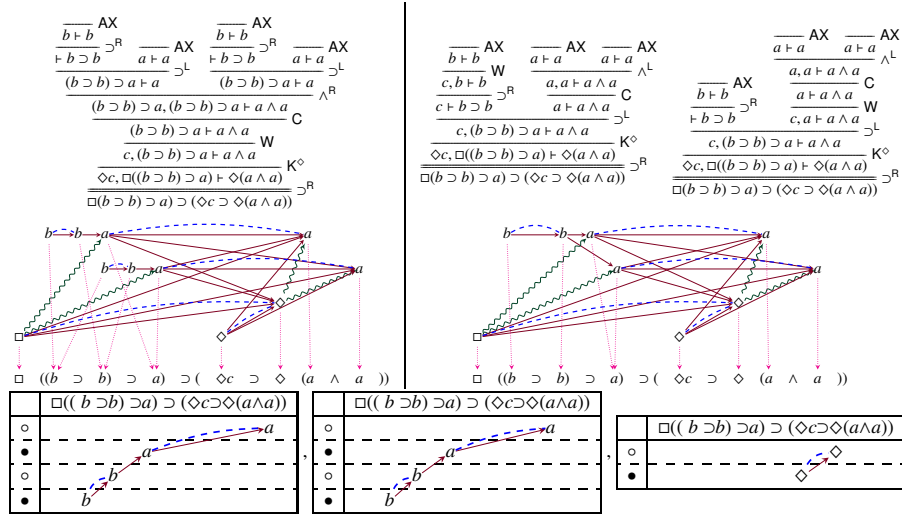

Figure 1: **Above:** three derivations of the formula $F = \Box((b \supset b) \supset a) \supset (\Diamond c \supset \Diamond(a \wedge a))$ together with their corresponding CK-ICP. **Below:** the three maximal views on the modal arena of F in the CK-WIS corresponding to the above proofs.

is no longer sufficient to express the behaviour of the modality \Diamond as it is no longer the dual of \Box . We here consider the minimal approach and only add the axiom $\Box(A \supset B) \supset (\Diamond A \supset \Diamond B)$, leading to what in the literature is now called *constructive modal logics* [36, 9, 20, 32, 14, 27].

Both the denotational approach and the model-theoretic approach have been developed in the literature on constructive modal logics. One of the desired feature of denotational models is full completeness: in a full complete model every denotation is the interpretation of some proof. Reasoning about the property of full complete models allows one to have a syntax-free characterization of the property of proofs. We say that a denotational model is *concrete* if its elements are not obtained by the quotient on proofs induced by cut-elimination. To our knowledge, the only full complete denotational model for this logic is not concrete since defined by the quotient of their λ -calculi with respect to β -reduction [7, 9].

The purpose of this paper is to lay the foundations for a concrete denotational full complete model in terms of a *game semantics* [1, 26, 31] for this logic by providing a definition of proofs denotations. Game semantics is a denotational semantics where proofs are denoted by winning strategies for a two-player game. In [39] it is shown how the syntax of intuitionistic combinatorial proofs (or ICPs), a graphical proof system for propositional intuitionistic logic, provides some intuitive insights about the innocent winning strategies (or WISs) in a Hyland-Ong arena [26, 34]. In order to define WIS for constructive modal logics we extend this correspondence. For this, we first provide the definition ICPs for these logics as shown in Figure 1.

Intuitionistic combinatorial proofs.

The syntax of *combinatorial proofs* has been introduced to address the problem of

proof equivalence for classical logic [23, 24]. In the last years this syntax has been extended to modal logics [5], multiplicative linear logic with exponentials [2], relevant logics [4, 8], first order logic [25], and intuitionistic propositional logic [39]. Combinatorial proofs allow to represent “syntax-free” proofs, that is, to represent proofs independently from a specific proof system [3, 38]. As consequence, we are able to identify proofs up to some rules permutations, which is the reason why we also refer to combinatorial proof as a semantics for proofs.

In the syntax of ICPs, formulas are represented by arenas, which are specific directed acyclic graphs,

$$\llbracket ((b \supset b) \supset a) \supset (a \wedge a) \rrbracket = b_1 \rightarrow b_0 \rightarrow a_1 \rightarrow a_2 \rightarrow a_0 \quad (1)$$

and proofs of a formula F are represented as specific graph homomorphisms, called *skew fibrations*, from an arena net (i.e. an arena with an equivalence relation \sim over vertices satisfying some topological conditions) to the arena of F . In the example below, we represent the \sim -partitions by dashed edges, the skew fibration by dotted arrows, and we write the conclusion F as formula on the left and as arena on the right.

$$\quad (2)$$

But both represent the same ICP.

In order to represent proofs of modal formulas, we define modal arenas (or MAs), i.e. we characterise labeled dags with two type of edges which can be uniquely associated to formulas

$$\llbracket (\Box(b \supset b) \supset \Diamond a) \supset \Diamond(a \wedge a) \rrbracket = \begin{array}{c} \Box \rightarrow \Diamond \rightarrow \Diamond \\ \Downarrow \quad \Downarrow \quad \Downarrow \\ b \rightarrow b \rightarrow a \rightarrow a \end{array} \quad (3)$$

We then identify the topological conditions which allows us to represent proofs as skew fibrations from a modal arena net to the MA representing the formula to prove.

$$\Box((b \supset b) \supset \Diamond a) \supset \Diamond(a \wedge a)$$

In particular, each \sim -class (which we represent by linking its vertices by means of dashed edges) in the partition represent either an axiom pairing two atom-labeled vertices, or a set of modalities introduced by a single application of an axiom k .

Game semantics for constructive modal logic. In intuitionistic propositional logic, we consider two-players games played on the arena of a formula F (we denote

the players by \circ and \bullet , but in the literature they are denoted by O and P , standing for *opponent* and *proponent*).

Each play consists of an alternation of \circ -moves and \bullet -moves, that are vertices of the arena of F . The first move in a play is a \circ -move selected among the \rightarrow -roots of the arena of F . Each subsequent move of a player must be *justified* by a previous move of the other player, that is, the selected vertex must \rightarrow -point a vertex previously played by the other player. The game terminates when one player has no possible moves, losing the play.

A winning innocent strategy (for \bullet) is a set of plays which takes into account every possible \circ -move, while each \bullet -move is uniquely determined (and justified) by one of the previous \circ -moves.

As shown in [39], the winning strategy over the arena in Equation (1) with maximal views

$$a_0^\circ a_1^\bullet b_0^\circ b_1^\bullet \quad \text{and} \quad a_2^\circ a_1^\bullet b_0^\circ b_1^\bullet$$

can be seen as the image of specific paths in the arena net by the skew fibration in the ICP in Equation (2). Such paths are the ones in which the \circ -move is followed by the unique \bullet -move in the same \sim -class. In this paper we show that a similar correspondence can be established for constructive modal logics, provided some additional conditions on winning strategies for modal arenas (see Figure 1).

In fact, the presence of modalities requires a new notion of *frames* in a play: whenever \circ plays a move in the scope of a new modality, that is, a modality whose scope contains no previous moves of the play, the next \bullet -move must be in the scope of the same number of modalities. This allows us to establish a relation between the modalities in the modal arena and to group them in frames accordingly. Intuitively, frames allow to certify the correct application of the modal axioms.

Outcomes of the paper. In this paper we provide the definition of ICPs and WISs for the constructive modal logics CK and CD. For this purpose, we show a decomposition theorem allowing to transform proofs of a formula into factorised proofs, that are proofs consisting of a linear part and a weakening-contraction part. We show soundness and completeness of these semantics and we prove the following full completeness result:

$$\{\text{factorised proof of } F\} \rightarrow \{\text{ICPs of } F\} \rightarrow \{\text{WISs on } \llbracket F \rrbracket\}$$

To our knowledge no game semantics for modal logic are discussed in the literature. Our game semantics approach paves the way to concrete full-complete denotational models for modal logics.

Organisation of the paper. In Section 2 we show a decomposition theorem by providing a polarized sequent calculus [29, 30] which also include some deep inference rules [18, 10, 16]; in Section 3 we establish a correspondence between certain labeled directed graphs (modal arenas) and modal formulas; these graphs, enriched with a partition of their vertices, are used in Section 4 to encode linear proofs; moreover, in Section 5 we show how to represent structural derivations by means of skew fibrations between modal arenas; in Section 6 we provide a definition of ICPs for CK and CD, and in Section 7 we use them to define winning innocent strategies for these logics.

$$\begin{array}{c}
\frac{}{a \vdash a} \text{AX} \quad \frac{\Gamma \vdash A \quad \Delta, A \vdash B}{\Gamma, \Delta \vdash B} \text{cut} \quad \frac{\Gamma, A, A \vdash B}{\Gamma, A \vdash B} \text{C} \quad \frac{\Gamma \vdash B}{\Gamma, A \vdash B} \text{W} \\
\frac{\Gamma, A \vdash B}{\Gamma \vdash A \supset B} \supset^R \quad \frac{\Gamma \vdash A \quad \Delta, B \vdash C}{\Gamma, \Delta, A \supset B \vdash C} \supset^L \quad \frac{\Gamma \vdash A \quad \Delta \vdash B}{\Gamma, \Delta \vdash A \wedge B} \wedge^R \quad \frac{\Gamma, A, B \vdash C}{\Gamma, A \wedge B \vdash C} \wedge^L \\
\frac{\Gamma \vdash A}{\Box \Gamma \vdash \Box A} \text{K}^\Box \quad \frac{A, \Gamma \vdash B}{\Diamond A, \Box \Gamma \vdash \Diamond B} \text{K}^\Diamond \quad \frac{\Gamma \vdash A}{\Diamond \perp, \Box \Gamma \vdash \Diamond A} \text{K}^\perp \quad \frac{\Gamma \vdash A}{\Box \Gamma \vdash \Diamond A} \text{D} \\
\text{IMLL} = \{\text{AX}, \supset^R, \supset^L, \wedge^L, \wedge^R\} \quad \text{LI} = \text{IMLL} \cup \{\text{C}, \text{W}\} \\
\text{IMLL-CK} = \text{IMLL} \cup \{\text{K}^\Box, \text{K}^\Diamond, \text{K}^\perp\} \quad \text{LCK} = \text{LI} \cup \{\text{K}^\Box, \text{K}^\Diamond\} \\
\text{IMLL-CD} = \text{IMLL} \cup \{\text{K}^\Box, \text{K}^\Diamond, \text{D}\} \quad \text{LCD} = \text{LI} \cup \{\text{K}^\Box, \text{K}^\Diamond, \text{D}\}
\end{array}$$

Figure 2: Sequent rules and sequent systems for constructive modal logics considered in this paper

$$\begin{array}{c}
\frac{}{a^\bullet, a^\circ} \text{ax} \quad \frac{\Gamma^\bullet, A^\circ}{\Gamma^\bullet, B^\bullet, A^\circ} \text{w}^\bullet \quad \frac{\Gamma^\bullet, A^\bullet, A^\bullet, B^\circ}{\Gamma^\bullet, A^\bullet B^\circ} \text{c}^\bullet \\
\frac{\Gamma^\bullet, A^\bullet, B^\circ}{\Gamma^\bullet, (A \multimap B)^\circ} \multimap^\circ \quad \frac{\Gamma^\bullet, A^\circ \quad \Delta^\bullet, B^\bullet, C^\circ}{\Gamma^\bullet, \Delta^\bullet, (A \multimap B)^\bullet, C^\circ} \multimap^\bullet \quad \frac{\Gamma^\bullet, A^\circ \quad \Delta^\bullet, B^\circ}{\Gamma^\bullet, \Delta^\bullet, (A \otimes B)^\circ} \otimes^\circ \quad \frac{\Gamma^\bullet, A^\bullet, B^\bullet, C^\circ}{\Gamma^\bullet, (A \otimes B)^\bullet, C^\circ} \otimes^\bullet \\
\frac{\Gamma^\bullet, A^\circ}{\Box \Gamma^\bullet, \Box A^\circ} \text{k}^\Box \quad \frac{A^\bullet, \Gamma^\bullet, B^\circ}{\Diamond A^\bullet, \Box \Gamma^\bullet, \Diamond B^\circ} \text{k}^\Diamond \quad \frac{\Gamma^\bullet, B^\circ}{\Diamond \perp^\bullet, \Box \Gamma^\bullet, \Diamond B^\circ} \text{k}^\perp \quad \frac{\Gamma^\bullet, A^\circ}{\Box \Gamma^\bullet, \Diamond A^\circ} \text{d} \\
\text{IMLL}^\circ = \{\text{ax}, \multimap^\circ, \multimap^\bullet, \otimes^\circ, \otimes^\bullet\} \quad \text{LI}^\circ = \text{IMLL}^\circ \cup \{\text{c}^\bullet, \text{w}^\bullet\} \\
\text{IMLL-CK}^\circ = \text{IMLL}^\circ \cup \{\text{k}^\Box, \text{k}^\Diamond, \text{k}^\perp\} \quad \text{LCK}^\circ = \text{LI}^\circ \cup \{\text{k}^\Box, \text{k}^\Diamond\} \\
\text{IMLL-CD}^\circ = \text{IMLL}^\circ \cup \{\text{k}^\Box, \text{k}^\Diamond, \text{d}\} \quad \text{LCD}^\circ = \text{LI}^\circ \cup \{\text{k}^\Box, \text{k}^\Diamond, \text{d}\}
\end{array}$$

Figure 3: Polarised sequent rules and polarised sequent systems for the constructive modal logics considered in this paper

$$\text{LI}_\downarrow^\circ = \left\{ \frac{\Gamma\{\Diamond \perp^\bullet\}}{\Gamma\{\Diamond A^\bullet\}} \text{w}_\downarrow^\Diamond, \frac{\Gamma\{A^\bullet\}}{\Gamma\{A \otimes B^\bullet\}} \text{w}_\downarrow^\otimes, \frac{\Gamma\{A^\circ\}}{\Gamma\{B \multimap A^\circ\}} \text{w}_\downarrow^\multimap, \frac{\Gamma\{(A \otimes A)^\bullet\}}{\Gamma\{A^\bullet\}} \text{c}_\downarrow^\bullet \right\}$$

Figure 4: Deep inference rules for weakening and contraction

2 Preliminaries on Constructive modal logics

In this paper we consider the *modal formulas* generated by a countable set of (atomic) propositional variables $\mathcal{A} = \{a, b, \dots\}$ via the following grammar

$$A, B ::= a \mid A \supset B \mid A \wedge B \mid \Box A \mid \Diamond A \mid \Diamond \perp$$

and we say that a formula is *modality-free* if it contains no occurrences of \Box and \Diamond .

We consider the variant of intuitionistic modal logic CK called *constructive modal logic* [6, 9, 32, 41, 28] defined by adding to the intuitionistic propositional logic the

necessitation rule

If F is provable, then $\Box F$ is provable

and the two following axiom schemes k_1 and k_2 .

$$k_1 : \Box(A \supset B) \supset (\Box A \supset \Box B) \quad k_2 : \Box(A \supset B) \supset (\Diamond A \supset \Diamond B)$$

A further extension of this logic, denoted CD, can be obtained by adding the following axiom scheme

$$d : \Box A \supset \Diamond A$$

In this paper we consider the fragment of CK and CD containing only implication and conjunction given by the rules and systems in Figure 2, since these suffice to express λ -calculi with pairs for these logics.

We remark that the presence of $\Diamond \perp$ is not standard for the unit-free fragment. In fact, no rule can introduce this formula in LCK and LCD. However, it plays a special role in some results in this paper since its purpose is to represent a “placeholder” for a \Diamond -formula which may be introduced by a weakening rule but whose occurrence is not a negligible information in the proof.

Theorem 1. *The sequent system LX is a sound and complete proof system for the disjunction-free fragment of the logic X for all $X \in \{\text{CK}, \text{CD}\}$. Moreover, LX satisfies cut-elimination property.*

Proof. In [28] there are provided sound and complete systems for these logics. These systems are proven to be analytic, i.e. satisfying cut-elimination property. Thus we can extract the desired disjunction-free calculi. \square

In order to define combinatorial proofs for a given logic, we need to have a *decomposition theorem* which lets us factorize proofs in a linear part, capturing the logic interactions between the components of the proof, and a resource management part, capturing resources duplication or erasing.

To achieve this decomposition result for the logics considered in this paper, we use the sound and complete cut-free sequent systems provided in [30] to define new rule systems in which we make use of deep inference rules [17, 18, 10, 16], that is, rules which can be applied deep inside a formula in any context. The use of deep inference rules allows us to push down in a derivation all the occurrences of weakening and contractions. In particular, as done in [5] for classical modal logic, we consider K and D as part of the logic interaction of a proof.

Polarized formulas

However, a difficulty arises in applying such permutations in the intuitionistic setting since weakening and contraction rules may be performed only on the left-hand-side formulas in a sequent. In order to assure the correctness of deep applications of weakening and contraction rules, we introduce a syntax using *polarized formulas* (or *P-formulas*) to represent a two-sided single-conclusion calculus by a polarized one-sided sequent calculus, as done in [30]. This allows us to keep track of which subformulas in a sequent Γ occurred on the left-hand-side of a sequent occurring in a derivation of Γ .

$$\begin{array}{ccc}
\frac{\Gamma^\bullet, B^\circ}{\Gamma^\bullet, A^\bullet, B^\circ} w^\bullet \quad \rightsquigarrow \quad \frac{\Gamma^\bullet, B^\circ}{\Box \Gamma^\bullet, \Box B^\circ} k^\Box & \frac{\Gamma^\bullet, B^\circ}{\Gamma^\bullet, A^\bullet, B^\circ} w^\bullet \quad \rightsquigarrow \quad \frac{\Gamma^\bullet, B^\circ}{\Box \Gamma^\bullet, \Diamond \perp^\bullet, \Diamond B^\circ} k^\perp & \\
\frac{\Gamma^\bullet, B^\circ}{\Box \Gamma^\bullet, \Box A^\bullet, \Diamond B^\circ} k^\Box & \frac{\Gamma^\bullet, B^\circ}{\Box \Gamma^\bullet, \Box A^\bullet, \Diamond B^\circ} w^\bullet & \frac{\Gamma^\bullet, B^\circ}{\Box \Gamma^\bullet, \Diamond A^\bullet, \Diamond B^\circ} k^\Diamond & \frac{\Gamma^\bullet, B^\circ}{\Box \Gamma^\bullet, \Diamond A^\bullet, \Diamond B^\circ} w^\bullet \\
\frac{\Gamma^\bullet, B^\circ}{\Gamma^\bullet, A^\bullet, B^\circ} w^\bullet \quad \rightsquigarrow \quad \frac{\Gamma^\bullet, B^\circ}{\Box \Gamma^\bullet, \Diamond B^\circ} d & \frac{\Gamma^\bullet, A^\bullet, C^\circ}{\Gamma^\bullet, A^\bullet, B^\bullet, C^\circ} w^\bullet \quad \rightsquigarrow \quad \frac{\Gamma^\bullet, A^\bullet, C^\circ}{\Gamma^\bullet, (A \otimes B)^\bullet, C^\circ} w^\otimes & \\
\frac{\Gamma^\bullet, B^\circ}{\Box \Gamma^\bullet, \Box A^\bullet, \Diamond B^\circ} d & \frac{\Gamma^\bullet, B^\circ}{\Box \Gamma^\bullet, \Box A^\bullet, \Diamond B^\circ} w^\bullet & \frac{\Gamma^\bullet, A^\bullet, C^\circ}{\Gamma^\bullet, A^\bullet, B^\bullet, C^\circ} w^\bullet & \frac{\Gamma^\bullet, A^\bullet, C^\circ}{\Gamma^\bullet, (A \otimes B)^\bullet, C^\circ} w^\otimes \\
\frac{\Gamma^\bullet, A^\circ}{\Gamma^\bullet, B^\bullet, A^\circ} w^\bullet \quad \rightsquigarrow \quad \frac{\Gamma^\bullet, A^\circ}{\Gamma^\bullet, B \multimap A^\circ} w^\circ & \frac{\Gamma^\bullet, A^\circ}{\Gamma^\bullet, B \multimap A^\circ} w^\circ & \frac{\Delta^\bullet, C^\circ}{\Gamma, A \multimap B, \Delta \vdash C} w^\bullet \quad \rightsquigarrow \quad \frac{\Delta^\bullet, C^\circ}{\Gamma, A \multimap B^\bullet, \Delta^\bullet, C^\circ} w^\bullet & \\
\frac{\Gamma^\bullet, A^\circ}{\Gamma^\bullet, B \multimap A^\circ} w^\bullet & \frac{\Gamma^\bullet, A^\circ}{\Gamma^\bullet, B \multimap A^\circ} w^\circ & \frac{\Delta^\bullet, C^\circ}{\Gamma, A \multimap B, \Delta \vdash C} w^\bullet & \frac{\Delta^\bullet, C^\circ}{\Gamma, A \multimap B^\bullet, \Delta^\bullet, C^\circ} w^\bullet
\end{array}$$

Figure 5: Rule permutations for w^\bullet

We define the set of \mathbf{P} -formulas as the set generated by $\mathcal{A} = \{a, b, \dots\}$ using the following grammar

$$\begin{array}{l}
A^\circ, B^\circ ::= a^\circ \mid A^\circ \otimes B^\circ \mid A^\bullet \multimap B^\circ \mid \Box A^\circ \mid \Diamond A^\circ \\
A^\bullet, B^\bullet ::= a^\bullet \mid A^\bullet \otimes B^\bullet \mid A^\circ \multimap B^\bullet \mid \Box A^\bullet \mid \Diamond A^\bullet \mid \Diamond \perp^\bullet
\end{array}$$

A *context* is a sequent $\Gamma\{\}$ in which one atom occurrence is been replaced by the hole $\{\}$.

In order to improve readability, we omit to write polarities on subformulas since they can be deduced as follows:

- if $(A \multimap B)^\circ$, then A^\bullet and B° ;
- if $(A \multimap B)^\bullet$, then A° and B^\bullet ;
- if $(A \otimes B)^\circ$, then A° and B° ;
- if $(A \otimes B)^\bullet$, then A^\bullet and B^\bullet ;
- if $\Box A^\circ$ or $\Diamond A^\circ$, then A° ;
- if $\Box A^\bullet$ or $\Diamond A^\bullet$, then A^\bullet ;

For \mathbf{P} -formulas, we define the sequent rules as systems in Figure 3, and deep rules in Figure 4. In particular, the rules in Figure 3 can be obtained by the ones in Figure 2 by encoding any two sided sequent $\Gamma, B \vdash A$ as the one-side sequent $\Gamma^\bullet, B^\bullet, A^\circ$.

Polarized formulas allow us to restrain the application of the deep rules only to specific subformulas. In particular, we can apply c^\bullet , w° , w^\bullet (w°) to the formulas which occurs as a \bullet -formula (respectively \circ -formula) in a sequent occurring in the derivation.

If H is a \mathbf{P} -formula, we denote by $[H]$ the formula obtained by removing all polarities occurring in H and replacing the \otimes and \multimap symbols respectively with \wedge and \supset . This translation induces a correspondence between the systems in Figure 2 and in Figure 3. However, the interest in introducing the polarized systems depends on the following result.

Notation 2. If S is a set of rules, we write $F' \stackrel{S}{\vdash} F$ if there is a derivation from F' to F using rules in S . Moreover, we write $\vdash^S F$ if there is a proof of F in S , i.e. a derivation using rules in S from the empty premise.

Theorem 3. Let $X \in \{\text{CK}, \text{CD}\}$ and H be a P-formula, then

- $\vdash^{\text{LX}} \lfloor H \rfloor \text{ iff } \vdash^{\text{LX}^\circ} H;$
- $\vdash^{\text{IMLL-X}} \lfloor H \rfloor \text{ iff } \vdash^{\text{IMLL-X}^\circ} H.$

Theorem 4 (Decomposition). Let $X \in \{\text{K}, \text{D}\}$ and H be a P-formula. Then $\vdash^{\text{LX}^\circ} H$ iff $\vdash^{\text{IMLL-X}^\circ} H' \vdash^{\text{LI}_\downarrow^\circ} H$.

Proof. Let us consider an LX° -derivation of H . We replace every occurrence of a \mathbf{c}° by a \otimes^\bullet followed by a $\mathbf{c}_\downarrow^\bullet$. We then permute every occurrence of \mathbf{w}^\bullet and rules in $\text{LI}_\downarrow^\circ$ by applying independent rule permutations plus the permutations in Figure 5 replacing a \mathbf{w}^\bullet into a $\mathbf{w}_\downarrow^\otimes, \mathbf{w}_\downarrow^\circ$ or $\mathbf{w}_\downarrow^\diamond$. Observe since H is a P-formula, then no \mathbf{w}^\bullet -rule occurs in the derivation at the end of this procedure. We conclude by permuting all deep-weakening and deep-contraction rules down in the derivation.

During this process, depending on the presence of \mathbf{k}^\perp or \mathbf{d} in CX , an occurrence of a \mathbf{k}^\diamond may be replaced in two different ways: either by \mathbf{k}^\perp followed by a $\mathbf{w}_\downarrow^\diamond$ or by a \mathbf{d} followed by a \mathbf{w}^\bullet as shown below:

$$\frac{\frac{\frac{\parallel}{B^\bullet, C^\circ}}{A^\bullet, B^\bullet, C^\circ} \mathbf{w}^\bullet}{\diamond A^\bullet, \square B^\bullet, \diamond C^\circ} \mathbf{k}^\diamond \rightsquigarrow \frac{\frac{\frac{\parallel}{B^\bullet, C^\circ}}{\diamond \perp^\bullet, \square B^\bullet, \diamond C^\circ} \mathbf{k}^\perp}{\diamond A^\bullet, \square B^\bullet, \diamond C^\circ} \mathbf{w}_\downarrow^\diamond \quad \text{or} \quad \frac{\frac{\frac{\parallel}{B^\bullet, C^\circ}}{\square B^\bullet, \diamond C^\circ} \mathbf{d}}{\diamond A^\bullet, \square B^\bullet, \diamond C^\circ} \mathbf{w}^\bullet$$

To prove the converse it suffice to revert the previous procedure. \square

If F is a formula, we call a *factorised proof* of F a derivation in $\text{IMLL-X}^\circ \cup \text{LI}_\downarrow^\circ$ of the form $\vdash^{\text{IMLL-X}^\circ} H' \vdash^{\text{LI}_\downarrow^\circ} H$, for H and H' P-formulas such that $F = \lfloor H \rfloor$.

3 Modal arenas

In this section we establish a correspondence between modal formulas and a family of labeled directed graphs we call *modal arenas*. These are employed in this paper in the definition of intuitionistic combinatorial proofs and games.

A *directed graph* $\mathcal{G} = \langle V_{\mathcal{G}}, \xrightarrow{\mathcal{G}} \rangle$ is given by a set of vertices $V_{\mathcal{G}}$ and a set of direct edges $\xrightarrow{\mathcal{G}} \subseteq V_{\mathcal{G}} \times V_{\mathcal{G}}$. If $V' \subset V_{\mathcal{G}}$, we say that $\langle V', \rightarrow \cap (V' \times V') \rangle$ is the *subgraph of \mathcal{G} induced by V'* . We write $u \xrightarrow{\mathcal{G}} v, u \not\xrightarrow{\mathcal{G}} v, u \xleftarrow{\mathcal{G}} v$ and $u \leftrightarrow v$ if respectively $uv \in \xrightarrow{\mathcal{G}}, uv \notin \xrightarrow{\mathcal{G}}, vu \in \xrightarrow{\mathcal{G}}$ and $uv \in \xrightarrow{\mathcal{G}} \cup \xleftarrow{\mathcal{G}}$. A vertex v is a $\xrightarrow{\mathcal{G}}$ -*root*, denoted $v \dashv$ if there is no vertex w such that $v \xrightarrow{\mathcal{G}} w$. We call $\vec{R}_{\mathcal{G}} = \{v \mid v \dashv\}$ the set of $\xrightarrow{\mathcal{G}}$ -roots of \mathcal{G} .

A *path* from v to w of length n is a sequence of vertices $x_0 \dots x_n$ such that $v = x_0$, $w = x_n$ and $x_i \xrightarrow{\mathcal{G}} x_{i+1}$ for $i \in \{0, \dots, n-1\}$. We write $v \xrightarrow{\mathcal{G}}^* w$ ($v \xrightarrow{\mathcal{G}}^n w$) if there is a path (respectively a path of length n) from v to w . A *directed acyclic graph* (or **dag** for short) is a direct graph such that $v \xrightarrow{\mathcal{G}}^n v$ implies $n = 0$ for all $v \in V$.

A *two-color directed acyclic graph* (or **2-dag** for short) $\mathcal{G} = \langle V_{\mathcal{G}}, \xrightarrow{\mathcal{G}}, \rightsquigarrow^{\mathcal{G}} \rangle$ is given by a set of vertices $V_{\mathcal{G}}$ and two disjoint sets of edges $\xrightarrow{\mathcal{G}}$ and $\rightsquigarrow^{\mathcal{G}}$ such that the graph $\langle V_{\mathcal{G}}, \xrightarrow{\mathcal{G}} \cup \rightsquigarrow^{\mathcal{G}} \rangle$ is acyclic. We denote $\overleftarrow{\mathcal{G}} = \xrightarrow{\mathcal{G}} \cup \overleftarrow{\mathcal{G}}$ and $\overleftarrow{\rightsquigarrow^{\mathcal{G}}} = \rightsquigarrow^{\mathcal{G}} \cup \overleftarrow{\rightsquigarrow^{\mathcal{G}}}$. We omit the superscript when clear from context.

If \mathcal{L} is a set, a 2-dag is \mathcal{L} -*labeled* if a label $\ell(v) \in \mathcal{L}$ is associated to each vertex $v \in V$. In this paper we fix the set of labels to be the set $\mathcal{L} = \mathcal{A} \cup \{\square, \diamond\}$, where \mathcal{A} is the set of propositional variables occurring in formulas.

Definition 5. Let \mathcal{G} and \mathcal{H} be 2-dags, we denote by $R_{\mathcal{H}}^{\mathcal{G}}$ the set of edges from the \rightarrow -roots of \mathcal{G} to the \rightarrow -roots of \mathcal{H} , that is $R_{\mathcal{H}}^{\mathcal{G}} = \{(u, v) \mid u \in \overrightarrow{R_{\mathcal{G}}}, v \in \overrightarrow{R_{\mathcal{H}}}\}$.

We define the following operations on 2-dags:

$$\begin{aligned} \mathcal{G} + \mathcal{H} &= \langle V_{\mathcal{G}} \cup V_{\mathcal{H}}, \xrightarrow{\mathcal{G}} \cup \xrightarrow{\mathcal{H}}, \rightsquigarrow^{\mathcal{G}} \cup \rightsquigarrow^{\mathcal{H}} \rangle \\ \mathcal{G} \rightarrow \mathcal{H} &= \langle V_{\mathcal{G}} \cup V_{\mathcal{H}}, \xrightarrow{\mathcal{G}} \cup \xrightarrow{\mathcal{H}} \cup R_{\mathcal{H}}^{\mathcal{G}}, \rightsquigarrow^{\mathcal{G}} \cup \rightsquigarrow^{\mathcal{H}} \rangle \\ \mathcal{G} \rightsquigarrow \mathcal{H} &= \langle V_{\mathcal{G}} \cup V_{\mathcal{H}}, \xrightarrow{\mathcal{G}} \cup \xrightarrow{\mathcal{H}}, \rightsquigarrow^{\mathcal{G}} \cup \rightsquigarrow^{\mathcal{H}} \cup R_{\mathcal{H}}^{\mathcal{G}} \rangle \end{aligned}$$

which can be pictured as follows, with \blacktriangleright representing the \rightarrow -roots of each graph.

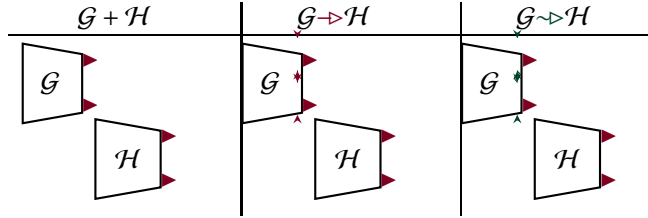

We use the notation a , \square and \diamond for the graph consisting of a single vertex labeled respectively by a , \square and \diamond . If F is a formula, we define a \mathcal{L} -labeled 2-dag $\llbracket F \rrbracket$ inductively as follows:

$$\begin{aligned} \llbracket a \rrbracket &= a & \llbracket \diamond \perp \rrbracket &= \diamond \\ \llbracket A \supset B \rrbracket &= \llbracket A \rrbracket \rightarrow \llbracket B \rrbracket & \llbracket \square A \rrbracket &= \square \rightsquigarrow \llbracket A \rrbracket \\ \llbracket A \wedge B \rrbracket &= \llbracket A \rrbracket + \llbracket B \rrbracket & \llbracket \diamond A \rrbracket &= \diamond \rightsquigarrow \llbracket A \rrbracket \end{aligned} \quad (4)$$

Using the same notation, if H is a P-formula and F the formula such that $F = \llbracket H \rrbracket$, we denote by $\llbracket H \rrbracket$ the 2-dag $\llbracket F \rrbracket$.

In order to characterize those 2-dags that are encoding of formulas, we require some additional definitions.

Definition 6. A \mathcal{L} -labeled dag $\mathcal{G} = \langle V_{\mathcal{G}}, \xrightarrow{\mathcal{G}} \rangle$ is a *arena* if $V_{\mathcal{G}} \neq \emptyset$ and if it is

- L-free: if $a \rightarrow u$ and $a \rightarrow w \rightarrow v$ then $u \rightarrow v$;

- Σ -free: if $a \rightarrow v$, $a \rightarrow w$, $b \rightarrow w$ and $b \rightarrow u$ then $a \rightarrow u$ or $b \rightarrow v$;

That is, the following induced subgraphs are forbidden.

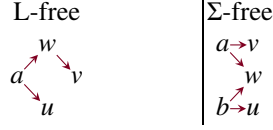

We recall some results from [39] on arenas and modality-free formulas.

Lemma 7 ([39]). *In an arena, if $v \rightarrow^n y$ and $w \rightarrow^m y$, then $\{v \rightarrow^n\} \subseteq \{w \rightarrow^m\}$ or $\{w \rightarrow^m\} \subseteq \{v \rightarrow^n\}$ where $\{u \rightarrow^k\} = \{x \mid u \rightarrow^k x\}$.*

Theorem 8 ([39]). *A graph \mathcal{G} is an arena iff there is a modality-free formula F such that $\mathcal{G} = \llbracket F \rrbracket$.*

Definition 9. A modal arena (or MA) $\mathcal{G} = \langle V_{\mathcal{G}}, \rightarrow, \rightsquigarrow \rangle$ is an \mathcal{L} -labeled 2-dag such that

- $\langle V, \rightarrow \rangle$ is an arena;
- \rightsquigarrow is modal, that is:
 - if $v \rightsquigarrow w$ and $w \rightsquigarrow u$, then $v \rightsquigarrow u$ (transitivity);
 - if $v \rightsquigarrow w$ and $u \rightsquigarrow w$, then $u \leftrightarrow v$;
 - if $v \rightsquigarrow w$ and $v \rightsquigarrow u$, then $u \not\rightarrow w$;
 - if $v \rightsquigarrow w$ and $u \rightarrow v$, then $u \rightarrow w$;
 - if $v \rightsquigarrow w$ and $v \rightarrow u$, then $w \rightarrow u$;
 - if $v \rightsquigarrow w$ and $w \rightarrow u$, then $v \rightarrow u$;
- \mathcal{G} is properly labeled:
 - if $v \rightsquigarrow w$, then $\ell(v) \in \{\Box, \Diamond\}$;
 - if $\ell(v) = \Box$, then there is a w such that $v \rightsquigarrow w$.

We denote by $V_{\mathcal{G}}^{\mathcal{A}}$, $V_{\mathcal{G}}^{\Box}$ and $V_{\mathcal{G}}^{\Diamond}$ the subsets of vertices of \mathcal{G} with labels respectively in \mathcal{A} , $\{\Box\}$ and $\{\Diamond\}$. We call *atomic* the vertices in $V_{\mathcal{G}}^{\mathcal{A}}$ and *modal* the ones in $V_{\mathcal{G}}^{\Box\Diamond} = V_{\mathcal{G}}^{\Box} \cup V_{\mathcal{G}}^{\Diamond}$.

From Lemma 7 we can prove the following:

Lemma 10. *Let \mathcal{G} be a MA and $u, v, w \in V_{\mathcal{G}}$. If $v \rightsquigarrow w$ then:*

- v is a \rightarrow -root iff w is a \rightarrow -root;
- $v \rightarrow^n u$ iff $w \rightarrow^n u$;
- if $u \rightarrow^n v$ then $u \rightarrow^n w$.

Proof. The first statement follows the fact that in a MA if $v \rightsquigarrow w$, then $v \rightarrow u$ iff $w \rightarrow u$. The second statement is proven using the same argument, proceeding by induction on n making use of Lemma 7. The third statement is also proven using Lemma 7 and the fact that in a MA if $v \rightsquigarrow w$ and $u \rightarrow v$, then $u \rightarrow w$. \square

Lemma 11. *If F is a formula, then the \mathcal{L} -labeled 2-dag $\llbracket F \rrbracket$ is an MA.*

Proof. The right-to-left implication is proven by induction over the number of connectives and modalities of a formula. It suffices to remark that the graph operations $+$ and \rightarrow cannot introduce forbidden MA configurations. Similarly, the operation \rightsquigarrow introduces no forbidden configurations whenever $\mathcal{G} = \mathcal{G}_1 \rightsquigarrow \mathcal{G}_2$ with \mathcal{G}_1 a single vertex graph of the form \square or \diamond . \square

For proving the converse, we need the following concept. If $v \in V^{\square\diamond}$ is a vertex in a MA, then we define the \rightsquigarrow -cone of v as the set of vertices

$$\tilde{\mathcal{C}}(v) = \{w \mid \text{there is } u \text{ such that } v \rightsquigarrow u, w \rightarrow^* u \text{ and } w \not\rightarrow^* v\}$$

Intuitively, the cone of a modal vertex delimits the subformula in the scope of the corresponding modality.

Example 12. Consider the formula $F = (a \supset \square(b \wedge (c \supset \diamond d))) \supset \diamond(e \supset f)$ and its MA

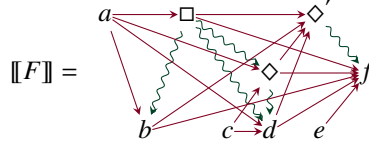

The \square modality has subformula $b \wedge (c \supset \diamond d)$, the first \diamond has subformula d and the second \diamond (denoted \diamond' on the graph) has subformula $e \supset f$. The corresponding \rightsquigarrow -cones are $\tilde{\mathcal{C}}(\square) = \{b, c, \diamond, d\}$, $\tilde{\mathcal{C}}(\diamond) = \{d\}$ and $\tilde{\mathcal{C}}(\diamond') = \{e, f\}$.

If v is a vertex of a MA \mathcal{G} , we call the *principal modal vertex of v* the unique¹ vertex \hat{v} such that $v \in \tilde{\mathcal{C}}(\hat{v})$ and for all $m \neq \hat{v}$ such that $v \in \tilde{\mathcal{C}}(m)$, then $\hat{v} \in \tilde{\mathcal{C}}(m)$. We write $v = \hat{v}$ if there is no m such that $m \rightsquigarrow v$. To have an intuition consider a formula F , the MA $\mathcal{G} = \llbracket F \rrbracket$ and the formula tree \mathcal{T}_F . If $\hat{v} \neq v$, then the vertex \hat{v} corresponds to the root of the smaller subtree of F with root labeled by a modality which contains the node corresponding to v . If $\hat{v} = v$, then such a node does not exist. By means of example, in Example 12 we have $\hat{a} = a$, $\hat{\diamond} = \hat{b} = \hat{c} = \square$, $\hat{d} = \diamond$ and $\hat{e} = \hat{f} = \diamond'$, $\hat{\square} = \square$ and $\hat{\diamond'} = \diamond'$.

Theorem 13. *Let \mathcal{G} be a \mathcal{L} -labeled 2-dag. If \mathcal{G} is a MA, then there is a formula F such that $\mathcal{G} = \llbracket F \rrbracket$.*

Proof. We proceed by induction on the size of \mathcal{G} . If $|V_{\mathcal{G}}| = 1$ then if $\ell(v) \in \mathcal{A}$, then $F = a \in \mathcal{A}$, if $\ell(v) = \diamond$ then $F = \diamond \perp$. Otherwise, since $\langle V_{\mathcal{G}}, \xrightarrow{\mathcal{G}} \rangle$ is an arena, we conclude by Lemma 7 (see [39]) that

¹Its uniqueness follows by definition of MA.

1. either every vertex in $V_{\mathcal{G}} \setminus \vec{R}_{\mathcal{G}}$ has a \rightarrow -paths to all roots in $\vec{R}_{\mathcal{G}}$,
2. or $\vec{R}_{\mathcal{G}}$ admits a partition $\vec{R}_{\mathcal{G}} = R_1 \uplus R_2$ such that any vertex in \mathcal{G} has \rightarrow -paths only to roots in one of the two sets.

If 1 holds, then we define \mathcal{G}_2 as the MA obtained from \mathcal{G} taking the vertices in

$$V_2 = \vec{R}_{\mathcal{G}} \cup \left(\bigcup_{v \in \vec{R}_{\mathcal{G}}} \overset{\rightsquigarrow}{\mathbb{C}}(v) \right)$$

and \mathcal{G}_1 as the MA over the remaining vertices $V_1 = V_{\mathcal{G}} \setminus V_2$. Since each vertex in \mathcal{G} has a path to all the roots in $\vec{R}_{\mathcal{G}}$, then there is a \rightarrow from any root of \mathcal{G}_1 to any root of \mathcal{G}_2 . Since by definition $\vec{R}_{\mathcal{G}_2} = \vec{R}_{\mathcal{G}}$, then we have that $\mathcal{G} = \mathcal{G}_1 \rightarrow \mathcal{G}_2$.

If 2 holds and $\vec{R}_{\mathcal{G}} = R_1 \uplus R_2$ with R_1 and R_2 non-empty sets. Since \rightsquigarrow is modal, we have the following possibilities:

- (a) if $R_1 = \{v\}$ and $v \rightsquigarrow w$ for all $w \in R_2$, then there is no u such that $u \rightarrow v$. Otherwise $u \rightarrow v$ and $u \rightarrow w$ for all w such that $v \rightsquigarrow w$, that is for all $w \in R_2$. This implies that $u \rightsquigarrow w$ for all $w \in \vec{R}_{\mathcal{G}}$, which contradicts the hypothesis 2. Thus we conclude that $\mathcal{G} = v \rightsquigarrow \mathcal{G}'$ where \mathcal{G}' is the MA with vertices $\overset{\rightsquigarrow}{\mathbb{C}}(v)$;
- (b) if there are no \rightsquigarrow -edges between R_1 and R_2 , then $\mathcal{G} = \mathcal{G}_1 + \mathcal{G}_2$ where \mathcal{G}_1 and \mathcal{G}_2 are the the MAs with vertices $V_1 = \{v \mid v \rightarrow^* w \text{ for a } w \in R_1\}$ and $V_2 = \{v \mid v \rightarrow^* w \text{ for a } w \in R_2\}$. In fact by definition there are no \rightarrow -edges between vertices in V_1 and V_2 otherwise by Lemma 7 we should have $R_1 = R_2$. Similarly there are no \rightsquigarrow -edges between vertices in V_1 and V_2 since there are no \rightsquigarrow -edges between R_1 and R_2 (by hypothesis) and if there is $v \in V_1 \setminus R_1$ and $w \in V_2$ such that $v \rightsquigarrow w$, then by Lemma 10 $w \notin R_2$ and we should have again $R_1 = R_2$;
- (c) otherwise, we pick a $v \in \vec{R}_{\mathcal{G}} \cap \overset{\rightsquigarrow}{\mathbb{C}}(v)$ and define $R_1 = \{v\} \cup \{w \mid v \rightsquigarrow w\}$ and $R_2 = \vec{R}_{\mathcal{G}} \setminus R_1$. If there is no $u \in \vec{R}_{\mathcal{G}}$ such that $v \rightsquigarrow u$, then $R_1 = \vec{R}_{\mathcal{G}}$ and we conclude by (a). If $R_2 \neq \emptyset$, then we define $V_1 = \{v \mid v \rightarrow^* w \text{ for a } w \in R_1\}$ and $V_2 = \{v \mid v \rightarrow^* w \text{ for a } w \in R_2\}$ and we conclude by (b).

□

As result of Lemma 11 and Theorem 13, we have the following correspondence between formulas and MAs:

Theorem 14. *A \mathcal{L} -labeled 2-dag \mathcal{G} is a MA iff there is a formula F such that $\mathcal{G} = \llbracket F \rrbracket$.*

We define the *formula isomorphism* as the equivalence relation over formulas $\overset{\dagger}{\sim}$ generated by the following relations:

$$\begin{aligned} A \wedge B \overset{\dagger}{\sim} B \wedge A & \quad A \wedge (B \wedge C) \overset{\dagger}{\sim} (A \wedge B) \wedge C \\ (A \wedge B) \supset C \overset{\dagger}{\sim} A \supset (B \supset C) & \end{aligned} \quad (5)$$

Proposition 15. If F and G are two formulas and $\stackrel{\dagger}{\sim}$ the equivalence relation defined in Equation (5) then

$$F \stackrel{\dagger}{\sim} G \iff \llbracket F \rrbracket = \llbracket G \rrbracket$$

Proof. By induction using the definition of the MAs operations $+$, \rightarrow and \rightsquigarrow . \square

4 Modal Arena Nets

In this section we show the correspondence between (linear) proofs in IMLL-CK and IMLL-CD, and respectively CK- and CD-arena nets, that are, modal arenas equipped with an equivalence relation over vertices satisfying specific topological conditions.

Definition 16. A *partitioned modal arena* $\mathcal{G} = \langle V_{\mathcal{G}}, \overset{\mathcal{G}}{\rightarrow}, \overset{\mathcal{G}}{\rightsquigarrow}, \overset{\mathcal{G}}{\sim} \rangle$ is given by a MA $\langle V_{\mathcal{G}}, \overset{\mathcal{G}}{\rightarrow}, \overset{\mathcal{G}}{\rightsquigarrow} \rangle$ together with an equivalence relation $\overset{\mathcal{G}}{\sim}$ over vertices such that:

- if $v \in V_{\mathcal{G}}^{\mathcal{A}}$ and $v \overset{\mathcal{G}}{\sim} w$, then $w \in V_{\mathcal{G}}^{\mathcal{A}}$ and $\ell(v) = \ell(w)$;
- if $v \in V_{\mathcal{G}}^{\mathcal{A}}$, then $v \overset{\mathcal{G}}{\sim} w$ for a unique $w \in V_{\mathcal{G}}^{\mathcal{A}}$.

In a partitioned modal arena we represent the equivalence relation \sim by drawing a (dashed non-oriented blue) edge $v \dashv w$ between two distinct vertices in the same \sim -class. For better readability, we only represent a minimal subset of these edges relying on the fact that \sim is an equivalence relation. By means of example, if $\{u, v, w\}$ is an \sim -class, we may represent $u \dashv v \dashv w$ omitting the edge between u and w .

We say that a formula (or P-formula) F is *associated* to \mathcal{G} if $\llbracket F \rrbracket = \langle V_{\mathcal{G}}, \overset{\mathcal{G}}{\rightarrow}, \overset{\mathcal{G}}{\rightsquigarrow} \rangle$.

Remark 17. If v and w are vertices in a partitioned modal arena \mathcal{G} such that $v \overset{\mathcal{G}}{\sim} w$, then $v \in V_{\mathcal{G}}^{\square\circ}$ iff $w \in V_{\mathcal{G}}^{\square\circ}$.

If \mathcal{G} is an arena, we define $d(v)$ as the length of the longest \rightarrow -paths from v to a root $w \in \vec{R}_{\mathcal{G}}$. The *parity of a vertex* v is the parity of $d(v)$. We denote by v° and v^{\bullet} if the parity of v is respectively even or odd.

Remark 18. In a arena \mathcal{G} , if v and w are vertices such that $d(v) = n > 0$ and $v \overset{\mathcal{G}}{\rightarrow}^* w$ and $w \in \vec{R}_{\mathcal{G}}$, then $v \overset{\mathcal{G}}{\rightarrow}^n w$.

The *parity* of a \rightarrow -edge $v \rightarrow w$ is the parity of $d(w)$. We say that an edge $v \rightarrow w$ is a *chord* if there is a vertex u such that either $v \rightarrow u$ and $u \rightsquigarrow w$; or $u \rightarrow w$ and $u \rightsquigarrow v$. By means of example, in the following MAs the edges $a \rightarrow b$ are chords.

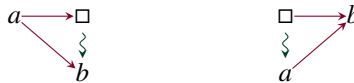

We denote by $\overset{\mathcal{G}}{\rightarrow}_{\bullet}$ the set of odd edges which are not chords.

Moreover, we define the set of edges

$$\overset{\mathcal{G}}{\rightsquigarrow}_{\partial} = \{vw \mid \text{either } v^{\circ} \text{ and } w = \hat{v} \text{ or } w^{\bullet} \text{ and } w = \hat{v}\}$$

Note that $v^{\bullet} \rightsquigarrow_{\partial} w^{\bullet}$ implies $v^{\bullet} \rightsquigarrow w^{\bullet}$, while $v^{\circ} \rightsquigarrow_{\partial} w^{\circ}$ implies $w^{\circ} \rightsquigarrow v^{\circ}$. That is, if $\Box A$ is right-hand side formula of a sequent (i.e., $\Box A^{\circ}$), then we have a $\rightsquigarrow_{\partial}$ from the vertex \Box to all the \rightarrow -roots of $\llbracket A \rrbracket$; while if $\Box A$ is left-hand side formula of a sequent (i.e., $\Box A^{\bullet}$), then we have a $\rightsquigarrow_{\partial}$ from the \rightarrow -roots of $\llbracket A \rrbracket$ to the vertex \Box .

Definition 19. A partitioned modal arena \mathcal{G} is *linked* if every $\overset{\mathcal{G}}{\sim}$ -class is of the form $\{v_1^{\bullet}, \dots, v_n^{\bullet}, w^{\circ}\}$. This induces the set directed edges $\overset{\mathcal{G}}{\rightarrow} = \{(v, w) \mid v^{\bullet} \overset{\mathcal{G}}{\sim} w^{\circ}\}$. The *linking graph* $\overset{\mathcal{G}}{\rightsquigarrow}$ of a modal arena is the direct graph with vertices $V_{\mathcal{G}}$ and edges $\overset{\mathcal{G}}{\rightarrow} \cup \overset{\mathcal{G}}{\rightsquigarrow}_{\partial} \cup \overset{\mathcal{G}}{\leftarrow}$.

We say that path in $\overset{\mathcal{G}}{\rightsquigarrow}$ is *checked* if it starts from a vertex in $\overset{\mathcal{G}}{\rightarrow} \cap \overset{\mathcal{G}}{\rightsquigarrow}_{\partial}$ and it contains no \leftarrow with source v with $\overset{\mathcal{G}}{\mathbb{C}}(v) \neq \emptyset$.

A *CK-arena net* is a non-empty linked modal arena which satisfies conditions 1-5 below:

1. $\overset{\mathcal{G}}{\rightsquigarrow}$ is acyclic: every checked path is acyclic;
2. $\overset{\mathcal{G}}{\rightsquigarrow}$ is *functional*: every checked path in $\overset{\mathcal{G}}{\rightsquigarrow}$ from a vertex v^{\bullet} to a root includes a vertex w° such that $v \rightarrow w$;
3. \mathcal{G} is *functorial*: if $v \rightsquigarrow w$ and $w \sim w'$ then there is v' such that $v \sim v'$ and $v' \rightsquigarrow w'$;
4. \mathcal{G} has almost all *non-empty modalities*²: if $v \in V_{\mathcal{G}}^{\Box\circ}$ and there is no $w \in V_{\mathcal{G}}$ such that $v \rightsquigarrow w$, then $v \in V_{\mathcal{G}}^{\circ}$;
5. \mathcal{G} is *CK-correct*: if $\{v_1^{\bullet}, v_2^{\bullet}, \dots, v_n^{\bullet}, w^{\circ}\} \subset V_{\mathcal{G}}^{\Box} \cup V_{\mathcal{G}}^{\circ}$ is a \sim -class, then either $v_1, v_2, \dots, v_n, w \in V_{\mathcal{G}}^{\Box}$ or there is a unique i such that $v_i, w \in V_{\mathcal{G}}^{\circ}$.

A modal arena is a *CD-arena net* if it satisfies Conditions 1-3 plus the following:

6. \mathcal{G} has all *non-empty modalities*: if $v \in V_{\mathcal{G}}^{\Box\circ}$, then there is $w \in V_{\mathcal{G}}$ such that $v \rightsquigarrow w$;
7. \mathcal{G} is *CD-correct*: if $\{v_1^{\bullet}, v_2^{\bullet}, \dots, v_n^{\bullet}, w^{\circ}\} \subset V_{\mathcal{G}}^{\Box} \cup V_{\mathcal{G}}^{\circ}$ is a \sim -class, then either $v_1, v_2, \dots, v_n, w \in V_{\mathcal{G}}^{\Box}$ or $w \in V_{\mathcal{G}}^{\circ}$ there is at most one $i \in \{1, \dots, n\}$ such that $v_i \in V_{\mathcal{G}}^{\circ}$.

A *modal arena net* is either a CK- or a CD-arena net. An *arena net* is a modal arena net with $V^{\Box\circ} = \emptyset$. Note that in this case Conditions 3, 4, 5, 6 and 7 are vacuous.

The intuition for Conditions 5 and 7 is that \sim -classes represent either atoms paired by an AX, or the set of modalities introduced by a same K^{\Box} , K^{\diamond} , K^{\perp} or D-rule. Following this intuition, if $\mathbb{c} = \{v_0, v_1, \dots, v_n\} \subset V_{\mathcal{G}}^{\Box\circ}$ is a \sim -class, then the modal arena with vertices $\bigcup_{v \in \mathbb{c}} \overset{\mathcal{G}}{\rightsquigarrow} \mathbb{C}(v)$ corresponds the sub-proof of the premise of any such rule.

²The only empty modality admitted is a \diamond^{\bullet} , that is, the \diamond which corresponds to a $\diamond \perp^{\bullet}$ introduced by a K^{\perp} -rule.

$$\begin{array}{c}
\frac{}{a \dashrightarrow a} \text{ax} \quad \frac{\mathcal{F}, \mathcal{G} \vdash \mathcal{H}}{\mathcal{F} \vdash \mathcal{G} \dashrightarrow \mathcal{H}} \supset^R \quad \frac{\mathcal{F} \vdash \mathcal{G} \quad \mathcal{J}, \mathcal{K} \vdash \mathcal{H}}{\mathcal{F}, \mathcal{J}, \mathcal{G} \dashrightarrow \mathcal{K} \vdash \mathcal{H}} \supset^L \quad \frac{\mathcal{F} \vdash \mathcal{G} \quad \mathcal{I} \vdash \mathcal{J}}{\mathcal{F}, \mathcal{I} \vdash \mathcal{G} \vdash \mathcal{J}} \wedge^R \quad \frac{\mathcal{F}, \mathcal{J}, \mathcal{I} \vdash \mathcal{K}}{\mathcal{F}, \mathcal{J} \vdash \mathcal{I} \vdash \mathcal{K}} \wedge^L \\
\frac{\langle \mathcal{G}_1, \dots, \mathcal{G}_n \vdash \mathcal{H} \mid \mathcal{E} \rangle}{\langle \diamond \dashrightarrow \mathcal{G}_1, \dots, \diamond \dashrightarrow \mathcal{G}_n \vdash \diamond \dashrightarrow \mathcal{H} \mid \mathcal{E} \cup \mathcal{V} \rangle} \text{K}^\square \quad \frac{\langle \mathcal{G}_1, \dots, \mathcal{G}_n \vdash \mathcal{H} \mid \mathcal{E} \rangle}{\langle \diamond \dashrightarrow \mathcal{G}_1, \dots, \diamond \dashrightarrow \mathcal{G}_i, \dots, \diamond \dashrightarrow \mathcal{G}_n \vdash \diamond \dashrightarrow \mathcal{H} \mid \mathcal{E} \cup \mathcal{V} \rangle} \text{K}^\diamond \\
\frac{\langle \mathcal{G}_1, \dots, \mathcal{G}_n \vdash \mathcal{H} \mid \mathcal{E} \rangle}{\langle \diamond, \diamond \dashrightarrow \mathcal{G}_1, \dots, \diamond \dashrightarrow \mathcal{G}_n \vdash \diamond \dashrightarrow \mathcal{H} \mid \mathcal{E} \cup \mathcal{V} \rangle} \text{K}^\perp \quad \frac{\langle \mathcal{G}_1, \dots, \mathcal{G}_n \vdash \mathcal{H} \mid \mathcal{E} \rangle}{\langle \diamond \dashrightarrow \mathcal{G}_1, \dots, \diamond \dashrightarrow \mathcal{G}_n \vdash \diamond \dashrightarrow \mathcal{H} \mid \mathcal{E} \cup \mathcal{V} \rangle} \text{D}
\end{array}$$

where $\mathcal{V} = \{(x, y) \mid x \text{ and } y \text{ vertices in the rule conclusion not occurring in the premise}\}$

Figure 6: Translation of the sequent rules in IMLL-CK and IMLL-CD into modal arena nets rules

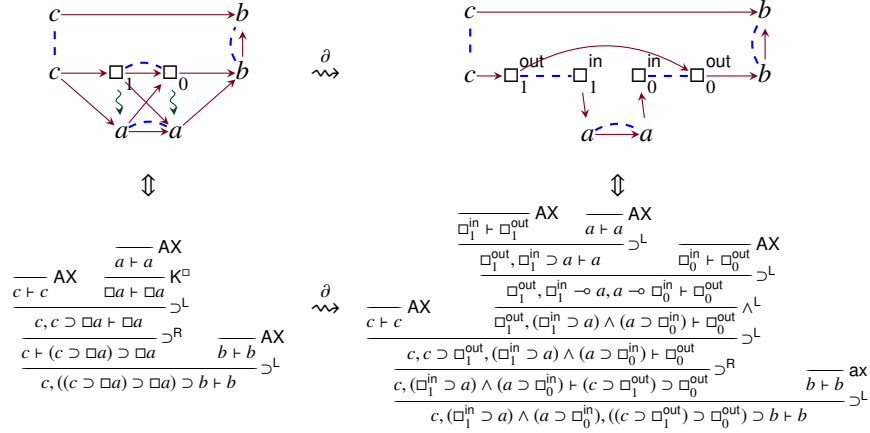

Figure 7: A K-arena net \mathcal{G} with associated formula $(c \wedge ((c \supset \square a) \supset \square a) \supset b) \supset b$, its corresponding arena $\partial(\mathcal{G})$, the derivations associated to \mathcal{G} and $\partial(\mathcal{G})$

Lemma 20. Let $X \in \{\text{CK}, \text{CD}\}$. If $\vdash^{IMLL-X} F$, then there is a X-arena net $\mathcal{G} = \langle V_{\mathcal{G}}, \xrightarrow{\mathcal{G}}, \rightsquigarrow^{\mathcal{G}}, \mathcal{E}^{\mathcal{G}} \rangle$ such that $\llbracket F \rrbracket = \langle V_{\mathcal{G}}, \xrightarrow{\mathcal{G}}, \rightsquigarrow^{\mathcal{G}} \rangle$.

Proof. Let π be a derivation of F in IMLL- X . We proceed by induction translating the derivation π of the formula F in a derivation of a modal arena \mathcal{G} (with associated formula F) in the system described by the rules in Figure 6.

By definition, each rule in IMLL- X preserves X-arena net conditions, that is, if the premises of a rule are X-arena nets, then the conclusion is. In particular, Condition 5 fails for the rule D. Similarly, each rule except K^\perp preserves the CD-arena net conditions. \square

Lemma 21. Let $X \in \{\text{CK}, \text{CD}\}$ and \mathcal{G} a modal arena with associated formula F . If \mathcal{G} is a X-arena net, then $\vdash^{IMLL-X} F$.

Proof. We prove the theorem for CK-arena nets.

To prove this theorem we define from the CK-arena net \mathcal{G} , with associated formula F , an arena net $\partial(\mathcal{G})$ with associated formula $\partial(F)$. We then use of the result in [39] on (non-modal) arena nets to produce an IMLL-derivation of $\partial(F)$. Then we conclude by showing how to define a IMLL- X -derivation of F using the IMLL-derivation of $\partial(F)$.

Step 1: definition of $\partial(\mathcal{G})$. If $\mathcal{G} = \langle V_{\mathcal{G}}, \xrightarrow{\mathcal{G}}, \rightsquigarrow^{\mathcal{G}}, \overset{\mathcal{G}}{\sim} \rangle$ is a CK-arena net, we write $v \Downarrow w$ either if $\hat{v} \sim \hat{w}$, or if $v = \hat{v}$ and $w = \hat{w}$, that is, $v \Downarrow w$ iff both v and w belongs to the scope of a same modality or in the scope of no modality.

We define the arena $\partial(\mathcal{G})$ by removing all \rightsquigarrow -edges in \mathcal{G} and keeping only the \rightarrow between vertices $v, w \in V_{\mathcal{G}}$ such that $v \Downarrow w$. Then we replace each modal vertex v by a pair of \rightarrow -linked vertices $v^{\text{in}}, v^{\text{out}}$ in such a way that the vertex v^{in} keeps track of the subformulas of the modality, while v^{out} is a placeholder to keep track of the interaction of the subformulas with the context.

Formally we define $\partial(\mathcal{G}) = \langle \partial(V_{\mathcal{G}}), \partial(\xrightarrow{\mathcal{G}} \cup \rightsquigarrow^{\mathcal{G}}), \overset{\partial(\mathcal{G})}{\sim} \rangle$ by:

- $\partial(V_{\mathcal{G}}) = V_{\mathcal{G}}^{\mathcal{A}} \cup \{v^{\text{in}}, v^{\text{out}} \mid v \in V_{\mathcal{G}}^{\circ}\}$
- $\partial(\xrightarrow{\mathcal{G}} \cup \rightsquigarrow^{\mathcal{G}})$ is the union of the following sets where we assume $u, v \in V_{\mathcal{G}}^{\mathcal{A}}$ and $l^{\circ}, r^{\circ}, m, n, p \in V_{\mathcal{G}}^{\circ}$:

$$\begin{aligned} & \{(u, v) \mid u \Downarrow v \text{ and } u \rightarrow v\} \\ & \{(l^{\text{out}}, r^{\text{out}}) \mid l \rightarrow r\} \\ & \{(u, r^{\text{in}}), (l^{\text{in}}, v) \mid l = \hat{v}, r = \hat{u}\} \\ & \{(u, m^{\text{out}}), (m^{\text{out}}, v) \mid u \rightarrow m \rightarrow v, m \Downarrow u \Downarrow v\} \\ & \{(m^{\text{out}}, n^{\text{out}}), (n^{\text{out}}, p^{\text{out}}) \mid m \rightarrow n \rightarrow p, m \Downarrow n \Downarrow p\} \end{aligned}$$

- $\overset{\partial(\mathcal{G})}{\sim}$ is defined as:

$$\begin{aligned} v \overset{\partial(\mathcal{G})}{\sim} w & \quad \text{if } v, w \in V_{\mathcal{G}}^{\mathcal{A}} \subset \partial(V_{\mathcal{G}}) \text{ and } v \overset{\mathcal{G}}{\sim} w \\ v^{\text{in}} \overset{\partial(\mathcal{G})}{\sim} v^{\text{out}} & \quad \text{for each } v \in V_{\mathcal{G}}^{\circ} \end{aligned}$$

See the first line of Figures 7 and 8 for running examples.

We observe that if $\{v_0^{\circ}, v_1^{\circ}, \dots, v_n^{\circ}\}$ is a $\overset{\mathcal{G}}{\sim}$ -class of modal vertices, then a P-formula associated to \mathcal{G} is of the form

$$H = H\{\ell(v_0)A_0^{\circ}\}\{\ell(v_1)A_1^{\circ}\} \cdots \{\ell(v_n)A_n^{\circ}\}$$

for an $(n+1)$ -ary context $H\{\} \cdots \{\}$. In this case, a P-formula associated to the arena $\partial(\mathcal{G})$ is of the form

$$\partial(H) = \partial(H)\{v_0^{\text{out}^{\circ}}\}\{v_1^{\text{out}^{\bullet}}\} \cdots \{v_n^{\text{out}^{\bullet}}\}\{H_c^{\bullet}\}$$

with $\partial(H)\{\} \cdots \{\}$ is an $(n+2)$ -ary context, $v_i^{\text{in}}, v_i^{\text{out}}$ are fresh propositional variables for all $i \in \{0, \dots, n\}$ and

$$H_c^{\bullet} = \left((v_1^{\text{in}} \multimap \partial(A_1^{\bullet}) \otimes \cdots \otimes v_n^{\text{in}} \multimap \partial(A_n^{\bullet})) \supset \partial(A_0^{\circ}) \multimap v_0^{\text{in}} \right)^{\bullet}$$

Step 2: prove that $\partial(\mathcal{G})$ is an arena net.

We observe that, by definition of $\partial(\mathcal{G})$, every path $\partial(\mathbf{p})$ in $\partial(\widehat{\mathcal{G}})$ can be constructed from a checked path \mathbf{p} in $\widehat{\mathcal{G}}$ by induction:

- the empty path is a path in both $\widehat{\mathcal{G}}$ and $\partial(\widehat{\mathcal{G}})$;
- if $\mathbf{p} = v \cdot \mathbf{p}'$ then
 - if $v \in V_{\mathcal{G}}^{\mathcal{A}}$, then $\partial(\mathbf{p}) = v \cdot \partial(\mathbf{p}')$;
 - if $v^{\bullet} \in V_{\mathcal{G}}^{\circ}$, then $\partial(\mathbf{p}) = v^{\text{out}} \cdot v^{\text{in}} \cdot \partial(\mathbf{p}')$;
 - if $v^{\circ} \in V_{\mathcal{G}}^{\circ}$, then $\partial(\mathbf{p}) = v^{\text{in}} \cdot v^{\text{out}} \cdot \partial(\mathbf{p}')$;

We remark that the parity of atomic vertices is preserved by ∂ , while the parity of a modal vertex $v \in V_{\mathcal{G}}$ is the same of the corresponding vertex $v^{\text{out}} \in V_{\partial(\mathcal{G})}$. Since if v^{\bullet} then $v^{\text{out}} \rightarrow v^{\text{in}}$, and if v° then $v^{\text{in}} \rightarrow v^{\text{out}}$, then we have that in $\partial(\mathcal{G})$ an even (odd) vertex may occur only in a even (odd) position in a path in $\widehat{\mathcal{G}}$. We conclude since from any path in $\partial(\widehat{\mathcal{G}})$ we obtain a path in $\widehat{\mathcal{G}}$ by replacing every subpath $v^{\text{out}} \rightarrow v^{\text{in}}$ and $v^{\text{in}} \rightarrow v^{\text{out}}$ by the corresponding modal vertex v in \mathcal{G} .

By this correspondence between checked paths in $\widehat{\mathcal{G}}$ and paths in $\partial(\widehat{\mathcal{G}})$ we conclude that $\partial(\widehat{\mathcal{G}})$ is acyclic and functional. That is, $\partial(\mathcal{G})$ is an arena net.

Step 3: construct the derivation associated to $\partial(\mathcal{G})$. Since $\partial(\mathcal{G})$ is an arena net, then we apply the result in [39] to produce a derivation in IMLL of the formula $\partial(F)$. In such a derivation, by functionality and functoriality of \mathcal{G} , whenever v and w are modal vertices such that $v \xrightarrow{\mathcal{G}} w$, then if a path in $\partial(\widehat{\mathcal{G}})$ contains v^{in} , then it also contains v^{out} , w^{in} , w^{out} . This means that if $\mathbf{c} = \{v_0^{\circ}, v_1^{\bullet}, \dots, v_n^{\bullet}\}$ is an \mathcal{G} -class of vertices in $\widehat{\mathcal{G}}$, then any derivation of $\partial(F)$ in IMLL contains a subderivation of the sequent $v_1^{\text{out}}, \dots, v_n^{\text{out}}, [H_{\mathbf{c}}] \vdash v_0^{\text{out}}$ of the following form

$$\frac{\frac{\frac{\frac{v_1^{\text{out}} \vdash v_1^{\text{out}} \text{ AX} \cdots \frac{v_n^{\text{out}} \vdash v_n^{\text{out}} \text{ AX}}{v_1^{\text{out}}, \dots, v_n^{\text{out}} \supset \partial(A_1), \dots, \partial(A_n) \vdash \partial(A_0)} \supset^{\text{IMLL}} \partial(A_1), \dots, \partial(A_n), \vdash \partial(A_0)} \supset^{\text{L}}}{v_1^{\text{out}}, \dots, v_n^{\text{out}}, v_1^{\text{in}} \supset \partial(A_1), \dots, v_n^{\text{in}} \supset \partial(A_n) \vdash \partial(A_0)} \wedge^{\text{L}}}{\frac{v_1^{\text{out}}, \dots, v_n^{\text{out}}, \wedge_{i=1}^n (v_i^{\text{in}} \supset \partial(A_i)) \vdash \partial(A_0)}{v_1^{\text{out}}, \dots, v_n^{\text{out}} \vdash \wedge_{i=1}^n (v_i^{\text{in}} \supset \partial(A_i)) \supset \partial(A_0)} \supset^{\text{R}}}{v_1^{\text{out}}, \dots, v_n^{\text{out}}, (\wedge_{i=1}^n (v_i^{\text{in}} \supset \partial(A_i)) \supset \partial(A_0)) \supset v_0^{\text{in}} \vdash v_0^{\text{out}} \text{ ax}} \rightarrow^{\bullet}}$$

In order to construct a derivation in IMLL-X of the formula F it suffices to proceed by induction over the number of \mathcal{G} -classes of modal vertices. Starting from the top of the derivation, we replace every such subderivation in the derivation of $\partial(F)$ with an application of a K^{\square} -, K^{\diamond} - or K^{\perp} -rule, we remove all the occurrences of the formula $[H_{\mathbf{c}}] = (\wedge_{i=1}^n (v_i^{\text{in}} \supset \partial(A_i)) \supset \partial(A_0)) \supset v_0^{\text{in}}$ in the derivation, and we replace for each $i \in \{0, \dots, n\}$ the atom v_i^{in} with the corresponding formula $\ell(v_i)A_i$ as shown in Figure 9. For some example, refer to the lower line of Figures 7 and 8.

The proof for CD-arena nets is similar by considering the rule D instead of K^{\perp} . \square

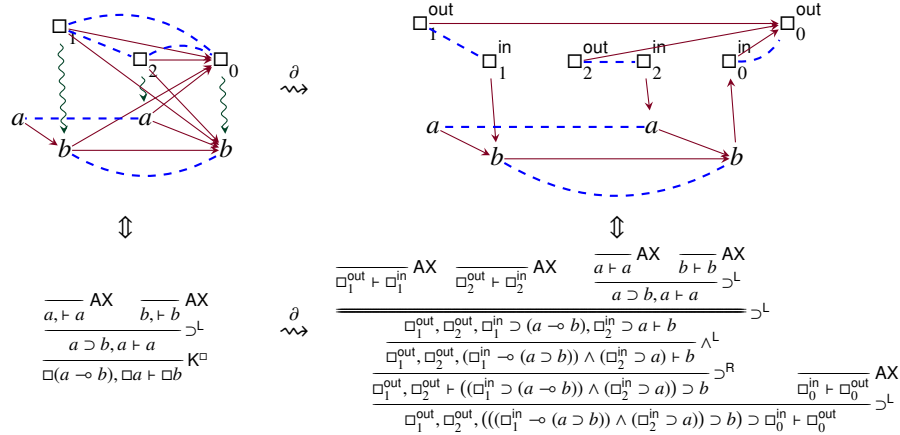

Figure 8: A K-arena net \mathcal{G} with associated formula $\Box(a \supset b) \supset (\Box a \supset \Box b)$ (the axiom k_1), its corresponding arena $\partial(\mathcal{G})$, the derivations associated to \mathcal{G} and $\partial(\mathcal{G})$

$$\begin{array}{c}
 \mathfrak{D}'' \parallel \text{IMLL} \\
 A_1, \dots, A_n, \vdash A_0 \\
 \partial(\mathfrak{D}') \parallel \text{IMLL} \\
 \square_1^{\text{out}}, \dots, \square_n^{\text{out}}, [H_c] \vdash \square_0^{\text{out}} \\
 \mathfrak{D}(\{\square_0^{\text{out}}\} \{ \square_1^{\text{out}} \} \dots \{ \square_n^{\text{out}} \} \{ [H_c] \}) \parallel \text{IMLL} \\
 \partial(F) \{ \square_0^{\text{out}} \} \{ \square_1^{\text{out}} \} \dots \{ \square_n^{\text{out}} \} \{ [H_c] \}
 \end{array}
 \rightsquigarrow
 \begin{array}{c}
 \mathfrak{D}'' \parallel \text{IMLL-X} \\
 A_1, \dots, A_n \vdash A_0 \\
 \square A_1, \dots, \square A_n \vdash \square A_0 \\
 \mathfrak{D}(\{\square A_0\} \{ \square A_1 \} \dots \{ \square A_n \} \{ \emptyset \}) \parallel \text{IMLL-X} \\
 F \{ \square A_0 \} \{ \square A_1 \} \dots \{ \square A_n \}
 \end{array}
 K^\square$$

Figure 9: An example of the construction of the derivation of F from the derivation of $\partial(F)$ assuming that in \mathcal{G} there is only one \sim -class of the form $\{\square_0, \dots, \square_n\}$

We summarize the results of this section (Lemmas 20 and 21) by the following

Theorem 22. Let $X \in \{\text{CK}, \text{CD}\}$ and \mathcal{G} be a modal arena with associated formula F , then

$$\mathcal{G} \text{ is a } X\text{-arena net} \iff \vdash^{\text{IMLL-X}} F$$

5 Skew fibrations

In this section we define specific maps between MAs to model the application of the deep inference rules in Figure 4.

If v, w are two vertices in an MA, a *meeting point* of v and w is a vertex u such that $v \rightarrow^* u$ and $w \rightarrow^* u$, and such that if there is u' such that $v \rightarrow^* u'$ and $w \rightarrow^* u'$, then $u \rightarrow^* u'$. The *meeting depth* of v and w is the minimum of the depth of their meeting point or -1 if no such vertex exists. Two distinct vertices v and w are *conjunct*, denoted $v \wedge w$ if their meeting depth is odd; they are *disjunct*, denoted $v \vee w$ if their meeting depth is even.

Definition 23 (Skew Fibration). An *arena homomorphism* is either a map $\emptyset_{\mathcal{G}}: \emptyset \rightarrow \mathcal{G}$ from the empty 2-dag to an MA \mathcal{G} , or a map $f: \mathcal{H} \rightarrow \mathcal{G}$ between two MAs \mathcal{H} and \mathcal{G} mapping $V_{\mathcal{H}}$ to $V_{\mathcal{G}}$ in such a way it preserves:

- \rightarrow : if $v \xrightarrow{\mathcal{H}} w$ then $f(v) \xrightarrow{\mathcal{G}} f(w)$;
- \rightsquigarrow : if $v \rightsquigarrow^{\mathcal{H}} w$ then $f(v) \rightsquigarrow^{\mathcal{G}} f(w)$;
- d : $d(v) = d(f(v))$;
- ℓ : $\ell(v) = \ell(f(v))$.

An arena homomorphism is *modal* whenever:

- if $f(v) \rightsquigarrow^{\mathcal{G}} f(u)$, then $w \rightsquigarrow^{\mathcal{H}} u$ and $f(v) = f(w)$ for a $w \in V_{\mathcal{G}}$.

An (*even*) *skew fibration* is a modal arena homomorphism $f: \mathcal{H} \rightarrow \mathcal{G}$ which:

- preserves \wedge : if $v \wedge_{\mathcal{H}} w$ then $f(v) \wedge_{\mathcal{G}} f(w)$;
- is a *skew lifting*: if $f(v) \wedge_{\mathcal{G}} w$, then there exists u with $v \wedge_{\mathcal{H}} u$ and $f(u) \not\wedge_{\mathcal{G}} w$;

An *odd skew fibration* is either a map $\emptyset_{\mathcal{G}}: \emptyset \rightarrow \mathcal{G}$, or a modal arena homomorphism $f: \mathcal{H} \rightarrow \mathcal{G}$ which:

- preserves \vee : if $v \vee_{\mathcal{H}} w$ then $f(v) \vee_{\mathcal{G}} f(w)$;
- is a *odd skew lifting*: if $f(v) \vee_{\mathcal{G}} w$, then there exists u with $v \vee_{\mathcal{H}} u$ and $f(u) \not\vee_{\mathcal{G}} w$;

Remark 24. In [39] the definition of skew fibration only demands the weaker *root preserving* condition (that is, if $v \in \vec{R}_{\mathcal{H}}$ then $f(v) \in \vec{R}_{\mathcal{G}}$) instead of the depth preserving condition we propose here. However, in the same paper it is proven that root preserving is equivalent to the depth preserving for even and odd skew fibrations between arenas.

In order to prove the results in this section, it is useful to highlight the correlations between mutual position of nodes in the formula tree \mathcal{T}_F of a formula F and the presence of \rightarrow - or \rightsquigarrow -edges between the corresponding vertices in $\llbracket F \rrbracket$.

Definition 25. If F is a formula, the *formula tree* of F is the tree \mathcal{T}_F with nodes labeled by \supset , \wedge or \perp symbols, atoms, and modalities occurring in F . It is defined inductively as follows:

- if $F = a$, then \mathcal{T}_F is the with a single node labeled by a ;
- if $F = A \supset B$ (respectively $F = A \wedge B$), then \mathcal{T}_F is the tree with root labeled by \supset (respectively \wedge) with children the roots of \mathcal{T}_A and \mathcal{T}_B ;
- If $F = \Box A$ ($F = \Diamond A$) for a formula A , then \mathcal{T}_F is the tree with root labeled by \Box (respectively \Diamond) which has as one child the root of \mathcal{T}_A ;
- If $F = \Diamond \perp$, then \mathcal{T}_F is the tree with root labeled by \Diamond and a single child labeled by \perp ;

Example 26. Let $F = \Box(\Diamond\perp \supset (a \wedge b)) \supset ((c \supset d) \wedge e)$ be a formula. The formula tree \mathcal{T}_F is the following

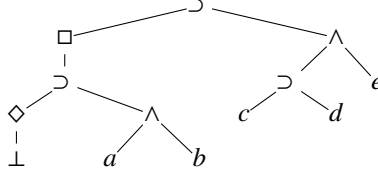

Definition 27. In a formula tree \mathcal{T}_F , we call a node the *left-hand side child* (*right-hand side child*) of a \supset -node if it corresponds to the root of the left-hand side (respectively the right-hand side) subformula formula of the implication.

If v is a node of a formula tree \mathcal{T}_F , we say that a node w is a *rightmost descendant* of v if there is a path from v to w in \mathcal{T}_F containing no left-hand side child of any \supset -node. If v is a \supset -node of a formula tree \mathcal{T}_F , we say that a node w is a *second-rightmost descendant* of v if it is a rightmost descendant of its left-hand side child.

By means of example, consider the formula tree of $F = (\Box(\Diamond\perp \supset (a \wedge b))) \supset ((c \supset d) \wedge e)$ given in Example 26. The left-hand side child of the root of \mathcal{T}_F is the root of $\mathcal{T}_{\Box(\Diamond\perp \supset (a \wedge b))}$ while its the right-hand side child is the root of $\mathcal{T}_{(c \supset d) \wedge e}$. The set of rightmost and second-rightmost nodes of the root \supset are respectively $\{d, e\}$ and $\{\Box, a, b\}$.

Remark 28. Let F be a formula and \mathcal{T}_F the formula tree of F . If we identify the atom or modality x occurring in F with the corresponding the node of \mathcal{T}_F and with the unique x -labeled vertex x in $\llbracket F \rrbracket$, then we have the following correspondence:

- $a \xrightarrow{\llbracket F \rrbracket} b$ iff the least common ancestor of a and b in \mathcal{T}_F is a \supset , and a and b are respectively a second-rightmost descendant and a rightmost descendant of the least common ancestor;
- $m \rightsquigarrow x$ with iff x is a rightmost descendant of $m \in \{\Box, \Diamond\}$.

Moreover, $d(x)$ is equal to the number of left-hand side children of \supset -nodes occurring in the path from the root of \mathcal{T}_F to the node v .

Lemma 29. *The composition of two skew fibrations is a skew fibration.*

Proof. By definition of skew fibration (see ??). □

Proof. By definition, the composition of two modal skew fibrations preserves \rightarrow , \rightsquigarrow , \sim and d . Then the preservation of \wedge and the skew lifting condition of the composition are guaranteed as consequence of the preservation of d and \rightarrow . Similarly, the modal condition of the composition is guaranteed as consequence of the preservation of \rightsquigarrow . □

Remark 30. Note that the proof of Lemma 29 makes crucial use of the fact that we talk about arena homomorphisms, and an arena is always associated to a formula. In classical logic [23, 5] a skew fibration is defined as a homomorphism between arbitrary graphs, and the composition of skew fibrations is only a skew fibration if those graphs are associated to formulas.

We are now able to prove the correspondence between LI_\perp° derivations from a P-formula H' to H and skew fibrations between their corresponding arenas.

Lemma 31. *For any P-formulas H' and H , if $H' \stackrel{\text{LI}_\perp^\circ}{\vdash} H$, then there is a skew fibration $f: \llbracket H' \rrbracket \rightarrow \llbracket H \rrbracket$.*

Proof. If we prove that for all $\rho \in \{\mathbf{w}_\perp^\diamond, \mathbf{w}_\perp^\otimes, \mathbf{w}_\perp^\circ, \mathbf{c}_\perp^\bullet\}$ if $\frac{H'}{H} \rho$ then there is a skew fibration $f: \llbracket H' \rrbracket \rightarrow \llbracket H \rrbracket$, we can conclude by Lemma 29. We proceed by case analysis.

If $\rho = \mathbf{w}_\perp^\otimes$, then $H' = \Gamma\{A^\bullet\}$ and $H = \Gamma\{A \otimes B^\bullet\}$. In particular, we can obtain \mathcal{T}_H from $\mathcal{T}_{H'}$ by removing the formula subtree \mathcal{T}_A and replace its root with a \otimes -node with children the roots of \mathcal{T}_A and \mathcal{T}_B . After Remark 28, the arena homomorphism $f: \llbracket H' \rrbracket \rightarrow \llbracket H \rrbracket$ preserves $\rightarrow, \rightsquigarrow, \sim, d$ and \wedge by definition. Moreover, since the map is injective, modal condition is trivially satisfied, while the skew lifting immediately follow by the fact that the roots of $\llbracket A^\bullet \rrbracket$ have odd depth in $\llbracket H \rrbracket$. Thus f is a skew fibration.

If $\rho = \mathbf{w}_\perp^\circ$, conclude by a similar reasoning. In this case, we obtain \mathcal{T}_H from $\mathcal{T}_{H'}$ by removing the formula subtree \mathcal{T}_A and replace its root with a \multimap -node with left-hand side child the root of \mathcal{T}_B and right-hand side child the root of \mathcal{T}_A . Since the root of \mathcal{T}_A is the right-hand side child of a \multimap , arena homomorphism $f: \llbracket H' \rrbracket \rightarrow \llbracket H \rrbracket$ is a skew fibration since it is injective and no new \rightarrow or \rightsquigarrow are added between the vertices in $\llbracket H \rrbracket$ image of vertices in f .

If $\rho = \mathbf{w}_\perp^\diamond$, conclude by a similar reasoning. In particular, it suffices to replace in \mathcal{T}'_H a leaf labeled by a \perp with the tree of the weakened formula.

If $\rho = \mathbf{c}_\perp^\bullet$, then $H' = \Gamma\{(A_1 \otimes A_2)^\bullet\}$ and $H = \Gamma\{A^\bullet\}$, that is, and \mathcal{T}'_H has the two identical subtrees \mathcal{T}_F and their roots are children of a same node labeled by \otimes . Thus \mathcal{T}_H can be obtained from \mathcal{T}'_H by removing the node labeled by \otimes and replace it with the root of \mathcal{T}_F . After Remark 28, the arena homomorphism $f: \llbracket H' \rrbracket \rightarrow \llbracket H \rrbracket$ preserves $\rightarrow, \rightsquigarrow, \sim$ and d . Moreover f is surjective, then it is a skew lifting and preserves \wedge . Moreover f is modal since it is injective on $\Gamma\{\}$ and whenever $f(v) \rightsquigarrow f(u)$, then either v and u are both vertices in $\llbracket A_1 \rrbracket$ or in $\llbracket A_2 \rrbracket$, or we have v' and u' such that $f(v) = f(v')$, $f(u) = f(u')$, $v \rightsquigarrow u'$, $v \rightsquigarrow v'$ with $i, j \in \{1, 2\}$, $i \neq j$. We conclude that f is a skew fibration. \square

In order to prove the converse result, we need some additional lemmas.

Lemma 32. *If $f: \mathcal{H} \rightarrow \mathcal{G}$ is an arena homomorphism and $\mathcal{G} = \mathcal{G}_1 + \mathcal{G}_2$, then $f = f_1 + f_2$ with $f_1: \mathcal{H}_1 \rightarrow \mathcal{G}_1$ and $f_2: \mathcal{H}_2 \rightarrow \mathcal{G}_2$ arena homomorphisms for some $\mathcal{H}_1, \mathcal{H}_2$ such that $\mathcal{H} = \mathcal{H}_1 + \mathcal{H}_2$.*

Proof. Since f preserves \rightarrow , then if $v \rightarrow^* w$ for a $w \in \vec{R}_{\mathcal{G}}$ then $f(v) \rightarrow^* f(w)$. Thus if $\mathcal{G} = \mathcal{G}_1 + \mathcal{G}_2$, then there is a partition³ $\vec{R}_{\mathcal{G}} = \vec{R}_{\mathcal{G}_1} \uplus \vec{R}_{\mathcal{G}_2}$. Then we can define $V_{\mathcal{H}_1}$ and $V_{\mathcal{H}_2}$ as the sets of vertices of \mathcal{H} which images by f admit a \rightarrow -path to a vertex in $\vec{R}_{\mathcal{G}_1}$

³As remarked in the proof of Theorem 14, in construction such partition, because of \rightsquigarrow -coherence, whenever $v \rightsquigarrow w$ then v and w belong to the same subset.

and $\vec{R}_{\mathcal{G}_2}$ respectively. The MAs \mathcal{H}_1 and \mathcal{H}_2 are defined from \mathcal{H} by the sets $V_{\mathcal{H}_1}$ and $V_{\mathcal{H}_2}$ respectively. \square

Lemma 33. *Let $f: \mathcal{H} \rightarrow \mathcal{G}$ is a even or odd skew fibration, with $\mathcal{G} = \mathcal{G}_1 \rightarrow \mathcal{G}_2$ and \mathcal{G}_1 MAs. If there are two MAs \mathcal{H}' and \mathcal{H}'' such that $\mathcal{H} = \mathcal{H}' \rightarrow \mathcal{H}''$ and \mathcal{H}'' cannot be written as \rightarrow of two MAs, then $f(v) \in V_{\mathcal{G}_2}$ for all $v \in V_{\mathcal{H}''}$.*

Proof. Let $v \in \mathcal{H}''$ such that $f(v) \in \mathcal{G}_1$. Since f preserves d , then $v \notin \vec{R}_{\mathcal{H}}$. Thus \mathcal{H}'' cannot be a single-vertex MA. If \mathcal{H}'' is a $+$ of two MAs, then there is $z \in \vec{R}_{\mathcal{H}''}$ such that $v \not\rightarrow^* z$, hence $v \wedge z$ in \mathcal{H} but $f(v) \not\wedge f(z)$ in \mathcal{G} . Therefore f is not an even skew fibration. Let $f(z) = w$. Then $f(v) \vee w$ because $f(v) \in \mathcal{G}_1$ and $w \in \vec{R}_{\mathcal{G}}$. If there is a u with $v \vee u$ in \mathcal{H} then there is $x \in V_{\mathcal{H}}$ such that $u \rightarrow x^\circ$ and $v \rightarrow x^\circ$. Since $x \rightarrow^* w$ we have $f(u) \vee w$, which means that f cannot be an odd skew fibration either. Then \mathcal{H}'' has to be of the shape $w \rightarrow \mathcal{H}_2''$ and $f(w) \in \mathcal{G}_2$ because $v \in \vec{R}_{\mathcal{H}}$. We can conclude as for the previous case that f is not an even or odd skew fibration. Contradiction. \square

Lemma 34. *Let $f: \mathcal{H} \rightarrow \mathcal{G}$ is a even or odd skew fibration, with $\mathcal{G} = \mathcal{G}_1 \rightarrow \mathcal{G}_2$ for an MA \mathcal{G}_1 . If there is an MA \mathcal{H}' such that $\mathcal{H} = \mathcal{H}' \rightarrow \mathcal{H}''$, then there are \mathcal{H}_1 and \mathcal{H}_2 such that $\mathcal{H} = \mathcal{H}_1 \rightarrow \mathcal{H}_2$ and $f = f_1 \rightarrow f_2$ where $f_1: \mathcal{H}_1 \rightarrow \mathcal{G}_1$ and $f_2: \mathcal{H}_2 \rightarrow \mathcal{G}_2$ are modal arena homomorphisms.*

Proof. By hypothesis, we can assume that \mathcal{H} is of the form $\mathcal{H} = \mathcal{H}' \rightarrow \mathcal{H}''$ where \mathcal{H}'' is not a \rightarrow of two MAs. We conclude by Lemma 33 that $f(v) \in V_{\mathcal{G}_2}$ for any $v \in V_{\mathcal{H}''}$. If $V_{\mathcal{G}_2} = f(V_{\mathcal{H}''})$, then we conclude that $\mathcal{H}_1 = \mathcal{H}'$ and $\mathcal{H}_2 = \mathcal{H}''$. Otherwise, let $\mathcal{H}' = \mathcal{H}'_1 + \dots + \mathcal{H}'_n$ such that \mathcal{H}'_i is a $+$ of two MAs for no $i \in \{1, \dots, n\}$. If $v, w \in V_{\mathcal{H}'}$, then there is a $(\leftrightarrow \cup \leftrightarrow)$ -path from v to w in $V_{\mathcal{H}'}$ iff there is $i \in \{1, \dots, n\}$ such that $v, w \in V_{\mathcal{H}'_i}$. Since $\vec{R}_{\mathcal{G}} \subset f(V_{\mathcal{H}''})$, this implies that if there is $i \in \{1, \dots, n\}$ such that $v, w \in V_{\mathcal{H}'_i}$, then there is $(\leftrightarrow \cup \leftrightarrow)$ -path from $f(v)$ to $f(w)$ in $V_{\mathcal{G}} \setminus \vec{R}_{\mathcal{G}}$. That is, $f(V_{\mathcal{H}'_i})$ is either a subset of $V_{\mathcal{G}_1}$ or a subset of $V_{\mathcal{G}_2}$ for all $i \in \{1, \dots, n\}$. Without loss of generality we assume there is j such that $f(V_{\mathcal{H}'_j}) \subset V_{\mathcal{G}_1}$ for all $i \leq j$. We conclude that $\mathcal{H}_1 = \mathcal{H}'_1 + \dots + \mathcal{H}'_j$ and $\mathcal{H}_2 = (\mathcal{H}'_{j+1} + \dots + \mathcal{H}'_n) \rightarrow \mathcal{H}''$. \square

Lemma 35. *Let $f: \mathcal{H} \rightarrow \mathcal{G}$ be a modal arena homomorphism and $\mathcal{G} = v \rightarrow \mathcal{G}'$. If f is an even skew fibration then, $\mathcal{H} = w \rightarrow \mathcal{H}'$ and $f = 1_w \rightarrow f'$ with $f': \mathcal{H}' \rightarrow \mathcal{G}'$ an even skew fibration. If f is odd skew fibration, then*

- either $\mathcal{H} = w \rightarrow \mathcal{H}_2$ and $f = 1_w \rightarrow f_2$ with $f_2: \mathcal{H}_2 \rightarrow \mathcal{G}_2$ an odd skew fibration;
- or $\mathcal{H} = (w \rightarrow \mathcal{H}_1) + \mathcal{H}_2$ and $f = [f_1, f_2]$ with $f_1: (w \rightarrow \mathcal{H}_1) \rightarrow (v \rightarrow \mathcal{G}_2)$ and $f_2: \mathcal{H}_2 \rightarrow (v \rightarrow \mathcal{G}_2)$.

Proof. If f is an even skew fibration, then to conclude it suffices to remark there is a unique w such that $f(w) = v$ since $v \in \vec{R}_{\mathcal{G}}$.

If f is an odd skew fibration, let w such that $f(w) = v$. If $V_{\mathcal{H}} \setminus \{w\} = \vec{\vec{C}}(w)$, then we can conclude. Otherwise we conclude with \mathcal{H}_2 be the MA with vertices in $V_{\mathcal{H}} \setminus (\{w\} \cup \vec{\vec{C}}(w))$. \square

In order to prove the converse of the previous theorem we give some additional definitions and useful lemmas.

Definition 36. If $f_1 : \mathcal{H}_1 \rightarrow \mathcal{G}_1$ and $f_2 : \mathcal{H}_2 \rightarrow \mathcal{G}_2$ are modal arena homomorphisms, we define the following modal arena homomorphisms:

$$\begin{aligned} 1_v &= 1 : v \rightarrow v \\ f_1 + f_2 &= f_1 \cup f_2 : \mathcal{H}_1 + \mathcal{H}_2 \rightarrow \mathcal{G}_1 + \mathcal{G}_2 \\ f_1 \rightarrow f_2 &= f_1 \cup f_2 : \mathcal{H}_1 \rightarrow \mathcal{H}_2 \rightarrow \mathcal{G}_1 \rightarrow \mathcal{G}_2 \quad (\mathcal{H}_1, \mathcal{G}_1 \neq \emptyset) \\ f_1 \rightsquigarrow f_2 &= f_1 \cup f_2 : \mathcal{H}_1 \rightsquigarrow \mathcal{H}_2 \rightarrow \mathcal{G}_1 \rightsquigarrow \mathcal{G}_2 \\ [f_1, f_2] &= f_1 \cup f_2 : \mathcal{H}_1 + \mathcal{H}_2 \rightarrow \mathcal{G} \quad (\mathcal{G}_1 = \mathcal{G}_2 = \mathcal{G}) \end{aligned}$$

Lemma 37. Every (even) skew fibration is of the form

$$1_{\mathcal{G}} \quad f^\circ + g^\circ \quad f^\bullet \rightarrow g^\circ \quad 1_v \rightsquigarrow g^\circ$$

and every odd skew fibration is of the form

$$1_{\mathcal{G}} \quad [f^\bullet, g^\bullet] \quad f^\bullet + g^\bullet \quad f^\circ \rightarrow g^\bullet \quad 1_v \rightsquigarrow g^\bullet \quad \emptyset_{\mathcal{G}}$$

where f° and g° are even skew fibrations, f^\bullet and g^\bullet are odd skew fibrations, $v \in V_{\llbracket H \rrbracket}^{\square\square}$, and \mathcal{G} can be any MA.

Proof. By case analysis, let $f : \mathcal{H} \rightarrow \mathcal{G}$ be a modal arena homomorphism, remarking that for any MA \mathcal{G} , the identity map $1_{\mathcal{G}}$ is by definition an even and an odd skew fibration.

If $f^\circ : \mathcal{H} \rightarrow \mathcal{G}$ is an even skew fibration, then

- if \mathcal{G} is a single-vertex MA, then \mathcal{H} cannot be either of the shape $\mathcal{H}_1 + \mathcal{H}_2$ or $\mathcal{H}_1 \rightarrow \mathcal{H}_2$ otherwise f would not preserve \wedge , or of the shape $\mathcal{H}_1 \rightsquigarrow \mathcal{H}_2$ otherwise it would not preserve d . Then $f = 1_v$ with v the unique vertex in $V_{\mathcal{H}} = V_{\mathcal{G}}$.
- if $\mathcal{G} = \mathcal{G}_1 + \mathcal{G}_2$, then by Lemma 32 we have that $f^\circ = f_1 + f_2$ with f_1 and f_2 arena homomorphisms. Since f° is an even skew fibration, it follows by definition of $+$ that f_1 and f_2 are even skew fibrations;
- if $\mathcal{G} = \mathcal{G}_1 \rightarrow \mathcal{G}_2$, then we define $V_1 = \{v \in V_{\mathcal{H}} \mid f(v) \in \mathcal{G}_1\}$ and $V_2 = \{v \in V_{\mathcal{H}} \mid f(v) \in \mathcal{G}_2\}$. We have that $V_2 \neq \emptyset$ since f preserve d . If $V_1 = \emptyset$, then $f = \emptyset_{\mathcal{G}_1} \rightarrow f_2$ with $f_2 : \mathcal{H} \rightarrow \mathcal{G}_2$. Otherwise, $V_1 \neq \emptyset$ and \mathcal{H} cannot be a single vertex. Similarly, \mathcal{H} cannot be of the shape $\mathcal{H}_1 + \mathcal{H}_2$ otherwise f would not preserve \wedge , nor of the shape $v \rightsquigarrow \mathcal{H}_2$ otherwise f would not be modal. We conclude by Lemma 34 that $f = f_1 \rightarrow f_2$. Moreover, since f is an even skew fibration it follows that f_2 also preserves \wedge and satisfies skew lifting while f_1 preserve \vee and satisfies odd skew lifting.
- if $\mathcal{G} = v \rightsquigarrow \mathcal{G}_2$, we conclude by Lemma 35.

If $f^\bullet : \mathcal{H} \rightarrow \mathcal{G}$ is an odd skew fibration, then we proceed similarly. If \mathcal{G} is a single-vertex MA, then \mathcal{H} cannot be of the shape $\mathcal{H}_1 \rightsquigarrow \mathcal{H}_2$ otherwise f it would not be modal,

or of the shape $\mathcal{H}_1 \rightarrow \mathcal{H}_2$ otherwise it would not preserve d . Let $\mathcal{H} = \mathcal{H}_1 + \mathcal{H}_2$ such that $\mathcal{H}_1 \neq \mathcal{H}'_1 + \mathcal{H}''_1$. Since f^\bullet preserve d and \rightsquigarrow , then \mathcal{H}_1 is a single-vertex MA. Moreover, $f_2: \mathcal{H}_2 \rightarrow \mathcal{G}_2$ is an odd skew fibration by definition. Then $f = [1_v, f_2]$ with v the unique vertex in $V_{\mathcal{H}} = V_{\mathcal{G}}$;

If $\mathcal{G} = \mathcal{G}_1 + \mathcal{G}_2$, $\mathcal{G} = \mathcal{G}_1 \rightarrow \mathcal{G}_2$ or $\mathcal{G} = v \rightsquigarrow \mathcal{G}_2$ we apply a similar reasoning of the case of f even skew fibration. \square

Theorem 38. *Let H and H' be P-formulas. If there is a skew fibration $f: \llbracket H' \rrbracket \rightarrow \llbracket H \rrbracket$, then $H' \stackrel{\text{LI}}{\vdash} H$.*

Proof. By Lemma 37 we can decompose any skew fibration using the operations in Definition 36. In particular, each $\emptyset_{\mathcal{G}}$ occurring in the decomposition corresponds to an application of a $w_{\downarrow}^{\diamond}$, w_{\downarrow}^{\otimes} or $w_{\downarrow}^{-\circ}$, while each occurrence of $[-, -]$ corresponds to an application of a c_{\downarrow}^{\bullet} . We conclude by reconstructing a derivation in $\text{LI}_{\downarrow}^{\circ}$ using this decomposition and the correspondence between P-formulas and MAs (Theorem 14). \square

6 Combinatorial proof

Using the results of the previous sections, we are able to define combinatorial proofs for the logics CK and CD and prove sound and completeness results for them.

Definition 39. Let F be a formula and $X \in \{\text{CK}, \text{CD}\}$.

An *X-intuitionistic combinatorial proof* (or X-ICP) is a skew fibration $f: \mathcal{G} \rightarrow \llbracket F \rrbracket$ from an X-arena net \mathcal{G} to the modal arena of a formula F containing no occurrences of $\diamond \perp$.

In particular, *intuitionistic combinatorial proofs* (or ICPs) from [39] are the special cases where no modalities occur, that is, an ICP is a skew fibration $f: \mathcal{G} \rightarrow \llbracket F \rrbracket$ from an arena net \mathcal{G} to the arena of a modality-free formula F .

Theorem 40. *Let F be a formula and $X \in \{\text{CK}, \text{CD}\}$. Then*

$$\stackrel{\text{LX}}{\vdash} F \iff \text{there is an X-ICP } f: \mathcal{G} \rightarrow \llbracket F \rrbracket$$

Proof. By Theorem 4 there is a P-formula H such that $F = \lfloor H \rfloor$ and $\stackrel{\text{LX}}{\vdash} F$ iff $\stackrel{\text{IMLL-X}^{\circ}}{\vdash} H' \stackrel{\text{LI}}{\vdash} H$ for a P-formula H' . By Theorem 38 we have that $H' \stackrel{\text{LI}}{\vdash} H$ iff there is a skew fibration $f: \llbracket H' \rrbracket \rightarrow \llbracket H \rrbracket$. We conclude by Theorem 22 since by Theorem 3 we have $\stackrel{\text{IMLL-CK}^{\circ}}{\vdash} H' \iff \stackrel{\text{IMLL-X}}{\vdash} \lfloor H' \rfloor$. \square

Lemma 41. *Let $X \in \{\text{CK}, \text{CD}\}$. If \mathcal{H} and \mathcal{G} are 2-dags and $f: V_{\mathcal{H}} \rightarrow V_{\mathcal{G}}$, then it can be checked in polynomial time (in the size of $\mathcal{H} \cup \mathcal{G}$) if f is a X-ICP.*

Proof. All the following checks can be done in polynomial time: that a 2-dag \mathcal{G} is an MA; that an MA is a K- or D-arena net; and that a map between two MAs is a skew fibration. \square

Corollary 42. *Let $X \in \{\text{CK}, \text{CD}\}$. Then the X-ICPs form a sound and complete proof system in the sense of Cook and Reckhow [11].*

7 Winning Strategies

In this section we provide the definition of winning strategies for a two-player game on a modal arena $\llbracket F \rrbracket$, and we show the correspondence between these strategies and CK and CD proofs of F .

Definition 43. Let \mathcal{G} be a MA. A *move* is a vertex of \mathcal{G} . Let $\mathbf{p} = p_0, \dots, p_n$ be a sequence of distinct *moves* (we denote by ϵ the empty sequence). If v and w are two moves in \mathbf{p} , we say that a vertex w *justifies* v whenever $v \xrightarrow{\mathcal{G}} w$. We call a move p_i in \mathbf{p} a \circ -*move* or \bullet -*move* if i is respectively even or odd. We say that \mathbf{p} is a *view* if the following conditions are fulfilled:

- \mathbf{p} is a *play*: if $\mathbf{p} \neq \epsilon$, then $p_0 \in \vec{R}_{\mathcal{G}}$;
- \mathbf{p} is *justified*: if $i > 0$, then $p_i \rightarrow p_j$ for some $j < i$;
- \mathbf{p} is \circ -*shortsighted*: if p_{i+1}° and p_i^\bullet , then $p_{i+1} \rightarrow p_i$;
- \mathbf{p} is \bullet -*uniform*: if p_{i+1}^\bullet and p_i° , then $\ell(p_{i+1}) = \ell(p_i)$.
- \mathbf{p} is *modal*: $p_i \in V^{\mathcal{A}} \cup V^\circ$.

The *predecessor* of a non-empty view \mathbf{p} is the sequence obtained by removing the last move in \mathbf{p} . The *successor* is the converse relation. A *winning innocent strategy* (or *WIS*) on \mathcal{G} is a finite predecessor-closed set \mathcal{S} of views in \mathcal{G} such that:

- \mathcal{S} and \circ -*complete*: if $\mathbf{p} \in \mathcal{S}$ has even length, then every successor of \mathbf{p} is in \mathcal{S} ;
- \mathcal{S} is *deterministic* and *total*: if $\mathbf{p} \in \mathcal{S}$ has odd length, then exactly one successors of \mathbf{p} is in \mathcal{S} ;
- \mathcal{S} is \diamond -*complete*: if $v^\circ \in V_{\mathcal{G}}^\circ$ occurs in \mathcal{S} , then $\tilde{\mathcal{C}}(v) \neq \emptyset$ and each w such that $v \rightsquigarrow w$ occurs in \mathcal{S} .

We say that a WIS \mathcal{S} is *atomic* if $p_i \in V_{\mathcal{G}}^{\mathcal{A}}$ for every $\mathbf{p} \in \mathcal{S}$.

Remark 44. Our definition of WIS restricted to (non-modal) arenas is the same as the one in the literature, or simply a reformulation in our setting (see e.g. [34] or [39]).

By means of example consider the strategy with maximal views shown in Figure 1. We remark that the totality and \circ -completeness of this strategy is guaranteed by the fact that the modal arena net is linked.

Definition 45. Let $X \in \{\text{CK}, \text{CD}\}$ and \mathcal{G} be an X -arena net. A *framed abstract view* of \mathcal{G} is a reverse checked path on $\tilde{\mathcal{G}}$.

We denote by $\llbracket \mathbf{p} \rrbracket$ the sequence of moves in \mathcal{G} obtained by removing from a play \mathbf{p} all modal vertices. For example if $\mathbf{p} = \square uv \square \diamond w$, then $\llbracket \mathbf{p} \rrbracket = uvw$.

An *abstract view* $\tilde{\mathbf{p}}$ in \mathcal{G} is a sequence of atomic vertices in \mathcal{G} defined as follows:

- either $\tilde{\mathbf{p}} = \llbracket \mathbf{p} \rrbracket$ for a framed abstract view \mathbf{p} of \mathcal{G} ;
- or $\tilde{\mathbf{p}} = \llbracket s_1 \rrbracket v_1 w_1 \llbracket s_3 \rrbracket \dots \llbracket s_{2k-1} \rrbracket v_k w_k \llbracket s_{2k+1} \rrbracket$ for a framed abstract view $\mathbf{p} = s_1 v_1 s_2 w_1 s_3 \dots s_{2k-1} v_k s_{2k} w_k p_{2k+1}$ of \mathcal{G} with $v_i, w_i \in V^\circ$ such that $v_i \rightarrow w_i$ for all $i \in \{0, \dots, k\}$;

Note that by definition, an abstract view of a non-modal arena net is a reverse path in \mathcal{G} .

We recall the result on ICPs from [39] which we aim to extend CK-ICPs and CD-ICPs in this section.

Theorem 46 ([39]). *If $f : \mathcal{G} \rightarrow \llbracket F \rrbracket$ is an ICP of a modality-free formula F , then the set of images of all abstract views of \mathcal{G} is a WIS on $\llbracket F \rrbracket$.*

For this purpose, we define *frames* as equivalence classes of modal vertices in the arena induced by the views. They are meant to reconstruct the information about the applications of modal axioms, that are, the \sim -equivalence classes of the modal arena net of the ICP. This information allows us to “de-contract” the formula F in such a way to obtain a formula F' which admits a linear derivation.

Let $\mathcal{G} = \llbracket F \rrbracket$ be a MA. The *address* of a vertex in $v \in V_{\mathcal{G}}$ is the unique (possibly empty) sequence of modal vertices $\text{add}_v = m_1 \cdots m_k$ such that $m_0 = v$ and $m_i = m_{i-1} \neq m_{i-1}$ for each $i \in \{1, \dots, k\}$. Intuitively, the address of a vertex v is the list of the modalities in the path the node corresponding to v to the root of the formula tree \mathcal{T}_F . We denote by $h_v = |\text{add}_v|$ and add_v^h the h^{th} element m_h in add_v . If \mathfrak{p} is a view, we write $h_{\mathfrak{p}} = \max\{h_v \mid v \in \mathfrak{p}\}$. Moreover, if \mathcal{S} is a strategy on \mathcal{G} , we say that $v \in V_{\mathcal{G}}$ is *involved* in \mathcal{S} if either $v \in \mathfrak{p}$ or if $v \in \text{add}_{\mathfrak{p}_i}$ for a view $\mathfrak{p} \in \mathcal{S}$.

Definition 47. Let $\mathfrak{p} = \mathfrak{p}_1 \cdots \mathfrak{p}_n$ be a view on a MA \mathcal{G} .

We say that \mathfrak{p} is *well-framed* if $|\text{add}_{\mathfrak{p}_{2k}}| = |\text{add}_{\mathfrak{p}_{2k+1}}|$ for every even $2k \in \{0, \dots, n-1\}$. A strategy is *well-framed* if each view in it is.

If \mathfrak{p} is well-framed, then we define its *framed view* as the $h_{\mathfrak{p}} \times n$ matrix $\mathcal{F}(\mathfrak{p}) = (\mathcal{F}(\mathfrak{p})_0, \dots, \mathcal{F}(\mathfrak{p})_n)$ with elements in $V_{\mathcal{G}} \cup \{\epsilon\}$ such that each column $\mathcal{F}(\mathfrak{p})_i$ is defined as follows:

$$\mathcal{F}(\mathfrak{p}) = \begin{pmatrix} \mathcal{F}(\mathfrak{p})_i^{h_{\mathfrak{p}}} & = & \text{add}_{\mathfrak{p}_i}^{h_{\mathfrak{p}}} \\ & \vdots & \\ \mathcal{F}(\mathfrak{p})_i^{h_i+1} & = & \text{add}_{\mathfrak{p}_i}^1 \\ \mathcal{F}(\mathfrak{p})_i^{h_i} & = & \epsilon \\ & \vdots & \\ \mathcal{F}(\mathfrak{p})_i^1 & = & \epsilon \\ \mathcal{F}(\mathfrak{p})_i^0 & = & \mathfrak{p}_i \end{pmatrix}$$

where a $h_i \in \{0, \dots, h_{\mathfrak{p}}\}$ defined for each $i \in \{0, \dots, n\}$.

Moreover, each $\mathcal{F}(\mathfrak{p})$ induces an equivalence relation $\overset{\mathcal{G}_{\mathfrak{p}}}{\sim}$ over $V_{\mathcal{G}}$ given by the symmetric, transitive, and reflexive closure of the following relations:

$$u \overset{\mathcal{G}_{\mathfrak{p}}}{\sim} w \quad \text{iff} \quad \begin{array}{l} u = \mathcal{F}(\mathfrak{p})_{2k}^h \text{ and } w = \mathcal{F}(\mathfrak{p})_{2k+1}^h \\ \text{for a } 2k < n \text{ and a } h \leq h_{\mathfrak{p}} \end{array}$$

We write $\text{add}_v \overset{\mathcal{G}_{\mathfrak{p}}}{\sim} \text{add}_w$ if v and w are involved in \mathfrak{p} and $\text{add}_v^k \overset{\mathcal{G}_{\mathfrak{p}}}{\sim} \text{add}_w^k$ for all k .

Lemma 48. *Let \mathcal{G} be a MA, \mathfrak{p} be a well-framed view on \mathcal{G} , and $v, w \in V_{\mathcal{G}}$. If $v \overset{\mathcal{G}_{\mathfrak{p}}}{\sim} w$, then there are some $i, j \in \{0, \dots, n\}$ and a $k \in \{0, \dots, h_{\mathfrak{p}}\}$ such that $v = \mathcal{F}(\mathfrak{p})_i^k$ and $w = \mathcal{F}(\mathfrak{p})_j^k$. Moreover, for any $h > k$ we have $\mathcal{F}(\mathfrak{p})_i^h \overset{\mathcal{G}_{\mathfrak{p}}}{\sim} \mathcal{F}(\mathfrak{p})_j^h$.*

Proof. Let us write \sim instead of $\overset{\mathcal{G}^p}{\sim}$. If $v \sim w$, then by definition there are $i, j, k \in \mathbb{N}$ such that $v = \mathcal{F}(p)_i^k$ and $w = \mathcal{F}(p)_j^k$. To prove that $\mathcal{F}(p)_i^h \sim \mathcal{F}(p)_j^h$ for all $h \geq k$, we assume w.l.o.g. that $j \geq i$ and we proceed by induction on $n = j - i$. If $n = 0$, then the statement trivially holds since $i = j$ and \sim is reflexive. If $n > 0$, we make case analysis on the parity of j . If j is odd, then $\mathcal{F}(p)_j^h \sim \mathcal{F}(p)_{j-1}^h$ for all $h \geq k$ by definition of \sim . By transitivity of \sim we have $\mathcal{F}(p)_{j-1}^h \sim \mathcal{F}(p)_i^h$. We conclude by inductive hypothesis since $(j-1) - i < n$. If j is even, then $\mathcal{F}(p)_j^k \sim \mathcal{F}(p)_{j-1}^k$ if and only if either $\mathcal{F}(p)_j^k = \mathcal{F}(p)_{j-1}^k$ or $\mathcal{F}(p)_j^k \sim \mathcal{F}(p)_{j+m}^k$ for a $m > 0$ such that $\mathcal{F}(p)_{j+m}^k = \mathcal{F}(p)_{j'}^k$ for a $j' < j$. In the first case we conclude by inductive hypothesis since $\mathcal{F}(p)_j^h = \mathcal{F}(p)_{j-1}^h$ for all $h > k$, and therefore $\mathcal{F}(p)_j^h \sim \mathcal{F}(p)_{j-1}^h$. In the second case we conclude by inductive hypothesis since $j' < j$. \square

Definition 49. Let \mathcal{S} be a well-framed strategy on a MA \mathcal{G} . We say that \mathcal{S} is *linked* if for every $p \in \mathcal{S}$ the $\overset{\mathcal{G}^p}{\sim}$ -classes are of the shape $\{v_1^*, \dots, v_n^*, w^\circ\}$. This induces an edge-relation $u \overset{\mathcal{G}^s}{\sim} w = \{u \overset{\mathcal{G}^p}{\sim} w^\circ \mid p \in \mathcal{S}\}$.

A *CK-framed* strategy on a MA \mathcal{G} is a well-framed linked strategy \mathcal{S} such that for each $w^\circ \in V_{\mathcal{G}}^{\circ}$ involved in \mathcal{S} the following conditions are fulfilled:

1. if $w \in V_{\mathcal{G}}^{\circ}$, then $v \in V_{\mathcal{G}}^{\circ}$ for any $v \overset{\mathcal{G}^s}{\sim} w$;
2. if $w \in V_{\mathcal{G}}^{\circ}$, then $v \in V_{\mathcal{G}}^{\circ}$ for a unique v such that $v \overset{\mathcal{G}^s}{\sim} w$.

A *CD-framed* strategy on a MA \mathcal{G} is a well-framed linked atomic strategy \mathcal{S} such that for each $w^\circ \in V_{\mathcal{G}}^{\circ}$ involved in \mathcal{S} , it satisfies Condition 1 plus the following

3. if $w \in V_{\mathcal{G}}^{\circ}$, then $v \in V_{\mathcal{G}}^{\circ}$ for at most one v such that $v \overset{\mathcal{G}^s}{\sim} w$.

For $X \in \{\text{CK}, \text{CD}\}$, we say that \mathcal{S} is a *X-WIS* if it is a *X-framed WIS*.

Example 50. Let us consider the two non CK-provable formulas $F = \Box a_1 \supset a_0$ and $F' = (\Box a_2 \supset \Box b_1) \supset \Box(a_3 \supset b_0)$ where we enumerate occurrences of the same atom to improve readability.

The unique view on $\llbracket F \rrbracket$ is $a_0^\circ a_1^\circ$. Since $\text{add}_{a_0} = \epsilon$ and $|\text{add}_{a_1}| = 1$, we conclude that any strategy on $\llbracket F \rrbracket$ is not well-framed.

Similarly, the unique maximal view on $\llbracket F' \rrbracket$ is $b_0^\circ b_1^\circ a_2^\circ a_3^\circ$. This view is well-framed. However its frame contains all three modalities of the formula, two of which are \circ ; Hence any strategy on $\llbracket F' \rrbracket$ would not be CK-framed

As consequence of Lemma 48 we have the following result

Corollary 51 (Functoriality). *Let \mathcal{S} is a well-framed strategy on a MA \mathcal{G} . If $v, w \in V_{\mathcal{G}}$ and $v \overset{\mathcal{G}^p}{\sim} w$, then $\text{add}_v \overset{\mathcal{G}^p}{\sim} \text{add}_w$.*

The rest of this section is devoted to show how to use X-ICP to expose the correspondence between X-WISs and proof in CX for $X \in \{\text{CK}, \text{CD}\}$. Since X-ICPs are sound and complete (see Theorem 40), it is easy to show that we can associate to any proof a X-WIS using the following lemma:

Lemma 52. *Let $X \in \{\text{CK}, \text{CD}\}$. If $f : \mathcal{G} \rightarrow \llbracket F \rrbracket$ is a X -ICP of a formula F , then the image by f of all abstract views of \mathcal{G} is a X -WIS on $\llbracket F \rrbracket$.*

Proof. The image by f of an abstract view is a play and it is \circ -shortsighted since f preserves d and if $v, w \in V_{\mathcal{G}}^{\mathcal{A}}$, then $v \rightarrow w$ in $\widehat{\mathcal{G}}$ only if $v \rightarrow_{\bullet} w$. Moreover, in a modal arena if $v \lesssim w$ and $v, w \in V_{\mathcal{G}}^{\mathcal{A}}$, then $\ell(v) = \ell(w)$. We deduce that f is \bullet -uniform since f also preserves ℓ . Hence the image by f of an abstract views on \mathcal{G} is a view on $\llbracket F \rrbracket$.

Since for any abstract view \mathfrak{p} on \mathcal{G} we have that $\mathfrak{p}_{2k+1} = v_{2k+1} \stackrel{\mathcal{G}}{\sim} v_{2k} = \mathfrak{p}_{2k}$, then by functoriality of \mathcal{G} (Condition 3 in Definition 19), we have $\hat{v}_{2k+1} \stackrel{\mathcal{G}}{\sim} \hat{v}_{2k}$. This allows us to conclude by induction that $h_{v_{2k}} = h_{v_{2k+1}}$ in \mathcal{G} , i.e., \mathfrak{p} is well-framed view since since f is modal and preserves \rightsquigarrow .

The \circ -completeness follows by definition of $\rightarrow_{\bullet} \cup \rightsquigarrow_{\theta}$. Determinism of the strategy follows by the fact that $\widehat{\mathcal{G}}$ is X -correct, then

- if $X = \text{CK}$, then for every $w^{\circ} \in V^{\mathcal{A}} \cup V^{\circ}$ there is a unique vertex⁴ v^{\bullet} such that $v^{\bullet} \rightarrow w^{\circ}$. Moreover in this case \diamond -completeness follows the non-empty modalities Conditions 4;
- and if $X = \text{CD}$, then \mathcal{S} is atomic and atomic vertices are paired in \sim -classes. Moreover in this case \diamond -completeness is valid since no \diamond occurs in \mathcal{S} .

We conclude since by definition $\widehat{\mathcal{G}}$ is linked and X -correct; thereby \mathcal{S} is X -framed. \square

To prove that each X -WIS correspond to a proof in CX , we give a procedure to define an X -ICP $f : \mathcal{G} \rightarrow \llbracket F \rrbracket$ using the information provided by the arena $\llbracket F \rrbracket$ and the strategy \mathcal{S} . Using the property of being well-framed, we are able to reconstruct some paths on $\llbracket F \rrbracket$ which should be the images by the skew fibration f of the framed abstract views in the modal arena net \mathcal{G} .

Definition 53. Let \mathfrak{p} be a well-framed view on a MA \mathcal{G} of length n . We define the *pre-view* of \mathfrak{p} as the sequence of vertices in \mathcal{G}

$$\begin{aligned} \tilde{\mathfrak{p}} &= \tilde{\mathfrak{p}}_0, \tilde{\mathfrak{p}}_2, \tilde{\mathfrak{p}}_4, \dots, \tilde{\mathfrak{p}}_{2k} && \text{if } n \text{ is even} \\ \tilde{\mathfrak{p}} &= \tilde{\mathfrak{p}}_0, \tilde{\mathfrak{p}}_2, \tilde{\mathfrak{p}}_4, \dots, \tilde{\mathfrak{p}}_{2k}, \tilde{\mathfrak{p}}_{2k+1} && \text{if } n \text{ is odd} \end{aligned}$$

where for all $i \in \{1, \dots, k\}$ we have

$$\begin{aligned} \tilde{\mathfrak{p}}_0 &= \mathcal{F}(\mathfrak{p})_0^{h_{\mathfrak{p}}}, \dots, \mathcal{F}(\mathfrak{p})_0^0 \\ \tilde{\mathfrak{p}}_{2i} &= \mathcal{F}(\mathfrak{p})_{2i-1}^0 \dots \mathcal{F}(\mathfrak{p})_{2i-1}^{h_i} \mathcal{F}(\mathfrak{p})_{2i}^{h_i} \dots \mathcal{F}(\mathfrak{p})_{2i}^0 \\ \tilde{\mathfrak{p}}_{2k+1} &= \mathcal{F}(\mathfrak{p})_{2k+1}^0, \dots, \mathcal{F}(\mathfrak{p})_{2k+1}^{h_{\mathfrak{p}}} \end{aligned}$$

for a $h_i = \max\{h \mid \mathcal{F}(\mathfrak{p})_{2i-1}^h \stackrel{\mathcal{G}_S}{\sim} \mathcal{F}(\mathfrak{p})_{2i}^h\}$ if $\text{add}_{\mathfrak{p}_{2i+1}} \stackrel{\mathcal{G}_S}{\sim} \text{add}_{\mathfrak{p}_{2i}}$ and $h_i = 0$ otherwise. We denote by $\tilde{\mathcal{S}}$ the set of the pre-views of all the views in \mathcal{S} , that is, $\tilde{\mathcal{S}} = \{\tilde{\mathfrak{p}} \mid \mathfrak{p} \in \mathcal{S}\}$.

A *unchecked prefix* of a $\tilde{\mathfrak{p}} \in \tilde{\mathcal{S}}$ is a sequence of vertices s^{\downarrow} obtained by replacing in a prefix s of $\tilde{\mathfrak{p}}$ each subsequence of the form vrw with vw whenever $v \stackrel{\mathcal{G}_S}{\sim} w$.

⁴Observe that this is not true for \square -vertices.

Example 54. Let us consider the maximal views on the modal arena of $\Box_1(b_1 \supset b_0) \supset a_1 \supset (\Diamond_1 c \supset \Diamond_0(a_2 \wedge a_0))$ from Figure 1. From the leftmost and central views we respectively define the pre-views $\Diamond_0^\circ a_0^\circ a_1^\bullet b_0^\circ b_1^\bullet \Box_1^\bullet$ and $\Diamond_0^\circ a_2^\circ a_1^\bullet b_0^\circ b_1^\bullet \Box_1^\bullet$. In particular, the sequence $\Diamond_0 \Box_1$ is the unique unchecked prefix associated to these two sequences.

Given an arena $\llbracket F \rrbracket$ and a X-WIS \mathcal{S} and following this intuition, we reconstruct a partitioned modal arena $\mathcal{G}_\mathcal{S}$ and a map $f_\mathcal{S}$ from its vertices to the ones in $\llbracket F \rrbracket$ as follows.

Definition 55. Let $X \in \{\text{CK}, \text{CD}\}$ and \mathcal{S} be a X-WIS on $\llbracket F \rrbracket$. We define an arena $\mathcal{G}_\mathcal{S} = \langle V_\mathcal{G}, \xrightarrow{\mathcal{G}}, \rightsquigarrow^{\mathcal{G}}, \overset{\mathcal{G}}{\sim} \rangle$ and a map $f_\mathcal{S} = f : V_\mathcal{G} \rightarrow \llbracket F \rrbracket$ as follows:

- in $V_\mathcal{G}$ there is one vertex for each non-empty unchecked prefix s^\perp of a pre-view $\tilde{\mathfrak{p}} \in \tilde{\mathcal{S}}$ (whose label is the same of the last vertex in s^\perp). That is,

$$V_\mathcal{G} = \{v_s \mid s \text{ is a non-empty unchecked prefix of a } \tilde{\mathfrak{p}} \in \tilde{\mathcal{S}}\} \quad (6)$$

$$\ell(v_{s'w}) = \ell(w) \quad (7)$$

- by definition every vertex is of the form v_s for a non-empty sequence s of vertices in $V_{\llbracket F \rrbracket}$. We define the map $f : V_\mathcal{G} \rightarrow V_{\llbracket F \rrbracket}$ in such a way it maps each $v_s \in V_\mathcal{G}$ to the last vertex of $s = s'w$. That is,

$$f(v_{s'w}) = w \quad (8)$$

- there is an edge $v \xrightarrow{\mathcal{G}} w$ whenever $f(v) \xrightarrow{\llbracket F \rrbracket} f(w)$, and the images of v and w occur in the addresses or are respectively some vertices x and y such that either x° and y^\bullet occur in a same view in \mathcal{S} , or there is $s \in \mathcal{S}$ such that sy° and sux^\bullet occur in \mathcal{S} . That is,

$$\xrightarrow{\mathcal{G}} = \left\{ v \rightarrow w \mid \begin{array}{l} f(v) \rightarrow f(w) \text{ and there are } x, y \in V_{\llbracket F \rrbracket} \text{ such that} \\ f(v) = x \text{ or } f(v) \in \text{add}_x, f(w) = y \text{ or } f(w) \in \text{add}_y \\ \text{and either } sy^\bullet x^\circ, \text{ or both } sy^\circ \text{ and } sux^\bullet \text{ are in } \mathcal{S} \end{array} \right\} \quad (9)$$

- there is an edge $v \rightsquigarrow^{\mathcal{G}} w$ whenever $f(v) \xrightarrow{\llbracket F \rrbracket} f(w)$, and v and w occur in a same pre-view in $\tilde{\mathcal{S}}$. That is,

$$\rightsquigarrow^{\mathcal{G}} = \{v \rightsquigarrow w \mid f(v) \xrightarrow{\llbracket F \rrbracket} f(w) \text{ and } f(v), f(w) \in \tilde{\mathfrak{p}} \text{ for a } \mathfrak{p} \in \mathcal{S}\} \quad (10)$$

- we define $v \overset{\mathcal{G}}{\sim} w$ as the symmetric and transitive closure of the edge-relation $\xrightarrow{\llbracket F \rrbracket}_\mathcal{S}$. That is,

$$\overset{\mathcal{G}}{\sim} = \{v \rightarrow w \mid f(v) \xrightarrow{\llbracket F \rrbracket}_\mathfrak{p}^* f(w) \text{ for a } \mathfrak{p} \in \mathcal{S}\} \quad (11)$$

Remark 56. By definition $\llbracket F \rrbracket_{\mathcal{S}} \sim = \bigcup_{p \in \mathcal{S}} \llbracket F \rrbracket_p \sim$ is not an equivalence relation over $\llbracket F \rrbracket$.

In fact in $\llbracket F \rrbracket$ we may have some vertices u, v and w such that $u \xrightarrow{\llbracket F \rrbracket_{\mathcal{S}}} v$ and $u \xrightarrow{\llbracket F \rrbracket_{\mathcal{S}}} w$ and $v \not\sim_{\llbracket F \rrbracket_{\mathcal{S}}} w$.

If we additionally assume that \mathcal{S} is linked, then we conclude that $u \xrightarrow{\llbracket F \rrbracket_{p_1}} v$ and $u \xrightarrow{\llbracket F \rrbracket_{p_2}} w$ for two distinct $p_1, p_2 \in \mathcal{S}$. Hence, the vertex u in $\llbracket F \rrbracket$ admits at least two different pre-images in \mathcal{G} . Then we conclude, as the homonymy suggests, that $\mathcal{G}_{\mathcal{S}}$ is a linked modal arena.

Remark 57. By definition of \rightsquigarrow , we have that $v \rightsquigarrow_{\mathcal{G}_{\mathcal{S}}} w$ iff $v \rightsquigarrow w$ and $v = \tilde{p}_i$ and $w = \tilde{p}_j$ for a $i > j$. That is, any pre-view is a reverse cautious path on $\tilde{\mathcal{G}}_{\mathcal{S}}$, that is, a framed abstract view. It follows that the abstract view which can be extract from a pre-view \tilde{p} of a $p \in \mathcal{S}$ is exactly the view p . In other words, the function mapping a view in its pre-view is the left adjoint of the function mapping a framed abstract view to its associated abstract view.

Hence, by proving that $f_{\mathcal{S}}$ is an X-ICPs we can prove that we can associate a proof in CX to any X-WIS.

Lemma 58. *Let $X \in \{\text{CK}, \text{CD}\}$ If F is a formula and \mathcal{S} a X-WIS on $\llbracket F \rrbracket$, then there is a X-ICP $f: \mathcal{G} \rightarrow \llbracket F \rrbracket$.*

Proof. We only prove the result for CK since the proof for CD is similar but easier since CD-WISs are atomic.

We use Definition 55 to define an X-ICP $f_{\mathcal{S}}: \mathcal{G}_{\mathcal{S}} \rightarrow \llbracket F \rrbracket$ from \mathcal{S} and $\llbracket F \rrbracket$. That is, we prove that the map $f_{\mathcal{S}}$ and the modal arena $\mathcal{G}_{\mathcal{S}}$ defined in Definition 55 are respectively a skew fibration and, whenever \mathcal{S} is CX-framed, an X-arena net.

The arena \mathcal{G} is linked by definition of \mathcal{G} as remarked in Remark 56. To conclude that \mathcal{G} is a CK-arena net we have to check the following conditions:

1. $\tilde{\mathcal{G}}$ is acyclic: if a checked path contains a cycle, then we can define a framed abstract view for any number of iterations of this cycle. Then \mathcal{S} should contains infinite views corresponding of the image through f of infinite abstract views on \mathcal{G} . Absurd.
2. $\tilde{\mathcal{G}}$ is functional: for any \tilde{p}_i^{\bullet} there is a $k \leq i$ such that $\tilde{p}_k = p_h$ occurs in p and either $k = i$ or $\tilde{p}_i \rightsquigarrow_{\mathcal{G}} \tilde{p}_k$. Since p is justified, then there is $l < h$ such that $p_h \rightarrow p_l$. Then there is $j < i$ such that $\tilde{p}_j = p_l$. By the fact that \rightsquigarrow is modal (see Definition 9), we conclude that $\tilde{p}_i \xrightarrow{\mathcal{G}} \tilde{p}_j$.
3. $\tilde{\mathcal{G}}$ is functorial: it follows Corollary 51;
4. $\tilde{\mathcal{G}}$ has almost all non-empty modalities: let $v \in V_{\mathcal{G}}^{\square}$ such that $v = v_s$ for a prefix $s = s' \mathcal{F}(p)_{2k}^h$ of a $\tilde{p} \in \tilde{\mathcal{S}}$. If $v \in V^{\square}$, then $h > 0$ (since no \square occurs in a abstract view) and there is $w = w_{s''}$ such that $v \rightsquigarrow_{\mathcal{G}} w$ such that either $s'' = s' \mathcal{F}(p)_{2k}^h \mathcal{F}(p)_{2k}^{h-1}$ if v° , or $s'' = s'$ if $v^{\bullet} \in V_{\mathcal{G}}^{\square}$. If $v^{\circ} \in V^{\circ}$, then we conclude by \diamond -completeness.

5. $\widehat{\mathcal{G}}$ is CK-correct: it follows from the fact that \mathcal{S} is CK-framed and that, by definition, $\underline{\mathcal{G}} = \underline{\mathcal{G}^s}$.

The map f is a skew fibration we have to check the following conditions:

- f preserves ℓ , \rightarrow , and \rightsquigarrow : by definition;
- f preserves d : since f preserves $\xrightarrow{\mathcal{G}}$, then $d(v) \geq d(f(v))$. If $d(v) > d(f(v))$ then there should be a w such that $f(v) \rightarrow w$ and $d(w) \geq d(f(v))$ which by Lemma 7, implies that $\llbracket F \rrbracket$ is not L-free. Contradiction;
- f is modal: if $f(v) \rightsquigarrow f(w)$, then by definition there is a k such that $\text{add}_{f(w)}^k = f(v)$. We conclude by letting $v' = \text{add}_w^k$.
- f preserves \wedge : it follows from the fact that f preserves \rightarrow and d ;
- f has the skew lifting property: we let $w \in V_{\llbracket F \rrbracket}$ such that $w \wedge f(v)$ for a $v \in V_{\mathcal{G}}$ and we prove that there is always a u such that $v \wedge u$ and $f(u) \not\wedge w$.

If there is no meeting point of w and $f(v)$, then we conclude by letting $u \in \vec{R}_{\mathcal{G}}$ such that $u \wedge v$ and $w \rightarrow^* f(u)$.

Otherwise, we let x^\bullet (hence $x \notin \vec{R}_{\llbracket F \rrbracket}$) be a meeting point of w and $f(v)$. By Lemma 10 can assume w.l.o.g. that $x \in V_{\llbracket F \rrbracket}^{\mathcal{A}}$. Moreover, we can also assume that x is in the image of f . In fact, since the meeting point exists, then there is a r° (at least one $r \in \vec{R}_{\llbracket F \rrbracket}$) such that $w \rightarrow^n r$ and $f(v) \rightarrow^m r$; we can assume $r \in V^{\mathcal{A}}$ and by determinism of \mathcal{S} we have a $z \in V^{\mathcal{A}}$ in the image of f such that $z \rightarrow r$; thus by Lemma 7 either z is the meeting point, or for all $r' \in V^{\mathcal{A}}$ such that $r' \rightarrow z$, r' is in the image of f since \mathcal{S} is total and \circ -complete; we conclude by induction.

We can deduce that $sx \in \mathcal{S}$ for a $s \in \mathcal{S}$. We now let y such that $w \rightarrow^* y \rightarrow x$. Since $sx \in \mathcal{S}$ and x^\bullet , then by \circ -completeness we have $sxy \in \mathcal{S}$ for every $y \in V^{\mathcal{A}}$ such that $y \rightarrow x$; thus $f(u) = y$ for a $u = v_{sxy} \in V_{\mathcal{G}}$. We conclude since the meeting point of w and $f(u)$ is $f(u) = y^\circ$ and the meeting point of $f(u)$ and $f(v)$ is x^\bullet .

□

We are able to prove a soundness and completeness result for X-WISs.

Theorem 59. *Let F be a formula and $X \in \{\text{CK}, \text{CD}\}$.*

$$F \text{ is provable in CX} \iff \text{there is a X-WIS on } \llbracket F \rrbracket.$$

Proof. By Theorem 40 we know that X-ICPs are a sound and complete proof system for LX. We conclude the proof using Lemmas 52 and 58 which state the correspondence between X-ICPs of a formula F and X-WIS on $\llbracket F \rrbracket$. □

8 Conclusions and Future Works

In this paper we present two semantics for proofs of the disjunction-free and unit-free fragment of the constructive modal logics CK and CD.

The first semantics is given by extending the syntax of ICPs from [39] by reshaping some techniques from the previous work on combinatorial proofs for modal logic [5] to fit with the syntax required to capture intuitionistic logic. We define MAs which extend the syntax of a Hyland-Ong arena [34] in order to represent modal formulas by finite directed graphs, and we define modal arena nets which are MAs equipped with a vertex partition capturing axioms in CK and CD. Then we prove that skew fibrations from a modal arena net to the arena of a formula are sound and complete with respect to the logics CK and CD.

The second semantics is given in terms of winning innocent strategies over modal arenas. It has been designed by extending the relation between ICPs and winning strategies shown in [39]: the set of paths in the linking graph of the arena net of the ICP is mapped by the skew fibration to a winning innocent strategy on the formula arena. This relation has been further refined by showing that for CK and CD it is possible to restrict this set of paths to specific ones passing on atoms and diamonds only.

We get the following result for our two new semantics:

Theorem 60 (Full completeness). *Let F be a formula and $X \in \{\text{CK}, \text{CD}\}$. Then*

1. *There is a surjection from the set of factorised proofs of F and the set X -ICPs of F .*
2. *There is a surjection from the set of X -ICPs of F and the set of X -WISs on $\llbracket F \rrbracket$.*
3. *There is a surjection from the set of LX -derivations of F and the set of X -WISs on $\llbracket F \rrbracket$.*

Proof. 1. The proofs of Theorem 22 and Theorem 38 allow to establish full maps respectively from $\text{IMLL-}X$ -derivations to X -arena nets, and from LI_\perp° -derivations to skew fibrations. We conclude by composing these maps.

2. The proof of Lemma 52 establishes a map from the set of X -ICPs of F to the set of X -WISs on $\llbracket F \rrbracket$. The proof of Lemma 58 associates an X -ICP to an X -WIS S . As remarked in Remark 57, the image by f_S of the abstract views on the linking graph of the modal arena net \mathcal{G}_S defined in Definition 55 is exactly initial X -WIS S . We conclude since every X -WIS S on $\llbracket F \rrbracket$ is the image by f of the framed abstract views in the X -ICP $f_S: \mathcal{G}_S \rightarrow \llbracket F \rrbracket$.

3. Direct consequence of 1 and 2. □

We conclude by presenting some lines of inquiry that have been initiated by the content of this paper.

Game semantics for CK and CD.

We are currently investigating the compositionality of CK-WISs and CD-WISs in order to define the game semantics for these logics. It seems natural that the standard

definitions of canonical strategies of game semantics (e.g., copy-cat, projections and evaluation) can be employed in our framework. However, the additional condition on frames requires a careful investigation which goes beyond the scope of this paper.

Relation between λ -terms and winning strategies. For propositional intuitionistic logic the relation between λ -terms and WISs is well-known [26, 12, 22] The exact correspondence between our WISs and λ -terms for CK and CD [9] is under investigation, but out of the scope of this paper.

Proof equivalence in constructive modal logics.

Both ICPs and WISs induce a proof equivalence between proofs defined as “two derivations are equivalent iff they are represented by the same semantic object”.

We conjecture that, as proven in [39] for the intuitionistic combinatorial proofs for the logic LI, the combinatorial proofs presented in this paper capture the proof equivalence defined on sequent calculus by independent rules permutations, weakening/contraction-comonad, and excising, i.e., the permutation of weakening which removes subproofs shown below (see the permutation in the bottom-right corner of Figure 5).

$$\frac{\frac{\frac{\frac{\text{ax}}{\Gamma \vdash A} \text{W}}{\Gamma, A \supset B, \Delta \vdash C} \supset^L} \text{ax}}{\Gamma, \Delta \vdash C} \text{W}}{\Gamma, A \supset B, \Delta \vdash C} \text{W} \quad \rightsquigarrow_e \quad \frac{\text{ax}}{\Gamma, A \supset B, \Delta \vdash C} \text{W}$$

We also conjecture that the full completeness results can be stated with respect to all proofs of a formula, and not only the factorised ones.

However, in the presence of modalities, the proof of these results is much more involved (see Figure 5), and would go beyond the scope of this paper. Although, it is easy to see that whenever two sequent proofs are equivalent modulo rule permutations, they are mapped to the same combinatorial proof, the converse is far from trivial, in particular, it is not true in the classical case.

Moreover, an additional problem seems to arise for CK which is similar to the well-known “jump-problem” for multiplicative linear logic proof nets with units [19]: permutations of W may re-assign which \diamond is introduced by a specific K^\diamond as in the following example.

$$\frac{\frac{\frac{\frac{\text{ax}}{a \vdash a} \text{AX}}{\vdash a \supset a} \supset^R} \text{W}}{B \vdash a \supset a} \text{K}^\diamond} {\diamond B \vdash \diamond(a \supset a)} \text{W} \quad \neq \quad \frac{\frac{\frac{\frac{\text{ax}}{a \vdash a} \text{AX}}{\vdash a \supset a} \supset^R} \text{W}}{C \vdash a \supset a} \text{K}^\diamond} {\diamond C \vdash \diamond(a \supset a)} \text{W}$$

Winning strategies for linear logic

We foresee no difficulties in defining WISs for *elementary* and *light* linear logic adapting the techniques used for defining CPs for multiplicative and exponential linear logic in [2].

We can envisage an encoding of $!A$ of the form $v \rightsquigarrow \llbracket A \rrbracket$ for vertex v such that $\ell(v) = !$. This would avoid the need of defining the arena of $!A$ as the tensor of infinitely

many copies of A , that is $!A = A \otimes A \otimes \dots$, preventing the need of a quotient on WISs required to capture the natural isomorphism between the copies of A .

In particular, to recover the results of Murawski-Ong for light linear logic [34], it suffices to consider the modalities $!$ and \S as instances of \Box , to define a frame condition simplifying the one of CK-frames (since there are no \Diamond), and restrain skew-fibration allowing deep weakening and deep contraction only to $!$ -formulas using techniques similar to the ones in [2].

References

- [1] Samson Abramsky, Pasquale Malacaria, and Radha Jagadeesan. Full abstraction for pcf. In *International Symposium on Theoretical Aspects of Computer Software*, pages 1–15. Springer, 1994.
- [2] Matteo Acclavio. Exponentially handsome proof nets. (submitted for publications at the post proceedings of the Joint Workshop Linearity & TLLA).
- [3] Matteo Acclavio and Lutz Straßburger. From syntactic proofs to combinatorial proofs. In *International Joint Conference on Automated Reasoning*, pages 481–497. Springer, 2018.
- [4] Matteo Acclavio and Lutz Straßburger. On combinatorial proofs for logics of relevance and entailment. In *International Workshop on Logic, Language, Information, and Computation*, pages 1–16. Springer, 2019.
- [5] Matteo Acclavio and Lutz Straßburger. On combinatorial proofs for modal logic. In Serenella Cerrito and Andrei Popescu, editors, *Automated Reasoning with Analytic Tableaux and Related Methods*, pages 223–240, Cham, 2019. Springer International Publishing.
- [6] Ryuta Arisaka, Anupam Das, and Lutz Straßburger. On nested sequents for constructive modal logics. *Logical Methods in Computer Science*, 11, 2015.
- [7] Gianluigi Bellin, Valeria De Paiva, and Eike Ritter. Extended curry-howard correspondence for a basic constructive modal logic. In *Proceedings of Methods for Modalities*, 05 2001.
- [8] Ralph Benjamin and Lutz Straßburger. Towards a combinatorial proof theory. In *Tableaux 2019*. Springer, 2019.
- [9] Gavin M. Bierman and Valeria CV de Paiva. On an intuitionistic modal logic. *Studia Logica*, 65(3):383–416, 2000.
- [10] Kai Brünnler and Alwen Fernanto Tiu. A local system for classical logic. In R. Nieuwenhuis and A. Voronkov, editors, *LPAR 2001*, volume 2250 of *LNAI*, pages 347–361. Springer, 2001.
- [11] Stephen A. Cook and Robert A. Reckhow. The relative efficiency of propositional proof systems. *J. of Symb. Logic*, 44(1):36–50, 1979.

- [12] V. Danos, H. Herbelin, and L. Regnier. Game semantics and abstract machines. In *Proceedings of the 11th Annual IEEE Symposium on Logic in Computer Science, LICS '96*, page 394, USA, 1996. IEEE Computer Society.
- [13] Rowan Davies and Frank Pfenning. A modal analysis of staged computation. *Journal of the ACM (JACM)*, 48(3):555–604, 2001.
- [14] Matt Fairtlough and Michael Mendler. Propositional lax logic. *Information and Computation*, 137(1):1–33, 1997.
- [15] Frederic B Fitch. Intuitionistic modal logic with quantifiers. *Portugaliae mathematica*, 7(2):113–118, 1948.
- [16] Alessio Guglielmi. A system of interaction and structure. *ACM Transactions on Computational Logic*, 8(1):1–64, 2007.
- [17] Alessio Guglielmi, Tom Gundersen, and Michel Parigot. A Proof Calculus Which Reduces Syntactic Bureaucracy. In Christopher Lynch, editor, *Proceedings of the 21st International Conference on Rewriting Techniques and Applications*, volume 6 of *LIPICs*, pages 135–150, Dagstuhl, Germany, 2010. Schloss Dagstuhl–Leibniz-Zentrum fuer Informatik.
- [18] Alessio Guglielmi and Lutz Straßburger. Non-commutativity and MELL in the calculus of structures. In *CSL 2001*, volume 2142 of *LNCS*, pages 54–68. Springer, 2001.
- [19] Willem Heijltjes and Robin Houston. No proof nets for MLL with units: proof equivalence in MLL is PSPACE-complete. In Thomas A. Henzinger and Dale Miller, editors, *Joint Meeting of the Twenty-Third EACSL Annual Conference on Computer Science Logic (CSL) and the Twenty-Ninth Annual ACM/IEEE Symposium on Logic in Computer Science (LICS), CSL-LICS '14, Vienna, Austria, July 14 - 18, 2014*, pages 50:1–50:10. ACM, 2014.
- [20] Samuli Heilala and Brigitte Pientka. Bidirectional decision procedures for the intuitionistic propositional modal logic is4. In *International Conference on Automated Deduction*, pages 116–131. Springer, 2007.
- [21] Ross Horne, Ki Yung Ahn, Shang-wei Lin, and Alwen Tiu. Quasi-open bisimilarity with mismatch is intuitionistic. In *Proceedings of the 33rd Annual ACM/IEEE Symposium on Logic in Computer Science, LICS '18*, page 26–35, New York, NY, USA, 2018. Association for Computing Machinery.
- [22] D. Hughes. Games and definability for system F. In *Logic in Computer Science, Symposium on*, page 76, Los Alamitos, CA, USA, jul 1997. IEEE Computer Society.
- [23] Dominic Hughes. Proofs Without Syntax. *Annals of Math.*, 164(3):1065–1076, 2006.

- [24] Dominic Hughes. Towards Hilbert’s 24th problem: Combinatorial proof invariants: (preliminary version). *Electr. Notes Theor. Comput. Sci.*, 165:37–63, 2006.
- [25] Dominic J. D. Hughes. First-order proofs without syntax, June 2019.
- [26] J.M.E. Hyland and C.-H.L. Ong. On full abstraction for PCF: I, II, and III. *Information and Computation*, 163(2):285 – 408, 2000.
- [27] Kensuke Kojima. *Semantical study of intuitionistic modal logics*. PhD thesis, Kyoto University, 2012. Ph.D. thesis.
- [28] Roman Kuznets, Sonia Marin, and Lutz Straßburger. Justification logic for constructive modal logic. IMLA 2017 - 7th Workshop on Intuitionistic Modal Logic and Applications, July 2017.
- [29] François Lamarche. Proof Nets for Intuitionistic Linear Logic: Essential Nets, 2008.
- [30] Sonia Marin and Lutz Straßburger. Label-free Modular Systems for Classical and Intuitionistic Modal Logics. In *Advances in Modal Logic 10*, 2014.
- [31] Guy McCusker. Games and full abstraction for fpc. *Information and Computation*, 160(1):1 – 61, 2000.
- [32] Michael Mendler and Stephan Scheele. Cut-free gentzen calculus for multimodal ck. *Information and Computation*, 209(12):1465–1490, 2011.
- [33] John-Jules Meyer and Frank Veltmanw. Intelligent agents and common sense reasoning. In Patrick Blackburn, Johan Van Benthem, and Frank Wolter, editors, *Handbook of Modal Logic*, volume 3 of *Studies in Logic and Practical Reasoning*, pages 991 – 1029. Elsevier, 2007.
- [34] Andrzej S. Murawski and C. H. Luke Ong. Evolving games and essential nets for affine polymorphism. In Samson Abramsky, editor, *Typed Lambda Calculi and Applications*, pages 360–375, Berlin, Heidelberg, 2001. Springer Berlin Heidelberg.
- [35] Gordon Plotkin and Colin Stirling. A framework for intuitionistic modal logics. In *Proceedings of the 1st Conference on Theoretical Aspects of Reasoning about Knowledge (TARK)*, pages 399–406, 1986.
- [36] Dag Prawitz. Natural deduction: A proof-theoretical study. *Almqvist Wiksell, Stockholm*, 1965.
- [37] Alex K Simpson. *The proof theory and semantics of intuitionistic modal logic*. PhD thesis, University of Edinburgh. College of Science and Engineering, 1994.
- [38] Lutz Straßburger. Combinatorial flows and their normalisation. In Dale Miller, editor, *FSCD’17*, volume 84 of *LIPICs*, pages 31:1–31:17. Schloss Dagstuhl, 2017.

- [39] Lutz Straßburger, Willem Heijltjes, and Dominic J D Hughes. Intuitionistic proofs without syntax. In *LICS 2019 - 34th Annual ACM/IEEE Symposium on Logic in Computer Science*, pages 1–13, Vancouver, Canada, June 2019. IEEE.
- [40] Dimiter Vakarelov. Modal logics for knowledge representation systems. *Theor. Comput. Sci.*, 90:433–456, 01 1991.
- [41] Duminda Wijesekera. Constructive modal logics i. *Annals of Pure and Applied Logic*, 50(3):271–301, 1990.