

Germ-typicality of the coexistence of infinitely many sinks

Pierre Berger*, Sylvain Crovisier**, Enrique Pujals

April 1, 2021

Abstract

In the spirit of Kolmogorov typicality, we introduce the notion of *germ-typicality*: in a space of dynamics, it encompasses all these phenomena that occur for a dense and open subset of parameters of any generic parametrized family of systems.

For any $2 \leq r < \infty$, we prove that the Newhouse phenomenon (the coexistence of infinitely many sinks) is locally C^r -germ-typical, nearby a *dissipative bicycle*: a dissipative homoclinic tangency linked to a special heterodimensional cycle.

During the proof we show a result of independent interest: the stabilization of some heterodimensional cycles for any regularity class $r \in \{1, \dots, \infty\} \cup \{\omega\}$ by introducing a new renormalization scheme. We also continue the study of the paradiynamics done in [Ber16, Ber17, BCP17] and prove that parablenders appear by unfolding some heterodimensional cycles.

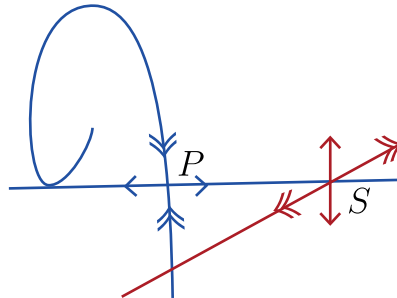

Figure 1: Bicycle

Contents

1	Concepts involved in the proof	6
2	Structure of the proofs of the theorems	13
3	From heterocycles to basic sets and strong heterocycles . . .	19
4	From chains of heterocycles to paraheterocycles	26
5	Nearly affine (para)-blender renormalization	30

One of the most complex and rich phenomenon in differentiable dynamical systems was discovered by Newhouse [New74, New79]. He showed the existence of locally Baire-generic sets

* Partially supported by the ERC project 818737 *Emergence of wild differentiable dynamical systems*.

** Partially supported by the ERC project 692925 *NUHGD*.

of dynamics displaying infinitely many sinks which accumulate onto a Smale's horseshoe (a stably embedded Bernoulli shift). This property is the celebrated *Newhouse phenomenon*. It appears in many classes of dynamics [Buz97, BD99, DNP06, Buz97, Dua08, Bie20]. Following Yoccoz, this phenomenon provides more a lower bound on the wildness and complexity of the dynamics, rather than a complete understanding on the dynamics. Indeed from the topological or statistical viewpoints, these dynamics are presently extremely far to be understood; it is not clear that the current dynamical paradigm would even allow to state a description of such dynamics.

Since then the problem of the typicality of the Newhouse phenomenon has been fundamental. But the notion of Baire-genericity among dynamical systems is a priori independent to other notions of typicality involving probability. That is why many important works and programs [TLY86, PT93, PS96, Pal00, Pal05, Pal08, GK07] wondered if the complement of the Newhouse phenomenon could be typical in some probabilistic senses inspired by Kolmogorov.

In his plenary talk ending the ICM 1954, Kolmogorov introduced the notion of typicality for analytic or finitely differentiable dynamics of a manifold M . He actually gave two definitions: one was designed to decide that a phenomenon is negligible, the other one to decide that a phenomena is typical. He called *negligible* a phenomenon which only holds on a subset dynamics sent into a Lebesgue null subset of \mathbb{R}^n by a finite number of [non trivial] real valued functionals $(\mathcal{F}_i)_{0 \leq i \leq n}$ on the space of dynamics. To decide if a phenomenon \mathcal{B} is *typical*, he proposed to start with a dynamics f_0 presenting the behavior, and then to consider a deformation f_a of the form

$$f_a(z) = f_0(z) + a \cdot \phi(x, a) ,$$

where ϕ is a function of both x and a , of the same regularity as f (e.g. analytic, smooth or finitely differentiable). Then he called the behavior \mathcal{B} *typical*, or *stably realizable* if, for every a small enough, the system f_a displays this behavior. This was presented as a criterion for detecting the importance of a phenomenon:

Any type of behavior of a dynamical system for which there exists at least one example of stable realization should be recognized as being important and not negligible.

Kolmogorov, ICM 1954.

Recently, [Ber16, Ber17] showed the existence of locally Baire-generic sets of C^r -families of dynamics $(f_a)_{a \in \mathbb{R}^k}$, $r, k < \infty$, such that for every $\|a\| \leq 1$, the map f_a displays the Newhouse phenomenon. In particular, this showed that the complement of the Newhouse phenomenon is not typical for some interpretations of Kolmogorov's typicality. In [Ber17], it has been also conjectured that some dynamics with complex statistical behavior should be typical in many senses.

In this work we show that the Newhouse phenomenon is typical according to the following notion inspired by Kolmogorov idea and subsequent developements [IL99, HK10, Mat03, KZ20]:

Definition 0.1 (Germ-typicality). *A behavior \mathcal{B} is C^r -germ-typical in $\mathcal{U} \subset C^r(M, M)$, if there exist a Baire-generic¹ set \mathcal{R} in the space of C^r -families² $\hat{f} = (f_a)_{a \in \mathbb{R}}$ of maps in \mathcal{U} and a lower semi-continuous function $\delta: \mathcal{R} \rightarrow (0, +\infty)$ such that for every $\hat{f} \in \mathcal{R}$ and for all $|a| < \delta(\hat{f})$, the map f_a presents the behavior \mathcal{B} .*

¹i.e. a set which contains a countable intersection of open and dense sets.

²In Section 1.1, we will precise the topological space of C^r -families involved.

To precise our setting, we consider an open set U with boundary inside a surface M and the space $\text{Diff}_{loc}^r(U, M)$ of local C^r -diffeomorphisms from \bar{U} to M . Working inside this space, we reveal that any homoclinic configuration called *bicycle* (see Fig. 1) is included in the closure of these open sets \mathcal{U} :

Definition 0.2. *A local diffeomorphism displays a bicycle if one of its saddle point has a homoclinic tangency and a heterocycle. A saddle point P displays a heterocycle if $W^u(P)$ contains a projectively hyperbolic source S and if the strong unstable manifold $W^{uu}(S)$ intersects $W^s(P)$. The bicycle is dissipative if the dynamics contracts the area along the orbit of P .*

Since a bicycle is a simple configuration, in many cases it may be easy to obtain, as we will see in Example 1.12 for the planar dynamics $(x, y) \mapsto (x^2 - 2, y)$.

The main theorem of this work is the following:

Theorem A. *For every $2 \leq r < \infty$ and for every local C^r -diffeomorphism of surface $f \in \text{Diff}_{loc}^r(U, M)$, which displays a dissipative bicycle, there exists a (non empty) open set $\mathcal{U}^r \subset \text{Diff}_{loc}^r(U, M)$ whose closure contains f and where the Newhouse phenomenon is C^r -germ-typical.*

Following Kolmogorov viewpoint, this theorem strengthens the evidence of the importance of the Newhouse phenomenon. As we mentioned previously, [Ber16] discovered the stable co-existence of infinitely many sinks for a generic subset of an open set of parametrized families, i.e. showed that the Newhouse phenomenon can not be neglected when one crosses a region of the space of systems along some “well-chosen directions”. In comparison Theorem A goes one step further and establishes the typicality of the Newhouse phenomenon in a sense which only depends on a neighborhood inside the space of systems (and not on the neighborhood of a specific family).

For the sake of clarity, we restrict the scope of the present work to the case of surface local diffeomorphisms and to a notion of germ-typicality involving only one-parameter families. However we are confident that our result could be generalized to a broader setting: for instance [Ber17] applies also to diffeomorphisms in higher dimension and to any finitely dimensional parameter families.

Locus of robust phenomena: stabilization of heterodimensional cycles

Another main point of the present work is to bring to light a very simple configuration nearby which germ-typicality of the Newhouse phenomenon holds true. The idea to associate a homoclinic configuration to a phenomenon goes back to Newhouse. In [New70], he first showed that it is possible to get a (non-empty) open set of diffeomorphisms of surface exhibiting homoclinic tangencies (these diffeomorphisms exhibit C^2 -robust homoclinic tangencies), and then in [New74] that this open set can encompass a Baire-generic subset formed by dynamics displaying the Newhouse phenomenon (infinitely many attracting cycles). To obtain such open sets of diffeomorphisms with robust homoclinic tangencies, Newhouse considered horseshoes with large fractal dimension (large thickness in his own nomenclature). Later, in [New79], Newhouse proved that from [the configuration defined by] a homoclinic tangency, a perturbation of the dynamics displays a robust homoclinic tangency (see Theorem 1.1).

For local diffeomorphisms, these thick horseshoes can be replaced by more topological object, called *blenders*. They were introduced by Bonatti and Diaz [BD96] for diffeomorphisms in dimension larger than or equal to three and can be recasted in the context of local diffeomorphisms

of surface as hyperbolic compact sets such that the union of their local unstable manifolds covers C^r -robustly a (non-empty open set of the surface (see Definition 1.4). In the same spirit as Newhouse’s work, one can wonder, nearby which homoclinic configurations blenders appear. Bonatti, Diaz and Kiriki [BDK12] proved that heterodimensional cycles (which, in the case of local diffeomorphisms of surface correspond to cycles between a saddle and a source) play that role when one considers the C^1 -topology: a C^1 -perturbation of the heterodimensional cycle generates open sets of dynamics exhibiting blenders and C^1 -robust heterodimensional cycles. In the present paper, we extend this result to the context of more regular dynamics:

Theorem B. *For every $1 \leq r \leq \infty$ or $r = \omega$, consider $f \in \text{Diff}_{loc}^r(U, M)$ exhibiting a heterocycle associated to a saddle P . Then there exists \tilde{f} , that is C^r -close to f , with a basic set K containing the hyperbolic continuation of P , and which has a C^r -robust heterocycle.*

While communicating our result, Li and Turaev have informed us that they independently achieved to prove a more general version of Theorem B for higher dimensional systems, by using different techniques [LT]. Diaz and Perez have also recently obtained [DP] a similar stabilization of heterodimensional cycles for C^r -diffeomorphisms in dimension 3, assuming in addition that one of the periodic points exhibits a homoclinic tangency.

Renormalization nearby heterocycles

In order to prove Theorem B (in Section 2.1), we first show in Proposition 2.1 that nearby heterocycles there are heterocycles satisfying an additional property. These configurations are called *strong heterocycles* and are defined in Definition 1.3. Then Proposition 2.2 introduces a renormalization nearby strong heterocycles to obtain nearly affine blenders.

This renormalization consists in selecting two inverses branches g^+ and g^- of larges iterates of the dynamics, which are defined on boxes nearby the heterocycle and then to rescale $\mathcal{R}g^- = \phi^{-1} \circ g^- \circ \phi$, $\mathcal{R}g^+ = \phi^{-1} \circ g^+ \circ \phi$ the two latter branches via a same coordinate change ϕ . The maps $\mathcal{R}g^-, \mathcal{R}g^+$ are close to affine maps and define a blender, which will be called *nearly affine blender*, see Definition 1.7.

Theorem B is restated more precisely in Section 1.4. Propositions 2.1 and 2.2 are proved in respectively Sections 3 and 5. This renormalization is one of the main technical novelty of the present work. It is further developed to obtain Theorem D (in Section 1.7), a parametric counterpart of Theorem B. Theorem D is essential to prove Theorem A. It states that nearby paraheterocycles there are nearly affine parablenders. These are objects of paradynamics.

Paradynamics

To explain the role of these parametric blenders we have to go back to the paper [Ber16]: it considered parameter families of local diffeomorphisms on surfaces and introduced the notion of *paratangencies*: a homoclinic tangency that is “sticky” (or unfolded in “slow motion”). That phenomenon implies that the attracting periodic points created by the unfolding of the tangency have “a long life in the parameter space”. Moreover, if any perturbation of a parameter family still exhibits a dissipative homoclinic paratangency for all parameters (in other words the family exhibits *robust homoclinic paratangencies*, the analog in the space parameter families of the robust homoclinic tangencies in the space of local diffeomorphisms) then, after small perturbation, the new family displays infinitely many attracting periodic points for all parameters (see Lemmas 2.15 and 2.16).

To provide robust paratangencies, [Ber16] introduced a parametric version of the blenders, called C^r -parablenders, see Definition 1.17. To grasp the idea behind this notion, first recall that any hyperbolic compact set of a map has a unique continuation for a nearby system. Any point in the hyperbolic set has a unique continuation as well (see Section 1.1 for details) and the same holds true for its local stable and unstable manifolds. When the parameter family is of class C^r , the continuation of a point defines a curve of class C^r . The key property of a C^r -parablender, is that for an open set of parametrized points in the surface, of the local unstable manifold of the parablender moves in slow motion with respect to the parametrized point. This property can be push forward to the unfolding of homoclinic tangencies and allows to create robust homoclinic paratangencies. For that purpose, it is easier to assume that the collection of local unstable manifolds covers a source homoclinically linked to the parablender.

In [BCP17], the notion of parablender has been recasted: parameter families of maps naturally induce an action on C^r -jets and the parablenders can be viewed as blenders for this dynamics on the space of jets. This viewpoint allowed us to systematize the construction of parablenders: in [BCP17], using Iterated Function Systems, a special type of parablenders called *nearly affine parablenders* (see Definition 1.18) is introduced.

In the present paper, we tried to follow Newhouse’s approach and looked for a simple bifurcation that generates “robust paratangencies”. According to [Ber17], it suffices to obtain a parablender covering a source and linked to a dissipative homoclinic tangency. Similarly to [BDK12], one can wonder if the parametric unfolding of a heterodimensional cycle may generate a parablender. We answer by proving that the unfolding of a homoclinic tangency related to a heterocycle (a *bicycle*) is the sough configuration which produces robust paratangencies.

To precise, first we prove that combining a homoclinic tangency with the heterocycle, one obtains alternate chain of heterocycles (a chain of heterocycles involving saddles with negative eigenvalues, see Definition 2.7). The unfolding of that special chain produces a *paraheterocycle* (a heterocycle that is unfolded in “slow motion”, see Definition 1.15 and theorem C) and which then gives birth to nearly affine parablenders (see theorem D) using the aforementioned renormalization technique.

Open problems

Paradynamics has been useful to prove that several complex and interesting phenomena are robust along a locally Baire-generic set of families of dynamics, see [Ber, IS17, BRb, BRa]. The tools brought by our work should enable to show the C^r -germ-typicality of these phenomena.

Note that if a behavior \mathcal{B} is C^r -germ-typical in \mathcal{U} then it occurs on an open and dense set of parameters for a Baire-generic set of C^r -families $(f_a)_a$ of dynamics $f_a \in \mathcal{U}$. But it does not imply that the Lebesgue measure of this open and dense set of parameters is full. In particular, it remains open whether the Newhouse phenomenon is locally typical with respect to some interpretations of Kolmogorov typicality given by [HK10], [Ber20] or [IL99, Chapter 2, section 1]. The latter is slightly stronger than:

Definition 0.3 (Arnold prevalence (soft version)). *For $r, k \geq 1$, a behavior \mathcal{B} is C^r - k -Arnold prevalent in $\mathcal{U} \subset C^r(M, M)$, if there exists a Baire-generic set \mathcal{R} of C^r -families $(f_a)_{a \in \mathbb{R}^k}$ formed by maps $f_a \in \mathcal{U}$ such that for every $(f_a)_a \in \mathcal{R}$, for Lebesgue almost every parameter $a \in \mathbb{R}^k$, f_a presents the behavior \mathcal{B} .*

Another notion of typicality has been introduced by Hunt, York and Sauer [HSY92], and

then developed by Kaloshin-Hunt in [HK10]; it was used by Gorodeski-Kaloshin [GK07] to study the typicality of the Newhouse phenomenon, but leaves open the problem of the typicality of Newhouse phenomenon following the latter notions³.

Finally let us emphasize that the important Arnold-prevalence or the germ-typicality of the Newhouse phenomenon are open for the C^∞ or analytic topologies. Hopefully the tools developed in this present work seem to us useful to progress on these important problems.

1 Concepts involved in the proof

In this section we state the main results which are used to obtain Theorem A.

In Section 1.1 we recall classical definitions about hyperbolicity in the particular context of local diffeomorphisms. In Section 1.2 and Section 1.3 we recall the concepts of homoclinic tangency and heterodimensional cycle between fixed points with different indices and the classical results of Newhouse and Bonatti-Diaz associated to these bifurcations. In Section 1.4 we recall the notions of blenders and nearly affine blenders and we state the main theorem that relates cycles and blenders (Theorem B). In Section 1.5, we state precisely the definition of bicycle (that combines a homocycle and a heterocycle) and we show in Corollary B' that from bicycles one can obtain robust bicycles (it is worth to mention that this is done in any C^r -regularity including the analytic one).

In Section 1.6 and Section 1.7 we give the parametric version of the previous results. In Section 1.6 we introduce the notion of paraheterocycle and explain how by unfolding heterocycles associated to saddles with negative eigenvalues one can obtain a paraheterocycle (Theorem C). In Section 1.7 we introduce the notions of affine and nearly affine parablenders and explain how they emerge from paraheterocycles (Theorem D).

1.1 Preliminaries

In the following M is a compact surface, U an open subset whose boundary is a smooth submanifold and $\text{Diff}_{loc}^r(U, M)$ for $r \in \mathbb{N} \cup \{\infty\}$, denotes the restrictions to U of C^r -map $f: \bar{U} \rightarrow M$ whose differential $D_x f$ is invertible at every $x \in \bar{U}$. Endowed with the C^r -topology, this is a Baire space.

For some results, one will also assume that M is a real analytic surface and let \tilde{M} be a complex extension. One then considers the space $\text{Diff}_{loc}^\omega(U, M)$ of real analytic maps endowed with the analytic topology defined as the inductive limit of the spaces of holomorphic maps defined on neighborhoods of M in \tilde{M} .

Now let us precise the space of C^r -families parametrized by the interval $\mathbb{I} = (-1, 1)$. For the sake of clarity, we will focus only on the space $\mathcal{D}^r(\mathbb{I} \times U, M)$ of families $(f_a)_{a \in \mathbb{I}}$ which are the restriction of a map $(a, x) \mapsto f_a(x)$ of class C^r on $\bar{\mathbb{I}} \times \bar{U}$, that we endow with the uniform C^r -topology. However all our arguments will be also valid for the smaller space $C^r(\bar{\mathbb{I}}, \text{Diff}_{loc}^r(U, M))$ endowed with the topology of C^r -maps from $\bar{\mathbb{I}}$ into $\text{Diff}_{loc}^r(U, M)$.

An *inverse branch* for $f \in \text{Diff}_{loc}^r(U, M)$ is the inverse of a restriction $f|_V$ of f to a domain $V \subset U$ such that $f^n|_V$ is a diffeomorphism onto its image.

³The original notion of typicality defined by [HSY92] is defined for Banach spaces; its counterpart for Banach manifolds (such as the space of dynamics on a compact manifold) is so far not unique (there is no version of this notion which is invariant by coordinate change, contrarily to germ-typicality or Arnold prevalence).

A compact set K is *(saddle) hyperbolic* for f if it is f -invariant (i.e. $f(K) = K$) and there exists a continuous, Df -invariant subbundle E^s of $TM|K$ which is uniformly contracted and normally uniformly expanded. More precisely, there exists $N \geq 1$ satisfying:

$$\|D_z f^N|E_z^s\| < 1/2 \quad \text{and} \quad \|p_{E^{s\perp}} \circ D_z f^N(v)\| \geq 2\|v\|, \quad \forall z \in K, v \in E_z^{s\perp},$$

where $E^{s\perp}$ is the subbundle of $TM|K$ equal to the orthogonal complement of E_z^s and $p_{E^{s\perp}}$ the orthogonal projection onto it. The hyperbolic set K is a *basic set* if it is transitive and locally maximal. Then K is equal to the closure of its subset of periodic points.

Any point $x \in K$ has a stable manifold $W^s(x)$ (also denoted $W^s(x; f)$) which is an injectively immersed curve. The map $f|K$ being in general not injective, a single point $x \in K$ has in general as many unstable manifolds as preorbits \underline{x} . We denote such a submanifold by $W^u(\underline{x})$, or $W^u(\underline{x}; f)$. The space of preorbits \underline{x} is denoted by $\overleftarrow{K} := \{\underline{x} = (x_i)_{i \leq 0} \in K^{\mathbb{Z}^-} : f(x_{i-1}) = x_i\}$. The space \overleftarrow{K} is canonically endowed with the product topology. The zero-coordinate projection is denoted by $\pi_f: \overleftarrow{K} \rightarrow M$; it semi-conjugates the shift dynamics σ on \overleftarrow{K} with f .

It is well known (see for instance [BR13]) that a hyperbolic compact set is *C^1 -inverse limit stable*: for every C^1 -perturbation f' of f , there exists a (unique) map $\pi_{f'}: \overleftarrow{K} \rightarrow M$ which is C^0 -close to $\pi_{f'}$ and so that:

$$\pi_{f'} \circ \sigma = f' \circ \pi_{f'}.$$

The image $K_{f'} := \pi_{f'}(\overleftarrow{K})$ is also a hyperbolic set. Note that $K_f = K$. Also $K_{f'}$ is called the *hyperbolic continuation* of K .

Two basic sets are *(homoclinically) related* if there exists an unstable manifold of the first which has a transverse intersection point with a stable manifold of the second, and vice-versa. Then by the Inclination Lemma, the local unstable manifolds of one basic set are dense in the unstable manifolds of the other.

An f -invariant compact space is *projectively hyperbolic expanding* if there exists a continuous Df -invariant subbundle E^{cu} of $TM|K$ which is uniformly expanded and normally uniformly expanded. More precisely, there exists $N \geq 1$ satisfying:

$$\|D_z f^N|E_z^{cu}\| > 2 \quad \text{and} \quad \|p_{E^{cu\perp}} \circ D_z f^N(v)\| \geq 2 \cdot \|v\| \cdot \|D_z f^N|E_z^{cu}\|, \quad \forall z \in K, v \in E_z^{cu\perp}.$$

If it is transitive and locally maximal, it is equal to the closure of its subset of periodic points. To any $\underline{x} \in \overleftarrow{K}$, one associates a strong unstable manifold $W^{uu}(\underline{x})$ as the set of points which converge to the orbit of \underline{x} in the past transversally to the bundle E^{cu} .

A saddle periodic point P of period $p \geq 1$, is *dissipative* if $|\det D_P f^p| < 1$.

A source periodic point S is *projectively hyperbolic* if the tangent space at S split into two Df -invariant directions, $T_S M = E^{cu} \oplus E^{uu}$, the direction E^{cu} –called *center unstable*– being less expanded than the direction E^{uu} –called *strong unstable*. Its strong unstable manifold $W^{uu}(S)$ is the set of points which converge to the orbit of S in the past in the direction of E^{uu} .

1.2 Homocycle

Given $f \in \text{Diff}_{loc}^r(U, M)$, a saddle periodic point $P \in U$ has a *homoclinic tangency* or *homocycle* for short, if its stable manifold has a non-transverse intersection point $T \in U$ with its unstable manifold.

$$(\text{Homocycle}) \quad \exists T \in TW^s(P) \cap TW^u(P).$$

More generally, a basic set $K \subset U$ has a homoclinic tangency if there exist $P \in K$ and $Q \in \overleftarrow{K}$ (not necessarily periodic) such that $W^s(P)$ is tangent to $W^u(Q)$. A basic set K has a C^r -robust homoclinic tangency if for every C^r -perturbation of the dynamics, the hyperbolic continuation of K still has a homoclinic tangency. If $r \geq 2$ and if the phase space is a surface, the tangency T is *quadratic*, if the curvature of $W^s(P)$ and $W^u(Q)$ at T are not equal.

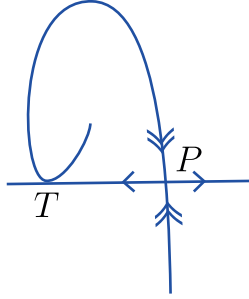

Figure 2: Homocycle

Here is a famous theorem by Newhouse [New79], which stabilizes the homoclinic tangencies.

Theorem 1.1 (Newhouse). *For $2 \leq r \leq \infty$ or $r = \omega$, consider $f \in \text{Diff}_{loc}^r(U, M)$ and a saddle periodic point P exhibiting a homoclinic tangency T . Then there exists \tilde{f} C^r -close to f , with a basic set K containing the hyperbolic continuation of P , and which has a C^r -robust homoclinic tangency.*

The open set \mathcal{N}^r of dynamics displaying a C^r -robust homoclinic tangency is called the *Newhouse domain*. We denote by $\mathcal{N}^r(P) \subset \mathcal{N}^r$ the open set of dynamics for which the hyperbolic continuation of P belongs to a basic set displaying a C^r -robust homoclinic tangency. By the Inclination Lemma, the stable and unstable manifolds of P are dense in the stable and unstable sets of K . Thus a C^r -small perturbation of any dynamics in $\mathcal{N}^r(P)$ creates a homoclinic tangency for P . This proves:

Proposition 1.2. *For every $1 \leq r \leq \infty$ or $r = \omega$, there exists a C^r -dense set in $\mathcal{N}^r(P)$, made by maps for which the hyperbolic continuation of P has a homoclinic tangency.*

Let $\mathcal{N}_{diss}^r(P) \subset \mathcal{N}(P)$ be the open set formed by dynamics for which the hyperbolic continuation of P is dissipative. As a periodic sink of arbitrarily large period can be obtained by a small perturbation of a dissipative homoclinic tangency, the latter proposition then implies the Baire-genericity in $\mathcal{N}_{diss}^r(P)$ of dynamics exhibiting a Newhouse phenomenon (see [New74] for more details).

1.3 Heterocycles

In the present section we first recast for the case of surface endomorphisms, the notion of heterodimensional cycle introduced in [D95, BD96], and present two stronger versions of it called *heterocycle* and *strong heterocycle*.

Definition 1.3. *A map $f \in \text{Diff}_{loc}(U, M)$ displays a heterodimensional cycle if it has a saddle periodic point P and a periodic source S such that $W^u(S)$ intersects $W^s(P)$ and S is in $W^u(P)$:*

(Heterodimensional cycle) $S \in W^u(P)$ and $W^s(P) \cap W^u(S) \neq \emptyset$.

The heterodimensional cycle forms a heterocycle if the source is projectively hyperbolic and $W^{uu}(S)$ intersects $W^s(P)$:

(Heterocycle) $S \in W^u(P)$ and $W^s(P) \cap W^{uu}(S) \neq \emptyset$.

This heterocycle is strong if furthermore $W^{uu}(S)$ contains P :

(Strong heterocycle) $S \in W^u(P)$ and $P \in W^{uu}(S)$.

We will see in Proposition 2.1 that any map displaying a heterocycle can be smoothly perturbed to display a strong heterocycle between a saddle point P' homoclinically related to the initial one P , and the initial source S .

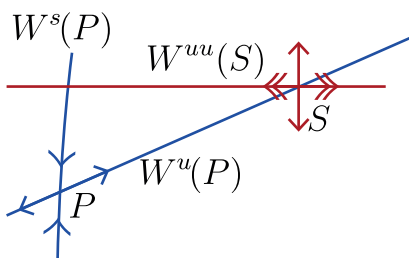

Figure 3: Heterocycle for a surface map.

A heterocycle is a one-codimensional phenomenon. To show its local density, we shall generalize it as follow. A basic set K and a projectively hyperbolic periodic source S of a surface map display a *heterocycle* if there exists $P \in K$ (not necessary periodic) such that $W^s(P) \cap W^{uu}(S) \neq \emptyset$ and there exists $\underline{P} \in \overline{K}$ such that $P = \pi_f(\underline{P})$ and $S \in W^u(\underline{P})$. The *heterocycle* is C^r -robust if for every C^r -perturbation of the dynamics, the hyperbolic continuations of K and S still have a heterocycle. The C^r -open set of surface maps which display a robust heterocycle is called the *Bonatti-Diaz domain* and is denoted by \mathcal{BD}^r . We denote by $\mathcal{BD}^r(P, S) \subset \mathcal{BD}^r$ the open set of dynamics for which the hyperbolic continuation of P belongs to a basic set displaying a C^r -robust heterocycle with the continuation of S .

1.4 Blenders

Let us again consider a robust heterocycle between a basic set K and a source S . As by a perturbation of the dynamics, S can be moved independently of K and its unstable manifold, this implies that K must be a *blender*:

Definition 1.4 (C^r -Blender). A C^r -blender for $f \in \text{Diff}_{loc}^r(U, M)$ is a basic set K such that the union of its local unstable manifolds has C^r -robustly non-empty interior: there exists a continuous family of local unstable manifolds whose union contains a non-empty open set $V \subset U$ and the same holds true for their continuations for any C^r -perturbations \tilde{f} of f .

The set V is called an activation domain of the blender K .

As the periodic points are dense in K , the unstable manifolds of periodic points are also dense in the activation domain. Hence for a small C^r -perturbation supported by a small neighborhood of the blender, there exists a periodic point whose unstable manifold contains the source, defining a heterocycle. This proves the following counterpart of Proposition 1.2:

Proposition 1.5. *For every $1 \leq r \leq \infty$ or $r = \omega$, there exists a C^r -dense set in $\mathcal{BD}^r(P, S)$ made by maps for which the hyperbolic continuation of P and S have a heterocycle.*

Bonatti and Diaz have introduced the notion of blender and obtained the first semi-local constructions of robust heterocycles [BD96].

Question 1.6. *All the known C^r -blenders are also C^1 -blender. Is \mathcal{BD}^r equal to \mathcal{BD}^1 ?*

The following notion has been introduced in [BCP17] and will play a key role in a renormalization that we will perform nearby heterocycles.

Definition 1.7 (Nearly affine blender). *For $r \in [1, \infty)$, $\Delta > 1$, $x_0 \in (-2, 2)$, $\delta > 0$, f has a δ - C^r -nearly affine blender with contraction Δ^{-1} if there is a C^r -chart $H: \mathbb{R}^2 \hookrightarrow M$ such that:*

- *there is an inverse branch g^+ of an iterate f^{N^+} of f such that $\mathcal{R}g^+ := H^{-1} \circ g^+ \circ H$ is well defined on $[-2, 2]^2$ and is δ - C^r -close to $(x, y) \mapsto (x_0, \Delta(y - 1) + 1)$;*
- *there is an inverse branch g^- of an iterate f^{N^-} of f such that $\mathcal{R}g^- := H^{-1} \circ g^- \circ H$ is well defined on $[-2, 2]^2$ and is δ - C^r -close to $(x, y) \mapsto (x_0, \Delta(y + 1) - 1)$.*

Observe that the maximal invariant set of the map:

$$(\mathcal{R}g^+)^{-1} \sqcup (\mathcal{R}g^-)^{-1} : \mathcal{R}g^+([-2, 2]^2) \sqcup (\mathcal{R}g^-([-2, 2]^2) \rightarrow \mathbb{R}^2$$

is a basic set K . The following is easy, see for instance [BCP17, Section 6] for details.

Proposition 1.8. *For every $\Delta > 1$ close to 1, $x_0 \in (-2, 2)$ and $\eta \in (0, 1)$, if $\delta > 0$ is sufficiently small, then the set K is a C^1 -blender and $(-2, 2) \times [-1 + \eta, 1 - \eta]$ is an activation domain.*

In Section 2 we will prove the following analogous of Newhouse Theorem 1.1, which stabilizes the heterocycles. It will be obtained by introducing a renormalization for a perturbation of f leading to a nearly affine blender.

Theorem B. *For every $1 \leq r \leq \infty$ or $r = \omega$, consider $f \in \text{Diff}_{loc}^r(U, M)$ exhibiting a heterocycle formed by a saddle P and a projectively hyperbolic source S . Then for every $\delta > 0$ and any number $\rho \leq r$, there exists \tilde{f} , C^r -close to f , such that $P_{\tilde{f}}$ is homoclinically related to a δ - C^ρ -nearly affine blender whose activation domain contains $S_{\tilde{f}}$.*

Question 1.9. *To what extent the previous results generalize to heterodimensional cycles?*

In that direction, [BDK12] proved for diffeomorphisms that it is possible to stabilize by C^1 -perturbation any classical heterodimensional cycle between saddles whose stable dimension differs by one, provided that at least one of the saddle involved in the cycle belongs to a nontrivial hyperbolic set. An analogue in any regularity class is done in [LT].

1.5 Bicycles and robust bicycles

Let us precise the definition of bicycle mentioned in the introduction:

Definition 1.10. A saddle P and a projectively hyperbolic source S display a bicycle if they form a heterocycle and if P has a homocycle. The bicycle is dissipative if the orbit of P is dissipative.

The notion of bicycle can be extended to basic sets.

Definition 1.11. A basic set for $f \in \text{Diff}_{loc}^r(U, M)$ displays a C^r -robust bicycle if it displays a C^r -robust homocycle and forms a C^r -robust heterocycle with a projectively hyperbolic source.

It is easy to build a bicycle by perturbation of some explicit example:

Example 1.12. For every $r \geq 2$, the map $f := (x, y) \in \mathbb{R}^2 \mapsto (x^2 - 2, y)$ is C^r -accumulated by maps f_ε exhibiting a bicycle. Hence by Theorem A, there is an open set of C^r -perturbations \mathcal{U}^r of f_ε in which the coexistence of infinitely many sinks is C^r -germ-typical.

Proof of Example 1.12. First, we choose the parameter a close to -2 such that the map $g(x) = x^2 + a$ admits two homoclinically related repelling periodic points s, p , the orbit of the critical point contains p (there exists $n \geq 1$ such that $g^n(0) = p$) and belongs to the unstable set of p (there exists a sequence of backward iterates of 0 which accumulates on p): usually such a parameter a is called a *Misiurewicz parameter*).

Then we consider a function ρ close to 1 which is equal to $1 + \varepsilon$ on a small neighborhood of the orbit of s and to $1 - \varepsilon$ in a small neighborhood of the orbit of p . We now consider the following small perturbation of f :

$$f_{a,\varepsilon}(x, y) \mapsto (x^2 + a, \rho(x)y).$$

Observe that it has a projectively hyperbolic source $S := (s, 0)$ and dissipative saddle point $P := (p, 0)$, such that the unstable manifold of each point intersects the other point and the image of the critical point still is preperiodic. One now can perform a small perturbation in a neighborhood of the critical point that makes the map a local diffeomorphism and that also preserves the image of the critical point, which then defines a homoclinic tangency of p . In a such way, one obtains a map with a bicycle involving P and S . \square

Similarly to Proposition 1.2 and Proposition 1.5 we have:

Proposition 1.13. For every $1 \leq r \leq \infty$ or $r = \omega$, consider an open set of maps $f \in \text{Diff}_{loc}^r(U, M)$ displaying a C^r -robust bicycle involving a saddle P and a projectively hyperbolic source S . It contains a C^r -dense subset of maps for which the hyperbolic continuation of P and S form a bicycle.

Combining Theorems 1.1 and B, one can stabilize the bicycles:

Corollary B'. For $2 \leq r \leq \infty$ or $r = \omega$, consider $f \in \text{Diff}_{loc}^r(U, M)$ and a saddle P exhibiting a bicycle. Then there exists \tilde{f} , C^r -close to f , with a hyperbolic basic set K containing the hyperbolic continuation of P which exhibits a C^r -robust bicycle.

1.6 Paraheterocycles

Let us fix $1 \leq r \leq \infty$, and a C^r -family $(f_a)_{a \in \mathbb{R}}$ of local diffeomorphisms $f_a \in \text{Diff}_{loc}^r(U, M)$.

Hyperbolic sets for families of dynamics It is well known that if f_0 has a hyperbolic fixed point P , then its hyperbolic continuation $(P_a)_{a \in I}$ is a C^r function of the parameter a on a neighborhood $I \subset \mathbb{R}$ of 0. More generally, if K is a hyperbolic set for f_0 , with \overleftarrow{K} the inverse limit of K , its hyperbolic continuation $(K_a)_{a \in I}$ by the range $K_a = \pi_a(\overleftarrow{K})$ of a family of maps $\pi_a := \pi_{f_a} : \overleftarrow{K} \rightarrow M$ (see Section 1.1) with the following regularity:

Proposition 1.14 (see Prop 3.6 [Ber16]). *There exists a neighborhood I of 0 where $(\pi_a)_{a \in I}$ is well defined. For any $\underline{z} \in \overleftarrow{K}$, the map $a \in I \mapsto \pi_a(\underline{z})$ is of class C^r and depends continuously on \underline{z} in the C^r -topology.*

The local stable and unstable manifolds $W_{loc}^s(z; f_a)$ and $W_{loc}^u(\underline{z}; f_a)$ are canonically chosen so that they depend continuously on a , z and \underline{z} in the C^r -topology (see Prop 3.6 in [Ber16]). They are called the *hyperbolic continuations* of $W_{loc}^s(z; f_0)$ and $W_{loc}^u(\underline{z}; f_0)$ for f_a .

Definition 1.15 (Paraheterocycle). *Given $0 \leq d \leq r$, the family $(f_a)_{a \in \mathbb{R}}$ displays a C^d -paraheterocycle at a_0 if there exist a heterocycle for f_{a_0} involving a saddle P and a projectively hyperbolic source S whose hyperbolic continuations satisfy for some $N \geq 0$*

$$(1.1) \quad d(S_a, f_a^N(W_{loc}^u(P_a))) = o(|a - a_0|^{d'}), \quad \text{for any integer } 0 \leq d' \leq d.$$

We say it is a strong C^d -paraheterocycle if furthermore P, S form a strong heterocycle.

Note that if f_{a_0} has a heterocycle then $(f_a)_a$ has a C^0 -paraheterocycle at $a = a_0$.

Theorem C. *Consider a C^∞ family of local diffeomorphisms $(f_a)_{a \in \mathbb{R}}$ in $\text{Diff}_{loc}^\infty(U, M)$ and a heterocycle for f_0 between a saddle point P with period p and a projectively hyperbolic source S . Let us assume furthermore that the stable eigenvalue of $D_P f_0^p$ is negative.*

Then there exists a family $(\tilde{f}_a)_{a \in \mathbb{R}}$, C^∞ -close to $(f_a)_{a \in \mathbb{R}}$, which displays a C^∞ -paraheterocycle at $a = 0$ between the continuation of the saddle P and a projectively hyperbolic source S' .

We will see in Lemma 2.9 that the assumption on the negative stable eigenvalue can be obtained when the heterocycle is included in a bicycle.

Remark 1.16. The definition of paraheterocycle, the statement of Theorem C and its proof extend without difficulty to families parametrized by \mathbb{R}^k , for any $k \geq 1$, see Remark 2.11 and Section 4.3.

1.7 Parablenders

In this section we fix $1 \leq r < \infty$.

Parablenders are a parametric counterpart of blenders. The first example of a parablender was given in [Ber16]; in [BCP17] a new example of parablender was given and therein the definition of parablender was formulated as:

Definition 1.17 (C^r -Parablender). *The continuation $(K_a)_{a \in I}$ of a hyperbolic set K for the family $(f_a)_{a \in \mathbb{R}}$ is a C^r -parablender at $a_0 \in \text{Interior}(I)$ if the following condition is satisfied.*

There exist a continuous family of local unstable manifolds $(W_{loc}^u(\underline{z}; f_{a_0}))_{\underline{z} \in \overleftarrow{K}}$ and a non-empty open set O of germs at a_0 of C^r -families of points $(\gamma_a)_{a \in I}$ in M such that for every $(\tilde{f}_a)_{a \in \mathbb{R}}$ C^r -close to $(f_a)_{a \in \mathbb{R}}$, there exists $\underline{z} \in \overleftarrow{K}$ satisfying:

$$\lim_{a \rightarrow a_0} |a - a_0|^{-r} \cdot d\left(\gamma_a, W_{loc}^u(\underline{z}; \tilde{f}_a)\right) = 0.$$

The open set O is called an activation domain for the C^r -parablender $(K_a)_{a \in I}$.

Here is the parametric counterpart of the nearly affine blender introduced in Def. 1.7.

Definition 1.18 (Nearly affine parablender⁴ [BCP17]). For $\Delta > 1$, $x_0 \in (-2, 2)$ and $\delta > 0$, a C^r -family $(f_a)_{a \in \mathbb{R}}$ has a δ -nearly affine C^r -parablender with contraction Δ^{-1} at $a = 0$ if there exist a neighborhood I of 0 in \mathbb{R} , a C^r -family $(H_a)_{a \in I}$ of charts $H_a: \mathbb{R}^2 \hookrightarrow M$, a diffeomorphism $\theta: J \hookrightarrow I$ fixing 0 and inverse branches $(g_a^+)_{a \in I}$, $(g_a^-)_{a \in I}$ of iterates $f_a^{N^+}$, $f_a^{N^-}$ such that

$$\mathcal{R}g_a^+ := H_a^{-1} \circ g_{\theta(a)}^+ \circ H_a \quad \text{and} \quad \mathcal{R}g_a^- := H_a^{-1} \circ g_{\theta(a)}^- \circ H_a$$

are well defined on $[2, 2]^2$ and $(\mathcal{R}g_a^\pm)_{a \in I}$ are δ - C^r -close to the two families $(A_a^\pm)_{a \in I}$ defined by

$$A_a^+ : (x, y) \mapsto (x_0, (\Delta + a) \cdot y + \Delta - 1) \quad \text{and} \quad A_a^- : (x, y) \mapsto (x_0, (\Delta + a) \cdot y - \Delta + 1).$$

Note that a nearly affine parablender defines a germ of family of nearly affine blenders $(K_a)_{a \in I}$ at $a = 0$ and so a germ of family of blenders by Proposition 1.8. In [BCP17, Section 6], we showed⁵ that it defines also a parablender:

Proposition 1.19. For every $\Delta > 1$ close to 1 and $x_0 \in (-2, 2)$, there is $\eta > 0$ arbitrarily small such that if $\delta > 0$ is sufficiently small, then $(K_a)_{a \in I}$ is a C^r -parablender at $a = 0$. Moreover, its activation domain contains:

$$\{(z_a)_{a \in I} \in C^r(I, \mathbb{R}^2) : z_0 \in [-2, 2] \times (-\eta, \eta) \quad \text{and} \quad \|\partial_a^k z_a|_{a=0}\| < \eta, \quad \forall 1 \leq k \leq r\}.$$

We will show that nearly affine C^r -parablenders appear as renormalizations of the dynamics nearby paraheterocycles. This will enable us to show:

Theorem D. Let us consider a C^∞ family of local diffeomorphisms $(f_a)_{a \in \mathbb{R}}$ in $\text{Diff}_{\text{loc}}^\infty(U, M)$ and, for $r \geq 1$, a family of saddles $(P_a)_{a \in \mathbb{R}}$ and a family of projectively hyperbolic sources $(S_a)_{a \in \mathbb{R}}$ exhibiting a C^r -paraheterocycle at $a = 0$.

Then there exists $(\tilde{f}_a)_{a \in \mathbb{R}}$, C^∞ -close to $(f_a)_{a \in \mathbb{R}}$ displaying a C^r -parablender at $a = 0$ which is homoclinically related to P_0 and whose activation domain contains the germ of $(S_a)_{a \in \mathbb{R}}$ at $a = 0$. In particular $(\tilde{f}_a)_{a \in \mathbb{R}}$ displays a robust C^r -robust paraheterocycle at $a = 0$.

2 Structure of the proofs of the theorems

2.1 Proof of Theorem B

The strategy of the proof breaks down into two steps. In a first step, we obtain, by perturbation of the heterocycle, a strong heterocycle. This is done in Section 3.

⁴The coordinates considered in [BCP17] were slightly different but the same modulo conjugacy: the renormalized inverses branches are of the form:

$$B_b^\pm : (X, Y) \mapsto (0, (Y \pm 1)/(\Delta^{-1} + b)),$$

which is conjugate to the presented form $(A_a^\pm)_\pm$ via the coordinates changes:

$$(X, Y) = (x - x_0, \frac{\Delta - 1}{\Delta + a} \cdot y) \quad \text{and} \quad a = -\frac{b \cdot \Delta^2}{1 + b \cdot \Delta}.$$

⁵The activation domain is not explicitated in the statements of the results of [BCP17, Section 6], but appears in the proof as a product $W = B \times A$ (see page 67), where $B = [-2, 2] \times (-\eta, \eta)^r$ and where A is a neighborhood of 0 in \mathbb{R}^{r+1} , obtained as the image of a neighborhood of 0 by a surjective linear map (page 63).

Proposition 2.1. *For $\rho \in \{\infty, \omega\}$, let $f \in \text{Diff}_{loc}^\rho(U, M)$ with a projectively hyperbolic source S and a saddle point P forming a heterocycle. Then there exists a map \tilde{f} arbitrary C^ρ -close with a saddle point Q homoclinically related to $P_{\tilde{f}}$ and which forms with $S_{\tilde{f}}$ a strong heterocycle.*

In a second step we perturb the strong heterocycle in order to exhibit a nearly affine blender displaying a robust heterocycle. See Section 5.

Proposition 2.2. *For $\rho \in \{\infty, \omega\}$, let $f \in \text{Diff}_{loc}^\rho(U, M)$ with a projectively hyperbolic source S and a saddle point Q forming a strong heterocycle. Fix $\infty > r \geq 1$ and take $\Lambda > 1$ close to 1.*

Then, for every $\delta > 0$ there exists a C^ρ -perturbation \tilde{f} exhibiting a $\delta - C^r$ -nearly affine blender which is homoclinically related to $Q_{\tilde{f}}$ and whose activation domain contains $S_{\tilde{f}}$.

Note that the conjunction of these two propositions implies Theorem B for the topologies C^∞ and C^ω . When the initial diffeomorphism is C^r , $1 \leq r < \infty$, we first perturb in the C^r -topology in order to get a C^∞ -diffeomorphism taking care that the source S still belongs to the unstable manifold of the saddle P , and we then apply the result for C^∞ -diffeomorphisms. \square

2.2 Proof of Theorem D

Similarly to the proof of Theorem B, the proof consists in two steps that are the parametric counterparts of Proposition 2.1 and Proposition 2.2. They are detailed in Sections 3 and 5.

Proposition 2.3. *Consider a C^∞ family of local diffeomorphisms $(f_a)_{a \in \mathbb{R}}$ in $\text{Diff}_{loc}^\infty(U, M)$, and, for $r \geq 1$, a family of saddles $(P_a)_{a \in \mathbb{R}}$ and a family of projectively hyperbolic sources $(S_a)_{a \in \mathbb{R}}$ exhibiting a C^r -paraheterocycle at $a = 0$.*

Then there exist $(\tilde{f}_a)_{a \in \mathbb{R}}$, C^∞ -close to $(f_a)_{a \in \mathbb{R}}$ with a family of saddles $(Q_a)_{a \in \mathbb{R}}$ homoclinically related to $(P_a)_{a \in \mathbb{R}}$ which forms with $(S_a)_{a \in \mathbb{R}}$ a strong C^r -paraheterocycle at $a = 0$.

Proposition 2.4. *Consider a C^∞ family of local diffeomorphisms $(f_a)_{a \in \mathbb{R}}$ in $\text{Diff}_{loc}^\infty(U, M)$, and, for $r \geq 1$, a family of saddles $(Q_a)_{a \in \mathbb{R}}$ and a family of projectively hyperbolic sources $(S_a)_{a \in \mathbb{R}}$ exhibiting a strong C^r -paraheterocycle at $a = 0$.*

Then there exists $(\tilde{f}_a)_{a \in \mathbb{R}}$, C^∞ -close to $(f_a)_{a \in \mathbb{R}}$, displaying a C^r -parablender at $a = 0$ homoclinically related to Q_0 and whose activation domain contains the germ of $(S_a)_{a \in \mathbb{R}}$ at $a = 0$.

This completes the proof of Theorem D. \square

Remark 2.5. One can choose the parablender and the family of local unstable manifolds defining its activation domain in such a way that each local unstable manifold does not have S_0 as an endpoint and is not tangent to the weak unstable direction of S_0 . See Remark 5.15.

2.3 Proof of Theorem C: chains of heterocycles

We begin with some preparation lemmas. The first one is proved in section 3.2.1.

Lemma 2.6. *Let S and P be a projectively hyperbolic source and a saddle point forming a heterocycle for a smooth map f . Then for a C^∞ -small perturbation of the dynamics, the source S belongs to a Cantor set R which is a projectively hyperbolic expanding set.*

We introduce the following notion.

Definition 2.7. *A N -chain of alternate heterocycles for a map $f \in \text{Diff}_{loc}(U, M)$ is the data of N saddle points P^1, \dots, P^N and N projectively hyperbolic sources S^1, \dots, S^N such that:*

- the orbits of $P^1, \dots, P^N, S^1, \dots, S^N$ are pairwise disjoint,
- the stable eigenvalues of the saddles P^i are negative,
- $W^u(P^i)$ contains S^i and is transverse to $E_{S^i}^{cu}$ for each $1 \leq i \leq N$,
- $W^{uu}(S^i)$ intersects transversally $W^s(P^{i+1})$ for $1 \leq i < N$ and $W^{uu}(S^N)$ intersects transversally $W^s(P^1)$.

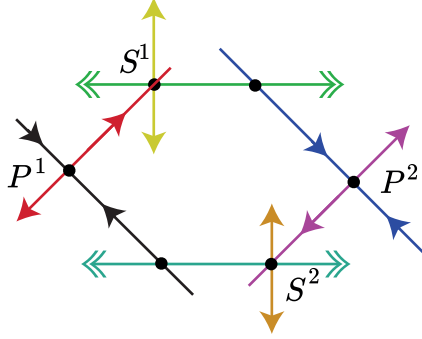

Figure 4: 2-Chain of heterocycles.

Chains of alternate heterocycles may be obtained as follows.

Lemma 2.8. *Consider $f \in \text{Diff}_{loc}^\infty(U, M)$ with a heterocycle between a saddle P with period p and a source S such that the stable eigenvalue of $D_P f^p$ is negative.*

Then, for any $N \geq 1$, there exists \tilde{f} , C^∞ -close to f , with an N -chain of alternate heterocycles whose saddles $P^1 = P, P^2, \dots, P^N$ are homoclinically related to the continuation $P_{\tilde{f}}$.

Proof. By preliminary perturbations one stabilizes the heterocycle and builds a blender K homoclinically related to P , whose activation domain contains S (Theorem B). One also reduces to the case where the source S belongs to a projectively hyperbolic expanding invariant Cantor set R (Lemma 2.6). One can also assume that $W^{uu}(S)$ and $W^s(P)$ have a transverse intersection point. In order to simplify, one will assume that K is topologically mixing (otherwise one has to decompose K into finitely many pieces permuted by the dynamics and whose return map is topologically mixing on each piece). Note that $P^1 = P$ and $S^1 = S$ define a 1-chain of alternate heterocycle. One proves the statement by induction on N . Let us assume that f has a $N - 1$ -chain of alternate heterocycles whose saddles P^i are homoclinically related to P .

One chooses a saddle P^N whose orbit is distinct from the orbits of P^1, \dots, P^{N-1} and which is homoclinically related to P : since $W^{uu}(S^{N-1})$ intersects transversally $W^s(P^1)$, it also intersects transversally $W^s(P^N)$. One also chooses a source $S^N \in R$ in the activation domain of K and whose orbit is distinct from the orbits of S^1, \dots, S^{N-1} ; one can furthermore assume that it is arbitrarily close to S , so that $W^{uu}(S^N)$ intersects transversally $W^s(P)$, hence $W^s(P^1)$. The blender property implies that S^N belongs to the unstable set of K . More precisely there exists $x \in K$ and $y \in W^u(x) \setminus \text{Orbit}(S^N)$ such that $f(y) \in \text{Orbit}(S^N)$. Since K is topologically mixing, $W^u(P^N)$ is dense in the unstable set of K , one can find $y' \in W^u(P^N)$ arbitrarily close to y and whose backward orbit is disjoint from a uniform neighborhood of y . One then perturbs f in a small neighborhood of y and get a map satisfying $\tilde{f}(y') = f(y)$. Consequently P^N and S^N define a heterocycle for \tilde{f} and the properties built at the previous steps of the induction are preserved. \square

The existence of a saddle point with negative stable eigenvalue may be obtained once a saddle belongs to a homocycle, as we recall in the next lemma.

Lemma 2.9. *Let $f \in \text{Diff}_{loc}^\infty(U, M)$ and P be a saddle point with a homoclinic tangency L . Then for a C^∞ -small perturbation \tilde{f} of the dynamics supported on a small neighborhood of L , the saddle P belongs to a basic set which contains a point Q with some period τ and such that the stable eigenvalue of $D_Q \tilde{f}^\tau$ is negative.*

Proof. This is a well-known result. Up to replace L by an iterate, one assumes $L \in W_{loc}^s(P)$. One perturbs f so that the contact of the homoclinic tangency is quadratic. By unfolding the homoclinic tangency, a horseshoe containing P appears. Indeed, one considers a thin rectangle R which is a tubular neighborhood of $W_{loc}^s(P)$. A large iterate $f^\ell(R)$ crosses R twice, with different orientations. In each component of the intersection, a ℓ -periodic point is obtained, and the signs of Df^ℓ along the stable direction differ. See [PT93, chapter 3] for details. \square

Theorem C follows from the next proposition, proved in Section 4.

Proposition 2.10. *For any $d \geq 0$, there exists $N = N(d) \geq 1$ with the following property.*

Consider a C^∞ family $(f_a)_{a \in \mathbb{R}}$ in $\text{Diff}_{loc}^\infty(U, M)$ such that f_0 has a N -chain of alternate heterocycles with saddle points P^i and sources S^i . Then there exists a family $(\tilde{f}_a)_{a \in \mathbb{R}}$, C^∞ -close to $(f_a)_{a \in \mathbb{R}}$, such that the continuations of P^1 and S^N form a C^d -paraheterocycle at $a = 0$.

Remark 2.11. This result is still valid for families parametrized by \mathbb{R}^k , $k \geq 1$ (see Section 4.3). The length of the chain required is then equal to:

$$N(r, k) = \dim_{\mathbb{R}} \{P \in \mathbb{R}[X_1, \dots, X_k] : \deg P \leq r, P(0) = 0\}.$$

Proof of Theorem C. For any large integer $d \geq 1$, Lemma 2.8 and Proposition 2.10 give after a C^∞ -perturbation a C^d -paraheterocycle between the continuation of the saddle P and a projectively hyperbolic source S' . Hence there exists a C^d -small perturbation $(f'_a)_{a \in \mathbb{R}}$ in $\text{Diff}_{loc}^\infty(U, M)$ and an integer N which satisfy $S'_a \in f'^N(W_{loc}^u(P'_{f'_a}))$ for any a close to 0. Since d has been chosen arbitrarily large, the perturbation can be chosen C^∞ -small. \square

2.4 Proof of Theorem A

A consequence of the previous results is the:

Corollary 2.12. *Consider a C^∞ family $(f_a)_{a \in \mathbb{R}}$ in $\text{Diff}_{loc}^\infty(U, M)$ such that f_0 displays a bicycle between a projectively hyperbolic source S_0 and a dissipative saddle point P_0 . Let $r \geq 1$. Then up to a C^r -perturbation of the family, and up to replacing S_0 by another projectively hyperbolic source, we can assume that:*

- (H₀) *There exists a blender K_0 for f_0 whose activation domain contains S_0 .*
- (H₁) *K_0 intersects the repulsive basin of S_0 .*
- (H₂) *P_0 is homoclinically related to K_0 and $W^s(P_0)$ has a robust tangency with the strong unstable foliation \mathcal{F}^{uu} of S_0 .*
- (H₃) *The continuation $(K_a)_{a \in I}$ of K_0 is a C^r -parablender at $a = 0$ and the continuation $(S_a)_{a \in I}$ of S_0 belongs to its activation domain.*

(H_4) In the continuous family of local unstable manifolds defining the activation domain involved in (H_0) and (H_3), each local unstable manifold does not have S_0 as an endpoint and is not tangent to the weak unstable direction of S_0 .

Remark 2.13. The properties (H_0)...(H_4) are C^r -open.

Proof. With Corollary B' Page 11, one first stabilizes the bicycle. By Lemma 2.9, up to a small C^∞ -perturbation, one gets a saddle Q_0 homoclinically related to P_0 whose stable eigenvalue at the period is negative. One thus gets a robust heterocycle between Q_0 and S_0 and Theorem C Page 12 gives a family $(f'_a)_{a \in \mathbb{R}}$, that is C^∞ -close, and displaying a C^∞ -paraheterocycle between the continuation of Q_0 and a projectively hyperbolic source saddles S' . Theorem D Page 13 produces a family C^r -close having a C^r -parablender $(K_a)_{a \in I}$ at $a = 0$ which is homoclinically related to Q_0 (and P_0) and whose activation domain contains the family of source $(S'_a)_{a \in I}$. Denoting the new source by S_0 , we get all the robust properties (H_0), (H_1) and (H_3). By Remark 2.5, (H_4) is also satisfied.

Since P_0 and S_0 form a robust heterocycle, one can assume (after a new perturbation) that the strong unstable manifold $W^{uu}(S_0)$ intersects transversally $W^s(P_0)$. From the robust tangency, we can perturb and produce a homoclinic tangency point L between $W_{loc}^u(P_0)$ and $W^s(P_0)$. The inclination lemma implies that $W^{uu}(S_0)$ accumulates on $W_{loc}^u(P_0)$. A last perturbation near L gives a quadratic tangency between $W^{uu}(S_0)$ and $W^s(P_0)$. For maps close, this tangency admits a continuation which is a quadratic tangency between $W^s(P_0)$ and the leaves of the strong unstable foliation in the repelling basin of S_0 : this is (H_2). \square

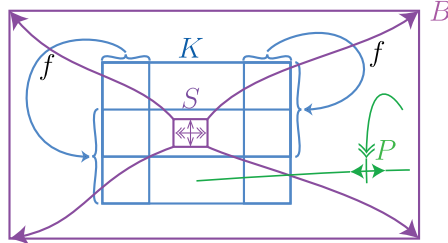

Figure 5: Assumptions (H_0)...(H_4).

We now use the following result of [Ber17, Theorem A, page 11]:

Theorem 2.14. Consider a C^∞ family $(f_a)_{a \in \mathbb{R}}$ in $\text{Diff}_{loc}^\infty(U, M)$ with a projectively hyperbolic source $(S_a)_{a \in \mathbb{R}}$ and a dissipative saddle point $(P_a)_{a \in \mathbb{R}}$ satisfying (H_0)...(H_4). Then, there are $\delta > 0$, a C^r -neighborhood \mathcal{V} of the family $(f_a)_a$ in the space of C^r -families and a Baire-generic subset $\mathcal{G} \subset \mathcal{V}$ such that for any $(\tilde{f}_a)_a \in \mathcal{G}$ and $a \in (-\delta, \delta)$, the map \tilde{f}_a displays infinitely many sinks.

For completeness we sketch its proof.

Idea of the proof of Theorem 2.14. Since the hypothesis are open, they hold for an open neighborhood \mathcal{V} of the initial family. Let us consider an arbitrary family $(f'_a)_{a \in \mathbb{R}}$ in \mathcal{V} . The robust heterocycle provided by (H_0) and (H_1) and Lemma 2.6 allow after a perturbation to assume that there are $\delta > 0$ and two distinct sources $(S_a)_{a \in [-\delta, \delta]}$, $(S'_a)_{a \in [-\delta, \delta]}$ which satisfy (H_0)...(H_4) at every $a_0 \in [-\delta, \delta]$ for each of these sources and for the family $(f'_a)_{a \in \mathbb{R}}$.

Then we apply the following key lemma (which uses (H_3)):

Lemma 2.15 ([Ber17, Prop. 3.6]). *For every $\varepsilon > 0$, there exist $\alpha > 0$ and an ε - C^r -perturbation $(f''_a)_{a \in [-\delta, \delta]}$ localized at $(S_a)_a$ and $(S'_a)_a$ such that:*

1. *for every $j \in 2\mathbb{Z}$, there exists a continuation of a periodic point $(P_a^{(j)})_a$ in the parablender whose local unstable manifold contains S_a for every $a \in [-\delta, \delta] \cap [\alpha j - \alpha/2, \alpha j + \alpha/2]$,*
2. *for every $j \in 2\mathbb{Z} + 1$, there exists a continuation of a periodic point $(P_a^{(j)})_a$ in the parablender whose local unstable manifold contains S'_a for every $a \in [-\delta, \delta] \cap [\alpha j - \alpha/2, \alpha j + \alpha/2]$.*

We continue with:

Lemma 2.16 ([Ber17, Prop. 3.4]). *After a new C^∞ -small perturbation of $(f''_a)_a$, for every $j \in \mathbb{Z} \cap [-\delta/\alpha, \delta/\alpha]$ the point P_a displays a quadratic homoclinic tangency which persists for every $a \in [-\delta, \delta] \cap [\alpha j - \alpha/2, \alpha j + \alpha/2]$.*

Idea of proof of Lemma 2.16. Assume j odd (resp. even) and let us continue with the setting of Lemma 2.15. As P_a and $P_a^{(j)}$ belong to the same transitive hyperbolic set and using Proposition 1.14, after a small perturbation a fixed iterate of the local unstable manifold of P_a contains S_a for every $a \in [-\delta, \delta] \cap [\alpha j - \alpha/2, \alpha j + \alpha/2]$. Then we proceed as depicted in Fig. 6: we denote by W_a^s a segment of $W^s(P_a)$ which is included in a basin of S_a (resp. S'_a) and display a tangency with the strong unstable foliation of the repelling basin of S'_a (resp. S_a) by (H_2) . After perturbation we can assume this tangency quadratic. Then, in the Grassmannian bundle $\mathbb{P}(TM)$ of M , the tangent space TW^s of this curve intersects transversally the unstable manifold of $(S_a, E^{uu}(S_a))$ for the action \hat{f}_a of Df_a on the Grassmannian. By the inclination lemma, the preimages $TW_{n,a}^s$ of TW_a^s , by \hat{f}_a^n , converge to the stable manifold $\{S_a\} \times \mathbb{P}^1 \setminus \{E^{cu}(S_a)\}$ of $(S_a, E^{uu}(S_a))$. By property (H_4) , a piece of $W_{loc}^u(P_a)$ intersects S_a with a direction different from $E^{uu}(S_a)$, hence the stable manifold of $(S_a, E^{uu}(S_a))$ intersects untangentially a piece TW_a^u of $TW_{loc}^u(P_a)$ for every $a \in [-\delta, \delta] \cap [\alpha j - \alpha/2, \alpha j + \alpha/2]$. This enables to perturb $(f_a)_a$ such that $TW_{n,a}^s \subset TW^s(P_a)$ intersects $TW_{loc}^u(P_a)$ for every $a \in [-\delta, \delta] \cap [\alpha j - \alpha/2, \alpha j + \alpha/2]$. \square

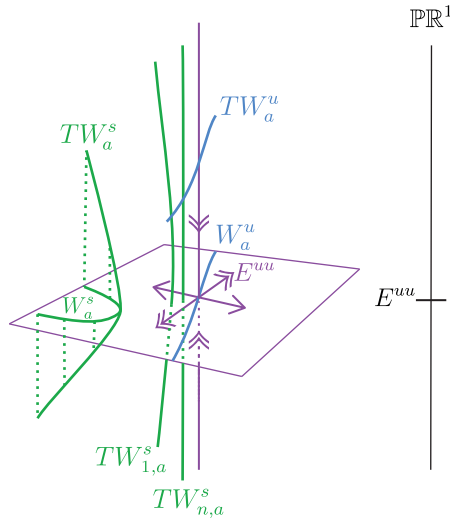

Figure 6: Inclination lemma used in the bundle $\mathbb{P}(TM)$ at $E^{uu}(S_A)$.

In [Ber17, Prop. 3.5] it is shown that for every $N \geq 1$, we can then perturb the family in the C^∞ -topology near the homoclinic tangency of $(P_a)_a$ obtained in Lemma 2.16 so that for every $a \in [\alpha j - \alpha/2, \alpha j + \alpha/2]$ and $j \in \mathbb{Z} \cap [-\delta/\alpha, \delta/\alpha]$, the new map \tilde{f}_a displays a periodic sink of period $\geq N$. Hence we have obtained an open and dense subset in \mathcal{V} of families displaying a sink of period $\geq N$ at every parameter $a \in [-\delta, \delta]$. By taking the intersection \mathcal{G} of these open and dense subsets over $N \geq 1$, we obtain Theorem 2.14. \square

This allows to complete the proof of our main theorem.

Proof of Theorem A. Let us consider a C^r map f with a dissipative bicycle associated to a saddle P . By Corollary B', there exists a C^r -open set $\mathcal{U} \in \text{Diff}_{loc}^r(U, M)$, which contains f in its closure, such that the continuation of P exhibits a robust bicycle for any map in \mathcal{U} .

Let $F := (f_a)_{a \in \mathbb{R}}$ be a C^r -family consisting of maps $f_a \in \mathcal{U}$. By perturbation, one can assume that the family is C^∞ and by Proposition 1.13 that f_0 displays a bicycle. Then, by Corollary 2.12, there exists a new C^r -perturbation which satisfies $(H_0) \cdots (H_4)$. Theorem 2.14 associates a neighborhood \mathcal{V}_F of this family and a dense G_δ -set \mathcal{G}_F of \mathcal{V}_F and $\delta_F > 0$. Let $\{F_n : n \in \mathbb{N}\}$ be a dense countable set in the space of families $(f_a)_{a \in \mathbb{R}} \in \mathcal{D}^r(\mathbb{I} \times U, M)$ consisting of maps $f_a \in \mathcal{U}$. The union $\mathcal{G} = \bigcup \mathcal{G}_{F_n}$ is a dense G_δ subset of this space. By construction, for any family $F = (f_a)_{a \in \mathbb{R}}$ in \mathcal{G} and any $|a|$ smaller than a semi-continuous function δ_F of F , the map \tilde{f}_a exhibits infinitely many sinks for any parameter a close to 0. \square

3 From heterocycles to basic sets and strong heterocycles

In this section we prove Proposition 2.1, Proposition 2.3 and Lemma 2.6.

We consider a C^∞ map $f \in \text{Diff}_{loc}^\infty(U, M)$ with a projectively hyperbolic source S and a saddle point P forming a heterocycle, and we show that by perturbation it can be improved to a strong heterocycle.

In Section 3.1, first we establish local coordinates around P and S . To obtain these coordinates, we need to perturb the dynamics, to assume the eigenvalues non-resonant, but also to ensure two transversality conditions (T_1) - (T_2) . Then nearby P and S , the inverse dynamics \mathcal{P} and \mathcal{S} are linear in local coordinates. Furthermore, the heterocycle defines inverse branches of the dynamics that are transitions from one linearizing chart to the other.

As a direct application of these linearizing charts, we build an IFS and from there an expanding projective hyperbolic set containing the source: this allows to prove Lemma 2.6 at the beginning of Section 3.2). Later, using again these coordinates, we obtain the existence of a non-trivial basic set K which contains P (Lemma 3.1). After a small perturbation, which consists in perturbing the stable eigenvalues of P , the strong unstable manifold of S intersects K , whereas S belongs to $W^u(K)$. This will imply Proposition 2.1. The proof of Proposition 2.3 follows similar lines.

3.1 Local coordinates for a heterocycle

For the sake of simplicity we assume that the periodic points P and S are fixed and that the eigenvalues of $D_P f$ and $D_S f$ are positive. Anyway we can go back to this case by regarding an iterate of the dynamics and performing the forthcoming perturbations nearby finitely many points belonging to different orbits.

Up to a smooth perturbation we can assume that the eigenvalues of $D_P f$ and $D_S f$ are non-resonant. Then Sternberg Theorem [Ste58] implies the existence of:

- neighborhoods $V'_S \subset V_S := f(V'_S)$ of S and coordinates for which $f|_{V'_S}$ has the form:

$$(x, y) \in V'_S \mapsto (\sigma_{uu}^{-1} \cdot x, \sigma_u^{-1} \cdot y) \in V_S \quad \text{with } 0 < \sigma_{uu} < \sigma_u < 1 .$$

- neighborhoods V'_P and $V_P := f(V'_P)$ of P and coordinates for which $f|_{V'_P}$ has the form:

$$(x, y) \in V'_P \mapsto (\sigma^{-1} \cdot x, \lambda^{-1} \cdot y) \in V_P \quad \text{with } 0 < \sigma < 1 < \lambda .$$

This defines the inverse branches $\mathcal{P} := (f|_{V'_P})^{-1}$ and $\mathcal{S} := (f|_{V'_S})^{-1}$:

$$\mathcal{S} : (x, y) \in V_S \mapsto (\sigma_{uu} \cdot x, \sigma_u \cdot y) \in V'_S \quad \text{and} \quad \mathcal{P} : (x, y) \in V_Q \mapsto (\sigma \cdot x, \lambda \cdot y) \in V'_Q .$$

Up to restricting V_P and V'_P and rescaling the coordinates, we can assume:

$$V'_P \equiv [-\sigma, \sigma] \times [-1, 1] \quad \text{and} \quad V_P \equiv [-1, 1] \times [-\lambda^{-1}, \lambda^{-1}] .$$

Let $W_{loc}^u(P) := V_Q \cap \{y = 0\}$, $W_{loc}^s(P) := V'_Q \cap \{x = 0\}$ and $W_{loc}^{uu}(S) := \{y = 0\} \cap V_S$.

Let H be a point in $W^s(P) \cap W^{uu}(S)$. Up to replacing it by an iterate, we can assume that H belongs to V'_P with $H =: (0, h)$ in the linearizing coordinates of P . Up to conjugating the dynamics by $(x, y) \mapsto (x, -y)$, we can assume moreover that $h > 0$. Also, a preimage S' of S has coordinates $S' =: (s, 0)$ in the linearizing coordinates of P :

$$S' \equiv (s, 0) \quad \text{and} \quad H \equiv (0, h) , \quad h > 0 .$$

Furthermore up to a smooth perturbation, we can assume that:

- (T_1) The intersection $W^s(P) \cap W^{uu}(S)$ is transverse at H .
- (T_2) The line $T_S W^u(P)$ is in direct sum with the weak unstable direction E^{cu} of S .
- (T_3) The line $T_S W^u(P)$ is in direct sum with the strong unstable direction E^{uu} of S .

Let $V''_S \Subset V'_S$ and $V_H \Subset V'_P$ be small neighborhoods of S and H ; and let $\mathcal{T}^S : V''_S \hookrightarrow V_P$ and $\mathcal{T}^H : V_H \hookrightarrow V_S$ be inverse branches of iterates of f such that $\mathcal{T}^S(S) = S'$ and $\mathcal{T}^H(H) \in W_{loc}^{uu}(S)$.

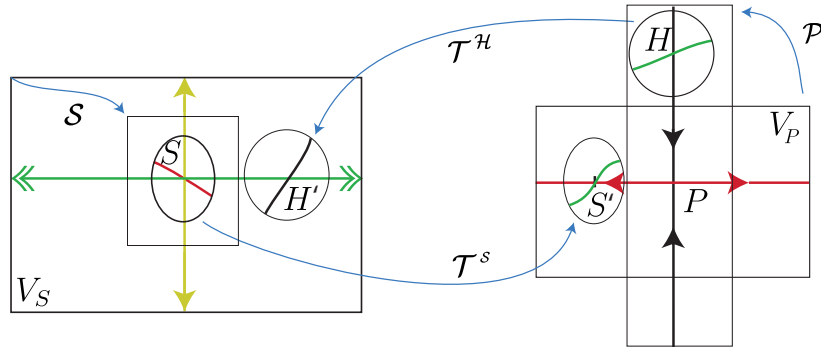

Figure 7: Inverse branches $\mathcal{S}, \mathcal{P}, \mathcal{T}^S, \mathcal{T}^H$ induced by the heterocycle.

3.2 Basic sets induced by a heterocycle

We now build two hyperbolic sets: one expanding projective hyperbolic set containing the source, and a saddle hyperbolic set containing the saddle.

3.2.1 Proof of Lemma 2.6: expanding Cantor set linked to the heterocycle

Note that for n large, the point $(s, \lambda^{-n}h)$ belongs to the range of \mathcal{T}^s . We perturb f near the point S' and define a map \tilde{f} which satisfies in coordinates

$$\tilde{f}(s, \lambda^{-n}h) = f(S').$$

This in turn defines a perturbation $\widetilde{\mathcal{T}}^s$ of the inverse branch \mathcal{T}^s .

As the point $(s, \lambda^{-n}h)$ is sent by \mathcal{P}^n to the $(\sigma^n \cdot s, h) \in V_H$, the map $\mathcal{T}^u \circ \mathcal{P}^n \circ \widetilde{\mathcal{T}}^s$ is well defined on a neighborhood W of S . Hence for N large compared to n , the maps $\mathcal{S}_1 := \mathcal{S}^N \circ \mathcal{T}^u \circ \mathcal{P}^n \circ \widetilde{\mathcal{T}}^s$ and $\mathcal{S}_2 := \mathcal{S}^N$ are contractions from W into W with disjoint images. So they define a transitive expanding Cantor set R for \tilde{f} which contains S .

Let us fix $\eta > 0$ small and introduce the cone $\mathcal{C} := \{(u, v) : |u| < \eta|v|\}$. Using (T₁), (T₂) and assuming that n, N have been chosen large enough, for any $x \in W$, the maps $D_x \mathcal{S}_1$ and $D_x \mathcal{S}_2$ send $\bar{\mathcal{C}}$ inside $\mathcal{C} \cup \{0\}$. The cone field criterion (see for instance [Yoc95]) implies that the Cantor set R is projectively hyperbolic. The Lemma 2.6 is proved. \square

3.2.2 Basic sets linked to the heterocycle

The heterocycle configuration implies under the transversality assumptions (T₁) and (T₂) that the saddle P has a transverse homoclinic intersection.

Lemma 3.1. *For all n large, the subsegment:*

$$W_{loc}^s(\bar{H}) := \mathcal{T}^s \circ \mathcal{S}^n \circ \mathcal{T}^u(W_{loc}^s(P) \cap V_H)$$

of $W^s(P)$ intersects transversally the local unstable manifold $W_{loc}^u(P)$ at a point \bar{H} which is $\asymp \sigma_{uu}^n$ -close to S' . The endpoints of $W_{loc}^s(\bar{H})$ are $\asymp \sigma_u^n$ -distant from $W_{loc}^u(P)$.

Proof. Let $\Gamma := W_{loc}^s(P) \cap V_H$. This curve is sent by \mathcal{T}^u to a curve which intersects transversally $W_{loc}^{uu}(S)$ by (T₁). By projective hyperbolicity, the image by \mathcal{S}^n of $\mathcal{T}^u(\Gamma)$ is a curve which is tangent to a thin vertical cone field, which is $\asymp \sigma_{uu}^n$ -close to S and which has length $\asymp \sigma_u^n$. As $(\mathcal{T}^s)^{-1}(\{y = 0\})$ intersects transversally $\{x = 0\} \cap V_S$ at S by (T₂), it must intersect transversally $\mathcal{S}^n \circ \mathcal{T}^u(\Gamma)$ for n large. Consequently the curve $\mathcal{T}^s \circ \mathcal{S}^n \circ \mathcal{T}^u(\Gamma)$ intersects the local unstable manifold $\{y = 0\} \cap V_P$ of P . \square

By Smale's horseshoe theorem (see [PT93, chapter 2]), one deduces:

Corollary 3.2. *There exists a basic set K containing P and \bar{H} .*

We will make it more precise. If N is large, K can be spanned by the inverse branches

$$\mathcal{G}_1 := \mathcal{P}^N \quad \text{and} \quad \mathcal{G}_2 := \mathcal{T}^s \circ \mathcal{S}^n \circ \mathcal{T}^u \circ \mathcal{P}^N.$$

Let $\varepsilon > 0$ be small enough so that $\{0\} \times [h - \varepsilon, h + \varepsilon]$ is included in V_H and let (see Fig. 8):

$$B := [-1, 1] \times \left[\frac{h - \varepsilon}{\lambda^N}, \frac{h + \varepsilon}{\lambda^N} \right].$$

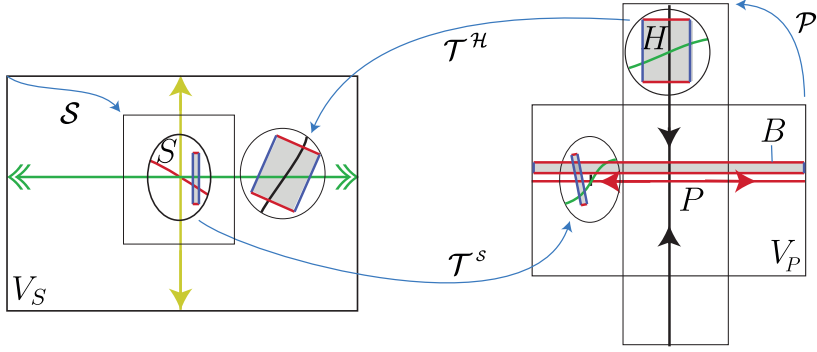

Figure 8: The box B and its images.

Lemma 3.3. *For every n, N large, the map \mathcal{G}_2 is well defined on B . If $\varepsilon \sigma_u^n \lambda^N \gg 1$, the map \mathcal{G}_2 displays a saddle fixed point \bar{Q} in $B \cap K$, which is homoclinically related to P .*

Proof. The box B is sent by \mathcal{P}^N to $(0, h) + [-\sigma^N, \sigma^N] \times [-\varepsilon, \varepsilon]$ which is included in V_H for N large enough. As $\mathcal{S}^n \circ \mathcal{T}^h(V_H)$ is included in V_S'' for n large enough, the map g is well defined on B . Let us decompose the boundary of B :

$$\partial^s B := \{-1, 1\} \times \left[\frac{h - \varepsilon}{\lambda^N}, \frac{h + \varepsilon}{\lambda^N} \right] \quad \text{and} \quad \partial^u B = \partial B \setminus \partial^s B.$$

Both curves of $\mathcal{S}^n \circ \mathcal{T}^h \circ \mathcal{P}^N(\partial^s B)$ are σ_{uu}^n close to the vertical arc $W_{loc}^c(S) := \{0\} \times [-1, 1]$ and their endpoints are $\asymp \varepsilon \cdot \sigma_u^n$ distant to $W_{loc}^{uu}(S)$ by transversality (T_1) at $\mathcal{T}^h(H)$ and by projective hyperbolicity of S . Thus they intersect transversally $(\mathcal{T}^s)^{-1}(W_{loc}^u(P))$ by property (T_2) .

Consequently $\mathcal{G}_2(B)$ intersects $W_{loc}^u(P)$, and $\mathcal{G}_2(\partial^u B)$ is $\asymp \varepsilon \cdot \sigma_u^n$ distant to $W_{loc}^u(P)$. By assumption, λ^{-N} is small compared to $\varepsilon \cdot \sigma_u^n$, then $\mathcal{G}_2(B)$ crosses B : it does not meet the vertical boundary $\partial^s B$, whereas B does not meet the horizontal boundary $\mathcal{G}_2(\partial^u B)$. Thus \mathcal{G}_2 displays a fixed point \bar{Q} in $B \cap \mathcal{G}_2(B)$.

Note that $D\mathcal{G}_2$ expands vectors in a vertical cone by a factor $\asymp \lambda^N \cdot \sigma_u^n$, which is large, and the image of these vectors are uniformly transverse to the horizontal. On the other hand by projective hyperbolicity $D\mathcal{G}_2^{-1}$ sends the vectors in an horizontal cone to uniformly horizontal vectors and expands them by a factor $\sigma_{uu}^{-n} \cdot \sigma^{-N}$. The point \bar{Q} is a saddle, its local unstable manifold is an horizontal graph in B over $[-1, 1]$ whereas its local stable manifold connects the two curves in $\mathcal{G}_2(\partial^u B)$ and so crosses the horizontal $W_{loc}^u(P)$. This shows that \bar{Q} and P are homoclinically related as required. \square

3.2.3 Replacement of the saddle point

Let us consider a saddle periodic point Q homoclinically related to P . The following allows to replace the saddle P by Q in the heterocycle.

Lemma 3.4. *Let Q be a periodic saddle point that is homoclinically related to P . Then there exists a map \tilde{f} that is C^∞ close to f such that S and Q form a heterocycle.*

One can choose \tilde{f} to coincide with f outside an arbitrarily small neighborhood of $f^{-1}(S) \setminus \{S\}$. In particular if $W^{uu}(S; f)$ contains Q , then S and Q form a strong heterocycle for \tilde{f} .

Proof. By assumption, there exists a point $z \in W^u(P) \cap f^{-1}(S) \setminus \{S\}$. Let Q_{-1} be the forward iterate of Q which satisfies $f(Q_{-1}) = Q$. Since Q_{-1} is homoclinically related to P , there exists $z' \in W^u(Q_{-1})$ arbitrarily close to z having a backward orbit which converges to the orbit of Q and which avoids a uniform neighborhood of z .

Hence, there exists a C^∞ -small perturbation of f supported on a small neighborhood of z satisfying $\tilde{f}(z') = f(z)$. In particular $W^u(Q)$ contains S . \square

We state a parametric version of the previous lemma.

Lemma 3.5. *Consider a C^∞ family $(f_a)_{a \in \mathbb{R}}$ in $\text{Diff}_{loc}^\infty(U, M)$, and, for $r \geq 1$, families of saddles $(P_a)_{a \in \mathbb{R}}$ and of projectively hyperbolic sources $(S_a)_{a \in \mathbb{R}}$ exhibiting a C^r -paraheterocycle at $a = 0$. If $(Q_a)_{a \in \mathbb{R}}$ is a family of saddles homoclinically related to $(P_a)_{a \in \mathbb{R}}$, then there exists $(\tilde{f}_a)_{a \in \mathbb{R}}$, C^∞ -close to $(f_a)_{a \in \mathbb{R}}$ such that Q_0 and S_0 form a C^r -paraheterocycle at $a = 0$.*

One can choose $(\tilde{f}_a)_{a \in \mathbb{R}}$ to coincide with $(f_a)_{a \in \mathbb{R}}$ outside an arbitrarily small neighborhood of $f_0^{-1}(S_0) \setminus \{S_0\}$. Hence if $Q_0 \in W^{uu}(S_0; f_0)$, then S_0, Q_0 form a strong heterocycle for \tilde{f}_0 .

Proof. Let $(K_a)_{a \in I}$ be a basic set that contains P_a and Q_a for a in a neighborhood I of 0. Let \underline{P} and \underline{Q} be the periodic lifts of P and Q in \overleftarrow{K} . By assumption, there exists a choice of local unstable manifolds $W_{loc}^u(\underline{z}, f_a)$ for $\underline{z} \in \overleftarrow{K}$ and $N \geq 1$ such that $d(S_a, f^N(W_{loc}^u(\underline{P}_a))) = o(|a|^r)$. Since P and Q are homoclinically related, there exists a sequence of points $\underline{z}_n \in \overleftarrow{K}$ which converges to \underline{P} and which belong to $W_{loc}^u(\underline{Q})$. Since $W_{loc}^u(\underline{z}; f_a)$ varies continuously with \underline{z} for the C^∞ -topology, when n is large there exists a family $(\tilde{f}_a)_{a \in \mathbb{R}}$, which is C^∞ -close to $(f_a)_{a \in \mathbb{R}}$, such that $d(S_a, \tilde{f}_a^N(W_{loc}^u(\underline{z}_n, \tilde{f}_a))) = o(|a|^r)$. There exists a large integer $\ell \geq 1$ such that $\tilde{f}_a^N(W_{loc}^u(\underline{z}_n, \tilde{f}_a)) \subset \tilde{f}_a^\ell(W_{loc}^u(\underline{Q}_a, \tilde{f}_a))$, hence $d(S_a, \tilde{f}_a^\ell(W_{loc}^u(\underline{Q}_a, \tilde{f}_a))) = o(|a|^r)$ as in the definition of C^r -paracycle. Note that the perturbation can be supported on a neighborhood of a point in $f_0^{-1}(S_0) \setminus \{S_0\}$. \square

3.3 Proof of Proposition 2.1: from heterocycles to strong heterocycles

The main step in the proof of Proposition 2.1 is contained in the following lemma.

Lemma 3.6. *Let us assume that both stable branches of P intersect $W^u(P)$ transversally. Then there exists a map \tilde{f} , C^∞ -close to f , with a saddle Q homoclinically related to $P_{\tilde{f}}$ such that:*

- f and \tilde{f} coincide on $W_{loc}^u(P)$ and outside a small neighborhood of P ,
- $W^{uu}(S, \tilde{f})$ contains Q .

Proof. From (T_1) , the curves $W_{loc}^{uu}(S)$ and $\mathcal{S}^n \circ \mathcal{T}^n(W_{loc}^s(P) \cap V_H)$ intersect transversally at a point whose image under \mathcal{T}^s is denoted as $[S', \bar{H}]$, see Fig. 9.

We can reduce to the case depicted on the left part of Fig. 9, where $[S', \bar{H}]$ belongs to the half upper plane $\{y > 0\}$ (for the chart of V_P). Indeed if we are in the other case (depicted on the right part of Fig. 9), we use the fact that the stable branch $\{0\} \times [-1, 0]$ of P has backward iterates which accumulate on $W_{loc}^s(P)$ in order to replace H by a point $H' = (0, h')$, $h' < 0$, which is a transverse intersection between $W^s(P)$ and $W^{uu}(S)$. The new point $[S', \bar{H}']$ is close to $[S', \bar{H}]$, hence belongs to the lower half plane. It remains to conjugate the chart by $(x, y) \mapsto (x, -y)$ in order to find the desired configuration.

Let us consider some large integers n, N , the map \mathcal{G}_2 and the box B defined at Section 3.2.2. The transversality conditions (T_2) and (T_3) imply that $\mathcal{T}^n(W_{loc}^{uu}(S))$ crosses the box $\mathcal{G}_2(B)$ along

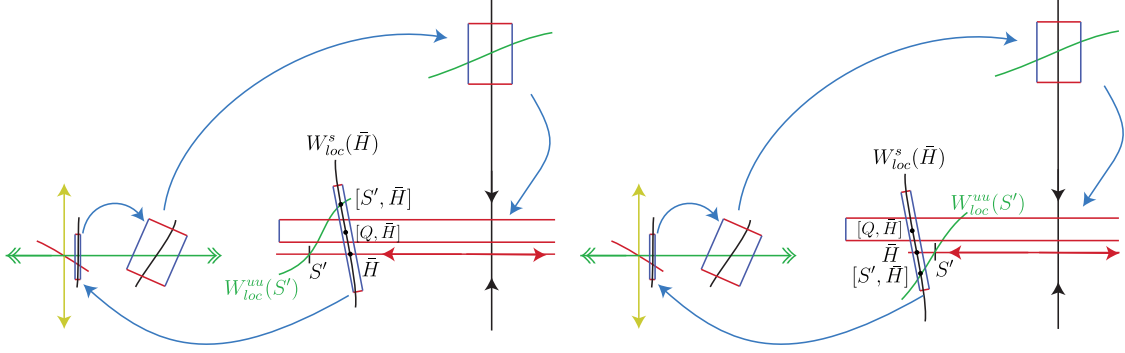

Figure 9: The two cases for the position of $[S', \bar{H}]$.

a small curve whose vertical coordinate belongs to an interval $[c_1 \cdot \sigma_{uu}^n, c_2 \cdot \sigma_{uu}^n]$, where c_1, c_2 are independent from the choice of n, N .

We choose n, N such that

$$(3.1) \quad (h - \varepsilon)\lambda^{-N-1} < c_2 \sigma_{uu}^n < (h - \varepsilon)\lambda^{-N}.$$

Note that the condition $\varepsilon \sigma_u^n \lambda^N \gg 1$ is satisfied and Lemma 3.3 associates a saddle point $\bar{Q} \in B$ whose vertical coordinates is in $[(h - \varepsilon)\lambda^{-N}, (h + \varepsilon)\lambda^{-N}]$. By the previous estimates, \bar{Q} is “above” the graph $\mathcal{T}^{\mathcal{H}}(W_{loc}^{uu}(S))$.

Now we consider a family $(f_t)_{t \in [0,1]}$ such that $f_0 = f$, and for every t , the restrictions of f_t to $W_{loc}^u(P)$ and to the complement of a neighborhood of V_P' coincide with f , while the restriction of the map $f_t|_{V_P'}$ is still linear with eigenvalues (λ_t, σ) such that:

$$\lambda_t = \frac{\lambda}{\sqrt[N]{1+t \cdot (C-1)}} \quad \text{with } C = \frac{c_1 h - \varepsilon}{c_2 h + \varepsilon} \cdot \lambda^{-1}.$$

Note that $(f_t)_{t \in [0,1]}$ is a smooth family which is C^∞ -close to be constantly equal to f since n is large. The map $\mathcal{S}, \mathcal{T}^s, \mathcal{T}^{\mathcal{H}}$ are unchanged, while $\mathcal{P}_t^p := (x, y) \in V_P \mapsto (\sigma \cdot x, \lambda_t \cdot y)$ depends on a . Any map of this family satisfies the assumptions of Section 3.2.2. Let $(\bar{Q}_t)_{t \in [0,1]}$ be the hyperbolic continuation of \bar{Q} . The vertical coordinate of \bar{Q}_1 is bounded by

$$(h + \varepsilon)\lambda_1^{-N} = C \cdot (h + \varepsilon) \cdot \lambda^{-N} = (h - \varepsilon) \cdot \lambda^{-N-1} \frac{c_1}{c_2},$$

From (3.1), it is smaller than $c_1 \cdot \sigma_{uu}^n$, hence \bar{Q}_1 is “below” the graph $\mathcal{T}^{\mathcal{H}}(W_{loc}^{uu}(S))$. One deduces that there exists a parameter such that \bar{Q}_t belongs to $\mathcal{T}^{\mathcal{H}}(W_{loc}^{uu}(S))$. This implies that \bar{Q}_t has an iterate Q which belongs to $W_{loc}^{uu}(S)$. \square

Proof of Proposition 2.1 in the C^∞ case. One considers a basic set K provided by Corollary 3.2. It contains a periodic saddle P' homoclinically related to P such that both of its stable branches intersects $W^u(P')$ transversally. The Lemma 3.4 allows by a first perturbation \tilde{f}_1 to replace P by the saddle P' so that the assumptions of the Lemma 3.6 are satisfied. One can then build a new perturbation \tilde{f}_2 such that $W^{uu}(S, \tilde{f}_2)$ contains a saddle Q which is homoclinically related to P and P' , whereas the heterocycle between S and P' is not destroyed (since the perturbation does not modify S nor $W_{loc}^u(P')$). After a third perturbation \tilde{f}_3 provided by Lemma 3.4, a strong heterocycle between Q and S is obtained. \square

3.4 Proof of Proposition 2.1 in the analytic case

Now we assume $f \in \text{Diff}_{loc}^\omega(U, M)$ and as before f displays a heterocycle between a saddle P and a source S . To prove Proposition 2.1 in the analytic case, it suffices to show the following counterparts of Lemmas 3.4 and 3.6.

Lemma 3.7. *Let Q be a periodic saddle point that is homoclinically related to P . Then there exists a map \tilde{f} that is C^ω close to f such that S and Q form a heterocycle.*

If $W^{uu}(S; f)$ contains Q , then, one can choose \tilde{f} so that S and Q form a strong heterocycle.

Lemma 3.8. *Let us assume that both stable branches of P intersect $W^u(P)$ transversally. Then there exists a map \tilde{f} , C^ω -close to f , with a saddle Q homoclinically related to $P_{\tilde{f}}$ such that:*

- $W^{uu}(S, \tilde{f})$ contains Q .
- $W^u(P, \tilde{f})$ contains S .

Proof of Lemma 3.7. First recall that M is analytically embedded into an Euclidean space \mathbb{R}^N , see [Gra58]. Hence there exists an analytic retraction $\pi : U \rightarrow M$ of a neighborhood U of M in \mathbb{R}^N . Let $W_{loc}^u(P)$ be a local unstable manifold of P which contains S in its interior and let $S' \neq S$ in $W_{loc}^u(P)$ such that $f(S') = S$. Let $V_{S'}$ be a small neighborhood of S' such that the backward orbit of S' inside $W_{loc}^u(P)$ does not meet S' . One takes an analytic chart $\phi : V_{S'} \rightarrow [-1, 1]^2$ sending S' to 0 and $V_{S'} \cap W_{loc}^u(P)$ to $[-1, 1] \times \{0\}$.

Now consider a C^∞ -family $(f_p)_{p \in [-\varepsilon, \varepsilon]}$ such that $f_0 = f$ and each f_p is equal to f outside $V_{S'}$ while on a smaller neighborhood of S' , the map f_p coincides with the composition of f with a translation of vector $(0, p)$. In particular the continuation of $W_{loc}^u(P)$ for f_p inside $V_{S'}$ is equal to $W_{loc}^u(P)$, while the continuations S_p of S and of its preimage $S'_p = f^{-1}(S) \cap V_{S'}$ satisfy that $\partial_p S'_p|_{p=0}$ has non-zero second coordinate. Remark that $\chi := Df^{-1} \circ (\partial_p f_p|_{p=0})$ is a smooth vector field defined on the compact subset $\bar{U} \subset \mathbb{R}^N$. Then by Stone-Weierstrass Theorem, there exists a polynomial vector fields $\tilde{\chi} \in \mathbb{R}[X_1, \dots, X_N]$ whose restriction to \bar{U} is C^1 -close χ . Also by reducing $\varepsilon > 0$, the following is well defined for any $|p| < \varepsilon$:

$$\tilde{f}_p := x \in U \mapsto \pi(f(x) + p \cdot Df \circ \tilde{\chi}(x)) .$$

Note that $\partial_p \tilde{f}_p|_{p=0} = Df \circ \tilde{\chi}$ is C^1 -close to $\partial_p f_p|_{p=0}$. In particular the hyperbolic continuation $(\tilde{S}'_p)_{p \in [-\varepsilon, \varepsilon]}$ of S' for $(\tilde{f}_p)_p$ is family C^1 -close to $(\tilde{S}'_p)_{p \in [-\varepsilon, \varepsilon]}$. Also the hyperbolic continuation $(W_{loc}^u(P, \tilde{f}_p))_{p \in [-\varepsilon, \varepsilon]}$ is a family of curves C^1 -close to the family constantly equal to $[-1, 1] \times \{0\}$. Hence assuming that the C^1 -size of the perturbation is small, the curve $\Gamma := \bigcup_{p \in [-\varepsilon, \varepsilon]} \{\tilde{S}'_p\} \times \{p\}$ intersects transversally the surface $\Sigma := \bigcup_{p \in [-\varepsilon, \varepsilon]} W_{loc}^u(P, \tilde{f}_p) \times \{p\}$ at $\{S'\} \times \{0\}$.

By the inclination lemma with parameter, see [Ber17, Lemma 3.2], there exists a sequence $(W_{n,p})_n$ of p -families of segments $W_{n,p} \subset W^u(Q, f_p)$ such that the sequence of surfaces $\Sigma_n := \bigcup_{p \in [-\varepsilon, \varepsilon]} W_{n,p} \times \{p\}$ converges to Σ in the C^1 -topology as $n \rightarrow \infty$. Thus when n is large, the curve Γ intersects Σ_n at a point close to $\{S'\} \times \{0\}$. Hence there is p arbitrarily small such that the continuations of S' and Q form a heterocycle for \tilde{f}_p . This proves the first part of the lemma since \tilde{f}_p is C^ω -close to f when p is small.

In the second part of the lemma, the saddle Q belongs to a local strong unstable manifold $W_{loc}^{uu}(S)$ of S and one performs a similar construction. Let $Q' \neq Q$ in $W_{loc}^{uu}(S)$ which satisfies $f(Q') = Q$, let $V_{Q'}$ be a small neighborhood of Q' , and consider a chart $\psi : V_{Q'} \rightarrow [-1, 1]^2$ sending Q' to 0 and $V_{Q'} \cap W_{loc}^{uu}(Q)$ to $[-1, 1] \times \{0\}$. One considers a C^∞ family of maps which are equal to f outside $V_{Q'}$ and which coincide with the composition of f with a translation of

vector $(0, q)$ on a small neighborhood of Q' : it induces a vector field ξ , that can be approximated by a polynomial vector field $\tilde{\xi}$. Up to shrinking $\varepsilon > 0$, for every $(p, q) \in [-\varepsilon, \varepsilon]^2$, the following is well defined:

$$\tilde{f}_{p,q} := x \in M \mapsto \pi(f(x) + p \cdot Df \circ \tilde{\chi}(x) + q \cdot Df \circ \tilde{\xi}(x)) .$$

Similarly we can consider the continuation $\tilde{S}_{p,q}$ of S , $\tilde{Q}_{p,q}$ of Q , $W_{loc}^u(P, \tilde{f}_{p,q})$ of $W_{loc}^u(P, f)$, $W_{n,p,q}$ of $W_{n,p}$ and $W_{loc}^u(Q, \tilde{f}_{p,q})$ of $W_{loc}^u(Q)$.

From the first part of the proof, $W_{loc}^u(P, \tilde{f}_{p,q})$ contains $\tilde{S}_{p,q}$ when (p, q) belongs to graphs γ_n that are arbitrarily C^1 -close to the curve $p = 0$ when $n \rightarrow \infty$. By a similar argument, $W_{loc}^{uu}(S, \tilde{f}_{p,q})$ contains $\tilde{Q}_{p,q}$ when (p, q) belongs to a one-dimensional submanifold σ that contains 0, is C^1 -close to the curve $q = 0$. In particular σ is transverse to the graphs γ_n . Thus the conclusion of the lemma holds for some map $\tilde{f}_{p,q}$ with $(p, q) \in \gamma_n \cap \sigma$ which is C^ω -close to f when n is large and p, q are small. This implies the second part of the lemma. \square

Proof of Lemma 3.8. The proof of Lemma 3.6 was obtained using a smooth family which changes the stable eigenvalue of P , without changing the relative position of S w.r.t. $W_{loc}^u(P; f)$. To obtain the analytic setting, as above, we approximate this family by an analytic one and we add an extra parameter which varies the relative position of S w.r.t. $W_{loc}^u(P; f)$. While the first parameter enables to find a saddle Q homoclinically related to P such that $Q \in W_{loc}^{uu}(S)$, in the analytic setting this unfolding might unfold also the heterocycle. However the new second parameter enables to restore it. \square

3.5 Proof of Proposition 2.3: from paraheterocycles to strong paraheterocycles

We follow the proof of the Proposition 2.1 in the C^∞ case. After a first C^∞ -small perturbation of f_0 (and hence of the family $(f_a)_{a \in \mathbb{R}}$), there exists a saddle Q homoclinically related to P which belongs to $W_{loc}^{uu}(S)$. The paracycle property (1.1) between S and P may not hold anymore, but by a new perturbation, with a similar size, it can be restored. Note that it is supported near $f^{-1}(S) \setminus \{S\}$, hence the property $Q \in W_{loc}^{uu}(S)$ is not destroyed. Finally one applies lemma 3.5, and gets a C^∞ -small perturbation of the family $(f_a)_{a \in \mathbb{R}}$ in order to get a strong C^r -paraheterocycle at $a = 0$ between S and Q . \square

4 From chains of heterocycles to paraheterocycles

We prove Proposition 2.10 in this section: an N -chain of alternate heterocycles whose saddles are homoclinically related, can be perturbed as a C^d -paraheterocycle, provided that N is large enough with respect to d . This is shown by induction on d . The case $d = 0$ follows from the continuity of the family (without any perturbation). The induction step is given by:

Proposition 4.1. *Consider a C^∞ family $(f_a)_{a \in \mathbb{R}}$ in $\text{Diff}_{loc}^\infty(U, M)$ and $d \geq 0$ such that f_0 has a 2-chain of alternate heterocycles with saddle points P^1, P^2 and sources S^1, S^2 such that (P^1, S^1) and (P^2, S^2) form two C^d -paraheterocycles at $a = 0$. Then there is a C^∞ -perturbation of $(f_a)_{a \in \mathbb{R}}$ such that the continuation of (P^1, S^2) forms a C^{d+1} -paraheterocycle at $a = 0$.*

Moreover the perturbation is supported on a small neighborhood of $\text{orbit}(S^1) \cup \text{orbit}(S^2)$.

Proof of Proposition 2.10. One considers a 2^d -chain of alternate heterocycles with periodic points $P^1, S^1, \dots, P^{2^d}, S^{2^d}$. Proposition 4.1 allows to perform a perturbation at $\text{orbit}(S^1) \cup \text{orbit}(S^2)$, such that P^1 and the continuation of S^2 form a C^1 -paraheterocycle.

Note that $P^1, S^2, P^3, S^3, \dots, P^{2^d}, S^{2^d}$ is still a $2^d - 2$ -chain of alternate heterocycles. By induction, one gets a 2^{d-1} -chain of alternate heterocycles $P^1, S^2, \dots, P^{2^{d-1}}, S^{2^d}$ such that $P^{2^{i+1}}, S^{2^{i+2}}$ form a C^1 -paraheterocycle at $a = 0$, for each $0 \leq i < 2^{d-1}$.

By a new perturbation supported near the sources, one gets a 2^{d-2} -chain of alternate heterocycles $P^1, S^4, \dots, P^{2^{d-3}}, S^{2^d}$ such that each pair $P^{4^{i+1}}, S^{4^{i+4}}$ forms a C^2 -paraheterocycle at $a = 0$. Repeating this construction inductively, one gets a C^d -paraheterocycle at $a = 0$ between P^1 and the continuation of S^{2^d} . \square

Proposition 4.1 is proved in the next two subsections. In Section 4.3 we discuss the case where there are several parameters.

4.1 Notations and local coordinates

The setting is similar to Section 3.1 and depicted Fig. 10. We choose a large integer r and a small number $\varepsilon > 0$, we look for a smooth perturbation of $(f_a)_{a \in \mathbb{R}}$ which is ε - C^r -small and such that the continuation of (P^1, S^2) forms a C^{d+1} -paraheterocycle at $a = 0$.

As in Section 3 we shall assume that the points P^2 and S^1 are fixed. We denote by $|\sigma_a| < 1$ and $\lambda_a < -1$ (resp. by $|\sigma_a^{uu}| < |\sigma_a^u| < 1$) the inverse of the eigenvalues of the tangent map of f_a at P_a^2 (resp. at S_a^1).

After a small perturbation we can assume that the eigenvalues are non-resonant and:

$$\frac{\log |\sigma_0^u|}{\log |\lambda_0|} \in \mathbb{R} \setminus \mathbb{Q}.$$

Then by [Tak71], there exist:

- neighborhoods $V'_S(a) \subset V_S(a) := f_a(V'_S(a))$ of S_a^1 endowed with coordinates depending C^r on the parameter and for which the inverse branch $\mathcal{S}_a := (f_a|_{V'_S})^{-1}$ has the form:

$$\mathcal{S}_a : (x, y) \in V_S \mapsto (\sigma_a^{uu} \cdot x, \sigma_a^u \cdot y) \in V'_S$$

- neighborhoods $V'_P(a)$ and $V_P(a) := f_a(V'_P(a))$ of P_a^2 endowed with coordinates depending C^r on the parameter and for which the inverse branch has the form:

$$\mathcal{P}_a : (x, y) \in V_P(a) \mapsto (\sigma_a \cdot x, \lambda_a \cdot y) \in V'_P(a).$$

Up to restricting V_P, V'_P and V_S we can assume them equal to filled rectangles containing 0 in their interior. We define:

$$W_{loc}^u(P_a^2) \equiv V_P(a) \cap \{y = 0\}, \quad W_{loc}^s(P_a^2) \equiv V'_P(a) \cap \{x = 0\} \quad \text{and} \quad W_{loc}^{uu}(S_a^1) \equiv \{y = 0\} \cap V_S(a).$$

Let H_0 be a point in $W^s(P_0^2) \cap W^{uu}(S_0^1)$. Up to replacing it by an iterate, we can assume that H_0 belongs to $V'_P(0)$ with $H_0 \equiv (0, h_0)$ in the linearizing coordinates of P_0^2 .

Also, a preimage $S_a'^2$ of S_a^2 by an iterate of f_a has coordinates $S_a'^2 = (x_a, y_a)$ in the linearizing coordinates of P_a^2 . Let $\mathcal{T}_a : V_H \hookrightarrow V_S$ be an inverse branches of an iterate of f_a defined on a neighborhood $V_H \Subset V'_P$ of H_0 and such that \mathcal{T}_0 sends H_0 into $W_{loc}^{uu}(S_0^1)$.

Up to a smooth perturbation, one can require that:

(T₁) $W^u(P^1)$ is transverse to $E_{S^1}^{cu}$ at S^1 ,

(T₂) $W_{loc}^{uu}(S_0^1)$ and $W_{loc}^s(P_0^2)$ are transverse at H_0 .

By (T₁), $W^u(P_a^1)$ contains a graph in the chart at S_a^1 , over a neighborhood $I \subset \mathbb{R}$ of 0:

$$\Gamma_a \equiv \{(x, \gamma_a(x)); x \in I\}.$$

By (T₂), the transverse intersection H_0 admits a continuation H_a for a close to 0. One sets

$$H_a \equiv (0, h_a) \quad \text{and} \quad \mathcal{T}_a(H_a) = (z_a, 0).$$

Since (P^1, S^1) and (P^2, S^2) form two C^d -paraheterocycles at $a = 0$, one has for any $0 \leq k \leq d$,

$$\partial_a^k \gamma_a(0)|_{a=0} = 0 \quad \text{and} \quad \partial_a^k y_a|_{a=0} = 0.$$

Up to a small perturbation, one can also assume that

$$\partial_a^{d+1} \gamma_a(0)|_{a=0} \neq 0 \quad \text{and} \quad \partial_a^{d+1} y_a|_{a=0} \neq 0.$$

Figure 10 summarizes the notations.

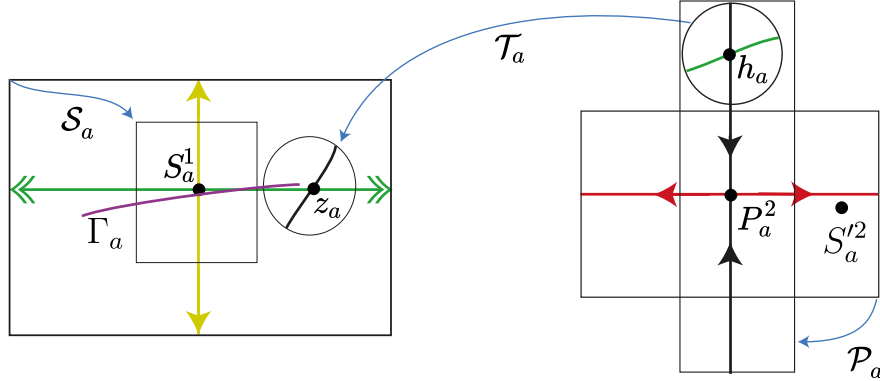

Figure 10: Notations.

4.2 Compositions nearby a paraheterocycle

Let Δ be the second coordinate of $\partial_y \mathcal{T}_0(H_0)$; it is nonzero by (T₂).

Lemma 4.2. *Given integers $n, m \geq 1$ large such that $(\sigma_0^u)^n \lambda_0^m = O(1)$, there is a C^r -perturbation of $(f_a)_a$ localized at S_a^2 such that the germ at $a = 0$ of $a \mapsto S_a^n \circ \mathcal{T}_a \circ \mathcal{P}_a^m(S_a'^2)$ is C^{d+1} -close to*

$$\left(0, (\sigma_0^u)^n \cdot \Delta \cdot \lambda_0^m \cdot \frac{\partial_a^{d+1} y_a|_{a=0}}{(d+1)!} a^{d+1}\right).$$

Proof. For m large, after a C^r -small perturbation localized at S_a^2 (which is conjugated to a translation in a small neighborhood of S_a^2), we can assume $S_a'^2 = (x_a, y_a + \varepsilon_a)$ where $a \mapsto \varepsilon_a$ is the C^∞ -small function defined by $\varepsilon_a := \lambda_a^{-m} \cdot h_a$ and where as before (x_a, y_a) are the coordinates of $S_a'^2$ before the perturbation.

Then observe that $\mathcal{P}_a^m(S_a'^2) = H_a + (\sigma_a^m \cdot x_a, \lambda_a^m \cdot y_a)$ forms a family whose germ at $a = 0$ is C^d -close to $(H_a)_a$. When m is large, the germ at $a = 0$ of $a \mapsto \mathcal{T}_a \circ \mathcal{P}_a^m(S_a'^2)$ is C^{d+1} -close to

$$\mathcal{T}_a(H_a) + D_{H_a} \mathcal{T}_a \left(\sigma_a^m \cdot x_a, \lambda_a^m \cdot \frac{\partial_a^{d+1} y_a|_{a=0}}{(d+1)!} a^{d+1} \right)$$

and so C^{d+1} -close to

$$(z_a, 0) + \partial_y \mathcal{T}_0(H_0) \cdot \lambda_a^m \cdot \frac{\partial_a^{d+1} y_a|_{a=0}}{(d+1)!} a^{d+1}.$$

Consequently, for any $n \geq 0$, the germ at $a = 0$ of $a \mapsto S_a^n \circ \mathcal{T}_a \circ \mathcal{P}_a^m(S_a'^2)$ is C^{d+1} -close to

$$((\sigma_a^{uu})^n \cdot z_a, 0) + \text{diag}((\sigma_a^{uu})^n, (\sigma_a^u)^n) \cdot \partial_y \mathcal{T}_0(H_0) \cdot \lambda_a^m \cdot \frac{\partial_a^{d+1} y_a|_{a=0}}{(d+1)!} a^{d+1}.$$

If $(\sigma_0^u)^n \lambda_0^m = O(1)$, then both $(\sigma_a^{uu})^n$ and $(\sigma_0^{uu})^n \lambda_0^m$ are small, and so we obtain the announced bound. \square

Since the ratio $\log |\sigma_0^u| / \log |\lambda_0|$ is irrational, and since $\partial_a^{d+1} \gamma_a(0)|_{a=0} \neq 0$ and $\partial_a^{d+1} y_a|_{a=0} \neq 0$, one can choose some large positive integers n, m such that

$$n \log |\sigma_0^u| + m \log |\lambda_0| - \log |\Delta| + \log |\partial_a^{d+1} y_a|_{a=0}$$

is arbitrarily close to $\log |\partial_a^{d+1} \gamma_a(0)|_{a=0}$. Since λ is negative, one can choose m to be odd or even so that $\Delta \cdot (\sigma_0^u)^n (\lambda_0)^m \partial_a^{d+1} y_a|_{a=0}$ and $\partial_a^{d+1} \gamma_a(0)|_{a=0}$ have the same sign.

By our assumptions, the C^d -jets of $a \mapsto \gamma_a(0)$ and $a \mapsto y_a$ at $a = 0$ vanish. With our choices, this guaranties that the C^{d+1} -jet at $a = 0$ of $a \mapsto \Delta \cdot (\sigma_0^u)^n (\lambda_0)^m y_a - \gamma_a(0)$ is arbitrarily small. By Lemma 4.2, after a C^r -perturbation of $(f_a)_a$ localized at $(S_a^2)_a$, the germ at $a = 0$ of the following function is C^{d+1} -small:

$$a \mapsto \eta_a := \gamma_a \circ p_x \circ S_a^n \circ \mathcal{T}_a \circ \mathcal{P}_a^m(S_a'^2) - p_y \circ S_a^n \circ \mathcal{T}_a \circ \mathcal{P}_a^m(S_a'^2).$$

A C^r -small perturbation localized at S_a^1 (which is locally conjugated to a translation) translates the functions $(\gamma_a)_a$ by $-\eta_a$ for each parameter a close to 0. Then we have at $a = 0$:

$$d(\Gamma_a, S_a^n \circ \mathcal{T}_a \circ \mathcal{P}_a^m(S_a'^2)) = o(a^{d+1}).$$

As a consequence, the continuation of P_0^1 and S_0^2 form a C^{d+1} -paraheterocycle at $a = 0$ for the chosen perturbation. Since the charts are a priori only C^r , the resulting perturbation is only C^r . In a last step, we thus smooth the family near the sources, keeping the paraheterocycle we have obtained (the latter being a finite codimensional condition on the family). Proposition 4.1 is now proved. \square

4.3 Families parametrized by k -parameters

When the family (f_a) is parametrized by $a = (a_1, \dots, a_k)$ in \mathbb{R}^k , $k > 1$, the proof follows the same scheme, by canceling one by one the partial derivatives $\partial_{a_1}^{i_1} \partial_{a_2}^{i_2} \dots \partial_{a_k}^{i_k}$ of the unfolding of the heterocycle. For this end, we proceed by induction on $\{\underline{i} = (i_1, \dots, i_k) \in \mathbb{N}^k : \sum_j i_j \leq d\}$ following an order \prec such that:

$$\sum_j i_j < \sum_j i'_j \Rightarrow \underline{i} \prec \underline{i}'.$$

5 Nearly affine (para)-blender renormalization

In this section, we prove Propositions 2.2 and 2.4.

We consider a C^∞ map $f \in \text{Diff}_{loc}^\infty(U, M)$ with a projectively hyperbolic source S and a saddle point Q forming a strong heterocycle, and build by perturbation a nearly affine blender homoclinically related to Q . It is defined by two inverse branches from a neighborhood of Q to “vertical rectangles” stretching across the local unstable manifold of the saddle.

In §5.1 and §5.2 we choose nice coordinate systems for the inverse dynamics nearby the source, the saddle and the heteroclinic orbits. It requires preliminary perturbation in order to satisfy some non-resonance and transversality conditions. We also explain how to unfold the strong heterocycle. The heterocycle induces well-defined inverse branches of the dynamics (§5.3) that are transitions from one linearizing chart to the other. §5.4 provides C^r -estimates on rescalings g^-, g^+ of the inverse branches. In §5.5 and §5.6, we tune the length of the branches and the size of the unfolding so that the inverse branches defines a nearly affine blender with a neat dilation Δ ; it is homoclinically related to the saddle point P and that its activation domain contains S . In other words, Proposition 2.2 will be proved.

In §5.8, we add a parameter, consider a family $(f_a)_{a \in \mathbb{R}}$ and apply the previous discussion to f_0 . The inverse branches admit continuations $(g_a^-)_{a \in \mathbb{R}}$ and $(g_a^+)_{a \in \mathbb{R}}$. After having chosen an adapted reparametrization, we extend the C^r -bounds to the parametrized families and check that they define a nearly affine C^r -parablender, concluding the proof of Proposition 2.4.

Notations. The proofs will depend on a small number $\varepsilon > 0$ and on integers n^+, n^-, m^+, m^- . The notation $A = O(\varepsilon)$ (or more generally $A = O(g(\varepsilon, n^+, n^-, m^+, m^-))$) will mean that the quantity A has a norm bounded by $C\varepsilon$ (or by $C|g(\varepsilon, n^+, n^-, m^+, m^-)|$), where the number $C > 0$ depends on the initial map f but not on the choices made during the construction.

Similarly, one will say that a function h (that may depend on coordinates x, y , and/or parameters a or α) is C^r -dominated by ε if $\partial^k h = O(\varepsilon)$ for all its k^{th} derivatives with respect to x, y, a, α with $0 \leq k \leq r$. Note that if in the C^r -topology, $h_i = h'_i + O(\varepsilon)$, $i \in \{1, 2\}$, then $h_1 \circ h_2 = h'_1 \circ h'_2 + O(\varepsilon)$.

5.1 Coordinates for generic perturbations of strong heterocycles

We first fix a system of coordinate as depicted in Fig. 11. As in Section 3.1, we shall assume that the points Q and S are fixed and the eigenvalues $1 < \sigma_u^{-1} < \sigma_{uu}^{-1}$ and $0 < \lambda^{-1} < 1 < \sigma^{-1}$ of $D_Q f$ and $D_S f$ respectively are positive and non-resonant. Furthermore we can assume that:

$$(5.1) \quad \frac{\log \sigma_u}{\log \lambda} \notin \mathbb{Q}.$$

The hypothesis of the proposition consists of two finite codimensional conditions:

$$(5.2) \quad S \in W^u(Q; f) \quad \text{and} \quad Q \in W^{uu}(S; f).$$

So after a small smooth perturbation, we can assume moreover:

$$(5.3) \quad T_Q W^{uu}(S; f) \oplus T_Q W^s(Q; f) = T_Q M \quad \text{and} \quad E^{cu}(S) \oplus T_S W^u(Q; f) = T_S M.$$

As in Section 3.1, the non-resonance of the eigenvalues and the smoothness of the dynamics imply, by the Sternberg Theorem [Ste58], the existence of:

- Neighborhoods $V'_S \subset V_S := f(V'_S)$ of S and coordinates for which $f|V'_S$ has the form:

$$f : (x, y) \in V'_S \mapsto (\sigma_{uu}^{-1} \cdot x, \sigma_u^{-1} \cdot y) \in V_S.$$

- Neighborhoods V'_Q and $V_Q = f(V'_Q)$ of Q and coordinates in which $f|V'_Q$ has the form:

$$f : (x, y) \in V'_Q \mapsto (\sigma^{-1} \cdot x, \lambda^{-1} \cdot y) \in V_Q.$$

This defines the inverse branches $\mathcal{Q} := (f|V'_Q)^{-1}$ and $\mathcal{S} := (f|V'_S)^{-1}$:

$$\mathcal{S} : (x, y) \in V_S \mapsto (\sigma_{uu} \cdot x, \sigma_u \cdot y) \in V'_S \quad \text{and} \quad \mathcal{Q} : (x, y) \in V_Q \mapsto (\sigma \cdot x, \lambda \cdot y) \in V'_Q.$$

Up to restrict V_Q and V'_Q and rescale their coordinate, we can assume:

$$V_Q \equiv [-2, 2] \times [-2\lambda^{-1}, 2\lambda^{-1}] \quad \text{and} \quad V'_Q \equiv [-2\sigma, 2\sigma] \times [-2, 2].$$

Let $W_{loc}^u(Q) := V_Q \cap \{y = 0\}$, $W_{loc}^s(Q) := V'_Q \cap \{x = 0\}$ and $W_{loc}^{uu}(S) := \{y = 0\} \cap V_S$.

By Eq. (5.2) there is a neighborhood $V_S'' \Subset V'_S$ of $0 \equiv S$ and an inverse branch $\mathcal{T}^s : V_S'' \hookrightarrow V_Q$ of an iterate of f sending 0 into $[-2, 2] \times \{0\}$. Similarly, there exists a neighborhood $V_Q'' \Subset V'_Q \cap V_Q$ of $0 \equiv Q$ and an inverse branch $\mathcal{T}^q : V_Q'' \hookrightarrow V_S$ of an iterate of f sending 0 into $V_S \cap \{y = 0\}$. The inverse branches \mathcal{T}^s and \mathcal{T}^q are called the *transitions maps*.

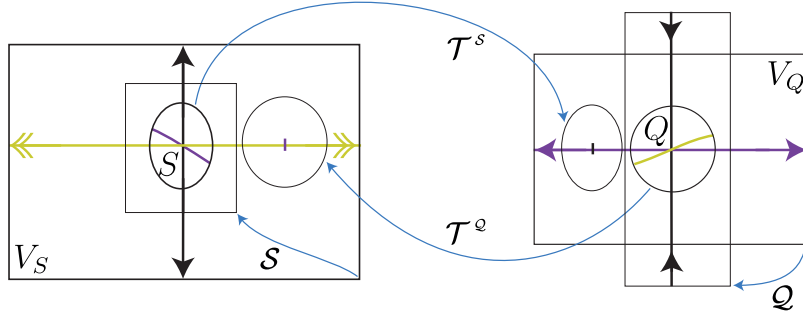

Figure 11: Inverse branches given by the strong heterocycle.

Assuming the neighborhoods V_S and V_Q small enough, it is possible (up to compose by an iterate of f) to choose $\mathcal{T}^s, \mathcal{T}^q$ such that

$$\mathcal{T}^s(0) \in V'_Q \setminus V_Q \quad \text{and} \quad \mathcal{T}^q(0) \in V_S \setminus V'_S.$$

Let the coordinates of \mathcal{T}^s and \mathcal{T}^q be

$$\mathcal{T}^s := (\mathcal{X}^s, \mathcal{Y}^s) \quad \text{and} \quad \mathcal{T}^q := (\mathcal{X}^q, \mathcal{Y}^q).$$

By Eq. (5.3), $\partial_y \mathcal{Y}^q(0) \neq 0$. Thus by rescaling one of the linearizing chart, we can assume:

$$(5.4) \quad \partial_y \mathcal{Y}^q(0) = 1.$$

5.2 Unfolding of the strong heterocycle

We will perturb $\mathcal{T}^s, \mathcal{T}^q$ so that the following points are close to but *not necessarily* in $\{y = 0\}$:

$$S' = (s'_x, s'_y) := \mathcal{T}^s(0) \quad \text{and} \quad Q' = (q'_x, q'_y) := \mathcal{T}^q(0).$$

This is enabled by the next claim without changing any derivative of the inverse branches.

Claim 5.1. *For every small numbers s'_y and q'_y , there exists a C^∞ perturbation of the dynamics such that the inverse branches \mathcal{S} and \mathcal{Q} remain unchanged, while the continuations of the inverse branches \mathcal{T}^s and \mathcal{T}^q have the same derivatives but satisfy:*

$$\mathcal{Y}^s(0) = s'_y \quad \text{and} \quad \mathcal{Y}^q(0) = q'_y.$$

Proof. First recall that $\mathcal{T}^s(0) \in V_Q \setminus V'_Q$. One perturbs f by composing with a translation supported on a small neighborhood of $\mathcal{T}^s(0)$. This enables to move the vertical position of $\mathcal{T}^s(0)$, without affecting the other branches. The modification of $\mathcal{T}^q(0)$ is done similarly. \square

In the following we will prescribe some values of s'_y, q'_y and consider the perturbed dynamics. The inverse branches of the new system will be still denoted by $\mathcal{Q}, \mathcal{S}, \mathcal{T}^s = (\mathcal{X}^s, \mathcal{Y}^s)$ and $\mathcal{T}^q = (\mathcal{X}^q, \mathcal{Y}^q)$. The next lemma enables to assume that $\partial_y \mathcal{Y}^s(0)$ is positive.

Lemma 5.2. *Up to perturbation f and to change \mathcal{T}^s , we can assume moreover that*

$$\partial_y \mathcal{Y}^s(0) > 0.$$

Proof. If $\partial_y \mathcal{Y}^s(0) < 0$, we are going to perturb f and replace \mathcal{T}^s by the inverse branch $\widetilde{\mathcal{T}}^s := \mathcal{T}^s \circ \mathcal{S}^n \circ \mathcal{T}^q \circ \mathcal{Q}^m \circ \mathcal{T}^s$ for some large n and m . First note that for any large n and any m , the map $\widetilde{\mathcal{T}}^s$ is well defined on a small neighborhood of $0 \equiv S$. Also $\partial_y \mathcal{T}^s(0)$ is a vector with negative vertical component. By hyperbolicity, it is sent by $D\mathcal{Q}^m$ to a vertical vector. Its vertical component is still negative since $\lambda > 0$. It is pointed at a point $\mathcal{Q}^m \circ \mathcal{T}^s(0)$ close to $0 \equiv S$. Thus for m sufficiently large, by Eq. (5.4), its image by $D\mathcal{T}^s$ is a vector with negative vertical component. By projective hyperbolicity of the source S , its image by $D\mathcal{S}$ is a vector vertical, pointed at a point nearby S when n is large, and with negative vertical component. Consequently it is sent by \mathcal{T}^s to a vector with positive vertical component at a point nearby $\mathcal{T}^s(0)$. In other words, the second coordinate of $\partial_y \widetilde{\mathcal{T}}^s(0)$ is positive.

It remains to perform a perturbation of f so that the second coordinate of $\widetilde{\mathcal{T}}^s(0)$ is zero. Let $(\mathcal{T}_t^s)_t$ be the family of perturbations of \mathcal{T}^s given by Claim 5.1 and enabling to move the y -coordinate of $\mathcal{T}^s(0)$. Note that when $n \gg m$,

$$\partial_t (\mathcal{T}_t^s \circ \mathcal{S}^n \circ \mathcal{T}^q \circ \mathcal{Q}^m \circ \mathcal{T}_t^s)(0) \approx \partial_t \mathcal{T}_t^s(0) + D(\mathcal{T}^s \circ \mathcal{S}^n \circ \mathcal{T}^q \circ \mathcal{Q}^m)(\partial_t \mathcal{T}_t^s(0)) \approx \partial_t \mathcal{T}_t^s(0).$$

Hence there is a small parameter t such that $\widetilde{\mathcal{T}}_t^s := (\mathcal{T}_t^s \circ \mathcal{S}^n \circ \mathcal{T}^q \circ \mathcal{Q}^m \circ \mathcal{T}_t^s)$ satisfies moreover that the y -coordinate of $\widetilde{\mathcal{T}}_t^s(0)$ is 0. \square

5.3 Choice and renormalization of inverse branches

Let us fix $\Delta > 1$ sufficiently close to 1 so that a nearly affine blender of contraction Δ^{-1} is a blender by Proposition 1.8. The construction also depends on a small number $\varepsilon > 0$ (it will measure the distance of the rescaled blender to an affine one) and on large integers n^-, m^-, n^+, m^+ that will be chosen later.

The nearly affine blender will be displayed in the neighborhood V_Q of Q , using two inverse branches g^+ and g^- of different iterates of f . We take them of the form:

$$g^\pm := \mathcal{T}^s \circ \mathcal{S}^{n^\pm} \circ \mathcal{T}^\varrho \circ \mathcal{Q}^{m^\pm}.$$

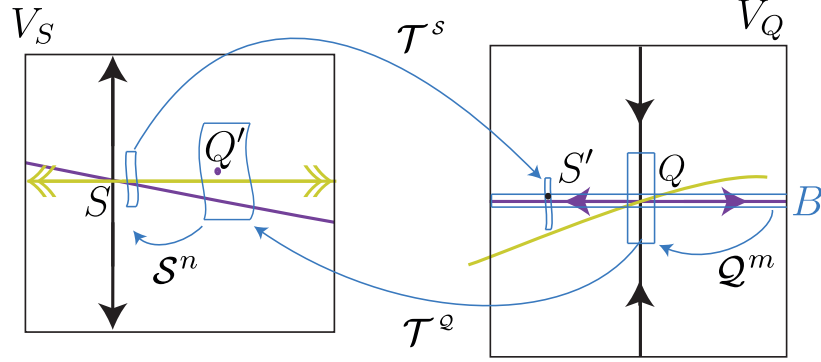

Figure 12: Construction of a nearly affine blender.

The inverse branches defining the blender will be rescaled by the map:

$$\mathcal{H} : (x, y) \in \mathbb{R}^2 \rightarrow (x, \varepsilon \cdot \lambda^{-m^+} \cdot y) \in V_Q.$$

Their renormalization are given for $\pm \in \{-, +\}$ by:

$$(5.5) \quad \mathcal{R}g^\pm := \mathcal{H}^{-1} \circ g^\pm \circ \mathcal{H} = \mathcal{H}^{-1} \circ \mathcal{T}^s \circ \mathcal{S}^{n^\pm} \circ \mathcal{T}^\varrho \circ \mathcal{Q}^{m^\pm} \circ \mathcal{H}$$

Lemma 5.3. *For every n^-, m^-, n^+, m^+ large, with $m^+ > m^-$, the renormalizations $\mathcal{R}g^-, \mathcal{R}g^+$ are well defined on $B := [-2, 2]^2$.*

Proof. Since $m^- < m^+$, both maps $\mathcal{Q}^{m^+} \circ \mathcal{H}, \mathcal{Q}^{m^-} \circ \mathcal{H}$ are well defined on B and equal to:

$$\mathcal{Q}^{m^+} \circ \mathcal{H}(x, y) = (\sigma^{m^+} \cdot x, \varepsilon \cdot y) \quad \text{and} \quad \mathcal{Q}^{m^-} \circ \mathcal{H}(x, y) = (\sigma^{m^-} \cdot x, \varepsilon \cdot \lambda^{m^- - m^+} \cdot y).$$

As ε is small, their ranges are contained in a small neighborhood of 0 and so in the domain of \mathcal{T}^ϱ . Thus both maps $\mathcal{T}^\varrho \circ \mathcal{Q}^{m^\pm} \circ \mathcal{H}$ are well defined on B and their ranges lie in a small neighborhood of $\mathcal{T}^\varrho(0) \in V_S$. Then as \mathcal{S} contracts V_S into itself with a fixed point at 0 and since n^\pm are large, $\mathcal{S}^{n^\pm} \circ \mathcal{T}^\varrho \circ \mathcal{Q}^{m^\pm} \circ \mathcal{H}$ is well defined on B and its image is included in the small neighborhood V_S'' of 0. Thus $\mathcal{T}^s \circ \mathcal{S}^{n^\pm} \circ \mathcal{T}^\varrho \circ \mathcal{Q}^{m^\pm} \circ \mathcal{H}$ is well defined on B . \square

5.4 Bounds on the renormalized maps

Given $\varepsilon > 0$ small, we require the following properties on the large integers n^\pm, m^\pm :

$$(5.6) \quad n^+ > n^- \geq \varepsilon^{-1} \quad \text{and} \quad m^+ > m^- \geq \varepsilon^{-1},$$

$$(5.7) \quad \{ \sigma_u^{n^-} \lambda^{m^-} \cdot \partial_y \mathcal{Y}^s(0), \sigma_u^{n^+} \lambda^{m^+} \cdot \partial_y \mathcal{Y}^s(0) \} \subset [\Delta - \varepsilon, \Delta + \varepsilon],$$

$$(5.8) \quad \varepsilon^{-1} \leq \sigma_u^{n^+ - n^-} \quad \text{and} \quad \lambda^{m^+ - m^-} \leq \varepsilon^2 \cdot \min(n^-, m^-).$$

Let us recall that the inverse eigenvalues satisfy $\kappa := \max(\sigma_u, \sigma_{uu}, \frac{\sigma_{uu}}{\sigma_u}, \lambda^{-1}, \sigma) < 1$.

Fact 5.4. For every $\varepsilon > 0$ small and $n > \varepsilon^{-1}$, it holds $\kappa^n < n^{-(r+4)}$.

In particular, one has $\sigma^{n^-} < \varepsilon$ and $\sigma_u^{n^-} < \varepsilon$.

We decompose the renormalized maps as

$$\mathcal{R}g^\pm = \Psi^\pm \circ \Phi^\pm = [\mathcal{H}^{-1} \circ \mathcal{T}^s \circ \mathcal{S}^{n^\pm} \circ \mathcal{H}^\pm] \circ [(\mathcal{H}^\pm)^{-1} \circ \mathcal{T}^\varrho \circ \mathcal{Q}^{m^\pm} \circ \mathcal{H}],$$

$$\text{where } \mathcal{H}^\pm := (x, y) \mapsto (x, \varepsilon \cdot \lambda^{m^\pm - m^+} \cdot y) - Q'.$$

Lemma 5.5. The maps $(x, y) \mapsto \Phi^\pm(x, y) - (0, y)$ are C^r -dominated by ε .

Proof. We have $\Phi^\pm(x, y) = (\mathcal{H}^\pm)^{-1} \circ \mathcal{T}^\varrho \circ \mathcal{Q}^{m^\pm} \circ \mathcal{H}(x, y)$. Since $Q' = \mathcal{T}^\varrho(0) = \mathcal{T}^\varrho \circ \mathcal{Q}^{m^\pm} \circ \mathcal{H}(0)$ we get $\Phi^\pm(0) = 0$. Recalling that $\mathcal{T}^\varrho = (\mathcal{X}^\varrho, \mathcal{Y}^\varrho)$ and that $Q' = (q'_x, q'_y)$, we obtain:

$$\begin{aligned} \Phi^\pm(x, y) &= (\mathcal{X}^\varrho, \varepsilon^{-1} \cdot \lambda^{m^+ - m^\pm} \cdot \mathcal{Y}^\varrho)(\sigma^{m^\pm} \cdot x, \varepsilon \cdot \lambda^{m^\pm - m^+} \cdot y) + (q'_x, \varepsilon^{-1} \cdot \lambda^{m^+ - m^\pm} \cdot q'_y). \\ \partial_x \Phi^\pm(x, y) &= \sigma^{m^\pm} \cdot (\partial_x \mathcal{X}^\varrho, \varepsilon^{-1} \cdot \lambda^{m^+ - m^\pm} \cdot \partial_x \mathcal{Y}^\varrho)(\sigma^{m^\pm} \cdot x, \varepsilon \cdot \lambda^{m^\pm - m^+} \cdot y). \\ \partial_y \Phi^\pm(x, y) &= (\varepsilon \cdot \lambda^{m^\pm - m^+} \cdot \partial_y \mathcal{X}^\varrho, \partial_y \mathcal{Y}^\varrho)(\sigma^{m^\pm} \cdot x, \varepsilon \cdot \lambda^{m^\pm - m^+} \cdot y). \end{aligned}$$

From this, (5.6) and Fact 5.4, the first coordinate of $D\Phi^\pm$ is C^{r-1} -dominated by ε . Using also (5.8), we have $\sigma^{m^\pm} \cdot \varepsilon^{-1} \cdot \lambda^{m^+ - m^\pm} < \sigma^{m^\pm} \cdot \varepsilon \cdot m^- < \varepsilon$ and the second coordinate of $\partial_x \Phi^\pm$ is C^{r-1} -dominated by ε . As $\partial_y \mathcal{Y}^\varrho(0) = 1$ by (5.4), the second coordinate of $\partial_y \Phi^\pm$ coincides with the constant function 1, up to an error term that is C^{r-1} -dominated by ε . \square

Lemma 5.6. The maps Ψ^\pm coincide with

$$(x, y) \mapsto (0, \Delta \cdot y) + (s'_x, \varepsilon^{-1} \lambda^{m^+} \cdot s'_y - \varepsilon^{-1} \cdot \lambda^{m^+} \sigma_u^{n^\pm} \cdot \partial_y \mathcal{Y}^s(0) \cdot q'_y),$$

up to an error term that is C^r -dominated by ε .

Proof. We have $\Psi^\pm = \mathcal{H}^{-1} \circ \mathcal{T}^s \circ \mathcal{S}^{n^\pm} \circ \mathcal{H}^\pm$. With $\mathcal{T}^s = (\mathcal{X}^s, \mathcal{Y}^s)$, it holds:

$$\Psi^\pm(x, y) = (\mathcal{X}^s, \varepsilon^{-1} \lambda^{m^+} \mathcal{Y}^s)(\sigma_{uu}^{n^\pm} \cdot (x - q'_x), \sigma_u^{n^\pm} \cdot (\varepsilon \cdot \lambda^{m^\pm - m^+} \cdot y - q'_y)).$$

Thus $\partial_x \Psi^\pm$ is C^{r-1} -dominated by $\sigma_{uu}^{n^-} \cdot \lambda^{m^+} \cdot \varepsilon^{-1}$, which by (5.6), (5.7), (5.8) is dominated by

$$\left(\frac{\sigma_{uu}}{\sigma_u}\right)^{n^-} \cdot \lambda^{m^+ - m^-} \cdot \varepsilon^{-1} < \left(\frac{\sigma_{uu}}{\sigma_u}\right)^{n^-} \cdot n^- \cdot \varepsilon < \varepsilon.$$

The first coordinate of $\partial_y \Psi^\pm$ is C^{r-1} -dominated by $\varepsilon \cdot \sigma_u^{n^\pm} \cdot \lambda^{m^\pm - m^+} < \varepsilon$. Similarly, using (5.7), the second coordinate of $\partial_y \Psi^\pm$ coincides with $\sigma_u^{n^\pm} \cdot \lambda^{m^\pm} \cdot \partial_y \mathcal{Y}^s(0)$, hence with Δ , up to an error term that is C^{r-1} -dominated by ε . We have thus shown that the derivative of $(x, y) \mapsto \Psi^\pm(x, y) - (0, \Delta \cdot y)$ is C^{r-1} -dominated by ε . Moreover:

$$\Psi^\pm(0) = (\mathcal{X}^s, \varepsilon^{-1} \cdot \lambda^{m^+} \cdot \mathcal{Y}^s)(-\sigma_{uu}^{n^\pm} \cdot q'_x, -\sigma_u^{n^\pm} \cdot q'_y).$$

The first coordinate is ε -close to $\mathcal{X}^s(0) = s'_x$ and the second coordinate is equal to:

$$\varepsilon^{-1} \lambda^{m^+} \mathcal{Y}^s(-\sigma_{uu}^{n^\pm} \cdot q'_x, -\sigma_u^{n^\pm} \cdot q'_y) = \varepsilon^{-1} \lambda^{m^+} \left(\mathcal{Y}^s(0) - \partial_x \mathcal{Y}^s(0) \cdot \sigma_{uu}^{n^\pm} \cdot q'_x - \partial_y \mathcal{Y}^s(0) \cdot \sigma_u^{n^\pm} \cdot q'_y + O(\sigma_u^{2n^\pm}) \right).$$

As before $\varepsilon^{-1} \cdot \lambda^{m^+} \cdot \sigma_{uu}^{n^-} = O(\varepsilon)$. By (5.7) and (5.8), $\varepsilon^{-1} \cdot \lambda^{m^+} \cdot \sigma_u^{2n^-}$ is dominated by $\varepsilon^{-1} \cdot \lambda^{m^+ - m^-} \cdot \sigma_u^{n^-} = O(\varepsilon)$. As $\mathcal{Y}^s(0) = s'_y$, we obtain (1). \square

5.5 Tuning iterates

Lemma 5.7. *Given $\varepsilon > 0$ small, there exist n^-, m^-, n^+, m^+ which satisfy (5.6), (5.7), (5.8).*

Proof. By (5.1), there exist $m, n \geq 1$ arbitrarily large such that:

$$\lambda^m \sigma_u^n \in [1 - \frac{\varepsilon}{10}, 1 + \frac{\varepsilon}{10}].$$

As Δ and $\partial_y \mathcal{Y}^s(0)$ have the same sign (by Lemma 5.2), there are $n^-, m^- > \varepsilon^{-1}$ such that:

$$n^- \geq \varepsilon^{-2} \cdot \lambda^m \quad \text{and} \quad \partial_y \mathcal{Y}^s(0) \cdot \lambda^{m^-} \sigma_u^{n^-} \in \Delta + [-\frac{\varepsilon}{10}, \frac{\varepsilon}{10}].$$

Then let $m^+ := m + m^-$ and $n^+ := n + n^-$. This gives $\lambda^{m^+} \cdot \partial_y \mathcal{Y}^s(0) \cdot \sigma_u^{n^+} = \Delta + [-\varepsilon, \varepsilon]$. \square

A consequence of the Lemmas 5.5, 5.6 and 5.7 is:

Corollary 5.8. *For every $\varepsilon > 0$ there exist n^-, m^-, n^+, m^+ such that the renormalized maps $\mathcal{R}g^\pm$ coincide, up to a term that is C^r -dominated by ε , with:*

$$(x, y) \mapsto (0, \Delta \cdot y) + (s'_x, \varepsilon^{-1} \cdot \lambda^{m^+} \cdot s'_y - \varepsilon^{-1} \cdot \lambda^{m^+} \cdot \sigma_u^{n^+} \cdot \partial_y \mathcal{Y}^s(0) \cdot q'_y).$$

5.6 Proof of Proposition 2.2: from strong heterocycles to blenders

Let n^-, m^-, n^+, m^+ be given by Corollary 5.8. It remains to choose the values of s'_y and q'_y , such that the renormalized maps $\mathcal{R}g^\pm$ are C^r -close to:

$$(x, y) \mapsto (s'_x, \Delta \cdot y) \pm (\Delta - 1).$$

In view of Corollary 5.8, it is enough to ask:

$$\varepsilon^{-1} \cdot \lambda^{m^+} \cdot s'_y - \varepsilon^{-1} \cdot \lambda^{m^+} \cdot \sigma_u^{n^+} \cdot \partial_y \mathcal{Y}^s(0) \cdot q'_y = \pm(\Delta - 1) + O(\varepsilon).$$

This is implied by choosing s'_y and q'_y as follows:

$$(5.9) \quad \varepsilon^{-1} \cdot \lambda^{m^+} \cdot s'_y = \Delta - 1 \quad \text{and} \quad \varepsilon^{-1} \cdot \lambda^{m^+} \sigma_u^{n^+} \cdot \partial_y \mathcal{Y}^s(0) \cdot q'_y = 2(\Delta - 1).$$

Indeed, one has $\sigma_u^{n^+ - n^-} \geq \varepsilon^{-1}$ by (5.8), and with (5.6), (5.7), Fact 5.4, the choices (5.9) give $s'_y = O(\varepsilon^2)$, $q'_y = O(\varepsilon)$ and $\varepsilon^{-1} \cdot \lambda^{m^+} \sigma_u^{n^+} \cdot \partial_y \mathcal{Y}^s(0) \cdot q'_y = O(\varepsilon)$.

By Proposition 1.8, $\{\mathcal{R}g^+, \mathcal{R}g^-\}$ defines a nearly affine blender with activation domain containing $[-2, 2] \times [-1/2, 1/2]$. Thus, $\{g^+, g^-\}$ defines a blender with activation domain containing $\mathcal{H}([-2, 2] \times [-1/2, 1/2]) = [-2, 2] \times [-\varepsilon \cdot \lambda^{-m^+}/2, \varepsilon \cdot \lambda^{-m^+}/2]$. Choosing $|\Delta - 1| < 1/4$, one gets $|s'_y| < \varepsilon \cdot \lambda^{-m^+}/2$ and S' belongs to this activation domain. Also the point $Q \equiv 0$ belongs to this activation domain. Note that the unstable manifold of Q stretches across $\{s'_x\} \times [-\varepsilon \cdot \lambda^{-m^+}/2, \varepsilon \cdot \lambda^{-m^+}/2]$ and so the stable manifolds of the blender. Hence Q is homoclinically related to the blender. Proposition 2.2 is proved in the C^∞ case. \square

5.7 Proof of the Proposition 2.2 in the analytic case

The whole previous proof is still valid in the analytic setting but Claim 5.1. Note that the proof of Proposition 2.2 does not use that the r first derivatives of \mathcal{T}^s and \mathcal{T}^∞ remain unchanged but only that they are bounded. Thus to prove the analytic case of Proposition 2.2, it suffices to show:

Claim 5.9. *For every small numbers s'_y and q'_y , there exists a C^ω perturbation of the dynamics such that the inverse branches \mathcal{S} and \mathcal{Q} remain unchanged, while the continuations of the inverse branches \mathcal{T}^s and \mathcal{T}^q derivatives at 0 and satisfy:*

$$\mathcal{Y}^s(0) = s'_y \quad \text{and} \quad \mathcal{Y}^q(0) = q'_y.$$

Moreover their C^r -norm vary continuously with the parameters s'_y, q'_y .

Proof. The perturbation technique follows the same lines as the proof of Lemma 3.7. First we embed analytically M into \mathbb{R}^N , and we define an analytic retraction π from a neighborhood of $M \subset \mathbb{R}^N$ to M . Then we chose a C^∞ -family $(f_p)_{p \in [-\varepsilon, \varepsilon]^8}$ such that $f_0 = f$, such that f_p coincide with f outside of a small neighborhood of $\{S, Q\}$, and such that the following map is a local diffeomorphism:

$$\Phi: p \in [-\varepsilon, \varepsilon]^8 \mapsto (S_p, P_p, \sigma(p), \lambda(p), \sigma_u(p), \sigma_{uu}(p)) \in M^2 \times \mathbb{R}^4,$$

where S_p and P_p are the continuations of S and P , while $(\sigma^{-1}(p), \lambda^{-1}(p))$ and $(\sigma_u^{-1}(p), \sigma_{uu}^{-1}(p))$ are their eigenvalues. Then using Stone-Weierstrass theorem and the retraction π , we define an analytic family $(\tilde{f}_p)_{p \in [-\varepsilon, \varepsilon]^8}$ such that $\tilde{f}_0 = f$ and such that the continuation of Φ remains a diffeomorphism. We can thus extract from this family a 4-parameter family $(\tilde{f}_p)_{p \in [-\varepsilon, \varepsilon]^4}$ along which the eigenvalues are constant, but such that the continuations \tilde{S}_p and \tilde{P}_p of S and P still satisfy that the following map is a local diffeomorphism:

$$p \in [-\varepsilon, \varepsilon]^4 \mapsto (\tilde{S}_p, \tilde{P}_p) \in M^2.$$

In §5.1, we assumed the eigenvalues of these points to be non-resonant. Thus we can apply [Tak71] which provides C^r -families of coordinates at S and P in which $f_p|V'_S$ and $f_p|V'_Q$ coincide with diagonalized linear part of $D_S f_p$ and $D_Q f_p$, which do not depend on p . Consequently the inverse branches \mathcal{S} and \mathcal{Q} (seen in the coordinates) remain unchanged when p varies in $[-\varepsilon, \varepsilon]^4$. Also the continuations of the inverse branches \mathcal{T}^s and \mathcal{T}^q vary C^r -continuously with p . On the other hand, the variation of the relative positions of the continuation of S and Q w.r.t. the local unstable manifold of Q and the strong unstable manifold of S is non-degenerated. \square

5.8 Proof of Proposition 2.4: from strong paraheterocycles to parablenders

We now consider a C^∞ family of $(f_a)_{a \in \mathbb{R}}$ and continue to work in the setting of §5.1–5.6 for the map $f = f_0$.

The continuations of the periodic points are $(S_a)_{a \in \mathbb{R}}, (Q_a)_{a \in \mathbb{R}}$, with eigenvalues $\sigma_u^{-1}(a), \sigma_{uu}^{-1}(a)$ and $\lambda^{-1}(a), \sigma^{-1}(a)$. By [Tak71], their linearizing coordinates can be extended for every $a \in I$ of I sufficiently small, as C^{r+1} -family of C^{r+1} -diffeomorphisms. This enables us to consider the continuations $\mathcal{S}_a, \mathcal{Q}_a, \mathcal{T}_a^q$ and \mathcal{T}_a^s of the inverse branches $\mathcal{S}, \mathcal{Q}, \mathcal{T}^q$ and \mathcal{T}^s . They are still of the form:

$$\mathcal{S}_a : (x, y) \in V_S \mapsto (\sigma_{uu}(a) \cdot x, \sigma_u(a) \cdot y), \quad \mathcal{Q}_a : (x, y) \in V_Q \mapsto (\sigma(a) \cdot x, \lambda(a) \cdot y),$$

$$\mathcal{T}_a^s = (\mathcal{X}_a^s, \mathcal{Y}_a^s) : (x, y) \in V_S'' \hookrightarrow V_Q, \quad \mathcal{T}_a^q = (\mathcal{X}_a^q, \mathcal{Y}_a^q) : (x, y) \in V_Q'' \hookrightarrow V_S,$$

and they allow to define the preimages by f_a :

$$S'_a = (s'_x(a), s'_y(a)) := \mathcal{T}_a^s(0) \quad \text{and} \quad Q'_a = (q'_x(a), q'_y(a)) := \mathcal{T}_a^q(0).$$

Observe that up to a perturbation localized at a neighborhood of \mathcal{S}_0 we can also assume:

$$(5.10) \quad \partial_a \frac{\log \sigma_u(a)}{\log \lambda(a)} \neq 0 \quad \text{at } a = 0.$$

We consider $\Delta > 1$, $\varepsilon > 0$, and the integers n^+, m^+, n^-, m^- as before. This allows to extend the definition of g^\pm as families $(g_a^\pm)_{a \in I}$. We also extend the rescaling maps:

$$\begin{aligned} \mathcal{H}_a &: (x, y) \mapsto (x, \varepsilon \cdot \lambda^{m^+}(a) \cdot y), \\ \mathcal{H}_a^\pm &: (x, y) \mapsto (x, \varepsilon \cdot \lambda^{m^\pm - m^+}(a) \cdot y) - Q'_a, \end{aligned}$$

and, similarly to Eq. (5.5), the renormalized inverse branches:

$$\mathcal{R}g_a^\pm := \mathcal{H}_a^{-1} \circ g_a^\pm \circ \mathcal{H}_a = \Psi_a^\pm \circ \Phi_a^\pm,$$

$$\text{where} \quad \Phi_\alpha^\pm := (\mathcal{H}_\alpha^\pm)^{-1} \circ \mathcal{T}_\alpha^\circ \circ \mathcal{Q}_\alpha^{m^\pm} \circ \mathcal{H}_\alpha \quad \text{and} \quad \Psi_\alpha^\pm := (\mathcal{H}_\alpha)^{-1} \circ \mathcal{T}_\alpha^s \circ \mathcal{S}_\alpha^{n^\pm} \circ \mathcal{H}_\alpha^\pm.$$

For a small, $\mathcal{R}g_a^+, \mathcal{R}g_a^-$ are well defined on $B := [-1, 1] \times [-2, 2]$ by Lemma 5.3 and form a C^r -nearly affine blender K_a by Section 5.6. We also rescale the parameter space:

$$\alpha(a) := \Delta_-(a) - \Delta_-(0) \quad \text{where} \quad \Delta_\pm(a) := \lambda^{m^\pm}(a) \cdot \partial_y \mathcal{Y}_a^s(0) \cdot \sigma_u^{n^\pm}(a).$$

Lemma 5.10. 1. The map α is a local diffeomorphism at $a = 0$.

2. The function $\alpha \mapsto a(\alpha)$ is C^r -dominated by in $1/n^-$ (and hence by ε).

3. The maps $\alpha \mapsto \Delta_\pm(\alpha) - (\Delta + \alpha)$ are C^r -dominated by ε .

Proof. First observe that $\alpha(0) = 0$. Then

$$\begin{aligned} \Delta_-^{-1} \cdot \partial_a \alpha &= \partial_a \log \Delta_- = \partial_a \log(\lambda^{m^-} \cdot \sigma_u^{n^-} \cdot \partial_y \mathcal{Y}_a^s(0)) = \partial_a \left(\frac{\log(\lambda^{m^-} \cdot \sigma_u^{n^-})}{\log \lambda} \cdot \log \lambda + \log \partial_y \mathcal{Y}_a^s(0) \right) \\ &= n^- \cdot \log \lambda \cdot \partial_a \frac{\log \sigma_u}{\log \lambda} + \frac{m^- \cdot \log \lambda + n^- \log \sigma_u}{\log \lambda} \cdot \partial_a \log \lambda + \partial_a \log(\partial_y \mathcal{Y}_a^s(0)). \end{aligned}$$

Thus by (5.7), when ε is small, $\partial_a \alpha|_{a=0}$ is invertible, of the order of n^- , giving the first item.

By induction, one gets that the higher derivatives can be written as:

$$(5.11) \quad \partial_a^k \Delta_- = \partial_a^k \alpha = \Delta_- \cdot \left(n^- \cdot \log \lambda \cdot \partial_a \frac{\log \sigma_u}{\log \lambda} + \frac{m^- \cdot \log \lambda + n^- \log \sigma_u}{\log \lambda} \cdot \partial_a \log \lambda + \partial_a \log(\partial_y \mathcal{Y}_a^s(0)) \right)^k + \Delta_- \cdot R_k(n^-, m^-),$$

where $R_k(n^-, m^-)$ is a polynomial in n^-, m^- with degree smaller or equal to $k - 1$. Hence $\partial_a^k \alpha$ is dominated by $(n^-)^k$. Note that $\partial_\alpha^k a \cdot (\partial_a \alpha)^{k+1}$ is a linear combination of terms of the form $(\partial_a \alpha)^{i_1} \cdot (\partial_a^2 \alpha)^{i_2} \cdots (\partial_a^k \alpha)^{i_k}$, where $i_1 + 2 \cdot i_2 + \cdots + k \cdot i_k \leq k$. This implies that $\partial_\alpha^k a$ is dominated by $1/n^- \leq \varepsilon$ as announced in the second item.

The definition of α gives $\Delta_-(\alpha) = \Delta_-(0) + \alpha$ and $|\Delta_-(0) - \Delta| < \varepsilon$ by (5.7). In order to get the third item, it is thus enough to prove that each derivative $\partial_\alpha^k(\Delta_+ - \Delta_-)$ is dominated by ε .

By (5.7) and (5.8), $\Delta_+ - \Delta_-$ is dominated by ε , and $n^+ - n^-$ is dominated by εn^- , whereas $m^- \cdot \log \lambda + n^- \log \sigma_u$ and $m^+ \cdot \log \lambda + n^+ \log \sigma_u$ are uniformly bounded. The partial derivative $\partial_a^k \Delta_-$ satisfies Eq. (5.11). Replacing Δ_-, n_-, m_- by Δ_+, n_+, m_+ , one obtains a relation for $\partial_a^k \Delta_+$. Taking the difference, one concludes that $\partial_a^k(\Delta_+ - \Delta_-)$ is dominated by $\varepsilon(n^-)^k$. Since $\partial_\alpha^k(\Delta_+ - \Delta_-)$ is a linear combination of terms $\partial_a^m(\Delta_+ - \Delta_-) \cdot \partial_\alpha^{i_1} a \cdots \partial_\alpha^{i_\ell} a$ with $i_1 + \cdots + i_\ell = m$, by the second equality of it is dominated by ε . \square

- Corollary 5.11.** 1. The maps $\alpha \mapsto S'_\alpha - S'_0$ and $\alpha \mapsto Q'_\alpha - Q'_0$ are C^r -dominated by ε .
2. The first derivative of $\alpha \mapsto \varepsilon^{-1} \cdot \lambda^{m^+ - m^\pm}(\alpha) \cdot q'_y(\alpha)$ is C^{r-1} -dominated by ε .
3. The first derivative of $\alpha \mapsto \varepsilon^{-1} \cdot \lambda^{m^+}(\alpha) \cdot \sigma_u^{n^\pm}(\alpha) \cdot q'_y(\alpha)$ is C^{r-1} -dominated by ε .

Proof. The first item is a direct consequence of Lemma 5.10: in particular the first derivative of $\alpha \mapsto q'_y(\alpha)$ is C^{r-1} -dominated by $1/n^-$. By our choice (5.9), $q'_y(0)$ is dominated by $\varepsilon \cdot \lambda^{m^- - m^+}$. Similarly, the first derivative of $\alpha \mapsto \lambda^{m^+ - m^-}(\alpha)$ is C^{r-1} -dominated by

$$\max\left\{\left(\frac{m^+ - m^-}{n^-}\right)^k \lambda^{m^+ - m^-} : 1 \leq k \leq r\right\} \leq \frac{m^+ - m^-}{n^-} \lambda^{m^+ - m^-} < \varepsilon^2 \lambda^{m^+ - m^-},$$

using (5.8). The second item is thus a consequence of (5.8): $\varepsilon^{-1} \lambda^{m^+ - m^\pm} / n^- \leq \varepsilon$.

The third item is obtained similarly, by writing $\lambda^{m^+}(\alpha) \cdot \sigma_u^{n^\pm}(\alpha) = \lambda^{m^+ - m^\pm}(\alpha) \cdot \lambda^{m^\pm} \sigma_u^{n^\pm}(\alpha)$ and by using (5.7). \square

Lemma 5.12. With $p_y : (x, y) \mapsto y$, the families of maps $(\Phi_\alpha^\pm - p_y)_\alpha$ are C^r -dominated by ε .

Proof. In addition to Lemma 5.5, it remains to study the partial derivatives involving α . Let us recall that $\Phi_\alpha^\pm(x, y)$ is given by

$$(\mathcal{X}_\alpha^\varnothing, \varepsilon^{-1} \cdot \lambda^{m^+ - m^\pm}(\alpha) \cdot \mathcal{Y}_\alpha^\varnothing)(\sigma^{m^\pm}(\alpha) \cdot x, \varepsilon \cdot \lambda^{m^\pm - m^+}(\alpha) \cdot y) - (q'_x(\alpha), \varepsilon^{-1} \cdot \lambda^{m^+ - m^\pm}(\alpha) \cdot q'_y(\alpha)).$$

By Corollary 5.11, one can reduce to consider the family indexed by α and formed by:

$$(5.12) \quad (x, y) \mapsto (\mathcal{X}_\alpha^\varnothing, \varepsilon^{-1} \cdot \lambda^{m^+ - m^\pm}(\alpha) \cdot \mathcal{Y}_\alpha^\varnothing)(\sigma^{m^\pm}(\alpha) \cdot x, \varepsilon \cdot \lambda^{m^\pm - m^+}(\alpha) \cdot y) + Cst.$$

By taking the first derivative w.r.t α and further derivatives w.r.t. x, y, α , factors of the form $(m^\pm)^i (\sigma)^{m^\pm}$, $(m^+ - m^-)^i \lambda^{m^+ - m^-}$ appear, together with at least one factor of the form $\partial_\alpha^i a$. Since $(m^\pm)^r (\sigma)^{m^\pm} < 1$ and $(m^+ - m^-)^r \lambda^{m^+ - m^-} < 1$ by Fact 5.4 and using 5.10, the derivative of (5.12) w.r.t. α forms a family C^{r-1} -dominated by the map $\varepsilon^{-1} \cdot \lambda^{m^+ - m^\pm}(0) \cdot \frac{1}{n^-}$ which is dominated by ε using Lemma 5.10. \square

Lemma 5.13. The families $(\Psi_\alpha^\pm)_\alpha$ coincide, up to the addition of maps C^r -dominated by ε , with the families defined by:

$$((x, y), \alpha) \mapsto (0, (\Delta + \alpha) \cdot y) + (s'_x(0), \varepsilon^{-1} \cdot \lambda^{m^+}(\alpha) \cdot s'_y(\alpha) - \varepsilon^{-1} \cdot \lambda^{m^+}(\alpha) \cdot \sigma_u^{n^\pm}(\alpha) \cdot \partial_y \mathcal{Y}_\alpha^s(0) \cdot q'_y(\alpha)).$$

Proof. In addition to Lemma 5.6, we are reduced to examine the $(\partial_\alpha \Psi_\alpha^\pm)_\alpha$. We have:

$$\Psi_\alpha^\pm(x, y) = (\mathcal{X}_\alpha^s, \varepsilon^{-1} \lambda^{m^+}(\alpha) \mathcal{Y}_\alpha^s)(\sigma_{uu}^{n^\pm}(\alpha) \cdot (x - q'_x(\alpha)), \sigma_u^{n^\pm}(\alpha) \cdot (\varepsilon \cdot \lambda^{m^\pm - m^+}(\alpha) \cdot y - q'_y(\alpha))).$$

We first discuss the families $(\partial_x \Psi_\alpha^\pm)_\alpha$, $(\partial_y \Psi_\alpha^\pm)_\alpha$ and then the families $(\partial_\alpha \Psi_\alpha^\pm(0))_\alpha$.

Step 1. The families $(\partial_x \Psi_\alpha^\pm)_\alpha$ are controlled as in the proof of Lemma 5.12, by bounding the factors $\partial_\alpha^k a$ by $1/n^-$ with Lemma 5.10. By (5.7), (5.8), m^-, m^+, n^+ are dominated by n^- . All of this implies that $\log(\lambda^{m^\pm})$, $\sigma_u^{n^\pm}$, $\sigma_{uu}^{n^\pm}$, as functions of α , are C^r -bounded. One deduces that $\partial_x \Psi_\alpha^\pm$ are C^{r-1} -dominated by $\sigma_{uu}^{n^\pm} \cdot \lambda^{m^+} \cdot \varepsilon^{-1}$. Arguing as in the proof of Lemma 5.6, $\partial_x \Psi_\alpha^\pm$ are thus C^{r-1} -dominated by

$$\left(\frac{\sigma_{uu}}{\sigma_u}\right)^{n^-} \cdot \lambda^{m^+ - m^-} \cdot \varepsilon^{-1} < \left(\frac{\sigma_{uu}}{\sigma_u}\right)^{n^-} \cdot n^- \cdot \varepsilon < \varepsilon.$$

Step 2. The families $(\partial_y \Psi_\alpha^\pm)_\alpha$ have a first coordinate which is C^{r-1} -dominated by $(n^\pm)^r \cdot \sigma_u^{n^\pm} \cdot (m^\pm - m^+)^r \cdot \lambda^{m^\pm - m^+} \cdot \varepsilon$, and by ε by Fact 5.4. The second coordinate of $\partial_y \Psi_\alpha^\pm$ equals:

$$((x, y), \alpha) \mapsto \sigma_u^{n^\pm}(\alpha) \cdot \lambda^{m^\pm}(\alpha) \cdot \partial_y \mathcal{Y}_\alpha^s \left(\sigma_{uu}^{n^\pm}(\alpha) \cdot (x - q'_x(\alpha)), \sigma_u^{n^\pm}(\alpha) \cdot (\varepsilon \cdot \lambda^{m^\pm - m^+}(\alpha) \cdot y - q'_y(\alpha)) \right).$$

It differs with $(\sigma_u^{n^\pm}(\alpha) \cdot \lambda^{m^\pm}(\alpha) \cdot \partial_y \mathcal{Y}_\alpha^s(0))_\alpha$ up to a map which is C^{r-1} -dominated by

$$\sigma_u^{n^\pm} \cdot \lambda^{m^\pm} \cdot \max \left\{ (n^\pm)^r \cdot \sigma_{uu}^{n^\pm}, (n^\pm)^r \cdot \sigma_u^{n^\pm} \cdot (m^+ - m^\pm)^r \cdot \lambda^{m^\pm - m^+} \cdot \varepsilon \right\},$$

and hence by ε from (5.7) and Fact 5.4. By definition $\sigma_u^{n^\pm}(\alpha) \cdot \lambda^{m^\pm}(\alpha) \cdot \partial_y \mathcal{Y}_\alpha^s(0) = \Delta_\pm(\alpha)$ and $\Delta_\pm(\alpha)$ coincides with $\Delta + \alpha$ up to a term that is C^r -dominated by ε , by Lemma 5.10.

Up to here, we have shown that the families $(D\Phi_\alpha^\pm)_\alpha$ coincide with the spatial derivative of the map $((x, y), \alpha) \mapsto (0, (\Delta + \alpha) \cdot y)$, up to a term C^{r-1} -dominated by ε .

Step 3. The families $(\partial_\alpha \Psi_\alpha^\pm(0))_\alpha$, are given by:

$$\Psi_\alpha^\pm(0) = (\mathcal{X}_\alpha^s, \varepsilon^{-1} \cdot \lambda^{m^+}(\alpha) \cdot \mathcal{Y}_\alpha^s)(-\sigma_{uu}^{n^\pm}(\alpha) \cdot q'_x(\alpha), -\sigma_u^{n^\pm}(\alpha) \cdot q'_y(\alpha)).$$

The first coordinate of each derivative $\partial_\alpha^k \Psi_\alpha^\pm(0)$ is dominated by derivatives $\partial_\alpha^i a$, hence the first coordinate of $\partial_\alpha \Psi_\alpha^\pm(0)$ is dominated by ε by Lemma 5.10.

By similar estimates as in Lemma 5.6, combined with Lemma 5.10, the second coordinate of $\partial_\alpha \Psi_\alpha^\pm(0)$ can be reduced (up to a term C^{r-1} -dominated by ε) to:

$$\varepsilon^{-1} \cdot \lambda^{m^+}(\alpha) \cdot \mathcal{Y}_\alpha^s(0) + \varepsilon^{-1} \cdot \lambda^{m^+}(\alpha) \cdot D\mathcal{Y}_\alpha^s(0) \cdot (0, -\sigma_u^{n^\pm}(\alpha) \cdot q'_y(\alpha)),$$

which is also equal to $\varepsilon^{-1} \cdot \lambda^{m^+}(\alpha) \cdot s'_y(\alpha) - \varepsilon^{-1} \cdot \lambda^{m^+}(\alpha) \cdot \sigma_u^{n^\pm}(\alpha) \cdot \partial_y \mathcal{Y}_\alpha^s(0) \cdot q'_y(\alpha)$. \square

As a consequence of the Lemmas 5.12, 5.13 and 5.7, we have obtained:

Corollary 5.14. *For every $\varepsilon > 0$ there exist n^+, n^-, m^+, m^- such that the families $(\mathcal{R}g_\alpha^\pm)_\alpha$ coincide, up to a term dominated by ε , with the families defined by:*

$$(x, y) \mapsto (0, (\Delta + \alpha) \cdot y) + (s'_x(0), \varepsilon^{-1} \cdot \lambda^{m^+}(\alpha) \cdot s'_y(\alpha) - \varepsilon^{-1} \cdot \lambda^{m^+}(\alpha) \cdot \sigma_u^{n^\pm}(\alpha) \cdot \partial_y \mathcal{Y}_\alpha^s(0) \cdot q'_y(\alpha)).$$

End of the proof of Proposition 2.4. Corollaries 5.14 and 5.11 reduce the family $(\mathcal{R}g_\alpha^\pm)_\alpha$ to:

$$(x, y) \mapsto (0, (\Delta + \alpha) \cdot y) + (s'_x(0), \varepsilon^{-1} \cdot \lambda^{m^+}(\alpha) \cdot s'_y(\alpha) + \varepsilon^{-1} \cdot \lambda^{m^+}(0) \cdot \sigma_u^{n^\pm}(0) \cdot \partial_y \mathcal{Y}_0^s(0) \cdot q'_y(0)).$$

As in Section 5.6,

$$\varepsilon^{-1} \cdot \lambda^{m^+}(0) \cdot \sigma_u^{n^-}(0) \cdot \partial_y \mathcal{Y}_0^s(0) \cdot q'_y(0) = 2(\Delta - 1) \quad \text{and} \quad \varepsilon^{-1} \cdot \lambda^{m^+}(0) \cdot \sigma_u^{n^+}(0) \cdot \partial_y \mathcal{Y}_0^s(0) \cdot q'_y(0) = O(\varepsilon).$$

As we started with a strong C^r -paraheterocycle, all the r -first derivatives of $\alpha \mapsto s'_y(\alpha)$ equal 0 at 0. So by Claim 5.1, we can perturb $(f_a)_a$ so that $\alpha \mapsto s'_y(\alpha)$ has the same r -jet as the C^r -small function $\alpha \mapsto \varepsilon \cdot \lambda^{-m^+}(\alpha) \cdot (\Delta - 1)$ at $\alpha = 0$. Then we obtain that $(\mathcal{R}g_\alpha^\pm)_\alpha$ are δ - C^r -close to:

$$(x, y) \mapsto (s'_x(0), (\Delta + \alpha) \cdot y \pm (\Delta - 1)),$$

and hence defines a δ -nearly affine C^r -parablender, where δ is arbitrarily close to 0 when $\varepsilon \rightarrow 0$. By Proposition 1.19, one deduces that the maximal invariant set K_a induced by the maps g_a^+, g_a^-

is a C^r -parablender. Its activation domain see in the chart \mathcal{H}_α contains any germ $\alpha \mapsto z(\alpha)$ with $z(0) \in [-2, 2] \times \{0\}$ and $\|\partial_\alpha z(\alpha)\|_{C^{r-1}} \leq \eta$, where $\eta > 0$ is small number independent from ε . Note that our perturbation satisfies $\mathcal{H}_\alpha(S'_\alpha) = (s'_x(\alpha), \varepsilon(\Delta - 1))$. Combining with Corollary 5.11, item 1, one concludes that the activation domain of $(K_\alpha)_{\alpha \in I}$ contains the germ of $(S'_\alpha)_\alpha$, and the germ of the source (S_α) at $\alpha = 0$. We also recall that Q is homoclinically related to the (para)-blender. Proposition 2.4 is proved. \square

Remark 5.15. For each point $\underline{x} \in \overleftarrow{K}$, let $\gamma_{\underline{x}}$ be the unstable curve of \underline{x} which is a graph over $[-2, 2]$. The activation domain is obtain by considering the local unstable manifolds of the form $(\mathcal{T}^s)^{-1}(\gamma_{\underline{x}})$. By assumption (5.3), $W^u(Q)$ is transverse to $E^{cu}(S)$. One deduces that the family of local unstable manifolds defining the activation domain of the parablender satisfies the property announced in Remark 2.5.

References

- [BCP17] P. Berger, S. Crovisier, and E. Pujals. Iterated functions systems, blenders, and parablenders. In Recent developments in fractals and related fields (Porquerolles 2015). *Trends Math.*, pages 57–70. Birkhäuser/Springer, 2017. [1](#), [5](#), [10](#), [12](#), [13](#)
- [BD96] C. Bonatti and L. Díaz. Persistent nonhyperbolic transitive diffeomorphisms. *Ann. of Math.* **143** (1996), 357–396. [3](#), [8](#), [10](#)
- [BD99] C. Bonatti and L. Díaz. Connexions hétéroclines et genericité d’une infinité de puits et de sources. *Ann. Sci. École Norm. Sup.* **32** (1999), 135–150. [2](#)
- [BDK12] C. Bonatti, L. Díaz, and S. Kiriki. Stabilization of heterodimensional cycles. *Nonlinearity* **25** (2012), 931–960. [4](#), [5](#), [10](#)
- [Ber] P. Berger. Generic family displaying robustly a fast growth of the number of periodic points. To appear in *Acta Mathematica*, preprint ArXiv:1701.02393. [5](#)
- [Ber16] P. Berger. Generic family with robustly infinitely many sinks. *Invent. Math.* **205** (2016), 121–172. Corrigendum: *Invent. Math.* **218** (2019), 649–656. [1](#), [2](#), [3](#), [4](#), [5](#), [12](#)
- [Ber17] P. Berger. Emergence and non-typicality of the finiteness of the attractors in many topologies. *Proceedings of the Steklov Institute of Mathematics* **297** (2017), 1–27. [1](#), [2](#), [3](#), [5](#), [17](#), [18](#), [19](#), [25](#)
- [Ber20] P. Berger. Complexities of differentiable dynamical systems. *Journal of Mathematical Physics* **61** (2020), 032702. [5](#)
- [Bie20] S. Biebler. Newhouse phenomenon for automorphisms of low degree in \mathbb{C}^3 . *Adv. Math.* **361** (2020), 106952. [2](#)
- [BRa] P. Barrientos and A. Raibekas. Berger domains and kolmogorov typicality of infinitely many invariant circles. ArXiv:2102.07962. [5](#)
- [BRb] P. Barrientos and J.D. Rojas. Typical coexistence of infinitely many strange attractors. ArXiv:2102.08316. [5](#)
- [BR13] P. Berger and A. Rovella. On the inverse limit stability of endomorphisms. *Ann. Inst. H. Poincaré Anal. Non Linéaire* **30** (2013), 463–475. [7](#)
- [Buz97] G.T. Buzzard. Infinitely many periodic attractors for holomorphic maps of 2 variables. *Ann. of Math. (2)* **145** (1997), 389–417. [2](#)

- [D95] L. Díaz. Robust nonhyperbolic dynamics and heterodimensional cycles. *Ergodic Theory Dynam. Systems* (1995), 291–315. [8](#)
- [DNP06] L. Díaz, A. Nogueira, and E. Pujals. Heterodimensional tangencies. *Nonlinearity* **19** (2006), 2543–2566. [2](#)
- [DP] L. J. Díaz and S. A. Pérez. Nontransverse heterodimensional cycles: stabilisation and robust tangencies. ArXiv:2011.08926. [4](#)
- [Dua08] P. Duarte. Elliptic isles in families of area-preserving maps. *Ergodic Theory Dynam. Systems* **28** (2008), 1781–1813. [2](#)
- [GK07] A. Gorodetski and V. Kaloshin. How often surface diffeomorphisms have infinitely many sinks and hyperbolicity of periodic points near a homoclinic tangency. *Adv. Math.* **208** (2007), 710–797. [2](#), [6](#)
- [Gra58] H. Grauert. On levi’s problem and the imbedding of real-analytic manifolds. *Annals of Mathematics* **68** (1958), 460–472. [25](#)
- [HK10] B. Hunt and V. Kaloshin. *Prevalence*, pages 43–83. Handbook of dynamical systems, volume 3. Elsevier, 2010. [2](#), [5](#), [6](#)
- [HSY92] B. Hunt, T. Sauer, and J. Yorke. Prevalence: a translation-invariant “almost every” on infinite-dimensional spaces. *Bull. Amer. Math. Soc.* **27** (1992), 217–238. Addendum: *Bull. Amer. Math. Soc.* **27** (1992), 217–238. [5](#), [6](#)
- [IL99] Yu. Ilyashenko and Weigu Li. *Nonlocal bifurcations*, volume 66 of *Mathematical Surveys and Monographs*. American Mathematical Society, Providence, RI, 1999. [2](#), [5](#)
- [IS17] Y. Ilyashenko and I. Shilin. Attractors and skew products. In *Modern theory of dynamical systems*, volume 692 of *Contemp. Math.*, pages 155–175. Amer. Math. Soc., Providence, RI, 2017. [5](#)
- [KZ20] V. Kaloshin and K. Zhang. *Arnold Diffusion for Smooth Systems of Two and a Half Degrees of Freedom: (AMS-208)*. Princeton University Press, 2020. [2](#)
- [LT] D. Li and D. Turaev. Persistence of heterodimensional cycles. To appear in ArXiv. [4](#), [10](#)
- [Mat03] J. Mather. Arnol’d diffusion. I. Announcement of results. *Sovrem. Mat. Fundam. Napravl.* **2** (2003), 116–130. translation in *J. Math. Sci.* **124** (2004), 5275–5289. [2](#)
- [New70] S. Newhouse. Nondensity of axiom A(a) on S^2 . In *Global Analysis (Proc. Sympos. Pure Math., Vol. XIV, Berkeley, Calif., 1968)*, pages 191–202. Amer. Math. Soc., Providence, R.I., 1970. [3](#)
- [New74] S. Newhouse. Diffeomorphisms with infinitely many sinks. *Topology* **12** (1974), 9–18. [1](#), [3](#), [8](#)
- [New79] S. Newhouse. The abundance of wild hyperbolic sets and nonsmooth stable sets for diffeomorphisms. *Publ. Math. Inst. Hautes Études Sci.* **50** (1979), 101–151. [1](#), [3](#), [8](#)
- [Pal00] J. Palis. A global view of dynamics and a conjecture on the denseness of finitude of attractors. In *Géométrie complexe et systèmes dynamiques (Orsay, 1995)*. *Astérisque* **261** (2000), 335–347. [2](#)
- [Pal05] J. Palis. A global perspective for non-conservative dynamics. *Annales de l’Institut Henri Poincaré. Analyse Non Linéaire* **22** (2005), 485–507. [2](#)

- [Pal08] J. Palis. Open questions leading to a global perspective in dynamics. *Nonlinearity* **21** (2008), T37–T43. [2](#)
- [PS96] C. Pugh and M. Shub. Stable ergodicity and partial hyperbolicity. In Int. Conf. on Dynamical Systems (Montevideo, 1995). *Pitman Res. Notes Math. Ser.* **362**, pages 182–187. Longman, Harlow, 1996. [2](#)
- [PT93] J. Palis and F. Takens. *Hyperbolicity and sensitive chaotic dynamics at homoclinic bifurcations*, volume 35 of *Cambridge Studies in Advanced Mathematics*. Cambridge University Press, Cambridge, 1993. [2](#), [16](#), [21](#)
- [Ste58] S. Sternberg. On the structure of local homeomorphisms of euclidean n -space. II. *Amer. J. Math.* **80** (1958), 623–631. [20](#), [30](#)
- [Tak71] F. Takens. Partially hyperbolic fixed points. *Topology* **10** (1971), 133–147. [27](#), [36](#)
- [TLY86] L. Tedeschini-Lalli and J. Yorke. How often do simple dynamical processes have infinitely many coexisting sinks? *Comm. Math. Phys.* **106** (1986), 635–657. [2](#)
- [Yoc95] J.-C. Yoccoz. Introduction to hyperbolic dynamics. In Real and complex dynamical systems (Hillerød, 1993). *NATO Adv. Sci. Inst. Ser. C Math. Phys. Sci.* **464**, pages 265–291. Kluwer Acad. Publ., Dordrecht, 1995. [21](#)

Pierre Berger

pierre.berger@imj-prg.fr

Institut de Math. Jussieu-Paris Rive Gauche
Sorbonne Université, Univ. de Paris, CNRS,
F-75005 Paris, France

Sylvain Crovisier

sylvain.crovisier@math.u-psud.fr

Laboratoire de Mathématiques d’Orsay
CNRS - UMR 8628, Univ. Paris-Saclay
Orsay 91405, France

Enrique Pujals

epujals@gc.cuny.edu

Graduate Center-CUNY
New York, USA