

K-FACE: A Large-Scale KIST Face Database in Consideration with Unconstrained Environments

Yeji Choi^{*1,2}, Hyunjung Park^{*1,3}, Gi Pyo Nam¹, Haksob Kim¹, Heeseung Choi¹, Junghyun Cho¹ and Ig-Jae Kim^{†1,3}

¹Korea Institute of Science and Technology (KIST)

²Yonsei University

³KIST-School, University of Science and Technology

Abstract

In this paper, we introduce a new large-scale face database from KIST, denoted as K-FACE, and describe a novel capturing device specifically designed to obtain the data. The K-FACE database contains more than 1 million high-quality images of 1,000 subjects selected by considering the ratio of gender and age groups. It includes a variety of attributes, including 27 poses, 35 lighting conditions, three expressions, and occlusions by the combination of five types of accessories. As the K-FACE database is systematically constructed through a hemispherical capturing system with elaborate lighting control and multiple cameras, it is possible to accurately analyze the effects of factors that cause performance degradation, such as poses, lighting changes, and accessories. We consider not only the balance of external environmental factors, such as pose and lighting, but also the balance of personal characteristics such as gender and age group. The gender ratio is the same, while the age groups of subjects are uniformly distributed from the 20s to 50s for both genders. The K-FACE database can be extensively utilized in various vision tasks, such as face recognition, face frontalization, illumination normalization, face age estimation, and three-dimensional face model generation. We expect systematic diversity and uniformity of the K-FACE database to promote these research fields.

1. Introduction

With the development of deep learning and advent of large-scale facial databases, deep-learning-based algorithms have exhibited remarkable performances in chal-

lenging research topics of computer vision related to facial images such as unconstrained face recognition, age estimation, and three-dimensional (3D) face transformation [11, 18, 15]. In particular, large-scale face database is one of the most important factors for the successfulness of deep learning models. The distinguishing features of a good database are high-quality images, number of subjects and images, as well as diversity of intra- and inter-class variations, uniformity of class distribution, and accurate annotation. However, most public face databases consider only some features and are not designed to focus on other variants. We address this issue by introducing a process of construction of a large-scale face database that guarantees the diversity and uniformity of data and accurate annotation. The proposed database enables to precisely analyze the effects of factors that cause performance degradation, such as poses, lighting changes, and accessories.

Public large-scale unconstrained face databases are divided into two categories according to the method used for image acquisition using web crawling and capturing device. As shown in Table 1, the first approach to collect facial images of celebrities or public figures via the Internet, including CelebA [14], CASIA-WebFace [19], and VGGFace2 [2], can acquire a large number of identities. However, owing to the lack of capturing condition information, the process is time-consuming and complex to obtain a correct label for an image and the obtained labels are limited to some categories and can be very unbalanced. For example, in VGG2, poses are categorized into only three angles (front, three-quarter, or profile views), while ages are classified into only two groups (deemed young or mature). The other approach, including Multi-PIE [4] and M²FPA [6], collects face images using a specially manufactured capturing device by recruiting subjects. In this case, the number of identities is limited, but clear annotations can be arranged automatically. How-

*Equally-contributed first author(cjycjy91@kist.re.kr,phj0307@kist.re.kr)

†Corresponding author (drjay@kist.re.kr)

Table 1. Comparisons of public databases.

Database	# Subjects	# Images	Pose	Illumination		Expression	Accessory	Age	Gender
				Type	Intensity				
CelebA[14]	10,177	202,599	No label	No label	No label	No label	No label	No label	Labeled (58.0% females)
CASIA-WebFace[19]	10,575	494,414	No label	No label	No label	No label	No label	No label	Labeled (41.1% females)
VGGFace2[2]	9,131	3,310,000	3	No label	No label	No label	No label	Labeled (Young or mature)	Labeled (40.7% females)
Multi-PIE[4]	337	755,307	15	19	No label	6	×	Labeled (Not balanced)	Labeled (30.3% females)
M ² FPA[6]	229	397,544	62	7	No label	3	1	No label	No label
K-FACE(Ours)	1,000	17,550,000	27	35	0-1000 lux	3	6+	Labeled, Balanced(20-59)	Labeled (50.2% females)

ever, most of these databases focus only on the environmental conditions of capturing so that the gender and age of the subjects are severely unbalanced and have a positively skewed distribution, which is concentrated in the younger age group. Furthermore, it does not evenly include extreme pose changes, transitions in the intensity and direction of lighting, and wearing multiple accessories, which are common in real-world scenarios. To address these issues, we introduce a novel large-scale unconstrained face database denoted as K-FACE. The main contributions of this study are summarized as follows.

- **Large-scale and high quality.** We construct the first large-scale and high-quality database of Koreans. We constructed the first large-scale high-quality database of Koreans. It contains a total of 17,550,000 images of 1,000 subjects with 17,550 images per person with various attributes. All images were captured using digital single-lens reflex (DSLR) cameras, which provided high-quality images with resolutions of 2592×1728 . The proposed database has advantages in both quantity of subjects and quality of images.
- **Diversity.** Through the hemispherical capturing system consisting of 27 cameras and 10 lighting devices, we obtained face images including 27 poses with changes in roll and yaw directions, 35 lighting conditions according to combinations of intensity and direction, three expressions, and multiple occlusions with five types of accessories such as glasses, cap, and mask. This allows many researchers to advance their specific topic by sampling the most appropriate subset.
- **Well balanced.** The proposed database includes all above elements evenly according to gender and age. The construction of different types of subsets by controlling specific properties enables to configure vari-

ous experimental environments and judge the factors of degradation.

The remainder of this paper is organized as follows. Section II introduces several representative public face databases. Section III describes the details of the K-FACE settings and statistics. In Section IV, we present challenging research topics that can be addressed by utilizing the proposed database. Finally, Section V concludes the paper.

2. Related Studies

2.1. CelebA

The CelebA database was introduced for face representation and attribute prediction in the wild [14] [7]. All face images were collected via the Internet. It contains a total of 202,599 images from 10,177 identities with five landmark points and 40 face attributes. For the details of face attributes, it provides a binary attribute about specific factors such as blonde and wearing sunglasses or not. In this regard, this database has been widely used not only for face recognition, but also for face landmark detection and attribute prediction. The research fields based on the CelebA database are extended to generative adversarial network-based methods, such as style transfer.

2.2. CASIA-WebFace

Yi *et al.* introduced a novel database, CASIAWebFace database, which consists of 494,414 images from 10,575 individuals collected from the web [19]. There are no environmental constraints in the collected image, such as pose, illumination, and expression. This implies that the CASIAWebFace database is close to the real-world environment, so that the database has been used widely to train unconstrained face recognition models. However, it is challeng-

ing to analyze the factors that affect the recognition performance because they do not provide the attribute information of the data, such as pose direction and illumination condition.

2.3. VGGFace2

The VGGFace database, the first version of VGGFace2, was released by Parkhi *et al.* in 2015 [12]. This database aims to train for the increase in face recognition accuracy. In terms of face recognition, the number of identities and images of each subject in the training set is one of the most important factors affecting the recognition performance. To consider this issue, the VGGFace database consists of 2.6 million images acquired from 2,622 people by crawling on the web. Cao *et al.* introduced the VGGFace2 [2] database, which was extended from VGGFace. It is constructed from 9,131 people and has a total of 3.31 million images. For ethnic balancing, it includes more Asian people than the previous version, although it is still limited. In addition, the database provides annotations about pose and age.

2.4. Multi-PIE

Gross *et al.* released a face database, denoted as Multi-PIE, acquired under various camera directions and illumination conditions to consider the pose, illumination, and expression variation [4]. It includes over 750,000 images captured from 337 individuals and considers a total of 15 camera directions and 18 light directions. Thirteen cameras were located at head height with 15° intervals, from -90° to +90°, and the others were installed above the subjects in consideration of the surveillance camera view. Illuminators were also installed near the locations of the cameras to consider various directions. However, it does not consider the luminance power; therefore, all images have the same lighting power.

2.5. M²FPA

Li *et al.* released the M²FPA database, which addresses the facial pose analysis, including frontalization, pose estimation, and pose-invariant face recognition [6]. It contains 397,544 images of 229 subjects with yaw, pitch, attribute, illumination, and accessory. The authors designed an image acquisition system to capture the person with multiple-yaw and pitch direction. They evaluated the performance of face frontalization and pose-invariant face recognition on M²FPA based on several state-of-the-art methods such as DR-GAN[16] and TP-GAN[5].

3. K-FACE Database

3.1. Capturing Device

To build the K-FACE database, we designed an elaborate hemispherical system as shown in Figure 1. This novel

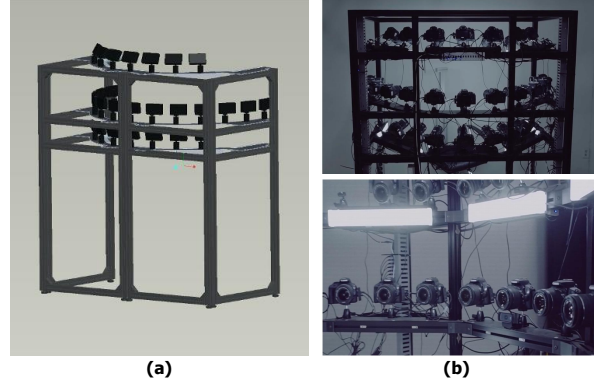

Figure 1. Capturing device. (a) Concept design and (b) actual appearance.

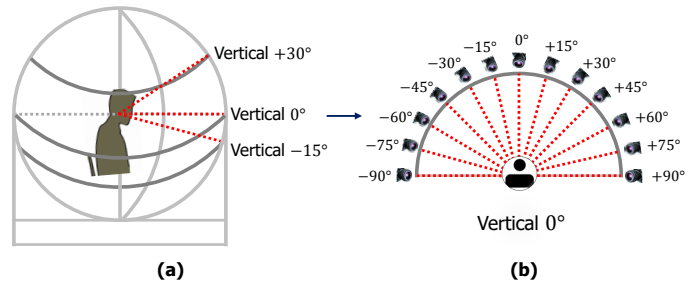

Figure 2. Positions of the cameras in the capturing device. (a) Vertical axis angle and (b) horizontal axis angle at 0° on the vertical axis.

system consists of 27 FHD DSLR cameras and 10 lighting devices installed at regular angular intervals. To acquire images more efficiently and systematically, all cameras were synchronized to acquire data at once. The camera was Canon EOS 100D, while the resolution of the images was 2592×1728 . As shown in Figure 2, based on the vertical axis, three hemisphere bars were placed at 0° in front of the face, +30°, and -15°. There were 13 cameras on the bar at 0° on the vertical axis. Based on the horizontal axis, the front of the face was at 0° and the cameras were located at 15° intervals from -90° to +90° in the left and right directions. The bars at +30° and -15° on the vertical axis contained seven cameras at equal intervals from -45° to +45°. Therefore, a total of 27 cameras were located at (horizontal axis, vertical axis): $(\pm 90, 0)$, $(\pm 75, 0)$, $(\pm 60, 0)$, $(\pm 45, 0)$, $(\pm 30, 0)$, $(\pm 15, 0)$, $(0, 0)$, $(\pm 45, +30)$, $(\pm 30, +30)$, $(\pm 15, +30)$, $(0, +30)$, $(\pm 45, -15)$, $(\pm 30, -15)$, $(\pm 15, -15)$, and $(0, -15)$. Moreover, to obtain images in various lighting environments, a total of 10 lighting devices, which can be individually controlled, were placed at (horizontal axis, vertical axis): $(\pm 90, +30)$, $(\pm 45, +30)$, $(0, +30)$, $(\pm 90, -15)$, $(\pm 45, -15)$ and $(0, -15)$. As shown in Table 2, we generated a total of 35 different lighting conditions by adjusting the intensities from zero to 1,000 lux and changing the lighting direction to include partial illumination for shadows on

Table 2. The configuration of K-FACE database.

Direction	+	-	Illumination				Pose		
Vertical	Up	Down	Label	Lux	Direction		Label	Direction	
Horizontal	Right	Left			Vertical	horizontal		Vertical	horizontal
			L1	1,000	All - vertical: +30, -15 - horizontal: +90 ~ -90 (interval: 45)		C1		+90
			L2	400			C2		+75
			L3	200			C3		+60
			L4	150			C4		+45
			L5	100			C5		+30
			L6	40			C6		+15
			L7	0			C7		0
			L8	400	+30	0	C8		-15
			L9	200			C9		-30
			L10	100			C10		-45
			L11	40			C11		-60
			L12	400	-15	All	C12		-75
			L13	200			C13		-90
			L14	100			C14		+45
			L15	40			C15		+30
			L16	400	All	+90	C16		+15
			L17	200			C17		0
			L18	100			C18		-15
			L19	40			C19		-30
			L20	400			C20		-45
			L21	200			C21		+45
			L22	100			C22		+30
			L23	40	+45	+30	C23		+15
			L24	400			C24		0
			L25	200			C25		-15
			L26	100			C26		-30
			L27	40	0	-15	C27		-45
			L28	400			C1		+90
			L29	200			C2		+75
			L30	100			C3		+60
			L31	40	-45	All	C4		+45
			L32	400			C5		+30
			L33	200			C6		+15
			L34	100			C7		0
			L35	40	-90	All	C8		-15
							C9		-30
							C10		-45

Label	Accessories
S001	Neutral (None)
S002	Glasses
S003	Horn-rimmed glasses
S004	Sunglasses
S005	Cap
S006	Cap + Horn-rimmed glasses
S007	(E10) Mask (E11) Cap + Glasses (E12) Cap + Sunglasses (E13) Cap + Mask (E14) Mask + Glasses (E15) Mask + HG (E16) Mask + Sunglasses (E17) Mask + Glasses + Cap (E18) Mask + HG + Cap (E19) Mask + Sunglasses + Cap * HG: Horn-rimmed glasses

Label	Expression
E01	Neutral
E02	Smile
E03	Disgust

the face. All labels regarding poses, lighting intensities, and directions were provided.

3.2. Data Acquisition and Annotating

To avoid data bias, a common problem in public databases, caused by the concentration of data on specific age groups or genders that are simple to obtain, we recruited subjects aged 20–50 years. Using the system described in Section 3.1, images of a subject were then acquired while wearing various accessories such as cap, two types of glasses, sunglasses, and mask, in various lighting environments for approximately 2 h. We had constructed K-FACE database for a long time since 2017[8]. The total number of images per subject was 17,550, which included diverse poses and three facial expression changes. Finally, we gathered a total of 17,550,000 images from 1,000 subjects.

Furthermore, to improve the quality and ensure the sophistication of our database, we cleaned and supplemented the data as soon as they were collected. To this end, full inspection was performed manually. Subsequently, if damaged data existed (e.g., out of focus, closed eyes, not match-

ing the lighting conditions due to synchronization delays), the data were immediately retaken to maintain the data distribution for all subjects and conditions. To expand the usability of the database, we also provided additional information about the facial landmark positions and bounding boxes.

As shown in Figure 3, seven coordinates for the facial

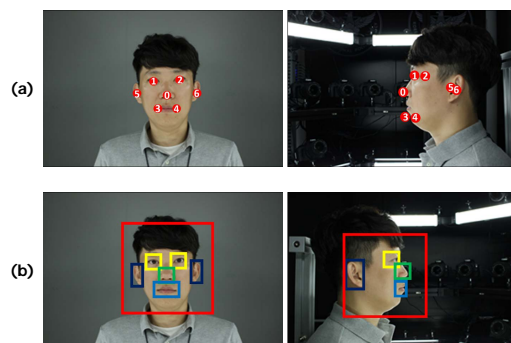

Figure 3. The positions of (a) facial landmarks and (b) bounding boxes.

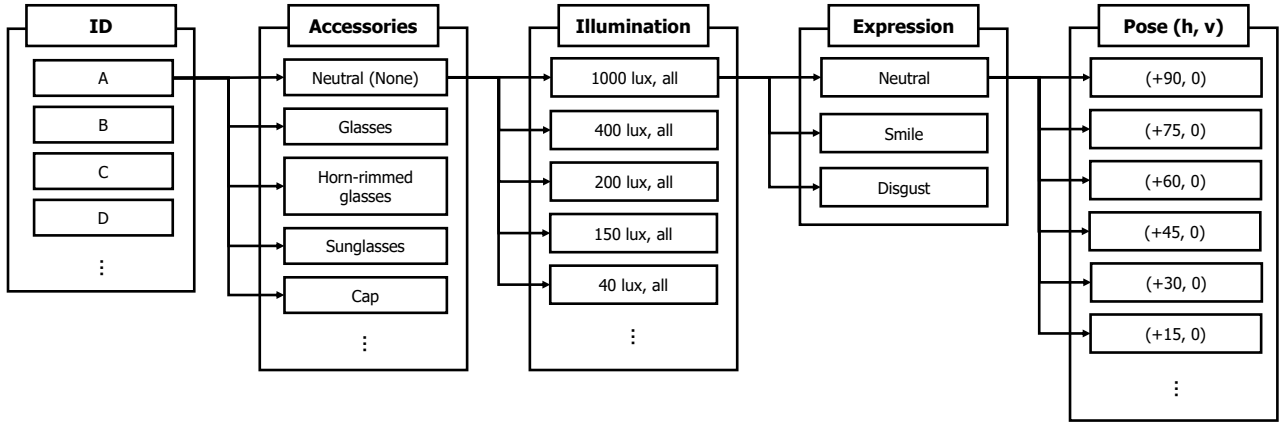

Figure 4. Structure of the K-FACE database.

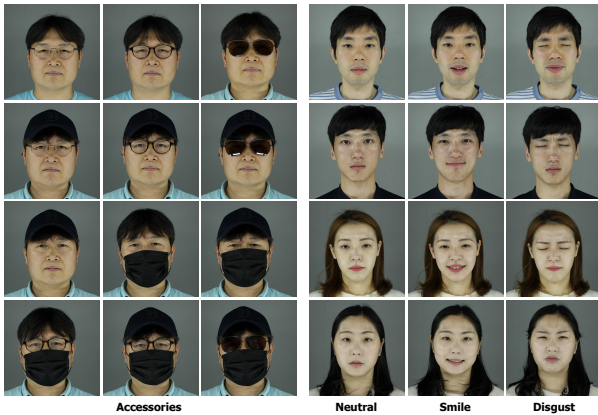

Figure 5. Sample images of accessories and expressions (neutral, smile, and disgust).

landmarks are offered: endpoint of the nose, centers of both eyes, left and right angles of the mouth, and centers of both ears. For bounding boxes, seven regions are provided: the entire face, both eyes, both ears, nose, and mouth.

3.3. Database Statistics

The K-FACE database was elaborately and systematically constructed while maintaining the ratio of age distribution, gender, and number of images per subject to overcome the limitations in existing public databases due to data imbalance. The data were acquired for those in their 20s to 50s and the distribution of each age group was the same (approximately 25%). The proportions of males and females were 49.8% and 50.2%, respectively, so that the gender ratio was almost the same. The gender ratios in each age group were also the same. Additionally, all subjects had the same number of images for each condition to enable an accurate statistical analysis of changes in pose, lighting, facial expressions, and accessories.

The K-FACE database is structurally well organized to

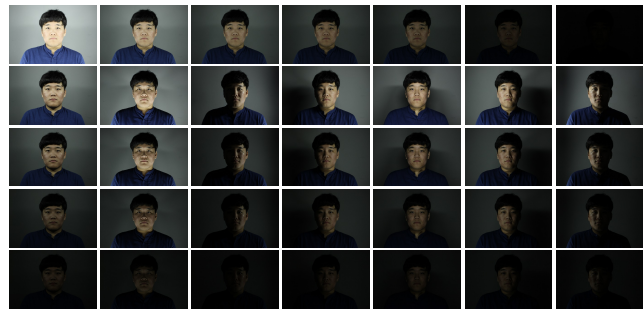

Figure 6. Sample images of lighting changes.

increase the usability. As shown in Figure 4, it consists of a total of five layers: identities, accessories, illuminations, expressions, and poses. There are a total of seven accessory conditions: neutral (none), where the subject did not wear anything, glasses, horn-rimmed glasses, sunglasses, cap, horn-rimmed glasses and cap, and combination of some accessories. In the last condition, to respond to the situation where wearing a mask becomes more common due to the spread of the coronavirus disease 2019 (COVID-19), we added a mask and expanded the diversity with a variety of 10 combinations such as cap and mask. The sample images of the accessory conditions are shown in Figure 5; further details are presented in Table 2. Each accessory condition includes 35 lighting conditions, except for the last accessory condition, which has only two lighting changes. As shown in Figure 6, some extreme illumination cases are included; for instance, when the intensity is close to zero. There are three facial expressions, neutral, smile, and disgust, per each lighting condition except for the last accessory condition. This case was acquired in one expression, neutral. Finally, there were 27 poses per facial expression. The sample images of all expressions and all poses are shown in Figure 5 and Figure 7, respectively.

Consequently, the K-FACE database is a uniformly or-

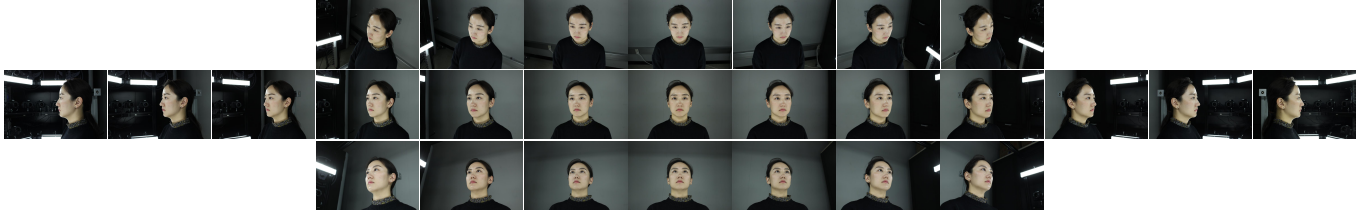

Figure 7. Sample images of poses.

ganized database of six accessories, 35 lighting conditions, three facial expressions, and 27 poses. Therefore, the number of images per subject is 17,550: 6 (accessory conditions) \times 35 (illumination conditions) \times 3 (expressions) \times 27 (poses) $+ 10$ (combinations of accessory conditions) \times 2 (illumination conditions) \times 1 (expression) \times 27 (poses). We also provide labels for all information, such as accessory conditions, which are denoted as S001, expressions, illumination changes, and poses, for all images. The notation of each label is shown in Figure 4.

4. Applicable Research Fields

The proposed K-FACE database can be utilized in all deep-learning research fields related to face images. Among the various research fields, representative challenging research topics that can be addressed by utilizing the K-FACE database are unconstrained face recognition and face age estimation.

4.1. Unconstrained Face Recognition

Inspired by the emergence of the large-scale face database and development of deep-learning-based image classification technology, the accuracy of face recognition has been largely improved to a level that surpasses the human recognition performance on some popular benchmarks. Nevertheless, the recognition of face images captured in the real world remains a challenging task, particularly in cases of changing poses, lighting conditions, facial expressions, and wearing accessories. In this respect, the proposed K-FACE database provides not only various face images in a highly balanced distribution, but also accurate labels for all information, such as poses, illumination conditions (intensity and direction), facial expressions, and types of accessories, which is significant in establishing a robust face recognizer in unconstrained environments.

Face image with pose variation is one of the most important factors that can degrade the face recognition performance. To solve this problem, extensive studies have been carried out based on face frontalization, which converts the face image to a frontal view, and pose-invariant face recognition in the real world. As K-FACE includes images in the vertical and horizontal directions, images acquired from the top angle can reproduce public video surveillances such as

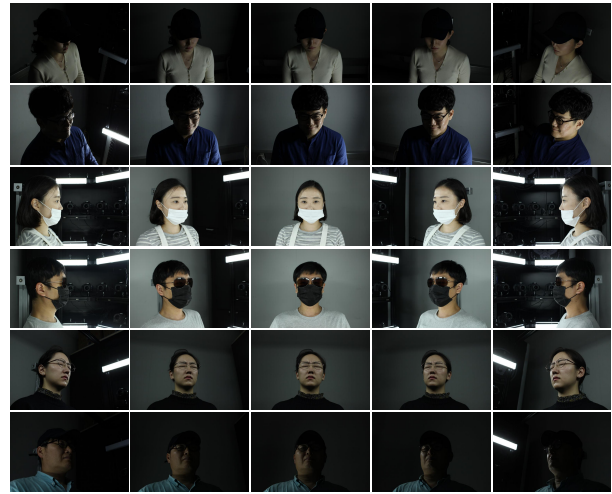

Figure 8. The sample images for unconstrained face recognition.

closed-circuit television and access control systems, while face images acquired from the bottom angle can be used to improve the accuracy in scenarios such as ATM and body cam. Regarding the changes in lighting, the face recognition accuracy can be degraded by reflections or shadows caused by an extremely low light intensity or partial illumination. Most existing face databases include only the direction of illumination, while the K-FACE database also includes the intensity of illumination, so that it is possible to study image-based lighting normalization under various conditions and model the lighting environment according to various directions and intensities. Moreover, K-FACE allows researchers to investigate face recognition robust to facial deformation caused by facial expression changes, such as neutral, smile, and disgust, and occlusion caused by wearing a mask, sunglasses, glasses, and cap. In particular, the demand for reliable identification systems for masked faces significantly increases owing to the COVID-19 pandemic [17]. The K-FACE database will enable researchers to develop and evaluate identification algorithms that utilize the upper part of the face or ear recognition. Figure 8 shows sample images in unconstrained environments, including various facial expressions wearing caps, sunglasses, and masks, acquired from different viewing angles under extreme light sources.

4.2. Face Age Estimation and Aging Simulation

Age estimation from face images and face aging, also referred to as age synthesis or age progression, has applications in various domains, including age-invariant face recognition, finding missing children, and entertainment[1]. In recent years, numerous face estimation and aging models have been proposed using the face age database and have provided impressive aging results for natural face images[9, 13, 10, 3]. However, the face estimation and aging can be still improved in real cases where many different poses, lighting changes, and occlusions occur. Changes in the above elements largely alter the appearance of the face and distort the morphological facial shape. These facts interfere with the accurate age estimation and often lead to the loss of the original person's identity in the aging simulations. In this respect, K-FACE enables age estimation applicable in real life as it includes face images with ages of 20 to 60 years acquired at various poses, lightings, facial expressions, and wearing accessories. Through the images provided by K-FACE, it is possible to capture components such as face shape, skin texture, and wrinkles that vary by age group.

4.3. Others

In addition to the aforementioned face recognition and age recognition fields, the K-FACE database can be used in various other fields. For instance, to perform an elaborate 3D face restoration using only two-dimensional images without depth information, multiple images acquired from various angles are required. Therefore, in this case, the K-FACE database containing images acquired from various angles is very useful. Furthermore, using information about landmarks and bounding boxes provided in the K-FACE databases, pose estimation, which predicts a pose in the face direction, and face or attribute (such as eyes, nose, and ears) detection can be performed.

5. Conclusion

In this paper, we introduced a novel large-scale face database, the K-FACE database, which contains 17,550,000 images of 1,000 subjects. This database was constructed uniformly and systematically by considering the ratio of age groups, gender ratio, and data distribution per subject. It also includes images acquired in various unconstrained environments, including poses, lighting changes, and accessories. Furthermore, it is possible to perform an accurate statistical analysis of the changes by offering labels for all conditions for all images. Therefore, it is a very valuable database that can be used in various fields, such as unconstrained face recognition, age estimation, and face reconstruction. We also designed a sophisticated device to facilitate the database construction. The quality of the database

can be guaranteed through manual data inspection. In future studies, we will carry out various experiments such as unconstrained face recognition and aging simulation using state-of-the-art methods to verify the validity and applicability of the K-FACE database.

Acknowledgement

This research was funded by R&D program for Advanced Integrated-intelligence for IDentification (AIID) through the National Research Foundation of Korea (NRF) funded by Ministry of Science and ICT, grant number (2018M3E3A1057288).

References

- [1] G. Antipov, M. Baccouche, and J.-L. Dugelay. Face aging with conditional generative adversarial networks. In *2017 IEEE international conference on image processing (ICIP)*, pages 2089–2093. IEEE, 2017. 7
- [2] Q. Cao, L. Shen, W. Xie, O. M. Parkhi, and A. Zisserman. Vggface2: A dataset for recognising face across pose and age. In *Proceedings of International Conference on Automatic Face and Gesture Recognition*, 2018. 1, 2, 3
- [3] B.-C. Chen, C.-S. Chen, and W. H. Hsu. Cross-age reference coding for age-invariant face recognition and retrieval. In *Proceedings of the European Conference on Computer Vision (ECCV)*, 2014. 7
- [4] R. Gross, I. Matthews, J. F. Cohn, T. Kanade, and S. Baker. Multi-pie. In *Proceedings of International Conference on Automatic Face and Gesture Recognition*, 2008. 1, 2, 3
- [5] R. Huang, S. Zhang, T. Li, and R. He. Beyond face rotation: Global and local perception gan for photorealistic and identity preserving frontal view synthesis. In *Proceedings of the IEEE international conference on computer vision*, pages 2439–2448, 2017. 3
- [6] P. Li, X. Wu, Y. Hu, R. He, and Z. Sun. M²fpa: a multi-yaw multi-pitch high-quality dataset and benchmark for facial pose analysis. In *Proceedings of International Conference on Computer Vision*, 2019. 1, 2, 3
- [7] Z. Liu, P. Luo, X. Wang, and X. Tang. Deep learning face attributes in the wild. In *Proceedings of International Conference on Computer Vision*, 2015. 2
- [8] G. P. Nam, H. Choi, J. Cho, and I.-J. Kim. Large-scale korean face database construction. In *The Institute of Electronics and Information Engineers*, pages 62–63, 2017. 4
- [9] Z. Niu, M. Zhou, L. Wang, X. Gao, and G. Hua. Ordinal regression with multiple output cnn for age estimation. In *Proceedings of the IEEE conference on computer vision and pattern recognition*, pages 4920–4928, 2016. 7
- [10] R. Or-El, S. Sengupta, O. Fried, E. Shechtman, and I. Kemelmacher-Shlizerman. Lifespan age transformation synthesis. In *European Conference on Computer Vision (ECCV'20)*, 2020. 7
- [11] O. M. Parkhi, A. Vedaldi, and A. Zisserman. Deep face recognition. *British Machine Vision Association*, 2015. 1

- [12] O. M. Parkhi, A. Vedaldi, and A. Zisserman. Deep face recognition. In *Proceedings of British Machine Vision Conference*, 2015. 3
- [13] K. Ricanek and T. Tesafaye. Morph: A longitudinal image database of normal adult age-progression. In *7th International Conference on Automatic Face and Gesture Recognition (FG06)*, pages 341–345. IEEE, 2006. 7
- [14] Y. Sun, X. Wang, and X. Tang. Deep learning face representation from predicting 10,000 classes. In *Proceedings of IEEE Conference on Computer Vision and Pattern Recognition*, June 2014. 1, 2
- [15] L. Tran and X. Liu. Nonlinear 3d face morphable model. In *Proceedings of the IEEE conference on computer vision and pattern recognition*, pages 7346–7355, 2018. 1
- [16] L. Tran, X. Yin, and X. Liu. Disentangled representation learning gan for pose-invariant face recognition. In *Proceedings of the IEEE conference on computer vision and pattern recognition*, pages 1415–1424, 2017. 3
- [17] Z. Wang, G. Wang, B. Huang, Z. Xiong, Q. Hong, H. Wu, P. Yi, K. Jiang, N. Wang, Y. Pei, et al. Masked face recognition dataset and application. In *arXiv:2003.09093*, 2020. 6
- [18] J. Xing, K. Li, W. Hu, C. Yuan, and H. Ling. Diagnosing deep learning models for high accuracy age estimation from a single image. *Pattern Recognition*, 66:106–116, 2017. 1
- [19] D. Yi, Z. Lei, S. Liao, and S. Z. Li. Learning face representation from scratch. *arXiv:1411.7923*, 2014. 1, 2