

Line Defects in Three Dimensional Mirror Symmetry beyond Linear Quivers

Anindya Dey

*Department of Physics and Astronomy, Johns Hopkins University, 3400 North Charles Street,
Baltimore, MD 21218, USA*

E-mail: anindya.hepth@gmail.com

ABSTRACT: The map of half-BPS line defects under mirror symmetry has previously been worked out for 3d $\mathcal{N} = 4$ linear quivers with unitary gauge groups, where these defects have a clear realization in terms of a brane picture in Type IIB String Theory. In this work, we initiate the study of line defects and the associated mirror maps for more general 3d $\mathcal{N} = 4$ quiver gauge theories from a QFT approach, using the S -type operations introduced in [1]. In particular, our construction does not rely on any String Theory realization of the quiver gauge theories and the defects. After discussing the general framework for the construction of these line defects and their mirror maps, we focus on quiver gauge theories of the D -type and the affine D -type with unitary gauge groups, as a concrete set of examples. Some of the line defects we study admit a Hanany-Witten description and we show that the associated mirror maps predicted by the Type IIB construction in these cases agree with the QFT computation. In addition, we study an example involving defects in an affine D -type theory, for which the dual theory is not directly realized by the Type IIB description. In a companion paper, we will discuss defects in infinite families of non-ADE quivers using the general construction developed in this paper.

Contents

1	Introduction and summary of results	1
1.1	Background and the basic idea of the paper	1
1.2	Outline and Summary	4
2	Wilson loop and Vortex loop operators in three dimensions	6
2.1	Generalities of 3d $\mathcal{N} = 4$ QFTs and half-BPS defects	6
2.1.1	Quiver notation for 3d $\mathcal{N} = 4$ QFTs	6
2.1.2	Supersymmetry algebra and protected sectors	7
2.1.3	Wilson defect on \mathbb{R}^3	9
2.1.4	Vortex defect on \mathbb{R}^3	9
2.1.5	Mirror symmetry	11
2.2	Brane construction for line defects in linear quivers	12
2.2.1	Brane construction for linear quivers without defects	12
2.2.2	Line defects: Wilson and Vortex	15
2.2.3	S-duality and mirror map	21
2.3	Wilson/vortex defects on S^3 and the Localization formulae	22
3	Elementary S-type operations and mirror map of line defects	30
3.1	Elementary S -type operations on theories without defects: Review	30
3.2	Abelianization of the non-Abelian S -type operation	36
3.3	Elementary S -type operations on theories with defects	38
3.4	Dual operations and the new mirror map of defects	41
3.5	Simple illustrative example: Abelian S -type operations on $T(U(2))$	45
4	Beyond linear quivers : D_n and \widehat{D}_n quiver gauge theories	48
4.1	Defects in a D_4 quiver	49
4.1.1	A vortex defect for the central node	51
4.1.2	Other vortex defects in the D_4 theory	54
4.1.3	A Wilson defect for the central node	56
4.2	Generalization I : Mirror of an $Sp(N_c)$ theory with N_f flavors	58
4.3	Adding flavors to the D_4 quiver	64
4.4	Generalization II : Affine D -type quivers	67
4.5	Adding defects to the D_4 quiver	70
5	Interlude: Type IIB construction of defects in quiver gauge theories	73
5.1	Type IIB configurations involving orbifold/orientifold planes	73
5.1.1	D3-branes ending on orbifolds	73
5.1.2	S-dual configurations: D3-branes ending on orientifolds	75
5.2	Type IIB configurations with defects and S-duality	77
5.2.1	Vortex defects in the presence of orbifold 5-planes	78

5.2.2	Wilson defects in the presence of orbifold 5-planes	80
6	Beyond Hanany-Witten : A flavored \widehat{D}_4 quiver	82
6.1	Vortex Defects in the \widehat{D}_4 quiver	83
6.2	Wilson Defects in the \widehat{D}_4 quiver	83
A	Line defects in a $U(2)$ gauge theory with $N_f = 4$ flavors	86
A.1	Mirror symmetry and partition functions	86
A.2	The vortex defects $V_{M,R}$ and the dual defects	87
A.3	The Wilson defect W_R and the dual defects	91
B	Abelian Gauging: Defects in the D_4 quiver gauge theory	93
B.1	Vortex defects	93
B.2	Wilson defects	95
C	Non-Abelian Gauging : Defects in the D_6 quiver	97
C.1	Non-Abelian Gauging via abelianization of the partition function	98
C.2	Non-Abelian Gauging without using abelianization	101

1 Introduction and summary of results

1.1 Background and the basic idea of the paper

The existence of UV/IR dualities is a ubiquitous feature of Quantum Field Theories in various space-time dimensions. Existence of such a duality implies that a set of theories, having distinctly different descriptions (for example, theories with different Lagrangians) at a given energy scale, describe the same physics at another energy scale. The discovery and analysis of these UV/IR dualities, particularly for QFTs with supersymmetry, have relied heavily on String Theory constructions involving branes [2]. In the recent past, localization techniques (see [3] for a recent review) have provided an avenue for working out extremely non-trivial checks for dualities in QFTs with sufficient supersymmetry. Given this recent progress on the QFT side, a natural question to ask is : can one use the tools of localization to construct a systematic field theory prescription for generating new dualities, starting from a well-defined set of basic dualities?

In the context of a class of IR dualities in three dimensions, such a construction was presented in [1], which we will briefly summarize. Consider a class of 3d CFTs with a weakly coupled description that has a manifest global symmetry subgroup $G_{\text{global}}^{\text{sub}} = \prod_{\gamma} U(M_{\gamma})$. We will refer to this class of 3d CFTs as class \mathcal{U} . Given a UV theory X in class \mathcal{U} , one can define a map (see Section 3 for notation and details) which acts on X to give a generically new theory X' , i.e.

$$\mathcal{O}_{\mathcal{P}}^{\alpha} : X[\widehat{\mathbf{A}}] \mapsto X'[\widehat{\mathbf{B}}], \quad (1.1)$$

where $\widehat{\mathbf{A}}$ and $\widehat{\mathbf{B}}$ denote various background fields associated with global symmetries of the theories X and X' respectively¹. In the trivial case, where $G_{\text{global}}^{\text{sub}} = U(1)$, and $\mathcal{O}_{\mathcal{P}}^{\alpha}$ is a gauging operation of the said $U(1)$, the above map coincides with the S generator of Witten’s $SL(2, \mathbb{Z})$ action [4] on a 3d CFT. In analogy, we refer to the above map as an “elementary S -type operation”.

Suppose the theory $X[\widehat{\mathbf{A}}]$ is IR dual to the theory $Y[\widehat{\mathbf{A}}]$, where both theories have a weakly coupled description. Given an elementary S -type operation $\mathcal{O}_{\mathcal{P}}^{\alpha}$ on $X[\widehat{\mathbf{A}}]$, one can define a dual operation $\widetilde{\mathcal{O}}_{\mathcal{P}}^{\alpha}$ on $Y[\widehat{\mathbf{A}}]$, i.e.

$$\widetilde{\mathcal{O}}_{\mathcal{P}}^{\alpha} : Y[\widehat{\mathbf{A}}] \mapsto Y'[\widehat{\mathbf{B}}], \quad (1.2)$$

such that the pair of theories $(X'[\widehat{\mathbf{B}}], Y'[\widehat{\mathbf{B}}])$ are again IR dual. The four theories $X[\widehat{\mathbf{A}}]$, $Y[\widehat{\mathbf{A}}]$, $X'[\widehat{\mathbf{B}}]$, and $Y'[\widehat{\mathbf{B}}]$, are therefore related as shown in the following figure.

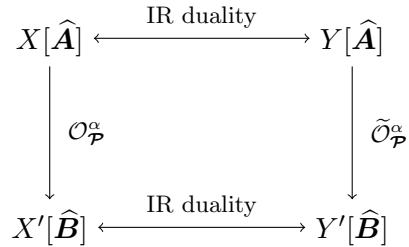

Figure 1: Generating new dual pairs using an elementary S -type operation.

The final step in the construction is to determine the dual operation $\widetilde{\mathcal{O}}_{\mathcal{P}}^{\alpha}$, given the pair $(X[\widehat{\mathbf{A}}], Y[\widehat{\mathbf{A}}])$ and the map $\mathcal{O}_{\mathcal{P}}^{\alpha}$, which should also allow one to read off the weakly coupled description of the theory $Y'[\widehat{\mathbf{B}}]$, if it exists. In this paper, we will focus on 3d $\mathcal{N} = 4$ theories, and a specific IR duality – the three dimensional mirror symmetry [5, 6]. For such theories and the particular IR duality in question, one can solve the problem of determining the dual operation $\widetilde{\mathcal{O}}_{\mathcal{P}}^{\alpha}$ explicitly, making use of RG-invariant observables computed using localization. The procedure, introduced in [1], is reviewed in Section 3.

Given a recipe for finding the dual of the S -type operation, there exists a straightforward strategy for generating new dualities. For a given class of IR dualities, one can define a convenient subset of dual theories, which are well understood from the String Theory and/or the QFT perspective, and refer to it as the set of “basic dualities” for the given IR duality. Starting with a pair (X, Y) in this set of basic dualities, one can then implement the prescription of Fig. 1 sequentially to generate new dual pairs. For the specific case of 3d mirror symmetry, we pick the set of basic dualities to be the set of linear quiver (A-type) gauge theories with unitary gauge groups, obeying the additional constraint that they should be good theories in the Gaiotto-Witten sense [7]. Mirror symmetry for this class of theories is well understood from a Type IIB brane construction [2] as well as QFT

¹In the most general case, an S -operation can also turn on defects in the theory, but we will ignore this for the time being to keep the discussion simple. More details on this can be found in Section 3 and later in the paper.

considerations. Using the construction outlined above, one can then try to construct mirror pairs involving quivers of arbitrary shapes. Several infinite families of non-ADE type quiver gauge theories and their Lagrangian mirror duals were constructed in this fashion [1].

In the present paper, we will extend the construction, summarized above in Fig. 1, to incorporate half-BPS vortex and Wilson defects in 3d $\mathcal{N} = 4$ theories. Consider a pair of dual theories decorated by line defects – $X[\mathcal{D}, \widehat{\mathbf{A}}]$ and $Y[\mathcal{D}^\vee, \widehat{\mathbf{A}}]$, where \mathcal{D} and \mathcal{D}^\vee are line defects of different types (vortex and Wilson respectively or vice-versa) that are mapped to each other under mirror symmetry. We additionally require that (X, Y) are good Lagrangian theories, with X being in class \mathcal{U} . Given a theory $X[\mathcal{D}, \widehat{\mathbf{A}}]$, an elementary S -type operation acts on X to give a generically new theory X' decorated by a defect \mathcal{D}' , i.e.

$$\mathcal{O}_{\mathcal{P}}^\alpha : X[\mathcal{D}, \widehat{\mathbf{A}}] \mapsto X'[\mathcal{D}', \widehat{\mathbf{B}}], \quad (1.3)$$

where \mathcal{D} and \mathcal{D}' are line defects of the same type (Wilson or vortex). As before, given the dual pair and the S -operation, one can define a dual operation, i.e.

$$\widetilde{\mathcal{O}}_{\mathcal{P}}^\alpha : Y[\mathcal{D}^\vee, \widehat{\mathbf{A}}] \mapsto Y'[\mathcal{D}'^\vee, \widehat{\mathbf{B}}], \quad (1.4)$$

such that the theories $X'[\mathcal{D}', \widehat{\mathbf{B}}], Y'[\mathcal{D}'^\vee, \widehat{\mathbf{B}}]$ are IR dual. This implies that the half-BPS defect \mathcal{D}' is mapped to the half-BPS defect \mathcal{D}'^\vee under mirror symmetry, and this relation between the two is referred to as the “mirror map” of the line defects in question. Schematically, the construction can be summarized in Fig. 2. The final step, as before, is

$$\begin{array}{ccc} X[\mathcal{D}, \widehat{\mathbf{A}}] & \xleftrightarrow{\text{IR duality}} & Y[\mathcal{D}^\vee, \widehat{\mathbf{A}}] \\ \downarrow \mathcal{O}_{\mathcal{P}}^\alpha & & \downarrow \widetilde{\mathcal{O}}_{\mathcal{P}}^\alpha \\ X'[\mathcal{D}', \widehat{\mathbf{B}}] & \xleftrightarrow{\text{IR duality}} & Y'[\mathcal{D}'^\vee, \widehat{\mathbf{B}}] \end{array}$$

Figure 2: Generating new dual pairs with defects using an elementary S -type operation.

to determine the dual operation $\widetilde{\mathcal{O}}_{\mathcal{P}}^\alpha$ given the pair $(X[\mathcal{D}, \widehat{\mathbf{A}}], Y[\mathcal{D}^\vee, \widehat{\mathbf{A}}])$ and the map $\mathcal{O}_{\mathcal{P}}^\alpha$, which should allow one to read off the weakly coupled description of the theory Y' (if it exists) as well as the defect \mathcal{D}'^\vee . Note that a recipe for finding the dual operation therefore automatically leads to the mirror map for the line defects \mathcal{D}' and \mathcal{D}'^\vee . One of the main results of this paper is to present a general recipe for finding the dual operation, using RG-invariant observables computed via localization. Given this recipe, one can again deploy the strategy outlined above to generate new dual pairs of quiver gauge theories of arbitrary shapes decorated by line defects, starting from a pair of A -type quivers with defects. After working out the details of this general construction, we use it to study the mirror maps of line defects in flavored D -type and affine D -type quiver gauge theories with unitary gauge groups. We also discuss how some of these line defects and the associated mirror maps

can be realized in a Type IIB construction of the Hanany-Witten type, although the main focus of the paper is to work out these mirror maps without any reference to the String Theory constructions. We also study an example of mirror symmetry which does not have a known Type IIB realization. In a companion paper [8], we will apply our construction to study mirror maps of line defects in theories involving non- ADE quiver gauge theories.

We would like to emphasize that finding the mirror map of line defects is in general a difficult problem for non-Abelian gauge theories. For A -type linear quivers with unitary gauge groups, the problem was solved relatively recently using a Type IIB brane construction [9], while line defects in D -type and E -type theories have not been addressed in this fashion in the literature, as far as we know. Our construction gives a systematic field theoretic procedure to generate line defects and the associated mirror maps in these quiver gauge theories and beyond, starting from the well understood dual linear quivers with defects.

1.2 Outline and Summary

The outline of the paper is as follows. In Section 2, we present a brief review of Wilson and vortex defects in 3d $\mathcal{N} = 4$ theories, and set up the notations for the rest of the paper. We review the Type IIB realization of these defects in an A -type quiver gauge theory, and the map of such defects under mirror symmetry. In addition, we discuss the localization computation for the expectation values of these defects on a round three-sphere, which will be our principal tool.

In Section 3, we concretely realize the construction, summarized in Fig. 2, in terms of the partition function on a round three-sphere. In particular, we discuss how to construct vortex defects as 3d-1d coupled quivers in a non- A -type 3d quiver gauge theory and their mirror maps. Analogous construction for the Wilson defects is also discussed. In Section 3.1, we review the S -type operations and their realization in terms of the S^3 partition function. Generically, a non-Abelian S -type operation (i.e. one that involves gauging a non-Abelian flavor symmetry) has a substantially more involved than the Abelian ones. However, at the level of the S^3 partition function, a non-Abelian S -type operation can be reduced to a set of Abelian S -type operations with certain Wilson defects. This “abelianization” procedure², which is an important tool for constructing generic quiver gauge theories, is discussed in Section 3.2. In Section 3.3, we discuss the action of S -type operations on 3d quivers with defects, and therefore realize the map (1.3) explicitly. The recipe for reading off the dual of the S -type operations for both cases is discussed in Section 3.4. Finally, we end the section with a simple example illustrating the general construction of Fig. 2, as given in the sections 3.3 - 3.4.

In Section 4, we apply the machinery of Section 3 to engineer line defects in D -type/affine D -type quivers and find their duals, starting from a dual pair of linear quivers

²This procedure should be understood simply as a convenient way of writing the matrix model, and not as a QFT operation.

with defects. In particular, gauge vortex defects in D -type theories are realized as 3d-1d coupled quivers. Under mirror symmetry, these are shown to map to gauge/flavor Wilson defects, which we explicitly determine. Analogous construction for Wilson defects in D -type theories are also presented. The vortex defects dual to Wilson defects in D -type theories are realized by 3d-1d coupled systems involving symplectic and/or unitary 3d gauge groups. A given vortex defect can be realized as multiple 3d-1d coupled quivers – a feature that was called “hopping duality” in [9]. We discuss the pattern of hopping dualities for vortex defects in the D -type and the affine D -type quiver gauge theories we study, as well as their mirror duals.

In Section 4.1, we begin by discussing an example of a D_4 quiver gauge theory dual to an $SU(2)$ gauge theory with four flavors. In Section 4.2, we extend our analysis to a D_{N_f} quiver dual to an $Sp(N_c)$ theory with N_f flavors. The former pair can be constructed by an Abelian S -type operation, while the latter pair requires a non-Abelian operation. In Section 4.3 and Section 4.4, we extend our discussion to more general D -type quivers and to affine D -type quivers respectively, using more involved S -type operations. In Section 4.5, we extend our discussion to more general defects in a D -type quiver. The computation of the defect partition function is straightforward (although tedious in some cases) once the general expressions of 3.3 - 3.4 are given. In Appendix B, we present a sample case to familiarize the reader with the details of the computation for Abelian S -type operations. In Appendix C, we work out the details of the non-Abelian operation relevant for the example in Section 4.2.

In Section 5, we take a short detour to discuss how an important class of line defects in the D -type quivers and the associated mirror maps may be realized by a Type IIB brane construction. A vortex (Wilson) defect in a D -type quiver is realized by a D3-D5-NS5-D1(F1) system in the presence of an orbifold 5-plane. The dual Wilson (vortex) defect is realized by a D3-D5-NS5-F1(D1) system in the presence of an $O5^0$ -plane, which is D5-brane coincident with an $O5^-$ -plane. The S-duality that relates the two configurations is explicitly discussed. We observe that the Type IIB answer in this case matches the QFT answer precisely. A detailed study of the Type IIB brane construction for more general line defects in D -type quiver gauge theories will be the subject of a future paper.

Finally, in Section 6, we discuss defects in an affine D_4 quiver, for which the mirror dual is not directly realized by a Type IIB construction. The naive mirror dual, read off from S-dualizing the original brane configuration, gives a theory which is “bad” in the Gaiotto-Witten sense [7]. This implies, among other things, that the S^3 partition function of the mirror theory diverges. The procedure of Fig. 1, however, allows one to construct a good mirror dual for the \widehat{D}_4 theory. In addition, it turns out that, for the aforementioned affine D_4 quiver decorated with a line defect, the procedure of Fig. 2 allows one to construct the mirror map of such a line defect. These mirror maps can be worked out explicitly following the construction of sections 3.3 - 3.4.

2 Wilson loop and Vortex loop operators in three dimensions

In this section, we review a few basic concepts and tools associated with half-BPS Wilson and vortex defects in 3d $\mathcal{N} = 4$ quiver gauge theories, from a field theory perspective as well as using a Type IIB String Theory construction. Readers familiar with these basic materials can skip this section.

2.1 Generalities of 3d $\mathcal{N} = 4$ QFTs and half-BPS defects

2.1.1 Quiver notation for 3d $\mathcal{N} = 4$ QFTs

The 3d $\mathcal{N} = 4$ QFTs have dimensionful coupling constants - such theories are asymptotically free in the UV and flow to a 3d $\mathcal{N} = 4$ SCFT in the IR. The theories relevant to this paper are quiver gauge theories, the Lagrangian description for which involves a vector multiplet corresponding to a gauge group G , and hypermultiplets in a quaternionic representation of the gauge group G . The UV theory has an $SU(2)_H \times SU(2)_C$ R-symmetry, where the subscripts indicate that they act as isometries on the Higgs and the Coulomb branch of the moduli space respectively. Both branches are hyperkähler cones and the corresponding $SU(2)$ R-symmetry rotates the three complex structure as a triplet. In addition, the theory has a global symmetry $G_H \times G_C$, which commutes with the R-symmetry and the Poincare supercharges. These are realized as tri-holomorphic isometries on the Higgs and Coulomb branches of the moduli space respectively.

The 3d $\mathcal{N} = 4$ gauge theories have two possible types of deformations which preserve the full $\mathcal{N} = 4$ supersymmetry – hypermultiplet masses and FI parameters. The masses transform as triplets of $SU(2)_C$ and constitute the scalar components of a background vector multiplet in the Cartan subalgebra \mathfrak{g}_H . Generically, these parameters lift the Higgs branch and deform the Coulomb branch. The FI parameters transform as triplets of $SU(2)_H$ and constitute the scalar components of a background twisted vector multiplet in the Cartan subalgebra \mathfrak{g}_C . Generically, they will lift the Coulomb branch and deform the Higgs branch.

Finally, the quiver notation of a gauge theory that we will use in this paper is summarized in the following figure.

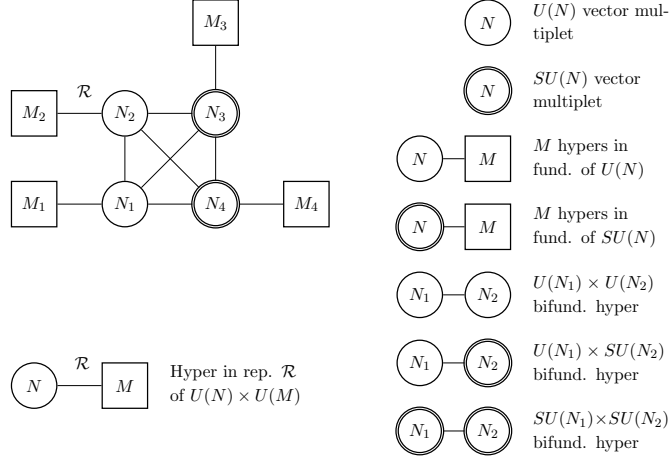

The quiver diagram on the LHS represents the field content of a 3d $\mathcal{N} = 4$ theory with gauge group $G = U(N_1) \times U(N_2) \times SU(N_3) \times SU(N_4)$, and hypermultiplets in various representations. The conventions for the reading off the representations in which the hypermultiplets transform are listed on the RHS. In a quiver diagram, we will refer to the circles as gauge nodes and the boxes as flavor nodes. For more general gauge groups, we will use the notation:

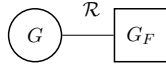

where \mathcal{R} is a representation of $G \times G_F$. For example, an $Sp(N)$ gauge theory with N_f fundamental hypermultiplets (i.e. $2N_f$ half-hypers) will be represented by the above quiver diagram with $G = Sp(N)$, $G_F = SO(2N_f)$, and \mathcal{R} being the bifundamental representation of $Sp(N) \times SO(2N_f)$. The line connecting the gauge and the flavor node denotes a half-hypermultiplet in this case.

2.1.2 Supersymmetry algebra and protected sectors

The 3d $\mathcal{N} = 4$ supersymmetry algebra has a pair of inequivalent protected 1d subalgebras. Following the presentation of [10], we discuss these subalgebras on \mathbb{R}^3 .

The 3d $\mathcal{N} = 4$ Poincare supercharges $Q_\alpha^{aa'}$ are doublets of $Spin(3) \cong SU(2)_E$ (indexed by $\alpha = 1, 2$) and transform as $(2, 2)$ under the R-symmetry group, $SU(2)_H \times SU(2)_C$ (indexed by $a = 1, 2$ and $a' = 1, 2$ respectively). The complex supercharges on \mathbb{R}^3 generate the following supersymmetry algebra:

$$\{Q_\alpha^{aa'}, Q_\beta^{bb'}\} = P_\mu \sigma_{\alpha\beta}^\mu \epsilon^{ab} \epsilon^{a'b'} - i\epsilon_{\alpha\beta} (\epsilon^{ab} m^{(a'b')} + \epsilon^{a'b'} t^{(ab)}), \quad (2.1)$$

where $(\sigma^\mu)_\beta^\alpha$ are the standard Pauli matrices, with $\mu = 1, 2, 3$. All $SU(2)$ indices are raised and lowered by the corresponding ϵ -tensor, with the convention $\epsilon^{12} = \epsilon_{21} = 1$. The second term denotes a central extension of the algebra which are realized as the two sets of $\mathcal{N} = 4$ supersymmetry preserving deformations in the Lagrangian – the triplet of masses and FI

parameters, i.e.

$$m^{(a'b')} = \begin{pmatrix} 2m_{\mathbb{C}} & -m_{\mathbb{R}} \\ -m_{\mathbb{R}} & -2\bar{m}_{\mathbb{C}} \end{pmatrix}, \quad t^{(ab)} = \begin{pmatrix} 2t_{\mathbb{C}} & -t_{\mathbb{R}} \\ -t_{\mathbb{R}} & -2\bar{t}_{\mathbb{C}} \end{pmatrix}. \quad (2.2)$$

We will split the Euclidean space-time $\mathbb{R}^3 \cong \mathbb{C}_z \times \mathbb{R}_t$, and the SUSY algebra can then be rewritten as

$$\begin{aligned} \{Q_1^{aa'}, Q_1^{bb'}\} &= -2\epsilon^{ab}\epsilon^{a'b'}P_{\bar{z}}, & \{Q_2^{aa'}, Q_2^{bb'}\} &= 2\epsilon^{ab}\epsilon^{a'b'}P_{\bar{z}}, \\ \{Q_1^{aa'}, Q_2^{bb'}\} &= \{Q_2^{bb'}, Q_1^{aa'}\} = \epsilon^{ab}\epsilon^{a'b'}P_t - i(\epsilon^{ab}m^{(a'b')} + \epsilon^{a'b'}t^{(ab)}). \end{aligned} \quad (2.3)$$

In this set-up, we will study half-BPS line operators inserted at $z = \bar{z} = 0$, preserving a 1d $\mathcal{N} = 4$ subalgebra (i.e. supercharges of the subalgebra anti-commute to translation along \mathbb{R}_t) of the full 3d $\mathcal{N} = 4$ algebra. There are two inequivalent choices of these subalgebras, which will be referred to as SQM_A and SQM_B . The associated line operators will be referred to as Type-*A* and Type-*B* line operators respectively.

The subalgebra SQM_A is defined as a 1d subalgebra which breaks the R-symmetry to $SU(2)_C \times U(1)_H$. There exists a \mathbb{CP}^1 worth of such subalgebras corresponding to the choices of an unbroken $U(1)_H$ inside $SU(2)_H$, which in turn is related to choices of a complex structure on the Higgs branch. Following [10], we adopt the following choice for the SQM_A subalgebra:

$$Q_A^{a'} = \delta_a^\alpha Q_\alpha^{aa'}, \quad \tilde{Q}_A^{a'} = (\sigma^3)_a^\alpha Q_\alpha^{aa'}, \quad (2.4)$$

where the non-vanishing anti-commutation relations are given as

$$\{Q_A^{a'}, \tilde{Q}_A^{b'}\} = 2\epsilon^{a'b'}(P_t - it_{\mathbb{R}}), \quad \{Q_A^{a'}, Q_A^{b'}\} = \{\tilde{Q}_A^{a'}, \tilde{Q}_A^{b'}\} = 2im^{(a'b')}. \quad (2.5)$$

The subalgebra SQM_B is defined as a 1d subalgebra which breaks the R-symmetry to $SU(2)_H \times U(1)_C$. Again, there exists a \mathbb{CP}^1 worth of such subalgebras corresponding to the choices of an unbroken $U(1)_C$ inside $SU(2)_C$, which in turn is related to choices of a complex structure on the Coulomb branch. We adopt the following choice for the SQM_B subalgebra:

$$Q_B^a = \delta_{a'}^\alpha Q_\alpha^{aa'}, \quad \tilde{Q}_B^a = (\sigma^3)_{a'}^\alpha Q_\alpha^{aa'}, \quad (2.6)$$

with the non-vanishing anti-commutation relations

$$\{Q_B^a, \tilde{Q}_B^b\} = 2\epsilon^{ab}(P_t - it_{\mathbb{R}}), \quad \{Q_A^a, Q_A^b\} = \{\tilde{Q}_A^a, \tilde{Q}_A^b\} = 2im^{(ab)}. \quad (2.7)$$

Finally, each subalgebra contains a topological supercharge:

$$Q_A = Q_A^1, \quad Q_B = Q_B^1, \quad (2.8)$$

where Q_A can be identified as the 3d reduction of the supercharge associated with Donaldson-Witten twisted 4d $\mathcal{N} = 2$ theories, and Q_B is associated with the Rozansky-Witten twist of 3d $\mathcal{N} = 4$ sigma models.

2.1.3 Wilson defect on \mathbb{R}^3

A Wilson defect is a half-BPS Type- B operator which can be defined on \mathbb{R}^3 as follows. The bosonic part of a 3d $\mathcal{N} = 4$ vector multiplet contains a gauge field A_μ and an $SU(2)_C$ triplet of real scalars in the adjoint representation of the gauge group G . Given a choice of complex structure on the Coulomb branch, the latter can be written as :

$$\phi^{(a'b')} = \begin{pmatrix} 2\phi & \sigma \\ \sigma & -2\bar{\phi} \end{pmatrix}, \quad (2.9)$$

where the real scalar $\sigma \in \mathfrak{g}$ and the complex scalar $\phi \in \mathfrak{g}_{\mathbb{C}}$. The following combination of the gauge field and the real scalar σ :

$$\mathcal{A}_t := A_t - i\sigma \quad (2.10)$$

is preserved by the 1d subalgebra SQM_B . A Wilson line in a finite-dimensional unitary representation R of the gauge group G can then be given as

$$W_R = \text{Hol}\left(\rho_R(\mathcal{A}_t)\right) = P\left(\exp \int_{\mathbb{R}_t} \rho_R(\mathcal{A}_t) dt\right), \quad (2.11)$$

where ρ_R is the map $\rho_R : \mathfrak{g}_{\mathbb{C}} \rightarrow \mathfrak{gl}(\dim R)$. As pointed out in [10], one can take the trace of the holonomy operator to give a gauge-invariant operator, if the non-compact line were replaced by a loop. For a non-compact line, gauge invariance requires appropriate boundary conditions at $t \rightarrow \pm\infty$. This, however, does not affect the local structure of these line operators studied in [10] or in this work.

2.1.4 Vortex defect on \mathbb{R}^3

A vortex defect is a half-BPS operator Type- A operator which can be defined on \mathbb{R}^3 using any one of the two following equivalent constructions, i.e.

1. Disorder operator
2. Coupled 3d-1d quiver.

We review the two approaches briefly below, focusing mainly on the second approach, which will concern us for the rest of this work.

Disorder operator: Consider a 3d $\mathcal{N} = 4$ theory with a gauge group G and N hypermultiplets, where the complex hypermultiplet scalars are labelled as (X_i, Y_i) with $i = 1, \dots, N$. The N complex scalars (X_i, Y_i) arrange themselves in a representation $\mathcal{R} \oplus \mathcal{R}^*$ of $G \times G_H$. Insertion of a vortex defect in the theory amounts to performing the path integral in a background of certain singular solutions of the BPS equations³. The solutions, in question,

³The generalized vortex equations in the \mathbb{C}_z -plane, i.e.

$$F_{z\bar{z}} = \mu_{\mathbb{R}} + t_{\mathbb{R}}, \quad D_{\bar{z}}X = D_{\bar{z}}Y = 0, \quad \mu_{\mathbb{C}} = -t_{\mathbb{C}}, \quad (2.12)$$

are obtained as a subset of the BPS equations for the subalgebra SQM_A . We refer the reader to Section 4 and Appendix A of the paper [10] (and the references therein) for the complete set of BPS equations.

are characterized by a singular profile of the hypermultiplet scalars (X, Y) at $z = 0$ on the \mathbb{C}_z -plane, as well as a compatible gauge symmetry breaking at $z = 0$. A given disorder operator can be labelled by certain holomorphic/algebraic data – we refer the reader to [10] for details.

Coupled 3d-1d system: Alternatively, a vortex defect can be inserted by coupling the 3d theory to an appropriate 1d $\mathcal{N} = (2, 2)$ quiver gauge theory [9]. Such theories can be obtained by the dimensional reduction of a 2d $\mathcal{N} = (2, 2)$ SQM. An $\mathcal{N} = (2, 2)$ SQM associated with vortex defects in 3d $\mathcal{N} = 4$ theories has the generic form:

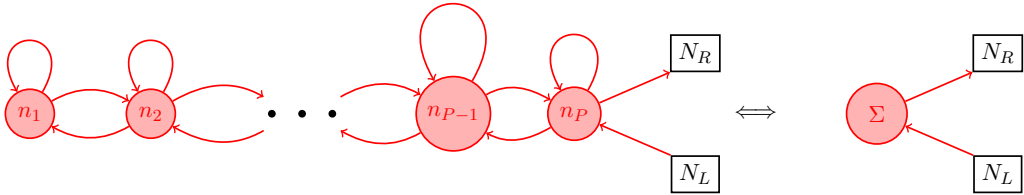

Figure 3: The general form of $(2,2)$ SQM which realizes a vortex defect in a 3d $\mathcal{N} = 4$ theory.

The circular nodes in the 1d quiver (on the left) represent $(2, 2)$ vector multiplets for unitary gauge groups, so that the full gauge group is $\prod_{i=1}^P U(n_i)$. The directed arrows connecting two circular nodes denote bifundamental chiral multiplets, with the incoming arrow denoting a fundamental chiral for the corresponding gauge node. The directed arrows beginning and ending on the same gauge node represent adjoint chiral multiplets for the corresponding gauge node. Finally, the rectangular nodes denote fundamental chiral/anti-chiral multiplets, with the incoming arrow (w.r.t. the circular node) denoting fundamental chirals, and the outgoing arrow denoting anti-chirals. On the right, we have a shorthand notation for presenting a generic quiver of this class.

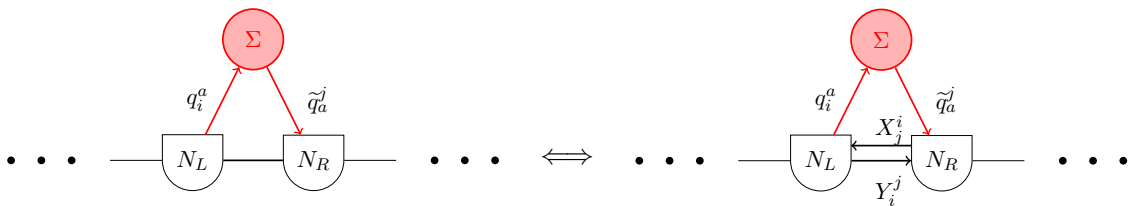

Figure 4: The general form of a 3d-1d quiver that realizes a vortex defect in a 3d $\mathcal{N} = 4$ quiver gauge theory.

A generic 3d-1d quiver which realizes a vortex defect in 3d has the form given in Fig. 4. The 1d flavor symmetries (or their subgroups) which are gauged by 3d vector multiplets are represented by the nodes \cup . In the above quiver, the $(2, 2)$ SQM is coupled to the 3d theory by gauging the $(U(N_L) \times U(N_R))/U(1)$ flavor symmetry with 3d vector multiplets.

In general, one can also gauge a subgroup of the flavor symmetry with background 3d vector multiplets, such that the a 1d flavor symmetry subgroup is identified with a 3d flavor symmetry group. In the quiver on the RHS, we have decomposed the 3d $\mathcal{N} = 4$ bifundamental hypermultiplet into a pair of $\mathcal{N} = 2$ chiral multiplets – X and Y , which transform in the bifundamental representation of $U(N_L) \times U(N_R)$ and $U(N_R) \times U(N_L)$ respectively⁴. The 3d-1d coupling introduces the following cubic superpotential in the theory:

$$\widetilde{W}_0 = q_i^a X_j^i \widetilde{q}_a^j + \dots, \quad (2.13)$$

where the \dots in the superpotential denote additional terms which contain higher derivatives of the complex scalar X . The indices run over $a = 1, \dots, n_P$, $i = 1, \dots, N_L$, $j = 1, \dots, N_R$.

A vortex defect in a 3d $\mathcal{N} = 4$ quiver gauge theory is specified by the following two pieces of data:

1. A 3d-1d quiver of the form discussed above, including the cubic superpotential.
2. Signs of the FI parameters $\boldsymbol{\xi}$ for the gauge nodes of the SQM.

A given vortex defect can be realized by multiple coupled 3d-1d systems. This was called the “hopping duality” in the context of 3d linear quivers in [9], where a vortex defect generically can be realized by at least a pair of coupled 3d-1d systems.

2.1.5 Mirror symmetry

Mirror symmetry is a special case of an IR duality in three dimensions for theories with eight supercharges, with the following properties:

- Given a pair of dual theories X and Y , mirror symmetry exchanges the Coulomb and the Higgs branches in the deep IR, i.e. as $g_{YM}^2 \rightarrow \infty$:

$$\mathcal{M}_C^{(X)} = \mathcal{M}_H^{(Y)}, \quad \mathcal{M}_H^{(X)} = \mathcal{M}_C^{(Y)}. \quad (2.14)$$

- The duality exchanges $SU(2)_C$ and $SU(2)_H$, and therefore maps hypermultiplet masses on one side of the duality to FI parameters on the other.

Mirror symmetry relates observables in theory X with observables in theory Y , and the precise map is referred to as the “mirror map”. In particular, it exchanges the subalgebra SQM_A with the subalgebra SQM_B , as well as the associated topological charges Q_A and Q_B . This implies that the half-BPS vortex defects, which are observables preserved by SQM_A on one side of the duality, are mapped to the half-BPS Wilson defects, preserved by SQM_B , on the other. The vortex defect can be additionally embellished by Wilson defects for the 3d topological symmetries, which are also preserved by SQM_A . In the next section, we will review a Type IIB construction for realizing these mirror maps in the class of linear quivers with unitary gauge groups. This will be the starting point for constructing mirror maps of line defects in more general quiver gauge theories, as we discuss in Section 3.

⁴In general, one can have a hypermultiplet in a representation \mathcal{R} of $U(N_L) \times U(N_R)$, and the complex scalars X and Y will transform accordingly.

2.2 Brane construction for line defects in linear quivers

In this section, we present a brief review of the Type IIB construction of the vortex and the Wilson line defects in linear quivers with unitary gauge groups, and the map of such defects under mirror symmetry. A generic linear quiver gauge theory with L gauge nodes is shown in Fig. 5, while its mirror dual (which is also a linear quiver gauge theory) is shown in Fig. 6. We first discuss the Type IIB construction of linear quivers without defects in Section 2.2.1, followed by incorporation of line defects in Section 2.2.2, and discussion of the mirror map of line defects in Section 2.2.3.

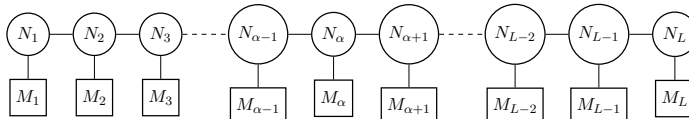

Figure 5: A generic linear quiver with L gauge nodes.

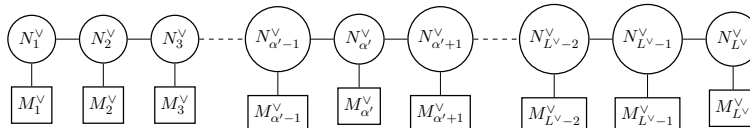

Figure 6: The linear quiver which is mirror dual to the generic linear quiver in Fig. 5. The total number of gauge nodes is L^{\vee} .

2.2.1 Brane construction for linear quivers without defects

The linear quivers have a very simple realization in terms of a Type IIB brane construction of the Hanany-Witten type [2]. For a modern review and generalization of the construction, we refer the reader to [7, 11]. A large class of 3d $\mathcal{N} = 4$ Lagrangian theories can be obtained by considering D3 branes extending along a line segment L , with 1/2-BPS boundary conditions at the two ends [7]. The simplest of these boundary conditions correspond to D3-branes ending on NS5- branes and/or D5-branes, and these are the only ingredients one needs for constructing a linear quiver.

	0	1	2	3	4	5	6	7	8	9
NS5	x	x	x	·	·	·	·	x	x	x
D5	x	x	x	·	x	x	x	·	·	·
D3	x	x	x	x	·	·	·	·	·	·

Table 1: Basic Type IIB brane construction.

The respective world-volumes of D3, D5 and NS5-branes are specified in Table 1. A more precise way of writing this data is as follows:

$$\begin{aligned}
\text{D3: } & \mathbb{R}^{2,1} \times L \times \{\mathbf{X}\}_{4,5,6} \times \{\mathbf{Y}\}_{7,8,9} \\
\text{D5: } & \mathbb{R}^{2,1} \times \{X_3\} \times \mathbb{R}_{4,5,6}^3 \times \{\mathbf{Y}'\}_{7,8,9} \\
\text{NS5: } & \mathbb{R}^{2,1} \times \{X'_3\} \times \{\mathbf{X}'\}_{4,5,6} \times \mathbb{R}_{7,8,9}^3,
\end{aligned} \tag{2.15}$$

where $\{X_3\}, \{\mathbf{X}\}, \{\mathbf{Y}\}$ (and $\{X'_3\}, \{\mathbf{X}'\}, \{\mathbf{Y}'\}$) are points in $L, \mathbb{R}_{4,5,6}^3, \mathbb{R}_{7,8,9}^3$ respectively. To a given configuration of D3-NS5-D5-branes, one can associate a set of linking numbers of the 5-branes ($l_\gamma^{\text{NS5}}, l_\beta^{\text{D5}}$) which are defined as follows:

$$l_\gamma^{\text{NS5}} = n_{\text{left}}(\text{D5}) - \tilde{n}_{\text{left}}(\text{D3}) + \tilde{n}_{\text{right}}(\text{D3}), \quad \gamma = 1, \dots, L+1, \tag{2.16}$$

$$l_\beta^{\text{D5}} = n_{\text{left}}(\text{NS5}) - \tilde{n}_{\text{left}}(\text{D3}) + \tilde{n}_{\text{right}}(\text{D3}), \quad \beta = 1, \dots, L^\vee + 1, \tag{2.17}$$

where $L^\vee = \sum_{\gamma=1}^L M_\gamma - 1$, $n_{\text{left},\text{right}}(\text{D5/NS5})$ denotes the number of D5/NS5-branes to the left or right of the 5-brane in question, while $\tilde{n}_{\text{left},\text{right}}(\text{D3})$ denotes the number of D3 branes ending on the 5-brane from the left and the right respectively. One can move the D5 and the NS5-branes past each other such that the linking numbers remain the same in the initial and the final configuration. Such moves, known as Hanany-Witten moves, create/annihilate D3-branes stretched between pairs of NS5-D5 branes. We will also refer to a given configuration of D3-NS5-D5-branes, among all the possible configurations for a given set of linking numbers, as a *Hanany-Witten frame*.

From the perspective of the 3d world volume, the gauge theory data can be read off from the Hanany-Witten frame where all D3-branes end on NS5-branes, using the following rules:

- The γ -th NS5 chamber containing N_γ D3 branes gives a $U(N_\gamma)$ vector multiplet. This arises from the massless modes of the D3-D3 open strings which survive the NS5 boundary conditions.
- The γ -th NS5 chamber, containing M_γ D5 branes, gives M_γ hypermultiplets in the fundamental representation of $U(N_\gamma)$. These arise from the massless modes of the D3-D5 open strings.
- There are hypermultiplets in the bifundamental of $U(N_\gamma) \times U(N_{\gamma+1})$, which arise from D3-D3 open strings running between the γ -th and the $\gamma+1$ -th NS5 chambers.

The $\mathcal{N} = 4$ supersymmetry preserving deformations are encoded in the brane construction as follows. The triplet of FI parameters are $\eta_\gamma^Y = t_\gamma^Y - t_{\gamma+1}^Y$, with $\gamma = 1, \dots, L$, where the parameter t_γ^Y corresponds to the relative position of the NS5 brane in $\mathbb{R}_{4,5,6}^3$ w.r.t. D3-branes in the chamber γ . The triplet of fundamental mass parameters m_β^Z , with $\beta = 1, \dots, \sum_{\gamma=1}^L M_\gamma$, correspond to the relative positions of the D5 branes in $\mathbb{R}_{7,8,9}^3$ w.r.t. the D3-brane in a given chamber. Given the translational symmetry on \mathbb{R}^3 , both sets of moduli should be counted up to an overall shift. The bifundamental masses correspond to

the relative position in $\mathbb{R}_{7,8,9}^3$ of the D3-branes in the γ -chamber w.r.t. the D3-branes in the $\gamma + 1$ -chamber. In the above Hanany-Witten frame, one can choose to put all D3-branes at the same point in $\mathbb{R}_{7,8,9}^3$, which sets all the bifundamental masses to zero and leaves the fundamental masses unconstrained up to an overall shift.

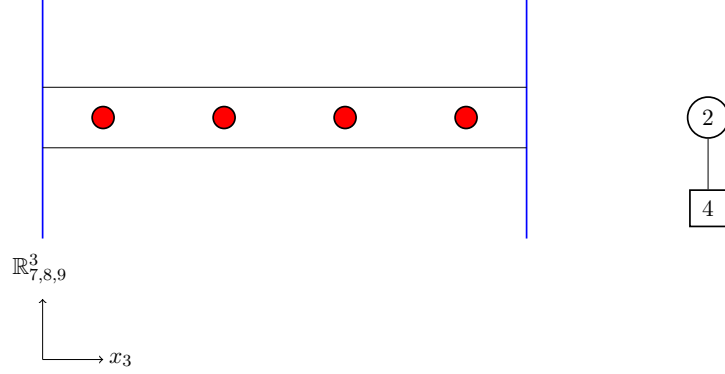

Figure 7: The figure on the left shows the Type IIB brane construction for the linear quiver on the right. The red nodes represent D5 branes, the horizontal black lines are D3 branes, and the vertical blue lines represent NS5 branes.

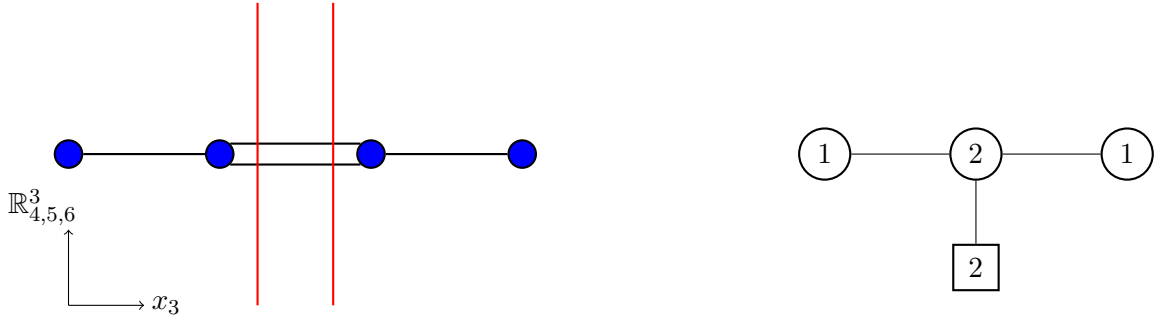

Figure 8: The figure on the left shows the Type IIB brane construction for the linear quiver on the right. The blue nodes represent NS5 branes, the horizontal black lines are D3 branes, and the vertical red lines represent D5 branes.

Fig. 7 gives an illustrative example of how one can read off the gauge theory content from the brane set up, using the rules listed above. Mirror symmetry in three dimensions can be understood as an S-duality of the above brane configuration, followed by a rotation $R : \mathbf{x}^{7,8,9} \rightarrow -\mathbf{x}^{4,5,6}, \mathbf{x}^{4,5,6} \rightarrow \mathbf{x}^{7,8,9}$. NS5 and D5 branes are exchanged under S-duality, while D3 branes are self-dual. To read off the dual gauge theory from the rotated S-dual brane system, one has to move to a Hanany-Witten frame where the all D3 branes end on NS5 branes. This can be done by performing a series of Hanany-Witten moves, where NS5 and D5 branes are moved past each other along the compact direction x^3 involving creation/annihilation of D3 branes. In the simple example of Fig. 7, the rotated S-duality transformation followed by appropriate Hanany-Witten moves lead to the brane

configuration in Fig. 8, from which the dual quiver gauge theory can again be read off, using the same rules as before. The mirror pair is shown in Fig. 9.

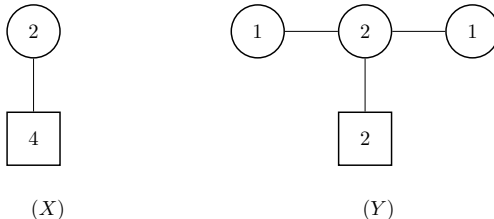

Figure 9: An example of a pair of linear quivers with unitary gauge groups which are 3d mirrors.

2.2.2 Line defects: Wilson and Vortex

In this section, we review the Type IIB construction of line defects in linear quivers – the Wilson and the vortex defects, which are defects of the Type-B and the Type-A respectively, as reviewed in Section 2. Our discussion largely follows [9], which is closely related to the discussion of Wilson defects in the 4d $\mathcal{N} = 4$ theory [12, 13].

Wilson defects

In addition to the standard D3-D5-NS5 system for a linear quiver, the insertion of Wilson defects in linear quivers requires additional D5-branes and F1-strings connecting these D5-branes with the D3-branes. These additional D5-branes can either have the same world-volume as the original D5-branes or be rotated in a specific fashion as discussed below. In the latter case, we will refer to them as D5'-branes, using the same notation as [9].

The respective world-volumes of the D3, D5, D5', NS5-branes, and the F1-strings are specified in Table 2. A more precise way of writing this data is as follows:

$$\begin{aligned}
 \text{D3: } & \mathbb{R}^{2,1} \times L \times \{\mathbf{X}\}_{4,5,6} \times \{\mathbf{Y}\}_{7,8,9} \\
 \text{D5: } & \mathbb{R}^{2,1} \times \{X_3\} \times \mathbb{R}_{4,5,6}^3 \times \{\mathbf{Y}'\}_{7,8,9} \\
 \text{D5': } & \mathbb{R}^{0,1} \times \{X_1\} \times \{X_2\} \times \{X'_3\} \times \mathbb{R}_{4,5,6}^3 \times \mathbb{R}_{7,8}^2 \times \{X_9\} \\
 \text{NS5: } & \mathbb{R}^{2,1} \times \{X'_3\} \times \{\mathbf{X}'\}_{4,5,6} \times \mathbb{R}_{7,8,9}^3 \\
 \text{F1: } & \mathbb{R}^{0,1} \times \{X'_1\} \times \{X'_2\} \times \{X''_3\} \times \{\mathbf{X}''\}_{4,5,6} \times \{X_7\} \times \{X_8\} \times \mathbb{R}_9,
 \end{aligned} \tag{2.18}$$

where we use the notation that $\{\cdot\}$ indicates a point in respective direction(s).

Let us briefly list the important features of the Type IIB construction that will be relevant for our work. Unless otherwise stated, we will always work with the canonical configuration where all D3-branes end on NS5-branes.

- In the γ -th NS5 chamber, the presence of a D5 or D5'-brane, away from the main stack of D5-branes in the x^9 -direction, introduces a gauge Wilson defect for the $U(N_\gamma)$

	0	1	2	3	4	5	6	7	8	9
NS5	x	x	x	·	·	·	·	x	x	x
D5	x	x	x	·	x	x	x	·	·	·
D3	x	x	x	x	·	·	·	·	·	·
D5'	x	·	·	·	x	x	x	x	x	·
F1	x	·	·	·	·	·	·	·	·	x

Table 2: Type IIB brane construction for a Wilson defect.

factor. The defect arises from F1-strings stretching between the D5/D5'-brane and the D3-branes in the given chamber.

- A stack of k F1-strings connecting a D5-brane and N_γ D3-branes introduces a Wilson defect in the k -th symmetric representation \mathcal{S}_k of the gauge group $U(N_\gamma)$. The set of non-negative integers $\{k_j\}_{j=1,\dots,N_\gamma}$, where k_j is the number of F1-strings ending on the j -th D3-brane, generate the weights of the representation \mathcal{S}_k in the orthogonal basis, i.e. given a weight $w = (w_1, w_2, \dots, w_{N_\gamma})$ of \mathcal{S}_k , we have $w_j = k_j$, with $\sum_{j=1}^{N_\gamma} k_j = k$. Similarly, a stack of k' F1-strings connecting a D5'-brane and N_γ D3-branes introduces a Wilson defect in the k' -th antisymmetric representation $\mathcal{A}_{k'}$ of the gauge group $U(N_\gamma)$. Similar to the case of the symmetric representation, the set of integers $\{k_j\}_{j=1,\dots,N_\gamma}$, where k_j is the number of F1-strings ending on the j -th D3-brane, generate the weights of the representation $\mathcal{A}_{k'}$ in the orthogonal basis. In this case, the integers are constrained to be $k_j = 0, 1 \forall j$, by the s-rule [2].
- In general, there can be multiple stacks F1-strings in a given NS5 chamber, connecting l D5-branes and l' D5'-branes with the N_γ D3-branes, such that the D5 and D5'-branes are all separated in the x^3 and the x^9 directions. This generates a Wilson defect in the representation $R = \otimes_{a=1}^l \mathcal{S}_{k^{(a)}} \otimes_{b=1}^{l'} \mathcal{A}_{k'^{(b)}}$ of $U(N_\gamma)$, with the weights w being given as $w_j = \sum_{a=1}^l k_j^{(a)} + \sum_{b=1}^{l'} k_j'^{(b)}$. An illustrative example of Wilson defects in the quiver gauge theory X of Fig. 9 is given in Fig. 10. The defect involves a stack of F1-strings connecting a D5 and a D5' respectively with D3-branes, introducing a gauge Wilson defect for $U(2)$ in the representation $R = \mathcal{S}_k \otimes \mathcal{A}_2$.
- The Hanany-Witten moves for the Type IIB construction with defects are substantially restricted. Moving the F1-strings past an NS5-brane will change the Wilson defect and is therefore not allowed. However, one can move them past the D5-branes without changing the IR physics, provided that the equal number of D3-branes end on the D5 from the left and the right. This is always the case in the canonical configuration, where no D3-branes end on the D5-branes.
- Introducing flavor Wilson defects requires moving to a Hanany-Witten frame, where a stack of D3-branes is stretched between an NS5 and a D5-brane. One can then introduce an additional D5-brane and F1-strings connecting the former and the D3-

branes, leading to an Abelian defect in some representation of the maximal torus of the flavor symmetry group associated with these D3-branes. An example of a flavor Wilson loop in the theory X of Fig. 9 is shown in Fig. 11.

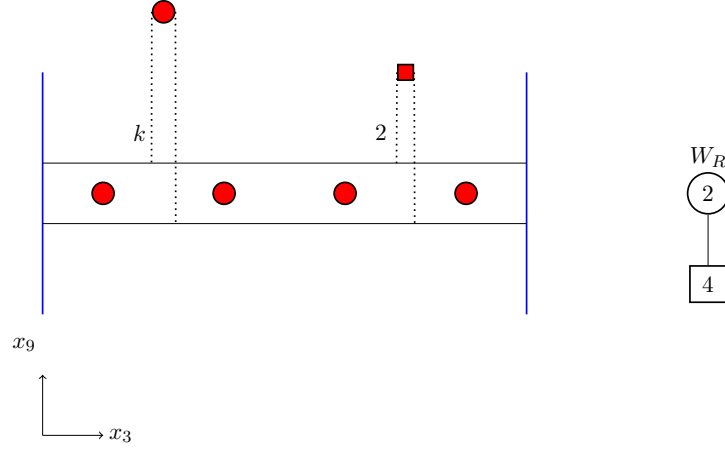

Figure 10: Type IIB brane construction for a gauge Wilson defect for $U(2)$ in a representation $R = \mathcal{S}_k \otimes \mathcal{A}_2$. The red rectangular nodes denote D5'-branes, while the dotted vertical lines denote F1-strings.

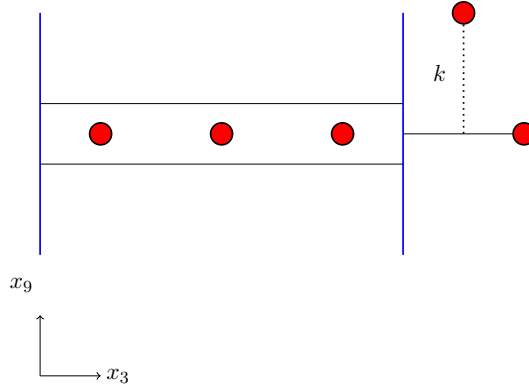

Figure 11: Type IIB brane construction for a flavor Wilson defect of charge k .

Vortex defects

In addition to the standard D3-D5-NS5 system for a linear quiver, the insertion of vortex defects in linear quivers requires additional NS5-branes and D1-branes connecting these NS5-branes with the NS5-branes in the original D3-D5-NS5 system. These additional NS5-branes can either have the same world-volume as the original NS5-branes or be rotated in a specific fashion as discussed below. In the latter case, we will refer to them as NS5'-branes, using the same notation as the D5-branes that appeared for the Wilson defects described above.

The respective world-volumes of the D3, D5, NS5, NS5', and the D1-branes are specified in Table 3. A more precise way of writing this data is as follows:

$$\begin{aligned}
\text{D3: } & \mathbb{R}^{2,1} \times L \times \{\mathbf{X}\}_{4,5,6} \times \{\mathbf{Y}\}_{7,8,9} \\
\text{D5: } & \mathbb{R}^{2,1} \times \{X_3\} \times \mathbb{R}_{4,5,6}^3 \times \{\mathbf{Y}'\}_{7,8,9} \\
\text{NS5: } & \mathbb{R}^{2,1} \times \{X'_3\} \times \{\mathbf{X}'\}_{4,5,6} \times \mathbb{R}_{7,8,9}^3 \\
\text{NS5': } & \mathbb{R}^{0,1} \times \{X_1\} \times \{X_2\} \times \{X'_3\} \times \mathbb{R}_{4,5}^3 \times \{X_6\} \times \mathbb{R}_{7,8,9}^3 \\
\text{D1: } & \mathbb{R}^{0,1} \times \{X'_1\} \times \{X'_2\} \times \{X''_3\} \times \{\mathbf{X}''\}_{4,5,6} \times \mathbb{R}_6 \times \{\mathbf{Y}''\}_{7,8,9},
\end{aligned} \tag{2.19}$$

where we use the notation that $\{\cdot\}$ indicates a point in respective direction(s).

	0	1	2	3	4	5	6	7	8	9
NS5	x	x	x	·	·	·	·	x	x	x
D5	x	x	x	·	x	x	x	·	·	·
D3	x	x	x	x	·	·	·	·	·	·
NS5'	x	·	·	·	x	x	·	x	x	x
D1	x	·	·	·	·	·	x	·	·	·

Table 3: Type IIB brane construction for a vortex line defect.

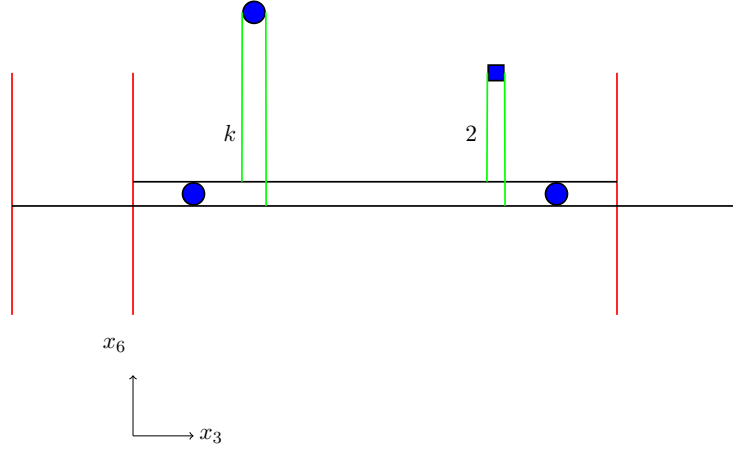

Figure 12: Type IIB brane construction for a gauge vortex defect for $U(2)$ in a representation $R = \mathcal{S}_k \otimes \mathcal{A}_2$. The blue rectangular nodes denote NS5'-branes, while the green vertical lines denote D1-strings.

We briefly list the important features of the Type IIB construction that will be relevant for the rest of the paper. Unless otherwise stated, we will always work with the canonical configuration where all D3-branes end on NS5-branes.

- In the γ -th NS5 chamber, the presence of an N5 or N5'-brane, away from the main stack of NS5-branes in the x^6 -direction, introduces a gauge vortex defect for the

$U(N_\gamma)$ factor. The defect arises from D1-branes stretching between the NS5/NS5'-brane and the D3-branes in the chamber γ .

- A stack of k D1-branes connecting an NS5-brane and N_γ D3-branes introduces a gauge vortex defect in the k -th symmetric representation \mathcal{S}_k of the gauge group $U(N_\gamma)$. The set of non-negative integers $\{k_j\}_{j=1,\dots,N_\gamma}$, where k_j is the number of D1-branes ending on the j -th D3-brane, generate the weights of the representation \mathcal{S}_k in the orthogonal basis, i.e. given a weight $w = (w_1, w_2, \dots, w_{N_\gamma})$ of \mathcal{S}_k , we have $w_j = k_j$, with $\sum_{j=1}^{N_\gamma} k_j = k$. Similarly, a stack of k' D1-branes connecting an NS5'-brane and N_γ D3-branes introduces a vortex defect in the k' -th antisymmetric representation $\mathcal{A}_{k'}$ of the gauge group $U(N_\gamma)$. In this case, the set of integers $\{k_j\}_{j=1,\dots,N_\gamma}$, where $k_j = 0, 1$ is the number of D1-branes ending on the j -th D3-brane, generate the weights of the representation $\mathcal{A}_{k'}$ in the orthogonal basis.
- In general, there can be multiple stacks D1-branes in a given NS5 chamber, connecting l NS5-branes and l' NS5'-branes with the N_γ D3-branes, such that the NS5 and NS5'-branes are all separated in the x^3 and the x^9 directions. This generates a vortex defect in the representation R of $U(N_\gamma)$:

$$R = \otimes_{a=1}^l \mathcal{S}_{k^{(a)}} \otimes_{b=1}^{l'} \mathcal{A}_{k'^{(b)}}, \quad (2.20)$$

with the weights w being given as $w_j = \sum_{a=1}^l k_j^{(a)} + \sum_{b=1}^{l'} k_j'^{(b)}$. Different relative orderings of the NS5/NS5'-branes in the x^6 and x^3 directions give the same vortex defect. An illustrative example of a vortex defect in the quiver gauge theory X of Fig. 9 is given in Fig. 12. The defect involves a stack of D1-branes connecting an NS5 and an NS5' respectively with D3-branes, introducing a gauge vortex defect for $U(2)$ in the representation $R = \mathcal{S}_k \otimes \mathcal{A}_2$.

- The Hanany-Witten moves for the Type IIB construction with defects are again restricted. Moving the D1-branes past an D5-brane are not allowed. However, one can move them past the NS5-branes without changing the IR physics, provided that the equal number of D3-branes end on the NS5 from the left and the right. Therefore, the position of the D1-stack in the x^3 -direction w.r.t the D5-branes in a given NS5-chamber is important. Generically, distinct insertion points (i.e. different number of D5-branes on the left/right of the D1-stack in the chamber) will lead to different vortex defect. Without loss of generality, let us assume that there are Q D5-branes to the right of the D1-stack. We will denote the vortex defect as $V_{Q,R}$, where R is defined above.
- A flavor Wilson defect for an Abelian subgroup of the 3d Coulomb branch symmetry can be introduced when a stack of D1-branes ends on an NS5-brane.

The above realization of a vortex defect can be regarded as a deformation of at least two different coupled 3d-1d system. This corresponds to making all the D1-branes end on the NS5-brane to the left, or making all of them end on the NS5-brane to the right.

In the former case, we will refer to the associated 1d quiver as the “left SQM”, and in the latter case as the “right SQM”. The rule for obtaining the left/right SQM from the set of D1-brane stacks, described above, is as follows. Suppose we have a set of P stacks where the x^9 positions of the NS5/NS5'-branes are in a decreasing order from left to right, and let k_i denote the number of D1-branes in the i -th stack. To begin with, one brings the NS5/NS5'-branes at the same point in x^3 direction (coincident with the left/right NS5-brane in main stack) but different points in x^9 , with D1-branes stretching between them. Before performing this operation, one needs to move the D5-branes in the chamber to the left/right of the NS5-brane so that the D-branes do not cross each other. In this configuration, the number of D1-branes in the i -th chamber, computed by demanding that the linking numbers associated with the NS5/NS5'-branes remain unchanged, is given by $n_i = \sum_{j=1}^i k_j$, with $i = 1, \dots, P$. For the defect in Fig. 12, this brane configuration is shown in Fig. 13, where the two D1-brane stacks are moved to the right NS5-brane. Given such a brane configuration, the 1d quiver can be obtained by the following rules:

1. k D1-branes stretched between an NS5 and an NS5'-brane give a $U(k)$ vector multiplet, while k D1-branes between a pair of NS5 or NS5'-branes give a $U(k)$ vector multiplet plus a single chiral multiplet in the adjoint representation. The gauge group is therefore $\prod_{i=1}^P U(n_i)$.
2. A given pair of consecutive 5-brane chambers, labelled i and $i + 1$, gives a bifundamental chiral and an anti-bifundamental chiral for $U(n_i) \times U(n_{i+1})$.
3. If N_L and N_R respectively denote the number of D3-branes ending on the NS5-brane in the main stack, then one has one bifundamental chiral for $U(n_P) \times U(N_L)$ and another bifundamental chiral for $U(N_R) \times U(n_P)$.

The 1d FI parameters can be related to the relative position of the NS5/NS5'-branes in the x^3 direction, i.e. $\eta_i = x_i^3 - x_{i-1}^3$, where η_i is the FI parameter associated with the 1d gauge group $U(n_i)$ with $i = 1, \dots, P$, and x_0^3 denotes the position of the NS5-brane in the main stack. This implies that the original Type IIB configuration can be thought of as a deformation of the left SQM with a positive FI parameter η_i for all the $U(n_i)$ factors, or equivalently as a deformation of the right SQM with negative FI parameters for the $U(n_i)$ factors.

The coupling of the SQM, constructed above, with the 3d quiver gauge theory can now be read off from the brane picture. The SQM has a $U(N_L) \times U(N_R)$ flavor symmetry, a subgroup of which will be gauged by the 3d bulk fields living on the D3-branes. Let us focus on the right SQM which implies that Q of the M_γ D5-branes in the γ -th NS5 chamber have to be moved to the right of the $\gamma + 1$ -th NS5-brane, and let $N_R = Q + n_R$. The SQM is then coupled to the 3d theory by gauging the $U(N_L) \times U(n_R)$ subgroup of the full flavor symmetry by dynamical 3d $\mathcal{N} = 4$ vector multiplets. In addition, the $U(Q)$ subgroup of $U(N_R)$ is weakly gauged by background 3d $\mathcal{N} = 4$ vector multiplets, completing the construction of the 3d-1d coupled system. We will denote the right SQM as $\Sigma_r^{Q,R}$ and the left SQM as $\Sigma_l^{Q,R}$.

To summarize, a gauge vortex defect in a 3d quiver gauge theory is completely (although not uniquely) specified by a 3d-1d coupled quiver along with a choice of the signs of the 1d FI parameters. In the construction presented above, they are either all positive (left SQM) or all negative (right SQM). The two 3d-1d systems associated with the vortex defect of Fig. 12 are shown in Fig. 14.

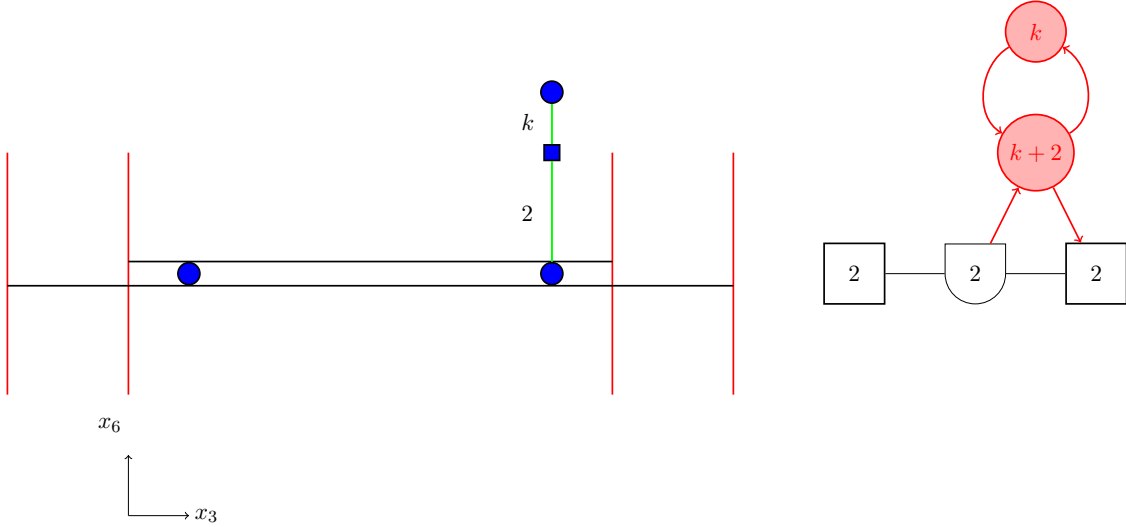

Figure 13: Type IIB brane construction for the right 3d-1d quiver that realizes a vortex defect $V_{2,R}$ for the $U(2)$ gauge group in the representation $R = \mathcal{S}_k \otimes \mathcal{A}_2$.

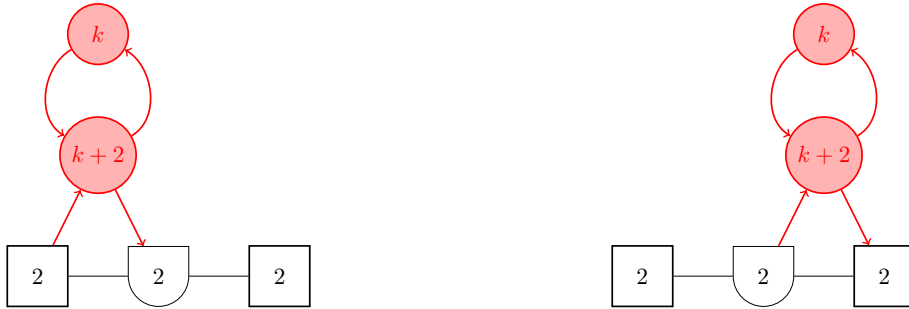

Figure 14: The right and the left 3d-1d quivers that realize a vortex defect $V_{2,R}$ for the $U(2)$ gauge group in a representation $R = \mathcal{S}_k \otimes \mathcal{A}_2$.

2.2.3 S-duality and mirror map

Given the Type IIB construction of the Wilson and the vortex defects in linear quivers, the mirror maps for such defects can be understood in the standard fashion. One implements an S-duality operation on a given brane configuration with defects, followed by a rotation $\mathbf{x}^{7,8,9} \rightarrow -\mathbf{x}^{4,5,6}$, $\mathbf{x}^{4,5,6} \rightarrow \mathbf{x}^{7,8,9}$, and finally a set of Hanany-Witten moves to read off the

mirror theory with the dual defects. NS5 and NS5'-branes are exchanged with D5 and D5'-branes under S-duality, while D3-branes are self-dual, as before. In addition, F1-strings and D1-branes are exchanged under the operation. As mentioned earlier, the Hanany-Witten moves are restricted, since F1-strings cannot cross NS5-branes while D1-branes cannot cross the D5-branes. In Fig. 15, we show a concrete example of a vortex defect in quiver X mapping to a Wilson defect in quiver Y , where the quivers X, Y are given in Fig. 12. We refer the reader to [9] for the more general cases.

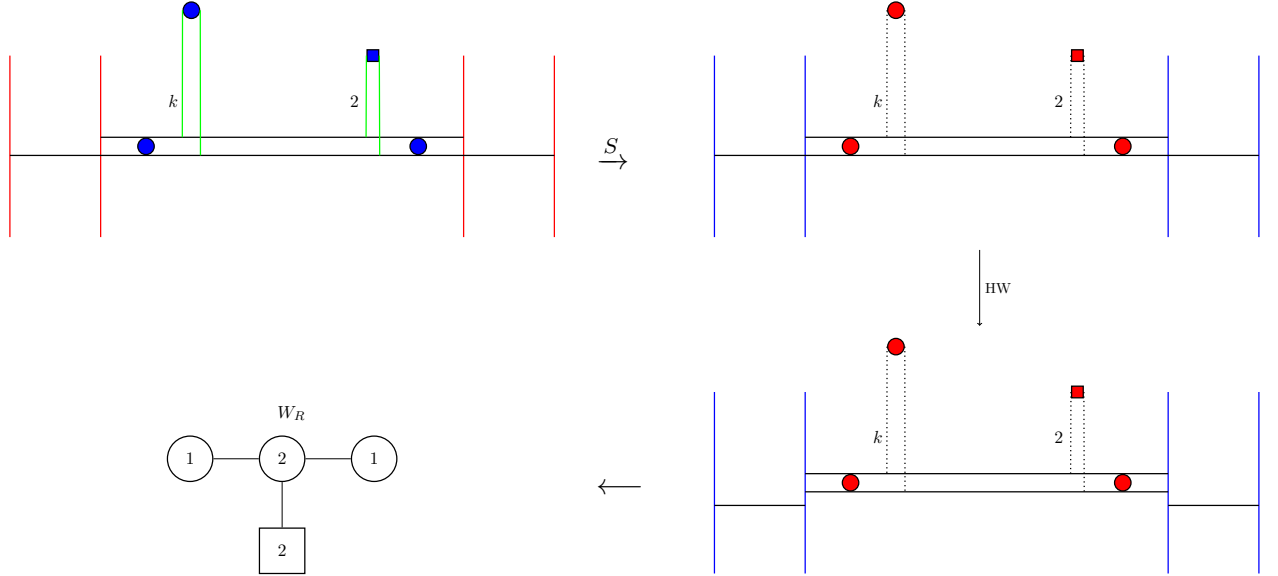

Figure 15: Type IIB configuration for a vortex defect mapping to the corresponding configuration for a Wilson defect.

2.3 Wilson/vortex defects on S^3 and the Localization formulae

The localization formulae for the expectation values of Wilson and vortex defects for 3d $\mathcal{N} = 4$ theories on S^3 will be our basic tool for performing computations on the QFT side. In this section, we give a brief review of these formulae, emphasizing aspects that will be important in the rest of the paper. For a detailed study of the $\mathcal{N} = 4$ supersymmetry algebra on S^3 , and the inequivalent 1d $\mathcal{N} = 4$ subalgebras, we refer the reader to [14, 15]. The study of Wilson defects for $\mathcal{N} \geq 2$ theories was initiated in [16], while vortex defects for Abelian $\mathcal{N} = 4$ theories were addressed in [17, 18], and extended to non-Abelian linear quivers in [9].

Let us summarize a few important and relevant features of $\mathcal{N} = 4$ supersymmetry on S^3 :

- The 3d $\mathcal{N} = 4$ supersymmetry algebra on S^3 is $\mathfrak{su}(2|1)_l \oplus \mathfrak{su}(2|1)_r$. The even generators consist of the generators of $\mathfrak{su}(2)_l \oplus \mathfrak{su}(2)_r$, which is the Lie algebra of the isometry group of S^3 , and the $\mathfrak{u}(1)_l \oplus \mathfrak{u}(1)_r$ generators. The $\mathfrak{u}(1)_{l,r}$ generators are

given by the linear combinations $R_C \pm R_H$, where R_C, R_H are the Cartan generators of the $\mathfrak{su}(2)_C, \mathfrak{su}(2)_H$ Lie algebras respectively. The odd generators have the following anticommutators:

$$\{Q_{l\alpha}, \bar{Q}_{l\beta}\} = \frac{2}{L} \left[\sigma_{\alpha\beta}^\mu J_\mu^l + \frac{\epsilon_{\alpha\beta}}{2} (R_C + R_H) \right], \quad (2.21)$$

$$\{Q_{r\alpha}, \bar{Q}_{r\beta}\} = \frac{2}{L} \left[\sigma_{\alpha\beta}^\mu J_\mu^r + \frac{\epsilon_{\alpha\beta}}{2} (R_C - R_H) \right], \quad (2.22)$$

where J_μ^l, J_μ^r are the $\mathfrak{su}(2)_l, \mathfrak{su}(2)_r$ generators respectively. The odd generators reduce to the $\mathcal{N} = 4$ Poincare supercharges in the flat space limit $L \rightarrow \infty$.

- 3d $\mathcal{N} = 4$ theories admit two types of supersymmetry deformation – hypermultiplet masses and FI parameters. Unlike flat space, supersymmetry permits turning on a single scalar in a given background (twisted) vector multiplet on S^3 , as opposed to a triplet. Observables like the partition function with/without defects are therefore written as functions of a set of real variables, one for every Cartan generator in the Lie algebra of $G_H \times G_C$.
- There are two inequivalent subalgebras inside the 3d $\mathcal{N} = 4$ supersymmetry algebra, which correspond to two different embeddings of $\mathfrak{su}(1|1)_l \oplus \mathfrak{su}(1|1)_r$ inside $\mathfrak{su}(2|1)_l \oplus \mathfrak{su}(2|1)_r$. Analogous to the flat space case, these subalgebras are exchanged under 3d mirror symmetry. Observables preserving one of the subalgebras is mapped to observables preserving the other, under mirror symmetry.

Bare partition function

Consider a 3d $\mathcal{N} = 4$ quiver gauge theory \mathcal{T} with gauge group G and a Higgs branch global symmetry group G_H , such that the hypermultiplets transform in a representation \mathcal{R} of $G \times G_H$. The partition function without defects [19] can be written as a matrix integral in terms of a single real scalar s which lives in the Cartan subalgebra of the gauge group. The real scalar s is the zero-mode associated with the real adjoint scalar field that sits inside the 3d $\mathcal{N} = 2$ vector multiplet, which in turn sits inside the 3d $\mathcal{N} = 4$ vector multiplet. As mentioned earlier, the partition function is a function of the real masses \mathbf{m} and real FI parameters $\boldsymbol{\eta}$, which are real scalars inside background 3d $\mathcal{N} = 4$ vector and twisted vector multiplets respectively. The matrix integral assumes the following form:

$$Z^{(\mathcal{T})}(\mathbf{m}; \boldsymbol{\eta}) = \int [d\mathbf{s}] Z_{\text{int}}(\mathbf{s}, \mathbf{m}, \boldsymbol{\eta}) =: \int [d\mathbf{s}] Z_{\text{FI}}(\mathbf{s}, \boldsymbol{\eta}) Z_{1\text{-loop}}^{\text{vector}}(\mathbf{s}) Z_{1\text{-loop}}^{\text{hyper}}(\mathbf{s}, \mathbf{m}), \quad (2.23)$$

where the measure $[d\mathbf{s}] = \frac{d^k \mathbf{s}}{|W(G)|}$, and $|W(G)|$ is the order of the Weyl group of G . The individual terms in the integrand on the RHS consist of classical and one-loop contributions, and are given as follows.

- The classical contribution arises from the l $U(1)$ factors in the gauge group:

$$Z_{\text{FI}}(\mathbf{s}, \boldsymbol{\eta}) = \prod_{\gamma=1}^l e^{2\pi i \eta_\gamma \text{Tr}(\mathbf{s}^\gamma)}, \quad (2.24)$$

where γ runs over the l gauge nodes with a $U(1)$ factor and η_γ is the associated FI parameter.

- The $\mathcal{N} = 4$ vector multiplet contributes a one-loop term:

$$Z_{1\text{-loop}}^{\text{vector}}(\mathbf{s}) = \prod_{\alpha} \sinh \pi \alpha(\mathbf{s}), \quad (2.25)$$

where the product extends over the roots of the Lie algebra of G . In fact, this is precisely the contribution of an $\mathcal{N} = 2$ vector multiplet since contribution of the adjoint chiral which is part of the $\mathcal{N} = 4$ vector multiplet is trivial [19].

- The one-loop contribution from $\mathcal{N} = 4$ hypermultiplets transforming in a representation \mathcal{R} of $G \times G_H$:

$$Z_{1\text{-loop}}^{\text{hyper}}(\mathbf{s}, \mathbf{m}) = \prod_{\rho(\mathcal{R})} \frac{1}{\cosh \pi \rho(\mathbf{s}, \mathbf{m})}, \quad (2.26)$$

where the product extends over the weights of the representation \mathcal{R} .

Given a mirror pair of theories X and Y , the partition functions of the theories are related as:

$$Z^{(X)}(\mathbf{m}; \boldsymbol{\eta}) = C_{XY}(\mathbf{m}, \boldsymbol{\eta}) Z^{(Y)}(\mathbf{m}'; \boldsymbol{\eta}'(\mathbf{m})), \quad (2.27)$$

$$C_{XY}(\mathbf{m}, \boldsymbol{\eta}) = e^{2\pi i \sum_{k,l} a^{kl} m_k \eta_l}, \quad (2.28)$$

where $(\mathbf{m}, \boldsymbol{\eta})$, $(\mathbf{m}', \boldsymbol{\eta}')$ are the masses and FI parameters for X and Y respectively. The mass parameters \mathbf{m}' and the FI parameters $\boldsymbol{\eta}'$ of Y are linear functions of the FI parameters and the mass parameters of X respectively. The partition functions agree up to an overall phase factor, whose exponent is linear in \mathbf{m} and $\boldsymbol{\eta}$ with integer coefficients a^{kl} . These phase factors arise from the three-dimensional contact terms as discussed in [20]. For the special case where (X, Y) are linear quivers with unitary gauge groups, the mirror map simply exchanges the mass and FI parameters up to a sign, and the partition functions are related as

$$Z^{(X)}(\mathbf{m}; \mathbf{t}) = e^{2\pi i a^{kl} m_k t_l} Z^{(Y)}(\mathbf{t}; -\mathbf{m}), \quad (2.29)$$

where the parameters t and m are as defined in Section 2.2.1.

Partition function with Wilson defects

A Wilson defect in a representation R of the gauge group G can be defined as:

$$W_R = \text{Tr}_R \left(P \exp \oint_{\gamma} (i A_{\mu} \dot{x}^{\mu} - |\dot{x}| \sigma) d\tau \right), \quad (2.30)$$

where γ is a curve on S^3 and τ is a coordinate along γ . The curve γ , if chosen to wrap a Hopf fiber at the north pole of the S^2 base of S^3 , gives a half-BPS Wilson defect [9]. The preserved subalgebra corresponds to a certain embedding of $\mathfrak{su}(1|1)_l \oplus \mathfrak{su}(1|1)_r$ inside

$\mathfrak{su}(2|1)_l \oplus \mathfrak{su}(2|1)_r$. The partition function of the theory \mathcal{T} with a half-BPS Wilson defect W_R inserted along the curve $\gamma \in S^3$, is given as

$$Z^{(\mathcal{T}[W_R])}(\mathbf{m}; \boldsymbol{\eta}) = \int [ds] Z_{\text{Wilson}}(\mathbf{s}, R) Z_{\text{FI}}(\mathbf{s}, \boldsymbol{\eta}) Z_{1\text{-loop}}^{\text{vector}}(\mathbf{s}) Z_{1\text{-loop}}^{\text{hyper}}(\mathbf{s}, \mathbf{m}), \quad (2.31)$$

$$Z_{\text{Wilson}}(\mathbf{s}, R) = \text{Tr}_R \left(e^{2\pi \mathbf{s}} \right) = \sum_{w \in R} e^{2\pi w \cdot \mathbf{s}}, \quad (2.32)$$

where w are the weights of the representation R , and the functions Z_{FI} , $Z_{1\text{-loop}}^{\text{vector}}$, $Z_{1\text{-loop}}^{\text{hyper}}$ are defined above. The expectation value of the defect is then given as

$$\langle W_R \rangle_{\mathcal{T}}(\mathbf{m}; \boldsymbol{\eta}) = \frac{1}{Z^{(\mathcal{T})}(\mathbf{m}; \boldsymbol{\eta})} \int [ds] Z_{\text{Wilson}}(\mathbf{s}, R) Z_{\text{FI}}(\mathbf{s}, \boldsymbol{\eta}) Z_{1\text{-loop}}^{\text{vector}}(\mathbf{s}) Z_{1\text{-loop}}^{\text{hyper}}(\mathbf{s}, \mathbf{m}). \quad (2.33)$$

The matrix integral for a generic Wilson defect is divergent, with the divergence arising from the region(s) $s_i \rightarrow \pm\infty$. The integral can be regularized by deforming the contour of integration for each eigenvalue s_i as follows. Note that the matrix integral poles, which exclusively come from the function $Z_{1\text{-loop}}^{\text{hyper}}$, are located in the upper and lower half-planes of the complex variable s_i , along lines parallel to the imaginary axis. For $\eta > 0$ ($\eta < 0$), the contour is deformed such that it encloses all the poles of the integrand in the upper (lower) half-plane, and moves off the real axis along an imaginary line at a finite point (see figure 37 of [9] for a schematic version of such a contour).

Partition function with vortex defects

Half-BPS vortex defects can be defined as disorder operators in a 3d $\mathcal{N} = 4$ theory on S^3 [17], where the defect is supported on a Hopf fiber at the north/south pole of the S^2 base of S^3 . The preserved supersymmetry corresponds to an inequivalent embedding of $\mathfrak{su}(1|1)_l \oplus \mathfrak{su}(1|1)_r$ inside $\mathfrak{su}(2|1)_l \oplus \mathfrak{su}(2|1)_r$, compared to the Wilson defect.

In order to realize a vortex defect as a coupled 3d-1d quiver with the SQM living on the Hopf fiber, one has to first specify which class of 1d theories preserves the same supersymmetry as that of a vortex defect. It was shown in [9] that :

- The 3d half-BPS vortex subalgebra can be written as a 1d (2,2) supersymmetry algebra deformed by background gauge fields for J_- and a $U(1)$ flavor symmetry G_F , where J_{\pm} are the Cartan generators of the Lie algebra of the 1d R-symmetry. The 1d generators can be related to the 3d generators as

$$J_- =: J_3^l + J_3^r - R_C, \quad (2.34)$$

$$G_F =: J_3^l + J_3^r - R_H. \quad (2.35)$$

- The identification works only for special values of the associated background vector multiplet fields:

$$J_- : a_- = -i/L, \quad m_- = 0, \quad (2.36)$$

$$G_F : a_F = 0, \quad m_F = 1/L. \quad (2.37)$$

Given this identification, one can construct a generic coupled 3d-1d quiver which preserves the appropriate supersymmetry algebra. The general procedure involves identifying 1d flavor symmetries (other than G_F) with 3d flavor symmetries and gauging them with dynamical or background 3d vector multiplets. At the level of the UV Lagrangian, this identification is imposed by turning on cubic superpotentials of the form (2.13), involving 1d chiral multiplets and 3d half-hypermultiplets. The SQM will have additional superpotential couplings consistent with (2,2) supersymmetry. Given this 3d-1d Lagrangian, one can now proceed to compute its partition function on S^3 , by performing a localization analysis [9]. The answer passes various consistency checks, and agrees with the known dualities from String Theory. Below, we summarize the main steps of the recipe, and refer the reader to [9] for further details.

- **1d Witten index:** The first step is to compute the twisted partition function (Witten index) of the SQM Σ with a gauge group G_{1d} and a flavor symmetry $G_F \times G'_F$. The twisted Witten index is formally defined as,

$$\mathcal{I}^\Sigma(\mathbf{m}, z, \mu | \boldsymbol{\xi}) = \text{Tr}_{\mathcal{H}} (-1)^F e^{2\pi i z J_-} e^{2\pi i \mu G_F} e^{2\pi i \mathbf{m}_i J_i}, \quad (2.38)$$

where we have isolated the J_- and G_F generators with complex chemical potentials $z = L(ia_- + m_-)$ and $\mu = L(ia_F + m_F)$ respectively. The remaining flavor symmetry generators are collectively denoted as $\{J_i\}$, with complex chemical potentials $\{\mathbf{m}_i\}$. The parameters $\boldsymbol{\xi}$ are the FI parameters associated with unitary factors in G_{1d} . On a circle, the path integral can be worked out using localization and can be written in terms of JK-residue formula [21], i.e.

$$\mathcal{I}^\Sigma(\mathbf{m}, z, \mu | \boldsymbol{\xi}) = \oint_{JK-\boldsymbol{\xi}} \prod_{I=1}^{\text{rank}(G_{1d})} dx_I g_{\text{vector}}(\mathbf{x}, z) \cdot g_{\text{chiral}}(\mathbf{x}, \mathbf{m}, \mu, z), \quad (2.39)$$

$$g_{\text{vector}}(\mathbf{x}, z) = \left(\frac{\pi}{\sinh \pi z} \right)^{\text{rank}(G_{1d})} \prod_{\alpha} \frac{\sinh \pi(-\alpha(x))}{\sinh \pi(\alpha(x) - z)}, \quad (2.40)$$

$$g_{\text{chiral}}(\mathbf{x}, \mathbf{m}, \mu, z) = \prod_{\rho \in \mathcal{R}} \frac{\sinh \pi[-(\rho(\mathbf{x}, \mathbf{m}) + q\mu + (\frac{r}{2} - 1)z)]}{\sinh \pi(\rho(\mathbf{x}, \mathbf{m}) + q\mu + \frac{r}{2}z)}. \quad (2.41)$$

In the above formula, α is a root of the Lie algebra of G_{1d} , ρ is a weight of the representation \mathcal{R} of $G_{1d} \times G'_F$ in which the chiral multiplet transforms, q is the G_F charge and r is the charge under J_- . The G_F and R -charges of the chiral multiplets are subject to various superpotential constraints. The convention for the JK residue for a meromorphic k -form $g(\mathbf{x}, \mathbf{m}, \mu, z)$ is given as:

$$\text{JK} - \text{Res}_{\boldsymbol{\xi}}[x^*]g(\mathbf{x}, \mathbf{m}, \mu, z) = \begin{cases} |\text{Res}[x^*]g(\mathbf{x}, \mathbf{m}, \mu, z)|, & \text{if } -\boldsymbol{\xi} \in C(w^I), \\ 0, & \text{otherwise,} \end{cases} \quad (2.42)$$

where a given set of poles $x^* = \{x_I^*\}$ is given by the intersection of k hyperplanes in \mathbb{C}^k , parametrized by the equations $w^{(I)} \cdot x^* + \tilde{\mathbf{q}}^{(I)} \cdot \mathbf{m} + q^{(I)} \cdot \mu + \frac{r^{(I)}}{2}z = 0$, with $I = 1, \dots, k$. $C(w^I)$ is a positive cone spanned by the k weight vectors: $C(w^I) = \{\sum_I^k c_I w^{(I)} | c_I > 0\}$, and $\boldsymbol{\xi} = \eta(1, 1, \dots, 1)$ should be treated as a vector in \mathbb{C}^k .

- **3d-1d matrix model:** The next step is to write the combined partition function of the SQM Σ coupled with a 3d quiver gauge theory \mathcal{T} , as a matrix model. At the level of the matrix model, identification of 1d flavor symmetries with 3d flavor symmetries can be performed in two steps. Firstly, one restricts the complex chemical potentials \mathbf{m} to take real values, and secondly, one identifies those real scalars with appropriate real scalars from the background vector multiplet associated with the 3d flavor symmetry. Finally, one can gauge a subgroup of the flavor symmetry by integrating over some of the scalars with the right measure. This reasoning leads to the following expression for the 3d-1d partition function on S^3 :

$$Z^{\mathcal{T}[\Sigma]}(\mathbf{m}; \boldsymbol{\eta}) = \lim_{\substack{z \rightarrow 1 \\ \mu \rightarrow 1}} \int [ds] Z_{\text{int}}^{(\mathcal{T})}(\mathbf{s}, \mathbf{m}, \boldsymbol{\eta}) \cdot \mathcal{I}^{\Sigma}(\mathbf{s}, \mathbf{m}, \mu, z|\boldsymbol{\xi}), \quad (2.43)$$

where the limits on z and μ arise from the fact that one needs special values of the J_- and G_F background gauge fields to preserve supersymmetry, as given in (2.36)-(2.37).

- **Analytic continuation and $z \rightarrow 1$ limit :** The final step of the recipe is to give a prescription about how the limits on the RHS of (2.43) should be taken. It turns out that the $\mu \rightarrow 1$ can be taken in a straightforward fashion. However, for z , the correct prescription for taking the limit, is to first analytically continue $z \in i\mathbb{R}$ in the integrand, perform the integration, and then finally set $z = 1$. One can then write down the final form of the 3d-1d partition function:

$$Z^{\mathcal{T}[\Sigma]}(\mathbf{m}; \boldsymbol{\eta}) = \lim_{z \rightarrow 1} \int [ds] Z_{\text{int}}^{(\mathcal{T})}(\mathbf{s}, \mathbf{m}, \boldsymbol{\eta}) \cdot \mathcal{I}^{\Sigma}(\mathbf{s}, \mathbf{m}, z|\boldsymbol{\xi}), \quad (2.44)$$

where the Witten index $\mathcal{I}^{\Sigma}(\mathbf{s}, \mathbf{m}, z|\boldsymbol{\xi}) = \lim_{\mu \rightarrow 1} \mathcal{I}^{\Sigma}(\mathbf{s}, \mathbf{m}, \mu, z|\boldsymbol{\xi})$. While doing an actual computation, we will only retain the z -dependence of the matrix model integrand in places where it changes the location of a pole. The $z \rightarrow 1$ limit can be taken trivially everywhere else.

Given the above recipe, one can compute the partition function (and therefore the expectation value) of a vortex defect inserted in a 3d theory on S^3 . The only input needed to perform this exercise is the precise 3d-1d quiver that corresponds to a given vortex defect, including the chamber in which the Witten index should be computed. Assuming that the 3d-1d quiver which realizes a vortex defect $V_{\mathcal{D},R}$ (with R being a representation of the 3d gauge group G and \mathcal{D} being some additional data) is known, the expectation value of the defect is given by the general formula:

$$\langle V_{\mathcal{D},R} \rangle_{\mathcal{T}} = W_{\text{b.g.}}(\boldsymbol{\eta}) \times \frac{1}{Z^{(\mathcal{T})}(\mathbf{m}; \boldsymbol{\eta})} \times \lim_{z \rightarrow 1} \int [ds] Z_{\text{int}}^{(\mathcal{T})}(\mathbf{s}, \mathbf{m}, \boldsymbol{\eta}) \mathcal{I}^{\Sigma^{\mathcal{D},R}}(\mathbf{s}, \mathbf{m}, z|\boldsymbol{\xi}), \quad (2.45)$$

where $W_{\text{b.g.}}(\boldsymbol{\eta})$ are Wilson defects for 3d topological symmetries that can also be turned on.

Using the Type IIB construction, reviewed in Section 2.2, it is possible to obtain the coupled 3d-1d quivers which realize the vortex defects for linear quivers with unitary gauge

groups. The general form of the 1d quivers that arise from this construction is shown in Fig. 3 and the associated 3d-1d quivers are of the generic form in Fig. 4. As we noted in our discussion in Section 2.2.2, there are at least two different 3d-1d quivers that can describe the same vortex defect in a linear quiver, involving the “right” and the “left” SQM. A generic example of this hopping duality is shown in Fig. 16.

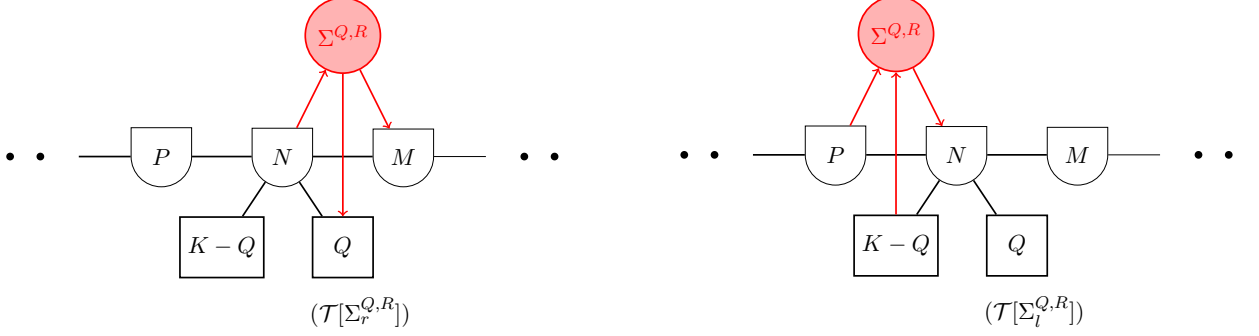

Figure 16: The right SQM $\Sigma_r^{Q,R}$ and the left SQM $\Sigma_l^{Q,R}$ coupled to a 3d linear quiver, which realize a vortex defect $V_{Q,R}$ of the gauge group $U(N)$. Note that $\Sigma_r^{Q,R}$ and $\Sigma_l^{Q,R}$ only differ in the numbers of fundamental and anti-fundamental chiral multiplets for the terminal gauge node.

Therefore, for a linear quiver \mathcal{T} , one can explicitly write down the expectation values of the vortex defect in a representation R of the gauge group $U(N) \subset G$:

$$\langle V_{Q,R}^{l,r} \rangle_{\mathcal{T}} = W_{\text{b.g.}}^{l,r}(\mathbf{t}) \times \frac{1}{Z^{(\mathcal{T})}(\mathbf{m}; \mathbf{t})} \times \lim_{z \rightarrow 1} \int [ds] Z_{\text{int}}^{(\mathcal{T})}(\mathbf{s}, \mathbf{m}, \mathbf{t}) \cdot \mathcal{I}^{\Sigma_{l,r}^{Q,R}}(\mathbf{s}, \mathbf{m}, z | \boldsymbol{\xi} \geq 0), \quad (2.46)$$

where the superscripts l, r denote the choice of the specific 3d-1d system (left or right) that realizes the vortex defect. Note that the left/right SQM realization comes with a prescription for the signs of the FI parameters, which determines the specific chamber in which the Witten index should be evaluated. As discussed in Section 2.2.2, this piece of information can also be read off from the Type IIB construction. The Witten indices for the right and the left SQM associated with the vortex defect in Fig. 16 have the general expression

$$\mathcal{I}^{\Sigma_r^{Q,R}} = \sum_{w \in R} \mathcal{F}^r(\mathbf{s}, z) \prod_{j=1}^N \prod_{i=1}^M \frac{\cosh \pi(s_j^{(N)} - s_i^{(M)})}{\cosh \pi(s_j^{(N)} + iw_j z - s_i^{(M)})} \prod_{a=1}^Q \frac{\cosh \pi(s_j^{(N)} - m_a)}{\cosh \pi(s_j^{(N)} + iw_j z - m_a)}, \quad (2.47)$$

$$\mathcal{I}^{\Sigma_l^{Q,R}} = \sum_{w \in R} \mathcal{F}^l(\mathbf{s}, z) \prod_{j=1}^N \prod_{l=1}^P \frac{\cosh \pi(s_j^{(N)} - s_l^{(P)})}{\cosh \pi(s_j^{(N)} - iw_j z - s_l^{(P)})} \prod_{b=1}^{K-Q} \frac{\cosh \pi(s_j^{(N)} - m_b)}{\cosh \pi(s_j^{(N)} - iw_j z - m_b)}, \quad (2.48)$$

where $w = (w_1, \dots, w_N)$ are the weights of the representation R . Subgroups of the $U(Q)$ and/or $U(K-Q)$ flavor symmetry groups can be promoted to gauge groups, which would

amount to integrating over a subset of the $\{m_a\}$ and/or the $\{m_b\}$ parameters with appropriate measure in the matrix model. The functions $\mathcal{F}^r(\mathbf{s}, z)$, $\mathcal{F}^l(\mathbf{s}, z)$ have poles which give zero residues in the limit $z \rightarrow 1$, and therefore one can take the limit for this term before performing the integral. Therefore, one can drop these functions in the formulae for Witten indices in the rest of the paper⁵.

Finally, the background Wilson defects for the left and the right SQM are given by

$$W_{\text{b.g.}}^r(\mathbf{t}) = e^{2\pi|R|t_r}, \quad W_{\text{b.g.}}^l(\mathbf{t}) = e^{2\pi|R|t_l}, \quad (2.49)$$

where the FI parameter of the $U(N)$ gauge group is given by $\eta^{(N)} = t_l - t_r$. The integer $|R|$ is the number of boxes in the Young diagram associated with the representation R .

At the level of the matrix model, the hopping duals are related by a simple change of variables. Starting from the partition function of the right 3d-1d quiver, given by (2.46)-(2.47), one can obtain the partition function of the left 3d-1d quiver, given by (2.46)-(2.48), by the following transformation:

$$s_j^{(N)} \rightarrow s_j^{(N)} - iw_j z, \quad \forall j = 1, \dots, N, \quad (2.50)$$

keeping all the other integration variables fixed. Since we have analytically continued $z \in i\mathbb{R}$, this operation will not introduce or omit any poles.

Mirror Map

Given that 3d mirror symmetry exchanges the 1d supersymmetry subalgebras SQM_A and SQM_B , one expects the half-BPS vortex defects to map to the half-BPS Wilson defects. The precise map, however, is difficult to determine for a generic pair of mirror duals. For linear quivers, the Type IIB construction allows one to explicitly construct these mirror maps, which could be independently checked by the sphere partition functions discussed above. Given a pair of linear quiver theories X and Y , the vortex-to-Wilson mirror map has the schematic form

$$\langle V_{Q,R}^{r,l} \rangle_X(\mathbf{m}; \mathbf{t}) = \langle \widetilde{W}_{R'} \rangle_Y(\mathbf{t}; -\mathbf{m}), \quad (2.51)$$

where $\widetilde{W}_{R'}$ is Wilson defect in representation R' of the gauge and flavor symmetry groups of the theory Y . An explicit mirror map for defects in the dual linear quiver pair of Fig. 9 is discussed in Appendix A.2. Similarly, a Wilson-to-vortex mirror map has the schematic form

$$\langle W_R \rangle_X(\mathbf{m}; \mathbf{t}) = \sum_i \langle \widetilde{W}_{\text{b.g.}}^{(i)} \cdot \widetilde{V}_{Q_i, R_i}^{r,l} \rangle_Y(-\mathbf{t}; \mathbf{m}), \quad (2.52)$$

where the RHS is a sum over vortex defects in the theory Y , combined with Wilson defects for 3d topological symmetries. An explicit mirror map of this type is discussed in Appendix A.3 for the dual pair in Fig. 9.

⁵For the precise forms of these functions, see Appendix B of [9].

3 Elementary S -type operations and mirror map of line defects

In this section, we discuss the construction of half-BPS defects and their mirror maps in theories beyond linear quivers, using the elementary S -type operations introduced in [1]. In addition, we present a systematic procedure to compute the associated mirror maps of line defects.

3.1 Elementary S -type operations on theories without defects: Review

Consider a pair of mirror dual quiver gauge theories (X, Y) where X belongs to class \mathcal{U} , i.e. a class of 3d CFTs with a UV Lagrangian that has a manifest global symmetry subgroup $G_{\text{global}}^{\text{sub}} = \prod_{\gamma} U(M_{\gamma})$. We will additionally assume that X and Y are good quivers in the Gaiotto-Witten sense [7]. Given such a quiver X , one can define a set of four basic operations [1]:

1. **Gauging ($G_{\mathcal{P}}^{\alpha}$):** A *gauging operation* $G_{\mathcal{P}}^{\alpha}$ at a flavor node α of the theory X (shown in the schematic figure below) involves the following two steps :

- The flavor node $U(M_{\alpha})$ is split into two flavor nodes, corresponding to a $U(r_{\alpha}) \times U(M_{\alpha} - r_{\alpha})$ global symmetry. The $U(1)^{M_{\alpha}}$ background vector multiplets are identified as the $U(1)^{r_{\alpha}} \times U(1)^{M_{\alpha} - r_{\alpha}}$ background vector multiplets by the following map:

$$\vec{m}_{i_{\alpha}}^{\alpha} = \mathcal{P}_{i_{\alpha}i} \vec{u}_i^{\alpha} + \mathcal{P}_{i_{\alpha}r_{\alpha}+j} \vec{v}_j^{\alpha}, \quad (i_{\alpha} = 1, \dots, M_{\alpha}, \quad i = 1, \dots, r_{\alpha}, \quad j = 1, \dots, M_{\alpha} - r_{\alpha}), \quad (3.1)$$

where any such map is parametrized by a choice of \mathcal{P} – a permutation matrix of order M_{α} . The resultant theory deformed by the $U(r_{\alpha}) \times U(M_{\alpha} - r_{\alpha})$ mass parameters will be denoted as (X, \mathcal{P}) .

- Given the theory (X, \mathcal{P}) , the flavor symmetry node $U(r_{\alpha})$ is promoted to a gauge node, i.e. the vector multiplets for $U(r_{\alpha})$ are now dynamical, and a background twisted vector multiplet for the $U(1)_J$ topological symmetry is turned on.

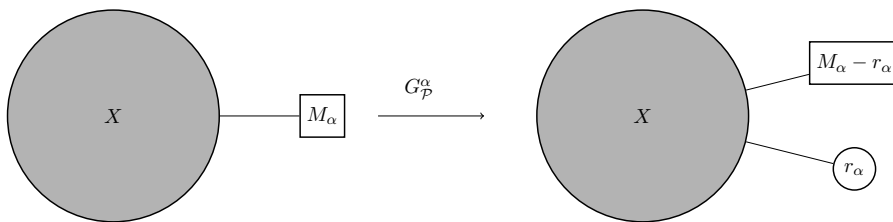

2. **Flavoring ($F_{\mathcal{P}}^{\alpha}$):** A *flavoring operation* $F_{\mathcal{P}}^{\alpha}$ at a flavor node α of the quiver gauge theory X (shown schematically in the figure below) involves the following two steps:

- Firstly, the theory (X, \mathcal{P}) is defined as above.
- Given the theory (X, \mathcal{P}) , a flavor node labelled by G_F^{α} is attached to the flavor node $U(r_{\alpha})$, as shown on the RHS of the figure below. This introduces some free hypermultiplets in the theory which transform under some representation of the global symmetry group $U(r_{\alpha}) \times G_F^{\alpha}$.

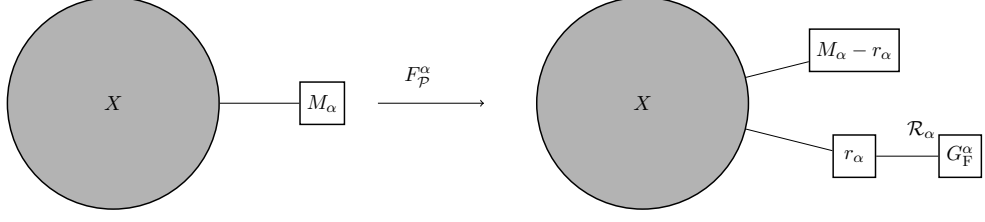

3. **Identification ($I_{\mathcal{P}}^\alpha$):** Given the quiver gauge theory X with a flavor symmetry subgroup $\prod_{\gamma=1}^L U(M_\gamma)$, let N_{p,r_α}^β denote a set of (not necessarily consecutive) $p \leq L$ flavor nodes labelled by β , where $\beta = \gamma_1, \dots, \gamma_p$. The parameter r_α is a positive integer such that $r_\alpha \leq \text{Min}(\{M_\beta\} | \beta \in N_{p,r_\alpha}^\beta)$. Let α be a chosen node in N_{p,r_α}^β . The identification operation $I_{\mathcal{P}}^\alpha$, shown in a figure below for $\beta = 2$, can be performed at a chosen node α in two steps:

- For all $\beta \in N_{p,r_\alpha}^\beta$, we split the corresponding flavor node $U(M_\beta) \rightarrow U(r_\alpha)_\beta \times U(M_\beta - r_\alpha)$ symmetry. For a given β , the choice of the $U(1)^{r_\alpha} \times U(1)^{M_\beta - r_\alpha}$ background vector multiplets in terms of the original $U(1)^{M_\beta}$ background vector multiplets can be encoded in the map:

$$\vec{m}_{i_\beta}^\beta = \mathcal{P}_{i_\beta i} \vec{u}_i^\beta + \mathcal{P}_{i_\beta r_\alpha + j} \vec{v}_j^\beta, \quad (i_\beta = 1, \dots, M_\beta, \quad i = 1, \dots, r_\alpha, \quad j = 1, \dots, M_\beta - r_\alpha), \quad (3.2)$$

where each such choice is parametrized by a permutation matrix \mathcal{P}_β of order M_β . We denote the resultant theory as $(X, \{\mathcal{P}_\beta\})$.

- Given the theory $(X, \{\mathcal{P}_\beta\})$, we identify the flavor nodes $U(r_\alpha)_\beta$ for all $\beta \neq \alpha$ to the flavor node $U(r_\alpha)_\alpha$, as shown on the RHS of the figure below.

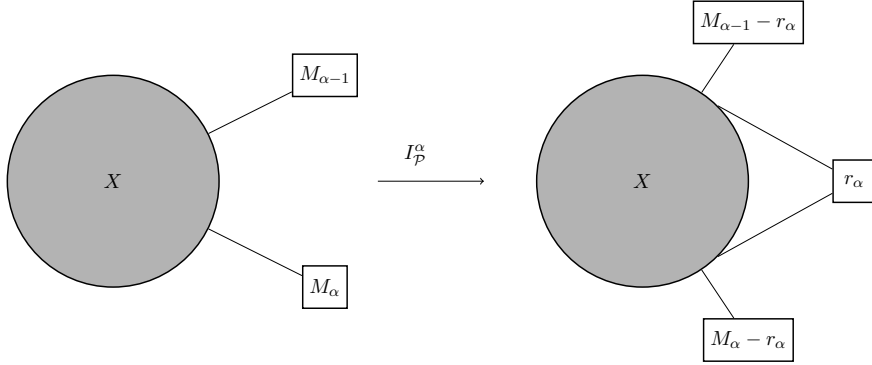

4. **Defect ($D_{\mathcal{P}}^\alpha$):** Given a $U(M_\alpha)$ flavor node of a quiver gauge theory X , the operation $D_{\mathcal{P}}^\alpha$ can be implemented at the node α in two steps:

- The theory (X, \mathcal{P}) is defined as above.
- A Type-A or Type-B defect is turned on for the flavor node $U(r_\alpha)$.

Definition. An elementary S -type operation $\mathcal{O}_{\mathcal{P}}^\alpha$ on X at a flavor node α , is defined by the action of any possible combination of the identification ($I_{\mathcal{P}}^\alpha$), the flavoring ($F_{\mathcal{P}}^\alpha$), and the defect ($D_{\mathcal{P}}^\alpha$) operations followed by a *single* gauging operation $G_{\mathcal{P}}^\alpha$.

$$\boxed{\mathcal{O}_{\mathcal{P}}^\alpha(X) := (G_{\mathcal{P}}^\alpha) \circ (D_{\mathcal{P}}^\alpha)^{n_3} \circ (F_{\mathcal{P}}^\alpha)^{n_2} \circ (I_{\mathcal{P}}^\alpha)^{n_1}(X), \quad (n_i = 0, 1, \forall i).} \quad (3.3)$$

In the special case where $G_{\mathcal{P}}^\alpha$ involves gauging a $U(1)$, we will refer to the corresponding S -type operation $\mathcal{O}_{\mathcal{P}}^\alpha$ as an *elementary Abelian S -type operation*. The order of the different constituent operations in the above definition is important to emphasize. The composition of the identification and the flavoring operations is commutative, while none of the operations commute with the gauging operation. For a Wilson defect, the defect operation also commutes with the identification and the flavoring operations. However, for a vortex defect, the defect operation may or may not commute with $F_{\mathcal{P}}^\alpha$ and $I_{\mathcal{P}}^\alpha$ – it depends on the details of the defect in question. In general, therefore, the order of the operations constituting $\mathcal{O}_{\mathcal{P}}^\alpha$ is important.

An elementary S -type operation $\mathcal{O}_{\mathcal{P}}^\alpha$, therefore, will map a quiver gauge theory X to a new quiver gauge theory X' , decorated by a defect D , i.e.

$$\mathcal{O}_{\mathcal{P}}^\alpha : X \mapsto X'[D]. \quad (3.4)$$

Given this operation, one can define a dual operation $\tilde{\mathcal{O}}_{\mathcal{P}}^\alpha$ which acts on the quiver gauge theory Y . The dual operation maps Y to a new theory Y' (not necessarily Lagrangian) decorated by a line defect D^\vee , i.e.

$$\tilde{\mathcal{O}}_{\mathcal{P}}^\alpha : Y \mapsto Y'[D^\vee], \quad (3.5)$$

such that the pair $(X'[D], Y'[D^\vee])$ is IR dual.

Let us now describe the realization of the operation $\mathcal{O}_{\mathcal{P}}^\alpha$ and its dual $\tilde{\mathcal{O}}_{\mathcal{P}}^\alpha$ in terms of a three-sphere partition function. For the dual pair (X, Y) , we denote as $(Y, \{\mathcal{P}_\beta\})$ the theory Y where the $U(1)^{r_\alpha} \times U(1)^{M_\beta - r_\alpha}$ (for all β) background twisted vector multiplets have been relabelled as given in (3.2). The partition function of the theory $(Y, \{\mathcal{P}_\beta\})$ has the form:

$$Z^{(Y, \{\mathcal{P}_\beta\})}(\mathbf{m}^Y(\boldsymbol{\eta}); \boldsymbol{\eta}^Y(\{\mathbf{u}^\beta\}, \{\mathbf{v}^\beta\}, \dots)) = \int \prod_{\gamma'} [d\boldsymbol{\sigma}^{\gamma'}] Z_{\text{int}}^{(Y, \{\mathcal{P}_\beta\})}(\{\boldsymbol{\sigma}^{\gamma'}\}, \mathbf{m}^Y(\boldsymbol{\eta}), \boldsymbol{\eta}^Y(\{\mathbf{u}^\beta\}, \dots)), \quad (3.6)$$

where γ' labels the gauge nodes of the theory Y , and $\mathbf{m}^Y, \boldsymbol{\eta}^Y$ denote the masses and FI parameters. Mirror symmetry implies that the partition functions of X and Y are related as:

$$Z^{(X, \{\mathcal{P}_\beta\})}(\{\mathbf{u}^\beta\}, \{\mathbf{v}^\beta\}, \dots; \boldsymbol{\eta}) = e^{2\pi i \sum_{i, l, \beta} b_\beta^{il} u_i^\beta \eta_l} \cdot C_{XY}(\{\mathbf{u}^\beta = 0\}, \dots, \boldsymbol{\eta}) \cdot Z^{(Y, \{\mathcal{P}_\beta\})}(\mathbf{m}^Y; \boldsymbol{\eta}^Y), \quad (3.7)$$

where b_β^{il} has integer entries, and C_{XY} is defined in (2.28). We will now address the two cases, where $\mathcal{O}_{\mathcal{P}}^\alpha$ doesn't and does involve defect operations, separately.

S-operation not involving a defect operation

In this case, the partition function of the theory $X' = \mathcal{O}_{\mathcal{P}}^\alpha(X)$ is given as

$$Z^{\mathcal{O}_{\mathcal{P}}^\alpha(X)}(\mathbf{m}^{\mathcal{O}_{\mathcal{P}}^\alpha}, \dots; \boldsymbol{\eta}, \eta_\alpha) = \int [d\mathbf{u}^\alpha] \mathcal{Z}_{\mathcal{O}_{\mathcal{P}}^\alpha(X)}(\mathbf{u}^\alpha, \{\mathbf{u}^\beta\}_{\beta \neq \alpha}, \eta_\alpha, \mathbf{m}^{\mathcal{O}_{\mathcal{P}}^\alpha}) \cdot Z^{(X, \{\mathcal{P}_\beta\})}(\{\mathbf{u}^\beta\}, \dots; \boldsymbol{\eta}), \quad (3.8)$$

where η_α is an FI parameter associated with gauging, and $\mathbf{m}^{\mathcal{O}_{\mathcal{P}}^\alpha}$ are hypermultiplet masses associated with flavoring and/or identification operations. The operator $\mathcal{Z}_{\mathcal{O}_{\mathcal{P}}^\alpha(X)}$ can be constituted from the partition function contributions of gauging ($G_{\mathcal{P}}^\alpha$), flavoring ($F_{\mathcal{P}}^\alpha$), and identification ($I_{\mathcal{P}}^\alpha$) operations as follows:

$$\mathcal{Z}_{\mathcal{O}_{\mathcal{P}}^\alpha(X)}(\mathbf{u}^\alpha, \{\mathbf{u}^\beta\}_{\beta \neq \alpha}, \eta_\alpha, \mathbf{m}^{\mathcal{O}_{\mathcal{P}}^\alpha}) = \mathcal{Z}_{G_{\mathcal{P}}^\alpha(X)} \cdot \left(\mathcal{Z}_{F_{\mathcal{P}}^\alpha(X)} \right)^{n_2} \cdot \left(\mathcal{Z}_{I_{\mathcal{P}}^\alpha(X)} \right)^{n_1}, \quad (n_1, n_2 = 0, 1), \quad (3.9)$$

where the individual constituents are:

$$\mathcal{Z}_{G_{\mathcal{P}}^\alpha(X)}(\mathbf{u}^\alpha, \eta_\alpha) = Z_{\text{FI}}(\mathbf{u}^\alpha, \eta_\alpha) Z_{1\text{-loop}}^{\text{vector}}(\mathbf{u}^\alpha) = e^{2\pi i \eta_\alpha \sum_i u_i^\alpha} \prod_{i < j} \sinh^2 \pi(u_i^\alpha - u_j^\alpha), \quad (3.10)$$

$$\mathcal{Z}_{F_{\mathcal{P}}^\alpha(X)}(\mathbf{u}^\alpha, \mathbf{m}_F^\alpha) = Z_{1\text{-loop}}^{\text{hyper}}(\mathbf{u}^\alpha, \mathbf{m}_F^\alpha) = \prod_{\rho(\mathcal{R}_\alpha)} \frac{1}{\cosh \pi \rho(\mathbf{u}^\alpha, \mathbf{m}_F^\alpha)}, \quad (3.11)$$

$$\mathcal{Z}_{I_{\mathcal{P}}^\alpha(X)}(\mathbf{u}^\alpha, \{\mathbf{u}^\beta\}, \boldsymbol{\mu}) = \int \prod_{j=1}^p \prod_{i=1}^{r_\alpha} du^{\gamma_j}_i \prod_{j=1}^p \delta^{(r_\alpha)}(\mathbf{u}^\alpha - \mathbf{u}^{\gamma_j} + \boldsymbol{\mu}^{\gamma_j}). \quad (3.12)$$

The partition function of the dual theory $Y' = \tilde{\mathcal{O}}_{\mathcal{P}}^\alpha(Y)$ can be computed in the following fashion. First, one can isolate the \mathbf{u}^β -dependent part of the matrix model integrand of the theory $(Y, \{\mathcal{P}_\beta\})$, i.e.

$$\frac{Z_{\text{int}}^{(Y, \{\mathcal{P}_\beta\})}(\{\boldsymbol{\sigma}^{\gamma'}\}, \mathbf{m}^Y(\boldsymbol{\eta}), \boldsymbol{\eta}^Y(\{\mathbf{u}^\beta\}, \dots))}{Z_{\text{int}}^{(Y, \{\mathcal{P}_\beta\})}(\{\boldsymbol{\sigma}^{\gamma'}\}, \mathbf{m}^Y(\boldsymbol{\eta}), \boldsymbol{\eta}^Y(\{\mathbf{u}^\beta = 0\}, \dots))} = e^{2\pi i \sum_{i, \beta} g_\beta^i(\{\boldsymbol{\sigma}^{\gamma'}\}, \mathcal{P}_\beta) u_i^\beta}, \quad (3.13)$$

where g_β^i is a set of linear functions of its arguments and is entirely determined by the mirror map of mass and FI parameters for the dual pair (X, Y) . The IR duality, along with the assumption that both $\mathcal{O}_{\mathcal{P}}^\alpha(X)$ and $\tilde{\mathcal{O}}_{\mathcal{P}}^\alpha(Y)$ are good theories, will imply that the two partition functions are related as

$$Z^{\mathcal{O}_{\mathcal{P}}^\alpha(X)}(\mathbf{m}^{\mathcal{O}_{\mathcal{P}}^\alpha}, \dots; \boldsymbol{\eta}, \eta_\alpha) = Z^{\tilde{\mathcal{O}}_{\mathcal{P}}^\alpha(Y)}(\mathbf{m}'(\boldsymbol{\eta}, \eta_\alpha); \boldsymbol{\eta}'(\mathbf{m}^{\mathcal{O}_{\mathcal{P}}^\alpha}, \dots)), \quad (3.14)$$

up to some contact terms, where $(\mathbf{m}, \boldsymbol{\eta})$ and $(\mathbf{m}', \boldsymbol{\eta}')$ collectively denote the $\mathcal{N} = 4$ preserving masses and FI parameters of $\mathcal{O}_{\mathcal{P}}^\alpha(X)$ and $\tilde{\mathcal{O}}_{\mathcal{P}}^\alpha(Y)$ respectively. From (3.14) and (3.8), using (3.7)-(3.6) and changing the order of integration, the partition function of the

dual theory can then be cast in the form:

$$\begin{aligned}
\mathcal{Z}_{\tilde{\mathcal{O}}_{\mathcal{P}}^{\alpha}(Y)}(\mathbf{m}'; \boldsymbol{\eta}') &= \int \prod_{\gamma'} [d\boldsymbol{\sigma}^{\gamma'}] \mathcal{Z}_{\tilde{\mathcal{O}}_{\mathcal{P}}^{\alpha}(Y)}(\{\boldsymbol{\sigma}^{\gamma'}\}, \mathbf{m}^{\mathcal{O}_{\mathcal{P}}^{\alpha}}, \eta_{\alpha}, \boldsymbol{\eta}) \cdot C_{XY}(\{\mathbf{u}^{\beta} = 0\}, \dots, \boldsymbol{\eta}) \\
&\quad \times \mathcal{Z}_{\text{int}}^{(Y, \{\mathcal{P}_{\beta}\})}(\{\boldsymbol{\sigma}^{\gamma'}\}, \mathbf{m}^Y(\boldsymbol{\eta}), \boldsymbol{\eta}^Y(\{\mathbf{u}^{\beta} = 0\}, \dots)),
\end{aligned}
\tag{3.15}$$

where $\mathbf{m}' = \mathbf{m}'(\boldsymbol{\eta}, \eta_{\alpha})$, $\boldsymbol{\eta}' = \boldsymbol{\eta}'(\mathbf{m}^{\mathcal{O}_{\mathcal{P}}^{\alpha}}, \dots)$, and the function $\mathcal{Z}_{\tilde{\mathcal{O}}_{\mathcal{P}}^{\alpha}(Y)}$ can be formally written as a Fourier-transform of the operator $\mathcal{Z}_{\mathcal{O}_{\mathcal{P}}^{\alpha}(X)}$:

$$\mathcal{Z}_{\tilde{\mathcal{O}}_{\mathcal{P}}^{\alpha}(Y)} = \int [d\mathbf{u}^{\alpha}] \mathcal{Z}_{\mathcal{O}_{\mathcal{P}}^{\alpha}(X)}(\mathbf{u}^{\alpha}, \{\mathbf{u}^{\beta}\}_{\beta \neq \alpha}, \eta_{\alpha}, \mathbf{m}^{\mathcal{O}_{\mathcal{P}}^{\alpha}}) \cdot e^{2\pi i \sum_{i, \beta} (g_{\beta}^i(\{\boldsymbol{\sigma}^{\gamma'}\}, \mathcal{P}_{\beta}) + \sum_l b_{\beta}^{il} \eta_l) u_i^{\beta}},
\tag{3.16}$$

where g_{β}^i is the set of functions defined above, and b_{β}^{il} are integers defined in (3.7). The expressions (3.15)-(3.16) give a working definition of the dual of the S -type operation on the theory Y . Note that although the RHS of (3.15) is written as an operation on a Lagrangian theory Y , the theory Y' is not guaranteed to be Lagrangian. However, if Y' is Lagrangian, one can rewrite the RHS of (3.15) in the standard form of (2.23), from which the gauge group and matter content of the theory can be easily read off. The contact term involved can also be read off from (3.15).

S -operation involving a defect operation

In this case, we will need to distinguish between the vortex and the Wilson defects to write down concrete formulae. For the Wilson defects, the partition function of the theory $X' = \mathcal{O}_{\mathcal{P}}^{\alpha}(X)$ is given by (3.8), where the operator $\mathcal{Z}_{\mathcal{O}_{\mathcal{P}}^{\alpha}(X)}$ can be constructed in the following fashion:

$$\mathcal{Z}_{\mathcal{O}_{\mathcal{P}}^{\alpha}(X)}(\mathbf{u}^{\alpha}, \{\mathbf{u}^{\beta}\}_{\beta \neq \alpha}, \eta_{\alpha}, \mathbf{m}^{\mathcal{O}_{\mathcal{P}}^{\alpha}} | R') = \mathcal{Z}_{G_{\mathcal{P}}^{\alpha}(X)} \cdot \left(\mathcal{Z}_{D_{\mathcal{P}}^{\alpha}(X)} \right) \cdot \left(\mathcal{Z}_{F_{\mathcal{P}}^{\alpha}(X)} \right)^{n_2} \cdot \left(\mathcal{Z}_{I_{\mathcal{P}}^{\alpha}(X)} \right)^{n_1},
\tag{3.17}$$

$$\mathcal{Z}_{D_{\mathcal{P}}^{\alpha}(X)}(\mathbf{u}^{\alpha}) = Z_{\text{Wilson}}(\mathbf{u}^{\alpha}, R') = \text{Tr}_{R'} e^{2\pi i \mathbf{u}^{\alpha}},
\tag{3.18}$$

where $n_i = 0, 1, \forall i$, and the contribution of the defect to the partition function depends on \mathbf{u}^{α} and the representation R' . The resultant theory is the quiver X' with a Wilson defect insertion. The dual theory will involve the quiver Y' with a vortex defect insertion and its partition function will be given by (3.15)-(3.16), with the operator $\mathcal{Z}_{\mathcal{O}_{\mathcal{P}}^{\alpha}}$ given by the expression in (3.17).

As discussed earlier, vortex defects are realized by coupled 3d-1d systems. We will consider defects where the associated (2,2) SQM Σ' generically couples to both the new gauge node and the new flavor node. The action of an S -type operation $\mathcal{O}_{\mathcal{P}}^{\alpha}$, involving

a vortex defect, on the quiver X gives the theory X' with a vortex defect insertion. Its partition function can be written as:

$$\begin{aligned} Z^{\mathcal{O}_{\mathcal{P}}^\alpha(X)}(\mathbf{m}^{\mathcal{O}_{\mathcal{P}}^\alpha}, \dots; \boldsymbol{\eta}, \eta_\alpha) &= \lim_{z \rightarrow 1} \int [d\mathbf{u}^\alpha] \mathcal{Z}_{\mathcal{O}_{\mathcal{P}}^\alpha(X)}(\mathbf{u}^\alpha, \{\mathbf{u}^\beta\}_{\beta \neq \alpha}, \eta_\alpha, \mathbf{m}^{\mathcal{O}_{\mathcal{P}}^\alpha}, z | \Sigma') \\ &\quad \times Z^{(X, \{\mathcal{P}_\beta\})}(\{\mathbf{u}^\beta\}, \dots; \boldsymbol{\eta}), \end{aligned} \quad (3.19)$$

where the expression on the RHS is computed by the analytic continuation procedure as before. In this case, the operator $\mathcal{Z}_{\mathcal{O}_{\mathcal{P}}^\alpha(X)}$ can be constructed in the following fashion:

$$\mathcal{Z}_{\mathcal{O}_{\mathcal{P}}^\alpha(X)}(\mathbf{u}^\alpha, \{\mathbf{u}^\beta\}_{\beta \neq \alpha}, \eta_\alpha, \mathbf{m}^{\mathcal{O}_{\mathcal{P}}^\alpha}, z | \Sigma') = \mathcal{Z}_{G_{\mathcal{P}}^\alpha(X)} \cdot \left(\mathcal{Z}_{D_{\mathcal{P}}^\alpha(X)} \right) \cdot \left(\mathcal{Z}_{F_{\mathcal{P}}^\alpha(X)} \right)^{n_2} \cdot \left(\mathcal{Z}_{I_{\mathcal{P}}^\alpha(X)} \right)^{n_1}, \quad (3.20)$$

$$\mathcal{Z}_{D_{\mathcal{P}}^\alpha(X)}(\mathbf{u}^\alpha, \mathbf{m}_F^\alpha, \eta_\alpha, z) = W_{\text{b.g.}}(\eta_\alpha, \boldsymbol{\eta}) \cdot \mathcal{I}^{\Sigma'}(\mathbf{u}^\alpha, \mathbf{m}_F^\alpha, z | \boldsymbol{\xi}'), \quad (3.21)$$

where $n_i = 0, 1, \forall i$. In the above expression, $\mathcal{I}^{\Sigma'}$ is the Witten index of the SQM Σ' for a certain choice of the signs of the 1d FI parameters $\boldsymbol{\xi}'$, which is needed to specify the data of the 3d defect completely. The dual theory will involve the quiver Y' with a Wilson defect insertion. The dual defect partition function, following the same logic as before, will be given by an expression analogous to (3.15), i.e.

$$\begin{aligned} Z^{\tilde{\mathcal{O}}_{\mathcal{P}}^\alpha(Y)}(\mathbf{m}'; \boldsymbol{\eta}') &= \lim_{z \rightarrow 1} \int \prod_{\gamma'} [d\boldsymbol{\sigma}^{\gamma'}] \mathcal{Z}_{\tilde{\mathcal{O}}_{\mathcal{P}}^\alpha(Y)}(\{\boldsymbol{\sigma}^{\gamma'}\}, \mathbf{m}^{\mathcal{O}_{\mathcal{P}}^\alpha}, \eta_\alpha, \boldsymbol{\eta}, z) \cdot C_{XY}(\{\mathbf{u}^\beta = 0\}, \dots, \boldsymbol{\eta}) \\ &\quad \times Z_{\text{int}}^{(Y, \{\mathcal{P}_\beta\})}(\{\boldsymbol{\sigma}^{\gamma'}\}, \mathbf{m}^Y(\boldsymbol{\eta}), \boldsymbol{\eta}^Y(\{\mathbf{u}^\beta = 0\}, \dots)), \end{aligned}$$

(3.22)

where the function $\mathcal{Z}_{\tilde{\mathcal{O}}_{\mathcal{P}}^\alpha(Y)}(\{\boldsymbol{\sigma}^{\gamma'}\}, \mathbf{m}^{\mathcal{O}_{\mathcal{P}}^\alpha}, \eta_\alpha, \boldsymbol{\eta}, z)$ is related to the operator $\mathcal{Z}_{\mathcal{O}_{\mathcal{P}}^\alpha(X)}$ in (3.20)-(3.21) in the following fashion:

$$\mathcal{Z}_{\tilde{\mathcal{O}}_{\mathcal{P}}^\alpha(Y)} = \int [d\mathbf{u}^\alpha] \mathcal{Z}_{\mathcal{O}_{\mathcal{P}}^\alpha(X)}(\mathbf{u}^\alpha, \{\mathbf{u}^\beta\}_{\beta \neq \alpha}, \eta_\alpha, \mathbf{m}^{\mathcal{O}_{\mathcal{P}}^\alpha}, z | \Sigma') \cdot e^{2\pi i \sum_{i,\beta} (g_\beta^i(\{\boldsymbol{\sigma}^{\gamma'}\}, \mathcal{P}_\beta) + \sum_l b_\beta^l \eta_l) u_i^\beta}. \quad (3.23)$$

For a Lagrangian theory Y' , the Wilson defect can be read off from (3.22), after some straightforward change of variables.

Generic S -type operation

A generic S -type operation on the quiver gauge theory X is defined as the action of successive elementary S -type operations at nodes $\alpha_1, \alpha_2, \dots, \alpha_l$:

$$\mathcal{O}_{(\mathcal{P}_1, \dots, \mathcal{P}_l)}^{(\alpha_1, \dots, \alpha_l)}(X) := \mathcal{O}_{\mathcal{P}_l}^{\alpha_l} \circ \mathcal{O}_{\mathcal{P}_{l-1}}^{\alpha_{l-1}} \circ \dots \circ \mathcal{O}_{\mathcal{P}_2}^{\alpha_2} \circ \mathcal{O}_{\mathcal{P}_1}^{\alpha_1}(X). \quad (3.24)$$

The partition function of the theory $\mathcal{O}_{(\mathcal{P}_1, \dots, \mathcal{P}_l)}^{(\alpha_1, \dots, \alpha_l)}(X)$ is given by using (3.8) (or (3.19) for operations with vortex defects) iteratively, while the partition function of the dual theory

$\tilde{\mathcal{O}}_{(\mathcal{P}_1, \dots, \mathcal{P}_l)}^{(\alpha_1, \dots, \alpha_l)}(Y)$ is given by using the formula (3.15)-(3.16) (or (3.22)-(3.23) for operators with vortex defects) iteratively.

Starting from a pair of dual linear quiver gauge theories, where the mirror map between the mass and FI parameters are known, one can generate new dual pairs of theories (with or without defects) by a sequence of elementary S -type operations.

3.2 Abelianization of the non-Abelian S -type operation

One of the important results obtained in [1] was that the action of an Abelian S -type operation (consisting of a sequence of elementary operations) on a pair of dual quiver gauge theories (X, Y) produces another dual pair of demonstrably Lagrangian theories (X', Y') . This procedure is substantially harder to implement if the S -type operation in question is non-Abelian⁶. However, at the level of the three-sphere partition function, an elementary non-Abelian S -type operation (which does not include any defect operation) can be written in terms of a set of Abelian S -type operations, which involve certain Wilson defect operations. We will refer to this procedure as the *abelianization* of a non-Abelian S -type operation. We would like to emphasize that this procedure should be thought of as a convenient way of writing the matrix model integral for the sphere partition function, and not as a QFT operation. In particular, this procedure does not extend naturally to other supersymmetric observable, like the 3d superconformal index.

For concreteness, we will discuss the procedure in detail for the case of a gauging operation. The argument can be readily extended to the other elementary operations, i.e. flavoring-gauging, identification-gauging, and identification-flavoring-gauging operations with/without defects.

Consider the action of an elementary gauging operation on a quiver gauge theory X at a flavor node α . From equations (3.9) -(3.10), the partition function of the theory $G_{\mathcal{P}}^\alpha(X)$ is given as

$$\begin{aligned} Z^{G_{\mathcal{P}}^\alpha(X)}(\mathbf{v}^\alpha, \dots; \boldsymbol{\eta}, \eta_\alpha) &= \frac{1}{|\mathcal{W}_\alpha|} \int \prod_{i=1}^{r_\alpha} du_i^\alpha Z_{\text{FI}}(\mathbf{u}^\alpha, \eta_\alpha) Z_{1\text{-loop}}^{\text{vector}}(\mathbf{u}^\alpha) Z^{(X, \mathcal{P})}(\mathbf{u}^\alpha, \mathbf{v}^\alpha \dots; \boldsymbol{\eta}), \\ &= \frac{1}{r_\alpha!} \int \prod_{i=1}^{r_\alpha} du_i^\alpha e^{2\pi i \eta_\alpha \sum_i u_i^\alpha} \prod_{i < j} \sinh^2 \pi(u_i^\alpha - u_j^\alpha) Z^{(X, \mathcal{P})}(\mathbf{u}^\alpha, \mathbf{v}^\alpha \dots; \boldsymbol{\eta}). \end{aligned} \quad (3.25)$$

Recall the following identity,

$$\prod_{i < j} 2 \sinh \pi(u_i^\alpha - u_j^\alpha) = \sum_{\rho \in \mathcal{S}_{r_\alpha}} (-1)^\rho e^{2\pi \omega_{r_\alpha}^{(\rho)} \cdot \mathbf{u}^\alpha}, \quad (3.26)$$

where \mathcal{S}_N is the permutation group of N distinct objects, $\omega_N =: \left(\frac{N-1}{2}, \frac{N-3}{2}, \dots, -\frac{N-1}{2} \right)$, and $\omega_N^{(\rho)}$ denotes a vector whose entries are obtained from those of ω_N by an action of an

⁶In general, there is no guarantee that the dual of a non-Abelian operation produces a Lagrangian theory, in contrast to the Abelian operation.

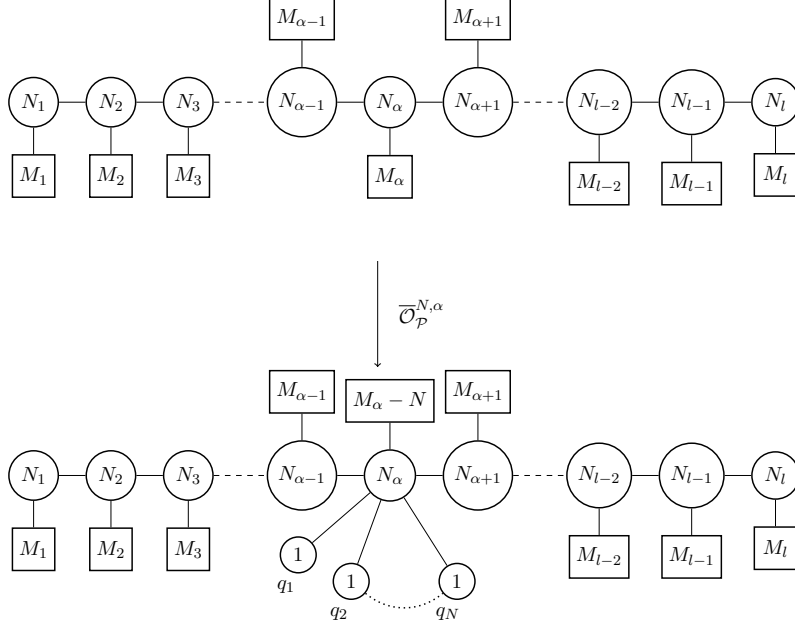

Figure 17: Construction of the theory $\bar{\mathcal{O}}_{\mathcal{P}}^{N,\alpha}(X)$ for a linear quiver gauge theory X .

element $\rho \in \mathcal{S}_N$. Using this identity, the partition function can be written as

$$\begin{aligned}
Z^{G_{\mathcal{P}}^{\alpha}(X)}(\mathbf{v}^{\alpha}, \dots; \boldsymbol{\eta}, \eta_{\alpha}) &= \frac{1}{r_{\alpha}!} \sum_{\rho, \rho'} (-1)^{\rho+\rho'} \int \prod_{i=1}^{r_{\alpha}} du_i^{\alpha} e^{2\pi i \eta_{\alpha} \sum_i u_i^{\alpha}} e^{2\pi(\omega_{r_{\alpha}}^{(\rho)} + \omega_{r_{\alpha}}^{(\rho')}) \cdot \mathbf{u}^{\alpha}} Z^{(X, \mathcal{P})}(\mathbf{u}^{\alpha}, \mathbf{v}^{\alpha} \dots; \boldsymbol{\eta}) \\
&= \frac{1}{r_{\alpha}!} \sum_{\rho, \rho'} (-1)^{\rho+\rho'} \int \prod_{i=1}^{r_{\alpha}} du_i^{\alpha} \left(\prod_{i=1}^{r_{\alpha}} e^{2\pi i \eta_{\alpha} u_i^{\alpha}} e^{2\pi \Omega_{(\rho, \rho')}^i u_i^{\alpha}} \right) Z^{(X, \mathcal{P})}(\mathbf{u}^{\alpha}, \mathbf{v}^{\alpha} \dots; \boldsymbol{\eta}),
\end{aligned} \tag{3.27}$$

where the vector $\Omega_{(\rho, \rho')} = \omega_{r_{\alpha}}^{(\rho)} + \omega_{r_{\alpha}}^{(\rho')}$, with $\rho, \rho' \in \mathcal{S}_{\rho_{\alpha}}$. The last equation can be rewritten as

$$Z^{G_{\mathcal{P}}^{\alpha}(X)} = \frac{1}{r_{\alpha}!} \sum_{\rho, \rho'} (-1)^{\rho+\rho'} \int \prod_{i=1}^{r_{\alpha}} du_i^{\alpha} \left(\prod_{i=1}^{r_{\alpha}} Z_{\text{FI}}(u_i^{\alpha}, \eta_{\alpha}) Z_{\text{Wilson}}(u_i^{\alpha}, \Omega_{(\rho, \rho')}^i) \right) Z^{(X, \mathcal{P})}(\mathbf{u}^{\alpha}, \mathbf{v}^{\alpha} \dots; \boldsymbol{\eta}), \tag{3.28}$$

where $Z_{\text{Wilson}}(u_i^{\alpha}, \Omega_{(\rho, \rho')}^i)$ is the partition function contribution of an Abelian Wilson defect of charge $\Omega_{(\rho, \rho')}^i$ for a $U(1)$ gauge group parametrized by u_i^{α} .

To write it more clearly, let $\bar{\mathcal{O}}_{\mathcal{P}}^{\beta}$ denote a defect-gauging Abelian elementary S -type operation at a given node β of X :

$$\bar{\mathcal{O}}_{\mathcal{P}}^{\beta} = G_{\mathcal{P}}^{\beta} \circ \mathcal{D}_{\mathcal{P}}^{\beta}(X), \tag{3.29}$$

where the defect operation involves turning on an Abelian Wilson line of charge q for the $U(1)$ flavor node in $U(M_{\beta}) \rightarrow U(1) \times U(M_{\beta} - 1)$, and is followed by gauging the $U(1)$

flavor symmetry. Let us define the S -type operation $\overline{\mathcal{O}}_{\mathcal{P}}^{N,\beta}(X)$:

$$\overline{\mathcal{O}}_{\mathcal{P}}^{N,\beta}(X) =: \overline{\mathcal{O}}_{\mathcal{P}_N}^{\beta_N} \circ \overline{\mathcal{O}}_{\mathcal{P}_{N-1}}^{\beta_{N-1}} \circ \dots \circ \overline{\mathcal{O}}_{\mathcal{P}_1}^{\beta_1}(X), \quad (3.30)$$

such that $\beta_1 = \beta$, β_2 corresponds to the flavor node $U(M_\beta - 1)$, β_3 corresponds to the flavor node $U(M_\beta - 2)$, and so on, and the Abelian defect charge introduced in the i -th step is q^i . Also, \mathcal{P} denotes the effective permutation matrix which determines the choice of $U(1)^N$ mass parameters from the original $U(1)^{M_\beta}$ mass parameters. For a linear quiver X , the quiver operation is shown in Fig. 17. The partition function of $\overline{\mathcal{O}}_{\mathcal{P}}^{N,\beta}(X)$ is therefore given in terms of the partition function of X as :

$$Z^{\overline{\mathcal{O}}_{\mathcal{P}}^{N,\beta}(X)}(\mathbf{v}^\beta, \dots; \boldsymbol{\eta}, \boldsymbol{\eta}_\beta | \mathbf{q}) = \int \frac{\prod_{i=1}^N du_i^\beta}{N!} \prod_{i=1}^N Z_{\text{FI}}(u_i^\beta, \eta_\beta^i) Z_{\text{Wilson}}(u_i^\beta, q^i) Z^{(X,\mathcal{P})}(\mathbf{u}^\beta, \mathbf{v}^\beta \dots; \boldsymbol{\eta}), \quad (3.31)$$

where $\{\eta_\beta^i\}_{i=1,\dots,N}$ denote the FI parameters associated with N Abelian gauging operations. The partition function of the theory $G_{\mathcal{P}}^\alpha(X)$, as given in (3.28), can then be written as:

$$Z^{G_{\mathcal{P}}^\alpha(X)} = \sum_{\rho, \rho'} (-1)^{\rho+\rho'} Z^{\overline{\mathcal{O}}_{\mathcal{P}}^{\alpha,\alpha}(X)}(\mathbf{v}^\alpha, \dots; \boldsymbol{\eta}, \eta_\alpha | \boldsymbol{\Omega}_{(\rho, \rho')}), \quad (3.32)$$

where the FI parameters associated with the r_α Abelian gauging operations are identical, and set equal to η_α . We would like to emphasize that all terms in the sum correspond to the partition function of the same Lagrangian theory (i.e. with the same gauge group and matter content) and differ only in the precise Wilson defect for the r_α $U(1)$ gauge nodes.

3.3 Elementary S -type operations on theories with defects

In this section, we discuss the action of S -type operations on quiver gauge theories with half-BPS defects. Let $X[\mathcal{D}]$ denote the quiver gauge theory X in class \mathcal{U} , decorated by a line defect \mathcal{D} of Type-A (Type-B). Also, let $Y[\mathcal{D}^\vee]$ denote the mirror dual quiver gauge theory Y , decorated by the dual line defect \mathcal{D}^\vee of Type-B (Type-A). Relabelling the mass parameters of $X[\mathcal{D}]$ as in (3.2), we denote the resultant theory as $(X[\mathcal{D}], \{P_\beta\})$. The mirror, with the relabelled FI parameters, will be denoted as $(Y[\mathcal{D}^\vee], \{P_\beta\})$. We will treat the two cases – \mathcal{D} being a vortex and a Wilson defect, separately.

Vortex defect \mathcal{D}

Let $\mathcal{D} = V_{R(G)}^\Sigma$ denote the vortex defect in a representation R of the gauge group G for the theory X , which is realized by a specific 3d-1d system Σ . The partition function of the coupled 3d-1d quiver is given by:

$$Z^{(X[V_{R(G)}^\Sigma], \{P_\beta\})}(\{\mathbf{u}^\beta\}, \dots; \boldsymbol{\eta}) = \lim_{z \rightarrow 1} \int [d\mathbf{s}] Z_{\text{int}}^{(X[V_{R(G)}^\Sigma], \{P_\beta\})}(\mathbf{s}, \{\mathbf{u}^\beta\}, \dots, \boldsymbol{\eta}, z) \quad (3.33)$$

$$=: \lim_{z \rightarrow 1} Z^{(X[V_{R(G)}^\Sigma], \{P_\beta\})}(\{\mathbf{u}^\beta\}, \dots; \boldsymbol{\eta} | z), \quad (3.34)$$

where the precise form of the function $Z_{\text{int}}^{(X[V_{R(G)}^\Sigma], \{P_\beta\})}$ can be read off from the general formula (2.44):

$$Z_{\text{int}}^{(X[V_{R(G)}^\Sigma], \{P_\beta\})} = W_{\text{b.g.}}(\boldsymbol{\eta}) Z_{\text{int}}^{(X, \{P_\beta\})}(\mathbf{s}, \{\mathbf{u}^\beta\}, \dots, \boldsymbol{\eta}) \mathcal{I}^\Sigma(\mathbf{s}, \{\mathbf{u}^\beta\}, \dots, z|\boldsymbol{\xi}). \quad (3.35)$$

The action of an S -type operation on the 3d-1d quiver $X[\mathcal{D}]$ at a flavor node α gives a new 3d-1d quiver $X'[\mathcal{D}']$:

$$\mathcal{O}_{\mathcal{P}}^\alpha : X[\mathcal{D}] \mapsto X'[\mathcal{D}']. \quad (3.36)$$

Let us first consider the case where $\mathcal{O}_{\mathcal{P}}^\alpha$ does not involve any defect operation. In this case, the S -operation is realized at the level of the partition function as follows:

$$\begin{aligned} Z_{\mathcal{P}}^{\mathcal{O}_\alpha(X[\mathcal{D}])}(\mathbf{m}^{\mathcal{O}_\alpha}, \dots; \boldsymbol{\eta}, \eta_\alpha) &=: Z^{(X'[\mathcal{D}'])}(\mathbf{m}^{\mathcal{O}_\alpha}, \dots; \boldsymbol{\eta}, \eta_\alpha) \\ &= \lim_{z \rightarrow 1} \int [d\mathbf{u}^\alpha] \mathcal{Z}_{\mathcal{O}_\alpha(X)}(\mathbf{u}^\alpha, \{\mathbf{u}^\beta\}_{\beta \neq \alpha}, \eta_\alpha, \mathbf{m}^{\mathcal{O}_\alpha}) \cdot Z^{(X[\mathcal{D}], \{P_\beta\})}(\{\mathbf{u}^\beta\}, \dots; \boldsymbol{\eta}|z), \end{aligned}$$

(3.37)

where the operator $\mathcal{Z}_{\mathcal{O}_\alpha(X)}$ is constructed from (3.9), and $Z^{(X[\mathcal{D}], \{P_\beta\})}(\dots|z)$ is defined in (3.34). The new 3d-1d system $X'[\mathcal{D}']$ can be read off from the matrix model formula in the second line. Note that the RHS of the above formula should be computed using the analytic continuation prescription for $z \in i\mathbb{R}$, and taking the $z \rightarrow 1$ limit in the final step.

Now, consider the case where the operation $\mathcal{O}_{\mathcal{P}}^\alpha$ involves a defect operation D , which needs to be of Type-A, so that the combined 3d-1d system still preserves the subalgebra SQM_A . Let $D = V_{R'(U(r_\alpha))}^{\Sigma'}$ denote a vortex defect in a representation R' of $U(r_\alpha)$ realized by a 3d-1d system Σ' . Then, the map (3.36) can be realized at the level of the partition function as follows:

$$\begin{aligned} Z_{\mathcal{P}}^{\mathcal{O}_\alpha(X[\mathcal{D}])}(\mathbf{m}^{\mathcal{O}_\alpha}, \dots; \boldsymbol{\eta}, \eta_\alpha) &=: Z^{(X'[\mathcal{D}'])}(\mathbf{m}^{\mathcal{O}_\alpha}, \dots; \boldsymbol{\eta}, \eta_\alpha) \\ &= \lim_{z \rightarrow 1} \int [d\mathbf{u}^\alpha] \mathcal{Z}_{\mathcal{O}_\alpha(X)}(\mathbf{u}^\alpha, \{\mathbf{u}^\beta\}_{\beta \neq \alpha}, \eta_\alpha, \mathbf{m}^{\mathcal{O}_\alpha}, z|\Sigma') \cdot Z^{(X[\mathcal{D}], \{P_\beta\})}(\{\mathbf{u}^\beta\}, \dots, \boldsymbol{\eta}|z), \end{aligned}$$

(3.38)

where the $\mathcal{Z}_{\mathcal{O}_\alpha(X)}$ operator is given in (3.20), and the function $Z_{\text{int}}^{(X[V_{R(G)}^\Sigma], \{P_\beta\})}$ is given in (3.34). As before, the new 3d-1d system $X'[\mathcal{D}']$ can be read off from the matrix model formula in the second line.

Wilson defect \mathcal{D}

Let $\mathcal{D} = W_{R(G)}$ denote the vortex defect in a representation R of the gauge group G for the theory X . The defect partition function has the following form:

$$Z^{(X[W_{R(G)}], \{P_\beta\})}(\{\mathbf{u}^\beta\}, \dots; \boldsymbol{\eta}) = \int [ds] Z_{\text{int}}^{(X[W_{R(G)}], \{P_\beta\})}(\mathbf{s}, \{\mathbf{u}^\beta\}, \dots, \boldsymbol{\eta}), \quad (3.39)$$

where the function $Z_{\text{int}}^{(X[W_{R(G)}], \{P_\beta\})}$ can be read off from (2.31):

$$Z_{\text{int}}^{(X[W_{R(G)}], \{P_\beta\})} = Z_{\text{int}}^{(X, \{P_\beta\})}(\mathbf{s}, \{\mathbf{u}^\beta\}, \dots, \boldsymbol{\eta}) Z_{\text{Wilson}}(\mathbf{s}, R). \quad (3.40)$$

The action of an S -type defect on a 3d quiver with a Wilson defect $X[\mathcal{D}]$ produces another 3d quiver with a Wilson defect $X'[\mathcal{D}']$, i.e.

$$\mathcal{O}_{\mathcal{P}}^\alpha : X[\mathcal{D}] \mapsto X'[\mathcal{D}']. \quad (3.41)$$

For an S -type operation $\mathcal{O}_{\mathcal{P}}^\alpha$ which does not involve a defect operation, the operation is realized at the level of the partition function as follows:

$$\begin{aligned} Z^{\mathcal{O}_{\mathcal{P}}^\alpha(X[\mathcal{D}])}(\mathbf{m}^{\mathcal{O}_{\mathcal{P}}^\alpha}, \dots; \boldsymbol{\eta}, \eta_\alpha) &=: Z^{(X'[\mathcal{D}'])}(\mathbf{m}^{\mathcal{O}_{\mathcal{P}}^\alpha}, \dots; \boldsymbol{\eta}, \eta_\alpha) \\ &= \int [d\mathbf{u}^\alpha] \mathcal{Z}_{\mathcal{O}_{\mathcal{P}}^\alpha(X)}(\mathbf{u}^\alpha, \{\mathbf{u}^\beta\}_{\beta \neq \alpha}, \eta_\alpha, \mathbf{m}^{\mathcal{O}_{\mathcal{P}}^\alpha}) \cdot Z^{(X[\mathcal{D}], \{P_\beta\})}(\{\mathbf{u}^\beta\}, \dots; \boldsymbol{\eta}), \end{aligned} \quad (3.42)$$

where the operator $\mathcal{Z}_{\mathcal{O}_{\mathcal{P}}^\alpha(X)}$ is constructed from (3.9), and the defect partition function $Z^{(X[\mathcal{D}], \{P_\beta\})}$ is defined in (3.39). The new 3d quiver with a Wilson defect $X'[\mathcal{D}']$ can be read off from the matrix model formula in the second line. For an S -type operation $\mathcal{O}_{\mathcal{P}}^\alpha$, which involves a Wilson defect $W_{R'(U(r_\alpha))}$ for the new gauge node $U(r_\alpha)$ in a representation R' , the above formula can be generalized to the following form:

$$\begin{aligned} Z^{\mathcal{O}_{\mathcal{P}}^\alpha(X[\mathcal{D}])}(\mathbf{m}^{\mathcal{O}_{\mathcal{P}}^\alpha}, \dots; \boldsymbol{\eta}, \eta_\alpha) &= Z^{(X'[\mathcal{D}'])}(\mathbf{m}^{\mathcal{O}_{\mathcal{P}}^\alpha}, \dots; \boldsymbol{\eta}, \eta_\alpha) \\ &= \int [d\mathbf{u}^\alpha] \mathcal{Z}_{\mathcal{O}_{\mathcal{P}}^\alpha(X)}(\mathbf{u}^\alpha, \{\mathbf{u}^\beta\}_{\beta \neq \alpha}, \eta_\alpha, \mathbf{m}^{\mathcal{O}_{\mathcal{P}}^\alpha} | R') \cdot Z^{(X[\mathcal{D}], \{P_\beta\})}(\{\mathbf{u}^\beta\}, \dots, \boldsymbol{\eta}), \end{aligned} \quad (3.43)$$

where the $\mathcal{Z}_{\mathcal{O}_{\mathcal{P}}^\alpha(X)}$ operator is given in (3.17), and the function $Z^{(X[\mathcal{D}], \{P_\beta\})}$ is given in (3.39).

To summarize: the action of an S -operation $\mathcal{O}_{\mathcal{P}}^\alpha$ involving a vortex defect operation D , on a 3d theory with a vortex defect $X[\mathcal{D}]$ is another 3d theory with a vortex defect $X'[\mathcal{D}']$, where \mathcal{D}' is a line defect built out of the pair of defects (D, \mathcal{D}) . Schematically, we can represent the action of the S -operation as:

$$\mathcal{O}_{\mathcal{P}}^\alpha : X[\mathcal{D}] \mapsto X'[\mathcal{D}'], \quad \mathcal{D}' = L(D, \mathcal{D}). \quad (3.44)$$

For the system to preserve the SQM_A or SQM_B supersymmetry, the line defects (D, \mathcal{D}) must be of the same type. The action can be realized at the level of the 3d partition function :

$$Z^{\mathcal{O}_{\mathcal{P}}^\alpha(X[\mathcal{D}])}(\mathbf{m}^{\mathcal{O}_{\mathcal{P}}^\alpha}, \dots; \boldsymbol{\eta}, \eta_\alpha) =: Z^{(X'[L(D, \mathcal{D})])}(\mathbf{m}^{\mathcal{O}_{\mathcal{P}}^\alpha}, \dots; \boldsymbol{\eta}, \eta_\alpha), \quad (3.45)$$

as discussed above in the individual cases, and the line defect $L(D, \mathcal{D})$ can be read off from the partition function expressions.

3.4 Dual operations and the new mirror map of defects

Let the theory dual to $X[\mathcal{D}]$ is denoted by $Y[\mathcal{D}^\vee]$, which is the quiver gauge theory Y decorated by a line defect \mathcal{D}^\vee of Type-A (Type-B), given that \mathcal{D} is of Type-B (Type-A). An S -type operation acts on a 3d quiver with a defect to give another 3d quiver with a defect, as given in (3.44). Given an operation $\mathcal{O}_{\mathcal{P}}^\alpha$ on $X[\mathcal{D}]$, one can define a dual operation on $Y[\mathcal{D}^\vee]$:

$$\tilde{\mathcal{O}}_{\mathcal{P}}^\alpha : Y[\mathcal{D}^\vee] \mapsto Y'[\mathcal{D}^{\vee\vee}], \quad \mathcal{D}^{\vee\vee} = L^\vee(\mathcal{D}^\vee, \mathcal{D}^\vee), \quad (3.46)$$

such that the pair $(X'[\mathcal{D}'], Y'[\mathcal{D}^{\vee\vee}])$ is IR dual. In this section, we discuss a systematic procedure to read off the dual line defect $L^\vee(\mathcal{D}^\vee, \mathcal{D}^\vee)$, and thereby write down the mirror map for the new defects L and L^\vee constructed above. As before, we will treat the case of a vortex defect and that of a Wilson defect, separately.

To begin with, the expectation values of the line defects in theory X and theory Y are generically related as follows:

$$\langle \mathcal{D} \rangle_X(\{\mathbf{u}^\beta\}, \dots; \boldsymbol{\eta}) = \langle \mathcal{D}^\vee \rangle_Y(\mathbf{m}^Y(\boldsymbol{\eta}); \boldsymbol{\eta}^Y(\{\mathbf{u}^\beta\}, \dots)), \quad (3.47)$$

which implies that the defect partition functions are related as follows:

$$Z^{(X[\mathcal{D}], \{P_\beta\})}(\{\mathbf{u}^\beta\}, \dots; \boldsymbol{\eta}) = C_{XY}(\{\mathbf{u}^\beta\}, \dots, \boldsymbol{\eta}) Z^{(Y[\mathcal{D}^\vee], \{P_\beta\})}(\mathbf{m}^Y(\boldsymbol{\eta}); \boldsymbol{\eta}^Y(\{\mathbf{u}^\beta\}, \dots)). \quad (3.48)$$

To work out the dual partition functions, we will need a slightly refined version of the above equality. Implementing the S -type operations involve performing integrals over $\{\mathbf{u}^\beta\}$ with an appropriate measure. Therefore, one needs to make sure that the limit $z \rightarrow 1$ is not taken trivially for any z -dependent term that involves a pole for the variables $\{\mathbf{u}^\beta\}$. This consideration is obviously not important for writing identities of the form (3.48), where the $\{\mathbf{u}^\beta\}$ are merely background gauge fields.

Let \mathcal{D} be a vortex defect and \mathcal{D}^\vee be a Wilson defect. In this case, the mirror symmetry implies a z -dependent equality:

$$\begin{aligned} Z^{(X[\mathcal{D}], \{P_\beta\})}(\{\mathbf{u}^\beta\}, \dots; \boldsymbol{\eta}|z) &= C_{XY}(\{\mathbf{u}^\beta\}, \dots, \boldsymbol{\eta}) Z^{(Y[\mathcal{D}^\vee], \{P_\beta\})}(\mathbf{m}^Y(\boldsymbol{\eta}); \boldsymbol{\eta}^Y(\{\mathbf{u}^\beta\}, \dots)|z) \\ &= C_{XY} \cdot \int \prod_{\gamma'} [d\boldsymbol{\sigma}^{\gamma'}] Z_{\text{int}}^{(Y[\mathcal{D}^\vee], \{P_\beta\})}(\{\boldsymbol{\sigma}^{\gamma'}\}, \mathbf{m}^Y(\boldsymbol{\eta}), \boldsymbol{\eta}^Y(\{\mathbf{u}^\beta\}, \dots), z), \end{aligned}$$

(3.49)

where the function $Z^{(X[\mathcal{D}], \{P_\beta\})}(\dots|z)$ is defined in (3.34) in terms of the vortex defect partition function. The function $Z^{(Y[\mathcal{D}^\vee], \{P_\beta\})}(\dots|z)$ has the property that it reduces to the Wilson defect partition function in the limit $z \rightarrow 1$, i.e.

$$\lim_{z \rightarrow 1} Z^{(Y[\mathcal{D}^\vee], \{P_\beta\})}(\mathbf{m}^Y(\boldsymbol{\eta}); \boldsymbol{\eta}^Y(\{\mathbf{u}^\beta\}, \dots)|z) = Z^{(Y[\mathcal{D}^\vee], \{P_\beta\})}(\mathbf{m}^Y(\boldsymbol{\eta}); \boldsymbol{\eta}^Y(\{\mathbf{u}^\beta\}, \dots)). \quad (3.50)$$

Similarly, for the case where \mathcal{D} is a Wilson defect and \mathcal{D}^\vee is a vortex defect, one can write a z -dependent equality of the same form as (3.49), where $Z^{(Y[\mathcal{D}^\vee], \{P_\beta\})}(\dots|z)$ is now defined by (3.34), and the function $Z^{(X[\mathcal{D}], \{P_\beta\})}(\dots|z)$ has the property that it reduces to the Wilson defect partition function in the limit $z \rightarrow 1$, i.e.

$$\lim_{z \rightarrow 1} Z^{(X[\mathcal{D}], \{P_\beta\})}(\{\mathbf{u}^\beta\}, \dots; \boldsymbol{\eta}|z) = Z^{(X[\mathcal{D}], \{P_\beta\})}(\{\mathbf{u}^\beta\}, \dots; \boldsymbol{\eta}). \quad (3.51)$$

Using the result (3.49), one can now write explicit formulae for the dual partition functions in the two cases.

Dual of a vortex defect

Let $\mathcal{D} = V_{R(G)}^\Sigma$ denote the vortex defect in a representation R of the gauge group G for the theory X , which is realized by a specific 3d-1d system Σ . The dual Wilson defect \mathcal{D}^\vee is of the generic form:

$$\mathcal{D}^\vee = \sum_{\kappa} c_{\kappa} \widetilde{W}_{\kappa}^{\text{flavor}} \cdot \widetilde{W}_{\widetilde{R}_{\kappa}(\widetilde{G})}, \quad (3.52)$$

where $\widetilde{W}_{\widetilde{R}_{\kappa}(\widetilde{G})}$ is a Wilson defect in a representation \widetilde{R}_{κ} of the gauge group \widetilde{G} of the theory Y , and $\widetilde{W}_{\kappa}^{\text{flavor}}$ is a flavor Wilson defect associated with the hypermultiplets. The requirement of IR duality for the pair $(X'[\mathcal{D}'], Y'[\mathcal{D}'^\vee])$ implies that the defect partition functions are related, up to certain contact terms, as follows:

$$Z^{\mathcal{O}_{\mathcal{P}}^\alpha(X'[\mathcal{D}'])}(\mathbf{m}^{\mathcal{O}_{\mathcal{P}}^\alpha}, \dots; \boldsymbol{\eta}, \eta_\alpha) = Z^{\widetilde{\mathcal{O}}_{\mathcal{P}}^\alpha(Y'[\mathcal{D}'^\vee])}(\mathbf{m}'(\boldsymbol{\eta}, \eta_\alpha); \boldsymbol{\eta}'(\mathbf{m}^{\mathcal{O}_{\mathcal{P}}^\alpha}, \dots)). \quad (3.53)$$

Consider the case where the S -type operation does not involve any defect operation. The operation is realized at the level of the partition function by (3.37). Using (3.37) and (3.53), along with the mirror symmetry relation (3.49) and changing the order of integration, the dual partition function is given by the following formula (up to certain contact terms):

$$\boxed{Z^{\widetilde{\mathcal{O}}_{\mathcal{P}}^\alpha(Y[\mathcal{D}^\vee])}(\mathbf{m}'; \boldsymbol{\eta}') = \sum_{\kappa} c_{\kappa} \lim_{z \rightarrow 1} \int \prod_{\gamma'} [d\boldsymbol{\sigma}^{\gamma'}] Z_{\widetilde{\mathcal{O}}_{\mathcal{P}}^\alpha(Y)}^{\kappa}(\{\boldsymbol{\sigma}^{\gamma'}\}, \mathbf{m}^{\mathcal{O}_{\mathcal{P}}^\alpha}, \eta_\alpha, \boldsymbol{\eta}) \cdot C_{XY}(\{\mathbf{u}^\beta = 0\}, \dots, \boldsymbol{\eta})} \\ \times Z_{\widetilde{W}_{\kappa}^{\text{flavor}}}(\mathbf{m}^Y(\boldsymbol{\eta})|z) \cdot Z_{\text{int}}^{(Y[\widetilde{W}_{\widetilde{R}_{\kappa}(\widetilde{G})}], \{P_\beta\})}(\{\boldsymbol{\sigma}^{\gamma'}\}, \mathbf{m}^Y(\boldsymbol{\eta}), \boldsymbol{\eta}^Y(\{\mathbf{u}^\beta = 0\}, \dots), z), \quad (3.54)$$

where the integrand $Z_{\text{int}}^{(Y[\widetilde{W}_{\widetilde{R}_{\kappa}(\widetilde{G})}], \{P_\beta\})}$ and the function $Z_{\widetilde{W}_{\kappa}^{\text{flavor}}}$ can be read off from the second line of (3.49). The functions $Z_{\widetilde{\mathcal{O}}_{\mathcal{P}}^\alpha(Y)}^{\kappa}$ are given by a formal Fourier transformation

of the operator $\mathcal{Z}_{\mathcal{O}_{\mathcal{P}}^\alpha(X)}$ defined in (3.9) :

$$\boxed{\mathcal{Z}_{\tilde{\mathcal{O}}_{\mathcal{P}}^\alpha(Y)}^\kappa = \int [d\mathbf{u}^\alpha] \mathcal{Z}_{\mathcal{O}_{\mathcal{P}}^\alpha(X)}(\mathbf{u}^\alpha, \{\mathbf{u}^\beta\}_{\beta \neq \alpha}, \eta_\alpha, \mathbf{m}^{\mathcal{O}_{\mathcal{P}}^\alpha}) \cdot e^{2\pi i \sum_{i,\beta} (g_\beta^i(\{\sigma^{\gamma'}\}, \mathcal{P}_\beta) + \sum_l b_\beta^{il} \eta_l) u_i^\beta}.}$$
(3.55)

If the dual theory Y' is Lagrangian, then the expression on the RHS of (3.54) can again be identified as the partition function of a quiver gauge theory Y' , decorated by a Wilson defect, which we can formally denote as $L^\vee(\mathbf{1}, \mathcal{D}^\vee)$. The formula (3.54) can be readily generalized to the case where the S -type operation involves a defect D , by simply replacing in the integrand:

$$\mathcal{Z}_{\tilde{\mathcal{O}}_{\mathcal{P}}^\alpha(Y)}^\kappa(\{\sigma^{\gamma'}\}, \mathbf{m}^{\mathcal{O}_{\mathcal{P}}^\alpha}, \eta_\alpha, \boldsymbol{\eta}) \rightarrow \mathcal{Z}_{\tilde{\mathcal{O}}_{\mathcal{P}}^\alpha(Y)}^\kappa(\{\sigma^{\gamma'}\}, \mathbf{m}^{\mathcal{O}_{\mathcal{P}}^\alpha}, \eta_\alpha, \boldsymbol{\eta}, z). \quad (3.56)$$

The latter functions are defined by the formal Fourier transform:

$$\mathcal{Z}_{\tilde{\mathcal{O}}_{\mathcal{P}}^\alpha(Y)}^\kappa = \int [d\mathbf{u}^\alpha] \mathcal{Z}_{\mathcal{O}_{\mathcal{P}}^\alpha(X)}(\mathbf{u}^\alpha, \{\mathbf{u}^\beta\}_{\beta \neq \alpha}, \eta_\alpha, \mathbf{m}^{\mathcal{O}_{\mathcal{P}}^\alpha}, z|\Sigma') \cdot e^{2\pi i \sum_{i,\beta} (g_\beta^i(\{\sigma^{\gamma'}\}, \mathcal{P}_\beta) + \sum_l b_\beta^{il} \eta_l) u_i^\beta}, \quad (3.57)$$

where the operator $\mathcal{Z}_{\mathcal{O}_{\mathcal{P}}^\alpha(X)}$ is defined in (3.20). The expression (3.54) will serve as the working definition for the dual S -type operation acting on the quiver gauge theory Y , decorated by a Wilson defect \mathcal{D}^\vee . For a Lagrangian Y' , the RHS can be identified as a Wilson defect partition function, and we denote the resultant Wilson defect as $L^\vee(D^\vee, \mathcal{D}^\vee)$.

Dual of a Wilson defect

Let $\mathcal{D} = W_{R(G)}$ denote the vortex defect in a representation R of the gauge group G for the theory X . The dual vortex defect \mathcal{D}^\vee will have the generic form:

$$\mathcal{D}^\vee = \sum_\kappa c_\kappa \widetilde{W}_\kappa^{\text{b.g.}} \widetilde{V}_{\widetilde{R}_\kappa(\widetilde{G})}^{\Sigma_\kappa}, \quad (3.58)$$

where $\widetilde{V}_{\widetilde{R}_\kappa(\widetilde{G})}^{\Sigma_\kappa}$ is a vortex defect in a representation \widetilde{R}_κ for the gauge group \widetilde{G} of the theory Y , and $\widetilde{W}_\kappa^{\text{b.g.}}$ is a Wilson defect for a combination of 3d topological symmetries of Y .

Let us first consider the case where S -operation does not involve any defect operation. Following the same reasoning as before, the dual partition function can be written in the form (up to contact terms):

$$\boxed{\mathcal{Z}_{\tilde{\mathcal{O}}_{\mathcal{P}}^\alpha(Y[\mathcal{D}^\vee])}^\kappa(\mathbf{m}'; \boldsymbol{\eta}') = \sum_\kappa c_\kappa \left(\lim_{z \rightarrow 1} \int \prod_{\gamma'} [d\boldsymbol{\sigma}^{\gamma'}] \mathcal{Z}_{\tilde{\mathcal{O}}_{\mathcal{P}}^\alpha(Y)}^\kappa(\{\sigma^{\gamma'}\}, \mathbf{m}^{\mathcal{O}_{\mathcal{P}}^\alpha}, \eta_\alpha, \boldsymbol{\eta}) \cdot Z_{\widetilde{W}_\kappa^{\text{b.g.}}}(\{\mathbf{u}^\beta = 0\}, \dots) \right. \\ \left. \times C_{XY}(\{\mathbf{u}^\beta = 0\}, \dots, \boldsymbol{\eta}) Z_{\text{int}}^{(Y[\widetilde{V}_{\widetilde{R}_\kappa(\widetilde{G})}^{\Sigma_\kappa}], \{\mathcal{P}_\beta\})}(\{\sigma^{\gamma'}\}, \mathbf{m}^Y(\boldsymbol{\eta}), \boldsymbol{\eta}^Y(\{\mathbf{u}^\beta = 0\}, \dots), z) \right),$$
(3.59)

where the integrand $Z_{\text{int}}^{(Y[\tilde{V}_{R\kappa}^{\Sigma\kappa}], \{\mathcal{P}_\beta\})}$ is given by the formula (3.35), and the functions $Z_{\tilde{\mathcal{O}}_{\mathcal{P}}^\kappa}^\kappa(Y)$ are given by the following formula:

$$\boxed{Z_{\tilde{\mathcal{O}}_{\mathcal{P}}^\kappa}^\kappa(Y) = \int [d\mathbf{u}^\alpha] \mathcal{Z}_{\mathcal{O}_{\mathcal{P}}^\alpha(X)}(\mathbf{u}^\alpha, \{\mathbf{u}^\beta\}_{\beta \neq \alpha}, \eta_\alpha, \mathbf{m}^{\mathcal{O}_{\mathcal{P}}^\alpha}) \cdot e^{2\pi i \sum_{i,\beta} (g_\beta^i(\{\sigma^{\gamma'}\}, \mathcal{P}_\beta) + \sum_l b_\beta^{il} \eta_l) u_i^\beta} Z_{\text{b.g.}}^\kappa(\{\mathbf{u}^\beta\}, \dots)}, \quad (3.60)$$

where $Z_{\text{b.g.}}^\kappa$ denotes the combined $\{\mathbf{u}^\beta\}$ -dependent part of $Z_{\tilde{W}_\kappa^{\text{b.g.}}}$ and any $\{\mathbf{u}^\beta\}$ -dependent background Wilson defect term in $Z_{\text{int}}^{(Y[\tilde{V}_{R\kappa}^{\Sigma\kappa}], \{\mathcal{P}_\beta\})}$. If the dual theory Y' is Lagrangian, then the expression on the RHS of (3.59) can be identified as the partition function of a quiver gauge theory Y' decorated by a vortex defect, which we denote as $L^\vee(\mathbf{1}, \mathcal{D}^\vee)$. The formula (3.59) can be readily generalized to the case where the S -type operation involves a defect D , by simply replacing in the integrand:

$$Z_{\tilde{\mathcal{O}}_{\mathcal{P}}^\kappa}^\kappa(\{\sigma^{\gamma'}\}, \mathbf{m}^{\mathcal{O}_{\mathcal{P}}^\alpha}, \eta_\alpha, \boldsymbol{\eta}) \rightarrow Z_{\tilde{\mathcal{O}}_{\mathcal{P}}^\kappa}^\kappa(\{\sigma^{\gamma'}\}, \mathbf{m}^{\mathcal{O}_{\mathcal{P}}^\alpha}, \eta_\alpha, \boldsymbol{\eta}|R'). \quad (3.61)$$

The latter functions are defined by :

$$\begin{aligned} Z_{\tilde{\mathcal{O}}_{\mathcal{P}}^\kappa}^\kappa(Y) &= \int [d\mathbf{u}^\alpha] \mathcal{Z}_{\mathcal{O}_{\mathcal{P}}^\alpha(X)}(\mathbf{u}^\alpha, \{\mathbf{u}^\beta\}_{\beta \neq \alpha}, \eta_\alpha, \mathbf{m}^{\mathcal{O}_{\mathcal{P}}^\alpha}|R') \cdot Z_{\text{b.g.}}^\kappa(\{\mathbf{u}^\beta\}, \dots) \\ &\quad \times e^{2\pi i \sum_{i,\beta} (g_\beta^i(\{\sigma^{\gamma'}\}, \mathcal{P}_\beta) + \sum_l b_\beta^{il} \eta_l) u_i^\beta}, \end{aligned} \quad (3.62)$$

where the operator $\mathcal{Z}_{\mathcal{O}_{\mathcal{P}}^\alpha(X)}$ is given in (3.17). The expression (3.59) will serve as the working definition for the dual S -type operation acting on the quiver gauge theory Y , decorated by a vortex defect \mathcal{D}^\vee . For a Lagrangian Y' , the RHS can be identified as a vortex defect partition function, and we denote the resultant vortex defect as $L^\vee(D^\vee, \mathcal{D}^\vee)$.

To summarize the above results, the dual of the S -type operation generates a theory Y' decorated by a line defect L^\vee built out of the pair $(D^\vee, \mathcal{D}^\vee)$, where $L^\vee, D^\vee, \mathcal{D}^\vee$ are all defects of the same type, i.e. they all preserve either the subalgebra SQM_A or SQM_B . The line defect L^\vee can be read off (in some cases, after some non-trivial manipulations of the partition function) if the dual theory Y' is Lagrangian. Schematically, we have:

$$Z_{\tilde{\mathcal{O}}_{\mathcal{P}}^\kappa}^{\tilde{\mathcal{O}}_{\mathcal{P}}^\kappa(Y[\mathcal{D}^\vee])}(\mathbf{m}'(\boldsymbol{\eta}, \eta_\alpha); \boldsymbol{\eta}'(\mathbf{m}^{\mathcal{O}_{\mathcal{P}}^\alpha}, \dots)) := Z^{(Y'[L^\vee(D^\vee, \mathcal{D}^\vee)])}(\mathbf{m}'(\boldsymbol{\eta}, \eta_\alpha); \boldsymbol{\eta}'(\mathbf{m}^{\mathcal{O}_{\mathcal{P}}^\alpha}, \dots)), \quad (3.63)$$

where the precise forms of the defect partition functions are given by (3.54) and (3.59) for \mathcal{D} being a vortex defect and a Wilson defect respectively.

The action of the S -type operation on the dual pair $(X[\mathcal{D}], Y[\mathcal{D}^\vee])$ therefore leads to the new duality statement :

$$\boxed{\langle L(D, \mathcal{D}) \rangle_{X'}(\mathbf{m}^{\mathcal{O}_{\mathcal{P}}^\alpha}, \dots; \boldsymbol{\eta}, \eta_\alpha) = \langle L^\vee(D^\vee, \mathcal{D}^\vee) \rangle_{Y'}(\mathbf{m}'; \boldsymbol{\eta}'), \quad (3.64)$$

where $\mathbf{m}' = \mathbf{m}'(\boldsymbol{\eta}, \eta_\alpha), \boldsymbol{\eta}' = \boldsymbol{\eta}'(\mathbf{m}^{\mathcal{O}_{\mathcal{P}}^\alpha}, \dots)$. Equation (3.64) allows one to directly read off the mirror map between the line defect $L(D, \mathcal{D})$ in the new quiver gauge theory X' and

the line defect $L^\vee(D^\vee, \mathcal{D}^\vee)$ in the dual theory Y' . We would like to emphasize that this procedure should work whenever the pair (X', Y') are Lagrangian, regardless of whether the theories have a Hanany-Witten type description.

3.5 Simple illustrative example: Abelian S -type operations on $T(U(2))$

In this section, we work out an explicit example which illustrates the basic points of the construction described in Section 3.3-Section 3.4. We will study an elementary Abelian flavoring-identification operation acting on a $T(U(2))$ theory⁷ with defects, which leads to another linear quiver with defects, and work out the mirror dual of the latter. Obviously, this mirror map can be worked out using the Type IIB description of [9], but we present it here to illustrate how the general procedure of Section 3.3-Section 3.4 works in simple examples.

$T(U(2))$ is a self-mirror, and its partition function obeys the following identity:

$$Z^{T(U(2))}(\mathbf{m}; \mathbf{t}) = e^{2\pi i(m_1 t_1 - m_2 t_2)} Z^{T(U(2))}(\mathbf{t}; -\mathbf{m}). \quad (3.65)$$

Consider a vortex defect of charge k for the $U(1)$ gauge group. The defect can be realized as two different 3d-1d quivers, shown as $X[V_{1,k}^l]$ and $X[V_{1,k}^r]$ in Fig. 18. The defect partition functions for the two quivers are given as:

$$Z^{X[V_{1,k}^l]}(\mathbf{m}; \mathbf{t}) = e^{2\pi k t_1} \cdot \lim_{z \rightarrow 1} Z^{T(U(2))}(m_1 + ikz, m_2; \mathbf{t}), \quad (3.66)$$

$$Z^{X[V_{1,k}^r]}(\mathbf{m}; \mathbf{t}) = e^{2\pi k t_2} \cdot \lim_{z \rightarrow 1} Z^{T(U(2))}(m_1, m_2 - ikz; \mathbf{t}). \quad (3.67)$$

Using the identity (3.65), one can rewrite the z -dependent functions on the RHS of the first equation as:

$$\begin{aligned} e^{2\pi k t_1} \cdot Z^{T(U(2))}(m_1 + ikz, m_2; \mathbf{t}) &= e^{2\pi i(m_1 t_1 - m_2 t_2)} Z^{Y[\widetilde{W}_k]}(\mathbf{t}; -\mathbf{m}|z) \\ &= e^{2\pi i(m_1 t_1 - m_2 t_2)} \int d\sigma \frac{e^{-2\pi i\sigma(m_1 - m_2)} e^{2\pi k \sigma z}}{\cosh \pi(\sigma - t_1) \cosh \pi(\sigma - t_2)}. \end{aligned} \quad (3.68)$$

The above equality is a special case of the equation (3.49), for the $T(U(2))$ theory and the vortex defect under consideration. Note that on taking the $z \rightarrow 1$ limit, one gets the result:

$$\begin{aligned} Z^{X[V_{1,k}^l]}(\mathbf{m}; \mathbf{t}) &= e^{2\pi i(m_1 t_1 - m_2 t_2)} \lim_{z \rightarrow 1} Z^{Y[\widetilde{W}_k]}(\mathbf{t}; -\mathbf{m}|z) \\ &= e^{2\pi i(m_1 t_1 - m_2 t_2)} Z^{Y[\widetilde{W}_k]}(\mathbf{t}; -\mathbf{m}), \end{aligned} \quad (3.69)$$

leading to the mirror map:

$$\langle V_{1,k}^l \rangle_X(\mathbf{m}; \mathbf{t}) = \langle \widetilde{W}_k \rangle_Y(\mathbf{t}, -\mathbf{m}), \quad (3.70)$$

⁷Recall that the theory $T(U(2))$ is obtained from $T(SU(2))$ by adding a decoupled theory which consists of a mixed CS term involving a background $U(1)$ vector multiplet and the $U(1)_J$ twisted vector multiplet.

which can also be read off from the Type IIB construction. Proceeding in a similar fashion, one can similarly show that:

$$\langle V_{1,k}^r \rangle_X(\mathbf{m}; \mathbf{t}) = \langle \widetilde{W}_k \rangle_Y(\mathbf{t}, -\mathbf{m}). \quad (3.71)$$

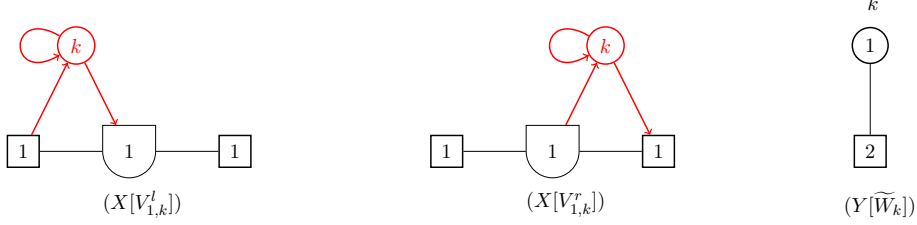

Figure 18: The two 3d-1d systems that realize the 3d vortex operator $V_{1,k}$ in a $U(1)$ gauge theory with two hypermultiplets. The mirror dual is a gauge Wilson defect of charge k .

Now, one can take the 3d-1d system $(X[V_{1,k}^l])$ on the LHS of Fig. 18, and implement a flavoring-gauging operation on a $U(1)$ flavor node, as shown in Fig. 19, following the general procedure outlined in Section 3.3. This corresponds to the following choice of the parameters (u, v) and the permutation matrix \mathcal{P} :

$$u = m_2, v = m_1, \quad \mathcal{P} = \begin{pmatrix} 0 & 1 \\ 1 & 0 \end{pmatrix}. \quad (3.72)$$

The resultant theory is another 3d-1d quiver, which we denote as $\mathcal{O}_{\mathcal{P}}(X[V_{1,k}^l])$. The defect partition function can be written down from the general expression (3.37) as follows:

$$\begin{aligned} \mathcal{Z}^{\mathcal{O}_{\mathcal{P}}(X[V_{1,k}^l])} &= e^{2\pi k t_1} \times \lim_{z \rightarrow 1} \left(\int du \frac{e^{2\pi i \eta u}}{\cosh \pi(u - m_f)} \mathcal{Z}^{T(U(2))}(v + ikz, u; \mathbf{t}) \right) \\ &= e^{2\pi k t_1} \cdot \lim_{z \rightarrow 1} \int du ds \frac{e^{2\pi i \eta u}}{\cosh \pi(u - m_f)} \mathcal{Z}_{\text{int}}^{T(U(2))}(s, v, u, \mathbf{t}) \mathcal{I}^{\Sigma^l}(s, v, z | \xi > 0). \end{aligned} \quad (3.73)$$

The matrix model integral in the last step can be identified as the partition function of the 3d-1d quiver $X'[V_{1,k}^{(I)}]$ in Fig. 19.

The dual defect partition function can be obtained from the general expressions (3.54)-(3.55). Firstly, one can compute the function $\mathcal{Z}_{\widetilde{\mathcal{O}}_{\mathcal{P}}(Y)}$ as follows:

$$\mathcal{Z}_{\widetilde{\mathcal{O}}_{\mathcal{P}}(Y)}(\sigma, v, m_f, \eta, \mathbf{t}) = \int du \frac{e^{2\pi i \eta u}}{\cosh \pi(u - m_f)} e^{2\pi i(\sigma - t_2)u} = \frac{e^{2\pi i m_f(\sigma + \eta - t_2)}}{\cosh \pi(\sigma + \eta - t_2)}. \quad (3.74)$$

Using the above expression and (3.68) in the general expression (3.54), the defect partition

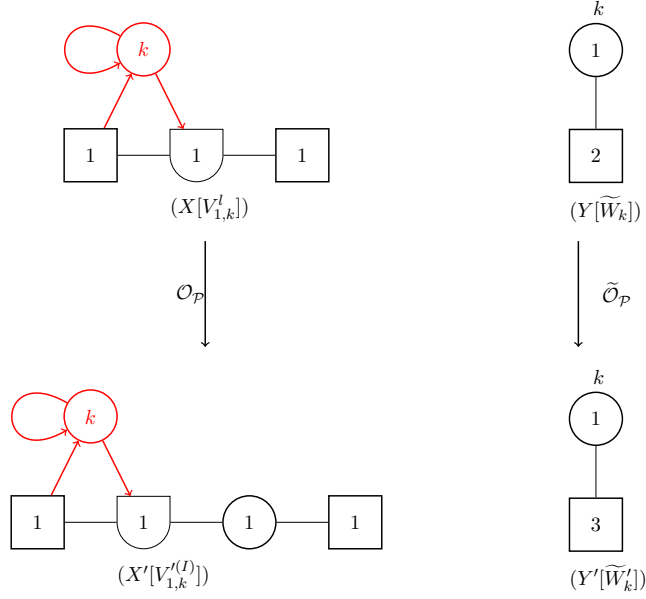

Figure 19: The construction of a vortex defect and its dual Wilson defect, using a flavoring-gauging operation, with a pair of defects in $T(U(2))$ as a starting point.

function can be written as:

$$\begin{aligned}
Z^{\tilde{\mathcal{O}}_{\mathcal{P}}(Y[\tilde{W}_k])} &= \lim_{z \rightarrow 1} \int d\sigma \frac{e^{2\pi i m_f (\sigma + \eta - t_2)}}{\cosh \pi (\sigma + \eta - t_2)} e^{2\pi i v t_1} \frac{e^{-2\pi i \sigma v} e^{2\pi k \sigma z}}{\cosh \pi (\sigma - t_1) \cosh \pi (\sigma - t_2)} \\
&= e^{2\pi i (v t_1 + m_f (\eta - t_2))} \int d\sigma \frac{e^{2\pi i (m_f - v) \sigma} e^{2\pi k \sigma}}{\cosh \pi (\sigma - t_1) \cosh \pi (\sigma - t_2) \cosh \pi (\sigma + \eta - t_2)}
\end{aligned} \tag{3.75}$$

$$= e^{2\pi i (v t_1 + m_f (\eta - t_2))} Z^{(Y'[\tilde{W}'_k])}, \tag{3.76}$$

where we can set $\eta = t_2 - t_3$, and $v = m_1$, $m_f = m_2$, to write the above partition function in a more standard form. The matrix model in the second step can be identified as the partition function of the theory Y' – a $U(1)$ gauge theory with three hypermultiplets of charge 1 – with a gauge $U(1)$ Wilson line of charge k inserted. The theory is denoted as $Z^{(Y'[\tilde{W}'_k])}$ in Fig. 19. The above computation then implies the mirror map:

$$\langle V'_{1,k} \rangle_{X'} = \langle \tilde{W}'_k \rangle_{Y'}. \tag{3.77}$$

One can similarly start from the 3d-1d system $X[V'_{1,k}]$ on the RHS of Fig. 18, one can implement a flavoring-gauging operation with

$$u = m_1, v = m_2, \quad \mathcal{P} = \begin{pmatrix} 1 & 0 \\ 0 & 1 \end{pmatrix}. \tag{3.78}$$

The resultant dual system is shown in Fig. 20, which leads to the mirror map of the defect operators:

$$\langle V_{1,k}'^{(II)} \rangle_{X'} = \langle \widetilde{W}_k' \rangle_{Y'}. \quad (3.79)$$

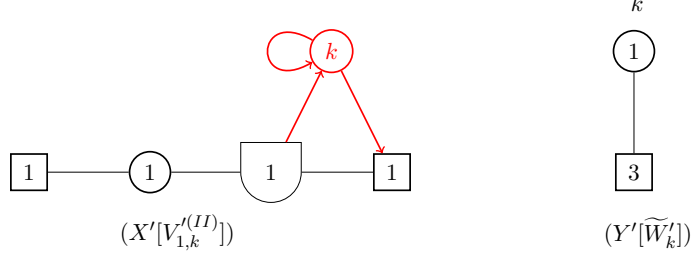

Figure 20: The second realization of the vortex defect in the theory X' via a 3d-1d system.

Finally, we can also take the 3d-1d quiver $(X[V_{1,k}^l])$ in Fig. 18, and implement a flavoring-gauging operation on the other $U(1)$ flavor node, which corresponds to the following choice of the parameters (u, v) and the permutation matrix \mathcal{P} :

$$u = m_1, v = m_2, \quad \mathcal{P} = \begin{pmatrix} 0 & 1 \\ 1 & 0 \end{pmatrix}. \quad (3.80)$$

The resultant dual system is shown in Fig. 20, which leads to the mirror map of the defect operators:

$$\langle V_{1,k}'^{(III)} \rangle_{X'} = \langle \widetilde{W}_k' \rangle_{Y'}. \quad (3.81)$$

From (3.77), (3.79), (3.81), we observe the fact that the vertex operator in X' dual to the gauge Wilson defect \widetilde{W}_k' in Y' has three different realizations as a 3d-1d quivers. This is also what one expects from the Type IIB description of the vortex operator in X' , where the stack of k D1-branes can end on any one of the three NS5-branes, thereby leading to the three 3d-1d systems.

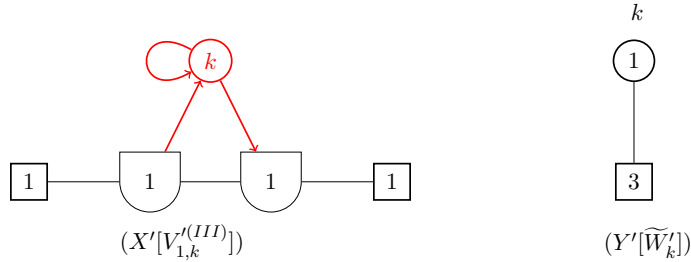

Figure 21: The third realization of the vortex defect in the theory X' via a 3d-1d system.

4 Beyond linear quivers : D_n and \widehat{D}_n quiver gauge theories

In this section, we will focus on deriving the mirror map of defects in quiver gauge theories of the D_n and \widehat{D}_n type, as a concrete application of the general construction developed in

Section 3.3-Section 3.4. The D_n and \widehat{D}_n quiver gauge theories discussed in this section can be realized by a Type IIB construction involving configurations of D3-D5-NS5 branes with one and two orbifold 5-planes respectively.

4.1 Defects in a D_4 quiver

In this section, we will discuss an example of mirror symmetry involving a D_4 quiver gauge theory with a gauge group $G = U(2) \times U(1)^3$ and a single fundamental hypermultiplet charged under the $U(2)$ factor, which is dual to an $SU(2)$ gauge theory with $N_f = 4$ flavors.

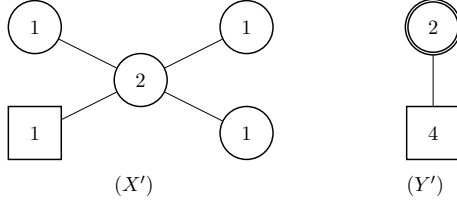

Given the dual pair, we will explicitly construct the mirror map for a class of Wilson/vortex defects in the dual theories, starting from defects in a dual pair of linear quivers, using Abelian S -type operations.

The starting point is the dual pair of linear quivers in Fig. 22. The mirror map

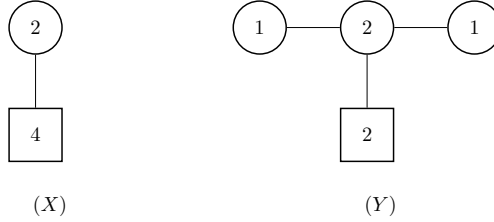

Figure 22: A pair of dual linear quivers with unitary gauge groups.

of defect operators for the dual pair above was discussed in detail in [9], using the S^3 partition function as well as the Type IIB brane construction. A set of vortex defects in quiver gauge theory X , labelled as $V_{M,R}$, can be realized as the coupled 3d-1d systems in Fig. 23, with R being a representation of the gauge group $U(2)$ of the form (2.20), and $0 \leq M \leq 4$.

The coupled 3d-1d systems above are two equivalent ways of describing the same defect $V_{M,R}$, and represent a hopping duality associated with the vortex defect. We will refer to the two SQMs as $\Sigma_r^{M,R}$ and $\Sigma_l^{M,R}$ respectively.

We will denote the dual Wilson defect in the quiver gauge theory Y generically as $\widetilde{W}_{\widetilde{R}}$, where \widetilde{R} is related to the representation R , and the precise relation is part of the mirror map between the defect operators. The dual Wilson defects were worked out in [9] and

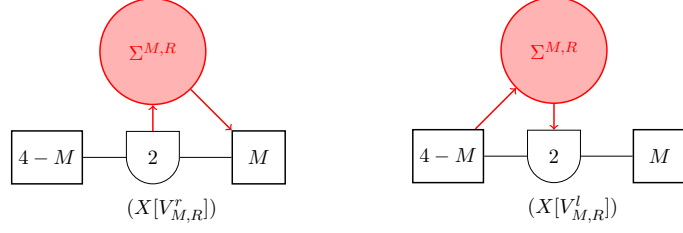

Figure 23: A family of vortex defects $V_{M,R}$ in the theory X and the associated 3d-1d coupled quivers.

have been reviewed in Appendix A.2. The mirror maps for various choices of the integer M can be enumerated as follows:

- $M = 0, 4$: These vortex defects are mapped to flavor Wilson defects in the theory Y . Let $U(2)_f$ denote the flavor symmetry group of Y associated with the fundamental hypermultiplets, and let $U(1)_1 \times U(1)_2 \subset U(2)_f$ be the maximal torus of $U(2)_f$. Also, let $\widetilde{W}_{i,q}^{\text{flavor}}$ denote Wilson defects for $U(1)_{i=1,2}$ with charge q . The mirror maps are then given as:

$$\langle V_{0,R} \rangle_X(\mathbf{m}; \mathbf{t}) = \langle \widetilde{W}_{2,|R|}^{\text{flavor}} \rangle_Y(\mathbf{t}; -\mathbf{m}), \quad (4.1)$$

$$\langle V_{4,R} \rangle_X(\mathbf{m}; \mathbf{t}) = \langle \widetilde{W}_{1,|R|}^{\text{flavor}} \rangle_Y(\mathbf{t}; -\mathbf{m}). \quad (4.2)$$

- $M = 1, 3$: These vortex defects are mapped to a combination of flavor Wilson defects and gauge Wilson defect in a $U(1)$ subgroup of the gauge group $\widetilde{G} = U(1) \times U(2) \times U(1)$ of the theory Y . The mirror maps are given as:

$$\begin{aligned} \langle V_{1,R} \rangle_X(\mathbf{m}; \mathbf{t}) &= \left\langle \sum_{\kappa \in \Delta} \widetilde{W}_{2,q_2^\kappa}^{\text{flavor}} \widetilde{W}_{q_1^\kappa}^{(3)} \right\rangle_Y(\mathbf{t}; -\mathbf{m}), \\ \langle V_{3,R} \rangle_X(\mathbf{m}; \mathbf{t}) &= \left\langle \sum_{\kappa \in \Delta} \widetilde{W}_{1,q_2^\kappa}^{\text{flavor}} \widetilde{W}_{q_1^\kappa}^{(1)} \right\rangle_Y(\mathbf{t}; -\mathbf{m}), \end{aligned} \quad (4.3)$$

where $\widetilde{W}_{q_1^\kappa}^{(\gamma'=1,3)}$ are gauge Wilson defects of charge q_1^κ for the $U(1)$ gauge nodes, labelled $\gamma' = 1, 3$ in the quiver Y . The charges (q_1^κ, q_2^κ) are obtained from the decomposition of the representation R under the maximal torus $U(1) \times U(1) \subset U(2)$, and Δ is the set of such charge doublets counted with degeneracies.

- $M = 2$: This vortex defect maps to a gauge Wilson defect \widetilde{W}_R in the same representation R of the central $U(2)$ gauge node of the theory Y , i.e.

$$\langle V_{2,R} \rangle_X(\mathbf{m}; \mathbf{t}) = \langle \widetilde{W}_R \rangle_Y(\mathbf{t}; -\mathbf{m}). \quad (4.4)$$

One can similarly consider a Wilson defect W_R , labelled by a representation R of the $U(2)$ gauge group in the theory X . The dual object is a vortex defect $\widetilde{V}_{1,R}$, labelled

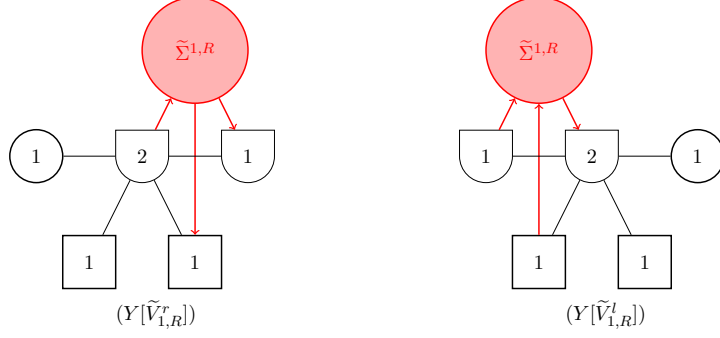

Figure 24: A family of vortex defects $\tilde{V}_{1,R}$ in the theory Y and the associated 3d-1d coupled quivers.

by a representation R of the central $U(2)$ gauge group in the quiver gauge theory Y . The coupled 3d-1d systems, worked out in [9], that realize the vortex defect are given in Fig. 24.

The construction of the mirror map in terms of the partition function is reviewed in Section A.3, and is given as:

$$\langle W_R \rangle_X(\mathbf{m}; \mathbf{t}) = \langle \tilde{V}_{1,R} \rangle_Y(-\mathbf{t}; \mathbf{m}). \quad (4.5)$$

4.1.1 A vortex defect for the central node

We begin with an example where a gauge vortex defect in the D_4 quiver gauge theory is mapped to a gauge Wilson defect in the $SU(2)$ theory. Consider the dual pair of defects $(V_{2,R}^r, \tilde{W}_R)$ – the coupled 3d-1d system (corresponding to the right SQM) and its dual are shown in the first line of Fig. 25. Let the fundamental masses in theory X be labelled as $\{m_i | i = 1, \dots, 4\}$, such that the $U(2)$ flavor node identified with the 1d flavor symmetry in $X[V_{M,R}^r]$ is associated with the masses m_3, m_4 . Following the general prescription of Section 3.3, we implement an Abelian S -type operation on the system $X[V_{2,R}^r]$, consisting of three elementary Abelian gauging operations, as follows:

$$\mathcal{O}_{\mathcal{P}}(X[V_{2,R}^r]) = G_{\mathcal{P}_3}^\beta \circ G_{\mathcal{P}_2}^{\alpha_2} \circ G_{\mathcal{P}_1}^{\alpha_1}(X[V_{2,R}^r]), \quad (4.6)$$

where $\alpha_1 = \alpha$, and α_2 is the residual $U(1)$ flavor node from $U(2)_\alpha$ in the theory $G_{\mathcal{P}_1}^{\alpha_1}(X)$. The mass parameters corresponding to the $U(1)^3$ global symmetry are chosen as:

$$u_1 = m_3, \quad u_2 = m_4, \quad u_3 = m_1. \quad (4.7)$$

Note that the S -type operation is splitting the $U(2)_\alpha$ flavor node into two $U(1)$ flavor nodes and gauging them. From (3.37), the partition function of the resultant 3d-1d system can

then be written down as follows:

$$Z^{\mathcal{O}\mathcal{P}(X[V_{2,R}^r])} = \lim_{z \rightarrow 1} \int \prod_{i=1}^3 du_i \left[ds \right] \prod_{i=1}^3 Z_{\text{FI}}(u_i, \eta_i) Z_{\text{int}}^{(X)}(\mathbf{s}, \mathbf{u}, v, \mathbf{t}) W_{\text{b.g.}}(\mathbf{t}, R) \mathcal{I}^{\Sigma_r^{2,R}}(\mathbf{s}, \mathbf{u}, z | \boldsymbol{\xi} < 0), \quad (4.8)$$

$$Z_{\text{int}}^{(X)}(\mathbf{s}, \mathbf{u}, v, \mathbf{t}) = \left\{ Z_{\text{int}}^{(X)}(\mathbf{s}, \mathbf{m}, \mathbf{t}) | m_3 = u_1, m_4 = u_2, m_1 = u_3, m_2 = v \right\}, \quad (4.9)$$

$$W_{\text{b.g.}}(\mathbf{t}, R) = e^{2\pi t_2 |R|}, \quad (4.10)$$

$$\mathcal{I}^{\Sigma_r^{2,R}}(\mathbf{s}, \mathbf{u}, z | \boldsymbol{\xi} < 0) = \sum_{w \in R} \prod_{j=1}^2 \prod_{i=1}^2 \frac{\cosh \pi(s_j - u_i)}{\cosh \pi(s_j + iw_j z - u_i)}, \quad (4.11)$$

where $w = (w_1, w_2)$ is a weight of representation R of $U(2)$. The expression on the RHS of (4.8) can be readily identified as the partition function of a coupled 3d-1d system, where the 3d theory is a D_4 quiver gauge theory X' with a gauge group $G' = U(2) \times U(1)^3$, and the SQM is $\Sigma_r^{2,R}$. This 3d-1d quiver is denoted as $X'[V_{2,R}^{(I)}]$ in Fig. 25 on the LHS of the second line. We claim that this 3d-1d quiver realizes a vortex defect in the representation R of the central $U(2)$ gauge node in the theory X' . In fact, we will find it convenient to redefine the defect partition function by a global Wilson defect factor as follows:

$$Z^{(X'[V_{2,R}^{(I)}])} := e^{-2\pi(t_2 - \frac{\eta_1 + \eta_2}{2})|R|} Z^{\mathcal{O}\mathcal{P}(X[V_{2,R}^r])}(v; \mathbf{t}, \boldsymbol{\eta}), \quad (4.12)$$

where the superscript (I) denotes the specific 3d-1d system that arises in the construction described above.

The dual system can be determined following the discussion of Section 3.4. The dual partition function can be read off from the general expressions (3.54)-(3.55) – the details of the computation are summarized in Appendix B.1. The dual partition function can be written in the following form:

$$Z^{(Y'[(V_{2,R}^{(I)})^\vee])} = e^{-2\pi(t_2 - \frac{\eta_1 + \eta_2}{2})|R|} Z^{\tilde{\mathcal{O}}\mathcal{P}(Y[\tilde{W}_R])}, \quad (4.13)$$

$$Z^{(Y'[(V_{2,R}^{(I)})^\vee])} = C(v, \boldsymbol{\eta}, \mathbf{t}) \int [d\boldsymbol{\sigma}] \delta(\text{Tr}\boldsymbol{\sigma}) Z_{\text{int}}^{U(2), N_f=4}(\boldsymbol{\sigma}, \mathbf{m}'(\mathbf{t}, \boldsymbol{\eta}), \eta' = 0) \sum_{w \in R} e^{2\pi \sum_j w_j \sigma_j}, \quad (4.14)$$

$$C(v, \boldsymbol{\eta}, \mathbf{t}) = e^{2\pi i v (\eta_1 + \eta_2 + \eta_3 + 2(t_1 - t_2))}, \quad (4.15)$$

where $C(v, \boldsymbol{\eta}, \mathbf{t})$ is a contact term, $Z_{\text{int}}^{U(2), N_f=4}(\boldsymbol{\sigma}, \mathbf{m}'(\mathbf{t}, \boldsymbol{\eta}), \eta')$ is the integrand for the partition function of a $U(2)$ gauge theory with $N_f = 4$ hypermultiplets, $\mathbf{m}'(\mathbf{t}, \boldsymbol{\eta})$ are the masses of the hypermultiplets, and η' is the FI parameter for the $U(2)$ gauge group.

The RHS of (4.14) implies that the theory $Y'[(V_{2,R}^{(I)})^\vee]$ can be identified as an $SU(2)$ gauge theory with $N_f = 4$ flavors, along with a Wilson defect in a representation \tilde{R} of the $SU(2)$ gauge group, where the representation \tilde{R} is the restriction of the $U(2)$ representation

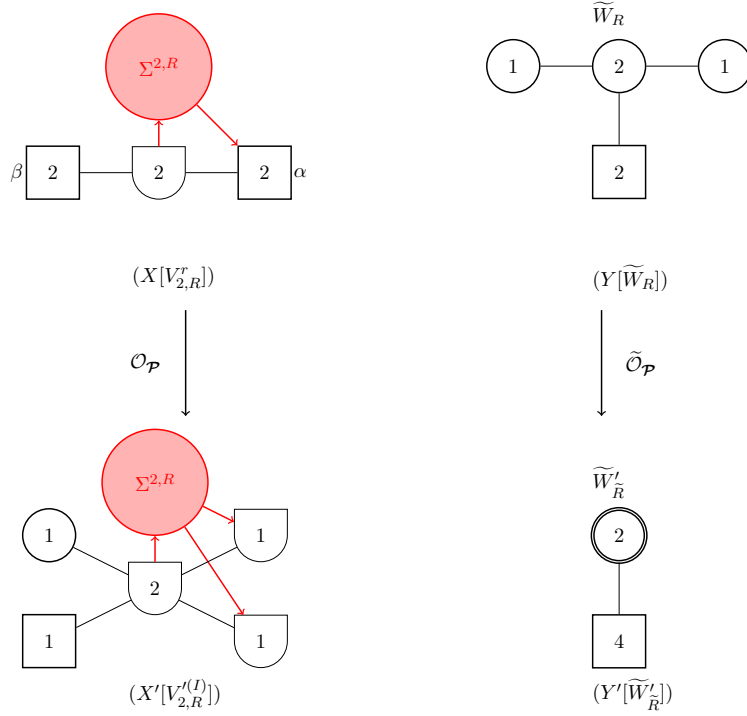

Figure 25: The construction of a vortex defect in a flavored D_4 quiver gauge theory and its dual Wilson defect, using an Abelian gauging operation.

R to an $SU(2)$ subgroup. More explicitly, we have

$$\begin{aligned} U(2) &\rightarrow SU(2), \\ R &\rightarrow \tilde{R}. \end{aligned} \tag{4.16}$$

We denote the theory Y' with the Wilson defect insertion as $Y'[\tilde{W}'_R]$, as shown on the RHS of the second line in Fig. 25. Normalizing the integrals with appropriate partition functions, we obtain the following mirror map of line defects in the pair of dual theories (X', Y') :

$$\langle V'_{2,R}{}^{(I)} \rangle_{X'}(\mathbf{t}, \boldsymbol{\eta}) = \langle \tilde{W}'_R \rangle_{Y'}(\mathbf{m}'(\mathbf{t}, \boldsymbol{\eta})), \tag{4.17}$$

where the functions $\mathbf{m}'(\mathbf{t}, \boldsymbol{\eta})$ can be read off from (B.14)-(B.17).

A second coupled 3d-1d quiver $(X'[V'_{2,R}{}^{(II)}])$ which realizes the same vortex defect is shown in Fig. 26. The Witten index for the coupled SQM in this case should be computed in the chamber $\boldsymbol{\xi} > 0$. One can read off this 3d-1d quiver directly by a change of variables in the matrix integral of (4.8): $s_j \rightarrow s_j - iw_j z$. It can also be obtained by implementing the S -type operation (4.6), characterized by the choice of the $U(1)^3$ parameters (4.7), on the theory $(X[V'_{2,R}{}^{(I)}])$. Note that the $U(2)$ flavor node identified with 1d flavor symmetry is, in this case, being split into two $U(1)$ flavor nodes, of which only one is being gauged.

The defect partition function is again redefined by a global Wilson defect factor, i.e.

$$\mathcal{Z}^{(X'[V'_{2,R}{}^{(II)}])} := e^{-2\pi(t_2 - \frac{\eta_1 + \eta_2}{2})|R|} \mathcal{Z}^{\mathcal{O}_{\mathcal{P}}(X[V'_{2,R}{}^I])}(v; \mathbf{t}, \boldsymbol{\eta}). \quad (4.18)$$

Proceeding as before, the dual partition function can be worked out from (3.54)-(3.55) leading to the relation:

$$\mathcal{Z}^{(Y'[(V'_{2,R}{}^{(II)})^\vee])} = \mathcal{Z}^{(Y'[(V'_{2,R}{}^I)^\vee])}, \quad (4.19)$$

where $\mathcal{Z}^{(Y'[(V'_{2,R}{}^I)^\vee])}$ is given in (4.14). Therefore, one concludes that the two 3d-1d coupled systems $X'[V'_{2,R}{}^I]$ and $X'[V'_{2,R}{}^{(II)}]$ are both realizations of the same vortex defect in the theory X' . This leads to the following mirror map:

$$\langle V'_{2,R}{}^{(II)} \rangle_{X'}(\mathbf{t}, \boldsymbol{\eta}) = \langle V'_{2,R}{}^I \rangle_{X'}(\mathbf{t}, \boldsymbol{\eta}) = \langle \widetilde{W}'_R \rangle_{Y'}(\mathbf{m}'(\mathbf{t}, \boldsymbol{\eta})). \quad (4.20)$$

We will discuss how this hopping duality arises from the Type IIB description of defects in D -type quivers in Section 5.2.

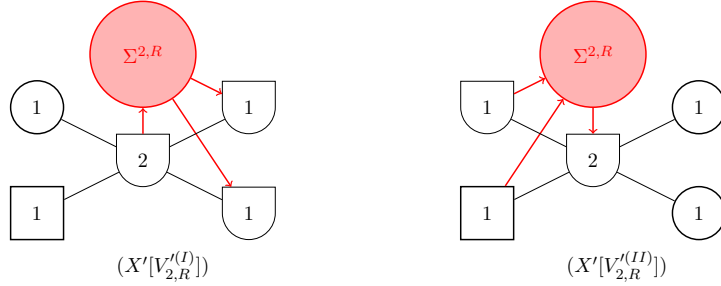

Figure 26: Different 3d-1d systems which realize the same vortex defect $V'_{2,R}$ in the D_4 quiver gauge theory X' . The Witten indices in the two cases are computed in the chambers $\xi < 0$ and $\xi > 0$ respectively. The system (I) is realized by starting with the right SQM for the defect $V_{2,R}$ in a $U(2)$ gauge theory with $N_f = 4$, while (II) is realized when one starts with the left SQM.

One can ask what is the interpretation of the additional 3d-1d quivers which can be obtained from $(X'[V'_{2,R}{}^r])$ (or $(X'[V'_{2,R}{}^l])$) by an Abelian S -type operation of the same form as $\mathcal{O}_{\mathcal{P}}$ in (4.6) but involving a different choice of the $U(1)^3$ global symmetry to be gauged. These 3d-1d quivers can be shown to be identical to the quivers $X'[V'_{2,R}{}^I]$ or $X'[V'_{2,R}{}^{(II)}]$ up to a relabelling of the FI parameters.

4.1.2 Other vortex defects in the D_4 theory

Let us now present a set of examples where a gauge vortex defect in the D_4 theory is mapped to a flavor Wilson defect in the $SU(2)$ theory. These can be constructed as follows. One can implement the S -type operation (4.6)-(4.7) on the 3d-1d coupled quivers corresponding to the vortex defects $V_{M,R}$ in the theory X , for $M \neq 2$. The resultant 3d-1d coupled quivers are shown in Fig. 27, where we have again used the right 3d-1d quiver $X[V'_{M,R}{}^r]$ as our starting point.

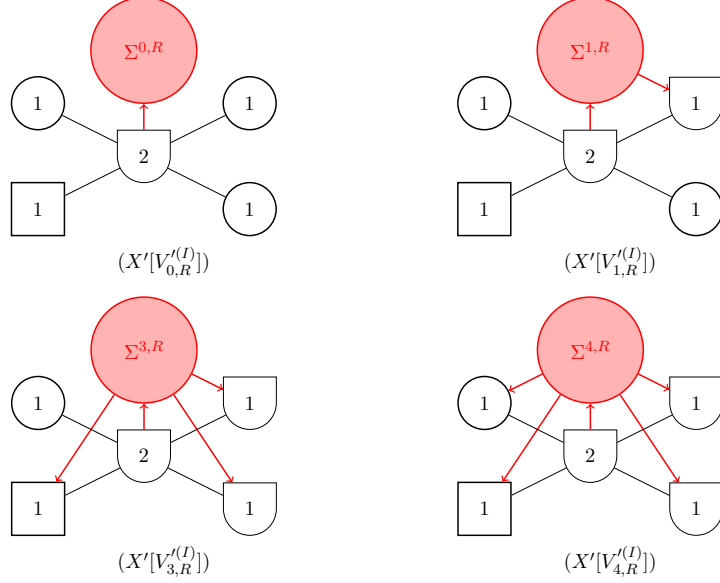

Figure 27: The construction of vortex defects in the flavored D_4 quiver gauge theory X' , using an Abelian S -type operation from $X[V_{M,R}^r]$ with $M = 0, 1, 3, 4$.

For the case of generic M , the resultant vortex defect is defined as

$$Z^{(X'[V_{M,R}^{(I)}])}(v; \mathbf{t}, \boldsymbol{\eta}) := e^{-2\pi(t_2 - \frac{\eta_1 + \eta_2}{2})|R|} Z^{\mathcal{O}_{\mathcal{P}}(X[V_{M,R}^r])}(v; \mathbf{t}, \boldsymbol{\eta}), \quad (4.21)$$

where the defect partition function $Z^{\mathcal{O}_{\mathcal{P}}(X[V_{M,R}^r])}$ being given as

$$Z^{\mathcal{O}_{\mathcal{P}}(X[V_{M,R}^r])} = \lim_{z \rightarrow 1} \int \prod_{i=1}^3 du_i [ds] \prod_{i=1}^3 Z_{\text{FI}}(u_i, \eta_i) Z_{\text{int}}^{(X)}(\mathbf{s}, \mathbf{u}, v, \mathbf{t}) W_{\text{b.g.}}(\mathbf{t}, R) \mathcal{I}^{\Sigma_r^{M,R}}(\mathbf{s}, \mathbf{u}, z | \boldsymbol{\xi} < 0), \quad (4.22)$$

and the various constituent functions on the RHS are given in (A.10)-(A.12). The dual Wilson defects can be worked out in a fashion similar to the $M = 2$ case. We enumerate the results below:

- $M = 1$: The dual defect partition function is given as:

$$\begin{aligned} Z^{(Y'[(V_{1,R}^{(I)})^\vee])} &= e^{-2\pi(t_2 - \frac{\eta_1 + \eta_2}{2})|R|} Z^{\tilde{\mathcal{O}}_{\mathcal{P}}(Y[\tilde{W}_R])} \\ &= C(v, \mathbf{t}, \boldsymbol{\eta}) \left(\sum_w e^{2\pi w_1 m'_4} e^{2\pi w_2 m'_3} \right) Z^{(Y')}(\mathbf{m}'(\mathbf{t}, \boldsymbol{\eta})), \end{aligned} \quad (4.23)$$

where $C(v, \mathbf{t}, \boldsymbol{\eta})$ is the contact term, and $Z^{(Y')}$ is the partition function of the quiver Y' . The form of the partition function shows that the defect dual to $V_{1,R}'$ is a flavor Wilson defect. The mirror map can therefore be written as:

$$\langle V_{1,R}' \rangle_{X'}(\mathbf{t}, \boldsymbol{\eta}) = \left\langle \sum_{\kappa \in \Delta} \tilde{W}_{4,q_1^\kappa}^{\text{flavor}} \tilde{W}_{3,q_2^\kappa}^{\text{flavor}} \right\rangle_{Y'}(\mathbf{m}'(\mathbf{t}, \boldsymbol{\eta})), \quad (4.24)$$

where $\widetilde{W}_{i,q^\kappa}^{\text{flavor}}$ denotes a flavor Wilson defect with charge q^κ for the $U(1)_i$ subgroup of the full flavor group, embedded as $U(1)_1 \times U(1)_2 \times U(1)_3 \times U(1)_4 \subset SO(8)$. The charges (q_1^κ, q_2^κ) are given by decomposing the representation R into $U(1)_1 \times U(1)_2 \subset U(2)$, where $U(1)_1 \times U(1)_2$ is the maximal torus of $U(2)$ and Δ denotes the set of all the charge doublets counted with degeneracies.

- $M = 3$: In this case, the dual defect partition function is given as:

$$\begin{aligned} Z^{(Y'[(V'_{3,R}{}^{(I)})^\vee])} &= e^{-2\pi(t_2 - \frac{\eta_1 + \eta_2}{2})|R|} Z_{\widetilde{\mathcal{O}}_{\mathcal{P}}(Y[\widetilde{W}_R])} \\ &= C(v, \mathbf{t}, \boldsymbol{\eta}) \left(\sum_w e^{2\pi w_1 m'_1} e^{2\pi w_2 m'_2} \right) Z^{(Y')}(\mathbf{m}'(\mathbf{t}, \boldsymbol{\eta})), \end{aligned} \quad (4.25)$$

which leads to the following mirror map:

$$\langle V'_{3,R} \rangle_{X'}(\mathbf{t}, \boldsymbol{\eta}) = \left\langle \sum_{\kappa \in \Delta} \widetilde{W}_{1,q_1^\kappa}^{\text{flavor}} \widetilde{W}_{2,q_2^\kappa}^{\text{flavor}} \right\rangle_{Y'}(\mathbf{m}'(\mathbf{t}, \boldsymbol{\eta})), \quad (4.26)$$

where the notation of operators on the RHS is the same as defined above for the $M = 1$ case.

- $M = 0, 4$: The dual partition functions in these cases are respectively given as:

$$Z^{(Y'[(V'_{0,R}{}^{(I)})^\vee])} = C(v, \mathbf{t}, \boldsymbol{\eta}) \left(\sum_w e^{2\pi(w_1 + w_2)m'_3} \right) Z^{(Y')}(\mathbf{m}'(\mathbf{t}, \boldsymbol{\eta})), \quad (4.27)$$

$$Z^{(Y'[(V'_{4,R}{}^{(I)})^\vee])} = C(v, \mathbf{t}, \boldsymbol{\eta}) \left(\sum_w e^{2\pi(w_1 + w_2)m'_2} \right) Z^{(Y')}(\mathbf{m}'(\mathbf{t}, \boldsymbol{\eta})), \quad (4.28)$$

leading to the following mirror maps:

$$\langle V'_{0,R} \rangle_{X'}(\mathbf{t}, \boldsymbol{\eta}) = \langle \widetilde{W}_{3,|R|}^{\text{flavor}} \rangle_{Y'}(\mathbf{m}'(\mathbf{t}, \boldsymbol{\eta})), \quad (4.29)$$

$$\langle V'_{4,R} \rangle_{X'}(\mathbf{t}, \boldsymbol{\eta}) = \langle \widetilde{W}_{2,|R|}^{\text{flavor}} \rangle_{Y'}(\mathbf{m}'(\mathbf{t}, \boldsymbol{\eta})), \quad (4.30)$$

where the notation of the various flavor Wilson defects are the same as defined for the $M = 1$ case.

Each of the vortex defects listed above is realized by two inequivalent coupled 3d-1d quivers. In exact analogy to the case treated in Section 4.1.1, the second quiver can be read off by implementing the S -type operation (4.6)-(4.7) on the left 3d-1d quiver $X[V'_{2,R}{}^{(I)}]$. Alternatively, one can read it off from the partition function $Z^{(X'[V'_{M,R}{}^{(I)}])}$ by a simple change of variables $s_j \rightarrow s_j - iw_j z$. The 3d-1d quivers associated with the $M = 1$ case are given explicitly in Fig. 28. The Witten index of the SQM for $V'_{1,R}{}^{(I)}$ is computed in the chamber $\boldsymbol{\xi} < 0$, and that for $V'_{1,R}{}^{(II)}$ is computed in the chamber $\boldsymbol{\xi} > 0$.

4.1.3 A Wilson defect for the central node

Let us now consider an example where a gauge Wilson defect in the D_4 theory is mapped to a gauge vortex defect in the $SU(2)$ theory. These defects and the associated mirror map

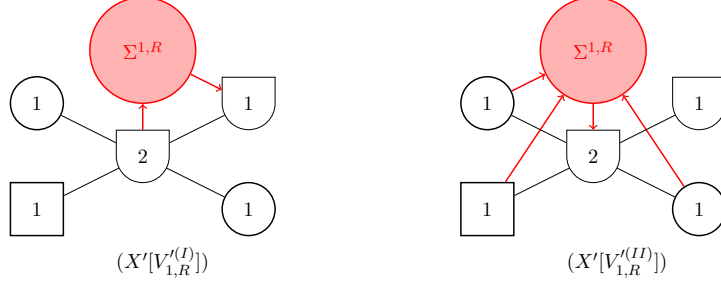

Figure 28: The hopping duals associated with the vortex defect $V'_{1,R}$ for the quiver gauge theory X' . The Witten indices in the two cases are computed in the $\xi < 0$ and $\xi > 0$ chambers respectively.

can be constructed as follows. Consider the dual pair of defects $(W_R, \tilde{V}'_{1,R})$ – the Wilson defect and the coupled 3d-1d system which realizes the dual vortex defect are shown in the first line of Fig. 29. We implement the Abelian S -type operation $\mathcal{O}_{\mathcal{P}}$ on the system $X[W_R]$, where $\mathcal{O}_{\mathcal{P}}$ is given as:

$$\mathcal{O}_{\mathcal{P}}(X[W_R]) = G_{\mathcal{P}_3}^{\alpha_3} \circ G_{\mathcal{P}_2}^{\alpha_2} \circ G_{\mathcal{P}_1}^{\alpha_1}(X[W_R]), \quad (4.31)$$

which corresponds to the following choice of the $U(1)^3$ global symmetry to be gauged:

$$u_1 = m_1, \quad u_2 = m_2, \quad u_3 = m_4. \quad (4.32)$$

The resultant defect partition function, following (3.43), is given as

$$Z^{\mathcal{O}_{\mathcal{P}}(X[W_R])} = \int \prod_{i=1}^3 du_i \left[ds \right] \prod_{i=1}^3 Z_{\text{FI}}(u_i, \eta_i) Z_{\text{int}}^{(X)}(\mathbf{s}, \mathbf{u}, v, \mathbf{t}) Z_{\text{Wilson}}(\mathbf{s}, R), \quad (4.33)$$

$$Z_{\text{int}}^{(X)}(\mathbf{s}, \mathbf{u}, v, \mathbf{t}) = \left\{ Z_{\text{int}}^{(X)}(\mathbf{s}, \mathbf{m}, \mathbf{t}) \mid m_1 = u_1, m_2 = u_2, m_4 = u_3, m_3 = v \right\}, \quad (4.34)$$

$$Z_{\text{Wilson}}(\mathbf{s}, R) = \sum_{w \in R} e^{\sum_j w_j s_j}. \quad (4.35)$$

The defect partition function can be readily identified as the partition function of a D -type quiver gauge theory X' with a gauge group $G' = U(2) \times U(1)^3$, with a Wilson defect labelled by the representation R of $U(2)$. The 3d theory with the defect inserted is denoted by $X'[W'_R]$ and shown in Fig. 29.

Following the general expressions (3.59)-(3.60), the dual partition function can be computed to read off the mirror map of the defects. The final answer takes the following form (the details of the computation can be found in App. B.2):

$$Z^{(Y'[(W'_R)^\vee])} = Z^{\tilde{\mathcal{O}}_{\mathcal{P}}(Y'[\tilde{V}'_{1,R}])}, \quad (4.36)$$

$$Z^{(Y'[(W'_R)^\vee])} = C \cdot W_{\text{b.g.}} \cdot \lim_{z \rightarrow 1} \int [d\sigma] \delta(\text{Tr}\sigma) Z_{\text{int}}^{U(2), N_f=4}(\sigma, \mathbf{m}'(\mathbf{t}, \eta), \eta') \mathcal{I}_{\Sigma_r}^{\tilde{\Sigma}^{1,R}}(\sigma, \mathbf{m}', z | \xi < 0), \quad (4.37)$$

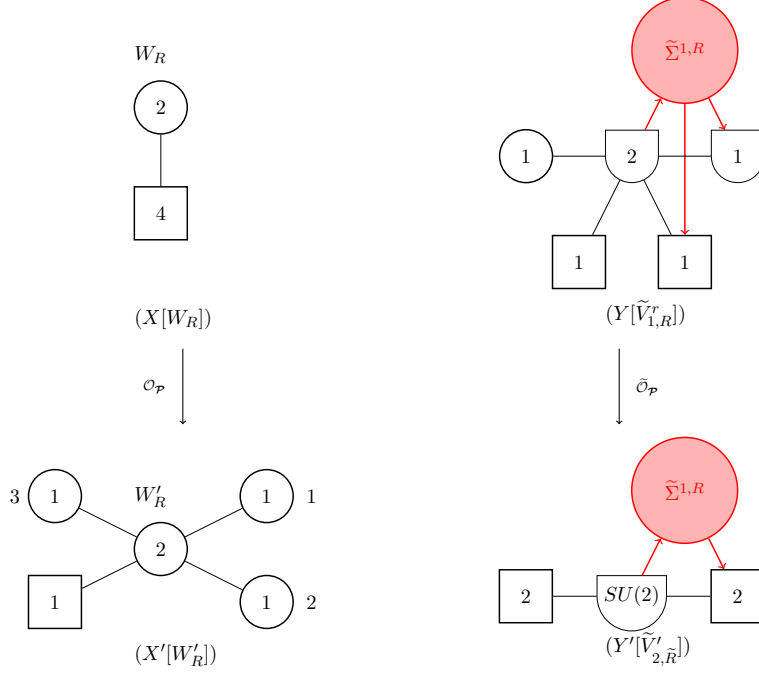

Figure 29: The construction of a Wilson defect in a flavored D_4 quiver gauge theory and its dual vortex defect, using an Abelian gauging operation.

$$C := C(v, \boldsymbol{\eta}, \mathbf{t}) = e^{2\pi i v(\eta_1 + \eta_2 + \eta_3 + 2(t_1 - t_2))}, \quad W_{\text{b.g.}} := W_{\text{b.g.}}(v, R) = e^{2\pi v|R|}, \quad (4.38)$$

$$\mathcal{I}_{\tilde{\Sigma}^{1,R}}(\boldsymbol{\sigma}, \mathbf{m}', z | \boldsymbol{\xi} < 0) = \sum_{w \in R} \prod_{j=1}^2 \prod_{i=1}^2 \frac{\cosh \pi(\sigma_j - m'_i)}{\cosh \pi(\sigma_j + iw_j z - m'_i)}, \quad (4.39)$$

where the masses $\mathbf{m}'(\mathbf{t}, \boldsymbol{\eta})$ are given in (B.14)-(B.17). The coupled 3d-1d system so obtained is denoted as the quiver $Y'[\tilde{V}'_{2,\tilde{R}}]$ in Fig. 29, where \tilde{R} is the restriction of the representation R to $SU(2)$. We interpret this coupled 3d-1d quiver as a vortex defect for the gauge group $SU(2)$ in the representation \tilde{R} (up to a global vortex defect), leading to the following mirror map:

$$\langle W'_R \rangle_{X'}(v; \mathbf{t}, \boldsymbol{\eta}) = \langle \tilde{V}'_{2,\tilde{R}} \rangle_{Y'}(\mathbf{m}'(\mathbf{t}, \boldsymbol{\eta}); v). \quad (4.40)$$

If one implements the dual S -operation on the quiver $Y[\tilde{V}'_{1,R}^l]$ instead of $Y[\tilde{V}'_{1,R}^r]$, it leads to the same final 3d-1d quiver $Y'[\tilde{V}'_{2,\tilde{R}}]$, as shown in App. B.2). The fact that the above vortex defect does not admit a hopping dual, analogous to the case with 3d unitary gauge group, can also be seen from the Type IIB realization of these defects, as we discuss later.

4.2 Generalization I : Mirror of an $Sp(N_c)$ theory with N_f flavors

In this section, we will generalize the results of Section 4.1.1-Section 4.1.3 to a mirror pair involving a D_{N_f} -type quiver gauge theory X' and an $Sp(N_c)$ gauge theory with N_f flavors,

Y' . For concreteness, we will focus on the case $N_c = 2$ and $N_f = 6$, but the extension of our results for generic N_c, N_f , obeying $N_f \geq 2N_c + 1$ (so that Y' is a good quiver), is straightforward.

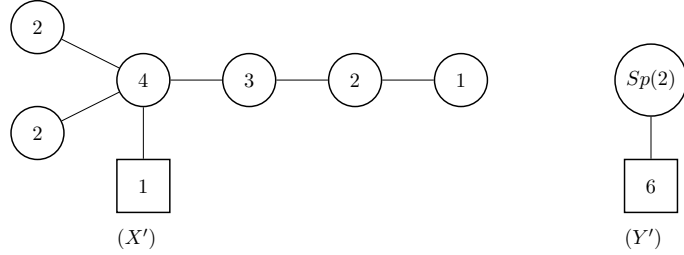
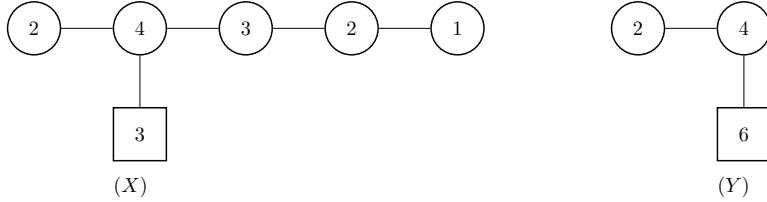

Figure 30: $Sp(2)$ gauge theory with $N_f = 6$ flavors and its mirror dual.

Using the general discussion of Section 3.3-Section 3.4 on constructing defects in generic quiver gauge theories, one can work out the mirror map for defects in the dual pair (X', Y') . As a starting point, we will choose the dual linear quiver pair (X, Y) shown below, and engineer the pair (X', Y') by implementing an elementary non-Abelian gauging operation \mathcal{O}_P .



One can also work out these mirror maps using a Type IIB construction presented, as we shall discuss later in Section 5.2.

Vortex defects: Let us focus on a specific class of vortex defects in the D_6 quiver gauge theory X' in Fig. 30 – vortex defects for the $U(4)$ gauge node at the bifurcated tail. Vortex defects for the gauge nodes away from the bifurcated tail can be handled in a fashion similar to defects in a linear quiver. Consider the vortex defect $V_{2,R}$ in X , realized by the 3d-1d quivers $X[V_{2,R}^l]$ and $X[V_{2,R}^r]$, and the dual Wilson defect \widetilde{W}_R in Y , as shown in Fig. 31.

Let the fundamental masses in theory X be labelled as $\{m_i | i = 1, \dots, 3\}$, such that the $U(2)$ flavor node identified with the 1d flavor symmetry in $X[V_{M,R}^l]$ is associated with the masses m_1, m_2 . The $U(1)$ flavor node identified with the 1d flavor symmetry in $X[V_{M,R}^r]$ is associated with the mass m_3 ⁸.

⁸Here, we are considering the theory X along with a background FI-type coupling to a $U(1) \times U(1)$ symmetry. The Higgs branch and the Coulomb branch symmetries of the combined theory are then $G_H = U(3)$ and $G_C = U(6)$ respectively. The $U(3)$ flavor node can then be split as $U(3) \rightarrow U(2) \times U(1)$, where the $U(2)$ factor talks to the SQM in $X[V_{M,R}^l]$ and the $U(1)$ factor does the same for $X[V_{M,R}^r]$.

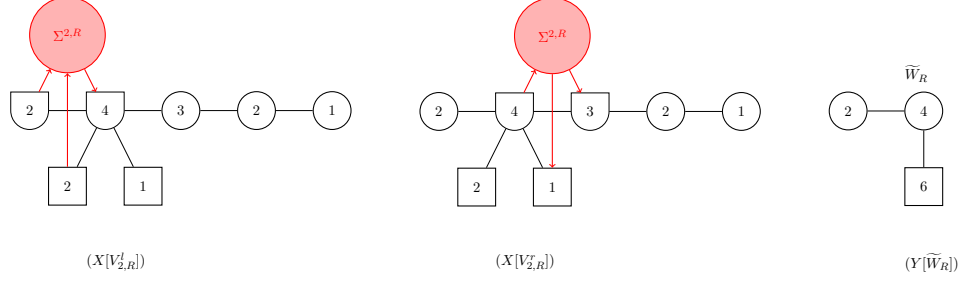

Figure 31: The vortex defect $V_{2,R}$, realized by the deformation of two different 3d-1d quivers - $X[V_{2,R}^l]$ and $X[V_{2,R}^r]$. The dual quiver is $Y[\widetilde{W}_R]$.

Following the general prescription of Section 3.3, let us implement an S -type operation $\mathcal{O}_{\mathcal{P}}$ on the quiver $X[V_{2,R}^l]$, where $\mathcal{O}_{\mathcal{P}}$ consists of a single gauging operation:

$$\mathcal{O}_{\mathcal{P}}(X[V_{M,R}^l]) = G_{\mathcal{P}}^{\alpha}(X[V_{M,R}^l]), \quad (4.41)$$

with the operation $G_{\mathcal{P}}^{\alpha}$ gauging the $U(2)$ flavor node labelled α in $X[V_{M,R}^l]$. The mass parameters associated with $U(2)$ factor to be gauged are therefore chosen as:

$$u_1 = m_1, \quad u_2 = m_2. \quad (4.42)$$

From the general formula (3.37), the partition function $Z^{\mathcal{O}_{\mathcal{P}}(X[V_{2,R}^l])}$ can be identified as the partition function of a coupled 3d-1d quiver $X'[V_{2,R}^{(I)}]$ in Fig. 32. The 3d quiver is a D_6 quiver gauge theory and the SQM is $\Sigma_I^{2,R}$, with the Witten index being computed in the chamber $\xi > 0$. As before, we will redefine the partition function of the new 3d-1d quiver by a global Wilson defect factor, i.e.

$$Z^{(X'[V_{2,R}^{(I)}])} := e^{-2\pi(\frac{\eta_{\alpha}}{2})|R|} Z^{\mathcal{O}_{\mathcal{P}}(X[V_{2,R}^l])}(v; \mathbf{t}, \eta). \quad (4.43)$$

The dual partition function

$$Z^{(Y'[(V_{2,R}^{(I)})^{\vee}])} = e^{-2\pi(\frac{\eta_{\alpha}}{2})|R|} Z^{\widetilde{\mathcal{O}}_{\mathcal{P}}(Y[\widetilde{W}_R])} \quad (4.44)$$

can be computed from the general expressions (3.54)-(3.55), and the abelianization formula (3.32)⁹. The computation, although somewhat tedious, is a straightforward exercise, and we will only state the result here (see App. C for details):

$$\begin{aligned} Z^{(Y'[(V_{2,R}^{(I)})^{\vee}])} &= C(v, \boldsymbol{\eta}, \mathbf{t}) \int [d\boldsymbol{\sigma}] \frac{\delta(\sigma_1 + \sigma_2) \delta(\sigma_3 + \sigma_4) Z_{\text{int}}^{U(4), N_f=6}(\boldsymbol{\sigma}, \mathbf{m}'(\mathbf{t}, \boldsymbol{\eta}), \eta' = 0)}{\sinh \pi \sigma_{13} \sinh \pi \sigma_{14} \sinh \pi \sigma_{23} \sinh \pi \sigma_{24}} \\ &\quad \times \left(\sum_{w \in R} e^{2\pi \sum_j w_j \sigma_j} \right), \\ &= C(v, \boldsymbol{\eta}, \mathbf{t}) \int [d\boldsymbol{\sigma}] \delta(\sigma_1 + \sigma_2) \delta(\sigma_3 + \sigma_4) Z_{\text{int}}^{Sp(2), N_f=6}(\{\sigma_1, \sigma_3\}, \mathbf{m}') \\ &\quad \times \left(\sum_{w \in R} e^{2\pi \sum_j w_j \sigma_j} \right), \end{aligned} \quad (4.45)$$

⁹It is also possible to perform the computation without resorting to the abelianization formula, as we show in App. C.2.

where $C(v, \boldsymbol{\eta}, \mathbf{t})$ is a contact term and $\sigma_{ij} = \sigma_i - \sigma_j$. The function $Z_{\text{int}}^{U(4), N_f=6}$ is the matrix model integrand for a $U(4)$ gauge theory with $N_f = 6$ flavors, and $Z_{\text{int}}^{Sp(2), N_f=6}$ is the analogous function for an $Sp(2)$ gauge theory with $N_f = 6$ flavors. The dual of the 3d-1d coupled system can now be read off from the partition function above. It is given by the quiver $Y'[\widetilde{W}'_{\widetilde{R}}]$ in Fig. 32, where Y' is an $Sp(2)$ gauge theory with $N_f = 6$ flavors and $\widetilde{W}'_{\widetilde{R}}$ is a Wilson defect for the gauge group $Sp(2)$. The representation \widetilde{R} is the restriction of the representation R of $U(4)$ to the subgroup $Sp(2)$, i.e.

$$\begin{aligned} U(4) &\rightarrow Sp(2), \\ R &\rightarrow \bigoplus_{\kappa \in \Delta} R_{\kappa} = \widetilde{R}, \end{aligned} \quad (4.46)$$

where Δ denotes the set of all representations R_{κ} that appear in the decomposition of R with degeneracies. Normalizing the integrals with appropriate partition functions, we obtain the following mirror map of line defects in the pair of dual theories (X', Y') :

$$\langle V'_{2,R} \rangle_{X'}(\mathbf{t}, \boldsymbol{\eta}) = \langle \sum_{\kappa \in \Delta} \widetilde{W}'_{R_{\kappa}} \rangle_{Y'}(\mathbf{m}'(\mathbf{t}, \boldsymbol{\eta})). \quad (4.47)$$

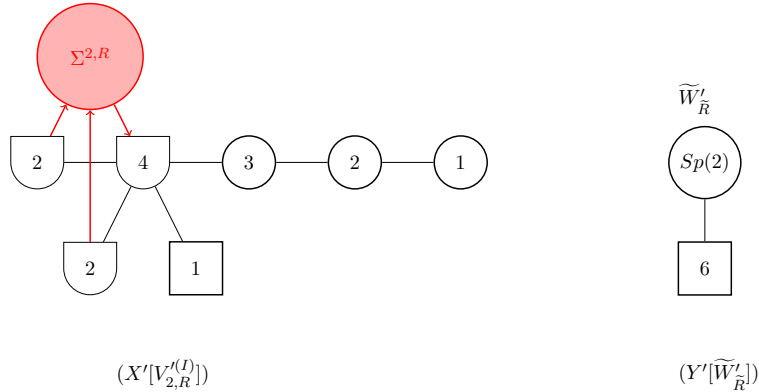

Figure 32: The construction of a vortex defect in the bifurcated quiver gauge theory X' , labelled by a representation R of the gauge node $U(4)$. It is dual to a Wilson defect in the theory Y' (an $Sp(2)$ gauge theory with $N_f = 6$), labelled by a representation \widetilde{R} of $Sp(2)$, where \widetilde{R} is the restriction of the representation R for $Sp(2) \subset U(4)$. The S -type operation $\mathcal{O}_{\mathcal{P}}$ is a non-Abelian gauging operation.

A second coupled 3d-1d quiver $(X'[V'_{2,R}(II)])$ which realizes the same vortex defect can be obtained by implementing the S -type operation (4.41) on the quiver $(X[V'_{2,R}])$ instead. The resultant quiver is shown in Fig. 33, where the Witten index of the SQM should be computed in the chamber $\boldsymbol{\xi} < 0$. Following the same procedure as above, one can show that the dual defect is given by $Y'[\widetilde{W}'_{\widetilde{R}}]$. This leads to the mirror map:

$$\langle V'_{2,R} \rangle_{X'}(\mathbf{t}, \boldsymbol{\eta}) = \langle V'_{2,R}(II) \rangle_{X'}(\mathbf{t}, \boldsymbol{\eta}) = \langle \sum_{\kappa \in \Delta} \widetilde{W}'_{R_{\kappa}} \rangle_{Y'}(\mathbf{m}'(\mathbf{t}, \boldsymbol{\eta})). \quad (4.48)$$

Alternatively, the 3d-1d quiver $(X'[V_{2,R}^{(II)}])$ can be read off by a change of variables in the matrix integral on the RHS of (4.43): $s_j^{(2)} \rightarrow s_j^{(2)} + iw_j z$, where $\mathbf{s}^{(2)}$ denote the matrix model integration variables in the Cartan of the $U(4)$ gauge group of the theory X' .

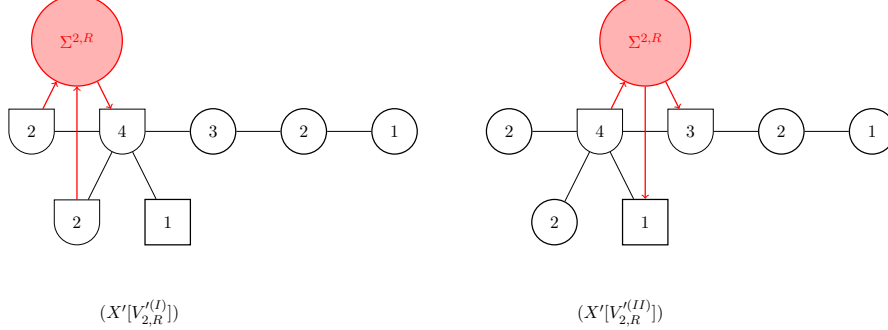

Figure 33: Different coupled 3d-1d quivers realizing the same vortex defect in the bifurcated quiver X' , which is dual to the Wilson defect \widetilde{W}_R' in the $Sp(2)$ gauge theory Y' . The Witten indices for the SQMs in the two cases are computed in the $\xi > 0$ and $\xi < 0$ chambers respectively.

Wilson defects: Analogous to the case of the vortex defect, we will focus on Wilson defects for the $U(4)$ gauge node. The starting point is the Wilson defect W_R in the theory X and the dual vortex defect $\widetilde{V}_{4,R}$ in Y – realized by the two 3d-1d quivers $Y[\widetilde{V}_{4,R}^r]$ and $Y[\widetilde{V}_{4,R}^l]$, as shown in Fig. 34.

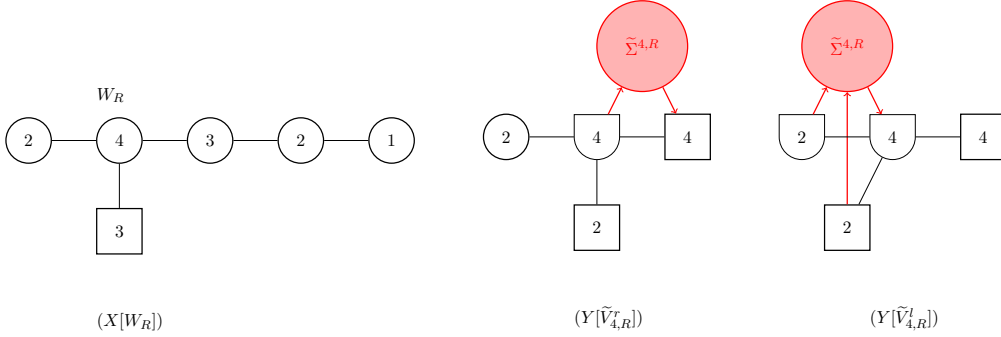

Figure 34: A gauge Wilson defect in the theory X and the dual vortex defect, realized by the deformation of two different 3d-1d quivers - $Y[\widetilde{V}_{4,R}^r]$ and $Y[\widetilde{V}_{4,R}^l]$.

We now implement the non-Abelian S -type operation $\mathcal{O}_{\mathcal{P}}$ on the quiver $X[W_R]$:

$$\mathcal{O}_{\mathcal{P}}(X[W_R]) = G_{\mathcal{P}}^{\beta}(X[W_R]), \quad (4.49)$$

where β labels the $U(3)$ flavor node of $X[W_R]$, and $G_{\mathcal{P}}^{\beta}$ is a gauging operation which splits the $U(3)$ node as a $U(2) \times U(1)$ and gauges the $U(2)$. The mass parameters associated with the gauged $U(2)$ are chosen (by an appropriate choice of \mathcal{P}) as:

$$u_1 = m_1, \quad u_2 = m_2. \quad (4.50)$$

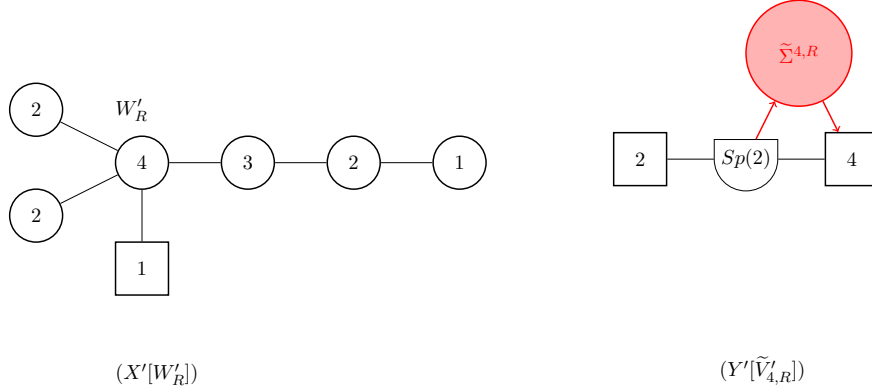

Figure 35: The construction of a Wilson defect in the bifurcated quiver gauge theory X' , labelled by a representation R of the gauge node $U(4)$. It is dual to a vortex defect in the theory Y' (an $Sp(2)$ gauge theory with $N_f = 6$), realized by a 3d-1d system labelled by the representation R for $U(4)$. The Witten index of the SQM in $(Y'[\tilde{V}'_{4,R}])$ should be computed in the chamber $\xi < 0$.

This S -operation on the quiver $X[W_R]$ leads to the defect quiver $X'[W'_R]$ in Fig. 35. The dual operation on the 3d-1d quiver $Y[\tilde{V}'_{4,R}]$ leads to a vortex defect in the theory Y' . The defect can be read off from the dual partition function following the general expressions (3.59)-(3.60), and the abelianization formula (3.32). After a straightforward but tedious computation, we find

$$\begin{aligned}
Z^{(Y'[(W'_R)^\vee])} &= C \cdot W_{\text{b.g.}} \cdot \lim_{z \rightarrow 1} \int [d\sigma] \frac{\delta(\sigma_1 + \sigma_2) \delta(\sigma_3 + \sigma_4) Z_{\text{int}}^{U(4), N_f=6}(\sigma, \mathbf{m}'(\mathbf{t}, \eta), \eta' = 0)}{\sinh \pi \sigma_{13} \sinh \pi \sigma_{14} \sinh \pi \sigma_{23} \sinh \pi \sigma_{24}} \\
&\quad \times \mathcal{I}_{\tilde{\Sigma}_r^{4,R}}(\sigma, \mathbf{m}', z | \xi < 0), \\
&= C \cdot W_{\text{b.g.}} \cdot \lim_{z \rightarrow 1} \int [d\sigma] \delta(\sigma_1 + \sigma_2) \delta(\sigma_3 + \sigma_4) Z_{\text{int}}^{Sp(2), N_f=6}(\{\sigma_1, \sigma_3\}, \mathbf{m}') \\
&\quad \times \mathcal{I}_{\tilde{\Sigma}_r^{4,R}}(\sigma, \mathbf{m}', z | \xi < 0), \tag{4.51}
\end{aligned}$$

where C and $W_{\text{b.g.}}$ are a contact term and a background Wilson defect respectively, while the 1d index $\mathcal{I}_{\tilde{\Sigma}_r^{4,R}}$ is given by

$$\mathcal{I}_{\tilde{\Sigma}_r^{4,R}}(\sigma, \mathbf{m}', z | \xi < 0) = \sum_{w \in R} \prod_{j=1}^4 \prod_{i=3}^6 \frac{\cosh \pi(\sigma_j - m'_i)}{\cosh \pi(\sigma_j + iw_j z - m'_i)}. \tag{4.52}$$

The coupled 3d-1d quiver which realizes the dual vortex defect can be read off from (4.51)-(4.52), and is given by $Y'[\tilde{V}'_{4,R}]$ in Fig. 35. If one implements the dual S -operation on the quiver $Y[\tilde{V}'_{4,R}]$ instead, it leads to the same final 3d-1d quiver $Y'[\tilde{V}'_{4,R}]$, as was the case in the D_4 example studied earlier. One therefore has a mirror map of the following form:

$$\langle W'_R \rangle_{X'}(v; \mathbf{t}, \eta) = \langle \tilde{V}'_{4,R} \rangle_{Y'}(\mathbf{m}'(\mathbf{t}, \eta); v). \tag{4.53}$$

4.3 Adding flavors to the D_4 quiver

In this section, we incorporate the Abelian flavoring-gauging operation in our discussion. This S -operation will allow us to study defects in more general D_4 quiver gauge theories, by adding hypermultiplets to one or more of the gauged flavor nodes. As a simple example, we will study defects for the following dual pair:

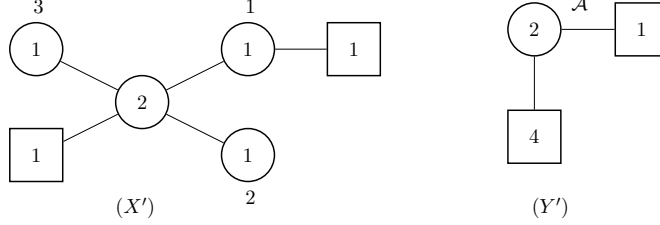

The label \mathcal{A} in the quiver Y' denotes a hypermultiplet in the rank-2 antisymmetric representation of $U(2)$. Note that in contrast to the examples encountered previously in this section, the dual of the D -type quiver gauge theory is a $U(2)$ gauge theory (as opposed to $SU(2)$ or $Sp(N)$ more generally).

Vortex defects: As before, we will focus on vortex defects for the central $U(2)$ gauge node of the D_4 quiver. Consider again the dual pair of defect quivers – $X[V_{2,R}^r]$ and $Y[\widetilde{W}_R]$, as shown in the first line of Fig. 25, and let us implement the following Abelian S -operation $\mathcal{O}_{\mathcal{P}}$ on $X[V_{2,R}^r]$:

$$\mathcal{O}_{\mathcal{P}}(X[V_{2,R}^r]) = G_{\mathcal{P}_3}^{\beta} \circ G_{\mathcal{P}_2}^{\alpha_2} \circ (G \circ F)_{\mathcal{P}_1}^{\alpha_1}(X[V_{2,R}^r]), \quad (4.54)$$

where $\alpha_1 = \alpha$, and α_2 is the residual $U(1)$ flavor node from $U(2)_{\alpha}$ in the theory $G_{\mathcal{P}_1}^{\alpha_1}(X)$. The mass parameters corresponding to the $U(1)^3$ global symmetry are chosen as:

$$u_1 = m_3, \quad u_2 = m_4, \quad u_3 = m_1. \quad (4.55)$$

From the general formula (3.37), the partition function $Z^{\mathcal{O}_{\mathcal{P}}(X[V_{2,R}^r])}$ can be identified as the partition function of a coupled 3d-1d quiver $X'[V_{2,R}^{(I)}]$, where the 3d quiver is the D_4 quiver gauge theory X' and the SQM is shown explicitly in Fig. 36. The Witten index for the SQM is computed in the chamber $\xi < 0$. Redefining the partition function of the new 3d-1d quiver by a global Wilson defect factor, i.e.

$$Z^{(X'[V_{2,R}^{(I)}])} := e^{-2\pi(t_2 - \frac{\eta_1 + \eta_2}{2})|R|} Z^{\mathcal{O}_{\mathcal{P}}(X[V_{2,R}^r])}(v, m_F^{(1)}; \mathbf{t}, \boldsymbol{\eta}), \quad (4.56)$$

where $v = m_2$ and $m_F^{(1)}$ are masses of the fundamental hypers in X' , the dual partition function

$$Z^{(Y'[(V_{2,R}^{(I)})^{\vee}])} = e^{-2\pi(t_2 - \frac{\eta_1 + \eta_2}{2})|R|} Z^{\widetilde{\mathcal{O}}_{\mathcal{P}}(Y[\widetilde{W}_R])} \quad (4.57)$$

can be computed from the general expressions (3.54)-(3.55), as we did in the previous examples. The dual 3d-1d coupled system, which can be read off from the partition function, is given by the quiver $Y'[\widetilde{W}_R]$ in Fig. 36, where Y' is a $U(2)$ gauge theory with $N_f = 4$ fundamental hypers and a single rank-2 antisymmetric hyper, and \widetilde{W}_R is a Wilson defect in

a representation R for the gauge group $U(2)$. Normalizing the integrals with appropriate partition functions, we obtain the following mirror map of line defects in the pair of dual theories (X', Y') :

$$\langle V'_{2,R}{}^{(I)} \rangle_{X'}(v, m_F^{(1)}; \mathbf{t}, \boldsymbol{\eta}) = \langle \widetilde{W}'_R \rangle_{Y'}(\mathbf{m}'(\mathbf{t}, \boldsymbol{\eta}), \eta'(v, m_F^{(1)})). \quad (4.58)$$

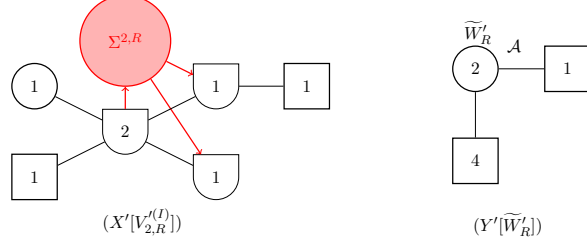

Figure 36: A 3d-1d system which realizes a vortex defect in the flavored D_4 quiver, and the dual Wilson defect in the $U(2)$ gauge theory.

A second coupled 3d-1d quiver $(X'[V'_{2,R}{}^{(II)}])$ which realizes the same vortex defect can be obtained by implementing the S -type operation (4.54) on the quiver $(X[V'_{2,R}{}^I])$ instead. The resultant quiver is shown in Fig. 37, and the Witten index should be computed in the chamber $\boldsymbol{\xi} > 0$. Following the same procedure as above, one can show that the dual defect is given by $Y'[\widetilde{W}'_R]$. The mirror map therefore assumes the final form:

$$\langle V'_{2,R}{}^{(II)} \rangle_{X'}(v, m_F^{(1)}; \mathbf{t}, \boldsymbol{\eta}) = \langle V'_{2,R}{}^{(I)} \rangle_{X'}(v, m_F^{(1)}; \mathbf{t}, \boldsymbol{\eta}) = \langle \widetilde{W}'_R \rangle_{Y'}(\mathbf{m}'(\mathbf{t}, \boldsymbol{\eta}), \eta'(v, m_F^{(1)})). \quad (4.59)$$

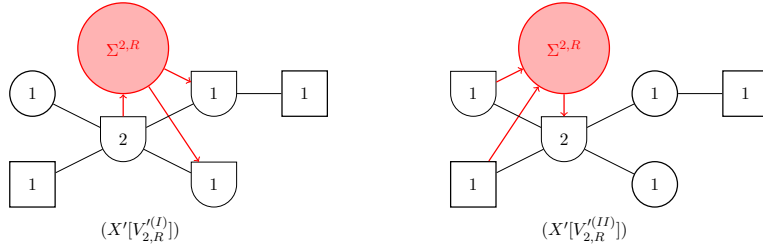

Figure 37: Two different realizations of a vortex defect as 3d-1d systems in a flavored D_4 quiver. The Witten index for the SQM in the first case should be computed in the chamber $\boldsymbol{\xi} < 0$, while for the second case it should be computed in $\boldsymbol{\xi} > 0$.

Wilson defects: We will focus on Wilson defects for central $U(2)$ gauge node of the D_4 quiver X' . The starting point is the dual pair of defects – the Wilson defect W_R in the theory X and the vortex defect $\widetilde{V}'_{1,R}$ in the theory Y , where the latter is realized by as a deformation of the right 3d-1d quiver. The pair $(W_R, \widetilde{V}'_{1,R})$ is shown in the first line of Fig. 29. We implement the Abelian S -type operation $\mathcal{O}_{\mathcal{P}}$ on the system $X[W_R]$, where $\mathcal{O}_{\mathcal{P}}$

is given as:

$$\mathcal{O}_{\mathcal{P}}(X[W_R]) = G_{\mathcal{P}_3}^{\alpha_3} \circ G_{\mathcal{P}_2}^{\alpha_2} \circ (G \circ F)_{\mathcal{P}_1}^{\alpha_1}(X[W_R]), \quad (4.60)$$

which corresponds to the following choice of the $U(1)^3$ global symmetry to be gauged:

$$u_1 = m_1, \quad u_2 = m_2, \quad u_3 = m_4. \quad (4.61)$$

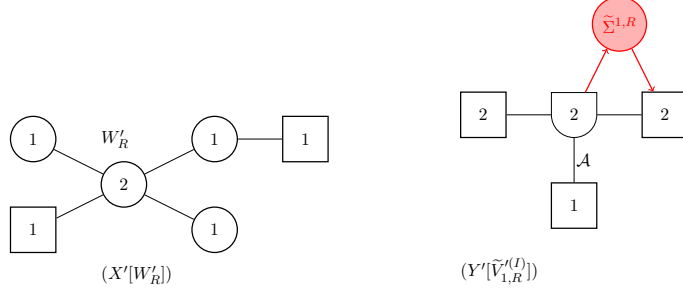

Figure 38: Wilson defect in a flavored D_4 quiver, and its dual vortex defect in a $U(2)$ gauge theory.

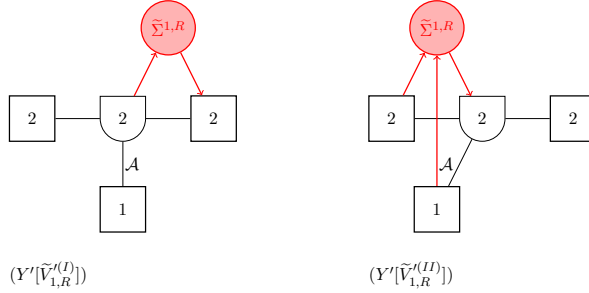

Figure 39: Two different realizations of the vortex defect dual to the Wilson defect in the flavored D_4 quiver. The Witten index for the SQM in the first case should be computed in the chamber $\xi < 0$, while for the second case it should be computed in $\xi > 0$.

This S -operation on the quiver $X[W_R]$ leads to the defect quiver $X'[W'_R]$ in Fig. 38. The dual S -operation acting on the 3d-1d quiver $Y[\tilde{V}'_{1,R}]$ leads to another 3d-1d quiver, which can be read off from the dual partition function computed from (3.59)-(3.60).

$$Z^{(Y'[(W'_R)^\vee])} = Z^{\tilde{\mathcal{O}}_{\mathcal{P}}(Y[\tilde{V}'_{1,R}])}, \quad (4.62)$$

$$Z^{(Y'[(W'_R)^\vee])} = C \cdot W_{\text{b.g.}} \cdot \lim_{z \rightarrow 1} \int [d\sigma] Z_{\text{int}}^{(Y')}(\sigma, \mathbf{m}'(\mathbf{t}, \boldsymbol{\eta}), \eta'(v, m_F^{(1)})) \mathcal{I}^{\tilde{\Sigma}^{1,R}}(\sigma, \mathbf{m}', z | \xi < 0), \quad (4.63)$$

$$C := C(v, \boldsymbol{\eta}, \mathbf{t}) = e^{2\pi i v(\eta_1 + \eta_2 + \eta_3 + 2(t_1 - t_2))}, \quad W_{\text{b.g.}} := W_{\text{b.g.}}(v, R) = e^{2\pi v |R|}, \quad (4.64)$$

$$Z_{\text{int}}^{(Y')} = \frac{\sinh^2 \pi(\sigma_1 - \sigma_2) e^{2\pi i(m_F^{(1)} - v)\text{Tr}\sigma}}{\cosh \pi(\text{Tr}\sigma) \prod_j \prod_{a=1}^4 \cosh \pi(\sigma_j - m'_a(\mathbf{t}, \boldsymbol{\eta}))}, \quad (4.65)$$

$$\mathcal{I}^{\tilde{\Sigma}^{1,R}}(\boldsymbol{\sigma}, \mathbf{m}', z | \boldsymbol{\xi} < 0) = \sum_{w \in R} \prod_{j=1}^2 \prod_{a=1}^2 \frac{\cosh \pi(\sigma_j - m'_a(\mathbf{t}, \boldsymbol{\eta}))}{\cosh \pi(\sigma_j + iw_j z - m'_a(\mathbf{t}, \boldsymbol{\eta}))}. \quad (4.66)$$

The resultant 3d-1d quiver can be read off from the RHS of (4.63), and is given by $Y'[\tilde{V}'_{1,R}^{(I)}]$ in Fig. 38.

Again, one could have used the dual pair $(W_R, \tilde{V}'_{1,R})$ instead as a starting point. The dual partition function can be written directly from (3.59)-(3.60), or by a change of variables $\sigma_j \rightarrow \sigma_j - iw_j z$ in the matrix integral (4.63):

$$Z^{(Y'[(W'_R)^\vee])} = Z^{\tilde{\mathcal{O}}_{\mathcal{P}}(Y[\tilde{V}'_{1,R}])}, \quad (4.67)$$

$$Z^{(Y'[(W'_R)^\vee])} = C \cdot W'_{\text{b.g.}} \cdot \lim_{z \rightarrow 1} \int [d\boldsymbol{\sigma}] Z_{\text{int}}^{(Y')}(\boldsymbol{\sigma}, \mathbf{m}'(\mathbf{t}, \boldsymbol{\eta}), \eta'(v, m_F^{(1)})) \mathcal{I}^{\tilde{\Sigma}^{1,R}}(\boldsymbol{\sigma}, \mathbf{m}', z | \boldsymbol{\xi} > 0), \quad (4.68)$$

$$C := C(v, \boldsymbol{\eta}, \mathbf{t}) = e^{2\pi i v(\eta_1 + \eta_2 + \eta_3 + 2(t_1 - t_2))}, \quad W'_{\text{b.g.}} := W'_{\text{b.g.}}(m_F^{(1)}, R) = e^{2\pi m_F^{(1)} |R|}, \quad (4.69)$$

$$Z_{\text{int}}^{(Y')} = \frac{\sinh^2 \pi(\sigma_1 - \sigma_2) e^{2\pi i(m_F^{(1)} - v)\text{Tr}\boldsymbol{\sigma}}}{\cosh \pi(\text{Tr}\boldsymbol{\sigma}) \prod_j \prod_{a=1}^4 \cosh \pi(\sigma_j - m'_a(\mathbf{t}, \boldsymbol{\eta}))}, \quad (4.70)$$

$$\mathcal{I}^{\tilde{\Sigma}^{1,R}}(\boldsymbol{\sigma}, \mathbf{m}', z | \boldsymbol{\xi} < 0) = \sum_{w \in R} \frac{\cosh \pi(\text{Tr}\boldsymbol{\sigma})}{\cosh \pi(\text{Tr}\boldsymbol{\sigma} - i|R|z)} \prod_{j=1}^2 \prod_{a=3}^4 \frac{\cosh \pi(\sigma_j - m'_a(\mathbf{t}, \boldsymbol{\eta}))}{\cosh \pi(\sigma_j - iw_j z - m'_a(\mathbf{t}, \boldsymbol{\eta}))}. \quad (4.71)$$

The dual defect is given by the 3d-1d quiver $Y'[\tilde{V}'_{1,R}^{(II)}]$, as shown in Fig. 39. This leads to the following mirror map:

$$\langle W'_R \rangle_{X'}(v, m_F^{(1)}; \mathbf{t}, \boldsymbol{\eta}) = \langle \tilde{V}'_{1,R}^{(I)} \rangle_{Y'}(-\mathbf{m}'(\mathbf{t}, \boldsymbol{\eta}); \eta'(v, m_F^{(1)})) = \langle \tilde{V}'_{1,R}^{(II)} \rangle_{Y'}(-\mathbf{m}'(\mathbf{t}, \boldsymbol{\eta}); \eta'(v, m_F^{(1)})). \quad (4.72)$$

4.4 Generalization II : Affine D -type quivers

In this section, we extend our analysis to affine D -type quiver gauge theories with additional flavors. In our previous examples involving D -type quivers, we studied vortex and Wilson defects for gauge nodes located at the bifurcated tail. An affine D -type quiver consists of two such bifurcated tails, and therefore defects in these theories can be studied without introducing any new ingredient. For concreteness, we will study a \hat{D}_4 quiver X' with gauge group $G = U(2) \times U(1)^4$ and two fundamental hypermultiplets and its mirror dual Y' , which is a $U(2)$ gauge theory with $N_f = 4$ fundamental flavors and two additional hypermultiplets in the rank-2 antisymmetric representation of $U(2)$. The quiver gauge theories are shown below.

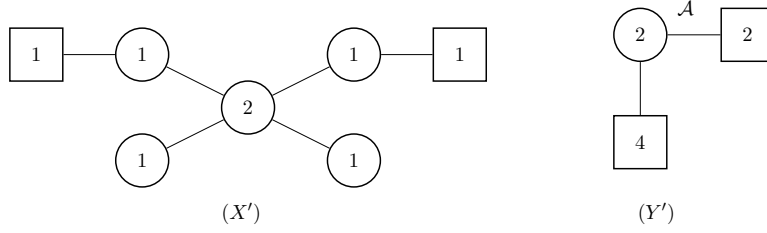

We will focus on vortex defects and Wilson defects for the central $U(2)$ gauge node of the \widehat{D}_4 quiver and their mirror duals. Other defects can be addressed using our general construction in a similar fashion. The partition function computations are very similar to the analogous ones in Section 4.3, and therefore we simply state the final results.

Vortex defect: The starting point is the dual pair of defect quivers – $X[V_{2,R}^r]$ and $Y[\widetilde{W}_R]$, as shown in the first line of Fig. 25. The fundamental masses in theory X be labelled as $\{m_i | i = 1, \dots, 4\}$, such that the $U(2)_\beta$ and the $U(2)_\alpha$ flavor nodes in $X[V_{2,R}^r]$ are associated with the masses (m_1, m_2) and (m_3, m_4) . Let us implement the following Abelian S -operation $\mathcal{O}_{\mathcal{P}}$ on $X[V_{2,R}^r]$:

$$\mathcal{O}_{\mathcal{P}}(X[V_{2,R}^r]) = G_{\mathcal{P}_4}^{\beta_2} \circ (G \circ F)_{\mathcal{P}_3}^{\beta_1} \circ (G)_{\mathcal{P}_2}^{\alpha_2} \circ (G \circ F)_{\mathcal{P}_1}^{\alpha_1}(X[V_{2,R}^r]), \quad (4.73)$$

where $\alpha_1 = \alpha$, and α_2 is the residual $U(1)$ flavor node from $U(2)_\alpha$ in the theory $G_{\mathcal{P}_1}^{\alpha_1}(X)$. Similarly, $\beta_1 = \beta$, and β_2 is the residual $U(1)$ flavor node from $U(2)_\beta$. The mass parameters corresponding to the $U(1)^4$ global symmetry to be gauged are chosen as:

$$u_1 = m_3, \quad u_2 = m_4, \quad u_3 = m_1, \quad u_4 = m_2. \quad (4.74)$$

The partition function $Z^{\mathcal{O}_{\mathcal{P}}(X[V_{2,R}^r])}$ can be identified as the partition function of a coupled 3d-1d quiver $X'[V_{2,R}^{\prime(I)}]$, where the 3d quiver is the \widehat{D}_4 quiver gauge theory X' , and the SQM is shown in Fig. 36. The Witten index for the SQM is computed in the chamber $\xi < 0$. We redefine the partition function of the new 3d-1d quiver by a global Wilson defect factor, i.e.

$$Z^{(X'[V_{2,R}^{\prime(I)}])} := e^{-2\pi(t_1 + \frac{\eta_3 + \eta_4}{2})|R|} Z^{\mathcal{O}_{\mathcal{P}}(X[V_{2,R}^r])}(m_F^{(1)}, m_F^{(3)}; \mathbf{t}, \boldsymbol{\eta}), \quad (4.75)$$

where $m_F^{(1)}, m_F^{(3)}$ are masses of the fundamental hypers in X' for the $U(1)_1$ and the $U(1)_3$ respectively. The dual defect is given by the quiver $Y'[\widetilde{W}'_R]$ in Fig. 40, where \widetilde{W}'_R is a Wilson defect in a representation R for the gauge group $U(2)$. A second coupled 3d-1d quiver ($X'[V_{2,R}^{\prime(II)}]$) which realizes the same vortex defect can be obtained by implementing the S -type operation (4.73) on the quiver ($X[V_{2,R}^l]$) instead. The 3d-1d quiver is shown in Fig. 41, where the Witten index for the SQM should be computed in the chamber $\xi > 0$. Computing the dual partition function, one can again show that the dual defect is given by $Y'[\widetilde{W}'_R]$. This leads to the following mirror map:

$$\boxed{\langle V_{2,R}^{\prime(II)} \rangle_{X'}(m_F^{(1)}, m_F^{(3)}; \mathbf{t}, \boldsymbol{\eta}) = \langle V_{2,R}^{\prime(I)} \rangle_{X'}(m_F^{(1)}, m_F^{(3)}; \mathbf{t}, \boldsymbol{\eta}) = \langle \widetilde{W}'_R \rangle_{Y'}(\mathbf{m}'(\mathbf{t}, \boldsymbol{\eta}), \eta'(m_F^{(1)}, m_F^{(3)}))}. \quad (4.76)$$

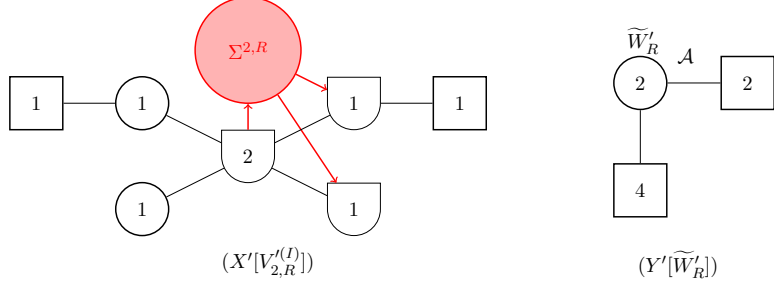

Figure 40: A 3d-1d system which realizes a vortex defect in the flavored \widehat{D}_4 quiver, and the dual Wilson defect in a $U(2)$ gauge theory.

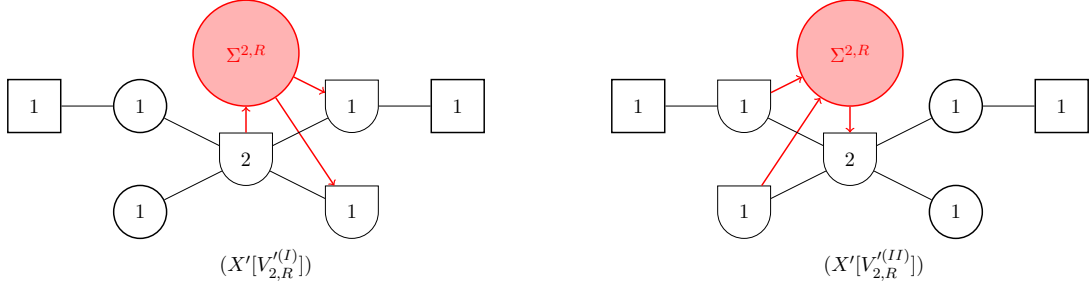

Figure 41: Two different realizations of a vortex defect as 3d-1d systems in a flavored \widehat{D}_4 quiver, dual to a Wilson defect in the $U(2)$ gauge theory of Fig. 40. The Witten index for the SQM in the first case should be computed in the chamber $\xi < 0$, while for the second case it should be computed in $\xi > 0$.

Wilson defect: Consider Wilson defects for central $U(2)$ gauge node of the \widehat{D}_4 quiver X' . The starting point is the dual pair of defects – the Wilson defect W_R in the theory X and the vortex defect $\tilde{V}_{1,R}$ in the theory Y , where the latter is realized by as a deformation of two 3d-1d quivers $\tilde{V}_{1,R}^r$ and $\tilde{V}_{1,R}^l$. The pair $(W_R, \tilde{V}_{1,R}^r)$ is shown in the first line of Fig. 29. We implement the Abelian S -type operation $\mathcal{O}_{\mathcal{P}}$ on the system $X[W_R]$, where $\mathcal{O}_{\mathcal{P}}$ is given as:

$$\mathcal{O}_{\mathcal{P}}(X[W_R]) = G_{\mathcal{P}_4}^{\alpha_4} \circ (G \circ F)_{\mathcal{P}_3}^{\alpha_3} \circ G_{\mathcal{P}_2}^{\alpha_2} \circ (G \circ F)_{\mathcal{P}_1}^{\alpha_1}(X[W_R]), \quad (4.77)$$

which corresponds to the following choice of the $U(1)^4$ global symmetry to be gauged:

$$u_1 = m_1, \quad u_2 = m_2, \quad u_3 = m_3, \quad u_4 = m_4. \quad (4.78)$$

This S -operation on the quiver $X[W_R]$ leads to the defect quiver $X'[W'_R]$ in Fig. 42. The dual vortex defect can be read off from the dual partition function as before, and is given by the 3d-1d quiver $Y'[\tilde{V}'_{1,R}^{(I)}]$, where the Witten index of the 1d quiver is computed in the chamber $\xi < 0$. Starting from the dual pair $(W_R, \tilde{V}_{1,R}^l)$ instead, the dual defect is given by the 3d-1d quiver $Y'[\tilde{V}'_{1,R}^{(II)}]$, as shown in Fig. 43. In this case, the Witten index of

the 1d quiver is computed in the chamber $\xi > 0$. This leads to the following mirror map:

$$\langle W'_R \rangle_{X'}(v, \mathbf{m}_F; \mathbf{t}, \boldsymbol{\eta}) = \langle \widetilde{V}'_{1,R} \rangle_{Y'}(-\mathbf{m}'(\mathbf{t}, \boldsymbol{\eta}); \eta(v, \mathbf{m}_F)) = \langle \widetilde{V}'_{1,R} \rangle_{Y'}(-\mathbf{m}'(\mathbf{t}, \boldsymbol{\eta}); \eta(v, \mathbf{m}_F)), \quad (4.79)$$

where $\mathbf{m}_F = (m_F^{(1)}, m_F^{(3)})$ collectively denotes the fundamental masses in the \widehat{D}_4 quiver gauge theory.

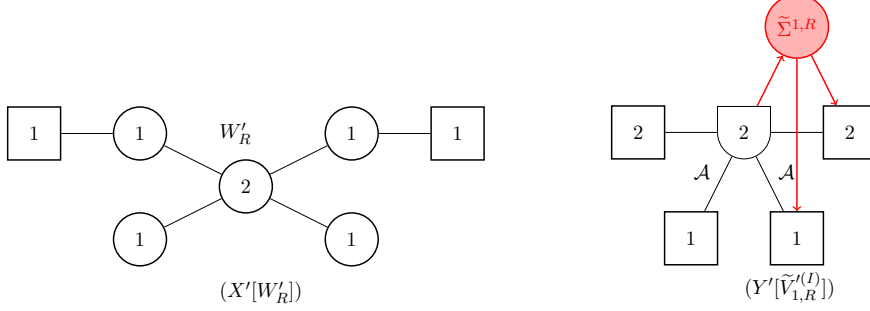

Figure 42: Wilson defect in a flavored \widehat{D}_4 quiver, and its dual vortex defect in a $U(2)$ gauge theory.

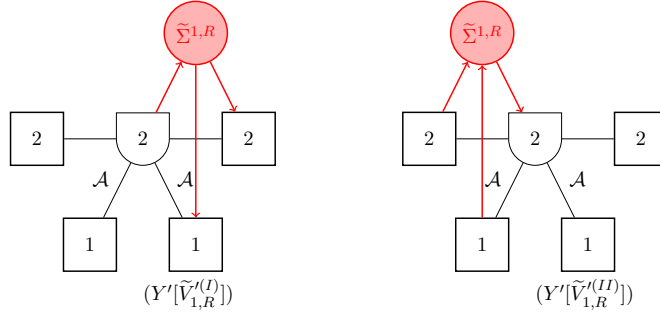

Figure 43: Hopping duals for the vortex defect mirror dual to the Wilson defect W'_R in the flavored \widehat{D}_4 quiver X' . The Witten index for the SQM in the first case should be computed in the chamber $\xi < 0$, while for the second case it should be computed in $\xi > 0$.

4.5 Adding defects to the D_4 quiver

In this section, we incorporate S -type operations involving defect operations in our discussion. These S -type operations can act non-trivially on the coupled SQM, in addition to the 3d quiver and its coupling to the SQM. We will focus on an example where we introduce a vortex defect in the D_4 quiver gauge theory encountered in Section 4.3 and then use the general prescription of Section 3.4 to find the dual defect. A Wilson defect can be addressed in a similar fashion, as discussed in Section 3.4.

The starting point is the dual pair of defects $(V'_{2,R}, \widetilde{W}'_R)$ for the theories X and Y respectively, as shown in the first line of Fig. 44. Let the fundamental masses in theory

X be labelled as $\{m_i|i = 1, \dots, 4\}$, such that the $U(2)$ flavor node labelled α in $X[V_{M,R}^T]$ is associated with the masses m_3, m_4 . Following the general prescription of Section 3.3, we implement an Abelian S -type operation $\mathcal{O}_{\mathcal{P}}$ on the system $X[V_{2,R}^T]$, consisting of three elementary Abelian ones – two gauging operations and a single flavoring-defect-gauging operation:

$$\mathcal{O}_{\mathcal{P}}(X[V_{2,R}^T]) = G_{\mathcal{P}_3}^{\beta} \circ G_{\mathcal{P}_2}^{\alpha_2} \circ (G \circ D \circ F)_{\mathcal{P}_1}^{\alpha_1}(X[V_{2,R}^T]), \quad (4.80)$$

where $\alpha_1 = \alpha$, and α_2 is the residual $U(1)$ flavor node from $U(2)_{\alpha}$ in the theory $(G \circ D \circ F)_{\mathcal{P}_1}^{\alpha_1}(X)$. The mass parameters corresponding to the $U(1)^3$ global symmetry are chosen as:

$$u_1 = m_3, \quad u_2 = m_4, \quad u_3 = m_1. \quad (4.81)$$

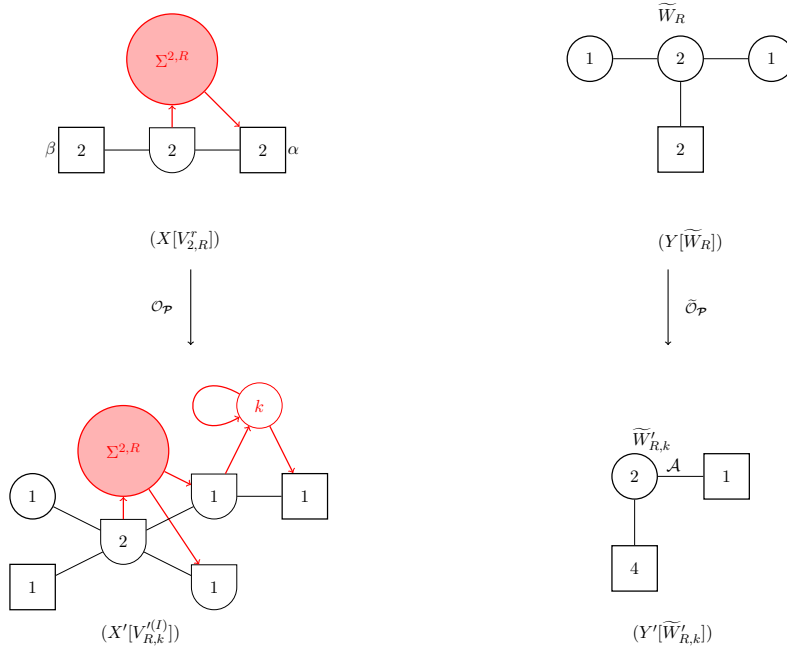

Figure 44: Construction of a 3d-1d system which realizes a vortex defect in the flavored D_4 quiver and the dual Wilson defect in the mirror $U(2)$ gauge theory, using an Abelian S -type operation $\mathcal{O}_{\mathcal{P}}$. The S -type operation, in this case, involves a Type-A defect operation.

We will choose the defect operation D such that it introduces a vortex defect of charge k for the $U(1)_1$ gauge node of the D_4 quiver – we denote it as $V_{1,k}^{(1)}$. From the equation (3.38) (where both D and \mathcal{D} are now non-trivial), the partition function of the 3d-1d quiver $\mathcal{O}_{\mathcal{P}}(X[V_{2,R}^T])$ can then be written down as follows:

$$Z^{\mathcal{O}_{\mathcal{P}}(X[V_{2,R}^T])} = \lim_{z \rightarrow 1} \int \prod_{i=1}^3 du_i [ds] \mathcal{Z}_{\mathcal{O}_{\mathcal{P}}}(\mathbf{u}, \boldsymbol{\eta}, \mathbf{m}_F, z | \Sigma'^k) Z_{\text{int}}^{(X[V_{2,R}^T], \mathcal{P})}(\mathbf{s}, \mathbf{u}, \mathbf{v}, \mathbf{t}, z), \quad (4.82)$$

$$Z_{\text{int}}^{(X[V_{2,R}^T], \mathcal{P})}(\mathbf{s}, \mathbf{u}, \mathbf{v}, \mathbf{t}, z) = Z_{\text{int}}^{(X)}(\mathbf{s}, \mathbf{u}, \mathbf{v}, \mathbf{t}) W_{\text{b.g.}}(\mathbf{t}, R) \mathcal{I}^{\Sigma'^{2,R}}(\mathbf{s}, \mathbf{u}, z | \boldsymbol{\xi} < 0), \quad (4.83)$$

where the functions $Z_{\text{int}}^{(X)}$, $W_{\text{b.g.}}$, and $\mathcal{I}_{\Sigma_r^{2,R}}$ are given in (4.9)-(4.11). The function $\mathcal{Z}_{\mathcal{O}_{\mathcal{P}}}$ can be assembled from (3.10), (3.11) and (3.21), as follows:

$$\mathcal{Z}_{\mathcal{O}_{\mathcal{P}}}(\mathbf{u}, \boldsymbol{\eta}, \mathbf{m}_F, z|\Sigma_r^{k'}) = \prod_{i=1}^3 Z_{\text{FI}}(\mathbf{u}, \boldsymbol{\eta}) Z_{1\text{-loop}}^{\text{hyper}}(u_1, m_F^{(1)}) W_{\text{b.g.}}(\mathbf{t}, \boldsymbol{\eta}, k) \mathcal{I}_{\Sigma_r^{k'}}(u_1, m_F^{(1)}, z|\xi' < 0), \quad (4.84)$$

where $W_{\text{b.g.}}$ is a global Wilson defect, and $\mathcal{I}_{\Sigma_r^{k'}}$ is the Witten index of a SQM $\Sigma_r^{k'}$ – a $U(k)$ gauge theory with a single adjoint chiral and a single fundamental and anti-fundamental chiral. Explicitly, we have

$$W_{\text{b.g.}}(\mathbf{t}, \boldsymbol{\eta}, k) = e^{2\pi k(2t_2 - \eta_1 - \eta_2)}, \quad (4.85)$$

$$\mathcal{I}_{\Sigma_r^{k'}}(u_1, m_F^{(1)}, z|\xi' < 0) = \frac{\cosh \pi(u_1 - m_F^{(1)})}{\cosh \pi(u_1 - m_F^{(1)} + ikz)}. \quad (4.86)$$

The expression on the RHS of (4.82) can be readily identified as the partition function of a 3d-1d system, where the 3d theory is the D_4 quiver gauge theory X' with a gauge group $G' = U(2) \times U(1)^3$, with a pair of coupled SQM $\Sigma_r^{2,R}$ and $\Sigma_r^{k'}$. Let us denote the resultant vortex defect as $V_{2,R}^{(I)} \cdot V_{1,k}^{(1)} := V_{R,k}^{(I)}$, and define the defect partition function as :

$$Z^{(X'[V_{R,k}^{(I)}])} := e^{-2\pi(t_2 - \frac{\eta_1 + \eta_2}{2})|R|} \mathcal{Z}_{\mathcal{O}_{\mathcal{P}}}(X[V_{R,k}^{(I)}])(v, m_F^{(1)}; \mathbf{t}, \boldsymbol{\eta}). \quad (4.87)$$

The dual partition function can be computed following the general expressions (3.54)-(3.55), and can be written as:

$$Z^{(Y'[(V_{R,k}^{(I)})^\vee])} = C_{X'Y'} \cdot \int [d\boldsymbol{\sigma}] e^{2\pi i(m_f^{(1)} - v)\text{Tr}\boldsymbol{\sigma}} Z_{1\text{-loop}}^{(Y')}(\boldsymbol{\sigma}, \mathbf{m}'(\mathbf{t}, \boldsymbol{\eta})) e^{2\pi k\text{Tr}\boldsymbol{\sigma}} \left(\sum_{w \in R} e^{2\pi \sum_j w_j \sigma_j} \right), \quad (4.88)$$

where Y' is the quiver in Fig. 44, with $C_{X'Y'}(v, m_f^{(1)}, \boldsymbol{\eta}, \mathbf{t})$ and $Z_{1\text{-loop}}^{(Y')}$ being a contact term and the 1-loop contribution to the partition function of Y' . The dual defect can now be read off from the RHS of the above equation: it is a product of a Wilson defect \widetilde{W}'_R for the gauge group $U(2)$ of Y' in a representation R and a Wilson defect \widetilde{W}'_k of charge k in the $U(1)$ subgroup of $U(2)$. We denote the combined Wilson defect as $\widetilde{W}'_{R,k}$. This leads to the following mirror map:

$$\boxed{\langle V_{R,k}^{(I)} \rangle_{X'}(v, m_F^{(1)}; \mathbf{t}, \boldsymbol{\eta}) = \langle \widetilde{W}'_{R,k} \rangle_{Y'}(\mathbf{m}'(\mathbf{t}, \boldsymbol{\eta}), \eta'(v, m_F^{(1)}))}. \quad (4.89)$$

The above 3d-1d quiver can be recast in the standard form, where the 3d theory is coupled with a single SQM of the form of given in Fig. 3. This can be seen by the following change of variables in the matrix integral (4.82):

$$u_1 \rightarrow u_1 - ikz, \quad u_2 \rightarrow u_2 - ikz, \quad (4.90)$$

such that the partition function can be recast in the form:

$$\begin{aligned} Z^{\mathcal{O}\mathcal{P}(X[V_{2,R}^r])} = \lim_{z \rightarrow 1} \int \prod_{i=1}^3 du_i \left[ds \right] \prod_{i=1}^3 Z_{\text{FI}}(\mathbf{u}, \boldsymbol{\eta}) Z_{1\text{-loop}}^{\text{hyper}}(u_1, m_F^{(1)}) Z_{\text{int}}^{(X)}(\mathbf{s}, \mathbf{u}, v, \mathbf{t}) W'_{\text{b.g.}}(\mathbf{t}, k, R) \\ \times \mathcal{I}^{\Sigma_r^{2,R,k}}(\mathbf{s}, \mathbf{u}, z | \boldsymbol{\xi} < 0). \end{aligned} \quad (4.91)$$

The background Wilson defect and the Witten index contribution on the RHS are given as:

$$W'_{\text{b.g.}}(\mathbf{t}, k, R) = e^{2\pi(2k+|R|)t_2}, \quad (4.92)$$

$$\mathcal{I}^{\Sigma_r^{2,R,k}}(\mathbf{s}, \mathbf{u}, z | \boldsymbol{\xi} < 0) = \sum_{w \in R} \prod_{j=1}^2 \prod_{i=1}^2 \frac{\cosh \pi(s_j - u_i)}{\cosh \pi(s_j + i(w_j + k)z - u_i)}. \quad (4.93)$$

There are multiple ways of writing down the resultant SQM $\Sigma_r^{2,R,k}$ from the original SQM $\Sigma_r^{2,R}$ as a quiver, where the different quivers are related by 1d Seiberg duality. A convenient choice for the quiver would be the following. Given $\Sigma_r^{2,R}$ of the form Fig. 3, the SQM $\Sigma_r^{2,R}$ can be obtained by substituting $n_P \rightarrow n_P + 2k$, keeping all the other $\{n_i\}$ fixed. Analogous to the previous examples, this 3d-1d quiver will have a standard hopping dual, which can be read off at the level of the matrix integral by the change of variables $s_j \rightarrow s_j - i(w_j + k)z$.

5 Interlude: Type IIB construction of defects in quiver gauge theories

In this section, we discuss the Type IIB construction of vortex and Wilson defects in D -type quivers with unitary gauge groups, and the S-dual configurations which allow one to read off the mirror map of line defects. In Section 5.1, we discuss configurations without any defects, before incorporating them in Section 5.2.

5.1 Type IIB configurations involving orbifold/orientifold planes

5.1.1 D3-branes ending on orbifolds

Let us extend our discussion of Section 2.2.1 to 3d quivers for which the Type IIB configuration involves D3-branes ending on orbifold 5-planes, in addition to the NS5 and D5-branes. Generically, these boundary conditions lead to bifurcated/D-type 3d quiver gauge theories with unitary gauge groups.

Given a Type IIB configuration of D3-D5-NS5-branes oriented as (2.15), consider an \mathbb{Z}_2 -orbifolding operation of the form $\mathcal{I}_4(-1)^{F_L}$, where

$$\mathcal{I}_4 : x^{3,4,5,6} \rightarrow -x^{3,4,5,6}, \quad (5.1)$$

and $(-1)^{F_L}$ counts the number of left-moving worldsheet fermions modulo 2. The fixed point of the orbifolding operation is the 5-plane located at the point $x^{3,4,5,6} = 0$ in the transverse direction, and we denote the 5-plane as Orb5. The supersymmetry preserved on

Orb5 is the same as that preserved on the NS5-brane [7]. The respective world-volumes of the D3, D5, NS5-branes and the Orb5-plane can be summarized as:

$$\begin{aligned}
\text{D3: } & \mathbb{R}^{2,1} \times L \times \{\mathbf{X}\}_{4,5,6} \times \{\mathbf{Y}\}_{7,8,9} \\
\text{D5: } & \mathbb{R}^{2,1} \times \{X_3\} \times \mathbb{R}^3_{4,5,6} \times \{\mathbf{Y}'\}_{7,8,9} \\
\text{NS5: } & \mathbb{R}^{2,1} \times \{X'_3\} \times \{\mathbf{X}'\}_{4,5,6} \times \mathbb{R}^3_{7,8,9}, \\
\text{Orb5: } & \mathbb{R}^{2,1} \times \{\mathbf{0}\}_{3,4,5,6} \times \mathbb{R}^3_{7,8,9}.
\end{aligned} \tag{5.2}$$

Consider a stack of N semi-infinite D3-branes ending on the Orb5-plane. The orbifold action on the bosonic fields in the D3 world-volume (which form the bosonic part of an $\mathcal{N} = 4$ vector multiplet) are given as follows:

$$A^\mu(\mathbf{x}, -x^3) = \gamma(g) A^\mu(\mathbf{x}, x^3) \gamma(g)^{-1}, \quad \mu = 0, 1, 2. \tag{5.3}$$

$$X^{A'}(\mathbf{x}, -x^3) = -\gamma(g) X^{A'}(\mathbf{x}, x^3) \gamma(g)^{-1}, \quad A' = 3, 4, 5, 6, \tag{5.4}$$

$$Y^A(\mathbf{x}, -x^3) = \gamma(g) Y^A(\mathbf{x}, x^3) \gamma(g)^{-1}, \quad A = 7, 8, 9, \tag{5.5}$$

where g is the odd element of \mathbb{Z}_2 , and $\gamma(g)$ is a $N \times N$ matrix which acts on the Chan-Paton factors associated with the N D3-branes. The most general form for $\gamma(g)$ is a diagonal matrix with entries

$$\gamma_{ij}(g) = \text{diag}(1, \dots, 1, -1, \dots, -1), \tag{5.6}$$

where $i, j = 1, \dots, N$, with N_+ entries being $+1$, N_- entries being -1 , and $N = N_+ + N_-$. Restricting these equations to $x^3 = 0$, we obtain a set of boundary conditions for the bosonic fields at the orbifold plane. The boundary conditions imply that gauge field A^μ and the scalars Y^A combine to give the bosonic field content of a 3d $\mathcal{N} = 4$ vector multiplet with a gauge group $U(N_+) \times U(N_-)$. The scalars $X^{A'}$, on the other hand, combine to give the field content of a 3d $\mathcal{N} = 4$ hypermultiplet in the bifundamental representation of $U(N_+) \times U(N_-)$. We will be mostly interested in D3-branes on a finite line segment stretched between an NS5-brane on the one side, and an orbifold plane on the other. The NS5-brane imposes Dirichlet boundary condition on the scalars $X^{A'}$, and Neumann boundary conditions on the remaining scalars. Therefore, the bifundamental hypermultiplets become massive on KK-reduction, and do not appear in the 3d Lagrangian. The brane configuration and the associated 3d quiver are shown in Fig. 45.

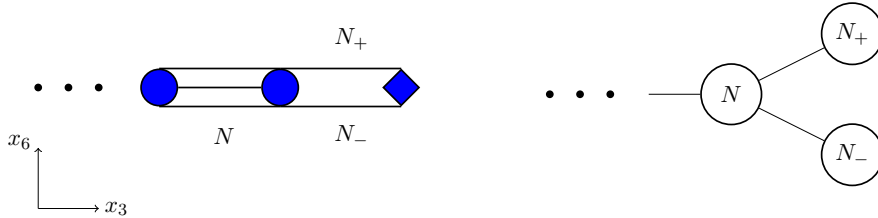

Figure 45: Type IIB realization of the bifurcated tail of a D -type quiver with unitary gauge groups. The blue circular nodes denote NS5-branes, while the blue rhombus denotes an Orb-5 plane. The D3-branes are denoted by black horizontal lines.

Now, let us consider the scenario where one has also M D5-branes coincident at the orbifold fixed point. The orbifold action on the hypermultiplet scalars, arising from the $D3 - D5$ massless open string spectrum, is given as:

$$h_{iI}^a(\mathbf{x}, 0) = \gamma_{ij}(g) h_{jJ}^a(\mathbf{x}, 0) \gamma_{JI}^{-1}(g), \quad (5.7)$$

where $a = 1, 2$ is the $SU(2)_H$ index, $i, j = 1, \dots, N$ are the CP indices for the D3-branes, and I, J are the CP indices for the D5-branes. Here, one has to distinguish two cases – one can either have M “full” D5-branes which are free to move off the orbifold fixed point, or they can be stuck at the fixed point as fractional branes. In the first case, the matrix $\gamma_{IJ}(g)$ is given by the regular representation of a \mathbb{Z}_2 -orbifold, i.e.

$$\gamma_{IJ}(g) = \text{diag}(+1, \dots, +1, -1, \dots, -1), \quad (5.8)$$

where $I, J = 1, \dots, 2M$, and the number of ± 1 entries is M in each case. In this case, the orbifold projection implies that the gauge groups $U(N_+)$ and $U(N_-)$ have M fundamental hypers each. For $M = 1$, the brane configuration and the associated quiver is shown in Fig. 46.

For the fractional D5-branes, the matrix $\gamma_{IJ}(g)$ is given as

$$\gamma_{IJ}(g) = \text{diag}(1, \dots, 1, -1, \dots, -1), \quad (5.9)$$

where $I, J = 1, \dots, M$, and with M_+ entries being $+1$, M_- entries being -1 , and $M = M_+ + M_-$. In this case, the orbifold projection implies that the gauge groups $U(N_+)$ and $U(N_-)$ will have M_+ and M_- fundamental hypers respectively. The brane configuration for $M = 1$, $M_+ = 1$, and $M_- = 0$, and the associated quiver is shown in Fig. 47.

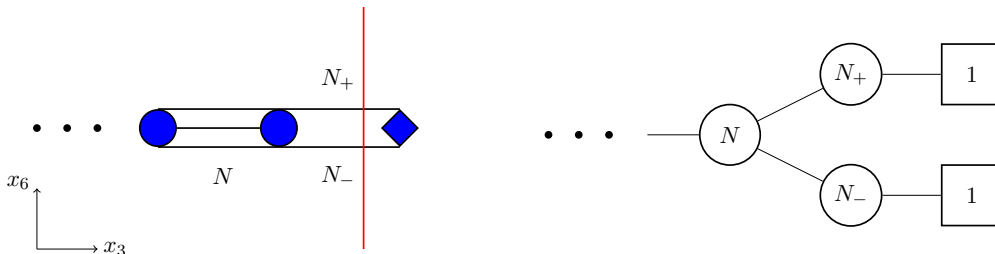

Figure 46: Type IIB configuration for a bifurcated tail of a D -type quiver with an additional D5-brane (denoted by a red vertical line). The associated 3d quiver is shown on the right.

5.1.2 S-dual configurations: D3-branes ending on orientifolds

Let us now extend our discussion to 3d quivers for which the Type IIB configuration involves D3-branes ending on orientifold 5-planes, in addition to the NS5 and D5-branes. Generically, these boundary conditions lead to linear quiver gauge theories with unitary as well as symplectic gauge groups.

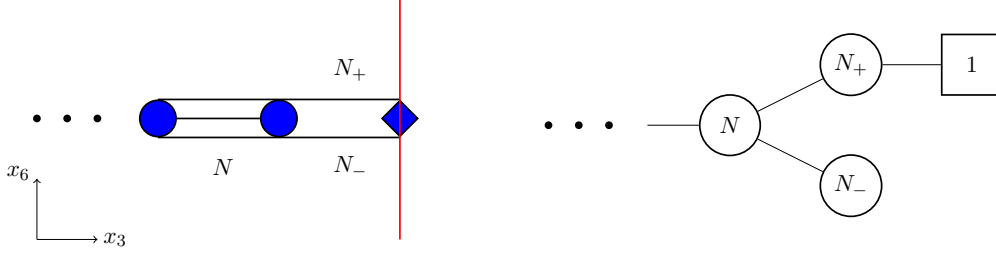

Figure 47: Type IIB configuration for a bifurcated tail of a D -type quiver with a fractional D5-brane (denoted by a red vertical line) stuck at the orbifold fixed plane. The associated 3d quiver is shown on the right.

Given a Type IIB configuration of D3-D5-NS5-branes oriented as (2.15), consider an orientifolding operation $\mathcal{I}_4 \Omega$, where

$$\mathcal{I}_4 : x^{3,7,8,9} \rightarrow -x^{3,7,8,9}, \quad (5.10)$$

and Ω is the worldsheet orientation reversal operation. The fixed plane of the orientifolding operation is the 5-plane located at the point $x^{3,7,8,9} = 0$ in the transverse direction. The gauge group for the world-volume theory on a stack of M D5-branes, coincident with this fixed plane, can be $Sp(M)$ or $O(2M)$. In the former case, the fixed plane has a D5-brane charge -1 , and is therefore referred to as the $O5^-$ -plane. In latter case, the D5-brane charge $+1$, and the corresponding fixed plane is denoted as $O5^+$. An orientifold 5-plane preserves the same supersymmetry as a parallel D5-brane. The respective world-volumes of the D3, D5, NS5-branes and the $O5^-$ -plane can be summarized as:

$$\begin{aligned} \text{D3: } & \mathbb{R}^{2,1} \times L \times \{\mathbf{X}\}_{4,5,6} \times \{\mathbf{Y}\}_{7,8,9} \\ \text{D5: } & \mathbb{R}^{2,1} \times \{X_3\} \times \mathbb{R}_{4,5,6}^3 \times \{\mathbf{Y}'\}_{7,8,9} \\ \text{NS5: } & \mathbb{R}^{2,1} \times \{X'_3\} \times \{\mathbf{X}'\}_{4,5,6} \times \mathbb{R}_{7,8,9}^3, \\ \text{O5}^- : & \mathbb{R}^{2,1} \times \{\mathbf{0}\}_{3,7,8,9} \times \mathbb{R}_{4,5,6}^3. \end{aligned} \quad (5.11)$$

To begin with, consider a stack of $2N$ D3-branes ending on an $O5^-$ -plane at one of the boundaries and an NS5-brane at the other boundary. The boundary conditions imply that gauge field A^μ and the scalars Y^A combine to give the bosonic field content of a 3d $\mathcal{N} = 4$ vector multiplet with a gauge group $Sp(N)$. The NS5-brane imposes Dirichlet boundary condition on the scalars $X^3, X^{A'}$ at one end, so that they do not figure in the 3d Lagrangian. Additionally, if there are D5-branes in the D3-brane chamber, then the massless states from the D3-D5 strings give hypermultiplets in the fundamental representation of the gauge group $Sp(N)$.

In this work, we shall encounter two distinct boundary conditions involving orientifold 5-planes, which in turn arise on S-dualizing boundary conditions involving orbifold 5-planes. The first case is the S-dual of $2N$ D3-branes ending on an orbifold 5-plane with $N_+ = N_- = N$ [7]. This is given by $2N$ D3-branes ending on an $O5^-$ -plane with a single

coincident D5-brane – a combination we will refer to as an $O5^0$ -plane, where the superscript indicates the zero total D5-brane charge. For a D3-brane stack between an $O5^0$ -plane and an NS5-brane, the associated 3d theory has an $Sp(N)$ vector multiplet and a single fundamental hypermultiplet.

The second case is the S-dual of $2N$ D3-branes ending on an orbifold 5-plane with M fractional D5-branes, and $N_+ = N_- = N$ as before. This is given by $2N$ D3-branes ending on an $O5^0$ -plane with M NS5-branes stuck at the $O5^-$ -plane. Similar to the first case, we would be interested in D3-branes ending on an NS5 at the other boundary of x^3 . In case of $M = 1$, the associated 3d theory can be shown to be a $U(2N)$ gauge theory with a hypermultiplet in the antisymmetric representation and the fundamental representation of the gauge group respectively [22, 23]. Presence of additional D5-branes will contribute to fundamental hypermultiplets for the gauge group in the 3d theory. For $M > 1$, the associated 3d theory can again be read off from the brane configuration – it turns out to be a linear quiver of unitary gauge nodes with a symplectic gauge node at the end.

Along with the standard D3-NS5-D5 system, the two boundary conditions with orbifold 5-planes (and their S-duals) are sufficient to engineer the D-type and the affine D-type quivers (and their mirror duals) we are interested in. The only exception will be the mirror pair discussed in Section 6 where the S-dual boundary condition involving orientifold 5-planes give a bad 3d quiver.

5.2 Type IIB configurations with defects and S-duality

In this section, we discuss the Type IIB brane configurations associated with vortex and Wilson defects in D -type and affine D -type quiver gauge theories with unitary gauge groups. Such configurations will generically involve introducing D1-branes and F1-strings respectively in a D3-D5-NS5 setting with one or two orbifold 5-planes. For each representative case, one can obtain the dual defect by S -dualizing this configuration, which will lead to a configuration with F1-strings and D1-branes respectively in a D3-D5-NS5 setting with one or two orientifold 5-planes. We will restrict ourselves to Type IIB configuration of Fig. 45, where there are no D5-branes between the orbifold 5-plane and the nearest NS5-brane.

A generic D -type quiver gauge theory, engineered by such a Type IIB configuration, has a bifurcated tail, and the terminal gauge nodes at the tail do not have any fundamental matter. Away from the tail, the vortex/Wilson defects will have features similar to the linear quivers. Therefore, we will focus on defects for gauge groups around the bifurcated tail and study their S-dual counterparts. For concreteness, we will choose the ranks of the gauge group and the matter content as follows.

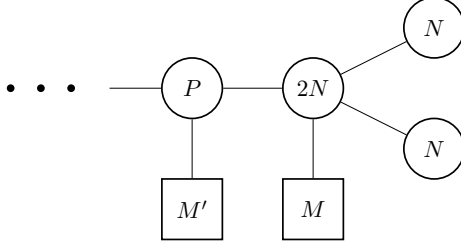

The integers P, M, M', N are chosen such that every gauge node is either balanced or overbalanced. In addition, we will set $M' = 0$ and $M = 1$, for simplifying the presentation.

5.2.1 Vortex defects in the presence of orbifold 5-planes

Consider a vortex defect labelled by a representation $R = \otimes_{a=1}^l \mathcal{S}_{k^{(a)}} \otimes_{b=1}^{l'} \mathcal{A}_{k'^{(b)}}$ for the gauge node $U(2N)$ of the D -type quiver. Note that this is precisely the type of vortex defect we encountered in Section 4.1.1 for a D_4 quiver (see Fig. 25) and in Section 4.2 for a D_6 quiver (see Fig. 32). The defect can be introduced in a fashion similar to the linear quiver, reviewed in Section 2.2.2. We introduce stacks of D1-branes stretching between the $2N$ D3-branes on one end and additional NS5 and/or NS5'-branes (displaced in the x^6 -direction) on the other. The D1 stacks ending on the NS5-branes and the NS5'-branes correspond to the symmetric factors $\mathcal{S}_{k^{(a)}}$ and the antisymmetric factors $\mathcal{A}_{k'^{(b)}}$ in the representation R respectively.

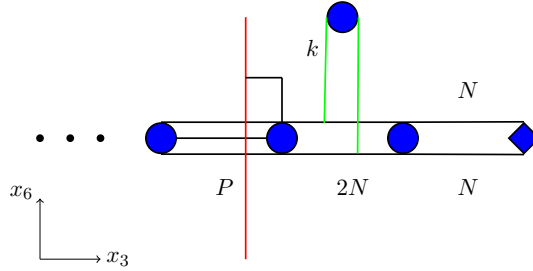

Figure 48: Type IIB configuration corresponding to a vortex defect for the $U(2N)$ gauge group in the generic D -type quiver discussed above. The green vertical lines denote k_1, \dots, k_N D1-branes respectively, where $k_1 + \dots + k_N = k$. The configuration corresponds to a vortex defect in a representation $R = \mathcal{S}_k$ of $U(2N)$.

The special case for $R = \mathcal{S}_k$ is shown in Fig. 48. In this case, k_i D1-branes (denoted by vertical green lines) stretch between an NS5-brane and the i -th D3-brane such that $k_1 + \dots + k_N = k$, with $\{k_i\}$ unrestricted. The set of integers $\{k_i\}$ are in one-to-one correspondence to the weights of the representation $R = \mathcal{S}_k$ of $U(2N)$. The configuration for a more general representation can be written down in an analogous fashion following the rules in Section 2.2.2.

The vortex defect can be realized as deformations of two different coupled 3d-1d systems obtained by moving the stack of k D1-branes to end either on the right NS5-brane or the left NS5-brane in Fig. 48. The brane configurations and the associated coupled

3d-1d systems, which can be manifestly read off from the brane configurations, are shown in Fig. 49. For $N = 2$ and $P = 3$, this is precisely the hopping duality we found in Fig. 33 of Section 4.2 for the D_6 quiver gauge theory. The coupled systems $X'[V'_{2,R}^{(I)}]$ and $X[V'_{2,R}^{(II)}]$ in Fig. 33 were shown to describe the same vortex defect by arguing that the partition functions of the two systems are equal. The configurations in Fig. 49 give a Type IIB brane description of the hopping duality.

For $N = 1$ and $P = 1$, the configurations of Fig. 49 reproduce the hopping duality found in Fig. 26 of Section 4 for a D_4 quiver.

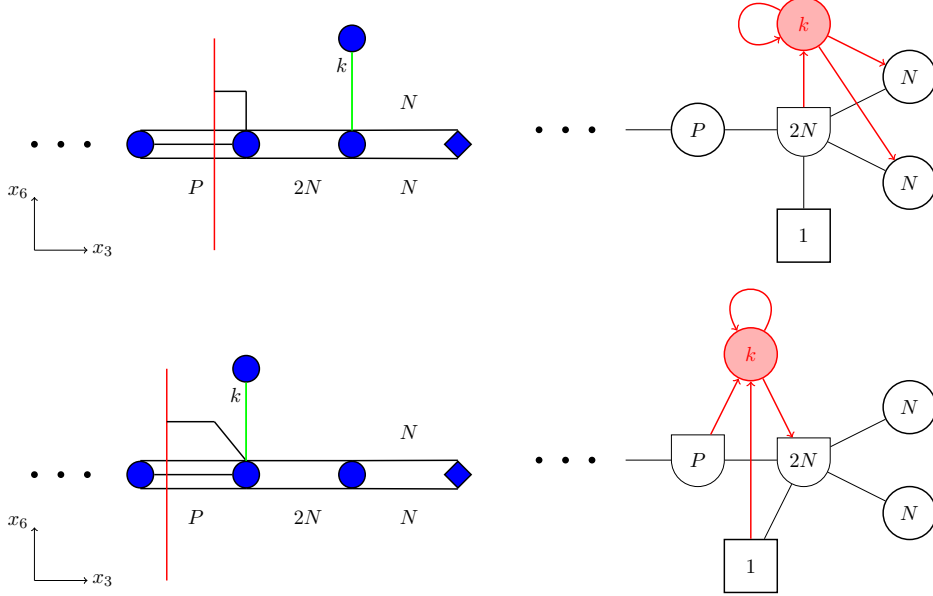

Figure 49: Vortex defects for the $U(2N)$ gauge group of the generic D -type quiver can be understood as the deformation of at least two 3d-1d coupled quivers. The two coupled quivers as well as the corresponding Type IIB realizations are shown.

To construct the dual defect and read off the mirror map, we consider the S-dual of the brane configuration presented above in Fig. 48. As reviewed in Section 5.1.2, D5 and NS5-branes are exchanged, D3-branes remain invariant, D1-branes become F1 strings, and the orbifold 5-plane becomes an $O5^0$ -plane. One now needs to subject this brane configuration to a Hanany-Witten move where the NS5-brane is moved across the D5-brane to the immediate right. After the move, one can have $2N$ D3-branes in the rightmost chamber stretching between the NS5-brane and the $O5^0$ -plane, while no D3-brane ends on the D5. The final configuration is given by Fig. 50, from which the dual theory as well as the dual defect can be read off. As reviewed in Section 5.1.2, the 3d theory associated with $2N$ D3-branes between the NS5-brane and the $O5^0$ -plane is an $Sp(N)$ gauge theory. The D5-branes in the chamber as well as the D3-branes stretching between the NS5 and D5-branes to the left will give fundamental hypermultiplets for $Sp(N)$. From the brane configuration, one can check that the total number of fundamental and bifundamental

hypermultiplets of $Sp(N)$ is $2N + 2$, i.e. $\widetilde{M} + \widetilde{N} = 2N$ in the quiver. The precise integers $\widetilde{M}, \widetilde{N}$ will depend on the details of the linear quiver tail. For the examples of the D -type quivers we have considered in this paper, $\widetilde{M} = 2N$ and $\widetilde{N} = 0$.

As shown in Fig. 50, the defect is realized by a stack of k F1-strings (denoted by vertical black dotted lines) stretched between a D5 and $2N$ D3-branes – k_i F1-strings end on the i -th D3-brane such that $k_1 + \dots + k_N = k$, with $0 \leq k_i \leq k$. Recall that the set of integers $\{k_i\}$ are in one-to-one correspondence to the weights of the representation $R = \mathcal{S}_k$ of $U(2N)$. The configuration for a generic R can be obtained in an analogous fashion. The configuration of F1-strings then generates a Wilson defect for the $Sp(N)$ gauge group, labelled by a representation \widetilde{R} , where \widetilde{R} is the restriction of the representation R of $U(2N)$ to the subgroup $Sp(N) \subset U(2N)$. Combined with the discussion of hopping duality, this leads to a mirror map of the form (4.48), which was obtained for the mirror pair involving the D_6 quiver and the $Sp(2)$ gauge theory from sphere partition function analysis.

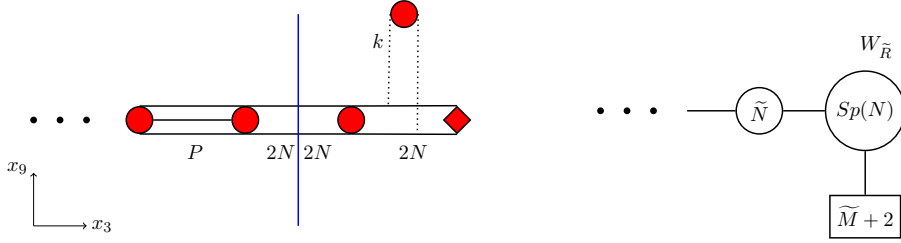

Figure 50: S-dual of the Type IIB configuration in Fig. 48. The red rhombus denotes an $O5^0$ -plane. The associated quiver with the Wilson defect is shown on the right.

5.2.2 Wilson defects in the presence of orbifold 5-planes

Next, we consider a Wilson defect labelled by a representation $R = \otimes_{a=1}^l \mathcal{S}_{k^{(a)}} \otimes'_{b=1}^{l'} \mathcal{A}_{k'^{(b)}}$ for the gauge node $U(2N)$ of the D -type quiver. Note that this is precisely the type of Wilson defect we encountered in Section 4.1.3 for a D_4 quiver (see Fig. 29) and in Section 4.2 for a D_6 quiver (see Fig. 35). The defect can be introduced in a fashion similar to the linear quiver, reviewed in Section 2.2.2. We introduce stacks of F1-strings stretching between the $2N$ D3-branes on one end and additional D5 and/or D5'-branes (displaced in the x^6 -direction) on the other. The F1 stacks ending on the D5-branes and the D5'-branes correspond to the symmetric factors $\mathcal{S}_{k^{(a)}}$ and the antisymmetric factors $\mathcal{A}_{k'^{(b)}}$ in the representation R respectively.

The special case for $R = \mathcal{S}_k$ is shown in Fig. 51. In this case, k_i F1-strings (denoted by vertical black dotted lines) stretch between a D5-brane and the i -th D3-brane such that $k_1 + \dots + k_N = k$, with $0 \leq k_i \leq k$ for all i . The set of integers $\{k_i\}$ are in one-to-one correspondence to the weights of the representation $R = \mathcal{S}_k$ of $U(2N)$. The configuration for a more general representation can be written down in an analogous fashion following the rules in Section 2.2.2.

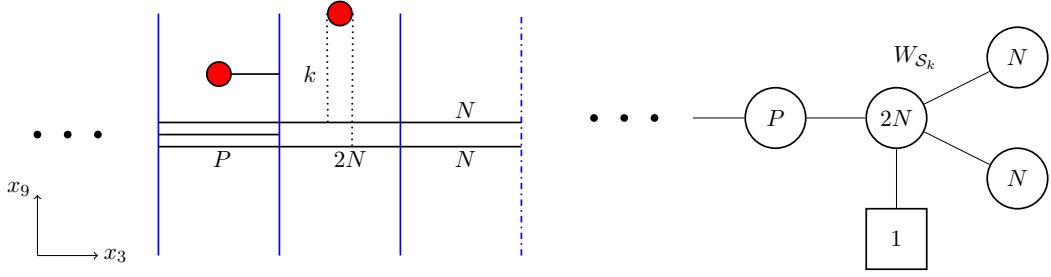

Figure 51: Type IIB configuration corresponding to a Wilson defect for the $U(2N)$ gauge group in the generic D -type quiver discussed above. The blue dot-dashed line denotes the Orb5-plane. The black dotted vertical lines denote k_1, \dots, k_N F1-strings respectively, where $k_1 + \dots + k_N = k$. The configuration corresponds to a Wilson defect in a representation $R = \mathcal{S}_k$ of $U(2N)$.

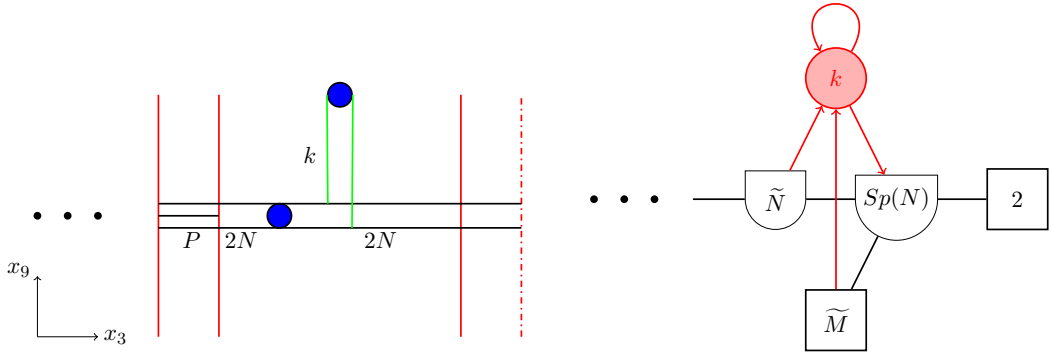

Figure 52: S-dual of the configuration in Fig. 51. The red dot-dashed vertical line is an $O5^0$ -plane. The Type IIB configuration realizes a vortex defect for the $Sp(N)$ gauge group. This vortex defect can be understood as a deformation of a 3d-1d coupled quiver, which is shown on the right.

To construct the dual defect and read off the mirror map, we consider the S-dual of the brane configuration presented above in Fig. 51. Under S-duality, D5 and NS5-branes are exchanged, D3-branes remain invariant, F1 strings become D1-branes, and the orbifold 5-plane becomes an $O5^0$ -plane. One now needs to subject this brane configuration to a Hanany-Witten move where the NS5-brane is moved across the D5-brane to the immediate right (exactly what we did while S-dualizing the vortex configuration above). After the move, we can arrange the $2N$ D3-branes in the rightmost corner to stretch between the NS5-brane and the $O5^0$ -plane. The final configuration is given in Fig. 52, from which the dual 3d theory and the dual defect can be read off as before.

From Fig. 52, one can see that the dual vortex defect is realized by a stack of k D1-branes (denoted by vertical green lines) stretched between an NS5 and $2N$ D3-branes – k_i D1-branes end on the i -th D3-brane such that $k_1 + \dots + k_N = k$, with $0 \leq k_i \leq k$. The coupled 3d-1d system corresponding to this vortex defect can be obtained by moving the stack of D1-branes to the left so that they all end on the NS5-brane. Then, using the rules reviewed in Section 2.2.2, the gauge group and the matter content of the coupled SQM can be read off – the result is shown in Fig. 52. The case of a generic representation

can be handled in an analogous fashion. One therefore arrives at a mirror map between a Wilson defect in the bifurcated quiver and a vortex defect in the quiver containing an $Sp(N)$ gauge group. In the special case of $Sp(2)$ gauge theory with $N_f = 6$ and its mirror dual, the mirror map reduces to (4.53), which was obtained in Section 4.2 using sphere partition functions. The coupled quiver in Fig. 52 clearly reduces to the coupled quiver in Fig. 35 for the special case of $\widetilde{M} = 2N$ and $\widetilde{N} = 0$.

An interesting feature of the vortex defect realized in Fig. 52 is that it admits a single 3d-1d quiver, as opposed to two – the left and the right – for a linear quiver with unitary gauge groups. This is because there is only a single NS5-brane in Fig. 52 that the stack of D1-branes can approach without encountering a D5-brane. This is something that was found in Section 4.1 and Section 4.2 using the sphere partition function argument. The brane construction gives a more physical and intuitive understanding of this fact.

6 Beyond Hanany-Witten : A flavored \widehat{D}_4 quiver

In this section, we consider an example of mirror symmetry which is not directly realized by a Type IIB construction. Consider the \widehat{D}_4 quiver gauge theory X' in Fig. 53, which can be constructed by a Hanany-Witten configuration of the type discussed in Section 5.1. The set-up involves D3-D5-NS5-branes and a pair of orbifold 5-planes, one of which contains a pair of fractional D5-branes responsible for engineering the two fundamental hypermultiplets in X' . The S -dual of the configuration leads to the quiver Y'_{HW} in Fig. 53. This quiver is evidently *bad* in the Gaiotto-Witten sense, and therefore does not give the correct mirror dual of X' . A careful analysis of the IR physics of Y'_{HW} , reveals a good quiver gauge theory dual to X' [24] – which we denote as Y' in Fig. 53. Alternatively, the theory Y' can also be obtained by implementing an S -type operation on an appropriate linear quiver X to engineer X' , and then reading off the dual from the partition function construction of [1].

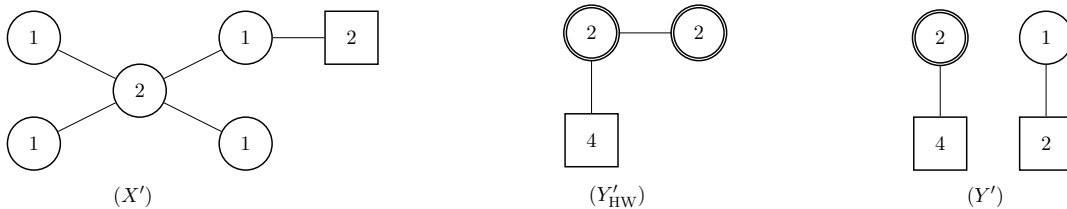

Figure 53: The Hanany-Witten dual of the theory X' and the good dual. The former is a bad theory since the $SU(2)$ node without fundamental hypers is a bad node.

Note that the good quiver Y' consists of two decoupled quiver gauge theories – an $SU(2)$ gauge theory with $N_f = 4$ flavors (Y'_1) and a $T(U(2))$ theory (Y'_2). We will study vortex and Wilson defects in the theory X' and determine the mirror maps, demonstrating in particular how the dual defect “factorizes” among the two decoupled theories.

6.1 Vortex Defects in the \widehat{D}_4 quiver

Let us consider vortex defects in the central $U(2)$ gauge node in the \widehat{D}_4 quiver. The starting point is the dual pair of defect quivers – $X[V_{2,R}^T]$ and $Y[\widetilde{W}_R]$, as shown in the first line of Fig. 54. The fundamental masses in theory X be labelled as $\{m_i|i = 1, \dots, 4\}$, such that the $U(2)_\beta$ and the $U(2)_\alpha$ flavor nodes in $X[V_{2,R}^T]$ are associated with the masses (m_1, m_2) and (m_3, m_4) . We implement the following Abelian S -operation $\mathcal{O}_{\mathcal{P}}$ on $X[V_{2,R}^T]$:

$$\mathcal{O}_{\mathcal{P}}(X[V_{2,R}^T]) = G_{\mathcal{P}_4}^{\beta_2} \circ G_{\mathcal{P}_3}^{\beta_1} \circ (G)_{\mathcal{P}_2}^{\alpha_2} \circ (G \circ F)_{\mathcal{P}_1}^{\alpha_1}(X[V_{2,R}^T]), \quad (6.1)$$

where $\alpha_1 = \alpha$, $\beta_1 = \beta$, α_2 is the residual $U(1)$ flavor node from $U(2)_\alpha$ in the theory $G_{\mathcal{P}_1}^{\alpha_1}(X)$, and β_2 is the residual $U(1)$ flavor node from $U(2)_\beta$. The flavoring operation in $(G \circ F)^{\alpha_1}$ adds two fundamental hypermultiplets. The mass parameters corresponding to the $U(1)^4$ global symmetry to be gauged are :

$$u_1 = m_3, \quad u_2 = m_4, \quad u_3 = m_1, \quad u_4 = m_2. \quad (6.2)$$

The partition function $Z^{\mathcal{O}_{\mathcal{P}}(X[V_{2,R}^T])}$ can be identified as the partition function of a coupled 3d-1d quiver $X'[V_{2,R}^{\prime(I)}]$, shown in Fig. 54, where the 3d quiver is the \widehat{D}_4 quiver gauge theory X' and the SQM is $\Sigma^{2,R}$. The Witten index for the SQM is computed in the chamber $\xi < 0$. We redefine the partition function of the new 3d-1d quiver by a global Wilson defect factor, i.e.

$$Z^{(X'[V_{2,R}^{\prime(I)}])} := e^{-2\pi(t_1 + \frac{\eta_3 + \eta_4}{2})|R|} Z^{\mathcal{O}_{\mathcal{P}}(X[V_{2,R}^T])}(v, \mathbf{m}_F; \mathbf{t}, \boldsymbol{\eta}), \quad (6.3)$$

where $\mathbf{m}_F = (m_{1F}, m_{2F})$ are masses of the fundamental hypers in X' for the $U(1)_1$ gauge node. The dual 3d-1d coupled system is then given by the quiver $Y'[\widetilde{W}'_R]$ in Fig. 54, where Y' consists of two decoupled sectors as shown. The defect \widetilde{W}'_R is a gauge Wilson defect in a representation \widetilde{R} for the gauge group $SU(2)$, where \widetilde{R} is given by restricting the representation R to a subgroup $SU(2) \subset U(2)$. A second coupled 3d-1d quiver which realizes the same vortex defect can be obtained by implementing the S -type operation (6.1) on the quiver $(X[V_{2,R}^T])$ – the resultant quiver $(X'[V_{2,R}^{\prime(II)}])$ is shown in Fig. 55. The Witten index for the SQM should be computed in the chamber $\xi > 0$. Computing the dual partition function, one can again show that the dual defect is given by $Y'[\widetilde{W}'_R]$. This leads to the following mirror map:

$$\langle V_{2,R}^{\prime(II)} \rangle_{X'}(\mathbf{m}_F; \mathbf{t}, \boldsymbol{\eta}) = \langle V_{2,R}^{\prime(I)} \rangle_{X'}(\mathbf{m}_F; \mathbf{t}, \boldsymbol{\eta}) = \langle \widetilde{W}'_R \rangle_{Y'_1} \cdot \langle \mathbf{1} \rangle_{Y'_2}, \quad (6.4)$$

where $\mathbf{1}$ denotes a trivial Wilson defect in the theory Y'_2 .

6.2 Wilson Defects in the \widehat{D}_4 quiver

Let us consider Wilson defects for the central $U(2)$ gauge node of the \widehat{D}_4 quiver X' . The starting point is the dual pair of defects – the Wilson defect W_R in the theory X and the vortex defect $\widetilde{V}_{1,R}$ in the theory Y , where the latter is realized by as a deformation of two

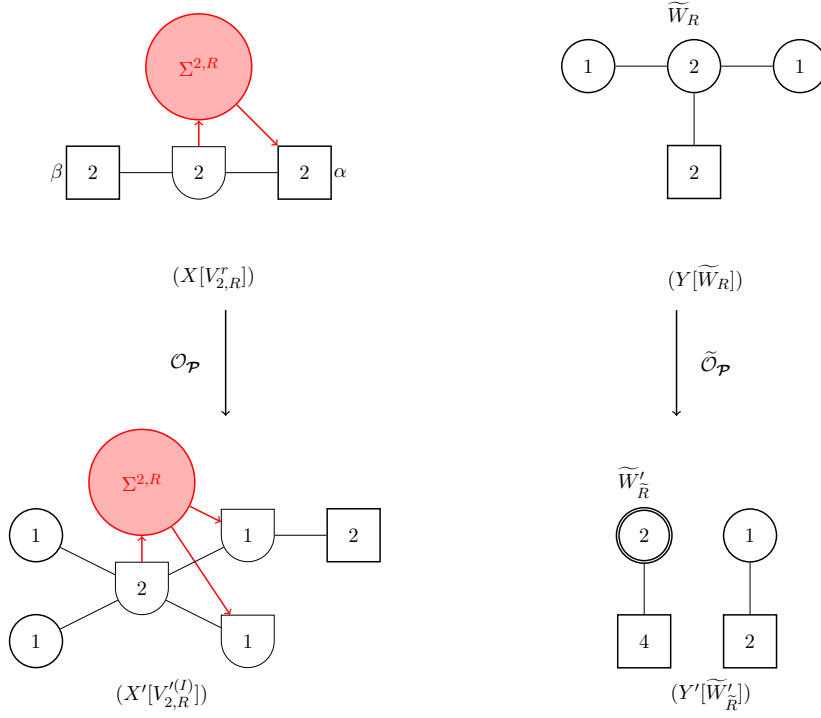

Figure 54: Construction of a vortex defect in the central $U(2)$ gauge node of the theory X' and its dual Wilson defect.

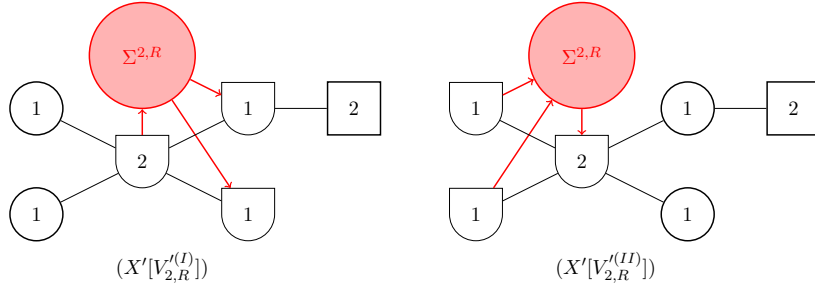

Figure 55: Two different realizations of a vortex defect for the central $U(2)$ gauge node in the quiver X' .

3d-1d quivers $\tilde{V}_{1,R}^r$ and $\tilde{V}_{1,R}^l$. The pair $(W_R, \tilde{V}_{1,R}^r)$ is shown in the first line of Fig. 56. We implement the Abelian S -type operation $\mathcal{O}_{\mathcal{P}}$ on the system $X[W_R]$, where $\mathcal{O}_{\mathcal{P}}$ is given as:

$$\mathcal{O}_{\mathcal{P}}(X[W_R]) = G_{\mathcal{P}_4}^{\alpha_4} \circ G_{\mathcal{P}_3}^{\alpha_3} \circ G_{\mathcal{P}_2}^{\alpha_2} \circ (G \circ F)_{\mathcal{P}_1}^{\alpha_1}(X[W_R]), \quad (6.5)$$

where $\alpha_1 = \alpha$, and the flavoring operation in $(G \circ F)^{\alpha_1}$ adds two fundamental hypermultiplets. The mass parameters corresponding to the following choice of the $U(1)^4$ global symmetry to be gauged:

$$u_1 = m_3, \quad u_2 = m_4, \quad u_3 = m_1, \quad u_4 = m_2. \quad (6.6)$$

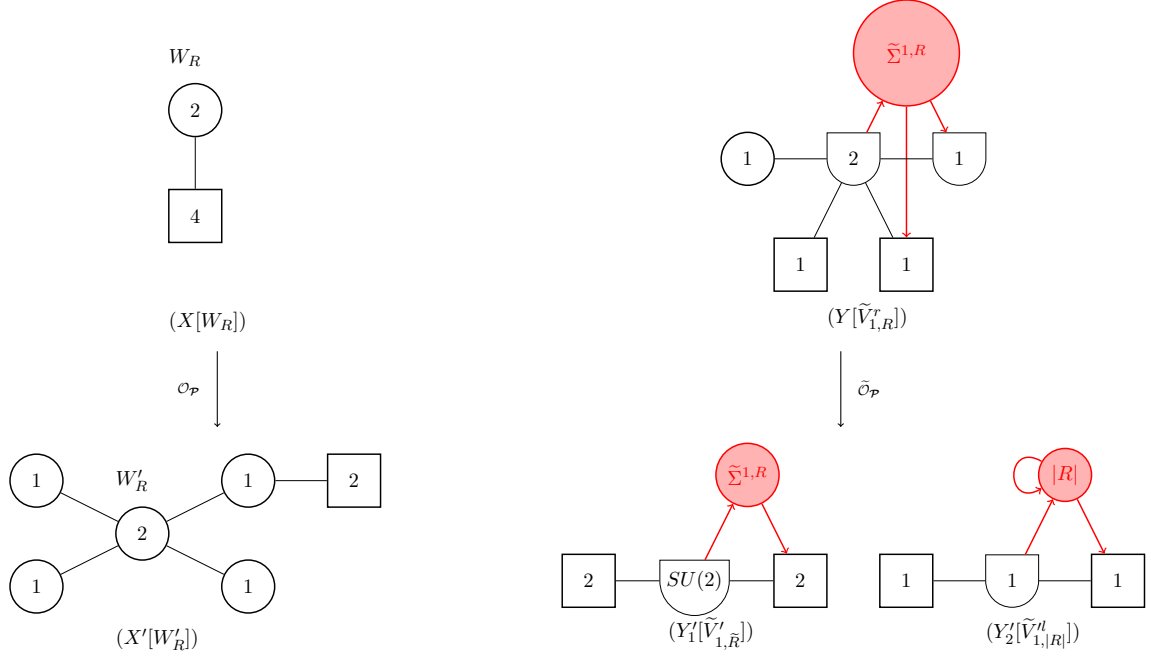

Figure 56: Wilson defect in the central gauge node of the \widehat{D}_4 quiver X' , and the dual vortex defect Y' .

This S -operation on the quiver $X[W_R]$ leads to the defect quiver $X'[W'_R]$ in Fig. 56. The dual vortex defect can be read off from the dual partition function and, after manipulations similar to previous examples, reduce to the following form:

$$Z^{(Y'[(W'_R)^\vee])} = C \cdot Z^{(Y'_1[\tilde{V}'_{1,\bar{R}}])} \cdot Z^{(Y'_2[\tilde{V}'_{1,|R|}])}, \quad (6.7)$$

$$Z^{(Y'_1[\tilde{V}'_{1,\bar{R}}])} = \lim_{z \rightarrow 1} \int [d\sigma] \delta(\text{Tr}\sigma) Z_{\text{int}}^{U(2), N_f=4}(\sigma, \mathbf{m}'^{(1)}(\mathbf{t}, \boldsymbol{\eta}), \eta') \mathcal{I}_{\tilde{\Sigma}_r}^{\tilde{\Sigma}_r^{1,R}}(\sigma, \mathbf{m}'^{(1)}, z | \boldsymbol{\xi} < 0), \quad (6.8)$$

$$Z^{(Y'_2[\tilde{V}'_{1,|R|}])} = e^{2\pi i m_{2F}|R|} \cdot \lim_{z \rightarrow 1} \int d\tau Z_{\text{int}}^{T(U(2))}(\tau, \mathbf{m}'^{(2)}(\mathbf{t}, \boldsymbol{\eta}), \mathbf{m}_F) \mathcal{I}_{\tilde{\Sigma}_r}^{\tilde{\Sigma}_r^{1,|R|}}(\tau, \mathbf{m}'^{(2)}, z | \boldsymbol{\xi} < 0), \quad (6.9)$$

where $C = C(\mathbf{m}_F, \boldsymbol{\eta}, \mathbf{t})$ is a contact term and $\mathbf{m}'^{(1)}, \mathbf{m}'^{(2)}$ are mass parameters of the quivers Y'_1 and Y'_2 respectively. The FI parameters of Y'_2 are given by $\mathbf{m}_F = (m_{1F}, m_{2F})$, which are the fundamental masses in the \widehat{D}_4 quiver gauge theory. Finally, the Witten indices are given as:

$$\mathcal{I}_{\tilde{\Sigma}_r}^{\tilde{\Sigma}_r^{1,R}}(\sigma, \mathbf{m}'^{(1)}, z | \boldsymbol{\xi} < 0) = \sum_{w \in R} \prod_{j=1}^2 \prod_{i=1}^2 \frac{\cosh \pi(\sigma_j - m_i^{(1)})}{\cosh \pi(\sigma_j + iw_j z - m_i^{(1)})}, \quad (6.10)$$

$$\mathcal{I}_{\tilde{\Sigma}_r}^{\tilde{\Sigma}_r^{1,|R|}}(\tau, \mathbf{m}'^{(2)}, z | \boldsymbol{\xi} < 0) = \frac{\cosh \pi(\tau - m_1^{(2)})}{\cosh \pi(\tau + i|R|z - m_1^{(2)})}. \quad (6.11)$$

The RHS of (6.7) shows that the dual defect factorizes into a vortex defect for the $SU(2)$ gauge group¹⁰ in the 3d quiver Y'_1 (denoted as $Y'_1[\tilde{V}'_{1,\tilde{R}}]$), and a vortex defect the $U(1)$ gauge group of the 3d quiver Y'_2 (denoted as $Y'_2[\tilde{V}''_{1,|R|}]$). The 3d-1d quiver is shown in the bottom right of Fig. 56. We therefore have the following mirror map:

$$\langle W'_R \rangle_{X'}(\mathbf{m}_F; \mathbf{t}, \boldsymbol{\eta}) = \langle \tilde{V}'_{1,\tilde{R}} \rangle_{Y'_1} \cdot \langle \tilde{V}''_{1,|R|} \rangle_{Y'_2}. \quad (6.12)$$

The dual of Wilson defects for the other gauge and flavor nodes can be similarly determined.

Acknowledgement

The author would like to thank Ibrahima Bah for comments, and Vivek Saxena for collaboration on related issues. The author is partially supported at the Johns Hopkins University by NSF grant PHY-1820784.

A Line defects in a $U(2)$ gauge theory with $N_f = 4$ flavors

A.1 Mirror symmetry and partition functions

The partition function of the quiver X is

$$Z^{(X)}(\mathbf{m}; \mathbf{t}) = \int \frac{d^2s}{2!} \frac{e^{2\pi i \text{Tr} s(t_1 - t_2)} \sinh^2 \pi(s_1 - s_2)}{\prod_{i=1}^2 \prod_{a=1}^4 \cosh \pi(s_i - m_a)}, \quad (A.1)$$

where m_1, m_2, m_3, m_4 are the hypermultiplet masses, while the FI parameter of the gauge group is $\eta = t_1 - t_2$. Using Cauchy determinant identity:

$$\frac{\sinh \pi(x_1 - x_2) \sinh \pi(y_1 - y_2)}{\prod_{i,j} \cosh \pi(x_i - y_j)} = \sum_{\rho \in S_2} (-1)^\rho \frac{1}{\prod_i \cosh \pi(x_i - y_{\rho(i)})}, \quad (A.2)$$

the above integral can be decomposed into a sum of terms each involving Abelian integrals. Evaluating the Abelian integrals explicitly, we have the expression:

$$Z^{(X)}(\mathbf{m}; \mathbf{t}) = - \left[\frac{(e^{2\pi i m_1 \eta} - e^{2\pi i m_3 \eta}) (e^{2\pi i m_2 \eta} - e^{2\pi i m_4 \eta})}{\sinh \pi(m_1 - m_3) \sinh \pi(m_2 - m_4)} - \frac{(e^{2\pi i m_1 \eta} - e^{2\pi i m_4 \eta}) (e^{2\pi i m_2 \eta} - e^{2\pi i m_3 \eta})}{\sinh \pi(m_1 - m_4) \sinh \pi(m_2 - m_3)} \right] \\ \times \frac{1}{\sinh \pi(m_1 - m_2) \sinh \pi(m_3 - m_4) \sinh^2 \pi \eta}. \quad (A.3)$$

Similarly, the partition function of the quiver Y is

$$Z^{(Y)}(\mathbf{t}; \mathbf{m}) = \int d\sigma^1 \left[d\boldsymbol{\sigma}^2 \right] d\sigma^3 \frac{e^{2\pi i \sigma^1 (m_1 - m_2)} e^{2\pi i \text{Tr} \boldsymbol{\sigma}^2 (m_2 - m_3)} e^{2\pi i \sigma^3 (m_3 - m_4)} \sinh^2 \pi(\sigma_1^2 - \sigma_2^2)}{\prod_{i=1}^2 \cosh \pi(\sigma^1 - \sigma_i^2) \prod_{a=1}^2 \cosh \pi(\sigma_i^2 - t_a) \cosh \pi(\sigma^3 - \sigma_i^2)}, \quad (A.4)$$

¹⁰Up to a global vortex defect.

where t_1 and t_2 are the masses of the fundamental hypermultiplets in the middle node, and the FI parameters of the three gauge nodes are $\eta_1 = m_1 - m_2, \eta_2 = m_2 - m_3, \eta_3 = m_3 - m_4$. Performing the σ_1 and σ_3 integrals, the matrix integral can be reduced to a sum over terms each involving Abelian integrals, and after evaluating the latter, we have

$$Z^{(Y)}(\mathbf{t}; \mathbf{m}) = \left[\frac{(e^{2\pi i t_1(m_1 - m_4)} - e^{2\pi i t_2(m_1 - m_4)})(e^{2\pi i t_1(m_2 - m_3)} - e^{2\pi i t_2(m_2 - m_3)})}{\sinh \pi(m_1 - m_4) \sinh \pi(m_2 - m_3)} - \frac{(e^{2\pi i t_1(m_1 - m_3)} - e^{2\pi i t_2(m_1 - m_3)})(e^{2\pi i t_1(m_2 - m_4)} - e^{2\pi i t_2(m_2 - m_4)})}{\sinh \pi(m_1 - m_3) \sinh \pi(m_2 - m_4)} \right] \times \frac{1}{\sinh \pi(m_1 - m_2) \sinh \pi(m_3 - m_4) \sinh^2 \pi(t_1 - t_2)}. \quad (\text{A.5})$$

Using the explicit expressions for the two matrix integrals, one can check that

$$Z^{(X)}[\mathbf{m}; \mathbf{t}] = C_{XY}(\mathbf{m}, \mathbf{t}) Z^{(Y)}[\mathbf{t}; -\mathbf{m}] = C_{XY}(\mathbf{m}, \mathbf{t}) Z^{(Y)}[-\mathbf{t}; \mathbf{m}], \quad (\text{A.6})$$

$$C_{XY}(\mathbf{m}, \mathbf{t}) = e^{2\pi i t_1(m_1 + m_2)} e^{-2\pi i t_2(m_3 + m_4)}. \quad (\text{A.7})$$

The expressions agree exactly (i.e. the contact term vanishes) when one imposes the constraints $t_1 + t_2 = 0, m_1 + m_2 + m_3 + m_4 = 0$.

A.2 The vortex defects $V_{M,R}$ and the dual defects

Using the ‘‘right’’ SQM realization, the defect partition function is given as:

$$Z^{(X[V_{M,R}^r])}(\mathbf{m}; \mathbf{t}) = W_{\text{b.g.}}(\mathbf{t}, R) \cdot \lim_{z \rightarrow 1} \int [ds] Z_{\text{int}}^{(X)}(\mathbf{s}, \mathbf{m}, \mathbf{t}) \cdot \mathcal{I}^{\Sigma_r^{M,R}}(\mathbf{s}, \mathbf{m}, z | \boldsymbol{\xi} < 0), \quad (\text{A.8})$$

$$=: W_{\text{b.g.}}(\mathbf{t}, R) \cdot \lim_{z \rightarrow 1} \int [ds] Z_{\text{int}}^{(X[V_{M,R}^r])}(\mathbf{s}, \mathbf{m}, \mathbf{t}, z | \boldsymbol{\xi} < 0), \quad (\text{A.9})$$

where the constituent functions are given as:

$$W_{\text{b.g.}}(\mathbf{t}, R) = e^{2\pi t_2 |R|}, \quad (\text{A.10})$$

$$Z_{\text{int}}^{(X)}(\mathbf{s}, \mathbf{m}, \mathbf{t}) = \frac{e^{2\pi i \text{Tr} \mathbf{s}(t_1 - t_2)} \sinh^2 \pi(s_1 - s_2)}{\prod_{j=1}^2 \prod_{i=1}^4 \cosh \pi(s_j - m_i)}, \quad (\text{A.11})$$

$$\mathcal{I}^{\Sigma_r^{M,R}}(\mathbf{s}, \mathbf{m}, z | \boldsymbol{\xi} < 0) = \sum_{w \in R} \mathcal{F}(s_j, z) \prod_{j=1}^2 \prod_{i=(5-M)}^M \frac{\cosh \pi(s_j - m_i)}{\cosh \pi(s_j + i w_j z - m_i)}, \quad (\text{A.12})$$

and the explicit form of the Witten index $\mathcal{I}^{\Sigma_r^{M,R}}$ depends on the value of M , with $0 \leq M \leq 4$. The function $\mathcal{F}(s_j, z)$ is given as

$$\mathcal{F}(s_j, z) = \prod_{\alpha, \kappa} \prod_{i \neq j} \frac{\sinh(-\pi(s_i - s_j + \alpha z \pm z + \kappa/2))}{\sinh \pi(s_i - s_j + \alpha z + \kappa/2)}, \quad (\text{A.13})$$

with α, κ taking real values which depend on the weights w . The poles of the function $\mathcal{F}(s_j, z)$ have vanishing residues in the limit $z \rightarrow 1$, and therefore the limit can be taken

trivially, which gives an overall sign. The defect partition function can then be written as

$$Z^{(X[V_{M,R}^r])}(\mathbf{m}; \mathbf{t}) = W_{\text{b.g.}}(\mathbf{t}, R) \cdot \sum_{w \in R} Z^{(X[V_{M,R}^r])}(\mathbf{m}; \mathbf{t}|w) \quad (\text{A.14})$$

$$Z^{(X[V_{M,R}^r])}(\mathbf{m}; \mathbf{t}|w) = \lim_{z \rightarrow 1} \int [ds] \frac{e^{2\pi i \text{Tr} \mathbf{s}(t_1 - t_2)} \sinh^2 \pi(s_1 - s_2)}{\prod_{j=1}^2 \prod_{i=1}^{4-M} \cosh \pi(s_j - m_i) \prod_{i=(5-M)}^4 \cosh \pi(s_j + iw_j z - m_i)}. \quad (\text{A.15})$$

We now list the dual Wilson defects for different values of M as follows.

The case of $M = 2$: Using the Cauchy determinant (A.2), we obtain the relation:

$$Z^{(X[V_{2,R}^r])}(\mathbf{m}; \mathbf{t}|w) = \frac{1}{2} \sum_{\rho \in S_2} Z^{(X)}(m_1, m_2, m_3 - iw_{\rho(1)}, m_4 - iw_{\rho(2)}; \mathbf{t}). \quad (\text{A.16})$$

Using the fact that S_2 is the Weyl group of the $U(2)$ gauge group, we obtain

$$\begin{aligned} Z^{(X[V_{2,R}^r])}(\mathbf{m}; \mathbf{t}) &= W_{\text{b.g.}}(\mathbf{t}, R) \cdot \sum_w \frac{1}{2} \sum_{\rho \in S_2} Z^{(X)}(m_1, m_2, m_3 - iw_{\rho(1)}, m_4 - iw_{\rho(2)}; \mathbf{t}) \\ &= W_{\text{b.g.}}(\mathbf{t}, R) \cdot \sum_w Z^{(X)}(m_1, m_2, m_3 - iw_1, m_4 - iw_2; \mathbf{t}). \end{aligned} \quad (\text{A.17})$$

Using the mirror symmetry relation (A.6)-(A.7), the above equation can be written as

$$\begin{aligned} Z^{(X[V_{2,R}^r])}(\mathbf{m}; \mathbf{t}) &= W_{\text{b.g.}}(\mathbf{t}, R) \cdot \sum_w Z^{(X)}(m_1, m_2, m_3 - iw_1, m_4 - iw_2; \mathbf{t}) \\ &= C_{XY}(\mathbf{m}, \mathbf{t}) \sum_w Z^{(Y)}(\mathbf{t}; -m_1, -m_2, -(m_3 - iw_1), -(m_4 - iw_2)). \end{aligned} \quad (\text{A.18})$$

We now show that this vortex defect is mirror dual to the Wilson defect \widetilde{W}_R , associated with the central $U(2)$ gauge node of the quiver Y in the same representation R . The latter defect has the following partition function:

$$Z^{(Y[\widetilde{W}_R])}(\mathbf{t}; \mathbf{m}) = \int d\sigma^1 [d\sigma^2] d\sigma^3 Z_{\text{int}}^{(Y)}(\{\sigma^\gamma\}, \mathbf{t}, \mathbf{m}) \cdot Z_{\text{Wilson}}(\sigma^2, R), \quad (\text{A.19})$$

$$= \sum_{w \in R} Z^{(Y[\widetilde{W}_R])}(\mathbf{t}; \mathbf{m}|w), \quad (\text{A.20})$$

where the constituent functions are given as

$$Z_{\text{int}}^{(Y)}(\{\sigma^\gamma\}, \mathbf{t}, \mathbf{m}) = \frac{e^{2\pi i \sigma^1 (m_1 - m_2)} e^{2\pi i \text{Tr} \sigma^2 (m_2 - m_3)} e^{2\pi i \sigma^3 (m_3 - m_4)} \sinh^2 \pi(\sigma_1^2 - \sigma_2^2)}{\prod_{i=1}^2 \cosh \pi(\sigma^1 - \sigma_i^2) \prod_{a=1}^2 \cosh \pi(\sigma_i^2 - t_a) \cosh \pi(\sigma^3 - \sigma_i^2)}, \quad (\text{A.21})$$

$$Z_{\text{Wilson}}(\sigma^2, R) = \sum_{w \in R} \left(e^{2\pi \sum_j w_j \sigma_j^2} \right). \quad (\text{A.22})$$

Integrating over σ_3 and manipulating the resultant expression, one can show that

$$Z^{(Y[\widetilde{W}_R])}(\mathbf{t}; \mathbf{m}|w) = \frac{1}{2} \sum_{\rho' \in S_2} Z^{(Y)}(\mathbf{t}; m_1, m_2, m_3 + iw_{\rho'(1)}, m_4 + iw_{\rho'(2)}). \quad (\text{A.23})$$

Again, recognizing that S_2 is the Weyl group of the $U(2)$ gauge group, we obtain

$$Z^{(Y[\widetilde{W}_R])}(\mathbf{t}; \mathbf{m}) = \sum_{w \in R} Z^{(Y)}(\mathbf{t}; m_1, m_2, m_3 + iw_1, m_4 + iw_2). \quad (\text{A.24})$$

Using (A.24) in the equation (A.18), we obtain the following relation between the two defect partition functions, i.e.

$$Z^{(X[V_{2,R}^r])}(\mathbf{m}; \mathbf{t}) = C_{XY}(\mathbf{m}, \mathbf{t}) Z^{(Y[\widetilde{W}_R])}(\mathbf{t}; -\mathbf{m}). \quad (\text{A.25})$$

Normalizing by the respective partition functions, the expectation values of the two defects are related as:

$$\langle V_{2,R}^r \rangle_X(\mathbf{m}; \mathbf{t}) = \langle \widetilde{W}_R \rangle_Y(\mathbf{t}; -\mathbf{m}). \quad (\text{A.26})$$

The case of $M = 1, 3$: Consider the $M = 1$ case first. The expression on the RHS of (A.15) can be rewritten using the identity,

$$\frac{\sinh \pi(s_1 - s_2 + i(w_1 - w_2)z)}{\prod_{i=1}^2 \cosh \pi(s_i + iw_i z - m_4)} = - \sum_{\rho \in S_2} (-1)^\rho \left(\frac{e^{-\pi(s_{\rho(1)} + iw_{\rho(1)} - m_4)}}{\cosh \pi(s_{\rho(1)} + iw_{\rho(1)} - m_4)} \right). \quad (\text{A.27})$$

The resultant expression can be massaged into the following form:

$$Z^{(X[V_{1,R}^r])}(\mathbf{m}; \mathbf{t}|w) = \frac{1}{2} (-1)^{w_1 + w_2} \sum_{\rho \in S_2} Z^{(X)}(m_1, m_2, m_3, m_4 - iw_{\rho(1)}; \mathbf{t}). \quad (\text{A.28})$$

Summing over all $w \in R$, and using the fact that S_2 is the Weyl group for the $U(2)$ gauge group, we get

$$Z^{(X[V_{1,R}^r])}(\mathbf{m}; \mathbf{t}) = \sum_{w \in R} W_{\text{b.g.}}(\mathbf{t}, R) (-1)^{w_1 + w_2} Z^{(X)}(m_1, m_2, m_3, m_4 - iw_1; \mathbf{t}). \quad (\text{A.29})$$

Using the mirror symmetry relation (A.6)-(A.7), the above equation can be rewritten as

$$Z^{(X[V_{1,R}^r])}(\mathbf{m}; \mathbf{t}) = C_{XY}(\mathbf{m}, \mathbf{t}) (-1)^{|R|} \sum_w e^{2\pi t_2 w_2} Z^{(Y)}(\mathbf{t}; -m_1, -m_2, -m_3, -(m_4 - iw_1)). \quad (\text{A.30})$$

Mirror symmetry maps the vortex defect $V_{1,R}^r$ to a Wilson defect $\widetilde{W}_{\widetilde{R}}$ in the theory Y :

$$\widetilde{W}_{\widetilde{R}} = \sum_{\kappa \in \Delta} \widetilde{W}_{2, q_2^\kappa}^{\text{flavor}} \widetilde{W}_{q_1^\kappa}^{(3)}, \quad (\text{A.31})$$

where $\widetilde{W}_{2, q_2^\kappa}^{\text{flavor}}$ is a flavor Wilson defect of charge q_2^κ under a $U(1)_{t_2}$ subgroup of the $U(2)_f$ flavor symmetry of Y , embedded as $U(1)_{t_1} \times U(1)_{t_2} \subset U(2)_f$, and $\widetilde{W}_{q_1^\kappa}^{(3)}$ is a gauge Wilson defect of charge q_1^κ for the rightmost $U(1)$ gauge node in the quiver Y . The charges (q_1^κ, q_2^κ) are obtained from the decomposition of the representation R under the subgroup

$U(1) \times U(1) \subset U(2)$, and Δ is the set of such charge doublets counted with degeneracies. This mirror map can be directly read off from (A.30) as follows. Firstly, note that

$$Z^{(Y)}(\mathbf{t}; -m_1, -m_2, -m_3, -(m_4 - iw_1)) = Z^{(Y[\widetilde{W}_{w_1}^{(3)}])}(\mathbf{t}; \mathbf{m}), \quad (\text{A.32})$$

while the first factor in the summand on the RHS of (A.30) can be identified as the contribution of the flavor Wilson defect $\widetilde{W}_{2,q_2^\kappa}^{\text{flavor}}$. Putting them together, we get

$$Z^{(X[V_{1,R}^r])}(\mathbf{m}; \mathbf{t}) = C_{XY}(\mathbf{m}, \mathbf{t}) \sum_{w \in R} Z_{\text{Wilson}}(t_2, w_2) Z^{(Y[\widetilde{W}_{w_1}^{(3)}])}(\mathbf{t}; -\mathbf{m}) \quad (\text{A.33})$$

$$= C_{XY}(\mathbf{m}, \mathbf{t}) \sum_{\kappa \in \Delta} Z_{\text{Wilson}}(t_2, q_2^\kappa) Z^{(Y[\widetilde{W}_{q_1^\kappa}^{(3)}])}(\mathbf{t}; -\mathbf{m}). \quad (\text{A.34})$$

Normalizing by the respective partition functions, the expectation values of the two defects are related as:

$$\langle V_{1,R}^r \rangle_X(\mathbf{m}; \mathbf{t}) = \left\langle \sum_{\kappa \in \Delta} \widetilde{W}_{2,q_2^\kappa}^{\text{flavor}} \widetilde{W}_{q_1^\kappa}^{(3)} \right\rangle_Y(\mathbf{t}; -\mathbf{m}). \quad (\text{A.35})$$

The case of the vortex defect $V_{M,R}^r$ for $M = 3$ can be handled in a similar fashion. Note that the RHS of (A.15) can be rewritten, after a change of variables $s_j \rightarrow s_j - iw_j z$, in the following fashion:

$$Z^{(X[V_{3,R}^r])}(\mathbf{m}; \mathbf{t}|w) = \frac{1}{2} (-1)^{w_1+w_2} e^{2\pi(w_1+w_2)(t_1-t_2)} \sum_{\rho \in S_2} Z^{(X)}(m_1 + iw_{\rho(1)}, m_2, m_3, m_4; \mathbf{t}). \quad (\text{A.36})$$

Summing over the weights $w \in R$, as before, yields

$$Z^{(X[V_{3,R}^r])}(\mathbf{m}; \mathbf{t}) = \sum_{w \in R} (-1)^{w_1+w_2} e^{2\pi t_1(w_1+w_2)} Z^{(X)}(m_1 + iw_1, m_2, m_3, m_4; \mathbf{t}). \quad (\text{A.37})$$

Proceeding in the same fashion as before, we obtain

$$Z^{(X[V_{3,R}^r])}(\mathbf{m}; \mathbf{t}) = C_{XY}(\mathbf{m}, \mathbf{t}) \sum_{w \in R} Z_{\text{Wilson}}^{\text{flavor}}(t_1, w_2) Z^{(Y[\widetilde{W}_{w_1}^{(1)}])}(\mathbf{t}; -\mathbf{m}) \quad (\text{A.38})$$

$$= C_{XY}(\mathbf{m}, \mathbf{t}) \sum_{\kappa \in \Delta} Z_{\text{Wilson}}^{\text{flavor}}(t_1, q_2^\kappa) Z^{(Y[\widetilde{W}_{q_1^\kappa}^{(1)}])}(\mathbf{t}; -\mathbf{m}), \quad (\text{A.39})$$

where $Z_{\text{Wilson}}^{\text{flavor}}(t_1, w_2)$ is the contribution of a flavor Wilson defect and $\widetilde{W}_{w_1}^{(1)}$ is a Wilson defect for the leftmost $U(1)$ gauge node in quiver Y . The charges (q_1^κ, q_2^κ) and the set Δ are defined as in the $M = 1$ case. This leads to the mirror symmetry map

$$\langle V_{3,R}^r \rangle_X(\mathbf{m}; \mathbf{t}) = \left\langle \sum_{\kappa \in \Delta} \widetilde{W}_{1,q_2^\kappa}^{\text{flavor}} \widetilde{W}_{q_1^\kappa}^{(1)} \right\rangle_Y(\mathbf{t}; -\mathbf{m}). \quad (\text{A.40})$$

The case of $M = 4, 0$: Similar to the $M = 3$ case, we implement a change of variables $s_j \rightarrow s_j - iw_j z -$ on the RHS of (A.15), leading to the expression

$$Z^{(X[V_{4,R}^r])}(\mathbf{m}; \mathbf{t}) = W_{\text{b.g.}}(\mathbf{t}, R) \cdot \sum_{w \in R} (-1)^{w_1+w_2} e^{2\pi(w_1+w_2)(t_1-t_2)} Z^{(X)}(\mathbf{m}; \mathbf{t}) \quad (\text{A.41})$$

$$= \left(\sum_{w \in R} (-1)^{w_1+w_2} e^{2\pi t_1(w_1+w_2)} \right) Z^{(X)}(\mathbf{m}; \mathbf{t}). \quad (\text{A.42})$$

Following the procedure as above, this leads to the mirror map:

$$\langle V_{4,R}^r \rangle_X(\mathbf{m}; \mathbf{t}) = \langle \widetilde{W}_{1,|R|}^{\text{flavor}} \rangle_Y(\mathbf{t}; -\mathbf{m}), \quad (\text{A.43})$$

where $\widetilde{W}_{|R|}^{\text{flavor}}$ is a flavor Wilson defect of charge $|R|$ in a $U(1)_{t_1}$ subgroup of the $U(2)_f$ flavor symmetry of the quiver Y , embedded as $U(1)_{t_1} \times U(1)_{t_2} \subset U(2)_f$.

The $M = 0$ defect also maps to a flavor Wilson defect in Y , which can be directly read off from (A.10)-(A.12). In this case, one can directly take the $z \rightarrow 1$ limit, since the residue of the z -dependent pole vanishes. The resultant mirror map is

$$\langle V_{0,R}^r \rangle_X(\mathbf{m}; \mathbf{t}) = \langle \widetilde{W}_{2,|R|}^{\text{flavor}} \rangle_Y(\mathbf{t}; -\mathbf{m}). \quad (\text{A.44})$$

A.3 The Wilson defect W_R and the dual defects

Consider the Wilson defect W_R for the $U(2)$ gauge node in the theory X in the representation R . The defect partition function has the following form:

$$Z^{(X[W_R])}(\mathbf{m}; \mathbf{t}) = \int [ds] Z_{\text{int}}^{(X)}(\mathbf{s}, \mathbf{m}, \mathbf{t}) \cdot Z_{\text{Wilson}}(\mathbf{s}, R) \quad (\text{A.45})$$

$$= \sum_{w \in R} Z^{(X[W_R])}(\mathbf{m}; \mathbf{t}|w), \quad (\text{A.46})$$

where the constituent functions are given as

$$Z_{\text{int}}^{(X)}(\mathbf{s}, \mathbf{m}, \mathbf{t}) = \frac{e^{2\pi i \text{Tr} \mathbf{s}(t_1-t_2)} \sinh^2 \pi(s_1 - s_2)}{\prod_{j=1}^2 \prod_{i=1}^4 \cosh \pi(s_j - m_i)}, \quad Z_{\text{Wilson}}(\mathbf{s}, R) = \sum_{w \in R} \left(e^{2\pi \sum_j w_j s_j} \right). \quad (\text{A.47})$$

Using the Cauchy determinant identity twice to reduce $Z^{(X[W_R])}(\mathbf{m}; \mathbf{t}|w)$ in terms of Abelian integrals, and then performing those Abelian integrals, we obtain

$$Z^{(X[W_R])}(\mathbf{m}; \mathbf{t}|w) = \sum_{\rho, \tilde{\rho}} (-1)^{\rho+\tilde{\rho}} \frac{(-1)^{w_1+w_2} \prod_{i=1}^2 \left(e^{2\pi i m_{\rho(i)}(\eta-iw_i)} - e^{2\pi i m_{2+\tilde{\rho}(i)}(\eta-iw_i)} \right)}{\sinh \pi m_{12} \sinh \pi m_{34} \sinh^2 \pi \eta \prod_{i=1}^2 \sinh \pi(m_{\rho(i)} - m_{2+\tilde{\rho}(i)})}, \quad (\text{A.48})$$

where $m_{12} = m_1 - m_2$, $m_{34} = m_3 - m_4$, $\eta = t_1 - t_2$, and $\rho, \tilde{\rho}$ are elements of S_2 .

The dual of the Wilson defect W_R in the theory X , is the vortex defect $\tilde{V}_{1,R}$ in the theory Y , where R is a representation of the central $U(2)$ gauge group. The defect partition function for the latter, using a right SQM realization, is given by

$$Z^{(Y[\tilde{V}_{1,R}])}(\mathbf{t}; \mathbf{m}) = W_{\text{b.g.}}(\mathbf{m}, R) \cdot \lim_{z \rightarrow 1} \int d\sigma^1 \left[d\boldsymbol{\sigma}^2 \right] d\sigma^3 Z_{\text{int}}^{(Y)}(\{\sigma^{\gamma'}\}, \mathbf{t}, \mathbf{m}) \cdot \mathcal{I}^{\tilde{\Sigma}_r^{1,R}}(\{\sigma^{\gamma'}\}, \mathbf{t}, z | \boldsymbol{\xi} < 0), \quad (\text{A.49})$$

$$=: W_{\text{b.g.}}(\mathbf{m}, R) \cdot \lim_{z \rightarrow 1} \int d\sigma^1 \left[d\boldsymbol{\sigma}^2 \right] Z_{\text{int}}^{(Y[\tilde{V}_{1,R}^r])}(\{\sigma^{\gamma'}\}, \mathbf{t}, \mathbf{m}, z | \boldsymbol{\xi} < 0). \quad (\text{A.50})$$

Using similar arguments as above, the defect partition function can be rewritten as

$$Z^{(Y[\tilde{V}_{1,R}])}(\mathbf{t}; \mathbf{m}) = W_{\text{b.g.}}(\mathbf{m}, R) \cdot \sum_{w \in R} Z^{(Y[\tilde{V}_{1,R}])}(\mathbf{t}; \mathbf{m}|w), \quad (\text{A.51})$$

where the individual functions can be written as

$$W_{\text{b.g.}}(\mathbf{t}, R) = e^{2\pi m_3 |R|}, \quad (\text{A.52})$$

$$Z^{(Y[\tilde{V}_{1,R}^r])}(\mathbf{t}; \mathbf{m}|w) = \lim_{z \rightarrow 1} \int d\sigma^1 \left[d\boldsymbol{\sigma}^2 \right] d\sigma^3 \frac{Z_{\text{int}}^{(Y)}(\{\sigma^{\gamma'}\}, \mathbf{t}, \mathbf{m}) \prod_i \cosh \pi(\sigma_i^2 - t_2) \cosh \pi(\sigma^3 - \sigma_i^2)}{\prod_i \cosh \pi(\sigma_i^2 + iw_i z - t_2) \cosh \pi(\sigma^3 - \sigma_i^2 - iw_i z)}, \quad (\text{A.53})$$

$$Z_{\text{int}}^{(Y)}(\{\sigma^{\gamma'}\}, \mathbf{t}, \mathbf{m}) = \frac{e^{2\pi i \sigma^1 (m_1 - m_2)} e^{2\pi i \text{Tr} \boldsymbol{\sigma}^2 (m_2 - m_3)} e^{2\pi i \sigma^3 (m_3 - m_4)} \sinh^2 \pi(\sigma_1^2 - \sigma_2^2)}{\prod_{i=1}^2 \cosh \pi(\sigma^1 - \sigma_i^2) \prod_{a=1}^2 \cosh \pi(\sigma_i^2 - t_a) \cosh \pi(\sigma^3 - \sigma_i^2)}. \quad (\text{A.54})$$

Performing the Abelian integrals over σ_1 and σ_3 , $Z^{(Y[\tilde{V}_{1,R}^r])}(\mathbf{m}; \mathbf{t}|w)$ can be recast in the following form:

$$Z^{(Y[\tilde{V}_{1,R}^r])}(\mathbf{t}; \mathbf{m}|w) \quad (\text{A.55})$$

$$= \lim_{z \rightarrow 1} \int \left[d\boldsymbol{\sigma}^2 \right] \frac{(-1)^{w_1 + w_2} e^{2\pi i m_{23} \text{Tr} \boldsymbol{\sigma}^2} (e^{2\pi i \sigma_1^2 m_{12}} - e^{2\pi i \sigma_2^2 m_{12}}) (e^{2\pi i (\sigma_1^2 + iw_1 z) m_{34}} - e^{2\pi i (\sigma_2^2 + iw_2 z) m_{34}})}{\sinh \pi m_{12} \sinh \pi m_{34} \prod_i \cosh \pi(\sigma_i^2 + iw_i z - t_2) \cosh \pi(\sigma_i^2 - t_1)}. \quad (\text{A.56})$$

Finally, performing the Abelian integrals over σ_1^2 and σ_2^2 , and manipulating the resultant expression, we obtain:

$$Z^{(Y[\tilde{V}_{1,R}^r])}(\mathbf{t}; \mathbf{m}|w) = e^{-2\pi m_3 (w_1 + w_2)} e^{2\pi i t_1 (m_1 + m_2)} e^{-2\pi i t_2 (m_3 + m_4)} Z^{(X[W_R])}(\mathbf{m}; -\mathbf{t}|w). \quad (\text{A.57})$$

The defect partition functions are therefore related as

$$Z^{(X[W_R])}(\mathbf{m}; \mathbf{t}) = C_{XY}(\mathbf{m}, \mathbf{t}) Z^{(Y[\tilde{V}_{1,R}^r])}(-\mathbf{t}; \mathbf{m}), \quad (\text{A.58})$$

which leads to the following mirror map:

$$\boxed{\langle W_R \rangle_X(\mathbf{m}; \mathbf{t}) = \langle \tilde{V}_{1,R}^r \rangle_Y(-\mathbf{t}; \mathbf{m})}. \quad (\text{A.59})$$

B Abelian Gauging: Defects in the D_4 quiver gauge theory

B.1 Vortex defects

Let us first consider the vortex defect, discussed in Section 4.1.1, which can be constructed from the defect $V_{M,R}$ for $M = 2$ in the quiver X by an S -type operation. The S -type operation $\mathcal{O}_{\mathcal{P}}$ is specified in (4.6)-(4.7), and the corresponding partition function is given as¹¹:

$$Z^{\mathcal{O}_{\mathcal{P}}(X[V_{2,R}^r])} = \lim_{z \rightarrow 1} \int \prod_{i=1}^3 du_i [ds] \prod_{i=1}^3 Z_{\text{FI}}(u_i, \eta_i) Z_{\text{int}}^{(X)}(\mathbf{s}, \mathbf{u}, v, \mathbf{t}) W_{\text{b.g.}}(\mathbf{t}, R) \mathcal{I}^{\Sigma_r^{2,R}}(\mathbf{s}, \mathbf{u}, z | \boldsymbol{\xi} < 0), \quad (\text{B.1})$$

$$Z_{\text{int}}^{(X)}(\mathbf{s}, \mathbf{u}, v, \mathbf{t}) = \left\{ Z_{\text{int}}^{(X)}(\mathbf{s}, \mathbf{m}, \mathbf{t}) \mid m_3 = u_1, m_4 = u_2, m_1 = u_3, m_2 = v \right\}, \quad (\text{B.2})$$

$$W_{\text{b.g.}}(\mathbf{t}, R) = e^{2\pi t_2 |R|}, \quad (\text{B.3})$$

$$\mathcal{I}^{\Sigma_r^{2,R}}(\mathbf{s}, \mathbf{u}, z | \boldsymbol{\xi} < 0) = \sum_{w \in R} \prod_{j=1}^2 \prod_{i=1}^2 \frac{\cosh \pi(s_j - u_i)}{\cosh \pi(s_j + iw_j z - u_i)}. \quad (\text{B.4})$$

We will identify the resultant 3d-1d quiver as a vortex defect in the D_4 quiver gauge theory X' , and will denote it as $X'[V_{2,R}^{(I)}]$.

$$Z^{(X'[V_{2,R}^{(I)}])} := e^{-2\pi(t_2 - \frac{\eta_1 + \eta_2}{2})|R|} Z^{\mathcal{O}_{\mathcal{P}}(X[V_{2,R}^r])}(v; \mathbf{t}, \boldsymbol{\eta}), \quad (\text{B.5})$$

$$= e^{2\pi(\frac{\eta_1 + \eta_2}{2})|R|} \lim_{z \rightarrow 1} \int \prod_{i=1}^3 du_i [ds] \prod_{i=1}^3 Z_{\text{FI}}(u_i, \eta_i) Z_{\text{int}}^{(X)}(\mathbf{s}, \mathbf{u}, v, \mathbf{t}) \mathcal{I}^{\Sigma_r^{2,R}}(\mathbf{s}, \mathbf{u}, z | \boldsymbol{\xi} < 0). \quad (\text{B.6})$$

Mirror symmetry for the 3d defects $X[V_{2,R}]$ and $Y[\widetilde{W}_R]$ leads to the following identity:

$$\begin{aligned} & \int [ds] Z_{\text{int}}^{(X)}(\mathbf{s}, \mathbf{u}, v, \mathbf{t}) W_{\text{b.g.}}(\mathbf{t}, R) \mathcal{I}^{\Sigma_r^{2,R}}(\mathbf{s}, \mathbf{u}, z | \boldsymbol{\xi} < 0) \\ &= \sum_{w \in R} W_{\text{b.g.}}(\mathbf{t}, R) \frac{\sinh \pi(u_1 - u_2 - iw_1 z + iw_2 z)}{\sinh \pi(u_1 - u_2)} Z^{(X)}(u_3, v, u_1 - iw_1 z, u_2 - iw_2 z; \mathbf{t}) \\ &= \sum_{w \in R} C_{XY}(\mathbf{u}, v, \mathbf{t}) \frac{\sinh \pi(u_1 - u_2 - iw_1 z + iw_2 z)}{\sinh \pi(u_1 - u_2)} Z^{(Y)}(\mathbf{t}; -u_3, -v, -u_1 + iw_1 z, -u_2 + iw_2 z) \\ &= C_{XY}(\mathbf{u}, v, \mathbf{t}) \int \prod_{\gamma'=1}^3 [d\sigma^{\gamma'}] Z_{\text{int}}^{(Y)}(\{\sigma^{\gamma'}\}, \mathbf{t}, -u_3, -v, -u_1, -u_2) \sum_{w \in R} e^{2\pi \sum_j w_j \sigma_j^2 z} \quad (\text{B.7}) \end{aligned}$$

$$=: C_{XY}(\mathbf{u}, v, \mathbf{t}) \int \prod_{\gamma'=1}^3 [d\sigma^{\gamma'}] Z_{\text{int}}^{(Y[\widetilde{W}_R])}(\{\sigma^{\gamma'}\}, \mathbf{t}, -u_3, -v, -u_1, -u_2, z). \quad (\text{B.8})$$

This is a concrete example of the identity (3.49) for the dual pair (X, Y) , $\mathcal{D} = V_{2,R}$ is a vortex defect and $\mathcal{D}^\vee = \widetilde{W}_R$ is a Wilson defect.

¹¹For the subsequent analysis in this section, we will drop the factors $\mathcal{F}(s_j, z)$ for reasons noted in the main text of the paper.

We can now compute the dual defect partition function, following the recipe given by (3.54)-(3.55). From (3.55), the function $\mathcal{Z}_{\tilde{\mathcal{O}}_{\mathcal{P}}(Y)}$ is given as

$$\mathcal{Z}_{\tilde{\mathcal{O}}_{\mathcal{P}}(Y)}(\{\sigma^{\gamma'}\}, \mathbf{t}, \boldsymbol{\eta}) = \delta(\eta_1 + \text{Tr}\sigma^2 - \sigma^3 - t_2) \delta(\eta_2 - t_2 + \sigma^3) \delta(\eta_3 + t_1 - \sigma^1). \quad (\text{B.9})$$

The general expression in (3.54) for the dual defect partition function reduces to the following expression:

$$\begin{aligned} Z_{\tilde{\mathcal{O}}_{\mathcal{P}}(Y[\tilde{W}_R])}(\mathbf{t}, \boldsymbol{\eta}; v) &= \lim_{z \rightarrow 1} \int \prod_{\gamma'=1}^3 [d\sigma^{\gamma'}] \mathcal{Z}_{\tilde{\mathcal{O}}_{\mathcal{P}}(Y)}(\{\sigma^{\gamma'}\}, \mathbf{t}, \boldsymbol{\eta}) C_{XY}(\mathbf{u} = 0, v, \mathbf{t}) \\ &\quad \times Z_{\text{int}}^{(Y[\tilde{W}_R])}(\{\sigma^{\gamma'}\}, \mathbf{t}, \mathbf{u} = 0, -v, z), \end{aligned} \quad (\text{B.10})$$

where the function $Z_{\text{int}}^{(Y[\tilde{W}_R])}(\dots, z)$ can be read off from (B.8):

$$Z_{\text{int}}^{(Y[\tilde{W}_R])}(\{\sigma^{\gamma'}\}, \mathbf{t}, \mathbf{u} = 0, -v, z) = Z_{\text{int}}^{(Y)}(\{\sigma^{\gamma'}\}, \mathbf{t}, \mathbf{u} = 0, -v) \sum_{w \in R} e^{2\pi \sum_i w_i \sigma_i^2 z}. \quad (\text{B.11})$$

Since there are no z -dependent poles in the integrand, the $z \rightarrow 1$ limit can be taken at this stage. Using the expression for $\mathcal{Z}_{\tilde{\mathcal{O}}_{\mathcal{P}}(Y)}$, implementing the delta functions and after shifting integration variables appropriately, we obtain

$$\begin{aligned} Z_{\tilde{\mathcal{O}}_{\mathcal{P}}(Y[\tilde{W}_R])}(\mathbf{t}, \boldsymbol{\eta}; v) &= C(v, \boldsymbol{\eta}, \mathbf{t}) \sum_{w \in R} \int [d\boldsymbol{\sigma}^2] \delta(\text{Tr}\boldsymbol{\sigma}^2) Z_{1\text{-loop}}^{\text{vec}}(\boldsymbol{\sigma}^2) Z_{1\text{-loop}}^{\text{fund}}(\boldsymbol{\sigma}^2, \eta_3 + \eta + \frac{\eta_1 + \eta_2}{2}) \\ &\quad \times Z_{1\text{-loop}}^{\text{fund}}(\boldsymbol{\sigma}^2, \frac{\eta_1 - \eta_2}{2}) \prod_{a=1}^2 Z_{1\text{-loop}}^{\text{fund}}(\boldsymbol{\sigma}^2, t_a + \frac{\eta_1 + \eta_2}{2} - t_2) e^{2\pi \sum_i w_i \sigma_i^2}, \end{aligned} \quad (\text{B.12})$$

$$=: C(v, \boldsymbol{\eta}, \mathbf{t}) \int [d\boldsymbol{\sigma}^2] \delta(\text{Tr}\boldsymbol{\sigma}^2) Z_{\text{int}}^{U(2), N_f=4}(\boldsymbol{\sigma}^2, \mathbf{m}'(\mathbf{t}, \boldsymbol{\eta}), \eta' = 0) \sum_{w \in R} e^{2\pi \sum_i w_i \sigma_i^2}, \quad (\text{B.13})$$

where $\eta = t_1 - t_2$ and $C(v, \boldsymbol{\eta}, \mathbf{t}) = e^{2\pi i v (\eta_1 + \eta_2 + \eta_3 + 2(t_1 - t_2))}$. The masses \mathbf{m}' of the theory Y' are given in terms of the FI parameters of X' as follows:

$$m'_1 = \eta_3 + \eta + \frac{\eta_1 + \eta_2}{2}, \quad (\text{B.14})$$

$$m'_2 = \eta + \frac{\eta_1 + \eta_2}{2}, \quad (\text{B.15})$$

$$m'_3 = \frac{\eta_1 + \eta_2}{2}, \quad (\text{B.16})$$

$$m'_4 = \frac{\eta_1 - \eta_2}{2}. \quad (\text{B.17})$$

The above expression (B.13) reproduces the defect partition function in (4.14).

The vortex defects which are constructed from the defect $V_{M,R}$ for $M \neq 2$ in quiver X can be analyzed in a similar fashion as above.

B.2 Wilson defects

Let us now consider a Wilson defect, discussed in Section 4.1.3, which can be constructed from the defect W_R in the quiver X by an S -type operation $\mathcal{O}_{\mathcal{P}}$ specified in (4.31)-(4.32). The starting point is the dual pair of defects $X[W_R]$ and $Y[\tilde{V}_{1,R}^r]$ discussed in Section A.3. The partition function $\mathcal{O}_{\mathcal{P}}(X[W_R])$ is given as:

$$Z^{\mathcal{O}_{\mathcal{P}}(X[W_R])} = \int \prod_{i=1}^3 du_i \left[ds \right] \prod_{i=1}^3 Z_{\text{FI}}(u_i, \eta_i) Z_{\text{int}}^{(X)}(\mathbf{s}, \mathbf{u}, v, \mathbf{t}) Z_{\text{Wilson}}(\mathbf{s}, R), \quad (\text{B.18})$$

$$Z_{\text{int}}^{(X)}(\mathbf{s}, \mathbf{u}, v, \mathbf{t}) = \left\{ Z_{\text{int}}^{(X)}(\mathbf{s}, \mathbf{m}, \mathbf{t}) \mid m_1 = u_1, m_2 = u_2, m_4 = u_3, m_3 = v \right\}, \quad (\text{B.19})$$

$$Z_{\text{Wilson}}(\mathbf{s}, R) = \sum_{w \in R} e^{\sum_j w_j s_j}. \quad (\text{B.20})$$

Mirror symmetry of the defects $X[W_R]$ and $Y[\tilde{V}_{1,R}^r]$ imply the following z -dependent identity:

$$\begin{aligned} \int [ds] Z_{\text{int}}^{(X[W_R])}(\mathbf{s}, \mathbf{u}, v, \mathbf{t}, z) &=: \int [ds] Z_{\text{int}}^{(X)}(\mathbf{s}, \mathbf{u}, v, \mathbf{t}) \sum_{w \in R} e^{\sum_j w_j s_j z} \\ &= C_{XY}(\mathbf{u}, v, \mathbf{t}) \int d\sigma^1 [d\sigma^2] d\sigma^3 W_{\text{b.g.}}(v, R) Z_{\text{int}}^{(Y[\tilde{V}_{1,R}^r])}(\{\sigma^{\gamma'}\}, -\mathbf{t}, \mathbf{u}, v, z), \end{aligned} \quad (\text{B.21})$$

where the contact term C_{XY} and the background Wilson defect $W_{\text{b.g.}}$ are given as

$$C_{XY}(\mathbf{u}, v, \mathbf{t}) = e^{2\pi i t_1(u_1+u_2)} e^{-2\pi i t_2(u_3+v)}, \quad W_{\text{b.g.}}(v, R) = e^{2\pi v |R|}. \quad (\text{B.22})$$

The integrand $Z_{\text{int}}^{(Y[\tilde{V}_{1,R}^r])}$ in (B.21) is given as

$$Z_{\text{int}}^{(Y[\tilde{V}_{1,R}^r])}(\{\sigma^{\gamma'}\}, \mathbf{t}, \mathbf{u}, v, z) = Z_{\text{int}}^{(Y)}(\{\sigma^{\gamma'}\}, \mathbf{t}, \mathbf{u}, v) \cdot \mathcal{I}_{\tilde{V}_{1,R}^r}^{\Sigma_r^{1,R}}(\{\sigma^{\gamma'}\}, \mathbf{t}, z | \xi < 0), \quad (\text{B.23})$$

$$Z_{\text{int}}^{(Y)}(\{\sigma^{\gamma'}\}, \mathbf{t}, \mathbf{u}, v) = \frac{e^{2\pi i \sigma^1(u_1-u_2)} e^{2\pi i \text{Tr} \sigma^2(u_2-v)} e^{2\pi i \sigma^3(v-u_3)} \sinh^2 \pi(\sigma_1^2 - \sigma_2^2)}{\prod_{j=1}^2 \cosh \pi(\sigma^1 - \sigma_j^2) \prod_{a=1}^2 \cosh \pi(\sigma_j^2 - t_a) \cosh \pi(\sigma^3 - \sigma_j^2)}, \quad (\text{B.24})$$

$$\mathcal{I}_{\tilde{V}_{1,R}^r}^{\Sigma_r^{1,R}}(\{\sigma^{\gamma'}\}, \mathbf{t}, z | \xi < 0) = \sum_{w \in R} \frac{\prod_i \cosh \pi(\sigma_j^2 - t_2) \cosh \pi(\sigma_j^2 - \sigma^3)}{\prod_j \cosh \pi(\sigma_j^2 + iw_j z - t_2) \cosh \pi(\sigma_j^2 + iw_j z - \sigma^3)}. \quad (\text{B.25})$$

The identity (B.21) is another concrete example of the general identity (3.49) for the dual pair (X, Y) , $\mathcal{D} = W_R$ is a Wilson defect and $\mathcal{D}^\vee = \tilde{V}_{1,R}^r$ is a vortex defect.

Following the general discussion around (3.59)-(3.60), the dual partition function $Z^{(Y'[(\tilde{V}_{1,R}^r)^\vee])} = Z^{\tilde{\mathcal{O}}_{\mathcal{P}}(Y[\tilde{V}_{1,R}^r])}(\mathbf{t}, \boldsymbol{\eta}; v)$ can be written as:

$$\begin{aligned} Z^{\tilde{\mathcal{O}}_{\mathcal{P}}(Y[\tilde{V}_{1,R}^r])}(\mathbf{t}, \boldsymbol{\eta}; v) &= \lim_{z \rightarrow 1} \int d\sigma^1 [d\sigma^2] d\sigma^3 \mathcal{Z}_{\tilde{\mathcal{O}}_{\mathcal{P}}(Y)}(\{\sigma^{\gamma'}\}, \mathbf{t}, \boldsymbol{\eta}) C_{XY}(\mathbf{u} = 0, v, \mathbf{t}) W_{\text{b.g.}}(v, R) \\ &\quad \times Z_{\text{int}}^{(Y[\tilde{V}_{1,R}^r])}(\{\sigma^{\gamma'}\}, -\mathbf{t}, \mathbf{u} = 0, v, z), \end{aligned} \quad (\text{B.26})$$

Finally, the function $\mathcal{Z}_{\tilde{\mathcal{O}}_{\mathcal{P}}(Y)}$ can be computed from the general formula (3.60):

$$\mathcal{Z}_{\tilde{\mathcal{O}}_{\mathcal{P}}(Y)}(\{\sigma^{\gamma'}\}, \mathbf{t}, \boldsymbol{\eta}) = \delta(\eta_1 + \sigma^1 + t_1) \delta(\eta_2 - \sigma^1 + \text{Tr} \sigma^2 + t_1) \delta(\eta_3 - t_2 - \sigma^3). \quad (\text{B.27})$$

Putting together the different ingredients on the RHS of (B.26) and integrating over σ^1 and σ^2 , we obtain the following expression for the dual partition function (after some trivial shifts in the integration variable):

$$Z^{(Y'[(W'_R)^\vee])} = C \cdot W_{\text{b.g.}} \cdot \lim_{z \rightarrow 1} \int [d\boldsymbol{\sigma}] \delta(\text{Tr}\boldsymbol{\sigma}) Z_{\text{int}}^{U(2), N_f=4}(\boldsymbol{\sigma}, \mathbf{m}'(\mathbf{t}, \boldsymbol{\eta}), \boldsymbol{\eta}') \mathcal{I}^{\tilde{\Sigma}_r^{1,R}}(\boldsymbol{\sigma}, \mathbf{m}', z | \boldsymbol{\xi} < 0), \quad (\text{B.28})$$

$$C := C(v, \boldsymbol{\eta}, \mathbf{t}) = e^{2\pi i v(\eta_1 + \eta_2 + \eta_3 + 2(t_1 - t_2))}, \quad W_{\text{b.g.}} := W_{\text{b.g.}}(v, R) = e^{2\pi v|R|}, \quad (\text{B.29})$$

$$\mathcal{I}^{\tilde{\Sigma}_r^{1,R}}(\boldsymbol{\sigma}, \mathbf{m}', z | \boldsymbol{\xi} < 0) = \sum_{w \in R} \prod_{j=1}^2 \prod_{i=1}^2 \frac{\cosh \pi(\sigma_j - m'_i)}{\cosh \pi(\sigma_j + iw_j z - m'_i)}, \quad (\text{B.30})$$

where the masses $\{m'_i\}_{i=1, \dots, 4}$ are given in (B.14)-(B.17). The 3d-1d quiver $Y'[\tilde{V}'_{1,R}]$ in Fig. 29 can be read off from the RHS of (B.28).

One can similarly implement the S -type operation (4.31)-(4.32) on the dual pair $X[W_R]$ and $Y[\tilde{V}'_{1,R}]$. Mirror symmetry then implies the following z -dependent identity:

$$\begin{aligned} \int [ds] Z_{\text{int}}^{(X[W_R])}(\mathbf{s}, \mathbf{u}, v, \mathbf{t}, z) &=: \int [ds] Z_{\text{int}}^{(X)}(\mathbf{s}, \mathbf{u}, v, \mathbf{t}) \sum_{w \in R} e^{\sum_j w_j s_j z} \\ &= C_{XY}(\mathbf{u}, v, \mathbf{t}) \int d\sigma^1 [d\boldsymbol{\sigma}^2] d\sigma^3 W_{\text{b.g.}}(u_2, R) Z_{\text{int}}^{(Y[\tilde{V}'_{1,R}])}(\{\sigma^{\gamma'}\}, -\mathbf{t}, \mathbf{u}, v, z), \end{aligned} \quad (\text{B.31})$$

where the contact term C_{XY} and the background Wilson defect $W_{\text{b.g.}}$ are given as

$$C_{XY}(\mathbf{u}, v, \mathbf{t}) = e^{2\pi i t_1(u_1 + u_2)} e^{-2\pi i t_2(u_3 + v)}, \quad W_{\text{b.g.}}(u_2, R) = e^{2\pi u_2|R|}. \quad (\text{B.32})$$

The integrand $Z_{\text{int}}^{(Y[\tilde{V}'_{1,R}])}$ in (B.21) is given as

$$Z_{\text{int}}^{(Y[\tilde{V}'_{1,R}])}(\{\sigma^{\gamma'}\}, \mathbf{t}, \mathbf{u}, v, z) = Z_{\text{int}}^{(Y)}(\{\sigma^{\gamma'}\}, \mathbf{t}, \mathbf{u}, v) \cdot \mathcal{I}^{\tilde{\Sigma}_l^{1,R}}(\{\sigma^{\gamma'}\}, \mathbf{t}, z | \boldsymbol{\xi} > 0), \quad (\text{B.33})$$

$$\mathcal{I}^{\tilde{\Sigma}_l^{1,R}}(\{\sigma^{\gamma'}\}, \mathbf{t}, z | \boldsymbol{\xi} > 0) = \sum_{w \in R} \frac{\prod_i \cosh \pi(\sigma_j^2 - t_1) \cosh \pi(\sigma_j^2 - \sigma^3)}{\prod_j \cosh \pi(\sigma_j^2 - iw_j z - t_1) \cosh \pi(\sigma_j^2 - iw_j z - \sigma^3)}, \quad (\text{B.34})$$

where $Z_{\text{int}}^{(Y)}$ is given above. The dual partition function $Z^{(Y'[(\tilde{V}'_{1,R})^\vee])} = Z^{\tilde{\mathcal{O}}_{\mathcal{P}}(Y[\tilde{V}'_{1,R}])}(\mathbf{t}, \boldsymbol{\eta}; v)$ can be written as:

$$\begin{aligned} Z^{\tilde{\mathcal{O}}_{\mathcal{P}}(Y[\tilde{V}'_{1,R}])}(\mathbf{t}, \boldsymbol{\eta}; v) &= \lim_{z \rightarrow 1} \int d\sigma^1 [d\boldsymbol{\sigma}^2] d\sigma^3 \mathcal{Z}_{\tilde{\mathcal{O}}_{\mathcal{P}}(Y)}(\{\sigma^{\gamma'}\}, \mathbf{t}, \boldsymbol{\eta}) C_{XY}(\mathbf{u} = 0, v, \mathbf{t}) \\ &\quad \times Z_{\text{int}}^{(Y[\tilde{V}'_{1,R}])}(\{\sigma^{\gamma'}\}, -\mathbf{t}, \mathbf{u} = 0, v, z), \end{aligned} \quad (\text{B.35})$$

where the function $\mathcal{Z}_{\tilde{\mathcal{O}}_{\mathcal{P}}(Y)}$ can be computed from the general formula (3.60):

$$\mathcal{Z}_{\tilde{\mathcal{O}}_{\mathcal{P}}(Y)}(\{\sigma^{\gamma'}\}, \mathbf{t}, \boldsymbol{\eta}) = \delta(\eta_1 + \sigma^1 + t_1) \delta(\eta_2 - \sigma^1 + \text{Tr}\sigma^2 + t_1 - i|R|z) \delta(\eta_3 - t_2 - \sigma^3). \quad (\text{B.36})$$

Note that the form of $\mathcal{Z}_{\tilde{\mathcal{O}}_{\mathcal{P}}(Y)}$ is different from what we got in the case of the right SQM. Now, performing a change of variables $\sigma_j^2 \rightarrow \sigma_j^2 + iw_j z$ on the RHS of (B.35), and then

integrating over σ^1 and σ^2 , we can rewrite the dual partition function (after some trivial shifts in the integration variable) in the following form:

$$Z^{\tilde{\mathcal{O}}_{\mathcal{P}}(Y[\tilde{V}_{1,R}^l])} = C \cdot W_{\text{b.g.}} \cdot \lim_{z \rightarrow 1} \int [d\sigma] \delta(\text{Tr}\sigma) Z_{\text{int}}^{U(2), N_f=4}(\sigma, \mathbf{m}'(\mathbf{t}, \boldsymbol{\eta}), \boldsymbol{\eta}') \mathcal{I}^{\tilde{\Sigma}_r^{1,R}}(\sigma, \mathbf{m}', z | \boldsymbol{\xi} < 0), \quad (\text{B.37})$$

where C , $W_{\text{b.g.}}$, and $\mathcal{I}^{\tilde{\Sigma}_r^{1,R}}$ are functions given above. The final 3d-1d quiver is therefore identical to the one that we obtained in the earlier case.

C Non-Abelian Gauging : Defects in the D_6 quiver

In this section, we explicitly construct the mirror map in Fig. 32, which involves a vortex defect in the D_6 quiver on the one hand and a Wilson defect in the $Sp(2)$ gauge theory on the other. The starting point is the pair of linear quivers with defects in Fig. 31, where we implement the S -type operation (4.41) on the 3d-1d system ($X[V_{2,R}^l]$).

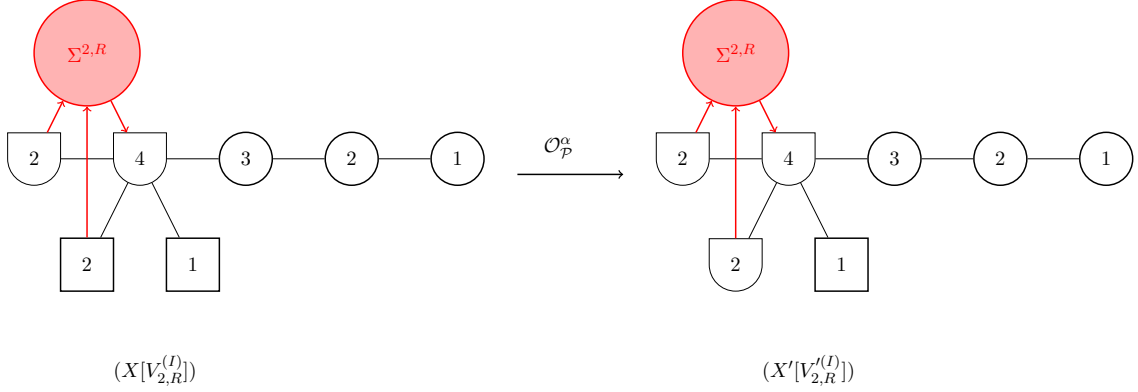

$$Z_{\mathcal{P}}^{G_\alpha(X[V_{2,R}^l])} = \lim_{z \rightarrow 1} \int [d\mathbf{u}] \prod_{\gamma=1}^5 [ds^\gamma] \mathcal{Z}_{G_\mathcal{P}}^\alpha(\mathbf{u}, \boldsymbol{\eta}^\alpha) Z_{\text{int}}^{(X, \mathcal{P})}(\{\mathbf{s}^\gamma\}, \mathbf{u}, v, \mathbf{t}) W_{\text{b.g.}}(\mathbf{t}, R) \times \mathcal{I}^{\Sigma_i^{2,R}}(\mathbf{s}^1, \mathbf{s}^2, \mathbf{u}, z | \boldsymbol{\xi} > 0), \quad (\text{C.1})$$

where the label γ of the gauge nodes of X increases from the left to the right. The constituent functions appearing in the matrix integral above – $\mathcal{Z}_{G_\mathcal{P}}^\alpha$, $Z_{\text{int}}^{(X)}$, $W_{\text{b.g.}}$ and $\mathcal{I}^{\Sigma_i^{2,R}}$ are given as

$$\mathcal{Z}_{G_\mathcal{P}}^\alpha(\mathbf{u}, \boldsymbol{\eta}^\alpha) = e^{2\pi i \eta_\alpha (u_1 + u_2)} \sinh^2 \pi(u_1 - u_2), \quad (\text{C.2})$$

$$Z_{\text{int}}^{(X, \mathcal{P})}(\{\mathbf{s}^\gamma\}, \mathbf{u}, v, \mathbf{t}) = Z_{\text{int}}^{(X)}(\{\mathbf{s}^\gamma\}, m_1 = u_1, m_2 = u_2, m_3 = v, \mathbf{t}), \quad (\text{C.3})$$

$$W_{\text{b.g.}}(\mathbf{t}, R) = e^{2\pi t_2 |R|}, \quad (\text{C.4})$$

$$\mathcal{I}^{\Sigma_i^{2,R}}(\mathbf{s}^1, \mathbf{s}^2, \mathbf{u}, z | \boldsymbol{\xi} > 0) = \sum_{w \in R} \prod_{j=1}^4 \left(\prod_{k=1}^2 \frac{\cosh \pi(s_j^2 - s_k^1)}{\cosh \pi(s_j^2 - iw_j z - s_k^1)} \right) \cdot \left(\prod_{i=1}^2 \frac{\cosh \pi(s_j^2 - u_i)}{\cosh \pi(s_j^2 - iw_j z - u_i)} \right). \quad (\text{C.5})$$

Mirror symmetry implies that one can write down an identity of the form (3.49) involving the z -dependent partition functions of X and Y . In the present case, this identity takes the form:

$$\begin{aligned} Z^{(X[V_{2,R}^l], \mathcal{P})}(\mathbf{u}, v, \mathbf{t}|z) &= \int \prod_{\gamma=1}^5 [ds^\gamma] Z_{\text{int}}^{(X, \mathcal{P})}(\{\mathbf{s}^\gamma\}, \mathbf{u}, v, \mathbf{t}) W_{\text{b.g.}}(\mathbf{t}, R) \mathcal{I}^{\Sigma_i^{2,R}}(\mathbf{s}^1, \mathbf{s}^2, \mathbf{u}, z|\xi > 0) \\ &= \int \prod_{\gamma'=1}^2 [d\sigma^{\gamma'}] Z_{\text{int}}^{(Y)}(\{\sigma^{\gamma'}\}, \mathbf{t}, -\mathbf{u}, -v) \sum_{w \in R} e^{2\pi \sum_j w_j \sigma_j^2 z}. \end{aligned} \quad (\text{C.6})$$

C.1 Non-Abelian Gauging via abelianization of the partition function

The non-Abelian gauging operation can then be Abelianized following the procedure of (3.28):

$$Z^{\mathcal{G}_{\mathcal{P}}^\alpha(X[V_{2,R}^l])} = \lim_{z \rightarrow 1} \int \prod_{i=1}^2 du_i e^{2\pi i \eta_\alpha(u_1+u_2)} (e^{2\pi u_1} e^{-2\pi u_2} + e^{-2\pi u_1} e^{2\pi u_2} - 2) Z^{(X[V_{2,R}^l], \mathcal{P})}(\mathbf{u}, v, \mathbf{t}|z) \quad (\text{C.7})$$

$$=: Z^{\bar{\mathcal{O}}_{\mathcal{P}}^{2,\alpha}(X[V_{2,R}^l])}(v, \mathbf{t}|1, -1) + Z^{\bar{\mathcal{O}}_{\mathcal{P}}^{2,\alpha}(X[V_{2,R}^l])}(v, \mathbf{t}|-1, 1) - 2Z^{\bar{\mathcal{O}}_{\mathcal{P}}^{2,\alpha}(X[V_{2,R}^l])}(v, \mathbf{t}|0, 0), \quad (\text{C.8})$$

where we have used the notation of (3.31). The function $Z^{\bar{\mathcal{O}}_{\mathcal{P}}^{2,\beta}(X[V_{2,R}^l])}(v, \mathbf{t}|q_1, q_2)$ corresponds to the partition function of a theory obtained from the quiver $X[V_{2,R}^l]$ by a sequence of two Abelian defect-gauging S -type operations of the Wilson type, and is given as

$$Z^{\bar{\mathcal{O}}_{\mathcal{P}}^{2,\alpha}(X[V_{2,R}^l])}(v, \mathbf{t}|q_1, q_2) = \lim_{z \rightarrow 1} \int \prod_{i=1}^2 du_i e^{2\pi i \eta_\alpha(u_1+u_2)} e^{2\pi q_1 u_1} e^{2\pi q_2 u_2} Z^{(X[V_{2,R}^l], \mathcal{P})}(\mathbf{u}, v, \mathbf{t}|z). \quad (\text{C.9})$$

To evaluate a partition function of the above form, we will use an analytic continuation trick of the following form:

$$Z^{\bar{\mathcal{O}}_{\mathcal{P}}^{2,\alpha}(X[V_{2,R}^l])}(v, \mathbf{t}|q_1, q_2) = \lim_{\substack{z \rightarrow 1 \\ z' \rightarrow 1}} \int \prod_{i=1}^2 du_i e^{2\pi i \eta_\alpha(u_1+u_2)} e^{2\pi q_1 u_1 z'} e^{2\pi q_2 u_2 z'} Z^{(X[V_{2,R}^l], \mathcal{P})}(\mathbf{u}, v, \mathbf{t}|z), \quad (\text{C.10})$$

where we compute the integral assuming $z' \in i\mathbb{R}$ and then take the $z' \rightarrow 1$ limit.

The partition function of the dual theory $\tilde{\mathcal{G}}_{\mathcal{P}}^\alpha(Y[\tilde{W}_R])$ can then be written as

$$Z^{\tilde{\mathcal{G}}_{\mathcal{P}}^\alpha(Y[\tilde{W}_R])} = Z^{\tilde{\mathcal{O}}_{\mathcal{P}}^{2,\alpha}(Y[\tilde{W}_R])}(v, \mathbf{t}|1, -1) + Z^{\tilde{\mathcal{O}}_{\mathcal{P}}^{2,\alpha}(Y[\tilde{W}_R])}(v, \mathbf{t}|-1, 1) - 2Z^{\tilde{\mathcal{O}}_{\mathcal{P}}^{2,\alpha}(Y[\tilde{W}_R])}(v, \mathbf{t}|0, 0), \quad (\text{C.11})$$

where the dual partition function for the Abelian S -type operation can be computed following the general prescription of (3.54)-(3.55). Explicitly, we have

$$\mathcal{Z}_{\tilde{\mathcal{O}}_{\mathcal{P}}^{2,\alpha}(X)} = e^{2\pi i \eta_\alpha (u_1 + u_2)} e^{2\pi q_1 u_1 z'} e^{2\pi q_2 u_2 z'}, \quad (\text{C.12})$$

$$\begin{aligned} \mathcal{Z}_{\tilde{\mathcal{O}}_{\mathcal{P}}^{2,\alpha}(Y)} &= \int \prod_{i=1}^2 du_i \mathcal{Z}_{\tilde{\mathcal{O}}_{\mathcal{P}}^{2,\alpha}(X)} \prod_{i=1}^2 e^{2\pi i g_i(\{\boldsymbol{\sigma}^{\gamma'}\}, \mathcal{P}) u_i} \\ &= \delta\left(-\text{Tr}\boldsymbol{\sigma}^1 + \eta_\alpha - iq_1 z'\right) \delta\left(\text{Tr}\boldsymbol{\sigma}^1 - \text{Tr}\boldsymbol{\sigma}^2 + \eta_\alpha - iq_2 z'\right), \end{aligned} \quad (\text{C.13})$$

where the functions $g_i(\{\boldsymbol{\sigma}^{\gamma'}\}, \mathcal{P})$ are given by

$$g_1(\{\boldsymbol{\sigma}^{\gamma'}\}, \mathcal{P}) = -\text{Tr}\boldsymbol{\sigma}^1, \quad g_2(\{\boldsymbol{\sigma}^{\gamma'}\}, \mathcal{P}) = \text{Tr}\boldsymbol{\sigma}^1 - \text{Tr}\boldsymbol{\sigma}^2. \quad (\text{C.14})$$

In writing the above formula for $\mathcal{Z}_{\tilde{\mathcal{O}}_{\mathcal{P}}^{2,\alpha}(Y)}$, we have ignored the \mathbf{u} -dependent contact terms, for the sake of simplifying the computation. These can be easily reinstated and will lead to contact terms and some additional background Wilson defect. However, the latter can be absorbed by an appropriate redefinition of the vortex defect.

From the general expression (3.54), one can write down the dual partition function $Z_{\tilde{\mathcal{O}}_{\mathcal{P}}^{2,\alpha}(Y[\widetilde{W}_R])}(v, \mathbf{t}; q_1, q_2)$ as follows:

$$\begin{aligned} Z_{\tilde{\mathcal{O}}_{\mathcal{P}}^{2,\alpha}(Y[\widetilde{W}_R])} &= \lim_{\substack{z \rightarrow 1 \\ z' \rightarrow 1}} \int \prod_{\gamma'=1}^2 [d\boldsymbol{\sigma}^{\gamma'}] \delta\left(-\text{Tr}\boldsymbol{\sigma}^1 + \eta_\alpha - iq_1 z'\right) \delta\left(\text{Tr}\boldsymbol{\sigma}^1 - \text{Tr}\boldsymbol{\sigma}^2 + \eta_\alpha - iq_2 z'\right) \\ &\quad \times Z_{\text{int}}^{(Y)}(\{\boldsymbol{\sigma}^{\gamma'}\}, \mathbf{t}, -\mathbf{u} = 0, -v) \sum_{w \in R} e^{2\pi \sum_j w_j \sigma_j^2 z}. \end{aligned} \quad (\text{C.15})$$

The limit $z \rightarrow 1$ can be trivially implemented at this stage. After a change of integration variables $\sigma_i^1 \rightarrow \sigma_i^1 + \eta_\alpha/2 - iq_1 z'/2$, one can rewrite the above partition function as follows:

$$\begin{aligned} Z_{\tilde{\mathcal{O}}_{\mathcal{P}}^{2,\alpha}(Y[\widetilde{W}_R])} &= \lim_{z' \rightarrow 1} \int \prod_{\gamma'=1}^2 [d\boldsymbol{\sigma}^{\gamma'}] \delta\left(\text{Tr}\boldsymbol{\sigma}^1\right) \delta\left(\text{Tr}\boldsymbol{\sigma}^1 - \text{Tr}\boldsymbol{\sigma}^2 + 2\eta_\alpha - i(q_1 + q_2)z'\right) e^{2\pi i v \text{Tr}\boldsymbol{\sigma}^2} \\ &\quad \times \prod_{\gamma'=1}^2 Z_{1\text{-loop}}^{\text{vec}}(\boldsymbol{\sigma}^{\gamma'}) Z_{1\text{-loop}}^{\text{bif}}(\boldsymbol{\sigma}^1, \boldsymbol{\sigma}^2, -\eta_\alpha/2 + iq_1 z'/2) Z_{1\text{-loop}}^{\text{fund}}(\boldsymbol{\sigma}^2, \mathbf{t}) \sum_{w \in R} e^{2\pi \sum_j w_j \sigma_j^2}. \end{aligned} \quad (\text{C.16})$$

Since $q_1 + q_2 = 0$ in the present case, z' -dependent term drops off from the delta function. In addition, performing a change of variables $\sigma_j^2 \rightarrow \sigma_j^2 + \eta_\alpha/2$, the above integral can be rewritten as (up to contact terms)

$$\begin{aligned} Z_{\tilde{\mathcal{O}}_{\mathcal{P}}^{2,\alpha}(Y[\widetilde{W}_R])} &= \lim_{z' \rightarrow 1} \int \prod_{\gamma'=1}^2 [d\boldsymbol{\sigma}^{\gamma'}] \delta\left(\text{Tr}\boldsymbol{\sigma}^1\right) \delta\left(\text{Tr}\boldsymbol{\sigma}^2\right) e^{2\pi |R|(\eta_\alpha/2)} \prod_{\gamma'=1}^2 Z_{1\text{-loop}}^{\text{vec}}(\boldsymbol{\sigma}^{\gamma'}) \\ &\quad \times Z_{1\text{-loop}}^{\text{bif}}(\boldsymbol{\sigma}^1, \boldsymbol{\sigma}^2, iq_1 z'/2) Z_{1\text{-loop}}^{\text{fund}}(\boldsymbol{\sigma}^2, \mathbf{t} - \eta_\alpha/2) \sum_{w \in R} e^{2\pi \sum_j w_j \sigma_j^2}. \end{aligned} \quad (\text{C.17})$$

Now, let us focus the σ^1 -dependent part of the integral, which can be written in the following form:

$$\begin{aligned}
I &:= \int [d\sigma^1] \delta(\text{Tr}\sigma^1) Z_{1\text{-loop}}^{\text{vec}}(\sigma^1) Z_{1\text{-loop}}^{\text{bif}}(\sigma^1, \sigma^2, iq_1 z'/2) \\
&= \int d\xi [d\sigma^1] e^{2\pi i \xi \text{Tr}\sigma^1} Z_{1\text{-loop}}^{\text{vec}}(\sigma^1) Z_{1\text{-loop}}^{\text{bif}}(\sigma^1, \sigma^2, iq_1 z'/2) \\
&= \int d\xi Z^{(U(2), N_f=4)}(\sigma^2 + iq_1 z'/2, \xi). \tag{C.18}
\end{aligned}$$

Using the result for the partition function of a $U(2)$ gauge theory with $N_f = 4$ flavors in (A.3), we get

$$\begin{aligned}
I &= \int d\xi \left[\frac{(e^{2\pi i \sigma_1^2 \xi} - e^{2\pi i \sigma_3^2 \xi})(e^{2\pi i \sigma_2^2 \xi} - e^{2\pi i \sigma_4^2 \xi})}{\sinh \pi(\sigma_1^2 - \sigma_3^2) \sinh \pi(\sigma_2^2 - \sigma_4^2)} - \frac{(e^{2\pi i \sigma_1^2 \xi} - e^{2\pi i \sigma_4^2 \xi})(e^{2\pi i \sigma_2^2 \xi} - e^{2\pi i \sigma_3^2 \xi})}{\sinh \pi(\sigma_1^2 - \sigma_4^2) \sinh \pi(\sigma_2^2 - \sigma_3^2)} \right] \\
&\quad \times \frac{e^{-2\pi q_1 z' \xi}}{\sinh \pi(\sigma_1^2 - \sigma_2^2) \sinh \pi(\sigma_3^2 - \sigma_4^2) \sinh^2 \pi \xi} \\
&= \int d\xi \left[(e^{2\pi i \xi(\sigma_1^2 + \sigma_2^2)} + e^{2\pi i \xi(\sigma_3^2 + \sigma_4^2)}) \left(\frac{1}{\sinh \pi \sigma_{13}^2 \sinh \pi \sigma_{24}^2} - \frac{1}{\sinh \pi \sigma_{14}^2 \sinh \pi \sigma_{23}^2} \right) \right. \\
&\quad \left. - \frac{e^{2\pi i \xi(\sigma_1^2 + \sigma_2^2)}}{\sinh \pi \sigma_{13}^2 \sinh \pi \sigma_{24}^2} - \frac{e^{2\pi i \xi(\sigma_2^2 + \sigma_3^2)}}{\sinh \pi \sigma_{13}^2 \sinh \pi \sigma_{24}^2} + \frac{e^{2\pi i \xi(\sigma_1^2 + \sigma_3^2)}}{\sinh \pi \sigma_{14}^2 \sinh \pi \sigma_{23}^2} + \frac{e^{2\pi i \xi(\sigma_2^2 + \sigma_4^2)}}{\sinh \pi \sigma_{14}^2 \sinh \pi \sigma_{23}^2} \right] \\
&\quad \times \frac{e^{-2\pi q_1 z' \xi}}{\sinh \pi(\sigma_{12}^2) \sinh \pi(\sigma_{34}^2) \sinh^2 \pi \xi} \\
&= \int d\xi \left[- (e^{2\pi i \xi(\sigma_1^2 + \sigma_2^2)} + e^{2\pi i \xi(\sigma_3^2 + \sigma_4^2)}) \left(\frac{\sinh \pi \sigma_{12}^2 \sinh \pi \sigma_{34}^2}{\sinh \pi \sigma_{13}^2 \sinh \pi \sigma_{24}^2 \sinh \pi \sigma_{14}^2 \sinh \pi \sigma_{23}^2} \right) \right. \\
&\quad \left. - \frac{e^{2\pi i \xi(\sigma_1^2 + \sigma_2^2)}}{\sinh \pi \sigma_{13}^2 \sinh \pi \sigma_{24}^2} - \frac{e^{2\pi i \xi(\sigma_2^2 + \sigma_3^2)}}{\sinh \pi \sigma_{13}^2 \sinh \pi \sigma_{24}^2} + \frac{e^{2\pi i \xi(\sigma_1^2 + \sigma_3^2)}}{\sinh \pi \sigma_{14}^2 \sinh \pi \sigma_{23}^2} + \frac{e^{2\pi i \xi(\sigma_2^2 + \sigma_4^2)}}{\sinh \pi \sigma_{14}^2 \sinh \pi \sigma_{23}^2} \right] \\
&\quad \times \frac{e^{-2\pi q_1 z' \xi}}{\sinh \pi(\sigma_{12}^2) \sinh \pi(\sigma_{34}^2) \sinh^2 \pi \xi}. \tag{C.19}
\end{aligned}$$

One can now take the $z' \rightarrow 1$ limit trivially, since there are no z' -dependent poles in the integral. Performing the sum over the terms in (C.11) gives a $\sinh^2 \pi \xi$ factor in the numerator which cancels against the $\sinh^2 \pi \xi$ factor in the denominator. The integration over ξ then gives a delta function and the dual partition function assumes the form:

$$\begin{aligned}
Z^{(Y'[(V'_{2,R})^\vee])} &= e^{-2\pi|R|(\eta_\alpha/2)} Z_{\tilde{G}_P^\alpha}^{\tilde{G}_P^\alpha}(Y[\tilde{W}_R]) \\
&= \int [d\sigma^2] \delta(\text{Tr}\sigma^2) Z_{1\text{-loop}}^{\text{vec}}(\sigma^2) Z_{1\text{-loop}}^{\text{fund}}(\sigma^2, \mathbf{t} - \eta_\alpha/2) \sum_{w \in R} e^{2\pi \sum_j w_j \sigma_j^2} \\
&\quad \times \left[- (\delta(\sigma_1^2 + \sigma_2^2) + \delta(\sigma_3^2 + \sigma_4^2)) \left(\frac{\sinh \pi \sigma_{12}^2 \sinh \pi \sigma_{34}^2}{\sinh \pi \sigma_{13}^2 \sinh \pi \sigma_{24}^2 \sinh \pi \sigma_{14}^2 \sinh \pi \sigma_{23}^2} \right) \right. \\
&\quad \left. - \frac{\delta(\sigma_1^2 + \sigma_4^2)}{\sinh \pi \sigma_{13}^2 \sinh \pi \sigma_{24}^2} - \frac{\delta(\sigma_2^2 + \sigma_3^2)}{\sinh \pi \sigma_{13}^2 \sinh \pi \sigma_{24}^2} + \frac{\delta(\sigma_1^2 + \sigma_3^2)}{\sinh \pi \sigma_{14}^2 \sinh \pi \sigma_{23}^2} + \frac{\delta(\sigma_2^2 + \sigma_4^2)}{\sinh \pi \sigma_{14}^2 \sinh \pi \sigma_{23}^2} \right] \\
&\quad \times \frac{1}{\sinh \pi(\sigma_{12}^2) \sinh \pi(\sigma_{34}^2)}. \tag{C.20}
\end{aligned}$$

Note that the terms inside the $\left[\right]$ brackets have different delta function coefficients. We now make a change of variables such that each term has the same delta coefficient $\delta(\sigma_1^2 + \sigma_2^2)$. For example, in the second term this is achieved by the change of variables $\sigma_3^2 \leftrightarrow \sigma_1^2$ and $\sigma_4^2 \leftrightarrow \sigma_2^2$, and so on. Note that the integrand in the first line on the RHS of (C.20), including the Wilson defect factor $\sum_{w \in R} e^{2\pi \sum_j w_j \sigma_j^2}$, is invariant under these change of variables. Factoring out the common delta function coefficient, the RHS of the matrix integral can then be simplified as follows:

$$\begin{aligned}
Z^{(Y'[(V_{2,R}^{(I)})^\vee])} &= \int \left[d\boldsymbol{\sigma}^2 \right] \delta(\text{Tr}\boldsymbol{\sigma}^2) Z_{1\text{-loop}}^{\text{vec}}(\boldsymbol{\sigma}^2) Z_{1\text{-loop}}^{\text{fund}}(\boldsymbol{\sigma}^2, \mathbf{t} - \eta_\alpha/2) \sum_{w \in R} e^{2\pi \sum_j w_j \sigma_j^2} \\
&\quad \times \left[\delta(\sigma_1^2 + \sigma_2^2) \left(\frac{1}{\sinh \pi \sigma_{13}^2 \sinh \pi \sigma_{24}^2 \sinh \pi \sigma_{14}^2 \sinh \pi \sigma_{23}^2} \right) \right] \\
&= \int \left[d\boldsymbol{\sigma}^2 \right] \delta(\sigma_1^2 + \sigma_2^2) \delta(\sigma_3^2 + \sigma_4^2) Z_{1\text{-loop}}^{\text{fund}}(\boldsymbol{\sigma}^2, \mathbf{t} - \eta_\alpha/2) \sum_{w \in R} e^{2\pi \sum_j w_j \sigma_j^2} \\
&\quad \times \left[\sinh^2 \pi \sigma_{12}^2 \sinh \pi \sigma_{13}^2 \sinh \pi \sigma_{24}^2 \sinh \pi \sigma_{14}^2 \sinh \pi \sigma_{23}^2 \sinh^2 \pi \sigma_{34}^2 \right].
\end{aligned} \tag{C.21}$$

Choosing $x = \sigma_1^2$ and $y = \sigma_3^2$, the term in the parenthesis (after implementing the delta functions) can be identified as the 1-loop contribution of an $Sp(2)$ vector multiplet, i.e.

$$\begin{aligned}
&\left[\sinh^2 \pi \sigma_{12}^2 \sinh \pi \sigma_{13}^2 \sinh \pi \sigma_{24}^2 \sinh \pi \sigma_{14}^2 \sinh \pi \sigma_{23}^2 \sinh^2 \pi \sigma_{34}^2 \right] \\
&\rightarrow \sinh^2 \pi 2x \sinh^2 \pi 2y \sinh^2 \pi (x+y) \sinh^2 \pi (x-y) =: Z_{1\text{-loop}}^{\text{vec}, Sp(2)}(\boldsymbol{\sigma}^2).
\end{aligned} \tag{C.22}$$

Therefore, the final form of the matrix integral is given as:

$$Z^{(Y'[(V_{2,R}^{(I)})^\vee])} = \int \left[d\boldsymbol{\sigma}^2 \right] \delta(\sigma_1^2 + \sigma_2^2) \delta(\sigma_3^2 + \sigma_4^2) Z_{1\text{-loop}}^{\text{vec}, Sp(2)}(\boldsymbol{\sigma}^2) Z_{1\text{-loop}}^{\text{fund}}(\boldsymbol{\sigma}^2, \mathbf{t} - \eta_\alpha/2) \sum_{w \in R} e^{2\pi \sum_j w_j \sigma_j^2}, \tag{C.23}$$

which reproduces (4.45) in the main text ¹².

The mirror map between the Wilson defect in the D_6 quiver and vortex defect in the $Sp(2)$ quiver can be similarly worked out by starting from the pair in Fig. 34 and implementing an S -type operation on $X[W_R]$. As before, the procedure involves abelianizing the S -type operation and then computing the dual partition function following (3.59)-(3.60).

C.2 Non-Abelian Gauging without using abelianization

Let us now perform the non-Abelian gauging operation without resorting to the abelianization procedure. The gauging operation on the defect partition function of $X[V_{2,R}^{(I)}]$ is given by (C.1), which manifestly gives the defect partition function of $X'[V_{2,R}^{(I)}]$.

¹²In performing the computation above, we haven't carried over the overall numerical/combinatorial factors in the intermediate steps to make the presentation less cumbersome. They have, however, been reinstated in the final answer and one can readily check that the matrix integrals have the correct Weyl factors.

The dual partition function can be constituted from the general expression (3.54), as follows:

$$Z_{\tilde{G}_P^\alpha}^{(Y[\tilde{W}_R])} = \lim_{z \rightarrow 1} \int \prod_{\gamma'=1}^2 [d\boldsymbol{\sigma}^{\gamma'}] \mathcal{Z}_{\tilde{G}_P^\alpha}(\{\boldsymbol{\sigma}^{\gamma'}\}, \eta_\alpha) Z_{\text{int}}^{(Y)}(\{\boldsymbol{\sigma}^{\gamma'}\}, \mathbf{t}, \mathbf{u} = 0, -v) \sum_{w \in R} e^{2\pi \sum_j w_j \sigma_j^2 z}, \quad (\text{C.24})$$

where the limit $z \rightarrow 1$ can be trivially implemented at this stage. The function $\mathcal{Z}_{\tilde{G}_P^\alpha}^{(Y)}$ is given as:

$$\begin{aligned} \mathcal{Z}_{\tilde{G}_P^\alpha}^{(Y)}(\{\boldsymbol{\sigma}^{\gamma'}\}, \eta_\alpha) &= \int \frac{d^2 u}{2!} \mathcal{Z}_{G_P^\alpha}(\mathbf{u}, \eta_\alpha) \prod_{i=1}^2 e^{2\pi i g_i(\{\boldsymbol{\sigma}^{\gamma'}\}, \mathcal{P}) u_i} \\ &= \int \frac{d^2 u}{2!} \mathcal{Z}_{G_P^\alpha}(\mathbf{u}, \eta_\alpha) e^{-2\pi i(u_1 - u_2) \text{Tr} \boldsymbol{\sigma}^1} e^{-2\pi i u_2 \text{Tr} \boldsymbol{\sigma}^2}, \end{aligned} \quad (\text{C.25})$$

with the functions $\mathcal{Z}_{G_P^\alpha}(\mathbf{u}, \eta_\alpha)$, g_i and $Z_{\text{int}}^{(Y)}$ being

$$\mathcal{Z}_{G_P^\alpha}(\mathbf{u}, \eta_\alpha) = e^{2\pi i \eta_\alpha (u_1 + u_2)} \sinh^2 \pi(u_1 - u_2), \quad (\text{C.26})$$

$$g_1(\{\boldsymbol{\sigma}^{\gamma'}\}, \mathcal{P}) = -\text{Tr} \boldsymbol{\sigma}^1, \quad g_2(\{\boldsymbol{\sigma}^{\gamma'}\}, \mathcal{P}) = \text{Tr} \boldsymbol{\sigma}^1 - \text{Tr} \boldsymbol{\sigma}^2, \quad (\text{C.27})$$

$$Z_{\text{int}}^{(Y)}(\{\boldsymbol{\sigma}^{\gamma'}\}, \mathbf{t}, \mathbf{u} = 0, -v) = e^{2\pi i v \text{Tr} \boldsymbol{\sigma}^2} \prod_{\gamma'=1}^2 Z_{1\text{-loop}}^{\text{vec}}(\boldsymbol{\sigma}^{\gamma'}) Z_{1\text{-loop}}^{\text{bif}}(\boldsymbol{\sigma}^1, \boldsymbol{\sigma}^2, 0) Z_{1\text{-loop}}^{\text{fund}}(\boldsymbol{\sigma}^2, \mathbf{t}). \quad (\text{C.28})$$

Given the expression in (C.24), we will first perform the integration over $\boldsymbol{\sigma}^1$. Isolating the $\boldsymbol{\sigma}^1$ -dependent part of the matrix integral, and using the result (A.3), we have

$$\begin{aligned} & \int [d\boldsymbol{\sigma}^1] Z_{1\text{-loop}}^{\text{vec}}(\boldsymbol{\sigma}^1) Z_{1\text{-loop}}^{\text{bif}}(\boldsymbol{\sigma}^1, \boldsymbol{\sigma}^2, 0) e^{-2\pi i(u_1 - u_2) \text{Tr} \boldsymbol{\sigma}^1} \\ &= \left[\frac{(e^{2\pi i \sigma_1^2 (u_2 - u_1)} - e^{2\pi i \sigma_3^2 (u_2 - u_1)}) (e^{2\pi i \sigma_2^2 (u_2 - u_1)} - e^{2\pi i \sigma_4^2 (u_2 - u_1)})}{\sinh \pi(\sigma_{13}^2) \sinh \pi(\sigma_{24}^2)} \right. \\ & \quad \left. - \frac{(e^{2\pi i \sigma_1^2 (u_2 - u_1)} - e^{2\pi i \sigma_4^2 (u_2 - u_1)}) (e^{2\pi i \sigma_2^2 (u_2 - u_1)} - e^{2\pi i \sigma_3^2 (u_2 - u_1)})}{\sinh \pi(\sigma_{14}^2) \sinh \pi(\sigma_{23}^2)} \right] \times \frac{1}{\sinh \pi(\sigma_{12}^2) \sinh \pi(\sigma_{34}^2) \sinh^2 \pi(u_2 - u_1)} \\ &= \left[- (e^{2\pi i(u_2 - u_1)(\sigma_1^2 + \sigma_2^2)} + e^{2\pi i(u_2 - u_1)(\sigma_3^2 + \sigma_4^2)}) \left(\frac{\sinh \pi \sigma_{12}^2 \sinh \pi \sigma_{34}^2}{\sinh \pi \sigma_{13}^2 \sinh \pi \sigma_{24}^2 \sinh \pi \sigma_{14}^2 \sinh \pi \sigma_{23}^2} \right) \right. \\ & \quad \left. - \frac{e^{2\pi i(u_2 - u_1)(\sigma_1^2 + \sigma_4^2)}}{\sinh \pi \sigma_{13}^2 \sinh \pi \sigma_{24}^2} - \frac{e^{2\pi i(u_2 - u_1)(\sigma_2^2 + \sigma_3^2)}}{\sinh \pi \sigma_{13}^2 \sinh \pi \sigma_{24}^2} + \frac{e^{2\pi i(u_2 - u_1)(\sigma_1^2 + \sigma_3^2)}}{\sinh \pi \sigma_{14}^2 \sinh \pi \sigma_{23}^2} + \frac{e^{2\pi i(u_2 - u_1)(\sigma_2^2 + \sigma_4^2)}}{\sinh \pi \sigma_{14}^2 \sinh \pi \sigma_{23}^2} \right] \\ & \quad \times \frac{1}{\sinh \pi(\sigma_{12}^2) \sinh \pi(\sigma_{34}^2) \sinh^2 \pi(u_2 - u_1)}, \end{aligned} \quad (\text{C.29})$$

where for the second equality, we have simply rearranged the terms within the parenthesis. The next step is to perform the integral over the variables $\{u_i\}$. First, note that the factor $1/\sinh^2 \pi(u_2 - u_1)$ in (C.29) exactly cancels the \sinh^2 term in $\mathcal{Z}_{G_P^\alpha}(\mathbf{u}, \eta_\alpha)$, and therefore u_1, u_2 only appear in the exponential terms of the integrand. It is convenient to redefine the integration variables as $u'_1 = u_1 - u_2$, $u'_2 = u_2$ (the resultant determinant of the Jacobian

matrix is unity). Performing the integration over u'_1 and u'_2 , and shifting the σ^2 variables as $\sigma_j^2 \rightarrow \sigma_j^2 + \eta_\alpha/2$ ($j = 1, \dots, 4$), one arrives at the following expression for the dual partition function:

$$\begin{aligned}
Z^{(Y'[(V'_{2,R})^\vee])} &= e^{-2\pi|R|(\eta_\alpha/2)} Z^{\tilde{G}_P^\alpha(Y[\tilde{W}_R])} \\
&= \int [d\sigma^2] \delta(\text{Tr}\sigma^2) Z_{1\text{-loop}}^{\text{vec}}(\sigma^2) Z_{1\text{-loop}}^{\text{fund}}(\sigma^2, t - \eta_\alpha/2) \sum_{w \in R} e^{2\pi \sum_j w_j \sigma_j^2} \\
&\times \left[-(\delta(\sigma_1^2 + \sigma_2^2) + \delta(\sigma_3^2 + \sigma_4^2)) \left(\frac{\sinh \pi \sigma_{12}^2 \sinh \pi \sigma_{34}^2}{\sinh \pi \sigma_{13}^2 \sinh \pi \sigma_{24}^2 \sinh \pi \sigma_{14}^2 \sinh \pi \sigma_{23}^2} \right) \right. \\
&\quad \left. - \frac{\delta(\sigma_1^2 + \sigma_4^2)}{\sinh \pi \sigma_{13}^2 \sinh \pi \sigma_{24}^2} - \frac{\delta(\sigma_2^2 + \sigma_3^2)}{\sinh \pi \sigma_{13}^2 \sinh \pi \sigma_{24}^2} + \frac{\delta(\sigma_1^2 + \sigma_3^2)}{\sinh \pi \sigma_{14}^2 \sinh \pi \sigma_{23}^2} + \frac{\delta(\sigma_2^2 + \sigma_4^2)}{\sinh \pi \sigma_{14}^2 \sinh \pi \sigma_{23}^2} \right] \\
&\times \frac{1}{\sinh \pi(\sigma_{12}^2) \sinh \pi(\sigma_{34}^2)}, \tag{C.30}
\end{aligned}$$

which is identical to (C.20). Then, after performing an identical sequence of manipulations of the matrix model integral, one arrives at the final answer (C.23), which reproduces the result (4.45) in the main text.

References

- [1] A. Dey, *Three Dimensional Mirror Symmetry beyond ADE quivers and Argyres-Douglas theories*, [arXiv:2004.0973](#).
- [2] A. Hanany and E. Witten, *Type IIB superstrings, BPS monopoles, and three-dimensional gauge dynamics*, *Nucl.Phys.* **B492** (1997) 152–190, [[hep-th/9611230](#)].
- [3] V. Pestun et al., *Localization techniques in quantum field theories*, *J. Phys.* **A50** (2017), no. 44 440301, [[arXiv:1608.0295](#)].
- [4] E. Witten, *SL(2,Z) action on three-dimensional conformal field theories with Abelian symmetry*, [hep-th/0307041](#).
- [5] K. A. Intriligator and N. Seiberg, *Mirror symmetry in three-dimensional gauge theories*, *Phys.Lett.* **B387** (1996) 513–519, [[hep-th/9607207](#)].
- [6] J. de Boer, K. Hori, H. Ooguri, Y. Oz, and Z. Yin, *Mirror symmetry in three-dimensional theories, SL(2,Z) and D-brane moduli spaces*, *Nucl. Phys.* **B493** (1997) 148–176, [[hep-th/9612131](#)].
- [7] D. Gaiotto and E. Witten, *S-Duality of Boundary Conditions In N=4 Super Yang-Mills Theory*, *Adv.Theor.Math.Phys.* **13** (2009) [[arXiv:0807.3720](#)].
- [8] A. Dey, *Line Defects in Three Dimensional Mirror Symmetry beyond Linear Quivers*, [In preparation](#).
- [9] B. Assel and J. Gomis, *Mirror Symmetry And Loop Operators*, *JHEP* **11** (2015) 055, [[arXiv:1506.0171](#)].
- [10] T. Dimofte, N. Garner, M. Geracie, and J. Hilburn, *Mirror symmetry and line operators*, *JHEP* **02** (2020) 075, [[arXiv:1908.0001](#)].
- [11] D. Gaiotto and E. Witten, *Supersymmetric Boundary Conditions in N=4 Super Yang-Mills Theory*, *J. Statist. Phys.* **135** (2009) 789–855, [[arXiv:0804.2902](#)].

- [12] J. Gomis and F. Passerini, *Wilson Loops as D3-Branes*, *JHEP* **01** (2007) 097, [[hep-th/0612022](#)].
- [13] J. Gomis and F. Passerini, *Holographic Wilson Loops*, *JHEP* **08** (2006) 074, [[hep-th/0604007](#)].
- [14] M. Dedushenko, S. S. Pufu, and R. Yacoby, *A one-dimensional theory for Higgs branch operators*, *JHEP* **03** (2018) 138, [[arXiv:1610.0074](#)].
- [15] M. Dedushenko, Y. Fan, S. S. Pufu, and R. Yacoby, *Coulomb Branch Operators and Mirror Symmetry in Three Dimensions*, *JHEP* **04** (2018) 037, [[arXiv:1712.0938](#)].
- [16] A. Kapustin, B. Willett, and I. Yaakov, *Exact Results for Wilson Loops in Superconformal Chern-Simons Theories with Matter*, *JHEP* **1003** (2010) 089, [[arXiv:0909.4559](#)].
- [17] N. Drukker, T. Okuda, and F. Passerini, *Exact results for vortex loop operators in 3d supersymmetric theories*, *JHEP* **07** (2014) 137, [[arXiv:1211.3409](#)].
- [18] A. Kapustin, B. Willett, and I. Yaakov, *Exact results for supersymmetric abelian vortex loops in 2+1 dimensions*, *JHEP* **06** (2013) 099, [[arXiv:1211.2861](#)].
- [19] A. Kapustin, B. Willett, and I. Yaakov, *Nonperturbative Tests of Three-Dimensional Dualities*, *JHEP* **1010** (2010) 013, [[arXiv:1003.5694](#)].
- [20] C. Closset, T. T. Dumitrescu, G. Festuccia, Z. Komargodski, and N. Seiberg, *Contact Terms, Unitarity, and F-Maximization in Three-Dimensional Superconformal Theories*, *JHEP* **10** (2012) 053, [[arXiv:1205.4142](#)].
- [21] K. Hori, H. Kim, and P. Yi, *Witten Index and Wall Crossing*, *JHEP* **01** (2015) 124, [[arXiv:1407.2567](#)].
- [22] A. Hanany and A. Zaffaroni, *Issues on orientifolds: On the brane construction of gauge theories with $SO(2n)$ global symmetry*, *JHEP* **9907** (1999) 009, [[hep-th/9903242](#)].
- [23] A. Hanany and A. Zaffaroni, *Branes and six-dimensional supersymmetric theories*, *Nucl.Phys.* **B529** (1998) 180–206, [[hep-th/9712145](#)].
- [24] A. Dey and P. Koroteev, *Good IR Duals of Bad Quiver Theories*, *JHEP* **05** (2018) 114, [[arXiv:1712.0606](#)].