

Quantum Hypothesis Testing with Group Structure

Zane M. Rossi* and Isaac L. Chuang

Department of Physics, Center for Ultracold Atoms, and Research Laboratory of Electronics
Massachusetts Institute of Technology (MIT), Cambridge, Massachusetts 02139, USA

(Dated: February 4, 2021)

The problem of discriminating between many quantum channels with certainty is analyzed under the assumption of prior knowledge of algebraic relations among possible channels. It is shown, by explicit construction of a novel family of quantum algorithms, that when the set of possible channels faithfully represents a finite subgroup of $SU(2)$ (e.g., $C_n, D_{2n}, A_4, S_4, A_5$) the recently-developed techniques of quantum signal processing can be modified to constitute subroutines for quantum hypothesis testing. These algorithms, for group quantum hypothesis testing (G-QHT), intuitively encode discrete properties of the channel set in $SU(2)$ and improve query complexity at least quadratically in n , the size of the channel set and group, compared to naïve repetition of binary hypothesis testing. Intriguingly, performance is completely defined by explicit group homomorphisms; these in turn inform simple constraints on polynomials embedded in unitary matrices. These constructions demonstrate a flexible technique for mapping questions in quantum inference to the well-understood subfields of functional approximation and discrete algebra. Extensions to larger groups and noisy settings are discussed, as well as paths by which improved protocols for quantum hypothesis testing against structured channel sets have application in the transmission of reference frames, proofs of security in quantum cryptography, and algorithms for property testing.

I. INTRODUCTION

Hypothesis testing is a fundamental statistical method with wide application in classical and quantum contexts. Seminal work [1] has led to a deep information-theoretic understanding of binary hypothesis testing for *quantum states*, but only quite recently have analogous lower bounds been proven for error in discrimination among *quantum channels* [2]. This forty-year gap between mature theories for quantum hypothesis testing (QHT), realized as quantum state and channel discrimination respectively, follows from the far richer structure of the latter problem. I.e., general quantum channel discrimination protocols may be adaptive, entanglement-assisted, and use auxiliary qubits; moreover, the concomitant optimizations over (possibly adaptive) preparations and measurements are computationally expensive.

It is known that sharpening the problem of quantum channel discrimination to narrower settings can drastically alter algorithmic efficiency, the requirement of entanglement, the requirement of auxiliary qubits, and the ease of both theoretical and computational analysis [3–5]. This work considers one such narrower statement of QHT for discriminating quantum channels.

A. Problem statement

We state our problem as a game. Consider a party with access to a small (single-qubit) quantum computer; she is able to apply unitary operations of her choice to this qubit, measure this qubit in chosen bases, and store

the resulting classical data for as long as she likes, possibly using this information to instruct future actions. She is furthermore permitted query access to an oracle whose result is the application of a single-qubit unitary quantum channel \mathcal{E}_i . This channel is from a publicly known set S (hereafter the *query set*) of n distinct unitary channels. Queries consistently apply \mathcal{E}_i , and i is unknown.

Problem I.1. *An S-QHT Problem is any instance wherein a party given access to \mathcal{E}_i for unknown $i \in [n]$ is tasked with the following: in as few queries as possible determine, with certainty, the hidden index i . The minimal expected query complexity the party is able to achieve is denoted q_s and is taken over an assumption of equal priors on $\{\mathcal{E}_\ell\}_{\ell \in [n]} = S$, a set of distinct single-qubit unitary quantum channels.*

The prefix S in Problem I.1 denotes QHT with respect to a *set* of quantum channels. This work examines only specific subsets of S-QHT games. Moreover, this work considers a specific resource model, described informally at the beginning of this section and depicted in Figure 1.

As described in Subsection IB, naïve upper and lower bounds on q_s , even for general S , can be computed without difficulty, although the gap between these bounds is in general large, i.e., exponential in the instance size $|S|$ [5]. A primary interest is thus to derive a set of properties on the set S for which a lower bound for q_s *dependent on the structure of S* can be both (1) proven and (2) asymptotically achieved by a quantum algorithm *exploiting the structure of S* to generate a strategy for playing an instance of S-QHT (Problem I.1).

This work provides one such sufficient condition on S . These constraints not only enable proof of query complexity lower bounds and constructions of algorithms achieving these bounds, but permit the cross-application of diverse methods in abstract algebra and functional approximation theory to quantum information and infer-

* zmr@mit.edu

ence. This work considers the specific constraint that S additionally faithfully represents a finite subgroup $G < \text{SU}(2)$ (i.e., it is a representation of a finite subgroup of the group of single-qubit unitary transformations).

Definition I.1. *A channel set S is said to faithfully represent a finite group G if the elements of S have the form $\{U_g\}_{g \in G}$ such that, respecting some natural product operation for elements in S , $U_g U_h = U_{gh}$ for $g, h \in G$, and moreover that the group homomorphism $g \mapsto U_g$ is injective, ensuring $|S| = |G|$.*

A variant of S-QHT incorporating the condition discussed above is denoted by G-QHT (Problem I.2). While this work considers groups $G < \text{SU}(2)$, this game naturally extends to finite representations embedded in any Hilbert space.

Problem I.2. *An instance of Problem I.1 with the additional constraint that S faithfully represents a finite group G is an instance of a G-QHT problem or G-QHT game.*

Before discussing this new game further, it is worthwhile to understand previous results in unitary quantum channel discrimination, to which these games have non-trivial relation. These results support why one should expect that the family of sets S which obeys the properties of Lemma I.1 is rich enough to furnish non-trivial instances of QHT, and why even in a limited resource model algorithms to solve G-QHT efficiently exist.

B. Prior work

The problem of *binary* quantum channel discrimination is well-understood under the assumption that the set of possible channels, i.e., the *query set*, denoted S , comprises only unitary channels. Foundational work by Acín [3] asserts that there is always some finite upper bound¹ on q_s for achieving *perfect discrimination* for any finite S with distinct, known, unitary elements. Moreover it is known that *in the binary case*, under the assumption that the discriminating party may apply unitary operations of their choice, neither entanglement nor auxiliary systems nor adaptive protocols are required to achieve optimal query complexity [4, 5].

For *binary discrimination* among pairs of *general quantum channels*, necessary and sufficient conditions are known for the achievability of perfect quantum channel discrimination in terms of the channel's respective Choi matrices [2]. Moreover, various *general lower bounds* are known for the symmetric error of discrimination (given a fixed number of channel uses) for binary and multiple

quantum channel discrimination, as well as some conditions on the set S , e.g., teleportation-covariance (telecovariance) and geometric uniform symmetry (GUS) under which these bounds can be improved upon and, in the former, more restrictive setting of telecovariance, asymptotically achieved [2, 6]. Such simplifying conditions have also been studied in the multiple unitary channel case for group covariant query sets for *non-adaptive* quantum strategies [7].

While it is known that entanglement (and in fact any resource in a convex resource theory like quantum mechanics [8, 9]) can be useful in quantum hypothesis testing among non-unitary channels, the performance of entanglement-free or low-entanglement strategies for multiple quantum channel discrimination remains largely unstudied, even in its simplest, unitary form. Namely, while intriguing examples for methods of discrimination among large sets of unitary operators where the use of entanglement improves query complexity have been given [5], the necessity of entanglement is not known. Moreover, the power afforded to quantum hypothesis testing strategies for quantum channels using entanglement *and which are also adaptive* has been shown to be non-trivial in the case of non-unitary channels, where even adaptiveness alone may assist algorithmic performance [10, 11].

Many of the techniques referenced above are agnostic to the structure of S ; however, the notion that the structure of the query set should inform the structure of optimal procedures to differentiate members of S is an old and clever idea, and indeed can provide optimal hypothesis testing protocols for query sets comprising *quantum states* which are group covariant [12]. It is as a generalization of this setting to quantum channels that Problem I.2 (G-QHT) finds its form. Moreover, the study of discrete and especially non-abelian algebraic objects in the context of quantum information is not new, and underlies many open problems, e.g., the dihedral hidden subgroup problem [13] and its reductions to various lattice problems [14], as well as the symmetric hidden subgroup problem and its reductions to graph isomorphism [15].

Multiple hypothesis testing for quantum channels is not merely of independent quantum-information-theoretic interest either, but has found use in designing protocols for the optimal transmission of reference frames [16] (i.e., when the query set is a compact group and the aim is estimation of a fixed unitary transformation). Discretized versions of this problem also naturally connect to the study of group frames and SIC-POVMs [17, 18], e.g., as discussed in Lemma VI.1.

While left as an open extension to this work, application of methods for quantum hypothesis testing against quantum channels where the n -th channel application depends non-trivially on the previous $n - 1$ applications, i.e., *memory channels* [19] also have application to proofs of the general impossibility of quantum bit-commitment [20], and are of interest in quantum cryptography.

In what follows we more concretely define our algorithmic resource model, provide an example of why it might

¹ This furnishes a loose upper bound for multiple unitary channel discrimination as well; one performs perfect discrimination on pairs of elements in S , eliminating channels one by one; this is the *standard reduction* to binary QHT.

be expected that the question of achievability within the exponential gap between the naïve upper and lower bounds on query complexity for multiple quantum hypothesis testing is richly structured, and finally give an outline for the methods of proof employed in analyzing this structure.

C. Our approach

The statement of G-QHT (Problem I.2) together with the serial adaptive query model depicted in Figure 1 raises the question of whether this model is (1) interesting, (2) non-trivial, and (3) tractable to analyze; this section addresses these questions.

The player challenged in G-QHT to determine the hidden index i of the queried channel \mathcal{E}_i is afforded precious few quantum resources. Stating it another way, the player is forced to devise quantum strategies in the *serial adaptive query model*. In this model, pictured in Figure 1, the player may only intersperse their oracle queries with measurements and unitary operations depending on previous measurements. Serially, the querent learns progressively more about the hidden index i , adaptively modifying her approach. Under the assumption of a small quantum computer and a reasonable classical one, this is the most general approach she may take, assuming all measurements are projective and she wishes to determine i with certainty. Furthermore, in this model, query complexity is a reasonable metric by which to judge algorithmic performance.

In addition to the serial adaptive query model, we can quickly chart algorithmic schemes for instances of G-QHT where the querent is afforded a larger quantum computer. In this case, the possibility for multiple-qubit² unitaries and collective measurements gives rise to a variety of series, parallel, and mixed strategies, which may be adaptive or non-adaptive. The relative discriminating power of these models for specific instances of QHT and specific query sets is not wholly understood. An informal depiction of some of these models is give in Figure 2.

As the querent in the course of playing the G-QHT game is allowed to store reasonable amounts of classical information, all that is asked of a successful quantum algorithm for G-QHT in the serial adaptive query model is that it is able to decide the hidden index i according to some efficiently computable function on any of its *probable* binary qubit measurement outputs. This statement is made concrete in Definition I.2.

Definition I.2. *A quantum algorithm in the serial adaptive query model is said to decide on a query set S of distinct unitary quantum channels of size n in q_s queries if there exists, for all $i \in [n]$ a computable deterministic*

function $f : \{0, 1\}^m \rightarrow [n]$ that returns the hidden index i with certainty, on all probable (i.e., non-zero probability outcomes of) m projective single-qubit measurements $\{\Lambda_\ell\}_{\ell \in [m]}$ resulting from the action of \mathcal{E}_i in a serial adaptive protocol defined by the quantum algorithm that uses q_s oracle queries. This definition can be suitably modified replacing S with G , a faithful representation of the group G in a specified Hilbert space.

While we will soon be interested in the efficiency of a single-qubit serial adaptive query model algorithm in deciding a set S which faithfully represents a finite subgroup $G < \text{SU}(2)$, and indeed whether, for these special sets, query-complexity-optimal, entanglement-free, serial adaptive protocols similar to those constructed in [4] are possible to construct, it is worthwhile to look at a simple, concrete instance of our game, and the function f it induces according to Definition I.2.

We introduce a minimal instance of G-QHT which, in addition to demonstrating why the naïve upper bounds on query complexity discussed in Subsection IB are in general not tight, also captures some of the intuitive motivations for the major results of this work for more complicated query sets. The following example has the added benefit of (1) requiring no explicit mention of QSP (Section II) in its construction and proof of optimality, and (2) providing some intuition for why QSP is natural to call on to solve the shortcomings that emerge in applying the strategy of Lemma I.1 to more general query sets.

Lemma I.1. *For natural numbers n there exists a quantum algorithm in the serial adaptive query model that perfectly decides any channel set S that faithfully represents a cyclic subgroup $C_{2^n} < \text{SU}(2)$, and which requires $2^n - 1$ oracle queries.*

Proof. For C_{2^n} , group elements are identifiable with binary strings of length n of which there are 2^n , namely labeling according to the angle of rotation in the Bloch sphere in units of $2^{1-n}\pi$ such that the queried channel rotates about a known fixed axis by this angle. Concretely, up to overall unitary transformation the query set is

$$S = \{R_x(m \cdot \pi/2^{n-1})\}, m \in [2^n]. \quad (1)$$

Any decision protocol using one qubit for readout can provide at most one bit of information as to the n -bit label for the queried group element.³ We read from least (LSB) to most (MSB) significant bit by the following algorithm:

1. Prepare $|0\rangle$. Query the channel 2^{n-1} times and measure in the standard basis, reading the LSB.

² One could of course also imagine access to qudits, or indeed stranger Hilbert spaces.

³ Note that these don't need to bits in the label of the queried channel, but rather some set of bits which, at the conclusion of the algorithm, can be taken by the function f to the hidden index i deterministically.

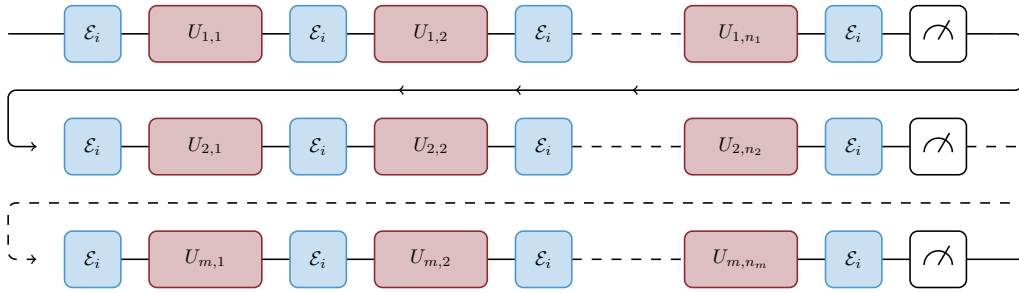

FIG. 1. A general circuit to perform QHT in the *serial adaptive query model*. The unitary operators $U_{i,j}$ for $i \in [n_j]$, $j \in [m]$ may depend on previous single-qubit projective measurements Λ_k for $k < j$, for $j \in [m]$, communicated by stored classical bit strings of reasonable finite length (represented by arrows). Each row in the figure is a quantum circuit applied to a qubit prepared from classical information depending only on the results of previous measurements. The serial nature of the discrimination protocol to determine the unknown channel is evident; when the protocol terminates a known classical function is computed on the set of measurement results (here, a bit-string of length m), equivalently Λ_k for $k \in [m]$, to infer the hidden channel. Other models one can consider are discussed in Figure 2.

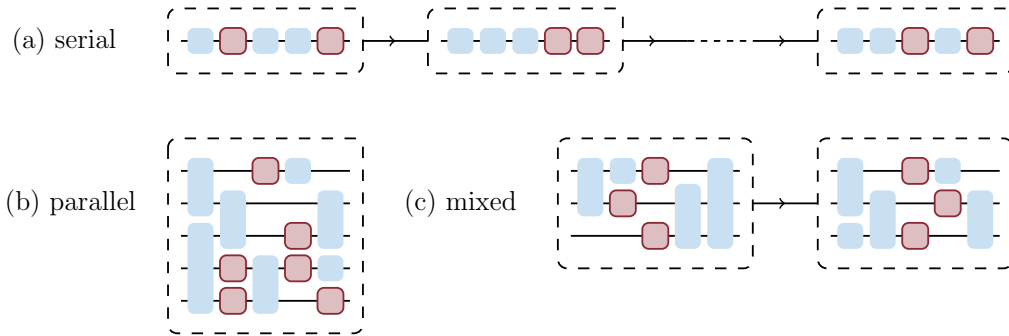

FIG. 2. Simplified illustrations of different models for quantum circuits performing QHT. Depicted are (a) serial adaptive, (b) parallel, and (c) mixed strategies. Given query access to a finite number of applications of the unknown quantum channel (red, outlined), in the figure 6 applications, the querent is conferred the ability to perform unitary operations (blue, non-outlined) of her choice. Blue operations shown are arbitrarily structured and for demonstrative purposes only. For serial adaptive strategies, (a), dashed boxes indicate regions between which only classical information is transmitted (i.e., measurement results). In (b) and (c) entanglement, auxiliary qubits, and collective measurements can, in general, improve the performance of QHT algorithms. Preparations and measurements are not explicitly shown.

- Dependent on the measurement in the previous step the possible query set S' has description

$$\begin{cases} \{R_x(m \cdot \pi/2^{n-2} + \pi/2^{n-1})\} & \text{if measured } |1\rangle \\ \{R_x(m \cdot \pi/2^{n-2})\} & \text{if measured } |0\rangle, \end{cases}$$

for $m \in [2^{n-1}]$. The latter is a representation of the cyclic group of order 2^{n-1} . The former, if each query is preceded by a unitary $U = R_x(-\pi/2^n)$, is also a representation of this cyclic group.

Set $U = R_x(-b \cdot \pi/2^{n-1})$, where $|b\rangle$ was measured in the previous step.

- Apply U before each of 2^{n-2} channel applications to bit-shift the label of the queried group element. Repeat algorithm for a cyclic group of size 2^{n-1} .

For the cyclic group of order 2, consisting of the identity channel and a π -rotation, the decision protocol is obvious. By recursion, the total decision protocol has query

complexity $2^{n-1} + 2^{n-2} + \dots + 1 = 2^n - 1$. Optimality follows from the optimality of phase estimation. ■

The methods used in the proof of Lemma I.1 illustrate an important concept: if the query set S is highly structured, binary measurement results can effectively correspond to halving the size of the remaining search space (or equivalently excluding, with one measurement, half of the possible channels). Here, compared to the upper bound given by the standard reduction to binary QHT, we see a square root improvement in the instance size $|C_{2^n}|$. Additionally, the function f from the statement of Definition I.2 simply reads the adaptive output measurements as a binary string and returns the corresponding integer (the channel's hidden index).

The reason that the simple method of Lemma I.1 works is because even powers of channel elements are not only subsets but subgroups of C_{2^n} , and specifically 2^{n-1} powers of group elements are rotations by angles in $\{0, \pi\}$,

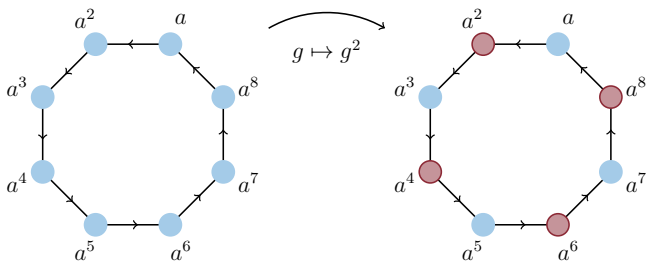

FIG. 3. Subroutine of decision protocol on C_8 . For the cyclic group of order 2^n , any map $g \mapsto g^{2^m}$ for $m < n$ generates a cyclic subgroup of order 2^{n-m} . Consequently, as the cyclic group of order 2 has an obvious discrimination strategy, the method in Lemma I.1 can recursively determine membership of the hidden element in cosets of cyclic subgroups of C_{2^n} . Equivalently, the querent performs binary search, i.e., using 2^{n-1} queries, she can determine membership of the hidden element in the red (image) or blue (complement of the image) subset as pictured for the case $n = 3$, assuming she can solve the $n = 2$ case.

which give perfectly orthogonal and thus perfectly distinguishable states when acting on special known initial pure states. The adaptive protocol permits the querent to recurse and learn the hidden index by asking individual questions of coset membership for prime-power order normal subgroups.

For cyclic groups of general order, however, this method fails. For odd-order cyclic groups, for instance, sets of integral powers of group elements do not necessarily form non-trivial subgroups by simple consequences of Lagrange's theorem. The question of bisecting the search space must thus be resolved by other methods; it is precisely the flexibility of QSP that will permit the recovery of algorithms of the same flavor as Lemma I.1 for more general groups. That is, to permit the construction of quantum algorithms that act deterministically on not merely subgroups but arbitrarily chosen subsets of the query set.

D. Paper outline and summary of results

The main body of this work describes methods for perfectly deciding sets of quantum channels (equivalently *query sets*) which faithfully represent finite subgroups $G < \text{SU}(2)$ in order of increasing complexity of the finite group considered. This culminates in Theorem I.1.

Theorem I.1. *[Simplified] There exist quantum algorithms in the serial adaptive query model which perfectly decide on all finite subgroups G of $\text{SU}(2)$, with the exception of the simple non-abelian group A_5 , and which do so with asymptotically optimal query complexity. These algorithms each closely track with a single generic algorithm (Algorithm 1), and their individual structure closely tracks the structure of the considered group.*

This work is organized such that algorithms for deciding simpler finite groups can, where applicable, be used as subroutines for algorithms deciding more complicated groups whose subgroup decomposition is non-trivial. It is this *bootstrapped approach* that provides novel sufficient conditions under which the open question in Subsection IB can be resolved in the serial adaptive query model.

We begin with an overview of the two mathematical techniques that underlie the main results of the paper. Namely, in Section II we review statements of the main theorems of quantum signal processing, their guarantees, and interpretations. Relatedly, we give a protocol (Algorithm 1) that players of a simplified version of the G-QHT game (Problem I.2) defined in Subsection IA may use to achieve perfect decision protocols. The theorems of QSP (and consequently solutions to the simplified game proposed in Problem II.1) rely on the existence and efficient computability of polynomials over real variables under simple constraints, the properties of which are discussed in Section III.

With both of the mathematical techniques established in Sections II and III, the paper proceeds to discuss concrete groups systematically. The statement of Problem I.2 as mentioned is simplified to Problem II.1, whose solution using the methods of QSP depends solely on the answer to questions in functional approximation. For each concrete algorithm corresponding to deciding each finite subgroup $G < \text{SU}(2)$ in Section IV, we perform reductions to decisions on normal subgroups of G where possible, and restate decision algorithms on G as multiple correlated instances of Algorithm 1. Specifically, we assert that Algorithm 1 and its performance guarantees are integral to the analysis of each algorithm given in Section IV.

Algorithm 1 connects decisions on G to problems in functional approximation which, referring back to the guarantees of Section III, determine the query complexity of the algorithm deciding on G . This connection is made explicit in Problems III.1 and IV.1.

We provide a diagram of the order in which we address decisions on specific finite subgroups (Figure 4) as well as relations between all problems introduced in this work (Figure 5). In turn, the relations between algorithms and problems are summarized in the statement of Algorithm 1 in conjunction with its accompanying remarks (Remarks II.1, II.2), toward a coherent framework for hypothesis testing on discrete query sets.

For generalizations to larger Hilbert spaces, near-unitary channels, and groups not embeddable in $\text{SU}(2)$, the reader is directed to Section V. Additionally, Section VI gives a list of open problems in the same vein as the results presented in this work, suggestions for the shape of their resolution, and instances (e.g., Remark VI.1) in which the methods derived here can be directly applied to physical problems.

iff $P, Q \in \mathbb{C}[x]$ satisfy the following properties:

1. $\deg(P) = k$ and $\deg(Q) = k - 1$.
2. P has the same parity as k modulo 2, while Q has the opposite parity.
3. For all $x \in [-1, 1]$, P and Q satisfy $P(x)P^*(x) + (1 - x^2)Q(x)Q^*(x) = 1$.

Theorem II.1 asserts that QSP protocols, which involve interleaving rotations about orthogonal axes (one of these rotations by a fixed, unknown angle, and the other by an unfixed, known angle) result in unitary operators whose elements are polynomials of the unknown rotation angle. These polynomials are under constraints necessary and sufficient to ensure the resulting operator is unitary. While the constraints of Theorem II.1 are non-intuitive for one wishing to solve the reverse problem (i.e., go from polynomial to a unitary operator in which the polynomial is embedded), the following theorem addresses precisely this concern.

Theorem II.2. In [24]. Let k in \mathbb{Z}^+ and let $P', Q' \in \mathbb{R}[x]$; there exists some $P, Q \in \mathbb{C}[x]$ satisfying the requirements of Theorem II.1 such that $P' = \Re(P)$, $Q' = \Re(Q)$ iff P', Q' satisfy the first two requirements of Theorem II.1 and additionally $P'(x)^2 + (1 - x^2)Q'(x)^2 \leq 1$.

The proof of this statement follows constructively from a provably efficient (e.g., polynomial in k) algorithm to build the missing complex parts of P, Q .

In Theorem II.2 the operator $W(x)$, the signal being processed, will be analogous to the quantum channel \mathcal{E}_i we wish to discriminate in G-QHT. That said, the utility of these theorems is not immediately clear: the form of $W(x)$ (rotation about a known, fixed axis) is far simpler than the members of the query set considered in G-QHT for arbitrary finite subgroups of $SU(2)$.

In the interest of making progress, we can thus modify the statement of Problem I.2 such that QSP stands a fair chance of providing a solution. Specifically we can write out the generic form of a QSP-based algorithm that perfectly decides any finite set $S = \{R_x(\theta_\ell)\}_{\ell \in [n]} \in [-\pi, \pi]^n$ under the map $R_x(\theta_\ell) = \exp\{-i\theta_\ell/2\sigma_x\}$. Note that here S need not be a group under composition. This modified version of the G-QHT game is discussed in Problem II.1.

Problem II.1. The rotation QHT problem (R-QHT problem) is a simplified version of the G-QHT problem (Problem I.2) with the following structure. Given query access to a single-qubit quantum channel from among a finite set S where each channel has again the form $R_\xi(\theta_i) = \exp\{-i(\theta_i/2)(\cos \xi \sigma_x + \sin \xi \sigma_y)\}$ for distinct, known θ_i and known rotation axis ξ , determine the queried channel with certainty in the serial adaptive query model.

Note that R-QHT problems are not a subset of G-QHT problems, save in the case that the set of angles $\{\theta_\ell\}$ are all distinct integral multiples of $2\pi/n$ for positive integral n (i.e., S represents a cyclic group).

As the rotation operators discussed in the R-QHT problem satisfy the form expected of the $W(x)$ operator in QSP, the methods of QSP suggest a neat prescription for a quantum algorithm (Algorithm 1) with classical subroutines such that the output is a solution for the R-QHT problem. We discuss assumptions on the input, output, and structure of Algorithm 1 in Remark II.1, give definitions for its classical subroutines in Definition II.2, and further remark on where the non-trivial aspects of Algorithm 1 lie in Remark II.2.

Remark II.1. We present a series of data structures which together define both an instance of the R-QHT problem (Problem II.1) and its solution, toward a concrete algorithm (Algorithm 1).

- **Input:** Any instance of R-QHT presupposes access to classical information in the form of a list of distinct angles $\{\theta_\ell \in [0, 2\pi]\}$, $\ell \in [n]$. R-QHT also presupposes access to a quantum oracle which, when called, applies a quantum channel channel $R_\xi(\theta_i)$ for fixed i about some known fixed axis ξ .
- **Output:** In the serial adaptive query model on qubits, a projective measurement is an evaluation of a probabilistic binary function on possible hidden indices $j \in [n]$ for the applied channel. An R-QHT algorithm's output is one of these indices, where success is dictated by high probability⁴ of or certainty in returning the proper hidden index i .
- **Assumptions:** The result of the evaluation of a set of these functions (corresponding to m binary measurements), $f_j : [n] \mapsto \{0, 1\}$, $j \in [m]$ on the hidden index i of the queried channel, is a composite function $g : i \mapsto \{0, 1\}^m$ defined as $g(i) = f_1(i)f_2(i) \cdots f_m(i)$.

If this function is injective for all $j \in [n]$ then the algorithm generating the f_j solves R-QHT.⁵ Equivalently the algorithm computes a series of m equivalence relations on the set of rotation angles $\{\theta_\ell\}$, $\ell \in [n]$ such that every element is uniquely defined by its membership under these m bisections.

Definition II.2. A quantum algorithm solving the R-QHT problem (Problem II.1) is referred to simply as an R-QHT algorithm, where solves indicates that it satisfies the input, output, and structural assumptions presented in Remark II.1.

In addition, toward an explicit description of one such R-QHT algorithm (Algorithm 1), we define four classical sub-algorithms whose application together constitutes the classical subroutine of Algorithm 1).

⁴ In the noiseless case, we consider only deterministic algorithms.

⁵ This is a non-trivial condition to satisfy, but in most instances can be thought of as assigning a binary tree's labels to each of m channels. This is the subject of Remark II.2.

- **genBisection**: Given a group representation G and a (possibly empty) set of evaluations of previous binary functions $f_j : S_j \rightarrow \{0,1\}$ for $S_j \subseteq S_{j-1} \subseteq \dots \subseteq S_1 \subseteq G$, returns a description of $f_{j+1} : S_{j+1} \rightarrow \{0,1\}$ where $S_{j+1} \subseteq S_j$ is a subset of S_j on which f_j is constant.

The choice of f_{j+1} is not arbitrary but instead depends heavily on the embedding of G in a larger continuous group. Examples for methods of choosing these f_j can be found in the concrete algorithms of Section IV. Further discussion of the properties of these functions is also covered in Remark II.2.

Note that in Algorithm 1, the description of f_{j+1} can be used to compute $f_{j+1}(i)$ on the hidden index, oblivious to the hidden index.

- **genRealPoly**: Given a description of f_j , defined on some subset of group elements $S_j \in G$, where each $s \in S_j$ is parameterized by some distinct real parameter $\theta_\ell \in [0, 2\pi]$ for $\ell \in |S_j|$, returns the minimal degree real polynomial p_j satisfying $|p_j(\arccos \theta_\ell)| = f_j(s[\theta_\ell])$ for all θ_ℓ , and where $|p_j(\theta)| \leq 1$ for $\theta \in [0, 2\pi]$. In addition p_j is of definite parity on $[-1, 1]$.

Methods for computing constrained interpolating polynomials are numerous and well-studied, comprising the discussion of Section III.

- **genComplexPoly**: Given a real polynomial p_j satisfying the constraints of the output of **genRealPoly**, returns a pair of complex polynomials (P_j, Q_j) on $[-1, 1]$, each of definite parity and satisfying $P_j(x)^2 + (1-x^2)Q_j(x)^2 = 1$ for $x \in [-1, 1]$. Moreover $\Re(P_j) = P'_j = p_j$ and $\Re(Q_j) = 0$. One implementation is given in [24].
- **genPhases**: Given two polynomials (P_j, Q_j) satisfying the constraints on the output of **genComplexPoly**, returns a set of phase angles $\Phi_j \in \mathbb{R}^{k+1}$ satisfying Theorem II.1.

This subroutine also returns a classical description of two quantum states, ψ_j, ψ'_j , the former an initial state and the latter a state with respect to which a projective measurement is performed to compute f_j on the hidden index, i.e., $f_j(i)$. These states are efficiently computable and project out p_j , equivalently $\langle \psi'_j | U_{\Phi_j} | \psi_j \rangle = p_j$, where U_{Φ_j} is the QSP unitary generated by Φ_j .

Methods for computing these phase factors are numerous [24, 26, 28]; all affirm that this computation is efficient and stable, using existing techniques in classical optimization.

- We denote by $M_{\psi_j}(|\psi\rangle)$ the measurement projecting $|\psi\rangle$ onto $\{M_0, M_1\} = \{|\psi_j\rangle\langle\psi_j|, I - |\psi_j\rangle\langle\psi_j|\}$, returning b upon measurement of M_b .

Algorithm 1: A generic algorithm for solving R-QHT

Assumptions : Input and output satisfying assumptions of Remark II.1

Input : A quantum channel oracle \mathcal{E}_i for hidden index i ; description of n channels $\{\mathcal{E}_\ell\}_{\ell \in [n]}$.

Output : The hidden channel index i .

for $j \leftarrow 1$ to m do

Classical subroutine (see Def. II.2):

$f_j \leftarrow \text{genBisection}(G, \{f_{<j}(i)\})$

$p_j \leftarrow \text{genRealPoly}(f_j)$

$(P_j, Q_j) \leftarrow \text{genComplexPoly}(p_j)$

$(\Phi_j, \psi_j, \psi'_j) \leftarrow \text{genPhases}(P_j, Q_j)$

Quantum subroutine:

$|\psi\rangle \leftarrow |\psi_j\rangle$ Initialize quantum state

 for $k \leftarrow 1$ to n_j do

$|\psi\rangle \leftarrow R_{\xi}(\theta_i) |\psi\rangle$ Apply oracle for unknown i

$|\psi\rangle \leftarrow U_k |\psi\rangle$ Apply QSP unitary $\exp\{i\phi_k \sigma_{\xi^\perp}\}$

 end

$f_j(i) \leftarrow M_{\psi'_j}(|\psi\rangle)$ Send $\{|\psi'_j\rangle, |\psi_j^\perp\rangle\} \mapsto \{0, 1\}$

 end

$i \leftarrow g(i) = f_1(i)f_2(i) \dots f_m(i)$ Invert g by Remark II.1

Return i

Remark II.2. The difficulty in Algorithm 1 stems from selection of the proper functions $f_j : S_j \rightarrow \{0,1\}$ for subsets $S_j \subseteq S$ of the query set of fixed-axis rotations (equivalently computing **genBisection** in Definition II.2).

As each f_j takes values on S_j in $\{0,1\}$, they can be thought of as labels dividing or bisecting the query set; the result of QSP is to make the quantum computation of these f_j on the hidden index i deterministic. A series of these f_j thus form the levels of a binary tree whose bisection condition is the result of a projective measurement onto $\{|\psi'_j\rangle, |\psi_j^\perp\rangle\}$. We discuss the desired properties of this binary decision tree; these principles foreshadow the properties discussed in Theorem IV.1.

- An efficiently searchable binary tree should be balanced; different channels should have binary labels according to the tree which differ as early as possible, equivalently each f_j should divide the remaining query set roughly in half.
- The discrete f_j objects are accessed by interpolating polynomials in a continuous embedding space, and as the minimal degree of such polynomials correspond to algorithmic performance, we desire that the f_j subdivide the search space into subsets which

have a larger average⁶ distance between elements in the natural metric of this space. Equivalently proximate elements in the binary tree are also proximate in the embedding space.

- Each leaf of the binary decision tree must correspond to no more than one channel. If each (probable with respect to measurement) leaf corresponds exactly to one channel, then g in II.1 is not only injective but bijective.
- The f_j must have definite parity in the continuous embedding space, here $SU(2)$; this parity constraint, requisite for the use of QSP, follows from properties of $SU(2)$.

Algorithm 1 and its supporting remarks show that, at least for a special set of channels, our hopes of computing successive equivalence relations on subsets of S to iteratively determine the hidden query element rest on the construction of low-degree constrained polynomials over real variables.

Moreover, as stated in Remark II.2, most of the difficulty of this algorithm resides in designing the binary functions f_j . The sequence of equivalence relations f_1, f_2, \dots, f_m , which together uniquely define the hidden index i , need to be properly chosen such that (1) the degrees of their polynomial interpolations are not too large, and (2) that the concatenation of their evaluations is invertible on every i ; luckily these conditions are not so complicated to achieve in practice.

E.g., we can see one such set of f_j in observing the ‘QSP-free’ decision algorithm for C_{2^n} in Lemma I.1, namely $f_j(i) = i \pmod{2^j}$ for $j \in [n]$. Evidently in this simplest case the family of f_j define precisely a binary search on the hidden channel index (and consequently the equator of the Bloch sphere under the map $i \mapsto \mathcal{E}_i$). What remains to be shown is the generalization of such a search.

It turns out that Algorithm 1 can indeed be extended to more interesting channel sets than single-axis rotations (i.e., that we can lift R-QHT problems to G-QHT problems). However, before investigating the flexibility of Algorithm 1 as a subroutine, we first briefly address methods in constrained polynomial interpolation. This analysis, in addition to closing the loop on the R-QHT problem and its query complexity, will demonstrate the methods by which the optimal query complexity of R-QHT is computed, and provide a foundation for generalizing to G-QHT.

III. CONSTRAINED POLYNOMIAL INTERPOLATION

In the previous section we reduced the solution of Problem II.1, a simplified version of G-QHT, to the existence of interpolating polynomials over real intervals. Moreover we asserted that, despite the restrictive form of the queried channel $W(x)$ considered in QSP, the guarantees of Theorem II.1 were still strong enough to enable discrimination among channel sets whose structure is richer than rotations about a fixed axis. This section considers one concrete interest of a party playing R-QHT: how can a computationally limited classical party compute Φ for a QSP algorithm such that the resulting matrix polynomials induce measurements obeying the prescriptions of Algorithm 1.

This is a problem of constrained polynomial interpolation. More generally, the field of functional approximation, in which this problem lives, is well-understood [29–34] given its practical instantiations in classical signal processing and relevance to foundational questions in real analysis. We quote the following results in constrained polynomial approximation and present their synthesis as a new theorem guaranteeing desired properties for the algorithms that will be constructed in Section IV for specific finite groups. Additionally, these results provide quantitative bounds on the query complexity of solutions to the R-QHT problem discussed previously.

We present a further sharpening of R-QHT (Problem II.1); this new problem, P-QHT, is similar to R-QHT but provides a new quantitative condition on the performance of an algorithm solving R-QHT.

Problem III.1. *The polynomial QHT problem, or P-QHT problem, answers the following question. Given an instance of the R-QHT problem (Problem II.1), which implicitly defines a set of angles $\{\theta_\ell\}$, what is an upper bound on the sum of degrees of the set of polynomials $\{p_j\}$ which interpolate binary functions⁷ f_1, f_2, \dots, f_m satisfy Remark II.2. This upper bound depends only on $\{\theta_\ell\}$.*

Toward analyzing the minimal degree of such interpolating polynomials as desired in Problem III.1, we give a series of older results from works in constrained interpolation.

Theorem III.1. In [30] *Let $\Xi = \{x_i : x_1 < x_2 < \dots < x_n\}$ a set from the real interval $[a, b]$ and \mathcal{P} the set of polynomials. For all $\epsilon > 0$ and for each $f \in C^0[a, b]$, the continuous functions on $[a, b]$, there exists $p \in \mathcal{P}$ such that the following conditions are satisfied:*

1. p is interpolating: $p(x_i) = f(x_i) \forall x_i$.

⁶ This is purposefully left ambiguous at this moment; we wish to lower the required derivative of the interpolating polynomial.

⁷ Note that for our purposes it is often not important to distinguish between $\{\ell\}$ the set of indices and $\{\theta_\ell\}$ the set of angles. While the degree of the interpolating polynomial depends on these angles, this dependence can be simplified by promises on separations between neighboring θ_ℓ .

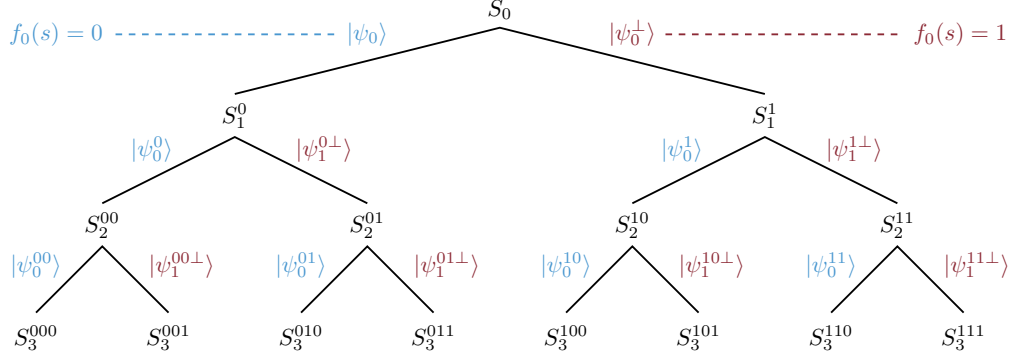

FIG. 6. Binary search as enacted by Algorithm 1. Algorithm 1 takes binary functions f_j on subsets of S_0 , specifically $S_j^{f_{<j}(s)}$, and produces a quantum algorithm that maps elements s on which f_j takes value $\{0, 1\}$ to orthogonal quantum states $\{|\psi_j^{f_{<j}(s)}\rangle, |\psi_j^{f_{<j}(s)\perp}\rangle\}$ respectively. Measurement in this basis determines the new query set, $S_{j+1}^{f_{<j+1}(s)}$, and the process is repeated until each leaf of the binary tree contains at most one quantum channel. The notation s here is overloaded, indicating both the quantum channel and the continuous parameter defining the channel. For extension of this concept from R-QHT to G-QHT see Remark IV.3

2. The polynomial p uniformly approximates f on $[a, b]$,

$$\max_{x \in [a, b]} |p(x) - f(x)| \leq \epsilon.$$

3. The polynomial p obeys the additional constraint

$$\max_{x \in [a, b]} |p(x)| = \max_{x \in [a, b]} |f(x)|.$$

Theorem III.2. In [35] Let ν index an increasing sequence of finite dimensional approximation subspaces N_ν in $C(T)$, for T a topological space, whose union N is dense in $C(T)$. If T is compact Hausdorff then the degree of approximation with Lagrange (function value) interpolatory side conditions $E_\nu(f, A)$ is related to the degree of the unrestricted approximation $E_\nu(f)$ by the inequality

$$\limsup_{\nu \rightarrow \infty} \frac{E_\nu(f, A)}{E_\nu(f)} \leq 2 \quad \forall f \in C(T) \setminus N,$$

where the constant 2 cannot be decreased in general, and is the best possible in the uniform approximation of (1) entire periodic functions by trigonometric polynomials and (2) entire functions on any closed finite interval by algebraic polynomials.

Corollary III.2.1. In the context of constrained polynomial interpolation the statement of Theorem III.2 can be made less general as follows: Given a real interval $[a, b]$ and a real polynomial f of degree d which interpolates a function g on $[a, b]$ at d distinct points in $[a, b]$, the minimal degree of a polynomial which interpolates g at these same points and has norm strictly less than $\|g\|$ on $[a, b]$ is bounded above by $2d$ as d goes to infinity and moreover this bound cannot be decreased in general.

Theorem III.3. In [31] Let $n \in \mathbb{Z}^+$ and let $x_j = \cos \theta_j$ where $\theta_1 < \theta_2 < \dots < \theta_n \in [0, 2\pi]$ and the minimum separation between adjacent θ_j (on the unit circle) is given by $\delta > 0$. Given any real function $f \in C([-1, 1])$ there exists a polynomial p such that the following conditions hold:

1. p is interpolating: $p(x_j) = f(x_j) \forall x_j$.
2. The polynomial p is of degree $2m \leq c/\delta$ where $c > 0$ is some absolute constant.
3. The following inequality holds where the infimum is taken over the space of all polynomials q of degree at most $2m$ and k is a constant independent of f and n :

$$\max_{x \in [-1, 1]} |f(x) - p(x)| \leq k \inf_{q \in \mathcal{P}} \left(\max_{x \in [-1, 1]} |f(x) - q(x)| \right)$$

Theorem III.4. Let $\Xi = \{x_j\}_{j \in [n]}$ where $x_j = \cos \theta_j$ and where $\theta_1 < \theta_2 < \dots < \theta_n \in [0, 2\pi]$ such that the minimum separation between adjacent θ_j (on the unit circle) is given by $\delta > 0$. Then given any real function $f \in C([-1, 1])$ there exists a polynomial p such that the following conditions hold:

1. p is interpolating: i.e., $p(x_j) = f(x_j) \forall x_j$.
2. The polynomial p is of degree $m = \mathcal{O}(1/\delta)$.
3. The polynomial p satisfies the following inequality

$$\max_{x \in [-1, 1]} |p(x)| = \max_{x \in [-1, 1]} |f(x)|.$$

Proof. The existence of this polynomial is assured by Theorem III.1, the scaling of degree of the unconstrained (uniformly approximating) polynomial is given by Theorem III.4, and that the constrained polynomial's degree

does not grow too large with respect to the unconstrained polynomial's is given by Theorem III.2. ■

Finally, we present a lemma which permits us to apply all of the above results in the context, mandated by QSP, that the constrained interpolating polynomials used have definite parity.

Lemma III.1. *If there exists a polynomial of degree n interpolating a set of points which has (the point set) definite parity, and the polynomial is of fixed norm, then there exists a polynomial of degree $m \leq n$ which still interpolates the points and which has the same parity as the points. Proof follows by re-expressing the polynomial as a sum of terms with definite parity and observing that the component of parity matching those of the interpolation points still satisfies the desired properties.*

The results of this series of theorems, and particularly the assurances of Theorem III.4, permit us to justify the idealized claims of the classical program discussed in Algorithm 1, at least for cyclic groups. I.e., given that the quantum channels considered can be (at least for the case that G is cyclic) distinguished by their eigenvalues, the methods of QSP and the assurances of Theorem III.4 together imply that their exist computationally cheap, flexible quantum algorithms whose measurement results are themselves deterministic functions on the discrete set of possible channels.

With respect to a resolution of Problem III.1, this section has provided a key observation: the minimal degree of the interpolating polynomial on a set of angles $\{\theta_\ell\}$, as in the R-QHT, problem is linear in both the number of interpolation points and $\max_{\ell,k} 1/|\theta_\ell - \theta_k|$, the minimal separation between (distinct) queried angles.

Once the interpolating polynomials p_j are computed, the path to generating QSP angles Φ_j is well understood and computationally efficient (i.e., polynomial in the degree of the interpolating polynomial). There are many ways to perform such a computation, both analytically [24] and by numerically stable computations [26]. Moreover, the interpolating polynomials can be computed in any number of ways, usually relating to a modified Remez-type algorithm [36, 37].

IV. DECISION PROTOCOLS ON FINITE SUBGROUPS OF $SU(2)$

We now close the loop on our simplification of G-QHT in Problem I.2 to R-QHT in Problem II.1 and finally, through Algorithm 1 to a problem in polynomial interpolation where the degree of these polynomials relates directly (by the results of Problem III.1) to the query complexity of the solution to R-QHT. In this section we finally address the more general problem of G-QHT for small groups G .

For each finite subgroup $G < SU(2)$, we provide constructive proof that there exists a *series of binary functions* f_1, f_2, \dots, f_m and a *series of protocols to access*

sets of rotations about known, fixed axes for which the polynomials that interpolate each f_j can be explicitly described, computed, and characterized in terms of degree. Once this degree is known, the expected query complexity of these algorithms follows by the results of Section III. Before this, however, we extend the statement of P-QHT (Problem III.1), which as stated applied only to sets of rotations about a fixed axis, to sets which obey more general structure.

Problem IV.1. *The P-QHT problem (Problem III.1) can be extended given the following prescription on a solution form. We begin with the standard statement of G-QHT: given query access to one quantum channel among a faithful representation of a finite group $G < SU(2)$ determine the optimal query complexity of an adaptive serial query model algorithm that determines the hidden index of the queried channel with certainty.*

Importantly, however, for P-QHT to provide a solution, one must be able to transform the query set in a special way; this reduction follows from the conditions given below:

1. *There must exist a series of protocols, given query access to a channel set S , for generating compound queries⁸ (see Definition IV.1) whose structure is (1) precisely a set of rotations by known angles around a fixed axis (i.e., inputs to the R-QHT problem satisfying Remark II.1), or (2) a subset of a finite group G' for which a decision algorithm is already known.*
2. *In the case of (1) as given above there must exist a solution for P-QHT (Problem III.1) for the new query set. There must also exist some additional assumption, specific to the structure of S , that permits the compound query map used to be invertible. This is accomplished in different ways for different groups, e.g., under the assumption that the represented group is a semi-direct product, as in Theorem IV.2.*

Definition IV.1. *A compound query with respect to a quantum channel $\mathcal{E} : A \rightarrow B$ is a quantum circuit $\mathcal{C} : A \rightarrow B$ which uses a finite number of copies of \mathcal{E} as well as a finite number of additional unitary operators independent of \mathcal{E} .*

Compound queries are often used by quantum algorithms (e.g., Algorithm 1) in place of bare queries, i.e., simply \mathcal{E}_i . Usually, useful compound query circuits do not act injectively on the query set.

⁸ In simple terms one may think of these as small quantum circuits which employ a small number of queries to the original oracle, and may be used as subroutines replacing oracle calls for a protocol expecting queries of a different form. Multiple *physical* queries can form one *compound* query.

Remark IV.1. *The extended statement of the P-QHT problem (Problem IV.1) exists to answer the following question: how far can Algorithm 1 be taken beyond its role as a solution to R-QHT?*

Consequently each of the algorithms discussed in this section is, in truth, simply (1) a procedure for reduction to R-QHT, followed by (2) application of Algorithm 1. When reduction is made to deciding a simpler group, the application of Algorithm 1 is hidden behind algebraic abstraction.

We go through the finite list of distinct families of finite subgroups of $SU(2)$ in order of increasing complexity, recovering instances of Problem IV.1 as stated above. As a road-map we provide the following lemma, which completely characterizes the finite subgroups of $SU(2)$. A diagram of the path of these reductions was given in Figure 4.

Lemma IV.1. *The finite subgroups of $SU(2)$ are in bijection with the finite subgroups of $SO(3)$ under the standard double covering $SU(2) \rightarrow SO(3)$. These finite subgroups are thus completely described by five families: (1) The cyclic groups of order n , C_n , $n \in \mathbb{Z}^+$. (2) The dihedral groups of order $2n$, D_{2n} , $n \in \mathbb{Z}^+$. (3) The alternating group on four elements, A_4 . (4) The symmetric group on four elements, S_4 . (5) The alternating group on five elements A_5 .*

A. Cyclic groups

Before lifting the methods of Lemma I.1 from C_{2^n} to general cyclic groups we provide a few lemmas.

Lemma IV.2. *The cyclic group of order n is isomorphic to the direct product of cyclic groups*

$$C_n \cong C_{p_1^{r_1}} \times C_{p_2^{r_2}} \times \cdots \times C_{p_s^{r_s}},$$

iff the unique prime decomposition of n is

$$n = \prod_{i=1}^s p_i^{r_i}, \quad (6)$$

for distinct primes p_i . I.e., C_n is isomorphic to a direct product of cyclic groups of prime-power order for all maximal prime powers dividing n . This is one statement of the Chinese remainder theorem.

We proceed to analyze decisions on C_n by a series of reductions to decisions on the more restricted (albeit infinite) family of cyclic groups of prime order.

Lemma IV.3. *If there exists a family of algorithms $\mathcal{F} = \{\mathcal{A}_{C_p}\}$ that each perfectly decide C_p for all primes p then there exists an algorithm \mathcal{A}_{C_n} that perfectly decides C_n for $n \in \mathbb{N}$, and which is asymptotically optimal in query complexity if the algorithms in \mathcal{F} are also optimal.*

Proof. Any positive integer n has a unique decomposition into a product of unique primes as given in (6), where r_i is the multiplicity of the i -th smallest prime dividing n , p_i , and s is the largest index for which p_i divides n at least once.

Assuming the existence of a deterministic algorithm $\mathcal{A}_{C_{p_i}}$ that can perfectly decide C_{p_i} , elements of the group C_n are decided according to the following protocol:

1. If the multiplicity r_i of p_i in n is one, in the place of the query usually made by the protocol $\mathcal{A}_{C_{p_i}}$, query the oracle n/p_i times. This compound query may be conjugated by a known unitary to achieve the representation that \mathcal{A}_{p_i} expects.
2. If the multiplicity of p_i in n (r_i) is greater than one, the same method presented in the Lemma I.1 is applied to compound queries of order $n/p_i^{r_i}$ to read off successive bits (this time in base p_i) of r_i , using the assumed subroutine for deciding $\mathcal{A}_{C_{p_i}}$.

Compound queries allow access to prime-power-order cyclic subgroups of C_n whose decision algorithms are strictly simpler and reducible to decisions on C_p for p prime. ■

We proceed by considering a result concerning the smallest non-trivial cyclic group, C_3 , with which to play G-QHT. This can be thought of as a base case for our eventual reduction from decision protocols on large cyclic groups to smaller ones.

Discriminating between quantum channels representing C_3 has some precedent in prior work: such channels are precisely those which can generate the *Peres-Wootters states* [38, 39] or equivalently *Mercedes-Benz frames* [40, 41] (for their threefold symmetry).

Lemma IV.4. *There exists an algorithm \mathcal{A}_{C_3} that perfectly decides C_3 (or rotations about a fixed axis on the Bloch sphere by one angle among the three angle set $\{0, 2\pi/3, 4\pi/3\}$) using at most 6 oracle queries. This algorithm is said to solve the three angle problem.*

Proof. Without loss of generality the group C_3 is represented by the set of quantum channels $\{R_0(0), R_0(2\pi/3), R_0(4\pi/3)\}$. Consider the QSP sequence defined by QSP phase list $\Phi = \{0, -\alpha, \alpha, 0\}$ using the convention of Theorem II.1, i.e., the product

$$U_\Phi = R_x(\theta)R_z(\alpha)R_x(\theta)R_z(-\alpha)R_x(\theta), \quad (7)$$

for any angle θ . It is not hard to explicitly compute the top left component of this unitary operator, and specifically for the special angle $\alpha = \arccos(\cos\theta/[1 - \cos\theta])$, which is real whenever $\pi/3 \leq \theta \leq 5\pi/3$, the top left component of this unitary $\langle 0|U_\Phi|0\rangle$ is 0. Consequently with three queries to the oracle, and $\alpha = \arccos(-1/3)$, the transition probability $|0\rangle \mapsto |0\rangle$ is 1 if $\theta = 0$ and 0 if $\theta \in \{2\pi/3, 4\pi/3\}$. Consequently three additional queries are enough, possibly replacing $R_x(\theta)$ with $R_x(\theta)R_x(-2\pi/3)$ in (7), to completely and perfectly determine the hidden

angle. Over equal priors the expected query complexity of this technique is 5.

Alternatively in the language of Theorem II.1, we intend that the top left element of U_Φ , under the map $\cos \theta/2 \mapsto x$, has the form

$$f_1(x) = \frac{4}{3}x(x - 1/2)(x + 1/2),$$

which is a polynomial⁹ that takes modulus 1 at $x = -1$ and $x = 1$, has definite parity, and takes value 0 at $x = \pm 1/2$. This, along with $f_1(x)$ under the map $\theta \mapsto \theta - 2\pi/3$ produces a pair of binary measurements for which the map¹⁰ $S \mapsto M$ is injective where M is the set of binary measurements.

$$\{ \langle +|U_\Phi|+\rangle, \langle +|U'_\Phi|+\rangle \} = \begin{cases} \{1, 0\} & \theta = 0 \\ \{0, 1\} & \theta = 2\pi/3 \\ \{0, 0\} & \theta = 4\pi/3, \end{cases}$$

where U'_Φ is the aforementioned pre-rotation replacing $R_x(\theta)$ with $R_x(\theta)R_x(-2\pi/3)$ or equivalently $\theta \mapsto \theta - 2\pi/3$. A visual depiction of this algorithm is given in Figure 8, and a table relating this Lemma's construction directly to Algorithm 1 is given in Table I. ■

The functional intuition of protocols deciding on representations of cyclic groups is depicted in Figure 8. As discussed previously, QSP protocols take equiangular rotations about different axes in equator of the Bloch sphere (see Figure 7), interleave them with rotations about orthogonal axes on the Bloch sphere, and give efficient methods for forcing the corresponding matrix elements of the final, composite rotation to be desired trigonometric polynomials in the unknown rotation angle. Figure 8 demonstrates that polynomials which have modulus 0 or 1 at specific angles result in deterministic protocols for dividing the search space. The work remaining is to systematize sub-protocols of this form to generate efficient decision protocols on the entire query set.

Finally we can provide a proof for perfect decision protocols on all prime order cyclic groups, and in fact this shows an even stronger result as the same method goes through for cyclic groups of any odd order. However, given the results of Lemma IV.3, QSP is only a necessary tool in the prime-order case, when compound queries provide no helpful simplifications.

Theorem IV.1. *There exists a family of deterministic algorithms $\mathcal{F} = \{\mathcal{A}_{C_p}\}$ for all primes p , where \mathcal{A}_{C_p} perfectly decides C_p , with asymptotically optimal query complexity.*

⁹ Note that $(4/3)(x - 1/2)(x + 1/2)$ also satisfies constraints required by QSP, and indeed this lemma can be shown using only 4 maximum (10/3 expected) oracle queries, though the resulting protocol is less geometrically obvious.

¹⁰ S is overloaded here: both channel elements and the continuous real parameter θ characterizing these elements. Note also that this map can be written as a binary tree as in Figure 6.

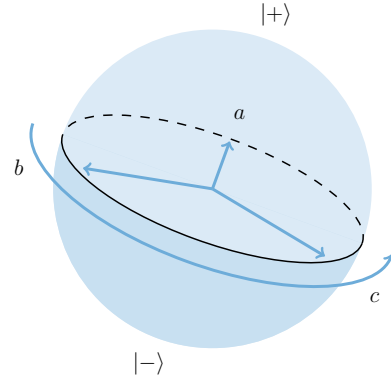

(a) Geometric interpretation.

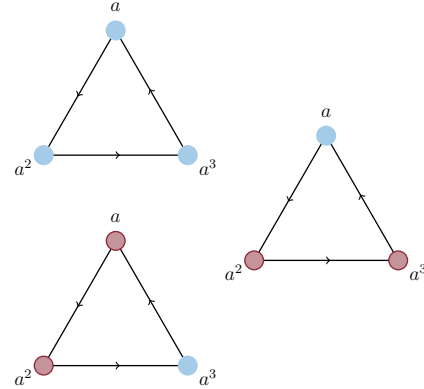

(b) Algebraic interpretation.

FIG. 7. Geometric (a) and algebraic (b) depictions of the proof of Lemma IV.4. Unitary representations of C_3 in $SU(2)$ are, without loss of generality, equivalent to a set of rotations which cycles states (a, b, c) as shown on the Bloch sphere in (a). Moving away from the Bloch sphere, any sequence of quantum channel discrimination protocols whose binary PVM output differs on subsets of quantum channels representing C_3 (e.g., partitions C_3 elements into red and blue subsets as pictured, and as proven in Lemma IV.4), also determines the queried quantum channel perfectly. The partitions indicated in (b) are generated by polynomials given in Figure 8.

Proof. The proof follows from the existence of a family of polynomials f_1, f_2, \dots, f_m whose moduli take values in $\{0, 1\}$ on a finite set of subsets $\{S_j\}$ for $j \in [m]$ of the set of p possible phases S_0 induced by queries to the oracle, namely

$$S_0 = \left\{ \cos \left(\frac{\pi n}{p} \right), n \in [p] \right\},$$

such that that the successive subsets $S_0 \supseteq S_1 \supseteq \dots \supseteq S_m$ have the following¹¹ properties:

¹¹ Also described in Remark II.2 and Figure 6.

Index	Query map	p_j	$ \psi_j\rangle$	$ \psi'_j\rangle$
$j = 1$	$\mathcal{E}_i \mapsto \mathcal{E}_i$	$(4x^3 - x)/3$	$ +\rangle$	$ \pm\rangle \mapsto \{0, 1\}$
$j = 2$	$\mathcal{E}_i \mapsto \mathcal{E}_i R_x(-2\pi/3)$	$(4x^3 - x)/3$	$ +\rangle$	$ \pm\rangle \mapsto \{0, 1\}$

$$\{f_1(\mathcal{E}_i), f_2(\mathcal{E}_i)\} = \begin{cases} \{0, 1\} \mapsto R_x(0) \\ \{1, 0\} \mapsto R_x(2\pi/3) \\ \{1, 1\} \mapsto R_x(4\pi/3) \end{cases} \quad (\text{Inverse map})$$

TABLE I. The use of Algorithm 1 as a subroutine for solving the three angle problem (Lemma IV.4) in tabular form. As p_j for $j \in [m]$ completely define both f_j and the corresponding QSP-derived objects given in Definition II.2, they provide a minimal explicit demonstration of the use of Algorithm 1. Included are quantum states for preparation, $|\psi_j\rangle$, and measurement, $|\psi'_j\rangle$, as well as the compound query map (Definition IV.1), where Algorithm 1 is fed compound queries. Finally, an inverse map is given to recover the hidden channel.

- **Bisecting:** The order of S_{j+1} should satisfy that $|S_{j+1}| \leq (1/c)|S_j|$ for some fixed constant $c = \mathcal{O}(1)$.
- **Density reducing:** The minimum separation between elements of S_{j+1} on which the modulus of the interpolating polynomial f_{j+1} takes distinct values should increase exponentially in j .
- **Totally deciding:** Constructing a family of interpolating polynomials p_j whose moduli take values in the set $\{0, 1\}$ on S_j is equivalent to computing a family of binary functions f_j on C_p ; the evaluation of these binary functions on the hidden channel corresponding to $g \in C_n$ should uniquely identify g . I.e., this map $g \mapsto \{0, 1\}^m$ should be injective (see Figure 6).
- **Parity preserving:** The elements of S_j should be of definite parity for all j ; this parity is shared by all p_j .

If all of these conditions are satisfied by some judicious sequence of S_j the result follows if the number of such non-trivial subsets of S , given by m , is asymptotically $\log p$ and the degree of the polynomial p_j goes as $\mathcal{O}(p/c^j)$ in which case the entire protocol has query complexity linear in p .

The existence of these interpolating polynomials is guaranteed by the results of Section III, while their asymptotic query complexity follows directly from exponentially increasing promised gaps between elements of S_j . For a given group C_p these subsets S_j have the explicit, measurement dependent, form

$$\begin{aligned} S_0 &= S_0 \\ S_j^0 &= \{s_k \in S_{j-1}, f_{j-1}(s_k) = 0\} \\ S_j^1 &= \{s_k \in S_{j-1}, f_{j-1}(s_k) = 1\} \end{aligned}$$

where the new S_j 's upper index indicates the measurement result of the QSP sequence dividing the search

space, and is subsequently dropped as this iterative division continues. The functions f_j are defined as polynomials which interpolate any binary function on the set S_{j-1} which alternates maximally with definite parity on $[-1, 1]$ (f_j will share this parity). These functions have explicit description, e.g., when given some subset S_j of size $2n + 1$, indexing by ℓ for increasing s_ℓ in $[-1, 1]$.

$$f_j(x_\ell) = \begin{cases} \frac{1}{2}[1 + (-1)^\ell] & 1 \leq \ell \leq n \\ \frac{1}{2}[1 + (-1)^{\ell-1}] & n + 1 \leq \ell \leq 2n + 1. \end{cases}$$

This evidently preserves parity and confers the right properties on successive subsets. In plain terms this is a binary search whose constituent sub-searches grow exponentially cheaper in query complexity, and whose base case is handled by Lemma IV.4. ■

Finally, by the previous results we can make a statement for all cyclic groups, and proceed to richer subgroups of $SU(2)$.

Corollary IV.1.1. *For all $n \in \mathbb{N}$, there exists a deterministic algorithm \mathcal{A}_{C_n} which perfectly decides C_n , with asymptotically optimal query complexity. This follows directly from Lemma IV.3 and Theorem IV.1.*

B. Dihedral groups

We consider the dihedral groups of order $2n$; it is not too difficult to see that each bit-string label for an element $g \in D_{2n}$ requires exactly one more bit to uniquely describe the element, corresponding to membership of g in one of two cosets of the normal cyclic subgroup $C_n \triangleleft D_n$. We show that this bit can be recovered in one additional measurement, and that our protocol is thus optimal assuming the optimality of the protocol which decides C_n .

Theorem IV.2. *Assuming existence of an algorithm \mathcal{A}_{C_n} that perfectly decides C_n there exists an algorithm $\mathcal{A}_{D_{2n}}$ that calls \mathcal{A}_{C_n} as a sub-routine and perfectly decides D_{2n} , the dihedral group of order $2n$, with one addi-*

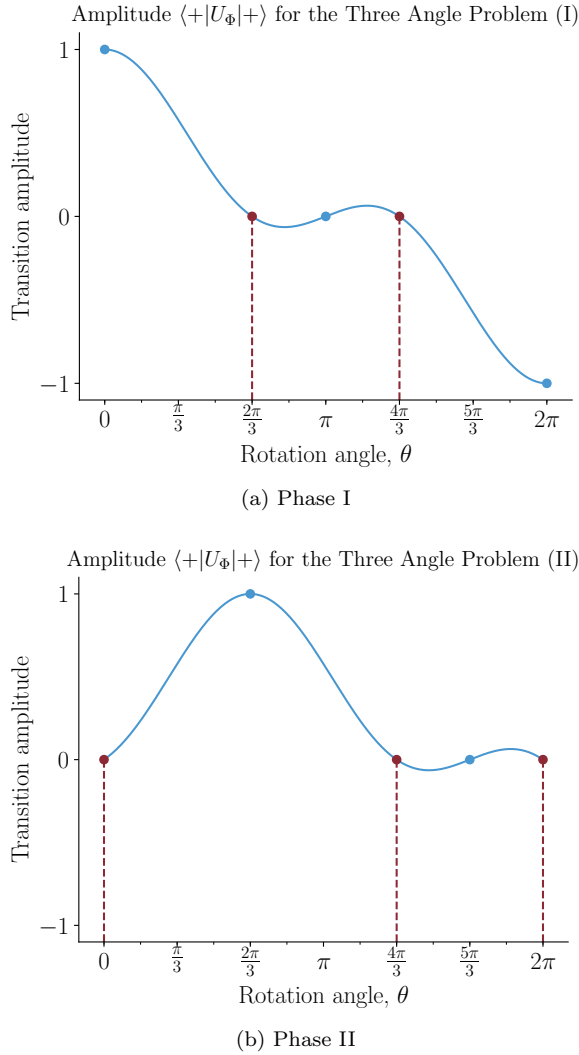

FIG. 8. Quantum response function employed in the proof of Lemma IV.4 (a), and its shifted version (b). On the left is the polynomial, in $\cos(\theta/2)$, which is generated as the top left component of the single-qubit unitary U_Φ corresponding to the angles Φ indicated in the first QSP subroutine of Lemma IV.4. On the right is the same protocol using a pre-rotation by $2\pi/3$, permitting a unique binary labeling of each channel after two measurements.

tional oracle query. A depiction of the overarching idea of this algorithm is given in Figure 9.

Proof. Without loss of generality $\mathcal{A}_{D_{2n}}$ has oracle access to a channel in a representation of D_{2n} whose cyclic subgroup C_n in $SU(2)$ has representation:

$$\{R_z(m \cdot 2\pi/n)\}, m \in [n]. \quad (8)$$

The $SU(2)$ embedding of D_{2n} that contains our embedding of C_n as a subgroup is generated by a generator of this C_n , σ , and another group element, τ , which without loss of generality has representation $R_x(\pi)$. The standard presentation of D_{2n} is

$$D_{2n} \equiv \{\sigma, \tau \mid \sigma^n = \tau^2 = \tau\sigma\tau = e\}, \quad (9)$$

The lemma follows if there exists a simple protocol to, given query access to an unknown element $g \in D_{2n}$, determine membership of the queried element g among the two cosets of $C_n < D_{2n}$.

Assume $U(g)$ is the unitary operation corresponding to the group element g embedded in $SU(2)$ as stated. Then

$$HU(\langle\sigma\rangle)H|0\rangle = |0\rangle \quad (10)$$

$$HU(\tau)U(\langle\sigma\rangle)H|0\rangle = |1\rangle, \quad (11)$$

where H is the Hadamard gate and $U(\langle\sigma\rangle)$ represents some unitary operation within the subgroup $\langle\sigma\rangle$ generated by σ . Intuitively, H rotates $|0\rangle$ to another state insensitive to the action of the cyclic index 2 subgroup of D_{2n} . This follows from the lack of irreducible representations of C_n in $SU(2)$.

If $|0\rangle$ is measured then \mathcal{A}_{C_n} can be applied as normal to future queries, respecting the embedding of the subgroup $\langle\sigma\rangle$. Otherwise any query made to the oracle $U(g)$ is prefaced by $R_x(\pi)$, reducing to a decision on C_n . Only one additional query is needed by $\mathcal{A}_{D_{2n}}$ to decide D_{2n} (a group with twice the size). ■

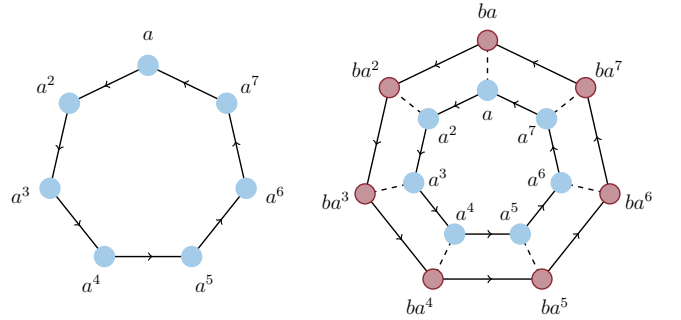

FIG. 9. Two presentations of Cayley graphs for the cyclic group of order 7 and the dihedral group of order 14. The observation that the cyclic group admits no irreducible representations in $SU(2)$ allows the perfect determination, in one additional query, of coset membership for the maximal cyclic subgroup of D_{2n} , partitioning the red and blue sets.

C. Platonic groups

Finally we address protocols for the finite subgroups of $SU(2)$ that do not fit into countably infinite families, and exhibit a richer non-abelian structure than the dihedral group. These are often referred to as the platonic groups due to their appearance in the study of symmetry groups of platonic solids. Before discussing protocols for deciding A_4 , S_4 and A_5 we define two basic group theoretic concepts that will aid in their construction.

Definition IV.2. (*Cycle decomposition*). Let S be a finite set, e.g., the integers $\{1, 2, \dots, n\}$, and σ a permutation $S \rightarrow S$. The cycle decomposition of σ expresses

Index	Query map	p_j	$ \psi_j\rangle$	$ \psi'_j\rangle$
$j = 1$	$\mathcal{E}_i \mapsto R_\xi(-\pi/2)\mathcal{E}_i R_\xi(\pi/2)$	x	$ +\rangle$	$ \pm\rangle \mapsto \{0, 1\}$
\vdots	\vdots	\vdots	\vdots	\vdots

$$\{f_1(\mathcal{E}_i), f_2(\mathcal{E}_i)\} = \begin{cases} \{0, \dots\} \mapsto e * C_n^? \\ \{1, \dots\} \mapsto \tau * C_n^? \end{cases} \quad (\text{Inverse map})$$

TABLE II. The use of Algorithm 1 as a subroutine for deciding on dihedral groups D_{2n} (Theorem IV.2) in tabular form. The table proceeds until reduction to C_n is achieved (i.e., after the first query); this query rotates to the basis in which σ (the generator of $C_n \triangleleft D_{2n}$) acts trivially on $\{|\pm\rangle\}$. Once coset membership in the maximal cyclic subgroup of the queried element is known, it can be inverted and applied to form compound queries that reduce the query set to C_n , given in Corollary IV.1.1. Here $C_n^?$ is an unknown power of σ .

σ as a product of disjoint cycles. For instance, if S has size 4 and the action of σ swaps pairs 1, 2 and 3, 4, then the cycle decomposition of σ is denoted $(1, 2)(3, 4)$, where the order of tuples is not uniquely defined.

Definition IV.3. (Cycle type). Let S be a finite set, for instance the integers $\{1, 2, \dots, n\}$, and σ a permutation $S \rightarrow S$. The cycle type¹² of σ is a tuple indicating the number of cycles of each given length in the cycle decomposition of σ . E.g., for the example given in Definition IV.2, the cycle decomposition $(1, 2)(3, 4)$ has cycle type $(0, 2, 0, 0)$, indicating two length-two cycles.

Note that the set of all possible cycle types is in bijection with unordered partitions of the integers in $\{1, 2, \dots, n\}$: i.e., for cycle type tuple c , the sum of $c_j \cdot j$ for $j \in [n]$ is simply n .

Theorem IV.3. There exists a deterministic algorithm A_{A_4} that perfectly decides A_4 with asymptotically optimal query complexity. This algorithm is additionally given in Table III.

Proof. The elements of A_4 can be classified according to their cycle type as permutations on four elements. For A_4 these types are $(1, 0, 1, 0)$, $(0, 2, 0, 0)$ and $(4, 0, 0, 0)$ (the last being the identity permutation).

Cubes of any element in A_4 have cycle type $(0, 2, 0, 0)$ or $(4, 0, 0, 0)$ only, meaning that if the queried element g is already in one of three representations for the D_4 normal subgroup of A_4 then running the D_4 algorithm on cubes of physical query elements gives the correct answer, and otherwise acts as if the queried element were the identity. This element can be determined in at most three compound queries deterministically, measuring in three mutually unbiased bases on the Bloch sphere, corresponding to the eigenstates of each of the generators of the chosen D_4 subgroup.

Given that $A_4 \equiv D_4 \rtimes C_3$, all elements g can be written in the form kh where h is drawn from a chosen normal D_4 subgroup of the representation of A_4 and k is from a realized C_3 subgroup. By pre-applying powers of a generator of one of these C_3 subgroups, the D_4 algorithm on cubes of queries will consistently compute the binary function of membership of the queried element g in a particular coset of the normal $D_4 \triangleleft A_4$. Assuming equal priors, such an algorithm is expected to¹³ terminate in 14.5 queries. ■

Definition IV.4. We give a name to a particular subroutine presented in Theorem IV.3, whose use is indicated in Table III.

The function `correctCoset` takes as input the evaluation of the three binary measurements given in Theorem IV.3 to determine which element of the D_4 normal subgroup of A_4 enters into the chosen semi-direct product $D_4 \rtimes C_3$ and returns the representation of the inverse of this element.

Theorem IV.4. There exists a deterministic algorithm A_{S_4} which perfectly decides S_4 , with asymptotically optimal query complexity.

Proof. Squares of elements in S_4 necessarily fall in the alternating group A_4 , though this mapping is not always invertible. It is invertible, however, when the queried element g in S_4 has the cycle type $(1, 0, 1, 0)$. For any element in S_4 there exists an element h of cycle type $(2, 1, 0, 0)$ for which the product gh is of cycle type $(1, 0, 1, 0)$. Consequently there exists an algorithm that, for every element h of cycle type $(2, 1, 0, 0)$, of which there are six, pre-applies h to queries (and repeats this process to generate squares of this query element, $ghgh = (gh)^2$) and runs the A_4 algorithm on this compound query, which recovers perfectly in finitely

¹² The cycle type is sometimes defined as a tuple of the lengths of each cycle in the cycle decomposition, rather than the number of cycles of each given length.

¹³ The explicit calculation is $(1/4) \cdot 6 + (1/4) \cdot 12 + (1/4) \cdot 18 + (1/4) \cdot 22 = 29/2$ for the $3 + 3 + 3$ non-trivial elements of the cosets of the normal D_4 followed by 3 trivial elements.

Index	Query map	p_j	$ \psi_j\rangle$	$ \psi'_j\rangle$
$j = 1$	$\mathcal{E}_i \mapsto (\mathcal{E}_i)^3$	x	$ +\rangle$	$ \pm\rangle \mapsto \{0, 1\}$
$j = 2$	$\mathcal{E}_i \mapsto R_x(\pi/2)(\mathcal{E}_i)^3 R_x(-\pi/2)$	x	$ +\rangle$	$ \pm\rangle \mapsto \{0, 1\}$
$j = 3$	$\mathcal{E}_i \mapsto R_{x'}(\pi/2)(\mathcal{E}_i)^3 R_{x'}(-\pi/2)$	x	$ +\rangle$	$ \pm\rangle \mapsto \{0, 1\}$
$j = 4$	$\mathcal{E}_i \mapsto \mathcal{E}_i \text{correctCoset}(f_{<4}(\mathcal{E}_i))$	$(4x^3 - x)/3$	$ +\rangle$	$ \pm\rangle \mapsto \{0, 1\}$
$j = 5$	$\mathcal{E}_i \mapsto R_{x''}(2\pi/3)\mathcal{E}_i \text{correctCoset}(f_{<4}(\mathcal{E}_i))$	$(4x^3 - x)/3$	$ +\rangle$	$ \pm\rangle \mapsto \{0, 1\}$

$$\{f_1(\mathcal{E}_i), f_2(\mathcal{E}_i), f_3(\mathcal{E}_i), \dots\} = \begin{cases} \{0, 0, 0, \dots\} \mapsto D_4^e * C_3^? \\ \{1, 1, 0, \dots\} \mapsto D_4^a * C_3^? \\ \{1, 0, 1, \dots\} \mapsto D_4^b * C_3^? \\ \{0, 1, 1, \dots\} \mapsto D_4^{ab} * C_3^? \end{cases} \quad (\text{Inverse map})$$

TABLE III. The use of Algorithm 1 as a subroutine for deciding on A_4 as in Theorem IV.3 in tabular form. As p_j for $j \in [m]$ completely define both f_j and the corresponding QSP-derived objects given in Definition II.2, they provide a minimal explicit demonstration of the use of Algorithm 1. The p_j given here have also had their QSP angles explicitly given in Lemma IV.4. Here $D_4^g * C_3^?$ indicates a group element in the semi-direct product defining A_4 which is the product of g , an element of the chosen D_4 normal subgroup in terms of generators $\{a, b\}$ and an unknown element of the chosen C_3 subgroup. Axes x, x' are chosen such that these rotations generate the chosen D_4 subgroup, and x'' the axis of rotation for the chosen C_3 .

many queries the hidden element g when the image $(gh)^2$ has cycle type $(1, 0, 1, 0)$. Namely there exists a subroutine which determines coset membership for cosets of the normal $A_4 \triangleleft S_4$, and proceeds by reduction to decision on A_4 . This protocol is expected to terminate in 34 queries.¹⁴ ■

We note that the two protocols given above make no reference to the mechanisms of QSP, but are instead completely algebraic in form, exploiting the simple canonical subgroup towers of A_4 and S_4 to reduce decisions on representations of these groups to those on their normal subgroups. It is the small size of these non-abelian groups in particular which, unfortunately, bring the following remark. Resolving this problem is left open as stated in Section VI.

Remark IV.2. *The alternating group on five elements has, unfortunately, no simple reduction to an algorithm of the previous, smaller groups, in part because A_5 is the smallest simple non-abelian group, and thus permits no non-trivial decompositions in terms of a canonical tower of subgroups.*

Before concluding this section we give an overview (Remark IV.3) of the major technique which has permitted the extension of algorithms solving R-QHT (i.e., Algorithm 1) to those solving G-QHT.

Remark IV.3. *Extending the recursive bisection depicted in Figure 6, which in turn demonstrates the methods of Algorithm 1, to representations of non-cyclic*

groups follows, in each instance described in this section, from the following sketched protocol.

For each finite group presented in Section IV, we must provide (1) a small quantum circuit to produce compound queries (Definition IV.1) satisfying the input assumptions of Algorithm 1, (2) apply Algorithm 1 and keep track of its minimal required query complexity, and finally (3) verify the satisfaction of conditions under which the compound query map is invertible (e.g., as in Remark II.2), these conditions remaining unchanged despite the introduction of compound queries.

Whether this protocol is possible to perform for general groups is an open question, and indeed the methods of this section relied on the fact that the finite groups investigated were non-simple and often semi-direct products of abelian groups.

V. EXTENDING QHT PROTOCOLS TO LARGER GROUPS AND NOISY SETTINGS

It is natural to consider generalizations to the setting in which the results of Section IV were derived. This section concerns itself with two: (1) the inclusion of noise and (2) extension to larger finite groups.

A. Noisy channels and noisy quantum gates

The algorithms of Section IV relied on the fact that compound queries to the oracle could, under the assumption of access to unitary channels, make perfect use of the algebraic relations which were a priori known among the query set. These relations led to *effective query access* to simpler query sets for whom the optimal hypothesis

¹⁴ Again this number is arrived at by explicitly writing a table of elements of S_4 and running them through the protocol as given until it terminates.

testing algorithm was known. Naturally, however, realistic quantum computers and quantum channels exhibit noise, and one might be concerned about two different sources of error as summarized below.

1. The queried elements U_g may not perfectly satisfy the conditions imposed on a faithful representation of G , but may instead only *approximately* satisfy them, i.e.,

$$U_g U_h \approx_\epsilon U_{gh} \quad \forall g, h \in G,$$

where the approximate equality is with respect to some reasonable norm, here the diamond norm. Alternatively one can consider that the channels themselves are only near-unitary, i.e., that $U'_g \approx_\epsilon U_g$ for all $g \in G$ where the norm is again reasonable. Such a channel might be given by its operator-sum representation

$$U_g \equiv \int_h f_g(h) U_h d\mu(h),$$

where $f_g(h)$ is some probability density function defined suitably on elements of $SU(2)$ which is peaked about g to induce an operator whose diamond norm with U_g is suitably small. Here μ is some suitable measure over $SU(2)$.

2. The unitary operators applied by the querent may, in general, also not be perfect. This is the statement that the rotations normally applied in a QSP sequence as per the statement of Algorithm 1 may again only satisfy $U'_j \approx_\epsilon U_j$ for all indices j in the QSP sequence. We denote by U'_j the applied unitary and by U_j the intended unitary.

We consider the first instance, namely the physically realistic scenario that the ideal query set S is not the sampled query set, but instead that physical queries may be slightly perturbed from ideal queries. I.e., the physical queries $\{\mathcal{E}'_i\}$ are such that the diamond distance $\|\mathcal{E}_i - \mathcal{E}'_i\|_\diamond \leq \epsilon$ for some small $\epsilon > 0$. In this case, which encompasses all small perturbations, methods analogous to the ‘peeling lemma’ in [2], permit us to bound our new error in discrimination.

Lemma V.1. *Fixing an initial state ρ_j the trace distance $\|\rho - \rho'\|$ between the serial quantum channel discrimination protocol defined by the interspersed unitaries $\{U_{i,j}\}$ acting on ρ_j where the queried channel set is $\{\mathcal{E}_i\}$ versus $\{\mathcal{E}'_i\}$ is bounded above by $n_j \|\mathcal{E}_m - \mathcal{E}'_m\|_\diamond \leq n_j \epsilon$.*

Proof. In the case that the QSP sequences used are length 2, we show the result, and show that the method generalizes to length n_j sequences. The distance $\|\rho - \rho'\|$ can

be reexpressed and bounded above according to

$$\begin{aligned} & \|U_2 \circ \mathcal{E}_m \circ U_1 \circ \mathcal{E}_m(\rho_j) - U_2 \circ \mathcal{E}'_m \circ U_1 \circ \mathcal{E}'_m(\rho_j)\| \\ & \leq \|\mathcal{E}_m \circ U_1 \circ \mathcal{E}_m(\rho_j) - \mathcal{E}'_m \circ U_1 \circ \mathcal{E}'_m(\rho_j)\| \\ & \leq \|\mathcal{E}_m \circ U_1 \circ \mathcal{E}_m(\rho_j) - \mathcal{E}_m \circ U_1 \circ \mathcal{E}'_m(\rho_j)\| \\ & \quad + \|\mathcal{E}'_m \circ U_1 \circ \mathcal{E}_m(\rho_j) - \mathcal{E}'_m \circ U_1 \circ \mathcal{E}'_m(\rho_j)\| \\ & \leq \|\mathcal{E}_m(\rho_j) - \mathcal{E}'_m(\rho_j)\| \\ & \quad + \|\mathcal{E}_m[U_1 \circ \mathcal{E}'(\rho_j)] - \mathcal{E}'_m[U_1 \circ \mathcal{E}'_m(\rho_j)]\| \\ & \leq 2\|\mathcal{E}_m - \mathcal{E}'_m\|_\diamond, \end{aligned}$$

where the inequalities, in order from top to bottom, follow from (1) the monotonicity of the trace distance, (2) the triangle inequality, (3) monotonicity with respect to the CPTP map $\mathcal{E}'_m \circ U_1$, and (4) that the diamond distance dominates the trace distance on any particular initial state. This result can be iterated for arbitrarily many channel applications where the coefficient on the diamond distance goes as n_j where n_j is the discrimination algorithm’s j -th subpart’s query complexity. ■

For the second instance, where the querent’s own unitary operations are only close to the ideal operations, an analogous argument to that used in [42] permits us to bound error to a multiple of the per-gate error ϵ (usually computed in terms of a trace distance between the intended and applied channel) where this multiple is proportional to the QSP sequence’s length. Consequently under reasonable assumptions of noise in both the queried channel and the locally applied unitary operators, the methods presented in the previous section do no worse than expected, accruing error linearly in sequence length for reasonable norms.

B. Extensions to larger groups

The methods of Section IV use *compound queries* (e.g., positive integer powers of queries), defined in Problem IV.1, to access representations of subgroups of G . It is thus of interest to determine when one is to expect that (1) subsets of m -th powers of group elements generate proper subgroups, and (2) what information can be extracted under the assumption of the ability to decide on said subgroups. We state a series of related lemmas regarding these questions, assuming a basic understanding of group theory.

The following two lemmas in particular discuss sufficient conditions under which a known normal subgroup of G permits query access to compound queries that reside in said normal subgroup. These lemmas capture the underlying mechanism of the protocols given previously for deciding D_{2n} and A_4 .

Lemma V.2. *If a finite group G admits a normal subgroup N of index m then the subset of m -th powers of G , equivalently $S^m = \{g_1^m, g_2^m, \dots, g_n^m\}$ for all n elements of G generates a proper subgroup $G' \leq N < G$.*

Proof. Proof follows from recognizing that elements of the form g_i^m are in the kernel of the group homomorphism $G \rightarrow G/N$ and thus $\langle S^m \rangle$ is a (possibly non-proper) subgroup of the normal subgroup N of G , equivalently $\langle S^m \rangle \leq N < G$. ■

Lemma V.3. *If a finite group G admits a normal subgroup N of index m then the subset of m -th powers of G , i.e., the group generated by S^m as in Lemma V.2, is contained within the intersection of all index m normal subgroups of G . Proof again follows by the isomorphism theorems.*

Furthermore we give a lemma that describes the underlying behavior of the protocol given previously for deciding on S_4 (Theorem IV.3). It is the statement of this lemma, as well as the two preceding it, that precludes a solution for deciding on A_5 , which admits no non-trivial normal subgroups.

Lemma V.4. *If the m -power map $g \mapsto g^m$ applied to elements of G generates a proper subgroup $G' < G$, and there exists a group element $h \in G$ such that for some subset S of G the map $s \mapsto (sh)^m$ is invertible for all $s \in S$, and there exists a quantum protocol for deciding G' , then there exists a quantum protocol for deciding the query set $G' \cup S$.*

Proof. Constructing compound queries of m -th powers of physical queries allows access (at m times the query complexity) to a representation of G' . The statement of the lemma with respect to the set S says merely that pre-application of $h \in G$ before each query s is, under the map given, invertible, and thus unique identification of s is also possible with knowledge of h . ■

The statements given in the lemmas above do not depend on particularly complicated notions in group theory; instead, we have simply asked which simple operations can be performed in our limited resource model to faithfully simplify the query set. In most instances, these simplifications correspond to the existence of normal subgroups (equivalently kernels of group homomorphisms). For statements beyond those given here, especially those concerning the conditions under which the assumptions of Lemma V.4 hold beyond S_4 , we define a selection of open problems in Section VI.

The procedure outlined in Lemma V.4 is also not the most general one; indeed, compound queries can be built from general products of known unitary operations (some of which may coincide with the query set) and possibly multiple copies the queried channel. Conditions under which such a map is invertible relate intimately to the study of characters in representation theory, and provide exciting avenues for improved protocols for larger finite groups, e.g., $G < SU(n)$. Moreover, when considering larger Hilbert spaces, in analogy to the algorithms deciding on the dihedral groups D_{2n} , the family of finite groups which permit no irreducible representation in said larger Hilbert space grows richer, and correspondingly decisions

on groups which are semi-direct products grow easier. Thus, while extension to larger Hilbert spaces may not resolve the discussion of efficient decision algorithms on all larger groups in the serial adaptive query model, it may reasonably result in interesting *quantitative* statements on the entanglement or auxiliary system size necessary to achieve efficient (query-complexity-wise) discrimination dependent on the nature of the represented group.

VI. DISCUSSION AND CONCLUSIONS

In this work we have provided a constructive approach for achieving efficient quantum multiple hypothesis testing for query sets whose algebra faithfully represents a finite subgroup of $SU(2)$. The nature of this construction centers on the use of Algorithm 1, a quantum algorithm for solving the simpler R-QHT problem (Problem II.1), as a subroutine along with methods for exploiting known algebraic structure of the query set to enable reductions to R-QHT. This reduction is summarized in Remark IV.3.

Concretely, when the represented group G is either abelian or both non-abelian and non-simple the protocols we construct achieve optimal query complexity without the use of auxiliary systems or entanglement; this statement is equivalent to a statement about the minimal degree of constrained interpolating polynomials, and resolves an open question in [5], as well as generalizes an old result in [12] to quantum channels. Moreover, the bridge that Algorithm 1 and its derivative algorithms demonstrate between quantum information and functional approximation theory indicates a rich variety of novel instantiations of the basic ideas of QSP [22, 24].

In addition to achieving efficient quantum channel discrimination for a family of channel sets in a serial adaptive query model, we show that our protocols can be aborted early while still accomplishing useful tasks; this follows simply from the nature of the binary search discussed in Remark II.2. For instance, the reductions provided throughout Section IV are directly realizable as coset membership testing procedures in general, or period finding for the case of cyclic groups.

In the following remarks and problem definitions, we provide one more direct application of the methods discussed in this work to a problem in quantum communication.

Remark VI.1. *As mentioned in [16, 20], efficient protocols for the estimation of unitary processes have use in the transmission of reference frames as well as various proofs of insecurity for device-independent protocols for quantum bit-commitment.*

We give one example for how this work can be applied to a discretized version (e.g., group frames [17, 18], which share close relation with SIC-POVMs) of reference frame-sharing (Problem VI.1 and Lemma VI.1).

Problem VI.1. Consider two separated parties, Alice and Bob; each is able to (1) perform single-qubit unitaries and (2) transmit qubits noiselessly to the other party. Alice and Bob agree on a shared z -axis but are rotated with respect to each other by some unknown angle θ about this axis. Moreover, the possible θ lie within a discrete set Θ of size n , known to both parties.

Alice and Bob can come to agreement on the unknown angle θ with certainty in a finite length interactive protocol; this protocol is denoted dual QSP due to its similarities with standard QSP [21–24], and is said to solve the dual QSP problem.

Lemma VI.1. There exists a finite length interactive protocol by which two parties playing the game defined in Problem VI.1 can win with certainty and with asymptotically optimal round number (under the restriction of sending single qubits).

Proof. Proof proceeds by direct construction. Beginning with some initial state $|\psi_0\rangle$, Alice applies to it a rotation about her local x axis, namely $\exp(i\phi_0\sigma_x)$, and sends this qubit to Bob. Bob applies a rotation about *his* local x -axis by another specified angle ϕ_1 , or equivalently according to Alice (if she knew the angle θ) Bob appears to apply $\exp(i\phi_1[\cos\theta\sigma_x + \sin\theta\sigma_y]) = U_B \exp(i\phi_1\sigma_x)U_B^{-1}$ where $U_B = \exp(-i[\theta/2]\sigma_z)$.

In other words, Alice and Bob can, according to some previously agreed upon prescription of real angles $\Phi = \{\phi_0, \phi_1, \dots, \phi_m\}$, collaboratively compute the unitary operator¹⁵

$$U_\Phi = e^{i\phi_m\sigma_x} \dots e^{-i[\theta/2]\sigma_z} e^{i\phi_3\sigma_x} e^{i[\theta/2]\sigma_z} e^{i\phi_2\sigma_x} e^{-i[\theta/2]\sigma_z} e^{i\phi_1\sigma_x} e^{i[\theta/2]\sigma_z} e^{i\phi_0\sigma_x}. \quad (12)$$

Moreover, following the final application of $\exp(i\phi_m\sigma_x)$ and measurement against $|\psi_1\rangle$, Alice can sample from the Bernoulli distribution defined by the transition probability $p = |\langle\psi_1|U_\Phi|\psi_0\rangle|^2$.

The construction above is almost a vanilla QSP sequence. It is not so difficult to see that if Alice and Bob additionally apply the rotation $\exp\{\pm i[\pi/2]\sigma_x\}$ respectively, locally, after their ϕ_j rotation for $j \in \{1, 2, \dots, m\}$, the collaborative sequence instead becomes

$$U_{\Phi'} = e^{i\phi_m\sigma_x} \dots e^{i[\theta/2]\sigma_z} e^{i\phi_3\sigma_x} e^{i[\theta/2]\sigma_z} e^{i\phi_2\sigma_x} e^{i[\theta/2]\sigma_z} e^{i\phi_1\sigma_x} e^{i[\theta/2]\sigma_z} e^{i\phi_0\sigma_x}, \quad (13)$$

which is of the form of a standard QSP sequence. Consequently we see concrete connection between *dual QSP* and standard QSP: i.e., a redefinition of QSP phase angles.

Given a standard QSP strategy, defined by an angular sequence Φ , there exists an angular sequence Φ' following the prescription given above such that the *dual QSP*

sequence defined by Φ' acts identically given access to parties of relative angular displacement θ as the sequence defined by Φ acts given query access to an equiangular rotation $\exp(-i[\theta/2]\sigma_z)$ in the setting of standard QSP.

Consequently a protocol solving Problem VI.1 follows directly from a protocol solving Problem II.1 under the prescription (following Algorithm 1) defined by $\Phi'_{j,k} = \Phi_{j,k} + \pi$ for $k \in \{1, \dots, n_j\}$ and $\Phi'_{j,0} = \Phi_{j,0}$. ■

Remark VI.2. We can analyze the performance of the protocol given in Lemma VI.1 in two ways: (1) in comparison naïve repetition of binary hypothesis testing and (2) in comparison to phase estimation, the continuous analogue of the problem statement.

- The results of [5] assert that the query complexity for distinguishing two distinct unitary operators U, V scales as $\mathcal{O}(1/\Theta[U^\dagger V])$ where $\Theta[W]$ is the length of the smallest arc containing all the eigenvalues of W on the unit circle in the complex plane.

When phrased as a decision on a representation¹⁶ of C_n , eliminating one possible quantum channel at a time gives a query complexity that scales as $\mathcal{O}(n^2)$ (as $\mathcal{O}(n)$ such discrimination procedures are required, each costing $\mathcal{O}(n)$ queries). As shown in the constructions leading to Corollary IV.1.1, however, decisions on C_n and consequently also discrete reference-frame sharing, have query complexity scaling as $\mathcal{O}(n)$ (up to logarithmic factors) courtesy of the implicit binary search in Algorithm 1.

- A feature of Lemma VI.1 is that it yields a deterministic quantum algorithm. If one only wishes to determine the relative rotation with high confidence, one can use phase estimation and achieve the same $\mathcal{O}(n)$ query complexity scaling [43] using $\mathcal{O}(\log n + \log(1/\epsilon))$ qubits for confidence ϵ . This also matches the performance of the estimation procedure in [16]. Thus while estimative methods perform similarly in the cyclic group case to G -QHT-derived methods, the methodology of Lemma VI.1 is tailored to the statement of discrete reference-frame sharing, can be done serially, and can be extended to richer finite groups.

The methods of Lemma VI.1 suggest a useful technique; namely, whenever a suitable sensing problem can be (1) discretized and (2) made coherent, the ability to, by a simple quantum process, induce a phase on, e.g., a single qubit, allows all of the mechanisms built in earlier sections to be directly applied with concomitant state-

¹⁵ Here assuming that m is even, i.e., that the protocol ends with Alice receiving the qubit.

¹⁶ This merely connects n in a reasonable, i.e., reciprocal, functional map to a factor defining the difficulty of discrimination, in which the stated quadratic improvement is always possible.

ments about query complexity or round complexity¹⁷ optimality.

Beyond direct applicability to discrete versions of problems defined in prior work (e.g., reference frame sharing), several fundamental open problems remain whose solution might lie in methods related to those discussed in this work; we outline a few of them below.

- **Decisions on the subgroup tower:** In analogy to the protocol given for deciding the dihedral group in Subsection IV B, are there families of larger groups G' whose lack of irreducible representation in the natural Hilbert space of multiple qubits ($[\mathbb{C}^2]^{\otimes n}$) or qudits (\mathbb{C}^d) permits groups G whose canonical subgroup tower includes G' to be decided by reduction to decisions on G' ? What are sufficient conditions under which protocols deciding G can, even inefficiently, be reduced to protocols for deciding normal subgroups of G ? Small examples of this phenomenon are given in the lemmas of Subsection V B.
- **Optimal G-QHT with bounded entanglement:** Given the procedure in the above part, does there exist a quantifiable trade-off between the serial and parallel query model query complexities required for deciding groups G given access to Hilbert spaces in which no representation of G is irreducible? If entanglement is required for optimal QHT algorithms on large or highly non-abelian query sets, are there methods to quantify the required minimum entanglement?
- **Quantum property testing:** Do there exist par-

tial discrimination protocols, e.g., beyond those provided for deciding coset membership, which decide other interesting properties of the group represented by the query set while not totally deciding on the group?

- **Estimating compact group elements:** Can the performance of quantum channel estimation protocols for compact groups G , e.g., as in [16], be suitably recovered by employing a method similar to those of this work to systematically divide the search space up to within a specified error? Under what assumptions about the compact group is this decision-to-estimation conversion in the serial adaptive query model still efficient?

To summarize, major avenues for extending this work lie in (1) natural generalizations to higher dimensional Hilbert spaces and (2) characterizations of richer finite groups which find natural representations in higher dimensional Hilbert spaces. Improvements in methods to address these questions have implications in quantum algorithms for problems in discrete algebra, and this subfield in turn has potential application, following translation of G-QHT-like problems to novel contexts (e.g., as in Lemma VI.1), to useful quantum algorithms for cryptography, communication, and sensing.

VII. ACKNOWLEDGMENTS

This work was supported in part by the NSF Center for Ultracold Atoms (CUA), the NSF EPiQC Expedition in Computing, and NTT Research.

-
- [1] C. W. Helstrom, *Quantum Detection and Estimation Theory*, Mathematics in Science and Engineering: A Series of Monographs and Textbooks (Academic Press, Inc., 1976).
 - [2] S. Pirandola, R. Laurenza, C. Lupo, and J. L. Pereira, Fundamental limits to quantum channel discrimination, *npj Quantum Inf.* **5**, 50 (2019).
 - [3] A. Acín, Statistical distinguishability between unitary operations, *Phys. Rev. Lett.* **87**, 177901 (2001).
 - [4] R. Duan, Y. Feng, and M. Ying, Perfect distinguishability of quantum operations, *Phys. Rev. Lett.* **103**, 210501 (2009).
 - [5] R. Duan, Y. Feng, and M. Ying, Entanglement is not necessary for perfect discrimination between unitary operations, *Phys. Rev. Lett.* **98**, 100503 (2007).
 - [6] Q. Zhuang and S. Pirandola, Ultimate limits for multiple quantum channel discrimination, *Phys. Rev. Lett.* **125**, 080505 (2020).
 - [7] T. Hashimoto, A. Hayashi, M. Hayashi, and M. Horibe, Unitary-process discrimination with error margin, *Phys. Rev. A* **81**, 062327 (2010).
 - [8] R. Takagi, B. Regula, K. Bu, Z. Liu, and G. Adesso, Operational advantage of quantum resources in subchannel discrimination, *Phys. Rev. Lett.* **122**, 140402 (2019).
 - [9] R. Takagi and B. Regula, General resource theories in quantum mechanics and beyond: Operational characterization via discrimination tasks, *Phys. Rev. X* **9**, 031053 (2019).
 - [10] A. W. Harrow, A. Hassidim, D. W. Leung, and J. Watrous, Adaptive versus nonadaptive strategies for quantum channel discrimination, *Phys. Rev. A* **81**, 032339 (2010).
 - [11] M. F. Sacchi, Optimal discrimination of quantum operations, *Phys. Rev. A* **71**, 062340 (2005).
 - [12] E. Davies, Information and quantum measurement, *IEEE Trans. Inf. Theory* **24**, 596 (1978).
 - [13] G. Kuperberg, A subexponential-time quantum algorithm for the dihedral hidden subgroup problem, *SIAM*

¹⁷ In the methods given, query complexity and round complexity are precisely the same (under the map from dual QSP to standard QSP): transmission of the shared qubit is necessary to enact a unitary operation dependent on the relative rotation.

- J. Comput. **35**, 170 (2005).
- [14] O. Regev, Quantum computation and lattice problems, *SIAM J. Comput.* **33**, 738– (2004).
- [15] A. M. Childs and W. van Dam, Quantum algorithms for algebraic problems, *Rev. Mod. Phys.* **82**, 1 (2010).
- [16] G. Chiribella, G. M. D’Ariano, and M. F. Sacchi, Optimal estimation of group transformations using entanglement, *Phys. Rev. A* **72**, 042338 (2005).
- [17] S. Waldron, Group frames, in *Finite Frames, Theory and Applications*, edited by P. G. Casazza and G. Kutyniok (Birkhäuser, New York, 2013) Chap. 5, pp. 171–192.
- [18] J. Kovačević and A. Chebira, An introduction to frames, *Found. Trends Signal Process.* **2**, 1 (2008).
- [19] G. Chiribella, G. M. D’Ariano, and P. Perinotti, Memory effects in quantum channel discrimination, *Phys. Rev. Lett.* **101**, 180501 (2008).
- [20] G. M. D’Ariano, D. Kretschmann, D. Schlingemann, and R. F. Werner, Reexamination of quantum bit commitment: The possible and the impossible, *Phys. Rev. A* **76**, 032328 (2007).
- [21] G. H. Low, T. J. Yoder, and I. L. Chuang, Methodology of resonant equiangular composite quantum gates, *Phys. Rev. X* **6**, 041067 (2016).
- [22] G. H. Low and I. L. Chuang, Optimal hamiltonian simulation by quantum signal processing, *Phys. Rev. Lett.* **118**, 010501 (2017).
- [23] G. H. Low and I. L. Chuang, Hamiltonian simulation by qubitization, *Quantum* **3**, 163 (2019).
- [24] A. Gilyén, Y. Su, G. H. Low, and N. Wiebe, Quantum singular value transformation and beyond: exponential improvements for quantum matrix arithmetics, in *Proceedings of the 51st Annual ACM SIGACT Symposium on Theory of Computing*, STOC 2019 (Association for Computing Machinery, 2019) p. 193–204.
- [25] A. W. Harrow, A. Hassidim, and S. Lloyd, Quantum algorithm for linear systems of equations, *Phys. Rev. Lett.* **103**, 150502 (2009).
- [26] Y. Dong, X. Meng, B. Whaley, and L. Lin, Efficient phase factor evaluation in quantum signal processing (2020), arXiv Preprint. <https://arxiv.org/abs/2002.11649>.
- [27] L. Lin and Y. Tong, Solving quantum linear system problem with near-optimal complexity (2019), arXiv Preprint. <https://arxiv.org/abs/1910.14596>.
- [28] J. Haah, Product decomposition of periodic functions in quantum signal processing, *Quantum* **3**, 190 (2019).
- [29] P. Erdos, On some convergence properties of the interpolation polynomials, *Ann. Math* **44**, 330 (1943).
- [30] W. Wolibner, Sur un polynome d’interpolation, *Colloquium Mathematicae* **2**, 136 (1951).
- [31] H. N. Mhaskar, F. J. Narcowich, N. Sivakumar, and J. D. Ward, Approximation with interpolatory constraints, *Proc. Am. Math. Soc.* **130**, 1355 (2001).
- [32] H. W. McLaughlin and P. M. Zaretski, Simultaneous approximation and interpolation with norm preservation, *J. Approx. Theory* **4**, 54 (1971).
- [33] F. Deutsch and P. D. Morris, On simultaneous approximation and interpolation which preserves the norm, *J. Approx. Theory* **2**, 355 (1969).
- [34] H. Yamabe, On an extension of the helly’s theorem, *Osaka J. Math* **2**, 15 (1950).
- [35] R. K. Beatson, *Degree of Approximation Theorems for Approximation with Side Conditions*, Ph.D. thesis, University of Canterbury (1977).
- [36] E. Remez, Sur le calcul effectif des polynomes d’approximation de tchebichef, *C. R. Acad. Sci. Paris* **199**, 337 (1934).
- [37] F. Grenez, Design of linear or minimum-phase fir filters by constrained chebyshev approximation, *Signal Process.* **5**, 325 (1983).
- [38] P. W. Shor, The adaptive classical capacity of a quantum channel, or information capacities of three symmetric pure states in three dimensions, *IBM Journal of Research and Development* **48**, 115 (2004).
- [39] A. Peres and W. K. Wootters, Optimal detection of quantum information, *Phys. Rev. Lett.* **66**, 1119 (1991).
- [40] B. Parvathalu and P. S. Johnson, Construction of mercedes-benz frame in \mathbb{R}^n , *Int. J. Appl. Comput. Math* **3**, 511 (2017).
- [41] S. A. Mohammad-Abadi and M. Najafi, Type of equiangular tight frames with $n + 1$ vectors in \mathbb{R}^n , *Int. J. Appl. Math. Res.* **1**, 391 (2012).
- [42] A. Y. Kitaev, A. H. Shen, and M. N. Vyalıy, *Classical and Quantum Computation*, Graduate Studies in Mathematics, Vol. 47 (American Mathematical Society, 2002).
- [43] M. A. Nielsen and I. L. Chuang, *Quantum Computation and Quantum Information: 10th Anniversary Edition*, 10th ed. (Cambridge University Press, USA, 2011).
- [44] A. Childs, J. Preskill, and J. Renes, Quantum information and precision measurement (1999), arXiv Preprint. <https://arxiv.org/abs/quant-ph/9904021v2>.