

AURSAD: Universal Robot Screwdriving Anomaly Detection Dataset

Błażej Leporowski^{*1}, Daniella Tola^{†1}, Casper Hansen^{‡2} and Alexandros Iosifidis^{§1}

¹Department of Electrical and Computer Engineering, Aarhus University

²Technicon ApS

February 9, 2021

arXiv:2102.01409v2 [cs.LG] 6 Feb 2021

*bl@ece.au.dk

†dt@ece.au.dk

‡cha@technicon.dk

§ai@ece.au.dk

Contents

1	Introduction	3
2	Designing the Process	3
2.1	Physical Setup	3
2.2	Data Collection	4
2.3	Reducing Bias in Data	5
3	Hardware Setup	8
3.1	Universal Robot	8
3.2	OnRobot Screwdriver	8
3.3	Cable Connections	8
4	Software Setup	9
4.1	Universal Robot Controller	10
4.2	Connection between Screwdriver and UR3e	10
4.3	Connection between Laptop, UR3e and OnRobot Screwdriver	11
5	Creating Anomalies	13
5.1	Missing screw anomaly	13
5.2	Extra assembly component	13
5.3	Damaged screw thread	13
5.4	Damaged plate thread	14
6	Data	14
6.1	Data structure	15
6.2	Data size	15
6.3	Data examples	15
7	Data experiments	18
7.1	Experiment 1 - Raw data	19
7.2	Experiment 2 - Processed data	20
7.3	Discussion	20
8	Conclusion	21
	References	21
	Appendices	25
A	Potential Issues	25
B	Data structure	26
C	Plates	27

1 Introduction

Screwdriving is present in numerous industrial applications. The American magazine ASSEMBLY has recently performed an annual Capital Equipment Spending Survey among the US assembly plant which found that screwdriving is performed in 58 percent of U.S. assembly plants, making it more popular than welding, pressing, adhesive bonding or riveting [1]. As in any process, different kinds of errors may occur during screwdriving. We define these errors as anomalies. Early automated detection of these anomalies, as well as post process data analysis, may prove helpful in the industrial applications of automated screwdriving. In order to evaluate whether Machine Learning (ML) approaches for detecting and classifying these anomalies is a viable path, a dataset containing comprehensive sensor readings captured during the automated screwdriving must be created first.

The goal of this report is to provide a general guide for the process of collecting data when creating a ML dataset. This will be accomplished using the case study of a screwdriving dataset with focus on normal and faulty operating scenarios. Obtaining faulty data from the manufacturing industry is challenging, since most of the recorded data is based on normal operating conditions. We attempt to close this gap within the screwdriving application, by creating a dataset consisting of different faulty scenarios that may occur during operation. This document describes the hardware and software setup, as well as the steps taken to collect this data.

The robotic screwdriver from OnRobot¹ was used to create this dataset, together with the UR3e robot from Universal Robots². Additionally, with the OnRobot Screwdriver being a relatively new tool, we share our experience regarding how to control it remotely and gather its sensor data while operating in unison with the UR3e robot. Furthermore, we create a Python framework that can be reused for controlling this combination of hardware in screwdriving applications. The resulting dataset contains time-series data for 5 types of operation:

Normal operation: the default, successful screwdriving process.

Missing screw anomaly: the screwdriver fails to pick up the screw and proceeds to try and complete the screwdriving process without it.

Damaged screw thread anomaly: the used screw has a damaged thread.

Extra assembly component anomaly: in the target position there is an unintended assembly component present, e.g. a washer.

Damaged plate thread: the plate's threaded hole is damaged

The anomalies are described in more detail in Table 2 in Section 5.

The report is divided into eight sections, where Section 2 describes how the data collection were designed. Section 3 describes the hardware setup, and Section 4 describes the software setup. This is followed by Section 5, which describes how the anomalies were created. The outcome of the experiments, describing the data, can be found in Section 6, followed by Section 7 which illustrates how different Machine Learning models have been applied to detect anomalies using the dataset. Finally, Section 8 gives a concluding summary of the report.

The data can be found at [2], and the accompanying library is available at [3].

2 Designing the Process

2.1 Physical Setup

The physical setup of the system is shown in Figures 1 and 2. The OnRobot Screwdriver is mounted on the UR3e robot arm, where it tightens and loosens screws on and to the plates A and P. For

¹<https://onrobot.com/en/products/onrobot-screwdriver>

²<https://www.universal-robots.com/products/ur3-robot/>

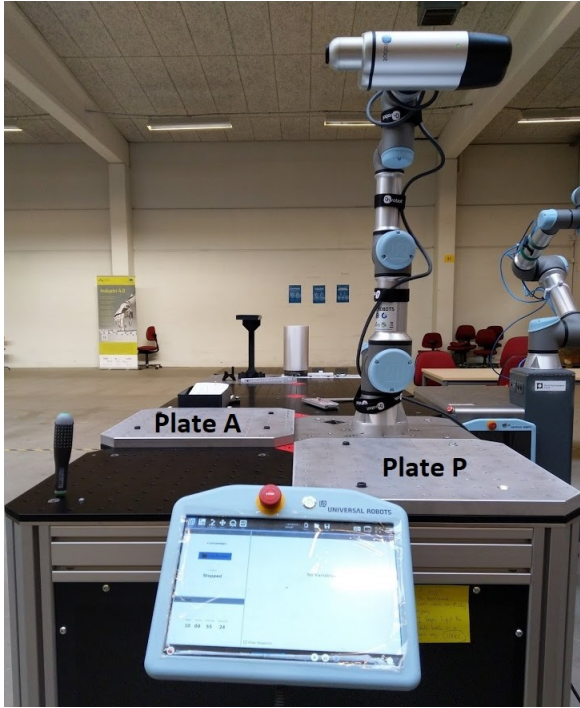

Figure 1: Robot cell shown from side.

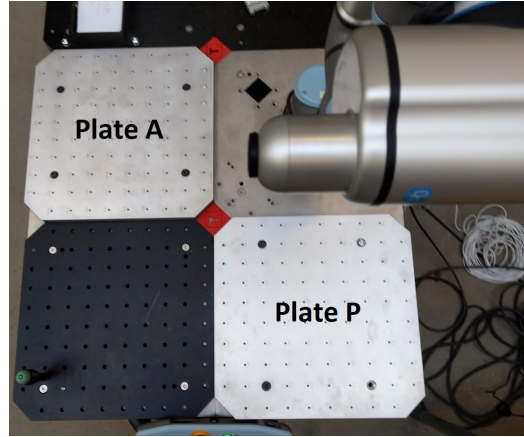

Figure 2: Robot cell shown from top.

example one sequence can be loosening screws from Plate A, and tightening them onto Plate P, and another one could be following the same process on the opposite order, i.e. loosening screws from Plate P and tightening them onto Plate P. More detailed information about the plates can be found in Appendix C.

2.2 Data Collection

The order of the robot movement is illustrated in Figure 3. The figure demonstrates how the robot would move, if it was loosening screws from plate A and tightening screws on plate P. The specific movement is in this report referred to as the *screw sequence*, which is the sequence of movements starting with the robot at the the home position. The robot moves to position x to unscrew or pick up a screw, moves to home position again, then moves to position y to tighten the screw, and returns back to the home position to finish the sequence, as illustrated in Figure 3.

The program sequence of the screwing motion is shown below.

```

1 def screw_motion(self, v, a, home_pos, pos1, pos2, to_pin=0, from_pin=0):
2     # Move to home then hole 1
3     self.set_int_from_plate(from_pin)
4     self.move_pin_bool(pos1, v=v, a=a)
5
6     # Loosen screw
7     self.loosen_screw(pos1)
8
9     # Move to home then hole 2
10    self.move_home_bool(home_pos, v=v, a=a) # toggle home pin, followed by move_home
    command
11    self.set_int_to_plate(to_pin)
12    self.set_int_from_plate(0) # clear from_plate pin
13    self.move_pin_bool(pos2, v=v, a=a)

```

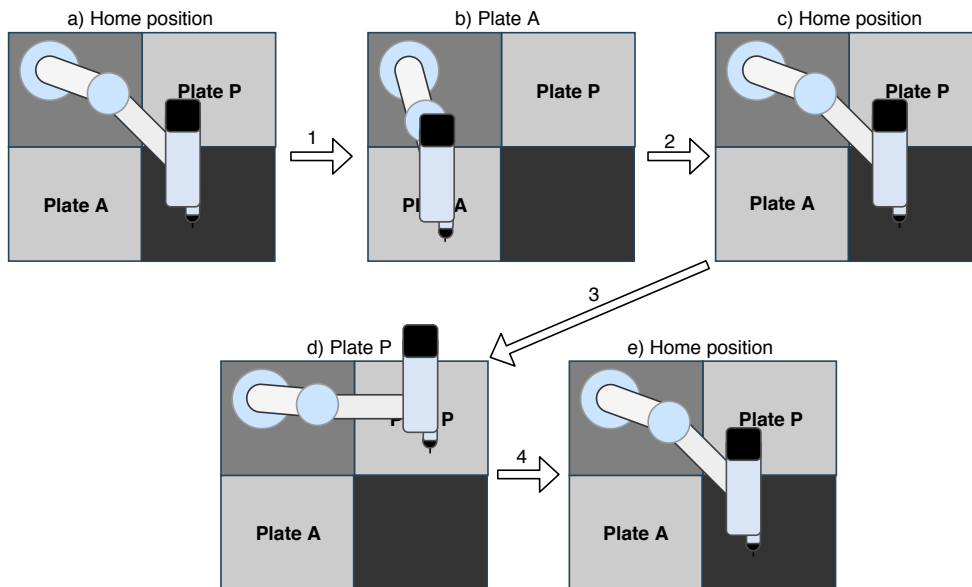



Figure 3: Example of the screw sequence: the robot starts from home position, moves to plate A to loosen and pick up a screw, moves to home position, moves to plate P to tighten a screw, then ends the sequence by moving back to the home position again.

```

14
15 # Tighten screw
16 self.tighten_screw(pos2)
17 self.move_home_bool(home_pos, v=v, a=a)
18 self.set_int_to_plate(0) # clear to_plate pin

```

Listing 1: Function performing the screw sequence motion.

The home position is used as start and end positions of the robot movements to allow for easier distinguishing between each sample run, since it allows for better slicing, labeling and selection of data in the later stages of the dataset creation process. Figure 4 illustrates the measured torque during one sequence and the value of the pin registers used to determine the position of the robot at different times. Table 1 provides the main pin commands and the positioning of the robot for each pin command. The pin command is usually sent before controlling the robot movement. For example, the home command pin is sent before sending a *move to home* command to the robot. These pin register values are used to split up the sequence depending on the application where the data is used.

2.3 Reducing Bias in Data

Datasets used for training ML models only contain a finite number of samples, which need to be representative of the problem they are trained to solve. That is, in order for the ML model to generalize well on unseen (test) data that it will encounter after deployment in the real system, the data it was trained on should not contain implicit biases that will deviate the ML model from learning generalizable characteristics of the (classes in the) data. To express this using a parallelism from computer vision, let us consider an image dataset containing the class *cat*, where only white cats are present. Without images depicting cats of other colors in the dataset, a ML model trained on this dataset will likely identify the white color as one of the important characteristics of the class *cat* leading to misclassification of cats having other colors. Figures 5 and 6 attempt to illustrate this

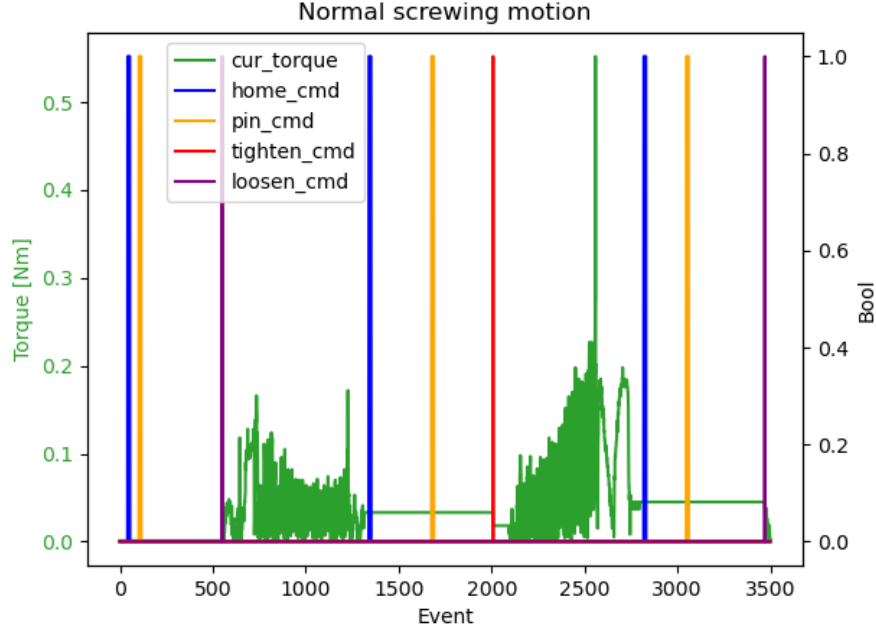

Figure 4: Sequence of normal screwing motion with labels

Command	Description	Current robot position
Move to home	Toggled to True then False. This indicates the robot just finished either a tighten or screw operation.	The robot is positioned at the recent hole it was operating on.
Move to pin	Toggled to True then False.	The robot is positioned at home, and is ready to move.
Tighten	Toggled to True then False. This commands the robot to perform a tightening operation. A screw is inside the On-Robot Screwdriver	The robot is positioned above the hole, where it will performed a tightening operation.
Loosen	Toggled to True then False. This commands the robot to perform a loosen operation, where the robot will loosen the screw and pull the screw inside the On-Robot Screwdriver.	The robot is positioned above the hole, where it will performed a loosen operation.

Table 1: Pin commands

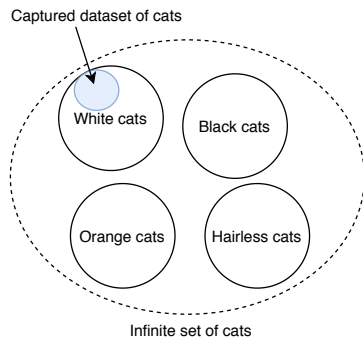

Figure 5: Biased dataset example.

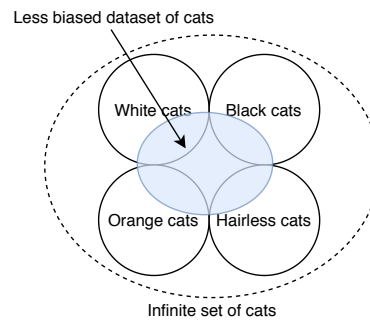

Figure 6: Less biased dataset example.

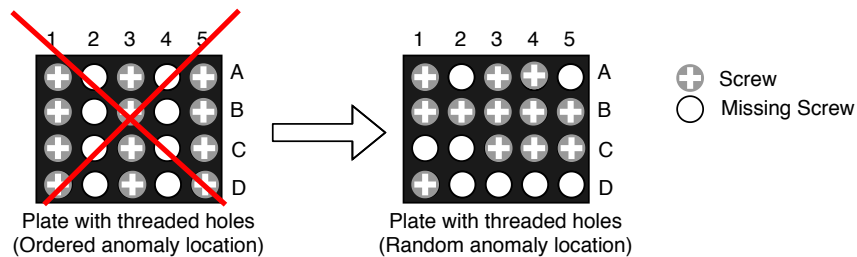

Figure 7: Illustration of how to reduce the bias of the dataset, by randomly placing anomalies.

problem.

Thus when creating a new dataset it is important to reduce bias as much as possible. We attempted to achieve this by defining varying sequences of the movement of the robot, varying locations of the anomalies, and varying changes between a normal screw and an anomalous screw. It was important to avoid the repetition of identical/repetitive movements of normal and anomalous screw to avoid creating patterns in the data that could potentially be learnt by the ML model. For example, Figure 7 (left) illustrates a pattern that may lead to the ML model learn that screws at specific horizontal positions are missing, and use this information instead of the differences in the measured torque when attempting to screw into an empty hole.

The anomalies are introduced into the sequences in several ways to increase the variation:

Every n-th point with varying starting points: The varying starting points and varying skipping n points allows a variation that is controlled by the developer.

First n points: using n subsequent points as anomalies results in different measurements, especially compared to the *every n-th point approach*.

Random n points: randomly generating points as anomalies will always result in a variation of the sequence of the anomalies.

To add variation to the movement of the robot and avoid using the same robot movement pattern all the time, two movement patterns were defined, a spiral and horizontal sequence, as illustrated in Figures 8 and 9. The same sequence was used on both plates, so if plate A was set to run with sequence 1, then plate P was also set to be run with the same sequence.

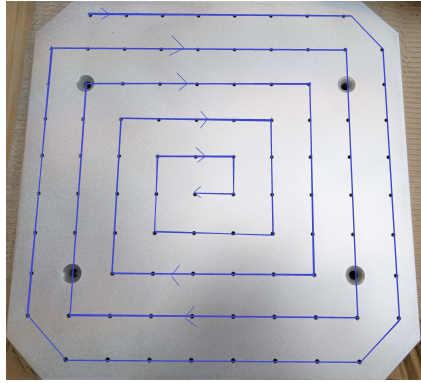

Figure 8: Movement pattern 1 - Spiral.

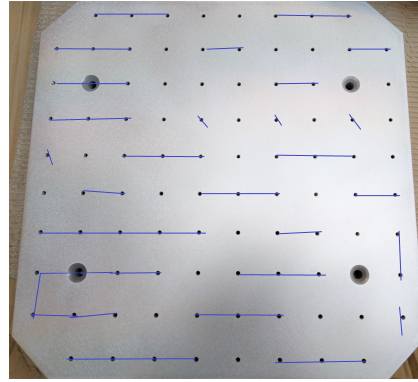

Figure 9: Movement pattern 2 - Horizontal Movement.

3 Hardware Setup

3.1 Universal Robot

The robot used in our data collection belongs to the E-series robots produced by the company Universal Robots. The UR3e collaborative robot is the smallest in the company's line up, aiming at light assembly tasks and automated workbench scenarios. The compact, table-top cobot weighs 11 kg and has a payload of 3 kg, as well as 360-degree rotation on all wrist joints, and infinite rotation on the end joint.

The UR3e can be operated and programmed both by the teach pendant, visible in Figure 1 as the front-mounted tablet, as well as remotely through different communication protocols. The software on the teach pendant is called *UR PolyScope*. The minimum UR PolyScope version used with the robot, must be 5.4 in order to operate with the OnRobot Screwdriver.

3.2 OnRobot Screwdriver

The OnRobot Screwdriver³ is a recently, as of date of this report, released out-of-the-box tool designed to seamlessly integrate with a wide range of the most popular industrial robots. Released out-of-the-box tool designed to seamlessly integrate with a wide range of the most popular industrial robots. The tool is able to automatically calculate the speed and force required for accurate and consistent screwdriving. The OnRobot Screwdriver is able to achieve torque values from 0.15 Nm to 5 Nm. One of the characteristics of this screwdriver is that it has an embedded Z-axis, or a so-called *shank*, that can be moved up and down when needed. When performing a tightening operation, the shank will gradually move down, simultaneously with the screw being tightened into the hole. This reduces the need for programming the robot arm movements and allows to fully retract the screw inside the screwdriver. The OnRobot Screwdriver handles screws up to 50 mm long and of size from M1.6 to M6. The datasheet is available at [4].

3.3 Cable Connections

The OnRobot Screwdriver connects to the UR3e using a Compute Box and ethernet cable. The Compute Box is designed to perform calculations based on force and torque measurements from the OnRobot sensor, positional information from the robot system, and commands requested on the Compute Box Robot Controller Interface (CBRCI). A tool data cable must be connected between

³<https://onrobot.com/en/products/onrobot-screwdriver>

the OnRobot Screwdriver and its compute box. An ethernet cable must be connected between the UR3e and the OnRobot Screwdriver Compute Box. To connect the PC to the UR3e and the OnRobot Screwdriver an ethernet switch was used, and the three components were connected as illustrated in Figure 10.

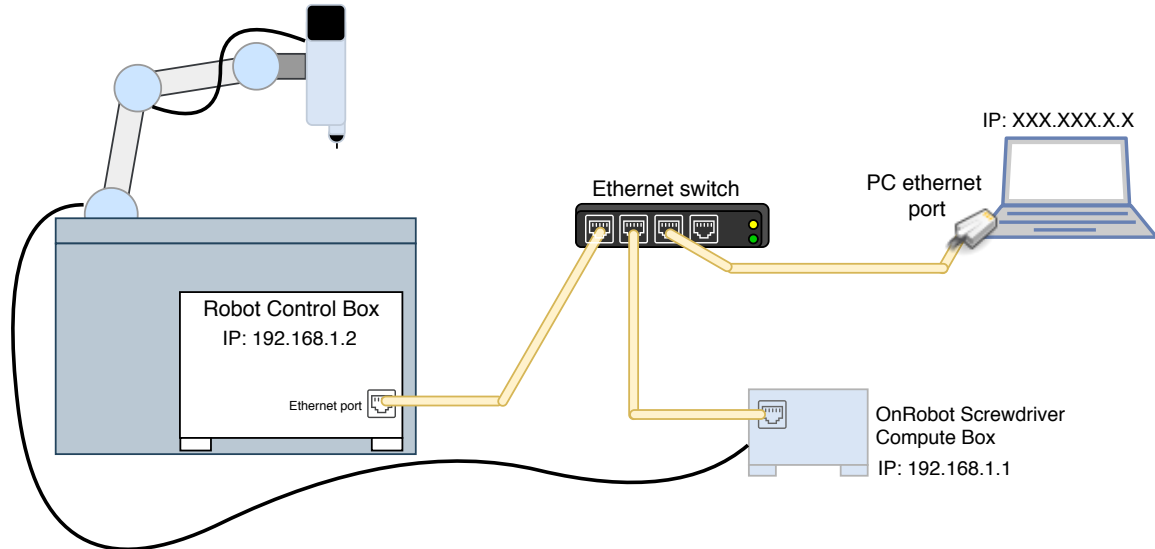

Figure 10: The cable connections between the components. The IP addresses that were used for the UR3e Control Box and the OnRobot Compute Box are also illustrated.

4 Software Setup

When creating a dataset, it is necessary to be able to interface to the different components in order to record the necessary data. In this case we also chose to control the UR3e using Remote Mode, where we connected a PC to the robot using an Ethernet cable, as illustrated in Figure 10. Controlling the UR3e using Remote Mode allowed us to define the complete program in Python, and use that to both control the robot and measure the data simultaneously, as illustrated in Figure 11. This enabled a smooth development process.

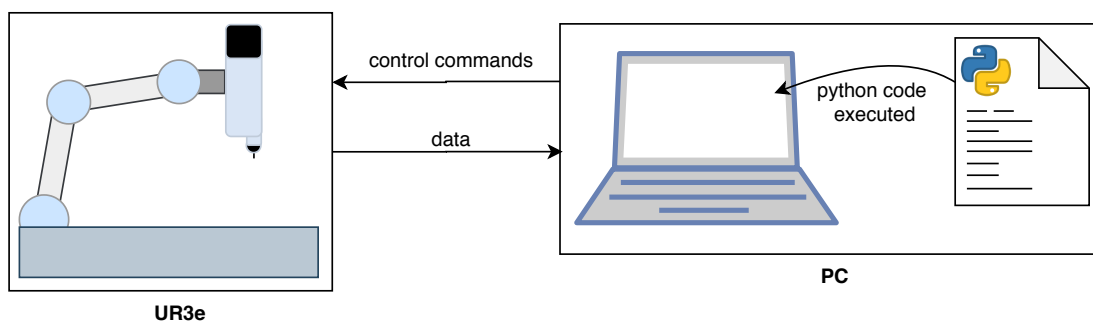

Figure 11: Exchanged data and commands between the PC and the UR3e.

In the following we describe in detail how the OnRobot Screwdriver and the UR3e were set up to communicate with a PC.

4.1 Universal Robot Controller

The UR3e can be controlled at two levels:

- the PolyScope level, and
- the UrScript level.

The UrScript programming language is a tool developed specifically for Universal robots. It allows to control the flow of control statements, and provides a set of in-built variables and function to monitor and control the robot's movements and I/O. In depth overview of the UrScript programming language as well as a description of the available functions is available at [5].

The Control Box of the UR3e contains a processor running a URControl service. The URControl service establishes a connection between the teach pendant to itself as a client. In order to control the UR3e using the Remote Mode, a PC has to be connected to the URControl as a client using a Transmission Control Protocol (TCP) or Internet Protocol (IP) socket. Having established this connection, UrScript commands can be sent to the robot in clear ASCII text.

Any language that provides the possibility to establish a TCP connection and send ASCII text through that connection can be used to control the robot. The most popular ones include Python, Java or different variants of C. Due to easily available libraries and general affinity of the authors with the Python language, it has been chosen for this work. The connection to the UR3e has been facilitated using the Python framework `urinterface`⁴.

In order to gather the data from the robot, UR3e provides a Real-Time Data Exchange protocol of the Universal Robot [6] (RTDE) protocol [6]. It provides synchronization of external applications with the UR3e controller over a TCP/IP connection, without breaking the real-time properties of the UR3e controller. The client sets up which variables are to be synchronized, and the RTDE protocol then takes care synchronization. It is important to note that the real-time properties of the controller take precedence over the RTDE interface, and in case where the controller is unable to complete both tasks some packages will be skipped by the RTDE. However, this comes into play if either the asked synchronization frequency is very high, or the UR3e controller has computationally intensive tasks.

4.2 Connection between Screwdriver and UR3e

The OnRobot Screwdriver is installed in the UR3e system as a URCap. A URCap extends the functions of the universal robot, to include specific functions related to the tool that is mounted on the robot. This extends the commands available through the teach pendant by adding screwdriver specific functions, such as:

- Tighten screw,
- Loosen screw,
- Pick screw,
- Move shank.

These functions can then be added to programs made using the teach pendant. The tighten screw function is illustrated in Figure 12.

The Compute Box can be connected to the PC using a TCP/IP connection. By doing so, the user gains access to 3 interface options. The web client, which can be used to monitor, update and, to some extent, control the device (as shown in Figure 13), a UDP connection for high-speed data reading, and a TCP connection for single or iterated data reading.

⁴<https://pypi.org/project/urinterface/>

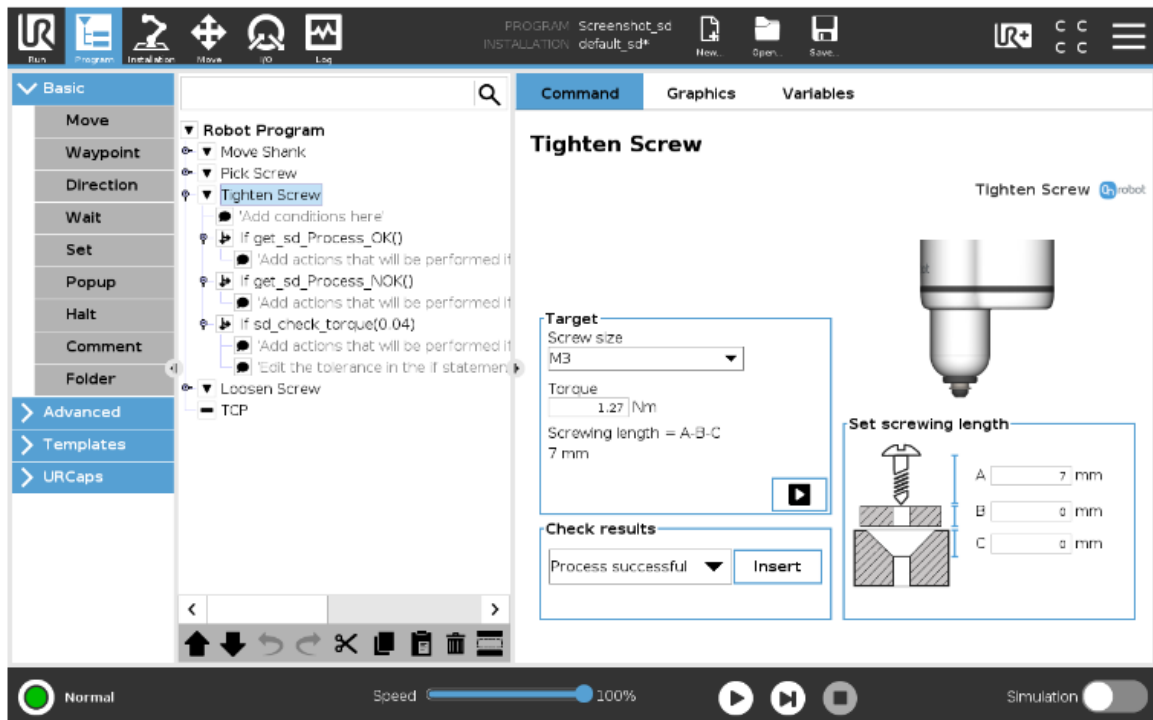

Figure 12: Program illustrating the different variables used when performing a tighten screw operation.

4.3 Connection between Laptop, UR3e and OnRobot Screwdriver

The RTDE protocol in the UR3e allows to send internal register value, which can have their values changed in the UrScript programs. The UrScript programs allow also for multithreading, meaning that assigning values to those registers can be done independently of the main program, and continuously. The solution is thus to create a program in the teach pendant for tightening, loosening and screw pick up operations. These programs operate only the screwdriver, not the robot arms. In a separate thread, they update the UR3e internal registers with all screwdriver sensor data at frequency of 100Hz.

The entire process of unscrewing and screwing can then be expressed as follows. At the beginning of the sequence, the RTDE protocol is set up to transmit data from several internal registers in addition to all the sensor data from UR3e itself. The robot is then moved to required position using commands sent through TCP connection. When the robot arrives at this location, a command is sent to load a loosening/tightening/picking up program which has been previously prepared and stored on the teach pendant. Because the program is then running directly from a file on the teach pendant, in contrast to being sent over the TCP connection, it is able to access the screwdriver functions. While this program is running, it continuously updates the UR3e internal registers with screwdriver sensors values, which are then sent in a synchronized fashion to the PC thanks to the RTDE interface. After performing the operation, the loop continues and the robot moves to the next position, it loads appropriate program and so on. Figure 14 illustrates how the program is loaded onto the teach pendant through the PC.

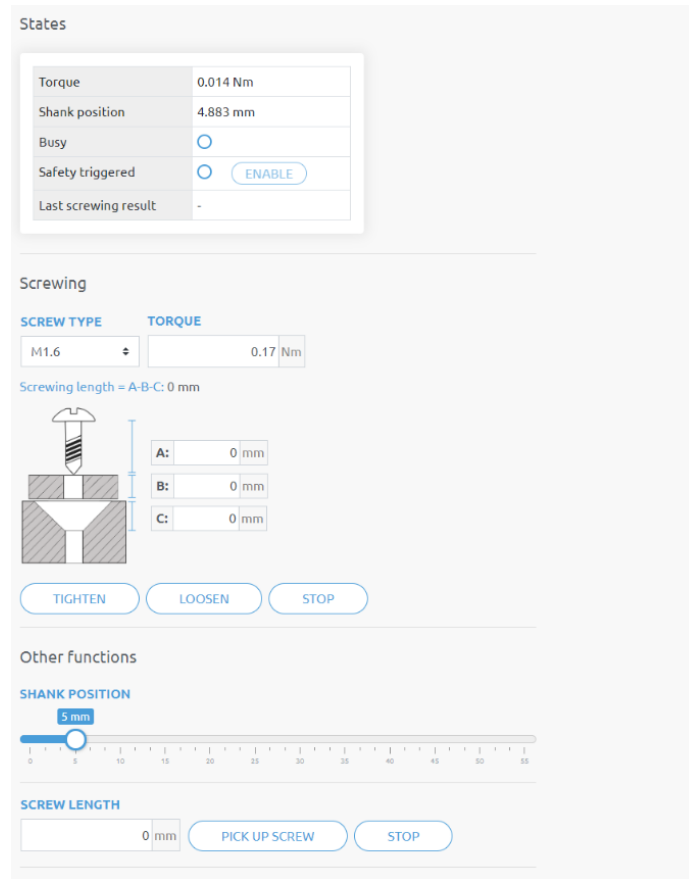

Figure 13: Screwdriver web client view.

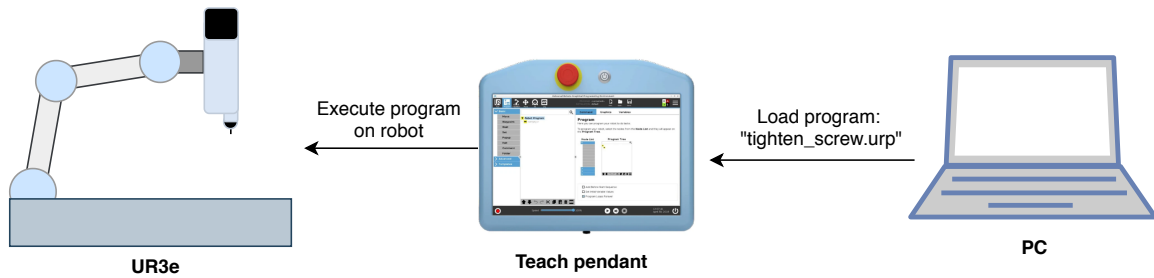

Figure 14: Illustration of how the "tighten_screw" program was loaded.

The above-described solution provides a non-elegant, but nevertheless a synchronized and reliable way to capture the data both from the UR3e and screwdriver. The downside is that the screwdriver data is not updated between the loosening/tightening/picking up operations. However, our tests showed that, as expected when the screwdriver is inactive, the only changes in the sensor data from the screwdriver while it is not operating is minor noise, so it can be omitted without lowering the quality of the dataset. The data from UR3e and screwdriver is sampled at 100Hz.

5 Creating Anomalies

These anomalies chosen for data collection are summarized in Table 2 and explained in more detail in the following subsections.

Anomaly	Description	Method
Missing screw	The screwdriver does not pick up a screw properly, and therefore there is a screw missing when performing a tighten command.	Possibility 1: the screwdriver does not loosen the screw on the from plate, but instead waits for 50ms. Possibility 2: the screwdriver fails to loosen the screw.
Extra assembly component	An extra assembly component is erroneously placed in between the screwdriver and the plate to screw on.	This anomaly is constructed by setting a washer on top of the threaded hole, to act as an extra assembly component.
Damaged screw thread	The thread of the screw is damaged. This could occur during the manufacturing process or if the screw is not shipped according to the specifications.	The screw thread is damaged using a metal file.
Damaged plate thread	The thread of the metal plate may be damaged.	The threaded plate hole is damaged by filing or chipping.

Table 2: List of anomalies included in the data set.

5.1 Missing screw anomaly

The missing screw anomaly represents the screwdriver failing to receive a screw, and then trying to perform a tighten operation without it. In industrial processes there may be multiple reasons for a screw to be missing during operation. In our data collection we chose to simulate this behaviour in two ways:

Skip loosening a screw and wait: This is done by moving the robot arm to the correct position just above the screw it is supposed to loosen, but instead of loosening, the robot waits in this position for 50 ms. The majority of the missing screw samples are created using this process.

Failure to loosen and pick up screw: This is a failure that occurred while creating the dataset. Every instance where the screwdriver failed to loosen a screw is registered and used as samples in the dataset.

The dataset focuses on screwdriving and anomalies encountered in this process and, because of that, no distinction has been made between the simulated and actual failure to pick up the screw.

5.2 Extra assembly component

The extra assembly component anomaly represents an unexpected item present on the screwdriving assembly. It could be an additional, unwanted component, a wrong type of the component etc. To represent this in our experiments, a washer is added on some screwdriving points. The setup of the screwdriver is unchanged, and it does not expect this component to be present. Figure 15 shows how the extra assembly component was set up.

5.3 Damaged screw thread

The damaged screw thread anomaly represents situations where the provided screw has damaged, sub-par or different than normal and expected thread. It could be a used or worn out screw, a screw

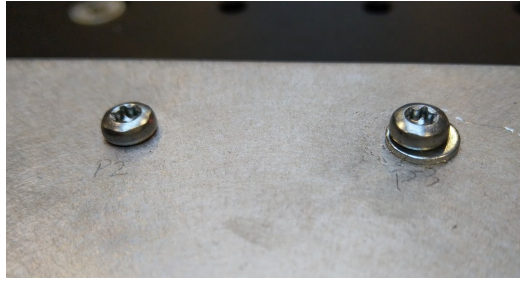

Figure 15: An example of the setup of an extra assembly component. The right screw with the washer is the anomalous sample in this case.

of sub-optimal quality, or a screw that has been damaged in some earlier process. This effect is simulated by filing down the threads on 10 screws. The threads are filed down quite aggressively in order to provide better distinction between them and the regular screws.

5.4 Damaged plate thread

The damaged plate thread anomaly represents situations where the threaded hole into which the screw has to be screwed is damaged. The damage could be caused by wear, faulty manufacturing etc. This effect is simulated partially by filing down the thread in the hole, and partially by using a hammer and chisel to chip some parts of the hole.

6 Data

The output data is stored in a hdf file. The dataset is available to download from the Zenodo website [2]. In order to facilitate easy access to the data, an accompanying Python library has been developed [3]. This library provides ways to customise the dataset according to the user's needs. The AURSAD library contains several useful functionalities for preprocessing the dataset for ML applications:

- Creating numpy training and test datasets from sampled data
- Creating a Keras TimeSeries generators for sliding window data
- Filtering the dataset
- Removing supporting columns
- 3 different types of labeling
 - 'Full' sample labeling where loosening and tightening motions are labeled together
 - 'Partial' sample labeling where loosening motion is given its own label
 - 'Tighten' sample labeling, when only the tightening parts of the whole process are labeled as normal/anomalies, loosening and movement parts of the motion get its own separate labels
- Subsampling the data
- Dimensionality reduction using PCA or ANOVA F-values
- One-hot label encoding

- Zero padding the samples to equalise their length
- Z-score standardisation

Samples are numbered according to the labeling mode selected. For labeling types 'Full' and 'Partial' each sample starts and ends at the home position.

6.1 Data structure

The gathered data contains 134 features, which are presented in Table 8 (Appendix B). The features in bold text are auxiliary features, which are by default removed from the dataset that is outputted to the user of the library. This is because these signals were intentionally added during data collection to allow for easier data manipulation and labeling in the dataset post processing stage, and are not representative of the actual data that the UR or screwdriver provide as output. Additionally, the labels for each event are present in the dataset, but they should be extracted beforehand. The recommended number of features is 125.

6.2 Data size

The size of collected data is around 6,4 GB in hdf format. Table 3 provides an overview of the statistics of the dataset.

Type	Label	Samples	Percentage
Normal operation	0	1420	70 %
Damaged screw	1	221	11 %
Extra assembly component	2	183	9 %
Missing screw	3	218	11 %
Damaged plate thread	4	3	0 %
Total		2045	100 %

Table 3: Dataset statistics.

6.3 Data examples

In this section examples of normal and anomalous data samples are illustrated. The differences between different labeling modes are also described.

Figures 16, 17, 18 and 19 present a randomly chosen sample from each class. The green liner corresponds to the readings of the screwdriver's current torque for the sample under consideration (`output_double_register_25` in the data), while the grey dotted line is the mean value of the current torque for this class. This feature has been chosen as it can be expected to show the most visible differences between the classes. The samples have been focused on the most interesting parts, and as such the figures do not show the entirety of a sample. Several hundred events before and after what is shown in these figures have been excluded in order to better illustrate differences in the data. Both the mean values for each class and the actual values from a random sample indicate that the current torque does vary a lot between the types of anomalies and normal operation.

The missing screw and extra assembly component sample values differ from their respective class mean values the most for this set of randomly chosen samples. It shows that while the differences between different classes do exist and can be seen even on a single data feature, the strong intraclass variations and interpositioning of the class mean values indicate that with different choice of samples this could have been not so visible by this one feature alone.

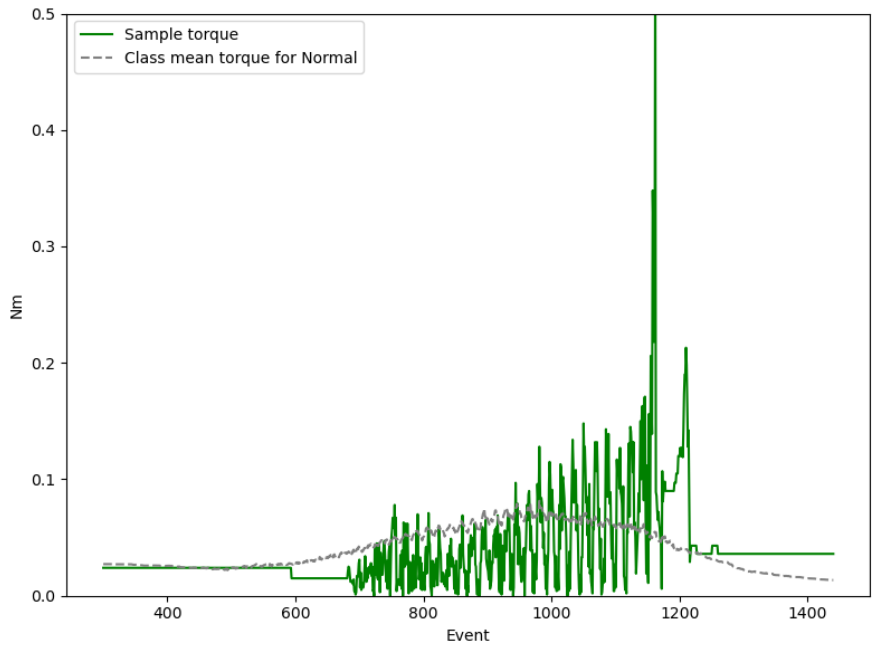

Figure 16: A normal sample.

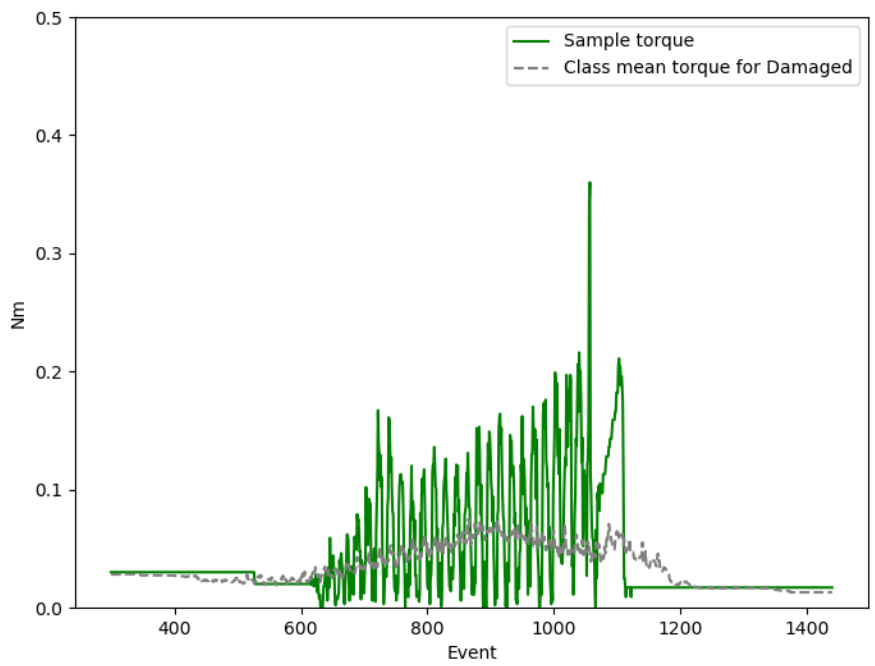

Figure 17: Example of damaged screw anomaly.

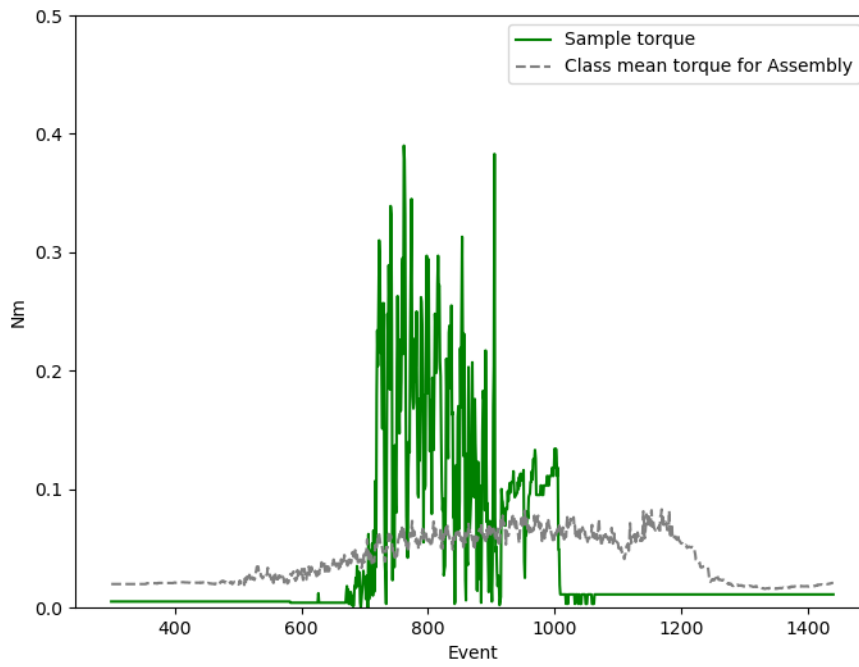

Figure 18: Example of extra assembly component anomaly.

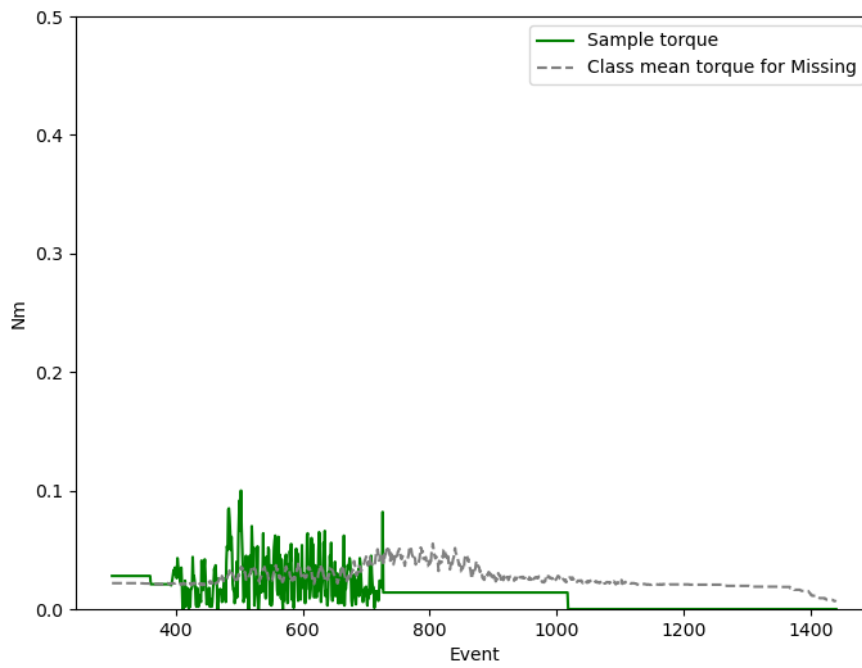

Figure 19: Example of missing screw anomaly.

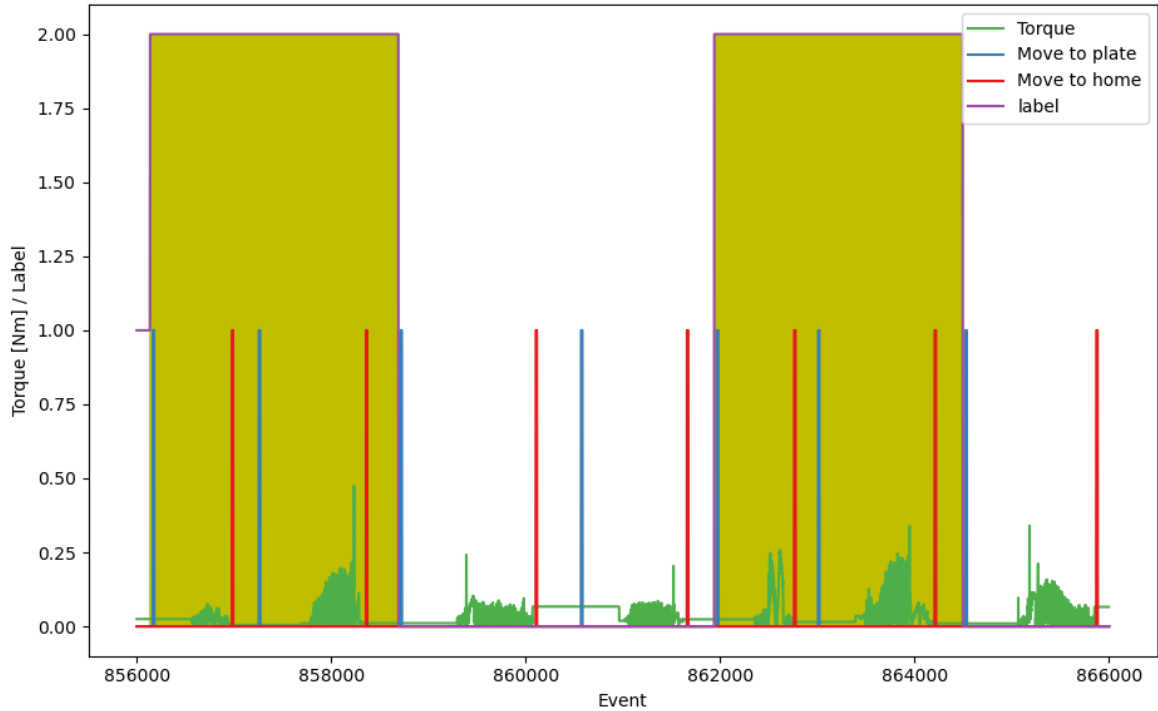

Figure 20: Group labeling of loosening and tightening.

Figures 20 and 21 illustrate the differences in labeling of the data. In Figure 20, the loosening and tightening sections of anomalies are given the same label. The yellow-colored area represents an anomalous sample. The loosening and tightening parts can be clearly distinguished. In Figure 21, the loosening sections of the screwing motion are given their own label, 5. This means that with this type of labeling the dataset contains 6 classes. The loosening samples can then be excluded from the dataset or treated as another class that the classifier needs to recognise. The yellow-colored areas show the same two anomalies as in Figure 20, but now only the tightening parts are anomalous.

7 Data experiments

To showcase an example usage of this dataset, two classification experiments have been performed. The dataset has been used in form of a set of time-series and loosening parts of the motion have been labeled separately. The loosening labels have been excluded, to focus on the classification performance on the tightening part of the motion. The damaged plate thread labels have been also excluded due to their low sample count in comparison to other classes.

The dataset contains sensor data gathered at frequency of 100Hz. This means that each screw motion consists of thousands of sampling points. As these experiments aim to only showcase the potential use of the data, the data has been sub sampled to 50Hz to allow for faster execution. In summary, the dataset version used in this experiment contains tightening motions for normal, missing screw, extra assembly component, and damaged screw thread labels, with the sampling frequency of 50Hz.

Two models have been used. The first is a 2-layer Long Short-Term Memory (LSTM) [7] network with layers consisting of 512 and 256 units and the dropout rate set at 30%. LSTM's are recurrent neural networks, which means that they have feedback properties. This means they are well-suited for operating on sequences of data, where they are able to take the temporal variation of the data

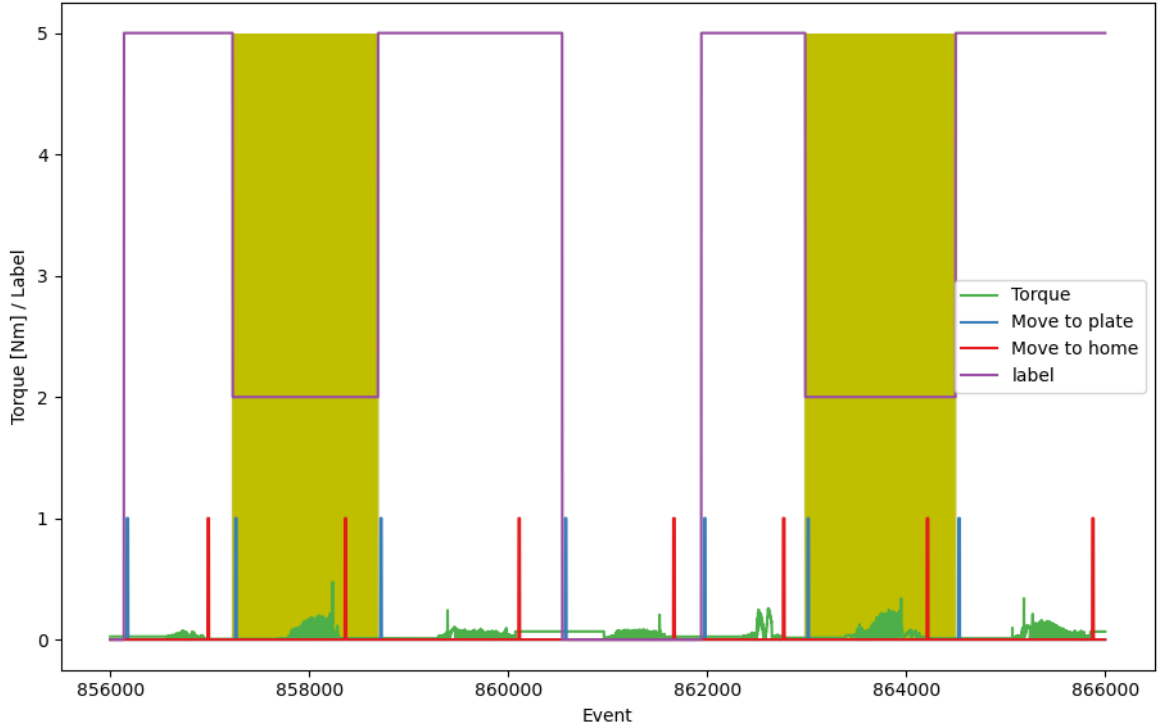

Figure 21: Separate labeling of loosening and tightening.

into account.

The second used model is a network using Bilinear and Temporal Augmented Bilinear layers [8]. This architecture makes use of the bilinear projection as well as an attention mechanism that enables it to recognise and place greater importance on key temporal information.

7.1 Experiment 1 - Raw data

In this experiment the input data is not processed in any way and all 125 dimensions are used. The classification results can be seen in Tables 4 and 5. The average F1 score for the LSTM classifier is 4.79 % and for the TABL classifier is 43.11 %. The low score for LSTM classifier was consistent across several different pure LSTM topologies. Figure 22 presents the confusion matrices for both classifiers, while Figure 23 shows the Area Under the Curve - Receiver Operating Characteristics curves.

Label	Accuracy	Precision	Recall	F1
0	0.106	0	0	0
1	0.106	0	0	0
2	0.106	0	0	0
3	0.106	0.106	1	0.250

Table 4: Classification metrics for LSTM network on raw data.

The confusion matrix for the LSTM classifier, Figure 22a, reinforces the conclusions drawn from the classification metrics in table 4. The network classifies all samples as belonging to the missing

Label	Accuracy	Precision	Recall	F1
0	0.518	0.820	0.535	0.647
1	0.518	0.068	0.063	0.065
2	0.518	0.099	0.405	0.160
3	0.518	0.891	0.891	0.852

Table 5: Classification metrics for TABL network on raw data.

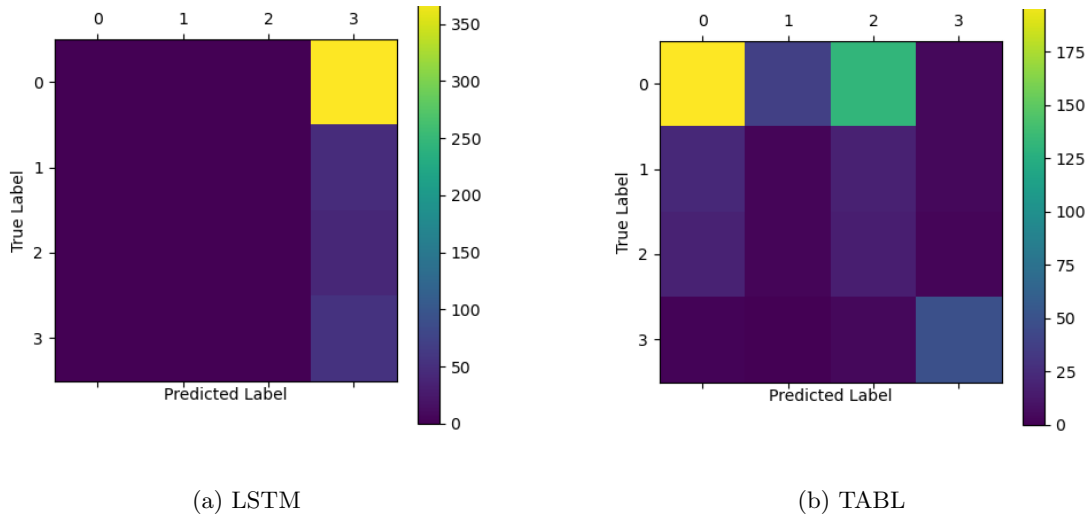

Figure 22: Confusion matrix comparison on raw data.

screw anomaly class. The TABL classifier, Figures 22b and 23b, struggles mostly with distinguishing between normal samples as extra assembly or damaged screw anomalies.

7.2 Experiment 2 - Processed data

In this experiment a standard dimensionality reduction technique, Principal Component Analysis (PCA) [9], was applied to reduce the dimensionality of the data from 125 to 60 dimensions. Dimensionality reduction techniques aim to discard the least important dimensions. Different techniques use different criteria for performing dimensionality reduction, with PCA adopting the minimum reconstruction error criterion. Apart from possibly alleviating the problem of the too many dimensions, as a side effect it also reduces the computational cost of the methods applied on the resulting reduced-dimensional data.

The classification results can be seen in Tables 6 and 7 for the LSTM and the TABL networks, respectively. Figure 24 presents the confusion matrices for both classifiers, while Figure 25 shows the Area Under the Curve - Receiver Operating Characteristics curves. The average F1 score for the LSTM classifier is 44.68 % and for the TABL classifier is 71.02 %.

7.3 Discussion

The experiments show that, at least for classification tasks, the 125 dimensions that the raw dataset contains, may need to be reduced for successful classification task. The TABL classifier, which employs a temporal attention mechanism, was able to perform adequately well, but the generic LSTM network, which lacks such mechanism, failed completely. After reducing the dimensionality

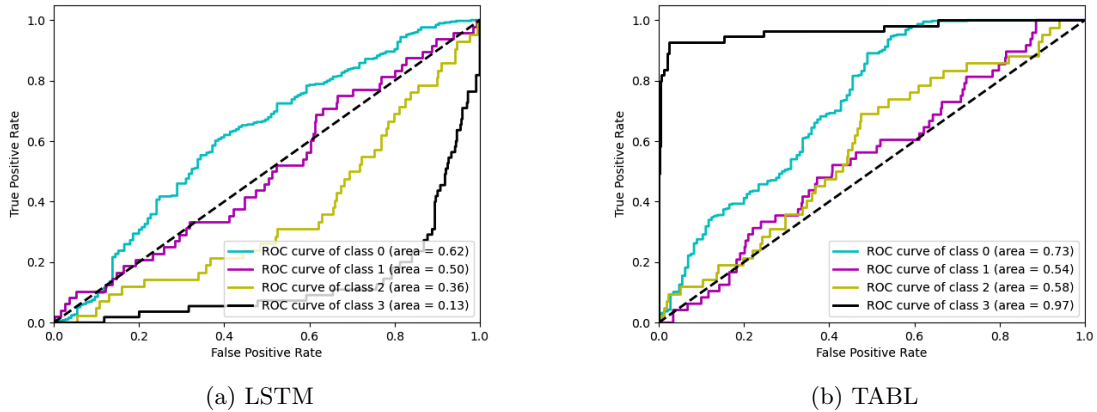

Figure 23: AUC-ROC comparison on raw data

Label	Accuracy	Precision	Recall	F1
0	0.526	0.872	0.508	0.642
1	0.526	0.191	0.271	0.224
2	0.526	0.142	0.5	0.221
3	0.526	0.576	0.891	0.7

Table 6: Classification metrics for LSTM network on low-dimensional data.

using the PCA the classification results improved drastically for both classifiers. The results of the experiments show also that the most distinctive anomaly is that of a missing screw. In almost all cases the missing screw anomaly was able to be distinguished from normal operation.

8 Conclusion

We presented a novel screwdriving dataset, which to our knowledge is the first dataset with measured data from a robotic screwdriver combined with both normal and faulty operations. We described the process of creating a Machine Learning dataset, with focus on avoiding biases in the collected data by using different variations of the experimental setup. The high sampling rate coupled with collecting all available data from the robot means that the resulting dataset can be used for various tasks. While it has been developed with the aim of being used for training Machine Learning models, it could prove useful in also modelling the screwdriving process, as the dataset contains the entirety of the robot sensor indications.

References

- [1] John Sprovieri. *New Technology for Automatic Screwdriving*. <https://www.assemblymag.com/articles/95431-new-technology-for-automatic-screwdriving>. Accessed: 24-11-2020.
- [2] *AURSAD dataset*. <https://zenodo.org/record/4487073>. Accessed: 01-02-2021.
- [3] *AURSAD python library*. <https://pypi.org/project/aurasad/>. Accessed: 01-02-2021.
- [4] *Datasheet: Screwdriver*. https://onrobot.com/sites/default/files/documents/Datasheet_Screwdriver_v1.1_ENGLISH.pdf. Accessed: 24-11-2020.

Label	Accuracy	Precision	Recall	F1
0	0.832	0.882	0.901	0.892
1	0.832	0.533	0.521	0.526
2	0.832	0.528	0.452	0.487
3	0.832	0.944	0.927	0.936

Table 7: Classification metrics for TABL network on low-dimensional data.

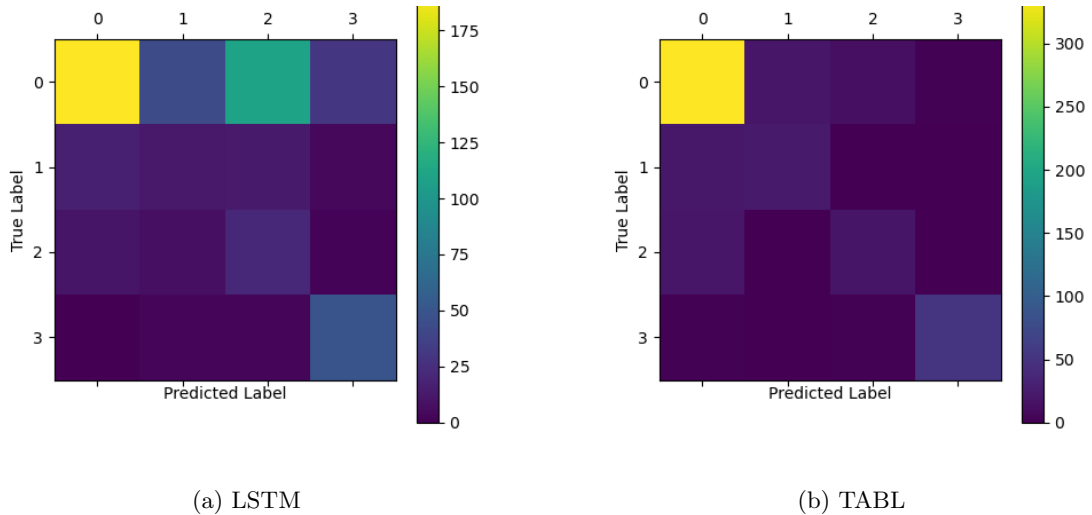
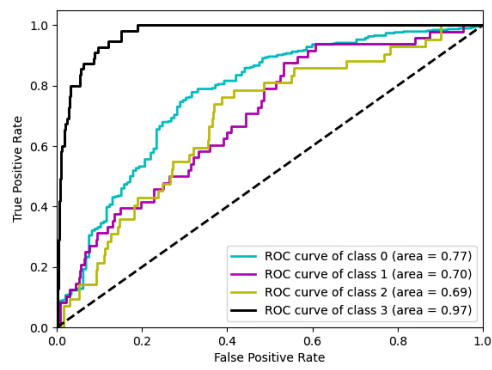
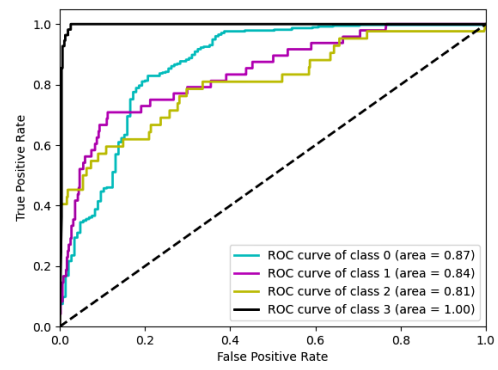

Figure 24: Confusion matrix comparison on reduced data

- [5] *The URScript Programming Language*. <https://s3-eu-west-1.amazonaws.com/ur-support-site/55568/scriptManual.pdf>. Accessed: 24-11-2020.
- [6] *Real-Time Data Exchange (RTDE) Guide*. <https://www.universal-robots.com/articles/ur/real-time-data-exchange-rtde-guide/>. Accessed: 24-11-2020.
- [7] Felix A Gers, Jürgen Schmidhuber, and Fred Cummins. “Learning to forget: Continual prediction with LSTM”. In: *Neural Computation* 12.10 (Accessed 2000), pp. 2451–2471. ISSN: 08997667. DOI: 10.1162/089976600300015015.
- [8] Dat Thanh Tran, Alexandros Iosifidis, Juho Kannianen, et al. “Temporal Attention augmented Bilinear Network for Financial Time-Series Data Analysis”. In: *IEEE Transactions on Neural Networks and Learning Systems* 30.5 (Accessed Dec. 2017), pp. 1407–1418. DOI: 10.1109/TNNLS.2018.2869225.
- [9] Hervé Abdi and Lynne J. Williams. “Principal component analysis”. In: *Wiley Interdisciplinary Reviews: Computational Statistics* 2.4 (Accessed July 2010), pp. 433–459. ISSN: 19395108. DOI: 10.1002/wics.101. <http://doi.wiley.com/10.1002/wics.101>.
- [10] *UR3e Collaborative Robot*. <https://www.universal-robots.com/products/ur3-robot/>. Accessed: 02-12-2020.



(a) LSTM



(b) TABL

Figure 25: AUC-ROC comparison on reduced data

Appendices

A Potential Issues

The UDP connection is ideal for the purpose of gathering synchronized, high frequency data from the screwdriver. Unfortunately, at the moment of writing the UDP connection is not available for the screwdriver. This means that the only possible way to obtain the sensor data directly from the compute box is through scraping the web client, which only provides a fraction of the total sensor readings, or to repeatedly send commands over the TCP connection. This, however, is unreliable and provides no easy means to verify the synchronization of the received data in relation to the rest of the robot sensors. The details of the TCP commands were found in the OnRobot connectivity guide which was sent to the authors after enquiring OnRobot. The lack of UDP connectivity, together with lack of sufficient documentation regarding the screwdriver, meant that finding a way to reliably transfer the data from the screwdriver to the PC proved to be a considerable challenge.

As highlighted above, the lack of UDP implementation for the screwdriver meant that directly accessing the screwdriver data through the Compute Box was not possible in a synchronized manner with high speed. The only protocol available that fulfills these criteria is the RTDE protocol for Universal Robots. This protocol, however, is able to only directly access and transmit the UR3e sensor data, not the data from the screwdriver sensors. And as the Compute Box and the screwdriver are able to sustain only one real-time connection at a time, and this connection is used for UR3e-screwdriver communication, this avenue was also closed.

Furthermore, during testing it turned out that controlling the screwdriver remotely poses another challenge. The UrCap functionality, which is accessible through the teach pendant, was not accessible remotely. The UR3e recognised functions such as tighten screw, loosen screw etc. when they were directly programmed on the teach pendant only. Sending those commands through the UR-PC TCP connection was thus impossible, as the UR3e did not recognise them this way. The UrScript program could be sent to the UR3e from PC through a TCP connection, but this program would be then unable to access the screwdriver functions.

Using the Modbus TCP connection between the PC and screwdriver was also unreliable, with some functions (like tighten or loosen) working fine, while others (notably move the shank function) failing to work at all. This issue meant that while the UR3e could be controlled directly from the PC, the screwdriver could not be controlled remotely with enough reliability and proper functionality, as required for gathering this dataset. Additionally, even if such operation could be achieved, the inability to collect the data directly from the screwdriver deemed direct control of the screwdriver irrelevant.

After many attempts following different approaches, a solution described in section 4.2 was found.

B Data structure

Feature	Description	Data type
timestamp	Measurement ime	float32
target_q_0..5	Target joint positions	float32
target_qd_0..5	Target joint velocities	float32
target_qdd_0..5	Target joint accelerations	float32
target_current_0..5	Target joint currents	float32
target_moment_0..5	Target joint moments (torques)	float32
actual_q_0..5	Actual joint positions	float32
actual_qd_0..5	Actual joint velocities	float32
actual_current_0..5	Actual joint currents	float32
actual_control_output_0..5	Joint control currents	float32
actual_TCP_pose_0..5	Actual Cartesian coordinates of the tool	float32
actual_TCP_speed_0..5	Actual speed of the tool in Cartesian coordinates	float32
actual_TCP_force_0..5	Generalized, compensated forces in the TCP	float32
target_TCP_pose_0..5	Target Cartesian coordinates of the tool	float32
target_TCP_speed_0..5	Target speed of the tool in Cartesian coordinates	float32
actual_digital_input_bits	Current state of the digital inputs	int8
joint_temperatures_0..5	Temperature of each joint	float32
actual_execution_time	Controller real-time thread execution time	float32
robot_mode		int8
joint_mode_0..5		int16
safety_mode		int8
actual_tool_accelerometer_0..2	Tool x, y and z accelerometer values	float32
speed_scaling	Speed scaling of the trajectory limiter	float32
target_speed_fraction		float32
actual_momentum	Norm of Cartesian linear momentum	float32
actual_main_voltage	Safety Control Board: Main voltage	float32
actual_robot_voltage	Safety Control Board: Robot voltage (48V)	float32
actual_robot_current	Safety Control Board: Robot current	float32
actual_joint_voltage_0..5	Actual joint voltages	float32
actual_digital_output_bits	Current state of the digital outputs.	int8
runtime_state	Program state	int8
output_int_register_24	Screwdriver command result	int8
output_int_register_25	Pin number on to plate	int8
output_int_register_26	Pin number on from plate	int8
output_double_register_24	Screwdriver achieved torque	float32
output_double_register_25	Screwdriver current torque	float32
output_double_register_26	Screwdriver target torque	float32
output_double_register_27	Screwdriver target torque gradient	float32
output_bit_register_64	Movement to pin poistion	bool
output_bit_register_65	Movement to home position	bool
output_bit_register_66	Screw loosening	bool
output_bit_register_67	Screw tightening	bool
output_bit_register_70	Screwdriver busy	bool
output_bit_register_71	Screwdriver process not ok	bool
output_bit_register_72	Screwdriver process ok	bool
label		int8
sample_nr		int8

Table 8: Data features description

C Plates

The plates used as the screwdriving targets are identical. They are 40 cm wide and 40 cm long. Each plate contains 92 threaded holes.

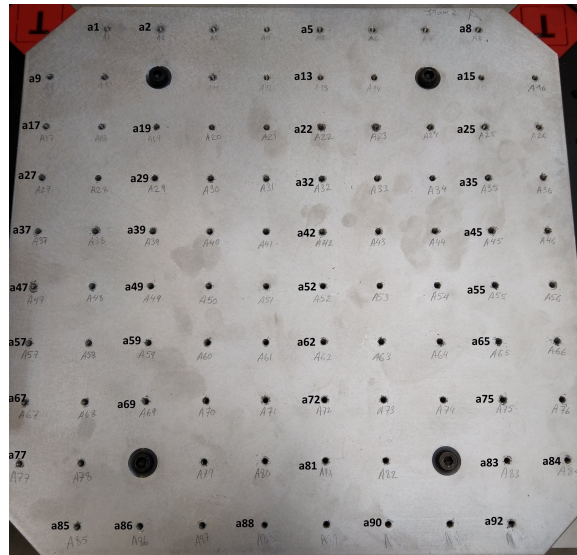

Figure 26: Plate A.

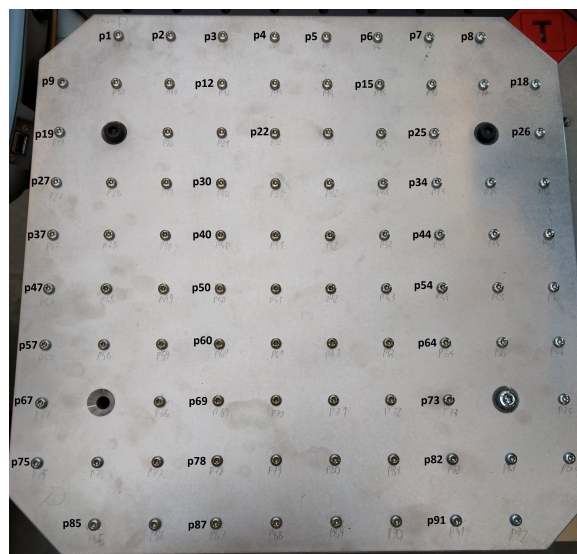

Figure 27: Plate P.