

GEODESIC LENGTH AND SHIFTED WEIGHTS IN FIRST-PASSAGE PERCOLATION

ARJUN KRISHNAN, FIRAS RASSOUL-AGHA, AND TIMO SEPPÄLÄINEN

ABSTRACT. We study first-passage percolation through related optimization problems over paths of restricted length. The path length variable is in duality with a shift of the weights. This puts into a convex duality framework old observations about the convergence of the normalized Euclidean length of geodesics due to Hammersley and Welsh, Smythe and Wierman, and Kesten, and leads to new results about geodesic length and the regularity of the shape function as a function of the weight shift. For points far enough away from the origin, the ratio of the geodesic length and the ℓ^1 distance to the endpoint is uniformly bounded away from one. The shape function is a strictly concave function of the weight shift. Atoms of the weight distribution generate singularities, that is, points of nondifferentiability, in this function. We generalize to all distributions, directions and dimensions an old singularity result of Steele and Zhang for the planar Bernoulli case. When the weight distribution has two or more atoms, a dense set of shifts produce singularities. The results come from a combination of the convex duality, the shape theorems of the different first-passage optimization problems, and modification arguments.

CONTENTS

1. Introduction	2
1.1. Stochastic growth models	2
1.2. First-passage percolation and its limit shape	3
1.3. Differentiability and length of geodesics	3
1.4. Duality of path length and weight shift	4
1.5. Euclidean length of geodesics	5
1.6. Regularity of the shape function as a function of the weight shift	5
1.7. Organization of the paper	5
1.8. Further literature: convergence of empirical measures	5
1.9. Notation and conventions	6
1.10. Acknowledgements	6
2. The models and the main results	6
2.1. Setting	6
2.2. Standard first-passage percolation	7
2.3. Restricted path-length first-passage percolation	11
2.4. Duality of the weight shift and geodesic length	16
3. Open problems	18

Submitted August 19, 2021. Revised January 23, 2023. Accepted February 9, 2023.

2020 *Mathematics Subject Classification.* 60K35, 60K37.

Key words and phrases. Approximate geodesic, convex duality, first-passage percolation, geodesic, path length, shape function, weight shift.

A. Krishnan was partially supported by a Wiley Assistant Professorship at University of Utah, an AMS-Simons Travel Grant, and Simons Collaboration grant 638966.

F. Rassoul-Agha was partially supported by National Science Foundation grants DMS-1811090 and DMS-2054630.

T. Seppäläinen was partially supported by National Science Foundation grants DMS-1854619 and DMS-2152362 and by the Wisconsin Alumni Research Foundation.

3.1. Asymptotic length of geodesics	18
3.2. Properties of the shape functions	19
3.3. Duality of the weight shift and geodesic length for real-valued weights	19
3.4. Modification arguments for real weights	19
3.5. General perturbations of weights	19
4. The shape functions and lengths of optimal paths	19
5. Modification proofs for strict concavity	26
5.1. Preparation for the modification arguments	26
5.2. Strict concavity	28
6. Modification proofs for nondifferentiability	44
7. Proofs of the main theorems	50
7.1. Strict concavity, derivatives, and geodesic length	50
7.2. Nondifferentiability	53
Appendix A. First-passage percolation with slightly negative weights	54
Appendix B. Restricted path length shape theorem	59
Appendix C. Peierls argument	70
Appendix D. Convex analysis	72
References	73

1. INTRODUCTION

1.1. Stochastic growth models. Irregular and stochastic growth surrounds us, for example in tumors, bacterial colonies, infections, spread of fluid in a porous medium, and propagating flame fronts. These phenomena attract the attention of mathematicians, scientists and engineers in various disciplines. Simplified mathematical models of stochastic growth have been studied in probability theory for over half a century. This work has inspired some of the central innovations of modern probability, such as the subadditive ergodic theorem, and created new connections between probability and other parts of mathematics, such as representation theory, integrable systems, and partial differential equations.

A class of much-studied stochastic growth models possess a metric-like structure where growth progresses along paths that optimize an energy functional defined in terms of a random environment. Depending on whether the optimal path is chosen through minimization or maximization, these models are called first-passage percolation and last-passage percolation.

A variety of settings for first- and last-passage percolation are studied. The admissible paths can be general or they can be restricted to be directed along some spatial directions. The underlying space can be a graph, the continuum, or a mixture of the two. In the graph case, the environment is given by random weights attached to the vertices or the edges. The most typical choice of graph is the d -dimensional integer lattice \mathbb{Z}^d . The one-dimensional case usually reduces to classical probability so the real work begins from the planar case $d = 2$.

Much progress in the planar case has taken place over the past 25 years under the rubric *Kardar-Parisi-Zhang universality*. A universal planar continuum limit, the directed landscape, has recently been constructed [8]. It is expected to be the scaling limit of a wide class of planar first- and last-passage percolation models, but this remains conjectural at present. Evidence for the universality comes from proofs that certain special exactly solvable directed models converge to the directed landscape [9]. We refer the reader to articles [4, 6] and the monograph [2] for general introductions to the field.

Our paper studies first-passage percolation with undirected paths on the integer lattice in arbitrary dimension. This has proved to be, in a sense, the most challenging model, as no exactly solvable

version has been discovered. A proof that this model lies in the KPZ class, while universally expected, appears well beyond reach in the current state of the field. Our results concern properties of the geodesics and the regularity of the limiting norm as we perturb the random weights by a common additive constant. We turn to discuss the background.

1.2. First-passage percolation and its limit shape. In *first-passage percolation* (FPP) a random pseudometric is defined on \mathbb{Z}^d by $T_{x,y} = \inf_{\pi} \sum_{e \in \pi} t(e)$ where the $\{t(e)\}$ are nonnegative, independent and identically distributed (i.i.d.) random weights on the nearest-neighbor edges between vertices of \mathbb{Z}^d and the infimum is over self-avoiding paths π between the two points x and y . A minimizing path is called a *geodesic* between x and y . FPP was introduced by Hammersley and Welsh [12] in 1965 as a simplified model of fluid flow in an inhomogeneous medium. A precise technical definition of the model comes in Section 2.

The fundamental questions of FPP concern the behavior of the passage times $T_{x,y}$ and the geodesics as the distance between x and y grows. At the level of the law of large numbers, under suitable hypotheses, normalized passage times converge with probability one: $n^{-1}T_{0,x_n} \rightarrow \mu(\xi)$ as $n \rightarrow \infty$, whenever $n^{-1}x_n \rightarrow \xi \in \mathbb{R}^d$. The special case $\mu(\mathbf{e}_1) = \lim_{n \rightarrow \infty} n^{-1}T_{0,ne_1}$ of the limit is also called the *time constant*.

The limiting *shape function* μ is a norm that characterizes the asymptotic shape of a large ball. Define the randomly growing ball in \mathbb{R}^d for $t \geq 0$ by $B(t) = \{x \in \mathbb{R}^d : T_{0,[x]} \leq t\}$ where $[x] \in \mathbb{Z}^d$ is obtained from $x \in \mathbb{R}^d$ by taking integer parts coordinatewise. Under the right assumptions, as $t \rightarrow \infty$ the normalized ball $t^{-1}B(t)$ converges to the unit ball $\mathcal{B} = \{\xi \in \mathbb{R}^d : \mu(\xi) \leq 1\}$ defined by the norm μ .

The shape function μ is not explicitly known in any nontrivial example. Soft properties such as convexity, continuity, positive homogeneity, and $\mu(\xi) > 0$ for $\xi \neq \mathbf{0}$ when zero-weight edges are subcritical, are readily established. But anything beyond that, such as strict convexity or differentiability, remain conjectural. The only counterexample to this state of affairs is the classic Durrett-Liggett [10] planar flat edge result, sharpened by Marchand [15], and then extended by Auffinger and Damron [1] to include differentiability at the boundary of the flat edge.

The FPP shape theorem occupies a venerable position as one of the fundamental results of the subject of random growth models and as an early motivator of subadditive ergodic theory. The reader is referred to the monograph [2] for a recent overview of the known results and open problems.

1.3. Differentiability and length of geodesics. The success of the shape theorem contrasts sharply with the situation of another natural limit question, namely the behavior of the normalized Euclidean length (number of edges) of a geodesic as one endpoint is taken to infinity. No useful subadditivity or other related property has been found. This issue has been addressed only a few times over the 55 years of FPP study and the results remain incomplete.

The fundamental observation due to Hammersley and Welsh is the connection between (i) the limit of the normalized length of the geodesic and (ii) the derivative of the shape function as a function of a weight shift. For $h \in \mathbb{R}$ let $\mu^{(h)}(\xi)$ denote the shape function for the shifted weights $\{t(e) + h\}$. Let $\underline{L}_{0,x}^{(h)}$ be the minimal Euclidean length of a geodesic from the origin to the point x for the shifted weights $\{t(e) + h\}$. Then the important fact is that when $n^{-1}x_n \rightarrow \xi$,

$$(1.1) \quad \lim_{n \rightarrow \infty} n^{-1} \underline{L}_{0,x_n}^{(h)} = \left. \frac{\partial \mu^{(s)}(\xi)}{\partial s} \right|_{s=h}$$

provided the derivative at h on the right-hand side exists.

The shape function $\mu^{(h)}(\xi)$ is a concave function of h and hence the derivative in (1.1) exists and the limit holds for all but countably many shifts h . But since the time constant itself remains a mystery, not a single specific nontrivial case where this identity holds has been identified. The first

results on the size of the set of exceptional h at which the derivative on the right fails are proved in the present paper and summarized in Sections 1.5 and 1.6 below.

Here is a brief accounting of the history of (1.1).

Hammersley and Welsh (Theorem 8.2.3 in [12]) gave the first version of (1.1). It was proved for the time constant of planar FPP, so for $d = 2$ and $\xi = \mathbf{e}_1$, and for the particular sequence $x_n = (n, 0)$. Their result applied to the geodesic of the so-called cylinder passage time from $(0, 0)$ to $(n, 0)$, and the mode of convergence in (1.1) was convergence in probability.

The limit (1.1) was improved in 1978 by Smythe and Wierman (Theorem 8.2 in [18]) and in 1980 by Kesten [13], in particular from convergence in probability to almost sure convergence. The ultimate version has recently been established by Bates (Theorem 1.25 in [3]): almost sure convergence in (1.1) without any moment assumptions on the weights, in all directions ξ , provided the derivative on the right exists.

A handful of precise results related to (1.1) exist in specific situations defined by criticality in percolation. Let p_c denote the critical probability of Bernoulli bond percolation on \mathbb{Z}^d . When $\mathbb{P}(t(e) = 0) \geq p_c$ the FPP problem becomes in a sense degenerate. Geodesics to far-away points can take advantage of long paths of zero-weight edges and the shape function μ becomes identically zero.

Zhang [21] proved in 1995 that in the supercritical case defined by $\mathbb{P}(t(e) = 0) > p_c$, for $\xi = \mathbf{e}_1$ and $h = 0$, the limit on the left in (1.1) exists and equals a nonrandom constant. In the planar critical case, that is, $d = 2$, $\mathbb{P}(t(e) = 0) = 1/2 = p_c$ and $h = 0$, Damron and Tang [7] proved that the left-hand side in (1.1) blows up in all directions ξ .

In 2003 Steele and Zhang [19] proved the first, and before the present paper the only, precise result about the derivative in (1.1), valid for subcritical planar FPP with Bernoulli weights. When the distribution is $\mathbb{P}(t(e) = 0) = p = 1 - \mathbb{P}(t(e) = 1)$, there exists $\delta > 0$ such that, if $\frac{1}{2} - \delta \leq p < \frac{1}{2}$, $d = 2$ and $\xi = \mathbf{e}_1$, then the derivative in (1.1) fails to exist at $h = 0$. Thus the Hammersley-Welsh differentiability criterion for the convergence of normalized geodesic length faces a limitation.

1.4. Duality of path length and weight shift. We move on to describe the contents of our paper. To investigate (1.1) and more broadly properties of geodesic length, we develop a convex duality between the weight shift h and a parameter that captures the asymptotic length of a path. This puts the limit (1.1) into a convex-analytic framework. To account for the possibility of nondifferentiability in (1.1), we enlarge the class of paths considered from genuine geodesics to $o(n)$ -approximate geodesics. These are paths whose endpoints are order n apart and whose passage times are within $o(n)$ of the optimal passage time. Through these we can capture the entire superdifferential of the shape function as a function of the shift h .

To be able to work explicitly with the path-length parameter, we introduce a version of FPP that minimizes over paths with a given number of steps but drops the requirement that paths be self-avoiding (Section 2.3). A further useful variant of the restricted path length FPP process allows zero-length steps that do not increase the passage time. The shape functions g and g^o of these altered models are no longer positively homogeneous, but they turn out to be continuously differentiable along rays from the origin (Theorem 2.16).

The restricted path length shape functions g and g^o are connected with the FPP shape function μ in several ways. A key fact is that g and g^o agree with μ on certain subsets of \mathbb{R}^d described by positively homogeneous functions that are connected with geodesic length (Theorems 2.11 and 2.16). Second, g and g^o generate μ as the maximal positively homogeneous convex function dominated by g and g^o (Remark 2.15). Third, g and g^o contain the information for generating all the shifts $\mu^{(h)}$ through convex duality (Theorem 2.17 and Remark 2.18).

From this setting we derive two types of main results for FPP: results on the Euclidean length of geodesics and on the regularity of the shape function as a function of the weight shift, briefly summarized in the next two paragraphs. The proofs come through a combination of

- (i) versions of the van den Berg-Kesten modification arguments [20],
- (ii) the convex duality (Theorem 2.17), and
- (iii) a shape theorem for the altered FPP models (Theorem 2.9 and Theorem B.1 in Appendix B).

Our results are valid on \mathbb{Z}^d in all dimensions $d \geq 2$, under the standard moment bound needed for the shape theorem and the assumption that the minimum of the edge weight $t(e)$ has probability strictly below p_c .

1.5. Euclidean length of geodesics. One of our fundamental results is that with probability one, all geodesics from the origin to far enough lattice points x have length at least $(1 + \delta)|x|_1$ for a fixed constant $\delta > 0$ (Theorem 2.5). The equality in (1.1) between the limiting normalized length of the geodesic and the derivative of the shape function, which is conditional on the existence of these quantities, is generalized to an unconditional identity between the entire interval of the asymptotic normalized lengths of the $o(n)$ -approximate geodesics and the superdifferential of the shape function as a function of the weight shift (Theorem 2.17). When the random weight $t(e)$ has an atom at zero or at least two atoms that satisfy suitable linear relations with integer coefficients, there are multiple geodesics whose lengths vary on the same scale as the distance between the endpoints (Theorem 2.6). For any weight distribution with at least two atoms, this happens on a countable dense set of shifts (Theorem 2.7).

1.6. Regularity of the shape function as a function of the weight shift. A second suite of main results concerns the regularity of the shape function $\mu^{(h)}(\xi)$ as a function of the weight shift h , in a fixed spatial direction $\xi \in \mathbb{R}^d \setminus \{\mathbf{0}\}$. This function is *strictly concave* in h (Theorem 2.2). In the situations where the atoms of $t(e)$ bring about geodesics whose asymptotic normalized lengths vary, the concave function $h \mapsto \mu^{(h)}(\xi)$ acquires points of nondifferentiability. In particular, there is a countable dense set of these singularities whenever the edge weight has two atoms (Theorems 2.6 and 2.7). We extend the Steele-Zhang nondifferentiability result [19] mentioned above to all dimensions, all directions ξ , and all distributions with an atom at the origin. Furthermore, we disprove their conjecture that $h = 0$ is the only nondifferentiability point in the Bernoulli case (Remark 2.8).

1.7. Organization of the paper. Section 2 describes the models and the main results. Section 3 describes open problems that arise from this work.

The proofs are divided into four sections. Section 4 develops soft results about the relationships between the different shape functions and the Euclidean lengths of optimal paths. The main technical Sections 5 and 6 contain the modification arguments. The final Section 7 combines the results from Sections 4, 5 and 6 to prove the main theorems.

Four appendixes contain auxiliary results that rely on standard material. Appendix A extends the FPP shape function to weights that are allowed small negative values. Appendix B proves a shape theorem for the restricted path length versions of FPP. Appendix C contains the Peierls argument that sets the stage for the modification proofs. Appendix D presents a lemma about the subdifferentials of convex functions.

1.8. Further literature: convergence of empirical measures. We close this introduction with a mention of a significant recent extension to the differentiability approach to limits along geodesics, due to Bates [3]. By representing the weights as functions $t(e) = \tau(U_e)$ of uniform random variables, one can consider perturbations $\tilde{t}(e) = \tau(U_e) + \psi(U_e)$ of the weights and differentiate the shape function in directions ψ in infinite dimensions. This way the limit in (1.1) can be upgraded to convergence of the empirical distribution of weights along a geodesic, again whenever the required derivative exists. This holds for various uncountable dense collections of weight distributions, exactly as (1.1) holds for an uncountable dense set of shifts h .

These more general limit results continue to share the fundamental shortcoming of the limit in (1.1), namely, that no particular nontrivial case can be identified where the limit holds. If $\mathbb{P}(t(e) = 0) \geq p_c$ the empirical measure along a geodesic converges trivially to a pointmass at zero.

Finding extensions of our results to the general perturbations of [3] presents an interesting open problem.

1.9. Notation and conventions. Here is notation that the reader may wish quick access to. $\mathbb{Z}_+ = \{0, 1, 2, 3, \dots\}$, $\mathbb{N} = \{1, 2, 3, \dots\}$, and $\mathbb{R}_+ = [0, \infty)$. For $n \in \mathbb{N}$, $[n] = \{1, 2, \dots, n\}$. Standard basis vectors in \mathbb{R}^d are $\mathbf{e}_1 = (1, 0, \dots, 0)$, $\mathbf{e}_2 = (0, 1, 0, \dots, 0)$, \dots , $\mathbf{e}_d = (0, \dots, 0, 1)$ and $\mathbf{0}$ is the origin of \mathbb{R}^d . The ℓ^1 norm of $x = (x_1, \dots, x_d) \in \mathbb{R}^d$ is $|x|_1 = \sum_{i=1}^d |x_i|$. Particular subsets of \mathbb{R}^d that recur are $\mathcal{R} = \{\pm \mathbf{e}_1, \dots, \pm \mathbf{e}_d\}$, $\mathcal{R}^o = \mathcal{R} \cup \{\mathbf{0}\}$, $\mathcal{U} = \text{co } \mathcal{R} = \{\xi \in \mathbb{R}^d : |\xi|_1 \leq 1\}$, and the topological interior $\text{int } \mathcal{U}$.

A finite or infinite path or sequence is denoted by $x_{m:n} = (x_m, \dots, x_n)$ for $-\infty \leq m \leq n \leq \infty$. Other notation for lattice paths are x and π . The steps of a path are the nearest-neighbor edges $e_i = \{x_{i-1}, x_i\}$. A finite path $x_{m:n}$ that satisfies $|x_n - x_m|_1 = n - m$ is called an ℓ^1 -path.

A *positively homogeneous* function f satisfies $f(cx) = cf(x)$ for $c > 0$ whenever both cx and x are in the domain of f [17, p. 30]. One-sided derivatives of a function defined around $s \in \mathbb{R}$ are defined by $f'(s+) = \lim_{h \searrow 0} h^{-1}[f(s+h) - f(s)]$ and $f'(s-) = \lim_{h \searrow 0} h^{-1}[f(s) - f(s-h)]$.

The diamond \diamond is a wild card for three superscripts $\langle \text{empty} \rangle$ (no superscript at all), o (zero steps allowed), and sa (self-avoiding) that distinguish different FPP processes with restricted path length.

A real number r is an *atom* of the random edge weight $t(e)$ if $\mathbb{P}\{t(e) = r\} > 0$. $M_0 = \text{ess sup } t(e)$ and $r_0 = \text{ess inf } t(e)$. Superscript (b) on any quantity means that it is computed with weights shifted by b : $t^{(b)}(e) = t(e) + b$.

The symbol \triangle marks the end of a numbered remark.

1.10. Acknowledgements. The authors would like to thank Michael Damron for sketching a route to prove the lower bound in Theorem 2.11(ii), and an anonymous referee for spotting a mistake in the proof of Theorem 2.17.

2. THE MODELS AND THE MAIN RESULTS

2.1. Setting. Fix an arbitrary dimension $d \geq 2$. Let $\mathcal{E}_d = \{\{x, y\} : x, y \in \mathbb{Z}^d, |x - y|_1 = 1\}$ denote the set of *undirected nearest-neighbor edges* between vertices of \mathbb{Z}^d . $(\Omega, \mathfrak{G}, \mathbb{P})$ is the probability space of an environment $\omega = (t(e) : e \in \mathcal{E}_d)$ such that the edge weights $\{t(e) : e \in \mathcal{E}_d\}$ are independent and identically distributed (i.i.d.) real-valued random variables. Translations $\{\theta_x\}_{x \in \mathbb{Z}^d}$ act on Ω by $(\theta_x \omega)\{u, v\} = t(\{x + u, x + v\})$ for a nearest-neighbor edge $\{u, v\}$.

A nearest-neighbor path $\pi = x_{0:n} = (x_i)_{i=0}^n$ is any finite sequence of vertices $x_0, x_1, \dots, x_n \in \mathbb{Z}^d$ that satisfy $|x_{i+1} - x_i|_1 = 1$ for each i . The steps of π are the nearest-neighbor edges $e_i = \{x_{i-1}, x_i\}$. The *Euclidean length* $|\pi|$ of π is the number of edges, so in this case $|\pi| = n$. Then we call π an n -path. The *passage time* of π is the sum of the weights of its edges:

$$(2.1) \quad T(\pi) = \sum_{i=1}^n t(e_i).$$

These definitions apply even if the path repeats vertices or edges, as will be allowed at times in the sequel. For notational consistency we also admit the zero-length path $\pi = x_{0:0} = (x_0)$ that has no edges and has zero passage time and length: $T(\pi) = |\pi| = 0$.

The main results are described next in three parts: results for standard FPP in Section 2.2, results for restricted path-length FPP in Section 2.3, including the connections between the two types of FPP, and finally in Section 2.4 the duality between weight shift and geodesic length.

2.2. Standard first-passage percolation. In *standard first-passage percolation* (FPP) the passage time between two points is defined as the minimal passage time over all self-avoiding paths. A path $\pi = x_{0:n} = (x_i)_{i=0}^n$ is *self-avoiding* if $x_i \neq x_j$ for all pairs $i \neq j$. Let $\Pi_{x,y}^{\text{sa}}$ denote the collection of all self-avoiding paths from x to y , of arbitrary but finite length. Define the passage time between x and y as

$$(2.2) \quad T_{x,y} = \inf_{\pi \in \Pi_{x,y}^{\text{sa}}} T(\pi).$$

This definition gives $T_{x,x} = 0$ because the only self-avoiding path from x to x is the zero-length path. A *geodesic* is a self-avoiding path π that minimizes in (2.2).

When $t(e) \geq 0$ the restriction to self-avoiding paths is superfluous in the definition of $T_{x,y}$. Let p_c denote the critical probability of Bernoulli bond percolation on \mathbb{Z}^d . A frequently used assumption in FPP is that zero-weight edges are subcritical:

$$(2.3) \quad \mathbb{P}\{t(e) = 0\} < p_c.$$

For nonnegative weights, the assumption (2.3) guarantees the existence of a geodesic (Prop. 4.4 in [2]).

For $b \in \mathbb{R}$, define *b-shifted weights* by

$$(2.4) \quad \omega^{(b)} = (t^{(b)}(e) : e \in \mathcal{E}_d) \quad \text{with} \quad t^{(b)}(e) = t(e) + b \quad \text{for} \quad e \in \mathcal{E}_d.$$

All the quantities associated with weights $\omega^{(b)}$ acquire the superscript. For example, $T_{x,y}^{(b)}$ is the passage time in (2.2) under weights $\omega^{(b)}$. Let

$$(2.5) \quad r_0 = \mathbb{P}\text{-ess inf}_{\omega} t(e)$$

denote the (essential) lower bound of the weights. So in particular, $\omega^{(-r_0)}$ is the weight configuration shifted so that the lower bound is at zero. Since we shift weights, most of the time we have to replace (2.3) with this assumption:

$$(2.6) \quad \mathbb{P}\{t(e) = r_0\} < p_c.$$

Let $\{t_i\}$ denote i.i.d. copies of the edge weight $t(e)$. The following moment assumption will be employed for various values of p .

$$(2.7) \quad \mathbb{E}[(\min\{t_1, \dots, t_{2d}\})^p] < \infty.$$

We record the Cox-Durrett shape theorem ([5], Thm. 2.17 in [2]), with a small extension to weights that can take negative values. This theorem is proved as Theorem A.1 in Appendix A.

THEOREM 2.1. *Assume $r_0 \geq 0$, (2.6), and the moment bound (2.7) with $p = d$. Then there exists a constant $\varepsilon_0 > 0$, determined by the dimension d and the distribution of the shifted weights $\omega^{(-r_0)}$, and a full-probability event Ω_0 such that the following statements hold. For each real $b > -r_0 - \varepsilon_0$ there exists a continuous, convex, positively homogeneous shape function $\mu^{(b)} : \mathbb{R}^d \rightarrow \mathbb{R}_+$ such that the limit*

$$(2.8) \quad \mu^{(b)}(\xi) = \lim_{n \rightarrow \infty} n^{-1} T_{\mathbf{0}, x_n}^{(b)}$$

holds for each $\omega \in \Omega_0$, whenever $\{x_n\} \subset \mathbb{Z}^d$ satisfies $x_n/n \rightarrow \xi$. We have $\mu^{(b)}(\mathbf{0}) = 0$ and $\mu^{(b)}(\xi) > 0$ for $\xi \neq \mathbf{0}$.

If we require the shape function only for a single nonnegative weight distribution without the shifts, then (2.6) can be replaced with the weaker assumption (2.3), and we will occasionally do so. The shape function of unshifted weights is denoted by $\mu = \mu^{(0)}$.

To emphasize dependence on b with $\xi \neq \mathbf{0}$ fixed, we write

$$(2.9) \quad \mu_{\xi}(b) = \mu^{(b)}(\xi) \quad \text{for} \quad b > -r_0 - \varepsilon_0.$$

Several of our main results concern the regularity of μ_ξ and its connections with geodesic length. The reason for allowing negative weights by extending the shift b below $-r_0$ is to enable us to talk about the regularity of $\mu_\xi(b)$ at $b = -r_0$. Throughout this paper, ε_0 is the constant specified in Theorem 2.1.

THEOREM 2.2. *Assume $r_0 \geq 0$, (2.6), and the moment bound (2.7) with $p = d$. Fix $\xi \in \mathbb{R}^d \setminus \{\mathbf{0}\}$.*

- (i) *The function μ_ξ of (2.9) is a continuous, strictly increasing, concave function on the open interval $(-r_0 - \varepsilon_0, \infty)$.*
- (ii) *Strict concavity holds on $[-r_0, \infty)$: $\mu'_\xi(a+) > \mu'_\xi(b-)$ for $-r_0 \leq a < b < \infty$. Furthermore, $\mu'_\xi(b+) > \mu'_\xi((-r_0)+)$ for $b \in (-r_0 - \varepsilon_0, -r_0)$.*

Concavity implies that one-sided derivatives $\mu'_\xi(b\pm)$ for $b > -r_0 - \varepsilon_0$ exist, $\mu'_\xi(b-) \geq \mu'_\xi(b+)$, and as functions of b , they are nonincreasing, $\mu'_\xi(b-)$ is left-continuous, and $\mu'_\xi(b+)$ is right-continuous. *Strict concavity* is the novel part of the theorem. This property is proved in Section 7, based on the modification argument of Section 5.2.

Introduce the notation

$$(2.10) \quad \begin{aligned} \underline{L}_{\mathbf{0},x} &= \text{minimal Euclidean length of a geodesic for } T_{\mathbf{0},x} \\ \text{and } \overline{L}_{\mathbf{0},x} &= \text{maximal Euclidean length of a geodesic for } T_{\mathbf{0},x}, \end{aligned}$$

with the superscripted variants $\underline{L}_{\mathbf{0},x}^{(b)} = \underline{L}_{\mathbf{0},x}(\omega^{(b)})$ and $\overline{L}_{\mathbf{0},x}^{(b)} = \overline{L}_{\mathbf{0},x}(\omega^{(b)})$ for shifted weights $\omega^{(b)}$. For a continuous weight distribution $\underline{L}_{\mathbf{0},x} = \overline{L}_{\mathbf{0},x}$ almost surely because in that case geodesics are unique almost surely. This is not the case for all shifts because as b increases the geodesic jumps occasionally and at the jump locations there are two geodesics.

Recall that a geodesic for standard FPP is by definition self-avoiding. Under the assumptions of Theorem 2.1, Theorem A.1 in Appendix A proves that the following holds on an event Ω_0 of full probability: $\overline{L}_{\mathbf{0},x}^{(b)} < \infty$ for all $x \in \mathbb{Z}^d$ and $b > -r_0 - \varepsilon_0$, and there exist a finite deterministic constant c and a finite random constant K such that

$$(2.11) \quad \overline{L}_{\mathbf{0},x}^{(b)} \leq \frac{c|x|_1}{(b+r_0) \wedge 0 + \varepsilon_0} \quad \forall b > -r_0 - \varepsilon_0 \text{ whenever } |x|_1 \geq K.$$

We justify part (i) of Theorem 2.2. This sets the stage for further discussion. Let $b > -r_0 - \varepsilon_0$. Take $0 < \delta \leq b + r_0 + \varepsilon_0$ and $\eta > 0$. Considering the shifted weights on the minimal and maximal length geodesics of $T_{\mathbf{0},x}^{(b)}$ leads to

$$(2.12) \quad T_{\mathbf{0},x}^{(b-\delta)} \leq T_{\mathbf{0},x}^{(b)} - \delta \overline{L}_{\mathbf{0},x}^{(b)} \quad \text{and} \quad T_{\mathbf{0},x}^{(b+\eta)} \leq T_{\mathbf{0},x}^{(b)} + \eta \underline{L}_{\mathbf{0},x}^{(b)}.$$

Rearrange to

$$(2.13) \quad \frac{T_{\mathbf{0},x}^{(b+\eta)} - T_{\mathbf{0},x}^{(b)}}{\eta} \leq \underline{L}_{\mathbf{0},x}^{(b)} \leq \overline{L}_{\mathbf{0},x}^{(b)} \leq \frac{T_{\mathbf{0},x}^{(b)} - T_{\mathbf{0},x}^{(b-\delta)}}{\delta}.$$

Here are the arguments for the properties of μ_ξ claimed in part (i) of Theorem 2.2.

- (i.a) *Strict increasingness.* In (2.12) take $x = x_n$ such that $x_n/n \rightarrow \xi$. Since $\overline{L}_{\mathbf{0},x}^{(b)} \geq |x|_1$, the inequality $\mu_\xi(b-\delta) \leq \mu_\xi(b) - \delta|\xi|_1$ follows by taking the limit (2.8) in (2.12).
- (i.b) *Concavity* follows by taking the same limit in (2.13).
- (i.c) *Continuity* of μ_ξ on the open interval $(-r_0 - \varepsilon_0, \infty)$ follows from concavity.

Since $\underline{L}_{\mathbf{0},x}^{(b)} \geq |x|_1$, (2.13) and the monotonicity of the derivatives give the easy bound

$$(2.14) \quad \mu'_\xi(b\pm) \geq |\xi|_1.$$

A corollary of the strict concavity given in Theorem 2.2(ii) is the strict inequality $\mu'_\xi(b_\pm) > |\xi|_1$. The next theorem records a slight strengthening of this and consequences of (2.11) and (2.13). A precise proof is given in Section 7.

THEOREM 2.3. *Assume $r_0 \geq 0$, (2.6), and the moment bound (2.7) with $p = d$. Let ε_0 be the constant specified in Theorem 2.1 and let c be the constant in (2.11). Then there exists a full-probability event Ω_0 such that the following holds: for all shifts $b > -r_0 - \varepsilon_0$, directions $\xi \in \mathbb{R}^d \setminus \{\mathbf{0}\}$, weight configurations $\omega \in \Omega_0$, and sequences $x_n/n \rightarrow \xi$, we have the bounds*

$$(2.15) \quad \begin{aligned} (1 + D(b))|\xi|_1 &\leq \mu'_\xi(b+) \leq \varliminf_{n \rightarrow \infty} \frac{\underline{L}_{\mathbf{0}, x_n}^{(b)}(\omega)}{n} \\ &\leq \overline{\varliminf}_{n \rightarrow \infty} \frac{\overline{L}_{\mathbf{0}, x_n}^{(b)}(\omega)}{n} \leq \mu'_\xi(b-) \leq \frac{2c}{(b + r_0) \wedge 0 + \varepsilon_0} |\xi|_1. \end{aligned}$$

$D(b)$ is a nonincreasing function of b such that $D(b) > 0$ for all $b > -r_0 - \varepsilon_0$.

The first inequality in (2.15) says that the strict concavity gap $\mu'_\xi(b+) > |\xi|_1$ is uniform across all directions $|\xi|_1 = 1$. This point is further strengthened to a uniformity for fixed weight configurations ω in Theorem 2.5.

Remark 2.4. Here are points that follow Theorems 2.2 and 2.3. Let $\xi \neq \mathbf{0}$.

(i) The inequalities in (2.15) imply the limit of Hammersley-Welsh, Smythe-Wierman and Kesten simultaneously for all sequences. Under the assumptions of Theorem 2.3, suppose μ_ξ is differentiable at $b \in (-r_0 - \varepsilon_0, \infty)$. Then (2.15) implies that for all $\omega \in \Omega_0$ and sequences $x_n/n \rightarrow \xi$,

$$(2.16) \quad \lim_{n \rightarrow \infty} \frac{\underline{L}_{\mathbf{0}, x_n}^{(b)}(\omega)}{n} = \lim_{n \rightarrow \infty} \frac{\overline{L}_{\mathbf{0}, x_n}^{(b)}(\omega)}{n} = \mu'_\xi(b).$$

By concavity, this happens at all but countably many b . In particular, if μ_ξ is a differentiable function then geodesic lengths converge with probability one, simultaneously in all directions and at all weight shifts. Presently there is no proof of differentiability under any hypotheses. Further below we show failures of differentiability under assumptions on the atoms of the weight distribution.

Suppose $\mu'_\xi(b+) < \mu'_\xi(b-)$. Then (2.15) tells us that all the possible asymptotic normalized lengths of geodesics that go in direction ξ form a subset of the interval $[\mu'_\xi(b+), \mu'_\xi(b-)]$. Presently there is no description of this subset.

For a characterization of $[\mu'_\xi(b+), \mu'_\xi(b-)]$ in terms of path length, given below in Theorem 2.17, we expand the class of paths considered to allow $o(n)$ -approximate geodesics. These are paths from the origin to $n\xi + o(n)$ whose passage times are in the range $n\mu_\xi(b) + o(n)$, without necessarily being geodesics between their endpoints.

(ii) The strict concavity of μ_ξ given in Theorem 2.2 and the inequalities in (2.15) imply that, for all $\omega, \tilde{\omega} \in \Omega_0$ and sequences $x_n/n \rightarrow \xi$ and $\tilde{x}_n/n \rightarrow \xi$,

$$(2.17) \quad \overline{\varliminf}_{n \rightarrow \infty} \frac{\overline{L}_{\mathbf{0}, x_n}^{(b)}(\omega)}{n} \leq \mu'_\xi(b-) < \mu'_\xi(a+) \leq \varliminf_{n \rightarrow \infty} \frac{\underline{L}_{\mathbf{0}, \tilde{x}_n}^{(a)}(\tilde{\omega})}{n} \quad \text{for all } b > a > -r_0 - \varepsilon_0.$$

In other words, distinct shifts of a given weight distribution cannot share any possible asymptotic geodesic lengths, even under distinct but typical environments ω and $\tilde{\omega}$.

(iii) There is a corresponding monotonicity for geodesics at fixed ω . Namely, when all the weights increase by a common constant, geodesics can only shrink in length. Let $\pi^{(a)}$ and $\pi^{(b)}$ be arbitrary geodesics for $T_{\mathbf{0}, x}^{(a)}$ and $T_{\mathbf{0}, x}^{(b)}$, respectively. Then

$$(2.18) \quad |\pi^{(b)}| \leq |\pi^{(a)}| \quad \text{for fixed } a < b \text{ and } \omega.$$

This follows from

$$(2.19) \quad \begin{aligned} T^{(b)}(\pi^{(a)}) - (b-a)|\pi^{(a)}| &= T^{(a)}(\pi^{(a)}) \leq T^{(a)}(\pi^{(b)}) = T^{(b)}(\pi^{(b)}) - (b-a)|\pi^{(b)}| \\ &\leq T^{(b)}(\pi^{(a)}) - (b-a)|\pi^{(b)}|. \end{aligned}$$

Furthermore, suppose a unique geodesic is chosen, for example by taking the minimal one according to some ordering of geodesics. Then as a increases to b , the geodesic cannot change without its length strictly shrinking:

$$(2.20) \quad \text{for fixed } a < b \text{ and } \omega, |\pi^{(b)}| = |\pi^{(a)}| \text{ implies } \pi^{(b)} = \pi^{(a)}.$$

This follows because the string of inequalities (2.19) together with $|\pi^{(b)}| = |\pi^{(a)}|$ implies that $T^{(b)}(\pi^{(a)}) \leq T^{(b)}(\pi^{(b)})$, so $\pi^{(a)}$ is still at least as good as $\pi^{(b)}$ for weights $\{t^{(b)}(e)\}$.

(iv) We establish below in Theorem 2.17 that $\mu'_\xi(b_\pm) \rightarrow |\xi|_1$ as $b \rightarrow \infty$. Naturally, as the weight shift grows very large, it pays less to search for smaller weights at the expense of a longer geodesic. \triangle

The first inequality in (2.15) implies that asymptotically the lengths of geodesics in a particular direction ξ exceed the ℓ^1 -distance. The next theorem strengthens this to a uniformity across all sufficiently faraway lattice endpoints. Its proof in Section 7 relies on the convex duality described in Section 2.4, the restricted path length shape theorem of Appendix B, and the modification arguments of Section 5.

THEOREM 2.5. *Assume $r_0 \geq 0$, (2.6), and the moment bound (2.7) with $p = d$. There exist a deterministic constant $\delta > 0$ and an almost surely finite random constant K such that $\underline{L}_{\mathbf{0},x} \geq (1 + \delta)|x|_1$ whenever $x \in \mathbb{Z}^d$ satisfies $|x|_1 \geq K$.*

We turn to nondifferentiability results for μ_ξ . An *atom* of the weight distribution is a value $r \in \mathbb{R}$ such that $\mathbb{P}\{t(e) = r\} > 0$.

THEOREM 2.6. *Assume $r_0 \geq 0$, (2.6), and the moment bound (2.7) with $p = d$. Additionally, assume that the weight distribution satisfies at least one of the assumptions (a) and (b) below:*

- (a) *zero is an atom;*
- (b) *there are two strictly positive atoms $r < s$ such that s/r is rational.*

Then there exist constants $0 < D, \delta, M < \infty$ such that

$$(2.21) \quad \mathbb{P}(\overline{L}_{\mathbf{0},x} - \underline{L}_{\mathbf{0},x} \geq D|x|_1) \geq \delta \quad \text{for } |x|_1 \geq M.$$

Furthermore, for all $\xi \in \mathbb{R}^d \setminus \{\mathbf{0}\}$, $\mu'_\xi(0-) - \mu'_\xi(0+) \geq D|\xi|_1$ and so the function $\mu_\xi(a) = \mu^{(a)}(\xi)$ is not differentiable at $a = 0$.

For unbounded weights the result above can be proved under more general assumptions on the atoms (see Theorem 6.2 in Section 6).

THEOREM 2.7. *Assume $r_0 \geq 0$, (2.6), and the moment bound (2.7) with $p = d$. Additionally, assume that the weight distribution has at least two atoms. Then there exists a countably infinite set $B \subset [-r_0, \infty)$ with these properties.*

- (i) *B is dense in $[-r_0, \infty)$.*
- (ii) *For each $b \in B$, conclusion (2.21) of Theorem 2.6 holds for the shifted weights $\omega^{(b)}$ with constants $D^{(b)}, \delta^{(b)}, M^{(b)}$ that depend on b .*
- (iii) *For each $\xi \in \mathbb{R}^d \setminus \{\mathbf{0}\}$ and $b \in B$, $\mu_\xi(a) = \mu^{(a)}(\xi)$ is not differentiable at $a = b$.*

The proof of Theorem 2.7 in Section 7.2 constructs the singularity set B explicitly from two atoms of $t(e)$ as a countably infinite union of arithmetic sequences.

Remark 2.8. Standard *Bernoulli weights* satisfy $\mathbb{P}\{t(e) = 0\} + \mathbb{P}\{t(e) = 1\} = 1$. In the subcritical planar Bernoulli case (that is, $d = 2$, $t(e) \in \{0, 1\}$ and $\mathbb{P}\{t(e) = 0\} < \frac{1}{2}$), Steele and Zhang [19] proved that $\mu_{\mathbf{e}_1}(a)$ is not differentiable at $a = 0$, as long as $\mathbb{P}\{t(e) = 0\}$ is close enough to $\frac{1}{2}$. Furthermore, they conjectured that $\mu_{\mathbf{e}_1}(a)$ is differentiable at all a such that $\mu_{\mathbf{e}_1}(a) > -\infty$ except at $a = 0$ (page 1050 in [19]).

Theorem 2.6 above extends the nondifferentiability at $a = 0$ to all directions ξ , all dimensions, and all weight distributions that have an atom at zero. Theorem 2.7 above disproves the Steele-Zhang conjecture by showing that, in all dimensions, in the subcritical Bernoulli case the nondifferentiability points form a countably infinite dense subset of $(0, \infty)$. \triangle

2.3. Restricted path-length first-passage percolation. Next we discuss FPP models that restrict the length of the paths over which the optimization takes place but give up the self-avoidance requirement. Remark 2.15 below characterizes the FPP shape function μ as the positively homogeneous convex function generated by the restricted path shape functions. In the next Section 2.4 this leads to the convex duality of μ_ξ and a sharpening of Theorem 2.3, and further conceptual understanding of the previous results.

It turns out convenient to consider also a version whose paths are allowed zero steps. In this case the set $\mathcal{R} = \{\pm \mathbf{e}_1, \dots, \pm \mathbf{e}_d\}$ of admissible steps is augmented to $\mathcal{R}^o = \mathcal{R} \cup \{\mathbf{0}\}$. For $x, y \in \mathbb{Z}^d$ and $n \in \mathbb{N}$ define three classes of paths $x_{0:n} = (x_i)_{i=0}^n$ from x to y of length n , presented here from largest to smallest:

$$(2.22) \quad \begin{aligned} \Pi_{x,(n),y}^o &= \{x_{0:n} \in (\mathbb{Z}^d)^{n+1} : x_0 = x, x_n = y, \text{ each } x_i - x_{i-1} \in \mathcal{R}^o\}, \\ \Pi_{x,(n),y} &= \{x_{0:n} \in (\mathbb{Z}^d)^{n+1} : x_0 = x, x_n = y, \text{ each } x_i - x_{i-1} \in \mathcal{R}\}, \\ \text{and } \Pi_{x,(n),y}^{\text{sa}} &= \{x_{0:n} \in \Pi_{x,(n),y} : \text{points } x_0, x_1, \dots, x_n \text{ are distinct}\}. \end{aligned}$$

The superscript in Π^{sa} is for self-avoiding. Paths in $\Pi_{x,(n),y}$ and $\Pi_{x,(n),y}^o$ are allowed to repeat both vertices and edges. Paths in $\Pi_{x,(n),y}$ are called *\mathcal{R} -admissible*, and those in $\Pi_{x,(n),y}^o$ *\mathcal{R}^o -admissible*. An n -path $x_{0:n}$ from $x_0 = x$ to $x_n = y$ is an ℓ^1 -path if $n = |y - x|_1$. For $n = 0$ and $\diamond \in \{\langle \text{empty} \rangle, o, \text{sa}\}$ we define each collection $\Pi_{x,(0),x}^\diamond$ as consisting only of the zero-length path (x) . For $x \neq y$, $\Pi_{x,(n),y}$ and $\Pi_{x,(n),y}^{\text{sa}}$ are nonempty if and only if $n - |y - x|_1$ is a nonnegative even integer, while $\Pi_{x,(n),y}^o$ is nonempty if and only if $n \geq |y - x|_1$.

With the three classes of paths go three collections of points reachable by an admissible path of length n from the origin: for the three superscripts $\diamond \in \{\langle \text{empty} \rangle, o, \text{sa}\}$, define

$$(2.23) \quad \mathcal{D}_n^\diamond = \{x \in \mathbb{Z}^d : \Pi_{\mathbf{0},(n),x}^\diamond \neq \emptyset\}.$$

If $0 \leq k < n$, any k -path can be augmented to an n -path by adding $n - k$ zero steps, and hence we have $\mathcal{D}_n^o = \cup_{0 \leq k \leq n} \mathcal{D}_k$.

The environment $\omega = (t(e) : e \in \mathcal{E}_d)$ is extended to zero steps by stipulating that zero steps always have zero weight, even when weights are shifted: $t^{(b)}(\{x, x\}) = 0 \forall x \in \mathbb{Z}^d$ and $b \in \mathbb{R}$.

Define three point-to-point first-passage times between two points $x, y \in \mathbb{Z}^d$ with restricted path lengths: for $\diamond \in \{\langle \text{empty} \rangle, o, \text{sa}\}$,

$$(2.24) \quad G_{x,(n),y}^\diamond = \min_{x_{0:n} \in \Pi_{x,(n),y}^\diamond} \sum_{k=0}^{n-1} t(\{x_k, x_{k+1}\}) \quad \text{for } y - x \in \mathcal{D}_n^\diamond.$$

If $\Pi_{x,(n),y}^\diamond = \emptyset$, set $G_{x,(n),y}^\diamond = \infty$. Obvious relations hold between these passage times and the standard FPP from (2.2):

$$(2.25) \quad G_{x,(n),y}^o = \min_{k: |y-x|_1 \leq k \leq n} G_{x,(k),y},$$

$$\Pi_{x,y}^{\text{sa}} = \bigcup_{n \geq |y-x|_1} \Pi_{x,(n),y}^{\text{sa}}$$

and

$$(2.26) \quad T_{x,y} = \inf_{\pi \in \Pi_{x,y}^{\text{sa}}} T(\pi) = \inf_{n: n \geq |y-x|_1} G_{x,(n),y}^{\text{sa}}.$$

For nonnegative weights the restriction to self-avoiding paths is superfluous for $T_{x,y}$ and hence

$$(2.27) \quad \text{if } r_0 \geq 0 \text{ then } T_{x,y} = \inf_{n: n \geq |y-x|_1} G_{x,(n),y}^o = \inf_{n: n \geq |y-x|_1} G_{x,(n),y}.$$

These identities point to the usefulness of G and G^o . Namely, they capture the FPP passage time when the path length parameter n coincides with a geodesic length. After taking this connection to the limit, the discrepancies between the shape function of G and the FPP shape function μ reveal which asymptotic path lengths are too short and which are too long to be asymptotic geodesic lengths.

The reader may wonder about the purpose of G^o and the zero-weight zero step. We shall see that G^o is a convenient link between standard FPP and restricted path length FPP because it is monotone:

$$(2.28) \quad \text{if } r_0 \geq 0 \text{ and } m \leq n \text{ then } G_{x,(m),y}^o \geq G_{x,(n),y}^o \geq T_{x,y}.$$

The monotonicity is simply a consequence of the fact that any m -path can be augmented to an n -path by adding zero steps.

The self-avoiding version $G_{x,(n),y}^{\text{sa}}$ is mentioned here to complete the overall picture but will not be used in the sequel. Open problem 3.3 points the way to an extension of this work that requires a study of $G_{x,(n),y}^{\text{sa}}$.

We state a shape theorem for restricted path length FPP, but only on the open set $\text{int } \mathcal{U} = \{\xi \in \mathbb{R}^d : |\xi|_1 < 1\}$. Its closure, the compact ℓ^1 ball \mathcal{U} , is the convex hull of both \mathcal{R} and \mathcal{R}^o and the set of possible asymptotic velocities of admissible paths in $\Pi_{\mathbf{0},(n),\cdot}^\diamond$ as $n \rightarrow \infty$. In this theorem we introduce the parameter α as a variable that controls asymptotic path length.

THEOREM 2.9. *Assume $r_0 > -\infty$ and that the moment bound (2.7) holds with $p = d$ for the non-negative weights $t_i^+ = t_i \vee 0$. Then there exist*

- (a) *nonrandom continuous convex functions $g : \text{int } \mathcal{U} \rightarrow [r_0, \infty)$ and $g^o : \text{int } \mathcal{U} \rightarrow [r_0 \wedge 0, \infty)$ and*
- (b) *an event Ω_0 of \mathbb{P} -probability one*

such that the following statement holds for any fixed $\omega \in \Omega_0$: for any $\xi \in \mathbb{R}^d$, any real $\alpha > |\xi|_1$, and any sequences $k_n \rightarrow \infty$ in \mathbb{N} , $x_n \in \mathcal{D}_{k_n}$ and $y_n \in \mathcal{D}_{k_n}^o$ such that $k_n/n \rightarrow \alpha$, $x_n/n \rightarrow \xi$ and $y_n/n \rightarrow \xi$, we have the laws of large numbers

$$(2.29) \quad \alpha g\left(\frac{\xi}{\alpha}\right) = \lim_{n \rightarrow \infty} \frac{G_{\mathbf{0},(k_n),x_n}}{n} \quad \text{and} \quad \alpha g^o\left(\frac{\xi}{\alpha}\right) = \lim_{n \rightarrow \infty} \frac{G_{\mathbf{0},(k_n),y_n}^o}{n}.$$

Furthermore, $g(\mathbf{0}) = r_0$ and $g^o(\mathbf{0}) = r_0 \wedge 0$. In general $g^o \leq g$ on $\text{int } \mathcal{U}$. If $r_0 \leq 0$ then $g = g^o$ on all of $\text{int } \mathcal{U}$. If $r_0 > 0$ then $g > g^o$ in a neighborhood of the origin.

The laws of large numbers (2.29) come from Theorem B.1 in Appendix B. The soft properties of g and g^o stated in the last paragraph of Theorem 2.9 are proved in Lemma 4.1 in Section 4. Figure 2.2 illustrates the limit functions in (2.29).

It is convenient to have g^\diamond defined on the whole of \mathcal{U} . An attempt to do this through the laws of large numbers (2.29) would divert attention from the main points of this paper. Furthermore, without

stronger moment assumptions there cannot be a finite limit, as can be observed by considering $\xi = \mathbf{e}_1$. Since there is a unique n -path from $\mathbf{0}$ to $n\mathbf{e}_1$, we see that a finite limit is possible only if $t(e) \in L^1(\mathbb{P})$:

$$(2.30) \quad \lim_{n \rightarrow \infty} n^{-1} G_{\mathbf{0},(n),n\mathbf{e}_1}^\diamond = \lim_{n \rightarrow \infty} n^{-1} \sum_{k=1}^n t(\{(k-1)\mathbf{e}_1, k\mathbf{e}_1\}) = \mathbb{E}[t(e)].$$

Instead of limiting passage times, we take radial limits of the shape functions from the interior as stated in the next theorem. The proof of this theorem comes in Lemma 4.1(iv).

THEOREM 2.10. *Under the assumptions of Theorem 2.9 we can extend both shape functions to all of \mathcal{U} via limits along rays: for $\diamond \in \{\langle \text{empty} \rangle, o\}$ and $|\xi|_1 = 1$ define $g^\diamond(\xi) = \lim_{t \nearrow 1} g^\diamond(t\xi)$. The resulting functions $g : \mathcal{U} \rightarrow [r_0, \infty]$ and $g^\circ : \mathcal{U} \rightarrow [r_0 \wedge 0, \infty]$ are both convex and lower semicontinuous.*

With this theorem we can extend the functions g^\diamond to lower semicontinuous proper convex functions on all of \mathbb{R}^d by setting

$$(2.31) \quad g^\diamond(\xi) = +\infty \quad \text{for } \xi \notin \mathcal{U}.$$

If g^\diamond is finite on \mathcal{U} , then g^\diamond is automatically upper semicontinuous on \mathcal{U} [17, Theorem 10.2], and hence continuous on \mathcal{U} .

The next theorem clarifies the relationship of g and g° with μ , beyond the obvious $\mu \leq g^\circ \leq g$, and links their connection with the asymptotic geodesic lengths from Theorem 2.3. In particular, we introduce here two functions $\underline{\lambda} \leq \bar{\lambda}$ that play several roles in our asymptotic results. In the theorem below they are first introduced as the boundaries of the regions where μ coincides with g and g° . Part (ii) indicates that $\underline{\lambda}$ and $\bar{\lambda}$ are also related to the derivatives of μ_ξ and geodesic length.

These properties are then elaborated on as we proceed. The interval $[\underline{\lambda}(\xi), \bar{\lambda}(\xi)]$ captures all the asymptotic lengths of geodesics in direction ξ , while the full interval is exactly the set of all asymptotic lengths of approximate geodesics (Remark 2.13). In Theorem 2.16 we see that $\underline{\lambda}$ and $\bar{\lambda}$ describe ranges where g and g° are affine and where these two functions disagree. The macroscopic description is completed in Theorem 2.17: as the weight shift b increases, the interval $[\underline{\lambda}^{(b)}(\xi), \bar{\lambda}^{(b)}(\xi)]$ shifts to the left and always equals the superdifferential $\partial\mu_\xi(b)$ of the concave function μ_ξ . Then we have reached the desired generalization of the Hammersley-Welsh connection (1.1): the assumptions of differentiability and existence of limiting geodesic length have been dropped, and the correct identity equates the superdifferential with the set of asymptotic lengths of approximate geodesics.

Set

$$(2.32) \quad \mu^* = \sup_{|\xi|_1=1} \mu(\xi).$$

In part (ii) of the theorem, on both lines of (2.35) the first inequality depends on the modification arguments and hence the subcriticality assumption is strengthened to (2.6). To capture the complete picture we include in (2.35) the inequalities from (2.15).

THEOREM 2.11. *Assume $r_0 \geq 0$, (2.3), and the moment bound (2.7) with $p = d$.*

- (i) *There exist two positively homogeneous functions $\underline{\lambda} : \mathbb{R}^d \rightarrow \mathbb{R}_+$ and $\bar{\lambda} : \mathbb{R}^d \rightarrow [0, \infty]$ such that $\underline{\lambda} \leq \bar{\lambda}$, and for all $\xi \in \mathcal{U}$,*

$$(2.33) \quad g^\circ(\xi) = \mu(\xi) \iff \underline{\lambda}(\xi) \leq 1$$

and

$$(2.34) \quad g(\xi) = \mu(\xi) \iff \underline{\lambda}(\xi) \leq 1 \leq \bar{\lambda}(\xi).$$

Furthermore, $\underline{\lambda}$ is lower semicontinuous and $\bar{\lambda}$ is upper semicontinuous. If $r_0 = 0$ then $\bar{\lambda}(\xi) \equiv \infty$, while $\bar{\lambda}$ is finite in the case $r_0 > 0$.

- (ii) *Strengthen the subcriticality assumption to (2.6). There exists a nonrandom constant $D > 0$ and a full-probability event Ω_0 such that, for all $\xi \in \mathbb{R}^d \setminus \{\mathbf{0}\}$, sequences $x_n/n \rightarrow \xi$, and $\omega \in \Omega_0$,*

$$\begin{aligned}
(1+D)|\xi|_1 \leq \underline{\lambda}(\xi) &= \mu'_\xi(0+) \leq \varliminf_{n \rightarrow \infty} n^{-1} \underline{L}_{\mathbf{0}, x_n}(\omega) \\
&\leq \overline{\lim}_{n \rightarrow \infty} n^{-1} \overline{L}_{\mathbf{0}, x_n}(\omega) \leq \mu'_\xi(0-) < \overline{\lambda}(\xi) = \infty \quad \text{if } r_0 = 0 \\
\text{and } (1+D)|\xi|_1 \leq \underline{\lambda}(\xi) &= \mu'_\xi(0+) \leq \varliminf_{n \rightarrow \infty} n^{-1} \underline{L}_{\mathbf{0}, x_n}(\omega) \\
&\leq \overline{\lim}_{n \rightarrow \infty} n^{-1} \overline{L}_{\mathbf{0}, x_n}(\omega) \leq \mu'_\xi(0-) = \overline{\lambda}(\xi) \leq (\mu^*/r_0)|\xi|_1 \quad \text{if } r_0 > 0.
\end{aligned}
\tag{2.35}$$

We spell out some of the consequences of the theorems.

Remark 2.12 (Coincidence of shape functions). There exists a finite constant κ such that $\underline{\lambda}(\xi) \leq \kappa|\xi|_1 \forall \xi \in \mathbb{R}^d$. This follows from lower semicontinuity and homogeneity, but is also proved directly from Kesten's fundamental bound in Lemma 4.2 below. Hence the set $\{\mu = g^o\} = \{\underline{\lambda} \leq 1\}$ contains the nondegenerate neighborhood $\{\xi \in \mathbb{R}^d : |\xi|_1 \leq \kappa^{-1}\}$ of the origin.

If $r_0 = 0$ then $\{\mu = g\} = \{\mu = g^o\}$ because $g = g^o$. If $r_0 > 0$ the equality $\mu(\xi) = g(\xi)$ holds for at least one nonzero point ξ along each ray from the origin. With all of the above, the first inequality of (2.35) implies that $\{\mu = g\}$ and $\{\mu = g^o\}$ are both nonempty closed subsets of $\text{int } \mathcal{U}$. \triangle

Remark 2.13 ($o(n)$ -approximate geodesics). For $\alpha > |\xi|_1 > 0$, (2.34) gives the equivalence $\mu(\xi) = \alpha g(\xi/\alpha)$ if and only if $\alpha \in [\underline{\lambda}(\xi), \overline{\lambda}(\xi)]$. (This is illustrated in Figure 2.2 below.) By the law of large numbers (2.29), this happens if and only if, with probability one, there are lattice points x_n and paths π^n from $\mathbf{0}$ to x_n such that $x_n/n \rightarrow \xi$, $|\pi^n|/n \rightarrow \alpha$ and $T(\pi^n)/n \rightarrow \mu(\xi)$. These paths π^n do not have to be self-avoiding or geodesics between their endpoints. But $T(\pi^n)/n \rightarrow \mu(\xi)$ does imply that $T(\pi^n)$ is within $o(n)$ of the passage time of the geodesic between $\mathbf{0}$ and x_n . The asymptotic normalized lengths of true self-avoiding geodesics for $\mu(\xi)$ are a subset of the interval $[\underline{\lambda}(\xi), \overline{\lambda}(\xi)]$ of asymptotic normalized lengths of $o(n)$ -approximate geodesics, as indicated in (2.35). \triangle

Remark 2.14 (Convergence of geodesic length). We now see the connection between the convergence of the normalized geodesic length and the coincidence of shape functions. In the case $r_0 > 0$, (2.35) shows that convergence in direction $\xi \neq \mathbf{0}$ follows from $\underline{\lambda}(\xi) = \overline{\lambda}(\xi)$, which is equivalent to the condition that the set $\{\mu = g\}$ has empty relative interior on the ξ -directed ray. \triangle

Remark 2.15 (Convexity). Fix $\xi \in \mathbb{R}^d \setminus \{\mathbf{0}\}$. For $\diamond \in \{\langle \text{empty} \rangle, o\}$, the convexity and continuity of g^\diamond on $\text{int } \mathcal{U}$ imply the convexity and continuity of the function $\alpha \mapsto \alpha g^\diamond(\xi/\alpha)$ defined for $\alpha \in (|\xi|_1, \infty)$. By Theorem 2.10, $\alpha g^\diamond(\xi/\alpha)$ extends to $\alpha = |\xi|_1$ by letting $\alpha \searrow |\xi|_1$. By (2.31), we extend $\alpha g^\diamond(\xi/\alpha)$ to $\alpha \in [0, |\xi|_1)$ by setting its value equal to $+\infty$. Thereby $\alpha \mapsto \alpha g^\diamond(\xi/\alpha)$ is a lower semicontinuous proper convex function on \mathbb{R}_+ .

For g^o , monotonicity (2.28) implies further that

$$\alpha \mapsto \alpha g^o(\xi/\alpha) \text{ is nonincreasing for } \alpha \in (|\xi|_1, \infty).
\tag{2.36}$$

A consequence of Theorem 2.11 is that for $\xi \in \mathbb{R}^d \setminus \{\mathbf{0}\}$,

$$\mu(\xi) = \inf_{\alpha \geq |\xi|_1} \alpha g^\diamond\left(\frac{\xi}{\alpha}\right) = \inf_{\alpha \geq 0} \alpha g^\diamond\left(\frac{\xi}{\alpha}\right) = \begin{cases} \alpha g^o(\xi/\alpha) & \forall \alpha \in [\underline{\lambda}(\xi), \infty), \\ \alpha g(\xi/\alpha) & \forall \alpha \in [\underline{\lambda}(\xi), \overline{\lambda}(\xi)] \cap [\underline{\lambda}(\xi), \infty). \end{cases}
\tag{2.37}$$

In the language of convex analysis [17, p. 35], the identity above characterizes the standard FPP shape function μ as the *positively homogeneous convex function generated by g^\diamond* . This means that μ is the greatest positively homogeneous convex function such that $\mu(\mathbf{0}) \leq 0$ and $\mu \leq g^\diamond$. Figure 2.2 illustrates (2.37). \triangle

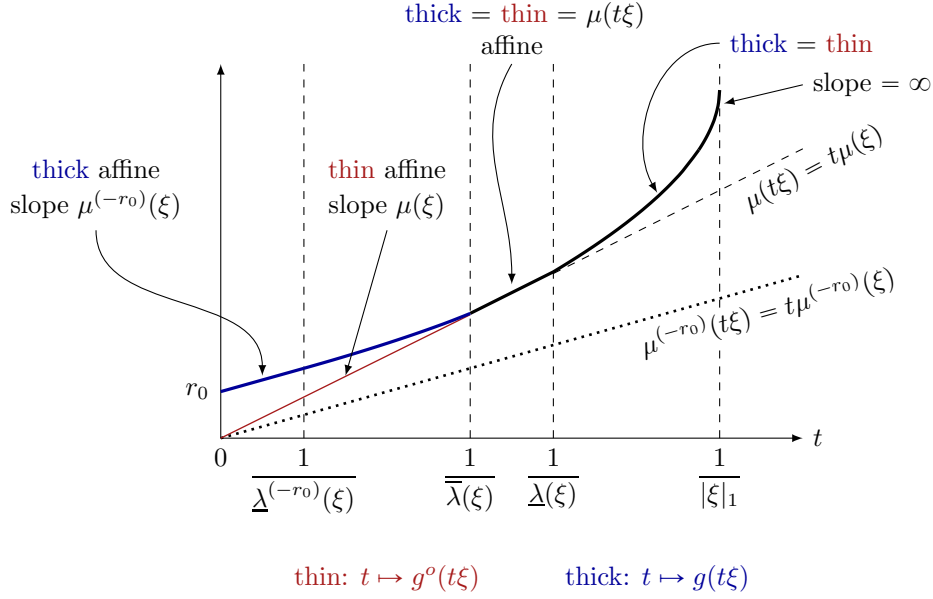

FIGURE 2.1. Illustration of Theorem 2.16 in the case $r_0 > 0$. On the t -axis it is possible that the two middle points $\frac{1}{\bar{\lambda}(\xi)}$ and $\frac{1}{\underline{\lambda}(\xi)}$ coincide. The separation illustrated here is the case where $\underline{\lambda}(\xi) = \mu'_\xi(0+) < \mu'_\xi(0-) = \bar{\lambda}(\xi)$, which can happen when $r_0 > 0$ for example in the situation described in Theorem 2.6. Strict concavity of μ_ξ implies that the middle points are necessarily separated from $\frac{1}{\underline{\lambda}^{(-r_0)}(\xi)}$ and $\frac{1}{|\xi|_1}$ (see (2.50) below).

The last theorem of this section records further properties of g^\diamond , illustrated in Figure 2.1. Part (iii) can be proved only in Section 7 after the modification results and hence requires the stronger subcriticality assumption (2.6).

THEOREM 2.16. *Assume $r_0 \geq 0$, (2.3), and the moment bound (2.7) with $p = d$. Fix $\xi \in \mathbb{R}^d \setminus \{\mathbf{0}\}$. For $\diamond \in \{\langle \text{empty} \rangle, \circ\}$, the shape functions g^\diamond of Theorem 2.9 have the following properties along the ξ -directed ray from the origin.*

- (i) *The function $t \mapsto g^\diamond(t\xi)$ is continuous, convex and strictly increasing for $t \in [0, |\xi|_1^{-1}]$. Both functions are affine at least in one nondegenerate interval with one endpoint at the origin: for $t \in [0, |\xi|_1^{-1}]$,*

$$(2.38) \quad \begin{aligned} t \in [0, (\underline{\lambda}^{(-r_0)}(\xi))^{-1}] &\iff g(t\xi) = r_0 + t\mu^{(-r_0)}(\xi) \\ t \in [0, (\underline{\lambda}(\xi))^{-1}] &\iff g^\circ(t\xi) = t\mu(\xi). \end{aligned}$$

- (ii) *For $t \in [0, |\xi|_1^{-1}]$,*

$$(2.39) \quad \begin{aligned} t \in [0, (\bar{\lambda}(\xi))^{-1}] &\iff g(t\xi) > g^\circ(t\xi) \\ t \in [(\bar{\lambda}(\xi))^{-1}, |\xi|_1^{-1}] &\iff g(t\xi) = g^\circ(t\xi). \end{aligned}$$

- (iii) *Strengthen the subcriticality assumption to (2.6). The function $t \mapsto g^\diamond(t\xi)$ is continuously differentiable on the open interval $(0, |\xi|_1^{-1})$ and $\lim_{t \nearrow |\xi|_1^{-1}} (g^\diamond)'(t\xi) = +\infty$. If $g^\diamond(\xi/|\xi|_1) < \infty$ then the left derivative of $t \mapsto g^\diamond(t\xi)$ at $t = |\xi|_1^{-1}$ exists and equals $+\infty$.*

Notice that the right-hand sides in (2.38) agree if and only if $r_0 = 0$, as is consistent with the agreement $g = g^\circ$ when $r_0 = 0$. From (2.39) and (2.35) we read that if $r_0 > 0$, the set $\{g > g^\circ\}$ is an open neighborhood of $\mathbf{0}$ that consists of finite rays from the origin, while its complement $\{g = g^\circ\}$

contains the nonempty annulus $\{\zeta \in \mathcal{U} : (1 + D)^{-1} \leq |\zeta|_1 \leq 1\}$, where D is the constant in (2.35). Another consequence of (2.38) and (2.39) is that g° is never strictly between μ and g but always agrees with at least one of them.

By Lemma D.1 in Appendix D, the differentiability property in part (iii) can be equivalently stated in geometric terms as follows: for $\xi \in (\text{int } \mathcal{U}) \setminus \{\mathbf{0}\}$, the subdifferential $\partial g^\circ(\xi)$ lies on a hyperplane perpendicular to ξ .

2.4. Duality of the weight shift and geodesic length. This section develops the duality between the weight shift variable b in $\omega \mapsto \omega^{(b)}$ and the path-length variable α in the limit shapes (2.29). Nonnegative weights ($r_0 \geq 0$) are assumed throughout.

Fix $\xi \in \mathbb{R}^d \setminus \{\mathbf{0}\}$ for the duration of this section. We restrict the shape function $\mu_\xi(b)$ of (2.9) to shifts $b \geq -r_0$ that preserve the nonnegativity of the weights and then extend it to an upper semicontinuous concave function on all of \mathbb{R} by setting

$$(2.40) \quad \bar{\mu}_\xi(b) = \begin{cases} \mu_\xi(b) = \mu^{(b)}(\xi), & b \geq -r_0 \\ -\infty, & b < -r_0. \end{cases}$$

To emphasize, the function $\bar{\mu}_\xi(b)$ drops the extension to $b \in (-r_0 - \varepsilon_0, -r_0)$ done in Theorem 2.1. The reason for this choice is that developing the duality for shifts $b < -r_0$ requires a study of the shape function of the self-avoiding version $G_{\mathbf{0},(n),x}^{\text{sa}}$ of restricted path length FPP. This is not undertaken in the present paper and is left as open problem 3.3.

By definition, the concave dual $\bar{\mu}_\xi^* : \mathbb{R} \rightarrow [-\infty, \infty)$ is another upper semicontinuous concave function, and together $\bar{\mu}_\xi$ and $\bar{\mu}_\xi^*$ satisfy

$$(2.41) \quad \bar{\mu}_\xi^*(\alpha) = \inf_{b \in \mathbb{R}} \{\alpha b - \bar{\mu}_\xi(b)\} \quad \text{and} \quad \bar{\mu}_\xi(b) = \inf_{\alpha \in \mathbb{R}} \{\alpha b - \bar{\mu}_\xi^*(\alpha)\}.$$

The *superdifferential* of the concave function $\bar{\mu}_\xi$ at b is by definition the set

$$\partial \bar{\mu}_\xi(b) = \{\alpha \in \mathbb{R} : \bar{\mu}_\xi(b') \leq \bar{\mu}_\xi(b) + \alpha(b' - b) \quad \forall b' \in \mathbb{R}\}.$$

By the definition $\partial \bar{\mu}_\xi(b) = \emptyset$ for $b < -r_0$. For $b > -r_0$, $\partial \bar{\mu}_\xi(b)$ is the bounded closed interval $[\bar{\mu}'_\xi(b+), \bar{\mu}'_\xi(b-)]$ and so $\partial \bar{\mu}_\xi(b) = \{\alpha\}$ if and only if $\bar{\mu}'_\xi(b) = \alpha$. These general equivalences hold:

$$\forall \alpha, b \in \mathbb{R} : \quad \alpha \in \partial \bar{\mu}_\xi(b) \iff \bar{\mu}_\xi^*(\alpha) + \bar{\mu}_\xi(b) = \alpha b \iff b \in \partial \bar{\mu}_\xi^*(\alpha).$$

Theorem 2.17 below establishes the convex duality. The qualitative nature of the (negative of the) dual function in (2.43) is illustrated in Figure 2.2, on the left in the case $r_0 = 0$ and on the right in the case $r_0 > 0$. In particular, on the left the affine portion of $\alpha \mapsto \alpha g(\xi/\alpha)$ on the interval $[\underline{\lambda}^{(b)}(\xi), \bar{\lambda}^{(b)}(\xi)]$ is the dual of the superdifferential $\partial \mu_\xi(b)$ in (2.46). The infinite slope at the left edge $|\xi|_1+$ is the dual of the limit (2.48).

A convenient feature of the restricted path length shape function without zero steps is that it transforms trivially under the weight shift:

$$(2.42) \quad g^{(b)}(\xi) = g(\xi) + b.$$

This and (2.37) applied to $\mu^{(b)}(\xi)$ give (2.44) below for $b > -r_0$, which is the basis for the duality.

THEOREM 2.17. *Assume $r_0 \geq 0$, (2.6), and the moment bound (2.7) with $p = d$. Fix $\xi \in \mathbb{R}^d \setminus \{\mathbf{0}\}$.*

(i) *The concave dual of $\bar{\mu}_\xi$ is*

$$(2.43) \quad \bar{\mu}_\xi^*(\alpha) = \begin{cases} -\alpha g(\xi/\alpha), & \alpha \geq |\xi|_1 \\ -\infty, & \alpha < |\xi|_1. \end{cases}$$

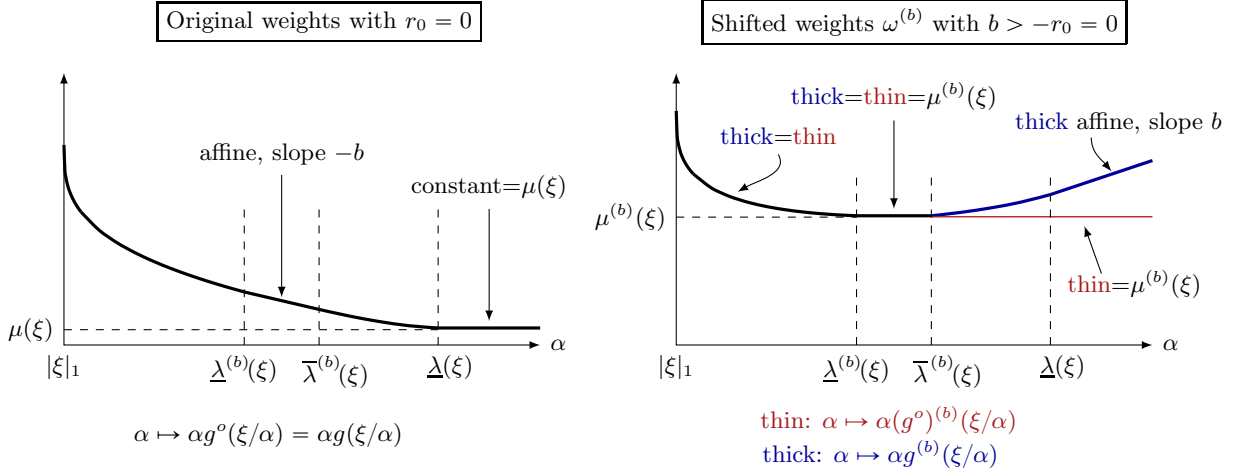

FIGURE 2.2. Fix $\xi \in \mathbb{R}^d \setminus \{0\}$. *Left:* Graphs of the functions $\alpha \mapsto \alpha\mu(\xi/\alpha) = \mu(\xi)$ and $\alpha \mapsto \alpha g^\circ(\xi/\alpha) = \alpha g(\xi/\alpha)$ in the case $r_0 = 0$. All three agree from $\underline{\lambda}(\xi)$ onwards to $\bar{\lambda}(\xi) = \infty$. *Right:* Graphs of $\alpha\mu^{(b)}(\xi/\alpha) = \mu^{(b)}(\xi)$, $\alpha(g^\circ)^{(b)}(\xi/\alpha)$ and $\alpha g^{(b)}(\xi/\alpha)$ for the weights shifted by $b > -r_0 = 0$. The labeling of the α -axis is the same in both figures. As the weights shift to higher values, the shape functions move up. In particular, the thick graph $\alpha \mapsto \alpha g^{(b)}(\xi/\alpha)$ on the right is obtained by adding the function $\alpha \mapsto b\alpha$ to the graph on the left. On the possibly degenerate interval $[\underline{\lambda}^{(b)}(\xi), \bar{\lambda}^{(b)}(\xi)]$ we have the triple coincidence $\alpha(g^\circ)^{(b)}(\xi/\alpha) = \alpha g^{(b)}(\xi/\alpha) = \mu^{(b)}(\xi)$ and after that $\alpha g^{(b)}(\xi/\alpha)$ separates from the other two. As b increases, the interval $[\underline{\lambda}^{(b)}(\xi), \bar{\lambda}^{(b)}(\xi)]$ moves to the left, without overlaps, approaching $|\xi|_1$ as $b \nearrow \infty$. In both pictures, at the left endpoint $|\xi|_1+$ the graphs coming from g° and g have slope $-\infty$. The three regions $[|\xi|_1, \underline{\lambda}^{(b)}(\xi))$, $[\underline{\lambda}^{(b)}(\xi), \bar{\lambda}^{(b)}(\xi)]$ and $(\bar{\lambda}^{(b)}(\xi), \infty)$ of qualitatively distinct behavior in the diagram on the right are described in Proposition 4.4.

In particular, we have the identities

$$(2.44) \quad \bar{\mu}_\xi(b) = \inf_{\alpha \geq |\xi|_1} \alpha g^{(b)}(\xi/\alpha) = \inf_{\alpha \geq |\xi|_1} \{\alpha g(\xi/\alpha) + \alpha b\} \quad \text{for } b \in \mathbb{R},$$

and

$$(2.45) \quad \alpha g(\xi/\alpha) = \sup_{b \geq -r_0} \{\bar{\mu}_\xi(b) - \alpha b\} \quad \text{for } \alpha \geq |\xi|_1.$$

(ii) For $b > -r_0$, the superdifferential $\partial \bar{\mu}_\xi(b)$ is the compact interval

$$(2.46) \quad \partial \bar{\mu}_\xi(b) = [\bar{\mu}'_\xi(b+), \bar{\mu}'_\xi(b-)] = [\underline{\lambda}^{(b)}(\xi), \bar{\lambda}^{(b)}(\xi)]$$

while

$$(2.47) \quad \partial \bar{\mu}_\xi(-r_0) = [\bar{\mu}'_\xi((-r_0)+), \infty) = [\underline{\lambda}^{(-r_0)}(\xi), \bar{\lambda}^{(-r_0)}(\xi)].$$

Furthermore,

$$(2.48) \quad \lim_{b \rightarrow \infty} \bar{\mu}'_\xi(b \pm) = |\xi|_1.$$

Remark 2.18. (a) Let us make explicit the conversion back to the original FPP shape function $\mu_\xi(b) = \mu^{(b)}(\xi)$ in Theorem 2.17. In (2.44) $\bar{\mu}_\xi(b)$ can be replaced by $\mu_\xi(b)$ for $b \geq -r_0$. In each of

(2.45), (2.46) and (2.48), $\bar{\mu}_\xi$ can be replaced by μ_ξ . (2.47) cannot be valid for $\partial\mu_\xi(-r_0)$ because $\mu_\xi(b) > -\infty$ for some $b < -r_0$. We do have

$$(2.49) \quad \mu'_\xi((-r_0)+) = \bar{\mu}'_\xi((-r_0)+) = \underline{\lambda}^{(-r_0)}(\xi) \quad \text{but} \quad \mu'_\xi((-r_0)-) < \infty = \bar{\lambda}^{(-r_0)}(\xi).$$

(b) The strict concavity of $\bar{\mu}_\xi$ that was stated in Theorem 2.2 was purposely left out of Theorem 2.17 so that this latter theorem can be proved easily at the end of Section 4, before we turn to the modification arguments. Combining Theorem 2.17 with Theorems 2.2 and 2.3 and (2.35) gives the following. There exists a constant $\kappa < \infty$ that depends on the dimension and the weight distribution such that, for all $b > a > -r_0$,

$$(2.50) \quad |\xi|_1 < \underline{\lambda}^{(b)}(\xi) \leq \bar{\lambda}^{(b)}(\xi) < \underline{\lambda}^{(a)}(\xi) \leq \bar{\lambda}^{(a)}(\xi) < \underline{\lambda}^{(-r_0)}(\xi) \leq \kappa|\xi|_1 < \infty = \bar{\lambda}^{(-r_0)}(\xi).$$

The strict inequalities above are due to the strict concavity of μ_ξ .

(c) When the infimum r_0 of the support of the weights is zero, g and g^o coincide (Theorem 2.9 and Lemma 4.1(ii)). Through (2.42) we get an alternative representation of the concave dual in (2.43) in terms of the restricted path FPP shape that admits zero steps:

$$(2.51) \quad \alpha g(\xi/\alpha) = \alpha g^{(-r_0)}(\xi/\alpha) + \alpha r_0 = \alpha (g^o)^{(-r_0)}(\xi/\alpha) + \alpha r_0.$$

We can combine (2.44) and (2.51) into a statement that shows that both g and $(g^o)^{(-r_0)}$ contain full information for retrieving all the shifts of μ among nonnegative weights:

$$(2.52) \quad \mu_\xi(b) = \inf_{\alpha \geq |\xi|_1} \{\alpha g(\xi/\alpha) + \alpha b\} = \inf_{\alpha \geq |\xi|_1} \{\alpha (g^o)^{(-r_0)}(\xi/\alpha) + \alpha(r_0 + b)\} \quad \text{for } b \geq -r_0.$$

(d) Equations (2.33), (2.51), and positive homogeneity of $\underline{\lambda}$ and μ show that $\alpha \mapsto \alpha g(\xi/\alpha)$ is affine for large α :

$$(2.53) \quad \alpha g(\xi/\alpha) = \mu^{(-r_0)}(\xi) + \alpha r_0 \quad \text{for } \alpha \geq \underline{\lambda}^{(-r_0)}(\xi).$$

The reader can recognize this statement as the dual version of $\partial\bar{\mu}_\xi(-r_0) = [\underline{\lambda}^{(-r_0)}(\xi), \infty)$ from the theorem above, and an immediate consequence of (2.38). This affine portion of $\alpha g(\xi/\alpha)$ is visible in both diagrams of Figure 2.2.

Identities (2.51) and (2.53) suggest that, for $\alpha \geq \underline{\lambda}^{(-r_0)}(\xi)$, the recipe for an optimal path of length approximately $n\alpha$ from $\mathbf{0}$ to a point close to $n\xi$ is this: shift the weights so that their infimum is zero and take the optimal path for the shifted weights $\omega^{(-r_0)}$. In particular, once α is above the FPP geodesic length, we can follow the FPP geodesic of the shifted weights $\omega^{(-r_0)}$ and extend the path to length $n\alpha$ by finding and repeating an edge whose weight is close to the minimum r_0 . \triangle

3. OPEN PROBLEMS

We list here open problems raised by the results.

3.1. Asymptotic length of geodesics. Does the Hammersley-Welsh limit generalize in some natural way when $\mu'_\xi(b+) < \mu'_\xi(b-)$? For example, are there weight configurations ω and $\tilde{\omega}$ and sequences $x_n/n \rightarrow \xi$ and $\tilde{x}_n/n \rightarrow \xi$ such that

$$(3.1) \quad \lim_{n \rightarrow \infty} \frac{\underline{L}_{\mathbf{0}, x_n}^{(b)}(\omega)}{n} = \mu'_\xi(b+) \quad \text{and} \quad \lim_{n \rightarrow \infty} \frac{\overline{L}_{\mathbf{0}, \tilde{x}_n}^{(b)}(\tilde{\omega})}{n} = \mu'_\xi(b-)?$$

If so, can these statements be strengthened to limits, and are they valid for all sequences and almost surely? Even if one cannot know the limits, are the random variables $\lim_{n \rightarrow \infty} n^{-1} \underline{L}_{\mathbf{0}, x_n}$ and $\lim_{n \rightarrow \infty} n^{-1} \overline{L}_{\mathbf{0}, x_n}$ almost surely constant?

3.2. Properties of the shape functions. Is μ_ξ differentiable when the weight distribution is continuous? What about the case of a single positive atom which is not covered by Theorems 2.6–2.7? Is any comparison between μ_ξ and $\mu_{\tilde{\xi}}$ possible for two distinct directions ξ and $\tilde{\xi}$? Is the function $\underline{\lambda}$ defined in (2.33) a norm on \mathbb{R}^d ? Do $\underline{\lambda}$ and $\bar{\lambda}$ possess more regularity than given in Theorem 2.11(ii)?

3.3. Duality of the weight shift and geodesic length for real-valued weights. The duality described in Section 2.4 restricted the shape function $\mu_\xi(b)$ to nonnegative weights through definition (2.40). This leaves open the duality of $\mu_\xi(b)$ for $b < -r_0$. To capture the full convex duality over all shifts b requires a study of the process $G_{\mathbf{0},(n),x}^{\text{sa}}$, restricted path length FPP that optimizes over self-avoiding paths, in a manner analogous to our study of $G_{\mathbf{0},(n),x}$ and its shape function.

The present shortcoming can be seen for example in the case $r_0 = 0$ of (2.35) where $\bar{\lambda}(\xi)$ blows up and cannot capture the left derivative $\mu'_\xi(0-)$. Graphically this same phenomenon appears in the left diagram of Figure 2.2 where the graph of $\alpha g(\xi/\alpha)$ never separates from $\mu(\xi)$ after $\underline{\lambda}(\xi)$. The graph of the function $\alpha g^{\text{sa}}(\xi/\alpha)$ of the self-avoiding version will separate from $\mu(\xi)$ for large enough α and capture $\mu'_\xi(0-)$.

3.4. Modification arguments for real weights. Do the van den Berg-Kesten modification arguments [20] extend to weights that can take negative values? Such an extension would permit the extension of the strict concavity of $\mu_\xi(b)$ to $b < -r_0$.

3.5. General perturbations of weights. Develop versions of our results for other perturbations of the weights, besides the simple shift $t^{(h)}(e) = t(e) + h$, such as the perturbations considered in [3].

4. THE SHAPE FUNCTIONS AND LENGTHS OF OPTIMAL PATHS

This section develops soft auxiliary results required for the main results of Section 2. Along the way we prove Theorem 2.10, part (i) of Theorem 2.11, parts (i)–(ii) of Theorem 2.16, and Theorem 2.17. To begin, assume $r_0 > -\infty$ and the moment bound (2.7) with $p = d$ for the nonnegative weights $t^+(e) = t(e) \vee 0$. Take the existence of the continuous, convex functions $g, g^\circ : \text{int } \mathcal{U} \rightarrow [r_0 \wedge 0, \infty)$ that satisfy the laws of large numbers (2.29) from Theorem B.1 in Appendix B. The limit implies $g \geq g^\circ$. Extend the shape functions g and g° to all of \mathcal{U} through radial limits: for $\diamond \in \{\langle \text{empty} \rangle, o\}$, define

$$(4.1) \quad g^\diamond(\xi) = \lim_{t \nearrow 1} g^\diamond(t\xi) \in [r_0 \wedge 0, \infty] \quad \text{for } |\xi|_1 = 1.$$

The limit exists because $t \mapsto g^\diamond(t\xi)$ is a convex function on the interval $[0, 1)$. Monotonicity (2.36), $g \geq g^\circ$, and the limit combine to give, for $|\xi|_1 \leq \tau \leq \alpha$,

$$(4.2) \quad \alpha g^\circ(\xi/\alpha) \leq \tau g^\circ(\xi/\tau) \leq \tau g(\xi/\tau).$$

Part (iv) of the next lemma proves Theorem 2.10.

LEMMA 4.1. *Assume $r_0 > -\infty$ and the moment bound (2.7) with $p = d$ for the nonnegative weights $t^+(e) = t(e) \vee 0$. The restricted path shape functions have the following properties.*

- (i) $g(\mathbf{0}) = r_0$ and $g^\circ(\mathbf{0}) = r_0 \wedge 0$.
- (ii) If $r_0 \leq 0$ then $g = g^\circ$ on all of \mathcal{U} . If $r_0 > 0$ then $g > g^\circ$ in an open neighborhood of the origin.
- (iii) For all $\xi \in \mathbb{R}^d \setminus \{\mathbf{0}\}$ and $\alpha \geq |\xi|_1$,

$$(4.3) \quad \alpha g^\circ\left(\frac{\xi}{\alpha}\right) = \inf_{\tau: |\xi|_1 \leq \tau \leq \alpha} \tau g\left(\frac{\xi}{\tau}\right)$$

and the infimum on the right is attained at some $\tau \in [|\xi|_1, \alpha]$. In particular, $|\xi|_1 = 1$ implies $g^o(\xi) = g(\xi)$.

(iv) For $\diamond \in \langle \text{empty} \rangle, o$, the extended function g^\diamond is convex and lower semicontinuous on \mathcal{U} .

Proof. Part (i). The lower bounds $g \geq r_0$ and $g^o \geq r_0 \wedge 0$ on all of $\text{int } \mathcal{U}$ follow from $t(e) \geq r_0$ and $t(\{x, x\}) = 0$. Also immediate is $g^o(\mathbf{0}) \leq 0$. Given $\varepsilon > 0$, we can fix as measurable functions of almost every ω ,

$$(4.4) \quad \text{an edge } e = \{x, y\} \text{ such that } t(e) < r_0 + \varepsilon, \text{ and a path } \pi \text{ from } \mathbf{0} \text{ to } x.$$

For large enough n consider paths $x_{0:n}$ that follow π and then repeat edge e $n - |\pi|$ times. Then $x_n/n \rightarrow 0$ and in the limit $g^o(\mathbf{0}) \leq g(\mathbf{0}) \leq r_0 + \varepsilon$.

Part (ii). The claim for $r_0 \leq 0$ is true because the zero steps of a path $\pi_n \in \Pi_{\mathbf{0},(n),x}^o$ can be replaced by repetitions of an edge with weight close to r_0 . Here is a detailed proof.

Fix $\xi \in \text{int } \mathcal{U}$ and a sequence $x_n \in \mathcal{D}_n$ such that $x_n/n \rightarrow \xi$. Let π_n be an optimal path for $G_{\mathbf{0},(n),x_n}^o$ and let k_n be the number of zero steps in π_n . Let e and π be as in (4.4). We construct an \mathcal{R} -admissible path π'_n of length n from $\mathbf{0}$ to x_n or $x_n + \mathbf{e}_1$ that repeats edge e as many times as possible, as follows.

- First, if k_n is even, let $y_n = x_n$, and if k_n is odd, let $y_n = x_n + \mathbf{e}_1$. Then π_n (plus the $y_n - x_n$ step if necessary) goes from $\mathbf{0}$ to y_n in $n - 2\lfloor k_n/2 \rfloor$ nonzero steps.
- The remaining $2\lfloor k_n/2 \rfloor$ steps are spent in an initial segment from $\mathbf{0}$ back to $\mathbf{0}$ by first following π to x , then back and forth across e altogether $2(\lfloor k_n/2 \rfloor - |\pi|)^+$ times, and then from x back to $\mathbf{0}$ along π (in reverse direction). If $\lfloor k_n/2 \rfloor \leq |\pi|$ then the initial segment does not go all the way to x but turns back towards $\mathbf{0}$ after $\lfloor k_n/2 \rfloor$ steps along π .

Let e_1, \dots, e_m denote the edges of π . We get the following bound:

$$(4.5) \quad \begin{aligned} G_{\mathbf{0},(n),y_n} &\leq T(\pi'_n) = 2 \sum_{i=1}^{m \wedge \lfloor k_n/2 \rfloor} t(e_i) + 2(\lfloor k_n/2 \rfloor - |\pi|)^+ t(e) + T(\pi_n) + t(\{x_n, y_n\}) \\ &\leq 2 \sum_{i=1}^m t^+(e_i) + 2(\lfloor k_n/2 \rfloor - |\pi|)^+ (r_0 + \varepsilon) + G_{\mathbf{0},(n),x_n}^o + t^+(\{x_n, x_n + \mathbf{e}_1\}). \end{aligned}$$

Divide through by n and let $n \rightarrow \infty$ along a suitable subsequence, utilizing $r_0 \leq 0$ and $y_n/n \rightarrow \xi$. We obtain

$$g(\xi) \leq \varepsilon + g^o(\xi) + \liminf_{n \rightarrow \infty} n^{-1} t^+(\{x_n, x_n + \mathbf{e}_1\}).$$

The last term vanishes almost surely because $n^{-1} t^+(\{x_n, x_n + \mathbf{e}_1\}) \rightarrow 0$ in probability. Since $g \geq g^o$ always, letting $\varepsilon \searrow 0$ establishes the equality $g = g^o$ under $r_0 \leq 0$.

The statement for $r_0 > 0$ in Part (ii) follows from Part (i) and continuity.

Part (iii). For $r_0 \leq 0$ (4.3) follows from $g^o = g$ and (4.2).

Assume $r_0 > 0$. The inequalities in (4.2) imply that \leq holds in (4.3). To prove the opposite inequality \geq in (4.3), consider first $\alpha > |\xi|_1$ so that we can take advantage of the laws of large numbers. Choose $k_n \rightarrow \infty$ and $x_n \in \mathcal{D}_{k_n}^o$ so that $k_n/n \rightarrow \alpha$, $|x_n|_1 \rightarrow \infty$ and $x_n/n \rightarrow \xi$. Begin with

$$G_{\mathbf{0},(k_n),x_n}^o = \min_{j: |x_n|_1 \leq j \leq k_n} G_{\mathbf{0},(j),x_n}.$$

Let $\varepsilon > 0$ and choose a partition $|\xi|_1 = \tau_0 < \tau_1 < \dots < \tau_m = \alpha$ such that $\tau_i - \tau_{i-1} < \varepsilon$. Choose integers $\ell_{n,i}$ such that $|x_n|_1 = \ell_{n,0} < \ell_{n,1} < \dots < \ell_{n,m}$, $\ell_{n,m} \geq k_n$, $\ell_{n,i}/n \rightarrow \tau_i$ and $x_n \in \mathcal{D}_{\ell_{n,i}}$. (When $\ell_{n,i} > |x_n|_1$, $x_n \in \mathcal{D}_{\ell_{n,i}}$ only requires $\ell_{n,i}$ to have the right parity.) Then

$$G_{\mathbf{0},(k_n),x_n}^o \geq \min_{1 \leq i \leq m} \min_{\ell_{n,i-1} \leq j \leq \ell_{n,i}} G_{\mathbf{0},(j),x_n} \geq \min_{1 \leq i \leq m} G_{\mathbf{0},(\ell_{n,i}),x_n} - 2T(\pi) - 2n\varepsilon(r_0 + \varepsilon)$$

where we again utilize (4.4): for $\ell_{n,i-1} \leq j \leq \ell_{n,i}$ whenever $x_n \in \mathcal{D}_j$, construct an $\ell_{n,i}$ -path from $\mathbf{0}$ to x_n by first going from $\mathbf{0}$ to one endpoint of e , repeating e as many times as needed, returning to $\mathbf{0}$, and then following an optimal j -path from $\mathbf{0}$ to x_n . (If $\ell_{n,i} - j$ is too small to allow travel all the way to e , then proceed part of the way and return to $\mathbf{0}$. $\ell_{n,i} - j$ is even because $x_n \in \mathcal{D}_{\ell_{n,i}} \cap \mathcal{D}_j$.) The number of repetitions of e is at most $2n\varepsilon$ when n is large enough.

In the limit

$$\alpha g^\circ(\xi/\alpha) \geq \min_{1 \leq i \leq m} \tau_i g(\xi/\tau_i) - 2\varepsilon(r_0 + \varepsilon) \geq \inf_{\tau: |\xi|_1 \leq \tau \leq \alpha} \tau g(\xi/\tau) - 2\varepsilon(r_0 + \varepsilon).$$

Let $\varepsilon \searrow 0$ to complete the proof of (4.3) in the case $\alpha > |\xi|_1$. The infimum in (4.3) is attained because on the right either the extended function is continuous down to $\tau = |\xi|_1$ or then it blows up to ∞ .

To complete the proof of (4.3) we show that $g^\circ(\xi) = g(\xi)$ when $|\xi|_1 = 1$. Only $g^\circ(\xi) \geq g(\xi)$ needs proof. Let $c < g(\xi)$. Since $g \geq r_0 > 0$ we can assume $c > 0$. Pick $u < 1$ so that $g(s\xi) > c$ for $s \in [u, 1]$. Then by (4.3) applied to the case $\alpha > 1$, for $t \in [u, 1]$ we have

$$g^\circ(t\xi) = t \cdot \inf_{s \in [t, 1]} \frac{g(s\xi)}{s} \geq tc.$$

Letting $t \nearrow 1$ gives $g^\circ(\xi) \geq c$.

Part (iv). Convexity extends readily to all of \mathcal{U} . If $\xi = \alpha\xi' + (1 - \alpha)\xi''$ in \mathcal{U} , then for $0 < t < 1$ convexity on $\text{int}\mathcal{U}$ gives $g^\circ(t\xi) \leq \alpha g^\circ(t\xi') + (1 - \alpha)g^\circ(t\xi'')$ and we can let $t \nearrow 1$.

We check the lower semicontinuity of the extension g° on \mathcal{U} . Since g° is continuous in the interior, we need to consider only limits to the boundary. Let $|\xi|_1 = 1$, $g^\circ(\xi) > c$ and $\xi_j \rightarrow \xi$ in \mathcal{U} . By the limit in (4.1) we can pick $t < 1$ so that $t^{-1}g^\circ(t\xi) > c$. By the continuity of g° on $\text{int}\mathcal{U}$, $g^\circ(t\xi_j) \rightarrow g^\circ(t\xi)$. Pick j_0 so that $t^{-1}g^\circ(t\xi_j) > c$ for $j \geq j_0$. Apply (4.2) to ξ_j with $\alpha = t^{-1}$ and $\tau = 1$ to get $g^\circ(\xi_j) \geq t^{-1}g^\circ(t\xi_j) > c$, again for all $j \geq j_0$. Lower semicontinuity of g° has been established.

Lower semicontinuity of g follows from $g \geq g^\circ$ and the equality $g = g^\circ$ on the boundary: when $|\xi|_1 = 1$ and $\xi_j \rightarrow \xi$ in \mathcal{U} , $\underline{\lim}_{j \rightarrow \infty} g(\xi_j) \geq \underline{\lim}_{j \rightarrow \infty} g^\circ(\xi_j) \geq g^\circ(\xi) = g(\xi)$. \square

In the remainder of this section we investigate the connections of g° and g with standard FPP and assume $r_0 \geq 0$ and either (2.3) or (2.6). We begin with the fact that μ and g° coincide in a neighborhood of the origin. Since the next lemma considers nonnegative weights without any shifts, the weaker subcriticality assumption (2.3) is sufficient.

LEMMA 4.2. *Assume $r_0 \geq 0$, (2.3), and the moment bound (2.7) with $p = d$. Then there exists a constant $\kappa \in (1, \infty)$ and a positively homogeneous function $\underline{\lambda}: \mathbb{R}^d \rightarrow \mathbb{R}_+$ such that $|\xi|_1 \leq \underline{\lambda}(\xi) \leq \kappa|\xi|_1$ $\forall \xi \in \mathbb{R}^d$ and*

$$(4.6) \quad \text{for } \xi \in \mathcal{U}, \quad \mu(\xi) = g^\circ(\xi) \iff \underline{\lambda}(\xi) \leq 1.$$

In particular, $\mu(\xi) = g^\circ(\xi)$ in the neighborhood $\{\xi \in \mathbb{R}^d: |\xi|_1 \leq \kappa^{-1}\}$ of the origin.

Proof. We claim that there exists a constant $\kappa \in (1, \infty)$ such that

$$(4.7) \quad \forall \xi \in \mathbb{R}^d \setminus \{\mathbf{0}\}: \mu(\xi/\alpha) = g^\circ(\xi/\alpha) \text{ for } \alpha \geq \kappa|\xi|_1.$$

It suffices to prove that a constant κ works for all $|\xi|_1 = 1$. Towards this end we show the existence of a deterministic constant κ and a random constant M_1 such that

$$(4.8) \quad \overline{L}_{\mathbf{0},x} \leq \frac{1}{2}\kappa|x|_1 \quad \text{for all } |x|_1 \geq M_1.$$

By Kesten's foundational estimate (Proposition 5.8 in [14], also Lemma 4.5 in [2]), valid under the subcriticality assumption (2.3), there are positive constants δ, c_1 such that, for all $k \in \mathbb{N}$,

$$(4.9) \quad \mathbb{P}(\exists \text{ self-avoiding path } \gamma \text{ such that } \mathbf{0} \in \gamma, |\gamma| \geq k, \text{ and } T(\gamma) \leq k\delta) \leq e^{-c_1 k}.$$

By adding these probabilities over the cases $|\gamma| = k \geq n$ we get

$$(4.10) \quad \mathbb{P}\{\exists \text{ self-avoiding path } \gamma \text{ from the origin with } |\gamma| \geq n \text{ and } T(\gamma) \leq \delta|\gamma|\} \leq Ce^{-c_1 n}.$$

Thus there exists a random constant M_1 such that any self-avoiding path γ from the origin of length $|\gamma| \geq M_1$ satisfies $T(\gamma) \geq \delta|\gamma|$.

Since the FPP shape function μ is positively homogeneous, by the FPP shape theorem ([2, p. 11] or (A.8) in Appendix A) we can increase M_1 if necessary so that, for a deterministic constant c_2 ,

$$(4.11) \quad T_{\mathbf{0},x} \leq c_2|x|_1 \quad \text{for all } |x|_1 \geq M_1.$$

Let $|x|_1 \geq M_1$ and let π be a geodesic for $T_{\mathbf{0},x}$. Then

$$\delta|\pi| \leq T(\pi) = T_{\mathbf{0},x} \leq c_2|x|_1$$

from which $|\pi| \leq (c_2/\delta)|x|_1$. (4.8) has been verified.

Given ξ such that $|\xi|_1 = 1$, let $x_n/n \rightarrow \xi$. Then for all large enough n , $\bar{L}_{\mathbf{0},x_n} \leq n\kappa$. Hence, recalling (2.25),

$$T_{\mathbf{0},x_n} = \min_{|x_n|_1 \leq k \leq n\kappa} G_{\mathbf{0},(k),x_n} = G_{\mathbf{0},(\lfloor n\kappa \rfloor),x_n}^o.$$

In the limit $\mu(\xi) = \kappa g^o(\xi/\kappa)$. (The requirement $\kappa > 1$ was imposed precisely to justify the limit $n^{-1}G_{\mathbf{0},(\lfloor n\kappa \rfloor),x_n}^o \rightarrow \kappa g^o(\xi/\kappa)$.) By the lower bound $g^o \geq \mu$ and the monotonicity in (4.2), $\mu(\xi) = \alpha g^o(\xi/\alpha)$ for $\alpha \geq \kappa$. (4.7) has been verified.

Define

$$(4.12) \quad \underline{\lambda}(\xi) = \inf\{\alpha \geq |\xi|_1 : \mu(\xi/\alpha) = g^o(\xi/\alpha)\}.$$

The claimed properties of the function $\underline{\lambda}$ follow. \square

Later in the paper (Corollary 7.2) after much more work we can show that $\underline{\lambda}(\xi) \geq (1+D)|\xi|_1$.

In the next lemma we strengthen the subcriticality assumption to (2.6) so that we can apply Lemma 4.2 to the shifted weights $\omega^{(-r_0)}$ and $\mu^{(-r_0)}(\xi) > 0$.

LEMMA 4.3. *Assume $r_0 \geq 0$, (2.6), and the moment bound (2.7) with $p = d$. For $\diamond \in \{\langle \text{empty} \rangle, o\}$, the shape functions g^\diamond have the following properties for a fixed $\xi \in \mathbb{R}^d \setminus \{\mathbf{0}\}$.*

- (i) *On the ξ -directed ray these functions are affine in a nondegenerate interval started from zero: for $0 \leq t \leq |\xi|_1^{-1}$,*

$$(4.13) \quad \begin{aligned} t \in [0, (\underline{\lambda}(\xi))^{-1}] &\iff g^\diamond(t\xi) = t\mu(\xi) \\ \text{and } t \in [0, (\underline{\lambda}^{(-r_0)}(\xi))^{-1}] &\iff g^\diamond(t\xi) = r_0 + t\mu^{(-r_0)}(\xi). \end{aligned}$$

- (ii) *The function $t \mapsto g^\diamond(t\xi)$ is continuous, convex, and strictly increasing for $t \in [0, |\xi|_1^{-1}]$.*

Proof. Part (i). The first line of (4.13) is exactly (4.6). Shifting weights gives $g(\zeta) = r_0 + g^{(-r_0)}(\zeta)$ and Lemma 4.1(ii) gives $g^{(-r_0)}(\zeta) = (g^o)^{(-r_0)}(\zeta)$. Then the first line of (4.13) applied to $\omega^{(-r_0)}$ gives the second line.

Part (ii). Continuity and convexity on $\text{int}\mathcal{U}$ are already in the construction of the functions g^\diamond . Since $\mu(\xi) \geq \mu^{(-r_0)}(\xi) > 0$ (Theorem 2.1), $t \mapsto g^\diamond(t\xi)$ is strictly increasing on a nondegenerate interval from 0. By convexity, it has to be strictly increasing on the entire interval $[0, |\xi|_1^{-1}]$. \square

Since the functions $\alpha \mapsto \alpha g^\diamond(\xi/\alpha)$ are central to our treatment, we rewrite (4.6) in this form:

$$(4.14) \quad \text{for } \xi \in \mathbb{R}^d \setminus \{\mathbf{0}\} \text{ and } \alpha \geq |\xi|_1, \quad \alpha g^o\left(\frac{\xi}{\alpha}\right) = \mu(\xi) \iff \alpha \geq \underline{\lambda}(\xi).$$

Together with (4.3) the above implies that some $\tau \geq |\xi|_1$ satisfies $\tau g(\xi/\tau) = \mu(\xi)$. By the $\mu \leq g^o \leq g$ inequalities, any such τ must satisfy $\tau \geq \underline{\lambda}(\xi)$. Now we have

$$(4.15) \quad \text{for } \xi \in \mathbb{R}^d \setminus \{\mathbf{0}\}, \quad \mu(\xi) = \inf_{\alpha: \alpha \geq |\xi|_1} \alpha g\left(\frac{\xi}{\alpha}\right).$$

Furthermore, for $\xi \in \mathbb{R}^d \setminus \{\mathbf{0}\}$,

$$(4.16) \quad \bar{\lambda}(\xi) = \sup\left\{\alpha \geq |\xi|_1 : \alpha g\left(\frac{\xi}{\alpha}\right) = \mu(\xi)\right\} \in [\underline{\lambda}(\xi), \infty]$$

is a meaningful definition as the supremum of a nonempty set. Positive homogeneity of $\bar{\lambda}$ on $\mathbb{R}^d \setminus \{\mathbf{0}\}$ follows from the positive homogeneity of μ . By Lemma 4.1(ii) and (4.14),

$$(4.17) \quad r_0 = 0 \quad \text{implies} \quad \bar{\lambda}(\xi) = \infty.$$

Recall $\mu^* = \sup_{|\xi|_1=1} \mu(\xi)$. Let α be such that $\alpha g(\xi/\alpha) = \mu(\xi)$. Then

$$\alpha r_0 \leq \alpha g(\xi/\alpha) = \mu(\xi) \leq \mu^* |\xi|_1.$$

Thus

$$(4.18) \quad r_0 > 0 \quad \text{implies} \quad \bar{\lambda}(\xi) \leq (\mu^*/r_0)|\xi|_1.$$

Since $r_0 > 0$ implies that $g(\mathbf{0}) = r_0 > 0 = \mu(\mathbf{0})$, (4.16) is not a meaningful definition of $\bar{\lambda}(\mathbf{0})$. Cued by (4.17) and (4.18), we can retain positive homogeneity by defining

$$(4.19) \quad \bar{\lambda}(\mathbf{0}) = \begin{cases} 0, & r_0 > 0 \\ \infty, & r_0 = 0. \end{cases}$$

The next proposition collects properties of the functions $\alpha \mapsto \alpha g^\diamond(\xi/\alpha)$ for $\diamond \in \{\langle \text{empty} \rangle, o\}$. These properties are implicit in the definitions and previously established facts. Note that part (i) below is still conditional for we have not yet proved that $|\xi|_1 < \underline{\lambda}(\xi)$. The trichotomy in the proposition is illustrated in Figure 2.2.

PROPOSITION 4.4. *Assume $r_0 \geq 0$, (2.3), and the moment bound (2.7) with $p = d$. Fix $\xi \in \mathbb{R}^d \setminus \{\mathbf{0}\}$. Then for $\alpha \in [|\xi|_1, \infty)$, the functions $\alpha \mapsto \alpha g(\xi/\alpha)$ and $\alpha \mapsto \alpha g^o(\xi/\alpha)$ have the following properties.*

- (i) *For $|\xi|_1 \leq \alpha < \underline{\lambda}(\xi)$, $\alpha g^o(\xi/\alpha) = \alpha g(\xi/\alpha)$ are strictly decreasing, convex, and strictly above $\mu(\xi)$.*
- (ii) *For $\underline{\lambda}(\xi) \leq \alpha \leq \bar{\lambda}(\xi)$, $\alpha g^o(\xi/\alpha) = \alpha g(\xi/\alpha) = \mu(\xi)$.*
- (iii) *For $\alpha > \bar{\lambda}(\xi)$, $\alpha g^o(\xi/\alpha) = \mu(\xi)$, while $\alpha g(\xi/\alpha) > \mu(\xi)$ and $\alpha g(\xi/\alpha)$ is convex and strictly increasing. This case is nonempty if and only if $r_0 > 0$.*

Proof. The inequalities

$$(4.20) \quad \underline{\lambda}(\xi) < \infty \quad \text{and} \quad |\xi|_1 \leq \underline{\lambda}(\xi) \leq \bar{\lambda}(\xi) \leq \infty.$$

are built into the definitions and Lemma 4.2.

Part (i). Assume $|\xi|_1 < \underline{\lambda}(\xi)$ so there is something to check. Since $\alpha \mapsto \alpha g^o(\xi/\alpha)$ is nonincreasing, convex, and reaches its minimum $\mu(\xi)$ at $\alpha = \underline{\lambda}(\xi)$ but not before, it must be strictly decreasing for $|\xi|_1 \leq \alpha < \underline{\lambda}(\xi)$.

Suppose $\alpha_0 g^o(\xi/\alpha_0) < \alpha_0 g(\xi/\alpha_0)$ for some $\alpha_0 > |\xi|_1$. (Equality holds at $\alpha_0 = |\xi|_1$ by Lemma 4.1(iii).) We show that $\underline{\lambda}(\xi) < \alpha_0$. By (4.3), for some $\tau_0 \in [|\xi|_1, \alpha_0)$ and all $\alpha \in [\tau_0, \alpha_0]$

$$\alpha_0 g^o(\xi/\alpha_0) = \tau_0 g(\xi/\tau_0) = \inf_{|\xi|_1 \leq \tau \leq \alpha_0} \tau g(\xi/\tau) = \inf_{|\xi|_1 \leq \tau \leq \alpha} \tau g(\xi/\tau) = \alpha g^o(\xi/\alpha).$$

Thus $\alpha \mapsto \alpha g^o(\xi/\alpha)$ is constant on $[\tau_0, \alpha_0]$ with $\tau_0 < \alpha_0$. It must be that $\underline{\lambda}(\xi) \leq \tau_0 < \alpha_0$.

Part (ii). From Part (i) and (4.14), the behavior of $\alpha g^o(\xi/\alpha)$ is completely determined. Furthermore, $\alpha g(\xi/\alpha)$ achieves its minimum $\mu(\xi)$ at $\alpha = \underline{\lambda}(\xi)$ by a combination of (4.3) with Part (i) and (4.14). Then $\alpha g(\xi/\alpha)$ must be nondecreasing for $\alpha \geq \underline{\lambda}(\xi)$, and definition (4.16) forces $\alpha g(\xi/\alpha) = \mu(\xi)$ for $\underline{\lambda}(\xi) \leq \alpha \leq \bar{\lambda}(\xi)$.

Part (iii) follows from convexity and the definitions. \square

The next lemma shows that $\underline{\lambda}$ is lower semicontinuous and $\bar{\lambda}$ upper semicontinuous.

LEMMA 4.5. *Let $\xi_i \rightarrow \xi$ in $\mathbb{R}^d \setminus \{\mathbf{0}\}$. Then*

$$(4.21) \quad \underline{\lambda}(\xi) \leq \liminf_{i \rightarrow \infty} \underline{\lambda}(\xi_i) \leq \overline{\lim}_{i \rightarrow \infty} \bar{\lambda}(\xi_i) \leq \bar{\lambda}(\xi).$$

Proof. If $\underline{\lambda}(\xi) = |\xi|_1$, the first inequality of (4.21) is trivial. Suppose $|\xi|_1 < \alpha < \underline{\lambda}(\xi)$. Then $\alpha g^o(\xi/\alpha) > \mu(\xi)$. By continuity on $\text{int}\mathcal{U}$, $\alpha g^o(\xi_i/\alpha) > \mu(\xi_i)$ for large i , which implies $\underline{\lambda}(\xi_i) > \alpha$.

If $\bar{\lambda}(\xi) = \infty$, the last inequality of (4.21) is trivial. By (4.17) and (4.18), the complementary case has $r_0 > 0$ and therefore $\bar{\lambda}(\xi_i) \leq (\mu^*/r_0)|\xi_i|_1$. Then

$$\bar{\lambda}(\xi_i) g\left(\frac{\xi_i}{\bar{\lambda}(\xi_i)}\right) = \mu(\xi_i).$$

Suppose a subsequence satisfies $\bar{\lambda}(\xi_i) \rightarrow \tau > \bar{\lambda}(\xi) \geq |\xi|_1$. Then for all large enough i , $\bar{\lambda}(\xi_i) \geq (1 + \delta)|\xi_i|_1$ for some $\delta > 0$. Continuity of g on $\text{int}\mathcal{U}$ and of μ on \mathbb{R}^d then leads to $\tau g(\xi/\tau) = \mu(\xi)$, a contradiction. \square

At this point we have covered everything needed to prove part (i) of Theorem 2.11 and parts (i)–(ii) of Theorem 2.16. The proofs of these theorems will be completed in Section 7.1 after the modification arguments. As the last item of this section we prove the claims about the convex duality.

LEMMA 4.6. *Assume (2.7) with $p = 1$. For all $\xi \in \mathbb{R}^d$, we have*

$$\lim_{b \rightarrow \infty} \frac{\mu^{(b)}(\xi)}{b} = |\xi|_1.$$

Proof. We may assume that $\xi \in \mathbb{Z}^d \setminus \{\mathbf{0}\}$ for the following. The extension to $\xi \in \mathbb{R}^d$ follows from the homogeneity and convexity of $\mu^{(b)}(\xi)$ in ξ .

Claim 4.7. For each $\xi \in \mathbb{Z}^d$, there exist $2d$ edge-disjoint paths $\{\pi_i\}_{i=1}^{2d}$ from $\mathbf{0}$ to ξ such that their Euclidean lengths satisfy $|\pi_1| = |\xi|_1$ and $|\pi_i| \leq |\xi|_1 + 8$ for $i \neq 1$.

The proof of this claim comes after the proof of the lemma, but it is intuitively clear that there exist $2d$ edge-disjoint paths from $\mathbf{0}$ to ξ such that at least one path has length $|\xi|_1$ and the length of each path is at most $|\xi|_1 + C_\xi$ for some constant C_ξ (see [14, Fig. 2.1] for the case $\xi = k\mathbf{e}_i$). Then,

$$(4.22) \quad \left(1 + \frac{r_0}{b}\right) |\xi|_1 \leq \frac{\mu^{(b)}(\xi)}{b} \leq \frac{\mathbb{E}[T_{\mathbf{0},\xi}^{(b)}]}{b} \leq \mathbb{E}\left[b^{-1} \min_{i=1,\dots,2d} T^{(b)}(\pi_i)\right],$$

where the first inequality follows from $T_{\mathbf{0},\xi}^{(b)} \geq |\xi|_1(b + r_0)$, the second from subadditivity, and the third from the fact that $T_{\mathbf{0},\xi}^{(b)}$ is an infimum over all paths from $\mathbf{0}$ to ξ . Denote the integrand on the right-hand side of (4.22) by Z_b .

Since $T^{(b)}(\pi_i) \leq (C_\xi + |\xi|_1)b + T(\pi_i)$ for $i = 1, \dots, 2d$, we have

$$Z_b \leq (C_\xi + |\xi|_1) + \min_{i=1,\dots,2d} T(\pi_i) \quad \text{for all } b \geq 1.$$

Next, we show that $\min_{i=1,\dots,2d} T(\pi_i)$ is integrable (see [2, Theorem 2.2]) in preparation for the dominated convergence theorem. A union bound over the edges of each path π_i and independence of the edge weights in the paths implies

$$\mathbb{P}\left\{\min_{i=1,\dots,2d} T(\pi_i) \geq s\right\} \leq \left(\max_i |\pi_i| \mathbb{P}\left\{t_e \geq \frac{s}{|\pi_i|}\right\}\right)^{2d}.$$

Integrating over $s \geq 0$ shows that for some constant C_ξ ,

$$\mathbb{E}\left[\min_{i=1,\dots,2d} T(\pi_i)\right] \leq C_\xi \mathbb{E}[\min\{t_1, \dots, t_{2d}\}] < \infty.$$

Since Z_b can be written as

$$Z_b = \min_{i=1,\dots,2d} \left(|\pi_i| + \frac{T(\pi_i)}{b}\right),$$

we see that $\lim_{b \rightarrow \infty} Z_b = |\pi_1| = |\xi|_1$. Therefore, by the dominated convergence theorem, we have

$$|\xi|_1 \leq \lim_{b \rightarrow \infty} \frac{\mu^{(b)}(\xi)}{b} \leq \lim_{b \rightarrow \infty} \mathbb{E}[Z_b] = |\xi|_1. \quad \square$$

Proof of Claim 4.7. For general $\xi \in \mathbb{Z}^d$, let k be the number of non-zero coordinates of ξ and suppose $k > 1$. This is the effective dimension of the rectangle formed with the origin and ξ as extreme opposing corners. We may assume without loss of generality that the first k coordinates of ξ are non-zero and the rest are 0. So let $\xi = (a_1, a_2, \dots, a_k, 0, \dots, 0)$.

The first k disjoint paths run along the edges of the rectangle. Such a path is encoded by a permutation $\sigma \in \mathbb{S}_k$. For example, $\sigma = (1, 2, \dots, k)$ corresponds to the path $\mathbf{0} \rightarrow a_1 \mathbf{e}_1 \rightarrow a_1 \mathbf{e}_1 + a_2 \mathbf{e}_2 \rightarrow \dots$. Two paths encoded by permutations $\sigma = (\sigma_1, \dots, \sigma_k)$ and $\mu = (\mu_1, \dots, \mu_k)$ meet (share a vertex) before ξ if and only if for some $j < k$, $\{\sigma_1, \dots, \sigma_j\} = \{\mu_1, \dots, \mu_j\}$. Consider the k paths corresponding to the cyclic permutations:

$$\pi_1 = (1, 2, \dots, k), \pi_2 = (2, 3, \dots, 1), \dots, \pi_k = (k, 1, \dots, k-1).$$

These k paths are vertex disjoint, except for their first and last vertices, and have length $|\xi|_1$.

The next $d - k$ paths are formed as follows. For each $j \in \{k+1, \dots, d\}$, start with an \mathbf{e}_j step, follow the path π_1 to $\xi + \mathbf{e}_j$, and conclude with a $-\mathbf{e}_j$ step to ξ . Get another $d - k$ paths by starting with $-\mathbf{e}_j$ and finishing with \mathbf{e}_j . These paths have length $|\xi|_1 + 2$.

Now we have altogether $k + 2(d - k)$ paths. The final k paths are a little trickier.

For each $i = \{1, \dots, k\}$, pair direction \mathbf{e}_i with path $p_{i+1 \bmod k}$. We construct the path for $i = 1$, and the rest are similar. The first step is $-\mathbf{e}_1$. Then follow π_2 until π_2 is about to step in the \mathbf{e}_k direction (the last step before it steps in the \mathbf{e}_1 direction). On the \mathbf{e}_k segment take $a_k + 1$ steps and then take $a_1 + 1$ steps in the \mathbf{e}_1 direction (this avoids the π_2 path), ending up at $\xi + \mathbf{e}_k$. Finish at ξ by taking a final $-\mathbf{e}_k$ step. Replacing \mathbf{e}_1 and π_2 by \mathbf{e}_j and $p_{j+1 \bmod k}$ for $j = 2, \dots, k$ gives us k such paths that are disjoint from each other and all the previous paths (except for their first and last vertices). All these have length $|\xi|_1 + 4$. Notice the crucial assumption of $k > 1$ for this construction.

The $k = 1$ case is covered in [14, Fig 2.1], as mentioned earlier. One can verify that this gives the worst case of $|\xi|_1 + 8$. \square

Proof of Theorem 2.17. Step 1. Identity (2.44). For $b \geq -r_0$, (2.44) is a combination of (4.15) and (2.42). For large α

$$(4.23) \quad \alpha g(\xi/\alpha) \leq \mu(\xi) + \alpha r_0$$

because an $\lfloor n\alpha \rfloor$ -path from $\mathbf{0}$ to a point close to $n\xi$ can be created by following the strategy in the proof of Lemma 4.1(ii): repeat an edge close to the origin with weight close to r_0 as many times as needed, and then follow a geodesic to a point close to $n\xi$. Bound (4.23) implies that the right-hand side of (2.44) equals $-\infty$ for $b < -r_0$. Identity (2.44) has been verified for all $b \in \mathbb{R}$.

Step 2. The duality. The convexity and lower semicontinuity of $\alpha \mapsto \alpha g(\xi/\alpha)$ for $\alpha \geq |\xi|_1$ imply that the function defined by the right-hand side of (2.43) is concave and upper semicontinuous. Thus (2.44) implies that $\bar{\mu}_\xi$ is the concave dual of this function. Then we can identify the dual $\bar{\mu}_\xi^*$ of $\bar{\mu}_\xi$ as (2.43), which gives (2.45).

Step 3. The superdifferentials. Let $b > -r_0$. Then $\bar{\lambda}^{(b)}(\xi) < \infty$ by (4.18). By Proposition 4.4 and the duality,

$$(4.24) \quad \begin{aligned} [\underline{\lambda}^{(b)}(\xi), \bar{\lambda}^{(b)}(\xi)] &= \{\alpha \geq |\xi|_1 : \bar{\mu}_\xi(b) = \alpha g^{(b)}(\xi/\alpha)\} \\ &= \{\alpha \geq |\xi|_1 : \bar{\mu}_\xi(b) = \alpha g(\xi/\alpha) + \alpha b\} \\ &= \{\alpha \in \mathbb{R} : \bar{\mu}_\xi(b) = \alpha b - \bar{\mu}_\xi^*(\alpha)\} = \partial \bar{\mu}_\xi(b). \end{aligned}$$

Similarly

$$(4.25) \quad \begin{aligned} [\underline{\lambda}^{(-r_0)}(\xi), \infty) &= \{\alpha \geq |\xi|_1 : \bar{\mu}_\xi(-r_0) = \alpha g^{(-r_0)}(\xi/\alpha)\} \\ &= \{\alpha \in \mathbb{R} : \bar{\mu}_\xi(-r_0) = -\alpha r_0 - \bar{\mu}_\xi^*(\alpha)\} = \partial \bar{\mu}_\xi(-r_0). \end{aligned}$$

Fix $a > -r_0$ and let $b > a$. From $|\xi|_1 \leq \mu'_\xi(b \pm)$ given in (2.14), concavity, and Lemma 4.6,

$$|\xi|_1 \leq \bar{\mu}'_\xi(b \pm) \leq \frac{\bar{\mu}_\xi(b) - \bar{\mu}_\xi(a)}{b - a} \rightarrow |\xi|_1 \text{ as } b \rightarrow \infty.$$

□

5. MODIFICATION PROOFS FOR STRICT CONCAVITY

The modification arguments provide the power to go beyond soft results. In particular, these give us the strict concavity of the shape function in the shift variable (Theorem 2.2(ii)), the strict separation of $\underline{\lambda}(\xi)$ from $|\xi|_1$ (Theorem 2.11(ii)), and the strict exceedance of ℓ^1 distance by the geodesic length (Theorem 2.5).

5.1. Preparation for the modification arguments. We adapt to our goals the modification argument of van den Berg and Kesten [20]. Throughout this section $r_0 = \text{ess inf } t(e) \geq 0$.

An N -box B is by definition a rectangular subset of \mathbb{Z}^d of the form

$$(5.1) \quad B = \{x = (x_1, \dots, x_d) \in \mathbb{Z}^d : a_i \leq x_i \leq a_i + 3N \text{ for } i \in [d] \setminus k, a_k \leq x_k \leq a_k + N\}$$

for some $a = (a_1, \dots, a_d) \in \mathbb{Z}^d$ and $k \in [d]$. In other words, one of the dimensions of B has size N and the other $d - 1$ dimensions are of size $3N$. The two *large* $3N \times \dots \times 3N$ faces of B in (5.1) are the subsets

$$\{x \in B : x_k = a_k\} \quad \text{and} \quad \{x \in B : x_k = a_k + N\}.$$

The *interior* of B is defined by requiring $a_i < x_i < a_i + 3N$ and $a_k < x_k < a_k + N$ in (5.1). The boundary ∂B of B is the set of points of B that have a nearest-neighbor vertex in the complement of B . Our convention will be that an edge e lies in B if *both* its endpoints lie in B , otherwise $e \in B^c$. A suitable ℓ^1 -neighborhood around B is defined by

$$(5.2) \quad \bar{B} = \{x \in \mathbb{Z}^d : \exists y \in B : |x - y|_1 \leq 3N(d - 1) + N\}.$$

The significance of the choice $3N(d - 1) + N$ is that the ℓ^1 -distance from any point in B to the boundary of \bar{B} is at least as large as the distance between any two points in B .

Introduce two parameters $0 < s_0, \delta_0 < \infty$ whose choices are made precise later. Consider these conditions on the edge weights in B and \bar{B} :

$$(5.3) \quad \max_{e \in B} t(e) \leq s_0,$$

$$(5.4) \quad \sum_{e \in B} t(e) \leq s_0,$$

and

$$(5.5) \quad T(\pi) > (r_0 + \delta_0)|y - x|_1 \text{ for every self-avoiding path } \pi \text{ that stays entirely in } \overline{B} \\ \text{and whose endpoints } x \text{ and } y \text{ satisfy } |y - x|_1 \geq N.$$

The properties of a black box stated in the next definition depend on whether the weights are bounded or unbounded. We let $M_0 = \mathbb{P}\text{-ess sup } t(e)$.

DEFINITION 5.1 (Black box).

- (i) *In the case of bounded weights ($M_0 < \infty$), color a box B black if conditions (5.3) and (5.5) are satisfied.*
- (ii) *In the case of unbounded weights ($M_0 = \infty$), color a box B black if conditions (5.4) and (5.5) are satisfied.*

By choosing s_0 and N large enough and δ_0 small enough, the probability of a given B being black can be made as close to 1 as desired. This is evident for conditions (5.3) and (5.4). For condition (5.5) it follows from Lemma 5.5 in [20] that we quote here:

LEMMA 5.2. [20, Lemma 5.5] *Assume (2.6), that is, that the infimum of the passage time is subcritical. Then there exist constants $\delta_0 > 0$ and $D_0 > 0$ such that for all $x, y \in \mathbb{Z}^d$,*

$$(5.6) \quad \mathbb{P}\{T_{x,y} \leq (r_0 + \delta_0)|y - x|_1\} \leq e^{-D_0|y-x|_1}.$$

When $r_0 > 0$, Lemma 5.5 of [20] requires the weaker assumption $P\{t(e) = r_0\} < \vec{p}_c$ where \vec{p}_c is the critical probability of oriented bond percolation on \mathbb{Z}^d . However, since we consider shifts of weights that can turn r_0 into zero, it is simpler to assume (2.6) for all $r_0 \geq 0$ instead of keeping track when we might get by with the weaker assumption.

The probability of the complement of (5.5) is then bounded by

$$\mathbb{P}\{(5.5) \text{ fails}\} \leq \sum_{x, y \in \overline{B}: |y-x|_1 \geq N} \mathbb{P}\{T_{x,y} \leq (r_0 + \delta_0)|y - x|_1\} \leq C_d N^{2d} e^{-D_0 N}.$$

The bound above decreases for large enough N and hence gives us this conclusion:

$$(5.7) \quad \text{There exists a fixed } \delta_0 > 0 \text{ such that for any } \varepsilon > 0 \text{ there exist } N \text{ and } s_0 \\ \text{such that } \mathbb{P}\{\text{box } B \text{ is black}\} \geq 1 - \varepsilon \text{ while } \mathbb{P}\{t(e) \geq s_0\} > 0. \text{ Increasing } N \text{ and } s_0 \\ \text{while keeping } \delta_0 \text{ fixed cannot violate this condition as long as } \mathbb{P}\{t(e) \geq s_0\} > 0.$$

Condition $\mathbb{P}\{t(e) \geq s_0\} > 0$ is included above simply to point out that s_0 is not chosen so large that property (5.3) becomes trivial for bounded weights.

A nearest-neighbor path $\pi = (x_i)_{i=0}^n$ that lies in B is a *short crossing* of B if x_0 and x_n lie on opposite large faces of B . More generally, we say that

$$(5.8) \quad \text{a path } \pi \text{ crosses } B \text{ if some segment } \pi_{x_k, x_m} = (x_i)_{i=k}^m \text{ of } \pi \text{ is a short crossing of } B \\ \text{and neither endpoint of } \pi \text{ lies in } B.$$

The second part of the definition ensures that π genuinely “goes through” B .

Let \mathcal{B} be the countable set of all triples (B, v, w) where B is an N -box and v and w are two distinct points on the boundary of B . A path π has a (B, v, w) -crossing if (5.8) holds and v is the point where π first enters B and w is the point through which π last exits B . (Then the short crossing of B is some segment $\pi_{v', w'} \subset \pi_{v, w}$.) If π crosses B , then π has a (B, v, w) -crossing for some $(B, v, w) \in \mathcal{B}$ with (v, w) uniquely determined by π and B .

Partition the set \mathcal{B} of all elements (B, v, w) into K subcollections $\mathcal{B}_1, \dots, \mathcal{B}_K$ such that within each \mathcal{B}_j all boxes B are separated by distance N . Any particular box B appears at most once in

any particular \mathcal{B}_j . The number K of subcollections depends only on the dimension d and the size parameter N . The particular size N of the separation of boxes in \mathcal{B}_j is taken for convenience only. In the end what matters is that the boxes are separated and that once N is fixed, K is a constant.

Let $\mathbb{B}(0, r) = \{x \in \mathbb{Z}^d : |x|_1 \leq r\}$ denote the ℓ^1 -ball (diamond) of radius $\lfloor r \rfloor$ in \mathbb{Z}^d , with (inner) boundary $\partial\mathbb{B}(0, r) = \{x \in \mathbb{Z}^d : |x|_1 = \lfloor r \rfloor\}$. The lemma below is proved in Appendix C.

LEMMA 5.3. *By fixing s_0 and N large enough and δ_0 small enough as in (5.7), we can ensure the existence of constants $0 < \delta_1, D_1, n_1 < \infty$ such that, for all $n \geq n_1$,*

$$(5.9) \quad \mathbb{P}\left\{\begin{array}{l} \text{every lattice path } \pi \text{ from the origin to } \partial\mathbb{B}(0, n) \text{ has an index} \\ j(\pi) \in [K] \text{ such that } \pi \text{ has at least } \lfloor n\delta_1 \rfloor \text{ } (B, v, w)\text{-crossings} \\ \text{of black boxes } B \text{ such that } (B, v, w) \in \mathcal{B}_{j(\pi)} \end{array}\right\} \geq 1 - e^{-D_1 n}.$$

We turn to the modification argument for the strict concavity of μ_ξ claimed in Theorem 2.2.

5.2. **Strict concavity.** Let $\delta_0 > 0$ be the quantity in (5.5) in the definition of a black box. In addition to $t(e) \geq 0$ we consider two complementary assumptions on the weight distribution. Either the weights are unbounded:

$$(5.10) \quad M_0 = \infty$$

and satisfy a moment bound, or the weights are bounded and have a strictly positive support point close enough to the lower bound:

$$(5.11) \quad \begin{array}{l} \text{the support of } t(e) \text{ contains a point } r_1 \text{ that satisfies} \\ 0 < r_1 < r_0 + \delta_0 < M_0 < \infty. \end{array}$$

If $r_0 > 0$ we can choose $r_1 = r_0$. Let $\varepsilon_0 > 0$ be the constant that appears in Theorem 2.1 and in Theorem A.1, also equal to the constant δ in (4.10) for the shifted weights $\omega^{(-r_0)}$.

THEOREM 5.4. *Assume $r_0 \geq 0$ and (2.6), in other words, that weights are nonnegative and the infimum is subcritical. Furthermore, assume that one of these two cases holds:*

- (a) *Unbounded case: the weights satisfy (5.10) and the moment bound (2.7) with $p = 1$.*
- (b) *Bounded case: the weights satisfy (5.11).*

Then there exists a finite positive constant M and a function $D(b) > 0$ of $b > 0$ such that the following bounds hold for all $b \in (0, r_0 + \varepsilon_0)$ and all $|x|_1 \geq M$:

$$(5.12) \quad \text{(i) In the unbounded case (a),} \quad \mathbb{E}[T_{\mathbf{0}, x}^{(-b)}] \leq \mathbb{E}[T_{\mathbf{0}, x}] - b \mathbb{E}[\bar{L}_{\mathbf{0}, x}] - D(b)b|x|_1.$$

$$(5.13) \quad \text{(ii) In the bounded case (b),} \quad \mathbb{E}[T_{\mathbf{0}, x}^{(-b)}] \leq \mathbb{E}[T_{\mathbf{0}, x}] - b \mathbb{E}[\underline{L}_{\mathbf{0}, x}] - D(b)b|x|_1.$$

Condition (2.7) with $p = 1$ guarantees that the expectation $\mathbb{E}[T_{\mathbf{0}, x}]$ above is finite (Lemma 2.3 in [2]). This together with Lemma A.3 then implies that $\mathbb{E}[T_{\mathbf{0}, x}^{(-b)}]$ is finite for $b \in (0, r_0 + \varepsilon_0)$. Since $\mathbb{E}[\bar{L}_{\mathbf{0}, x}] \geq \mathbb{E}[\underline{L}_{\mathbf{0}, x}]$, (5.12) provides a better bound than (5.13). This is due to the fact that the modification argument gives sharper control of the geodesic under unbounded weights.

Our modification proofs force the geodesic to follow explicitly constructed paths. These paths are parametrized by two integers k and ℓ whose choice is governed by the support of $t(e)$ through the lemma below.

LEMMA 5.5. *Fix reals $0 < r < s$ and $b > 0$. Then there exist arbitrarily large positive integers k, ℓ such that*

$$(5.14) \quad k(s + \delta) < (k + 2\ell)(r - \delta) < (k + 2\ell)(r + \delta) < k(s - \delta) + (2\ell - 1)b$$

holds for sufficiently small real $\delta > 0$.

Proof. It suffices to show the existence of arbitrarily large positive integers k, ℓ that satisfy the strict inequalities

$$(5.15) \quad ks < (k + 2\ell)r < ks + (2\ell - 1)b$$

and then choose $\delta > 0$ small enough. Let $0 < \varepsilon < b/r$ and choose an integer $m > 2/\varepsilon$. Then for each $k \in \mathbb{N}$ there exists $\ell \in \mathbb{N}$ such that

$$(5.16) \quad k\left(\frac{s}{r} - 1\right) < 2\ell < k\left(\frac{s}{r} - 1\right) + m\varepsilon,$$

and k and ℓ can be taken arbitrarily large. Rearranging (5.16) and remembering the choice of ε gives

$$ks < (k + 2\ell)r < ks + m\varepsilon r < ks + mb.$$

To get (5.15), take k and ℓ large enough to have $m < 2\ell - 1$. □

Proof of Theorem 5.4. The proof has three stages. The first and the last are common to bounded and unbounded weights. The most technical middle stage has to be tailored separately to the two cases. We present the stages in their logical order, with separate cases for the middle stage.

Stage 1 for both bounded and unbounded weights.

Let $\pi(x)$ be a geodesic for $T_{\mathbf{0},x}$. When geodesics are not unique, $\pi(x)$ will be chosen in particular measurable ways that are made precise later in the proofs. Assume that $|x|_1 \geq n_1$ so that Lemma 5.3 applies with $n = |x|_1$. The event in (5.9) lies in the union

$$\bigcup_{j=1}^K \{\pi(x) \text{ crosses at least } \lfloor |x|_1 \delta_1 \rfloor \text{ black boxes from } \mathcal{B}_j\}.$$

By (5.9), there is a *nonrandom* index $j(x) \in [K]$ such that

$$(5.17) \quad \mathbb{P}\{\pi(x) \text{ crosses at least } \lfloor |x|_1 \delta_1 \rfloor \text{ black boxes from } \mathcal{B}_{j(x)}\} \geq \frac{1 - e^{-D_1|x|_1}}{K}.$$

Define the event

$$(5.18) \quad \Lambda_{B,v,w,x} = \{B \text{ is black and } \pi(x) \text{ has a } (B, v, w)\text{-crossing}\}.$$

Consequently

$$(5.19) \quad \mathbb{P}\{\Lambda_{B,v,w,x} \text{ occurs for at least } \lfloor |x|_1 \delta_1 \rfloor \text{ elements } (B, v, w) \in \mathcal{B}_{j(x)}\} \geq \frac{1 - e^{-D_1|x|_1}}{K}.$$

Turn this into a lower bound on the expected number of events, with a new constant $D_1 > 0$:

$$(5.20) \quad \sum_{(B,v,w) \in \mathcal{B}_{j(x)}} \mathbb{P}(\Lambda_{B,v,w,x}) = \mathbb{E}[\#\{(B, v, w) \in \mathcal{B}_{j(x)} : \Lambda_{B,v,w,x} \text{ occurs}\}] \geq D_1|x|_1.$$

The next Stage 2 of the proof shows that, after a modification of the environment on a black box, the geodesic encounters a $k + 2\ell$ *detour* whose weights are determined by the modification. By this we mean that the geodesic runs through a straight-line k -step path segment of the form $\pi^+ = (\pi_0^+ + i\mathbf{u})_{0 \leq i \leq k}$ parallel to an integer unit vector $\mathbf{u} \in \{\pm \mathbf{e}_i\}_{i=1}^d$, with some initial vertex π_0^+ . A $k + 2\ell$ detour associated to π^+ is a path $\pi^{++} = (\pi_i^{++})_{0 \leq i \leq k+2\ell}$ that shares both endpoints with π^+

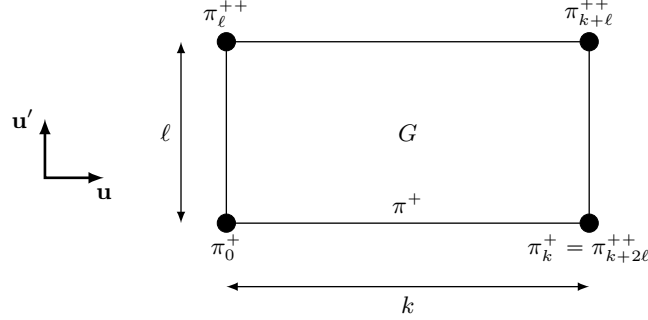

FIGURE 5.1. Illustration of (5.21): \mathbf{u} and \mathbf{u}' are two perpendicular unit vectors in \mathbb{Z}^d , π^+ is a path that takes k \mathbf{u} -steps, while the detour π^{++} first takes ℓ \mathbf{u}' -steps, followed by k \mathbf{u} -steps, and last ℓ $(-\mathbf{u}')$ -steps. The detour rectangle G is bounded by these paths.

and translates the k -segment by ℓ steps in a direction perpendicular to \mathbf{u} : so for some integer unit vector $\mathbf{u}' \perp \mathbf{u}$,

$$(5.21) \quad \pi_i^{++} = \begin{cases} \pi_0^+ + i\mathbf{u}', & 0 \leq i \leq \ell \\ \pi_0^+ + \ell\mathbf{u}' + (i - \ell)\mathbf{u}, & \ell + 1 \leq i \leq k + \ell \\ \pi_0^+ + \ell\mathbf{u}' + k\mathbf{u} - (i - k - \ell)\mathbf{u}', & k + \ell + 1 \leq i \leq k + 2\ell. \end{cases}$$

In particular, π^+ and π^{++} are edge-disjoint while they share their endpoints.

The $k \times \ell$ rectangle $G = [\pi_0^+, \pi_0^+ + k\mathbf{u}] \times [\pi_0^+, \pi_0^+ + \ell\mathbf{u}']$ enclosed by π^+ and π^{++} will be called a *detour rectangle*. Its relative boundary on the plane spanned by $\{\mathbf{u}, \mathbf{u}'\}$ is $\partial G = \pi^+ \cup \pi^{++}$. Throughout we use superscripts $+$ and $++$ to indicate objects associated with the two portions of the boundaries of detour rectangles G . Figure 5.1 illustrates.

Stage 2 is undertaken separately for bounded and unbounded weights.

Stage 2 for bounded weights.

LEMMA 5.6. *Assume (5.11). For $i \in \{0, 1, 2\}$ there exist nondecreasing sequences $\{s_i(q)\}_{q \in \mathbb{N}}$ with the following properties:*

$$(5.22) \quad r_0 + \delta_0 < s_0(q) \leq s_1(q) \leq s_2(q) = M_0,$$

$$(5.23) \quad \lim_{q \rightarrow \infty} s_0(q) = M_0 \quad \text{and} \quad \lim_{q \rightarrow \infty} \mathbb{P}\{t(e) \leq s_0(q)\} = 1,$$

$$(5.24) \quad \text{for } \varepsilon > 0 \text{ and } q \in \mathbb{N}, \quad \mathbb{P}\{s_0(q) - \varepsilon \leq t(e) \leq s_0(q)\} > 0,$$

$$(5.25) \quad \text{and for } i \in \{0, 1\} \text{ and } q \in \mathbb{N}, \quad \mathbb{P}\{s_i(q) \leq t(e) \leq s_{i+1}(q)\} > 0.$$

Proof. If $\mathbb{P}\{t(e) = M_0\} > 0$ then let $s_i(q) = M_0$ for all i and q . So suppose $\mathbb{P}\{t(e) = M_0\} = 0$.

Let $s_0(0) = r_0 + \delta_0$. For $q \geq 1$ define inductively $s_0(q)$ in the interval $(s_0(q-1) \vee (M_0 - q^{-1}), M_0)$ so that $\mathbb{P}\{s_0(q) - \varepsilon \leq t(e) \leq s_0(q)\} > 0$ for all $\varepsilon > 0$. This can be done as follows. Let $s_0(q)$ be an atom of $t(e)$ in $(s_0(q-1) \vee (M_0 - q^{-1}), M_0)$ if one exists. If not, the c.d.f. of $t(e)$ is continuous in this interval and we take $s_0(q)$ to be a point of strict increase which must exist.

Then $s_0(q) \rightarrow M_0$ and thus $\mathbb{P}\{t(e) \leq s_0(q)\} \rightarrow 1$. Furthermore, $\mathbb{P}\{t(e) > s_0(q)\} > 0$ for all q because $s_0(q) < M_0$. Pick $s'(q) \in [s_0(q), M_0)$ so that $\mathbb{P}\{s_0(q) \leq t(e) \leq s'(q)\} > 0$. Define a nondecreasing sequence by $s_1(q) = \max_{j \leq q} s'(j)$. Since $s_1(q) < M_0$ we have $\mathbb{P}\{t(e) > s_1(q)\} > 0$. \square

We fix various parameters for this stage of the proof. Fix $b \in (0, r_1)$ and determine k, ℓ, δ' by applying Lemma 5.5 to $0 < b < r_1 < M_0$ to have

$$(5.26) \quad k(M_0 + \delta') < (k + 2\ell)(r_1 - \delta') < (k + 2\ell)(r_1 + \delta') < k(M_0 - \delta') + (2\ell - 1)b.$$

Since $s_0(q) \rightarrow M_0$ from below, we can fix q large enough and $\delta \in (0, \delta')$ small enough so that

$$(5.27) \quad k(s_0 + \delta) < (k + 2\ell)(r_1 - \delta) < (k + 2\ell)(r_1 + \delta) < k(s_0 - \delta) + (2\ell - 1)b$$

holds for $s_0 = s_0(q)$. Note that this continues to hold if we increase q to take s_0 closer to M_0 or decrease δ .

Take N large enough, $\delta_0 > 0$ small enough, and q large enough so that the crossing bound (5.9) of Lemma 5.3 is satisfied for the choice $s_0 = s_0(q)$. Drop q from the notation and henceforth write $s_i = s_i(q)$.

Shrink $\delta > 0$ further so that

$$(5.28) \quad r_1 + \delta < r_0 + \delta_0$$

and

$$(5.29) \quad (\ell + 1)s_0 > (\ell + 1)(r_1 + \delta) + k\delta.$$

The construction to come will attach $k + 2\ell$ detours to edges of cubes. The number of such attachments per edge is given by the parameter

$$k_0 = \left\lceil \frac{30dM_0}{r_0 + \delta_0 - r_1 - \delta} \right\rceil + 2.$$

Let m_1 be an even positive integer and define two constants

$$(5.30) \quad c_1 = 2ks_0 + 2m_1(r_1 + \delta)$$

and

$$(5.31) \quad c_2 = r_0 + \delta_0 - \left((r_1 + \delta) \frac{m_1}{m_1 + k} + s_0 \frac{k}{m_1 + k} \right).$$

We have the lower bound

$$c_2 \geq c'_2 = r_0 + \delta_0 - \left((r_1 + \delta) \frac{m_1}{m_1 + k} + M_0 \frac{k}{m_1 + k} \right).$$

Fix m_1 large enough so that

$$(5.32) \quad m_1 \geq \frac{16\ell M_0}{r_0 + \delta_0 - r_1 - \delta},$$

$$(5.33) \quad m_1(r_1 - \delta) > (k + 2\ell)(r_1 + \delta),$$

$$(5.34) \quad c'_2 > 0 \quad \text{and} \quad \frac{c'_2(k_0(m_1 + k) - 2\ell)}{6dM_0} \geq 4m_1 + 3(k + 1)(\ell + 1).$$

Note that after fixing m_1 , (5.32) and (5.33) remain true as we shrink δ and (5.34) remains true with c_2 in place of c'_2 as we increase s_0 towards M_0 .

Set three size-determining integer parameters as

$$(5.35) \quad \ell_1 = k_0(m_1 + k), \quad \ell'_2 = \ell_1 - 2\ell, \quad \text{and} \quad \ell''_2 = 3\ell'_2.$$

Set

$$(5.36) \quad m_2 = \left\lfloor \frac{c_2 \ell'_2}{6dM_0} \right\rfloor = \left\lfloor \frac{c_2(k_0(m_1 + k) - 2\ell)}{6dM_0} \right\rfloor \geq 4m_1 + 3(k + 1)(\ell + 1)$$

where we appealed to (5.34).

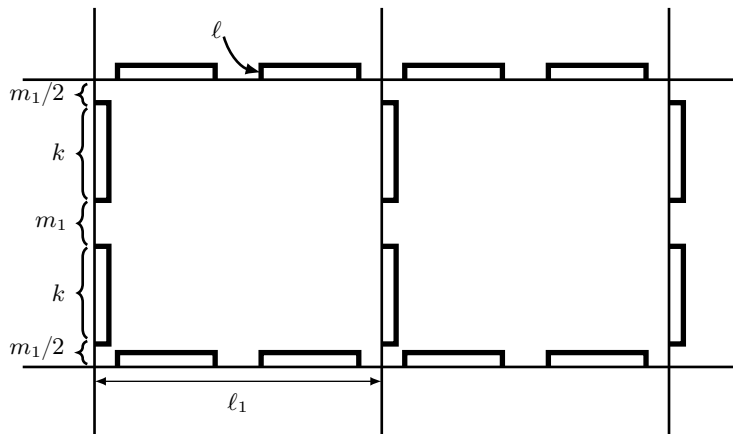

FIGURE 5.2. $k + 2\ell$ -detours attached to the south and west boundaries of $\ell_1 \times \ell_1$ 2-faces. In this illustration each edge has $k_0 = 2$ detours attached to it, spaced m_1 apart.

As the last step fix N so that $N - 2\ell'_2$ is a multiple of ℓ_1 and large enough so that

$$(5.37) \quad Q = c_2 N - 4d(\ell'_2 + \ell_1)M_0 - c_1 \geq c_2 N/2.$$

Increasing N may force us to take s_0 closer to M_0 to maintain the crossing bound (5.9). As observed above, this can be done while maintaining all the inequalities above.

We perform a construction within each N -box B . Let V be a box inside B that is tiled with cubes V_i of the form $\prod_{j=1}^d [u_j, u_j + \ell_1]$ where $(u_1, \dots, u_d) \in \mathbb{Z}^d$ is the lower left corner of the cube and the side-length ℓ_1 comes from (5.35). The cubes V_i are nonoverlapping but neighboring cubes share a $(d-1)$ -dimensional face. Then, $V = \bigcup_{i=1}^{\alpha} V_i$ where $\alpha = 3^{d-1} \ell_1^{-d} (N - 2\ell'_2)^d$ is the number of cubes required to tile V . Inside box B , V is surrounded by an annular region $B \setminus V$ whose thickness (perpendicular distance from a face of V to B^c) is ℓ'_2 in the direction where B has width N and ℓ'_2 in the other directions.

A *boundary edge* of a cube V_j is one of the $2^{d-1}d$ line segments (one-dimensional faces) of length ℓ_1 that lie on the boundary ∂V_j .

Attach $(k + 2\ell)$ -detours along each of the boundary edges of the tiling so that the k -path π^+ is on the boundary edge and the detour π^{++} is in the interior of one of the two-dimensional faces adjacent to this boundary edge. Adopt the convention that if the boundary edge is $[v, v + \ell_1 \mathbf{e}_i]$ then the detour lies on the 2-dimensional face $[v, v + \ell_1 \mathbf{e}_i] \times [v, v + \ell_1 \mathbf{e}_j]$ for some $j \neq i$ (in other words, the detour points into a positive coordinate direction). See Figure 5.2.

Place k_0 detours on each boundary edge of the tiling so that the detours are exactly distance m_1 apart from each other and a detour that is right next to a corner vertex of the tiling is exactly distance $m_1/2$ from that vertex. This is consistent with the definition of ℓ_1 in (5.35).

Since $m_1/2 > \ell$ by (5.11) and (5.32), distinct detour rectangles that happen to lie on the same two-dimensional face do not intersect and the points on a detour are closer to the boundary edge of the detour than to any other boundary edge.

Inside a particular N -box B , for $j \in \{0, 1, 2\}$ let W_j denote the union of the j -dimensional faces of the cubes $\{V_i\}$ tiling V . Let W'_1 be the union of W_1 (the boundary edges) and the detours π^{++} attached to the boundary edges.

We describe in more detail the structure of the detours on the two-dimensional faces inside a particular B . Let $H \subset W_2$ be a two-dimensional $\ell_1 \times \ell_1$ face. For simplicity of notation suppose $H = [0, \ell_1 \mathbf{e}_1] \times [0, \ell_1 \mathbf{e}_2]$. Assume without loss of generality that the boundary edge $[0, \ell_1 \mathbf{e}_1]$ has its

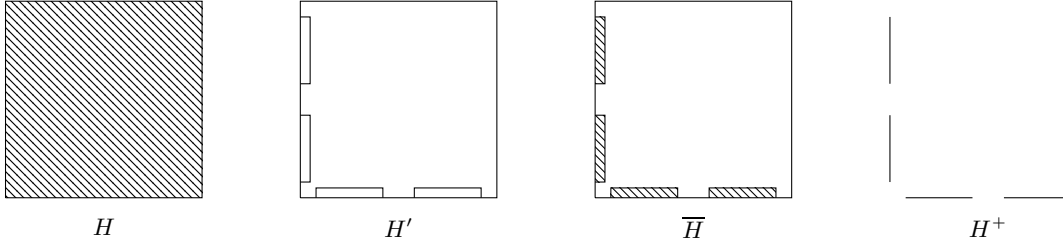

FIGURE 5.3. From left to right: a two-dimensional face H (shaded), H' that consists of the boundary ∂H of H and the boundaries of the detour rectangles in H , \overline{H} that consists of ∂H and the full (shaded) detour rectangles in H , and finally H^+ that consists of the π^+ -parts of the boundaries of the detour rectangles in H .

detours contained in H . For $i \in [k_0]$ define the i th detour rectangle:

$$G_{i,S} = [(m_1/2 + (i-1)(k+m_1))\mathbf{e}_1, (m_1/2 + (i-1)(k+m_1) + k)\mathbf{e}_1] \times [0, \ell\mathbf{e}_2].$$

The subscript S identifies these detour rectangles as attached to the southern boundary of H . Similarly, if the detour rectangles attached to the western boundary of H lie in H , we denote these by $\{G_{i,W} : 1 \leq i \leq k_0\}$.

For a label $U \in \{S, W\}$, let $\pi_{i,U}^{++} = \partial G_{i,U} \setminus \partial H$ be the portion of the boundary of $G_{i,U}$ in the interior of H . $\pi_{i,U}^{++}$ is the detour path of $k + 2\ell$ edges. Let $\pi_{i,U}^+ = \partial G_{i,U} \cap \partial H$ be the portion of the boundary of $G_{i,U}$ that lies on the boundary of H . $\pi_{i,U}^+$ is a straight path of k edges, the path bypassed by the detour. Let

$$(5.38) \quad H' = \partial H \cup \bigcup_{\substack{1 \leq i \leq k_0 \\ U \in \{S, W\}}} \partial G_{i,U}, \quad \overline{H} = \partial H \cup \bigcup_{\substack{1 \leq i \leq k_0 \\ U \in \{S, W\}}} G_{i,U}, \quad \text{and} \quad H^+ = \bigcup_{\substack{1 \leq i \leq k_0 \\ U \in \{S, W\}}} \pi_{i,U}^+.$$

See Figure 5.3. Let \overline{W}_1 (resp. W_1^+) be the union of all \overline{H} (resp. H^+) as H ranges over all the two-dimensional faces that lie in W_2 . The union of all H' equals W_1' as already defined above.

Since multiple geodesics are possible, we have to make a particular measurable choice of a geodesic to work on and one that relates suitably to the structure defined above. For this purpose order the admissible steps for example as in

$$(5.39) \quad \emptyset < \mathbf{e}_1 < -\mathbf{e}_1 < \mathbf{e}_2 < -\mathbf{e}_2 < \cdots < \mathbf{e}_d < -\mathbf{e}_d$$

and then order the paths lexicographically. Here \emptyset stands for a missing step. So if π' extends π with one or more steps, then $\pi < \pi'$ in lexicographic ordering. Recall the choice of index $j(x)$ in (5.17).

LEMMA 5.7. Fix $x \in \mathbb{Z}^d \setminus \{\mathbf{0}\}$. There exists a unique geodesic π for $T_{\mathbf{0},x}$ that satisfies the following two conditions.

- (i) For every N -box $B \in \mathcal{B}_{j(x)}$ and points $u, v \in \pi_B = \pi \cap B$ the following holds: if both $u, v \in \overline{W}_1$ or $u \in \overline{W}_1$ and $v \in \partial B$ (or vice versa), and if every edge of $\pi_{u,v}$ lies in B but not in \overline{W}_1 , then there is no geodesic between u and v that remains in B , uses only edges with strictly positive weights, and uses at least one edge in \overline{W}_1 .
- (ii) π is lexicographically first among all geodesics of $T_{\mathbf{0},x}$ that satisfy point (i).

Proof. It suffices to show the existence of a geodesic that satisfies point (i). Point (ii) then picks a unique one.

Start with any $T_{\mathbf{0},x}$ -geodesic π of maximal Euclidean length. For the purpose of this proof consider π as an ordered sequence of vertices and the edges connecting them.

Consider in order each segment $\pi_{u,v}$ that violates point (i). When this violation happens, there is a particular N -box $B \in \mathcal{B}_{j(x)}$ such that $\pi_{u,v} \subset B \setminus \overline{W}_1$ and there is an alternative geodesic $\pi'_{u,v} \subset B$ that uses only edges with strictly positive weights and uses at least one edge in \overline{W}_1 . Replace the original segment $\pi_{u,v}$ with $\pi'_{u,v}$.

Since we replaced one geodesic segment with another, $T(\pi'_{u,v}) = T(\pi_{u,v})$. Suppose that after the replacement, the full path is no longer self-avoiding. Then a portion of it can be removed and this portion contains part of $\pi'_{u,v}$. Since $\pi'_{u,v}$ uses only edges with strictly positive weights, this removal reduces the passage time by a strictly positive amount, contradicting the assumption that the original passage time was optimal. Consequently the new path is still a self-avoiding geodesic.

Since the original path was a geodesic of maximal Euclidean length, it follows that $|\pi'_{u,v}| \leq |\pi_{u,v}|$. Since the replacement inserted into the geodesic at least one new edge from \overline{W}_1 , $\pi'_{u,v}$ has strictly fewer edges in $B \setminus \overline{W}_1$ than $\pi_{u,v}$.

The new segment $\pi'_{u,v}$ may in turn contain smaller segments $\pi'_{u_1,v_1}, \dots, \pi'_{u_m,v_m}$ that violate point (i). Replace each of these with alternative segments $\pi''_{u_1,v_1}, \dots, \pi''_{u_m,v_m}$. Continue like this until the entire path segment between u and v has been cleaned up, in the sense that no smaller segment of it violates (i). This process must end because each replacement leaves strictly shorter segments that can potentially violate point (i).

Observe that the clean-up of the segment $\pi_{u,v}$ happens entirely inside the particular N -box B , does not alter the endpoints u, v of the original segment, and does not alter the other portions $\pi_{0,u}$ and $\pi_{v,x}$ of the geodesic because each replacement step produced a self-avoiding geodesic.

Proceed in this manner through all the path segments that are in violation of point (i). There are only finitely many. At the conclusion of this process we have a geodesic that satisfies point (i). \square

Define the event

$$(5.40) \quad \Gamma_B = \left\{ \begin{aligned} \omega : r_1 - \delta < t(e) < r_1 + \delta \quad \forall e \in W'_1 \setminus W_1^+, \\ s_0 - \delta < t(e) \leq s_0 \quad \forall e \in W_1^+, \\ s_0 \leq t(e) \leq s_1 \quad \forall e \in \overline{W}_1 \setminus W'_1, \\ s_1 \leq t(e) \leq M_0 \quad \forall e \in B \setminus \overline{W}_1 \end{aligned} \right\}.$$

A key consequence of the definition of the event Γ_B is that, by (5.27), the boundary paths π^+ and π^{++} of all detour rectangles G in W'_1 satisfy

$$(5.41) \quad T(\pi^+) < T(\pi^{++}) < T(\pi^+) + (2\ell - 1)b.$$

Once the parameters have been fixed, then up to translations and rotations there are only finitely many ways to choose the constructions above. Thus

$$(5.42) \quad \exists D_2 > 0 \text{ such that } \mathbb{P}(\Gamma_B) \geq D_2 \text{ for all } B.$$

D_2 depends on N and the probabilities of the events on $t(e)$ that appear in Γ_B . In particular, D_2 does not depend on x .

Our point of view shifts now to the implications of the event Γ_B for a particular $B \in \mathcal{B}_{j(x)}$.

Let γ be a self-avoiding path in W_1 . Then if $\omega \in \Gamma_B$,

$$(5.43) \quad T(\gamma) \leq |\gamma|_1 \left(s_0 \frac{k}{m_1 + k} + (r_1 + \delta) \frac{m_1}{m_1 + k} \right) + c_1$$

where c_1 came from (5.30). The main term on the right of (5.43) contains the weights of the k -paths of detours and m_1 -gaps completely covered by γ , and c_1 accounts for the partially covered pieces at either end of γ .

We say that a point $y \in \overline{W}_1$ is *associated* with a boundary edge I of a cube V_{i_0} if either $y \in I$ or y lies in one of the detour rectangles $G_{i,U}$ attached to the edge I . We say that points $y, z \in \overline{W}_1$ are (ℓ^1, W_1) -*related* if they are each associated to boundary edges $I \subset V_{i_0}$ and $J \subset V_{j_0}$ such that every point on I can be connected to every point on J by an ℓ^1 -path that remains entirely within W_1 . Recall that an ℓ^1 -path $x_{m:n}$ satisfies $|x_n - x_m|_1 = n - m$.

LEMMA 5.8. *Let $\omega \in \Gamma_B$. Let $y, z \in \overline{W}_1$ be two (ℓ^1, W_1) -related points. Suppose a geodesic between y and z lies within B . Then there exists a geodesic between y and z that stays within B and uses at least one edge in \overline{W}_1 .*

Proof. There are two cases:

- (A) y, z are connected by an ℓ^1 -path inside \overline{W}_1 .
- (B) y, z cannot be connected by an ℓ^1 -path that remains entirely inside \overline{W}_1 .

In case (A), any ℓ^1 -path inside \overline{W}_1 takes weights that are at most s_1 and any path inside $B \setminus \overline{W}_1$ takes weights that are at least s_1 . Since we assume the existence of a geodesic between y and z that lies entirely inside B , we see that there must exist a geodesic that remains entirely within \overline{W}_1 .

In case (B), suppose $\hat{\pi} \subset B$ is a self-avoiding path between y and z that lies outside \overline{W}_1 . Construct a path $\pi' \subset \overline{W}_1$ from y to z by concatenating the following path segments: using at most ℓ steps, connect y to the closest point y' on the boundary edge I that y is associated with; using at most ℓ steps, connect z to the closest point z' on the boundary edge J that z is associated with; connect y' to z' with an ℓ^1 -path π'' in W_1 . We show that $T(\pi') \leq T(\hat{\pi})$, thus proving the lemma.

We argue that

$$(5.44) \quad \pi'' \text{ uses at least } m_1/2 \text{ edges in } W_1' \setminus W_1^+.$$

Indeed, observe that y and z cannot both be on W_1 nor both in the same detour rectangle $G_{i,U}$, for otherwise we would be in case (A). On the other hand, if y is in a detour rectangle and z is on W_1 , then π'' is an ℓ^1 -path that connects y' to $z' = z$. If in this case $|\pi'' \cap (W_1' \setminus W_1^+)|_1 < m_1/2$, then it must be the case that $\pi'' \subset I = J$. But then in this case π' is an ℓ^1 -path from y to z and we are again in case (A). The symmetric case of $y \in W_1$ and z in a detour rectangle is similar. Lastly, if y and z belong to different detour rectangles, then the segment of π'' that connects the two rectangles must be of length at least m_1 , the distance between two neighboring detours.

We have verified (5.44). From (5.44) and $m_1 \geq 8\ell$ comes the lower bound

$$|z - y|_1 \geq m_1/2 - 2\ell \geq m_1/4.$$

The $m_1/2$ edges in $\pi'' \cap (W_1' \setminus W_1^+)$ all have weight at most $r_1 + \delta$. Furthermore, $|\pi''|_1 \leq |z - y|_1 + 2\ell$ and all the edges along π'' have weight no larger than s_0 . This gives the bound

$$T(\pi'') \leq m_1(r_1 + \delta)/4 + (|z - y|_1 - m_1/4 + 2\ell)s_0.$$

Since $\hat{\pi}$ connects y to z and the weights along $\hat{\pi}$ are at least s_1 ,

$$T(\hat{\pi}) \geq m_1 s_1/4 + (|z - y|_1 - m_1/4)s_1.$$

Together these observations give the lower bound

$$T(\hat{\pi}) - T(\pi'') \geq m_1(s_1 - (r_1 + \delta))/4 - 2\ell s_0.$$

From this,

$$T(\pi') \leq T(\pi'') + 2\ell s_1 \leq T(\hat{\pi}) - m_1(s_1 - (r_1 + \delta))/4 + 4\ell s_1 < T(\hat{\pi}).$$

The last inequality used (5.32) and $r_1 + \delta < r_0 + \delta_0 < s_1 \leq M_0$. □

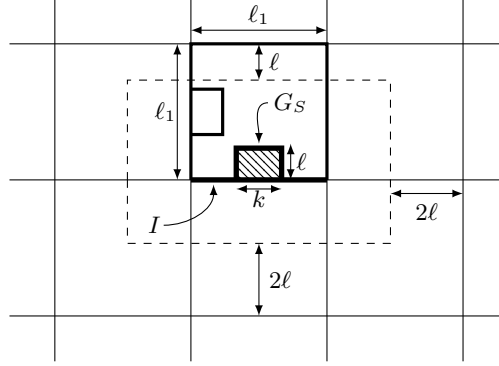

FIGURE 5.4. The proof of Lemma 5.9. The light grid is W_1 . The thicker square and its two detours are part of \overline{W}_1 . The thickest edge of the square is denoted by I . The hashed box, denoted by G_S , is a detour rectangle attached to I . The points that are within distance $\ell_1 - 2\ell$ from a point on $I \cup G_S$ are all inside the dashed rectangle. All these points that are also on W_1 can be reached from any point on I via an ℓ^1 path that stays on W_1 .

LEMMA 5.9. *Let $\omega \in \Gamma_B$. Suppose $y, z \in \overline{W}_1$ are not (ℓ^1, W_1) -related and that they are connected by a path $\hat{\pi}$ that remains entirely in $B \setminus \overline{W}_1$. Then*

$$T(\hat{\pi}) \geq s_1(\ell_1 - 2\ell).$$

Proof. Inspection of Figure 5.4 convinces that any two points $y, z \in \overline{W}_1$ such that $|z - y|_1 < \ell_1 - 2\ell$ must be (ℓ^1, W_1) -related. Thus $|\hat{\pi}|_1 \geq \ell_1 - 2\ell$ and by assumption it uses only weights $\geq s_1$. \square

LEMMA 5.10. *Let $\omega \in \Gamma_B$ and $y, z \in B$. Assume that either both $y, z \in \overline{W}_1$ or that $y \in \overline{W}_1$ and $z \in \partial B$. Let π be a geodesic between y and z . Assume that the edges of π lie entirely outside \overline{W}_1 . Then either there is a geodesic between y and z inside B that uses at least one edge in \overline{W}_1 or*

$$(5.45) \quad T(\pi) \geq \min\{s_1(\ell_1 - 2\ell), s_1\ell'_2\} = s_1\ell'_2.$$

Proof. If π reaches the boundary ∂B (in either case of y, z) then π must travel through $B \setminus V$ and consequently $T(\pi) \geq s_1\ell'_2$. The other possibility is that π stays inside $B \setminus \overline{W}_1$. If y and z are (ℓ^1, W_1) -related then Lemma 5.8 gives a geodesic in B that uses an edge in \overline{W}_1 . If y and z are not (ℓ^1, W_1) -related, Lemma 5.9 gives $T(\pi) \geq s_1(\ell_1 - 2\ell)$. The last equality of (5.45) is from (5.35). \square

Henceforth we often work with two coupled environments ω and ω^* . Quantities calculated in the ω^* environment will be marked with a star if ω^* is not explicitly present. For example, $T_{\mathbf{0},x}^* = T_{\mathbf{0},x}(\omega^*)$ denotes the passage time between $\mathbf{0}$ and x in the environment ω^* .

Recall the event $\Lambda_{B,v,w,x}$ defined in (5.18).

LEMMA 5.11. *Let ω and ω^* be two environments that agree outside B and satisfy $\omega \in \Lambda_{B,v,w,x}$ and $\omega^* \in \Gamma_B$. Then there exists a self-avoiding path $\tilde{\pi}$ from $\mathbf{0}$ to x such that*

$$T^*(\tilde{\pi}) \leq T(\pi(x)) - Q.$$

Proof. Since box B is black on the event $\Lambda_{B,v,w,x}$,

$$T(\pi_{v,w}(x)) > (r_0 + \delta_0)(|w - v|_1 \vee N).$$

The bound above comes from (5.5), on account of these observations: regardless of whether $\pi_{v,w}(x)$ exits \overline{B} , there is a segment inside \overline{B} of length $|w - v|_1$, and furthermore $\pi_{v,w}(x)$ contains a short crossing of B that has length at least N .

Define a path π' from v to w in B as follows. Let λ_1 be an ℓ^1 -path from v to some point $a \in W_1$. Similarly, let λ_3 be an ℓ^1 -path from w to some $b \in W_1$. These paths satisfy $|\lambda_1|_1 \vee |\lambda_3|_1 \leq d\ell_2'' + (d-2)\ell_1$. Let λ_2 be a shortest path from a to b that remains in W_1 . Since $|a-b|_1 \leq |v-w|_1 + 2d\ell_2'' + 2(d-2)\ell_1$, $|\lambda_2|_1 \leq |v-w|_1 + 2d\ell_2'' + 2d\ell_1$. (To go from a to b along W_1 use $2\ell_1$ steps to go from a and b to the nearest vertices a' and b' in W_0 , respectively, and an ℓ^1 -path along W_1 will take $|a'-b'|_1 \leq |a-b|_1 + 2\ell_1$ steps.)

Let π' be the concatenation of λ_1 , λ_2 and λ_3 . Define $\tilde{\pi}$ as the concatenation of $\pi_{\mathbf{0},v}(x)$, π' , and $\pi_{w,x}(x)$. The next calculation uses (5.43), (5.37) and (5.31), and the facts that $\omega = \omega^*$ outside B , $\omega \in \Lambda_{B,v,w,x}$ and $\omega^* \in \Gamma_B$.

$$\begin{aligned}
T(\pi(x)) - T^*(\tilde{\pi}) &= T(\pi_{v,w}(x)) - T^*(\pi') \\
&\geq (r_0 + \delta_0) \max(|v-w|_1, N) - 2(d\ell_2'' + (d-2)\ell_1)M_0 \\
&\quad - (|v-w|_1 + 2d\ell_2'' + 2d\ell_1) \left(s_0 \frac{k}{m_1 + k} + (r_1 + \delta) \frac{m_1}{m_1 + k} \right) - c_1 \\
&\geq (r_0 + \delta_0) \max(|v-w|_1, N) - 2(d\ell_2'' + (d-2)\ell_1)M_0 \\
&\quad - (\max(|v-w|_1, N) + 2d\ell_2'' + 2d\ell_1) \left(s_0 \frac{k}{m_1 + k} + (r_1 + \delta) \frac{m_1}{m_1 + k} \right) - c_1 \\
&= (r_0 + \delta_0) \max(|v-w|_1, N) - 2(d\ell_2'' + (d-2)\ell_1)M_0 \\
&\quad - (\max(|v-w|_1, N) + 2d\ell_2'' + 2d\ell_1)(r_0 + \delta_0 - c_2) - c_1 \\
&= c_2 \max(|v-w|_1, N) - 2(d\ell_2'' + (d-2)\ell_1)M_0 - (2d\ell_2'' + 2d\ell_1)(r_0 + \delta_0) - c_1 \\
&\geq c_2 N - 4d(\ell_2'' + \ell_1)M_0 - c_1 = Q.
\end{aligned}$$

In the first inequality, $2(d\ell_2'' + (d-2)\ell_1)M_0$ bounds the time spent on λ_1 and λ_3 and the remaining negative terms bound the passage time of λ_2 . The lemma is proved. \square

Henceforth we assume that $\omega \in \Lambda_{B,v,w,x}$ and $\omega^* \in \Gamma_B$. Let $\pi^*(x)$ be the geodesic from $\mathbf{0}$ to x in the ω^* -environment specified in Lemma 5.7. By Lemma 5.11,

$$(5.46) \quad T^*(\pi^*(x)) \leq T^*(\tilde{\pi}) \leq T(\pi(x)) - Q \leq T(\pi^*(x)) - Q.$$

This implies that $\pi^*(x)$ must use edges in $\overline{W_1}$ because ω and ω^* agree outside B , while $t(e) \leq s_0 \leq s_1 \leq t^*(e)$ on edges in $B \setminus \overline{W_1}$.

Let a_0 be the first vertex of $\pi^*(x)$ in B , a_1 the first vertex of $\pi^*(x)$ in $\overline{W_1}$, and b_1 the last vertex of $\pi^*(x)$ in B . Decompose the path segment $\pi_{a_1,b_1}^*(x)$ between a_1 and b_1 into excursions π^1, \dots, π^σ ($\sigma \in \mathbb{N}$) as follows: each excursion π^i begins with a nonempty segment $\pi^{i,1}$ of edges inside $\overline{W_1}$, followed by a nonempty segment $\pi^{i,2}$ of edges outside $\overline{W_1}$. The excursions $\pi^1, \dots, \pi^{\sigma-1}$ begin and end at a vertex in $\overline{W_1}$, while the last excursion π^σ begins in $\overline{W_1}$ and ends at the vertex b_1 where $\pi^*(x)$ exits B . Figure 5.5 illustrates.

By $\omega^* \in \Gamma_B$, (5.27) and (5.28), $r_1 - \delta > 0$ and hence $t^*(e) > 0$ for all edges $e \in B$. Then condition (i) of Lemma 5.7 ensures that those portions of the segments $\pi^{1,2}, \pi^{2,2}, \dots, \pi^{\sigma,2}$ that connect $\overline{W_1}$ to itself or to ∂B inside B cannot be replaced by segments that use edges in $\overline{W_1}$. Therefore these segments obey bound (5.45). This gives the last inequality below:

$$T^*(\pi_{a_0,b_1}^*(x)) \geq T^*(\pi_{a_1,b_1}^*(x)) \geq \sum_{i=1}^{\sigma} T^*(\pi^{i,2}) \geq \sigma s_1 \ell_2'.$$

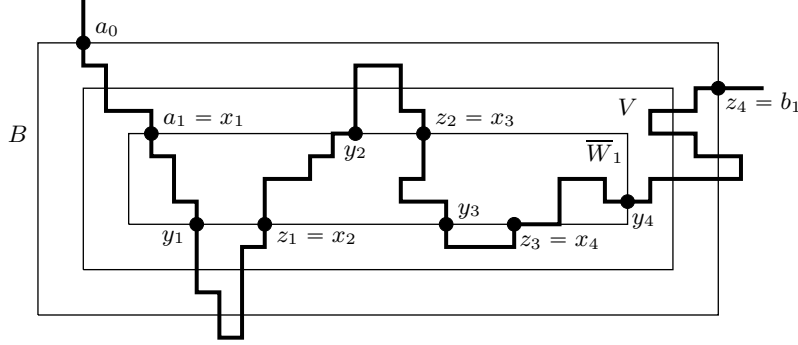

FIGURE 5.5. The path segment $\pi_{a_0, b_1}^*(x)$ with four excursions π^1, \dots, π^4 . The segment $\pi^{i,1}$ inside \overline{W}_1 goes from x_i to y_i and the segment $\pi^{i,2}$ outside \overline{W}_1 goes from y_i to z_i . Note that \overline{W}_1 is *not* actually a box but is represented as one above for the purpose of illustration.

Since the maximal side length of B is $3N$, a_0 and b_1 can be connected with a path π^o such that $T^*(\pi^o) \leq 3dNM_0$. Since $\pi^*(x)$ is optimal, $\sigma s_1 \ell'_2 \leq 3dNM_0$, and therefore

$$(5.47) \quad \sigma \leq \frac{3dNM_0}{s_1 \ell'_2}.$$

Using (5.46), and that $\omega = \omega^*$ outside B while $\omega \leq \omega^*$ on $B \setminus \overline{W}_1$,

$$\begin{aligned} Q &\leq T(\pi^*(x)) - T^*(\pi^*(x)) \\ &= T(\pi_{a_0, a_1}^*(x)) - T^*(\pi_{a_0, a_1}^*(x)) + T(\pi_{a_1, b_1}^*(x)) - T^*(\pi_{a_1, b_1}^*(x)) \\ &\leq \sum_{i=1}^{\sigma} [T(\pi^i) - T^*(\pi^i)]. \end{aligned}$$

Then some excursion $\bar{\pi} \in \{\pi^1, \dots, \pi^\sigma\}$ must satisfy

$$(5.48) \quad T(\bar{\pi}) - T^*(\bar{\pi}) \geq \frac{Q}{\sigma} \geq \frac{c_2 N s_1 \ell'_2}{6dNM_0} = \frac{c_2 s_1 \ell'_2}{6dM_0}.$$

The second inequality comes from (5.37) and (5.47). The only positive contributions to $T(\bar{\pi}) - T^*(\bar{\pi})$ can come from $\bar{\pi}^1$, the segment of $\bar{\pi}$ in \overline{W}_1 . Since B is black, $t(e) - t^*(e) \leq t(e) \leq s_0 \leq s_1$ for all edges $e \in B$. Therefore the number of edges $|\bar{\pi}^1|_1$ satisfies $s_1 |\bar{\pi}^1|_1 \geq T(\bar{\pi}) - T^*(\bar{\pi})$. From this and (5.36)

$$(5.49) \quad |\bar{\pi}^1|_1 \geq \frac{T(\bar{\pi}) - T^*(\bar{\pi})}{s_1} \geq \frac{c_2 \ell'_2}{6dM_0} \geq m_2 \geq 4m_1 + 3(k+1)(\ell+1).$$

The next lemma ensures that the path segment $\bar{\pi}^1$ goes through the k -path of at least one $k+2\ell$ -detour.

LEMMA 5.12. *Let ω and ω^* be two environments that agree outside B and satisfy $\omega \in \Lambda_{B, v, w, x}$ and $\omega^* \in \Gamma_B$. Let $\pi^*(x)$ be the geodesic for $T_{0, x}(\omega^*)$ chosen in Lemma 5.7. Then there exists a detour rectangle G in B with boundary paths (π^+, π^{++}) such that $\pi^*(x)$ follows π^+ and does not touch π^{++} , except at the endpoints shared by π^+ and π^{++} .*

Proof. By construction, the portion $\bar{\pi}^1$ of $\pi^*(x)$ has a continuous path segment of length $m_2 \geq 4m_1 + 3(k+1)(\ell+1)$ in \overline{W}_1 . This forces $\bar{\pi}^1$ to enter at least three $k \times \ell$ detour rectangles, because these rectangles are m_1 apart along \overline{W}_1 and the path can use at most $(k+1)(\ell+1)$ edges in a gives detour rectangle. Let G be a middle rectangle along this path segment, in other words, one that is

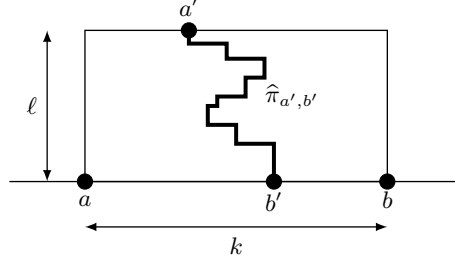
FIGURE 5.6. Case 1: a' lies on the k -side of π^{++} and $b' \in \pi^+$.

both entered and exited, and such that $\bar{\pi}^1$ covers two m_1 -segments on W_1 that connect G to some neighboring detour rectangles. (Recall Figure 5.2.) We can assume without loss of generality that G lies in the $(\mathbf{e}_1, \mathbf{e}_2)$ -plane and that it is attached to a boundary edge of some V_j that lies along \mathbf{e}_1 .

Let π^+ and π^{++} be the boundary paths of G and a and b their common endpoints. Let $\hat{\pi} = \bar{\pi}_{a,b}^1$ denote the segment of $\bar{\pi}^1$ between a and b . For ease of language assume that $\hat{\pi}$ visits a first and then b . We show that $\hat{\pi} = \pi^+$ by showing that all other cases are strictly worse.

Definition (5.40) of Γ_B and inequality (5.27) imply $T^*(\pi^{++}) \geq (k + 2\ell)(r_1 - \delta) > s_0 k \geq T^*(\pi^+)$ and rule out the case $\hat{\pi} = \pi^{++}$. If $\hat{\pi}$ coincides with neither π^+ nor π^{++} , there are points a' and b' on ∂G such that $\hat{\pi}$ visits a, a', b', b in this order and $\pi' = \hat{\pi}_{a',b'}$ lies in the interior $G \setminus \partial G$.

If a' and b' lie on the same or on adjacent sides of ∂G , the ℓ^1 -path from a' to b' along ∂G has smaller weight than π' .

Suppose a' and b' lie on opposite ℓ -sides of π^{++} . Then

$$T^*(\hat{\pi}) \geq T^*(\hat{\pi}_{a,a'}) + s_0 k + T^*(\hat{\pi}_{b',b}) > s_0 k \geq T^*(\pi^+).$$

The term $s_0 k$ is a lower bound on $T^*(\pi')$. The strict inequality comes from $r_1 - \delta > 0$ (from (5.27)) and because the segments $\hat{\pi}_{a,a'}$ and $\hat{\pi}_{b',b}$ are not degenerate paths. This is the case because no edge connects the interior $G \setminus \partial G$ to either a or b .

The remaining option is that a' and b' lie on opposite k -sides of ∂G . Let a' be the first point at which $\hat{\pi}$ leaves ∂G , and let b' be the point of first return to ∂G .

Case 1. Suppose a' lies on the k -side of π^{++} and $b' \in \pi^+$ (Figure 5.6). Fix coordinates as follows: a is at the origin, $a' = a'_1 \mathbf{e}_1 + \ell \mathbf{e}_2$, and $b' = b'_1 \mathbf{e}_1$. Then,

$$\begin{aligned} T^*(\hat{\pi}_{a,b'}) &= T^*(\hat{\pi}_{a,a'}) + T^*(\hat{\pi}_{a',b'}) \\ &\geq (r_1 - \delta)|a - a'|_1 + |a' - b'|_1 s_0 \\ &= (\ell + a'_1)(r_1 - \delta) + (\ell + |b'_1 - a'_1|)s_0 \\ &\geq 2\ell r_1 - \ell\delta + (a'_1(r_1 - \delta) + |b'_1 - a'_1|s_0). \end{aligned}$$

Combine the above with $T^*(\pi_{a,b'}^+) \leq s_0 b'_1$ and develop further:

$$\begin{aligned} T^*(\hat{\pi}_{a,b'}) - T^*(\pi_{a,b'}^+) &\geq 2\ell r_1 - \ell\delta + a'_1(r_1 - \delta) + |b'_1 - a'_1|s_0 - s_0 b'_1 \\ &\geq 2\ell r_1 - \ell\delta - a'_1(s_0 - r_1 + \delta) \\ &> 2\ell(r_1 - \delta) - k(s_0 - r_1 + \delta) > 0. \end{aligned}$$

The last inequality is from (5.27). Thus $\hat{\pi}$ cannot cross the interior of G from π^{++} to π^+ .

Case 2. Suppose $a' \in \pi^+$ and b' lies on the k -side of π^{++} , so that $a' = a'_1 \mathbf{e}_1$, and $b' = b'_1 \mathbf{e}_1 + \ell \mathbf{e}_2$. Then

$$\begin{aligned} T^*(\hat{\pi}_{a,b'}) &= T^*(\hat{\pi}_{a,a'}) + T^*(\hat{\pi}_{a',b'}) \\ &\geq a'_1(s_0 - \delta) + (\ell + |b'_1 - a'_1|)s_0 \\ &\geq (\ell + b'_1)s_0 - a'_1\delta \\ &> (\ell + b'_1)(r_1 + \delta) + (\ell + 1)(s_0 - r_1 - \delta) - k\delta \\ &> (\ell + b'_1)(r_1 + \delta) \geq T^*(\pi_{a,b'}^{++}). \end{aligned}$$

The last strict inequality is from (5.29). Thus it is strictly better to take π^{++} from a to b' .

In conclusion, $\hat{\pi}$ does not coincide with π^{++} , nor does $\hat{\pi}$ visit the interior of the detour rectangle. The only possibility is that $\hat{\pi} = \pi^+$.

It remains to argue that $\pi^*(x)$ does not touch π^{++} except at the endpoints a and b when it goes through π^+ . Suppose on the contrary that $\pi^*(x)$ visits a vertex \hat{z} on π^{++} . This has to happen either before vertex a or after vertex b . The two cases are similar so suppose \hat{z} is visited before a . Then, by the choice of the detour rectangle G , the segment $\pi_{\hat{z},a}^*(x)$ contains an m_1 -segment on W_1 that ends at a . Hence by the definition of Γ_B and (5.33),

$$T^*(\pi_{\hat{z},a}^*(x)) \geq m_1(r_1 - \delta) > (k + 2\ell)(r_1 + \delta).$$

However, $(k + 2\ell)(r_1 + \delta)$ is an upper bound on the passage time of the path from a to \hat{z} along π^{++} , which is then strictly faster than $\pi_{\hat{z},a}^*(x)$. Since $\pi_{\hat{z},a}^*(x)$ must be a geodesic, the supposed visit to \hat{z} cannot happen. \square

Stage 2 for unbounded weights.

In the unbounded weights case we construct first the $k + 2\ell$ detour for a given triple (B, v, w) and then the good event $\Gamma_{B,v,w}$. Given any $k, \ell \in \mathbb{N}$, the construction below can be carried out for all large enough N . We label the construction below so that we can refer to it again. Figure 5.7 gives an illustration.

Construction 5.13 (The $k + 2\ell$ detour for the unbounded weights case). Fix two unit vectors \mathbf{u} and \mathbf{u}' among $\{\pm \mathbf{e}_i\}_{i=1}^d$ perpendicular to each other so that the point $v + (k + \ell + 2)\mathbf{u} + \ell\mathbf{u}'$ lies in B . Hence also the rectangle of size $(k + \ell + 2) \times \ell$ with corners v and $v + (k + \ell + 2)\mathbf{u} + \ell\mathbf{u}'$ lies in B . Switch the labels \mathbf{u} and \mathbf{u}' if necessary to guarantee that w does not lie in the set

$$(5.50) \quad A = \{v + h\mathbf{u} : 0 \leq h \leq \ell\} \cup \{v + i\mathbf{u} + j\mathbf{u}' : \ell + 1 \leq i \leq k + \ell + 1, 0 \leq j \leq \ell\}.$$

The two versions of A obtained by interchanging \mathbf{u} and \mathbf{u}' have only v in common, so at least one of them does not contain w .

From $v + (k + \ell + 2)\mathbf{u}$ there is a self-avoiding path to w that stays inside B and does not intersect A . The existence of such a path and an upper bound on the minimal length of such a path can be seen as follows.

- (i) If w does not lie on the plane through v spanned by $\{\mathbf{u}, \mathbf{u}'\}$, take a minimal length path from $v + (k + \ell + 2)\mathbf{u}$ to w that begins with a step \mathbf{z} perpendicular to this plane. Unit vector \mathbf{z} is chosen so that $(w - v) \cdot \mathbf{z} > 0$. This path will not return to the $\{\mathbf{u}, \mathbf{u}'\}$ plane and hence avoids A . The length of this path is at most $k + \ell + 2 + |w - v|_1$. This is because a possible A -avoiding route to w takes first the \mathbf{z} -step from $v + (k + \ell + 2)\mathbf{u}$, then $k + \ell + 2$ $(-\mathbf{u})$ -steps to $v + \mathbf{z}$, and from $v + \mathbf{z}$ a minimal length path to w . A path from v to w includes a \mathbf{z} -step, hence the distance from $v + \mathbf{z}$ to w is $|w - v|_1 - 1$.

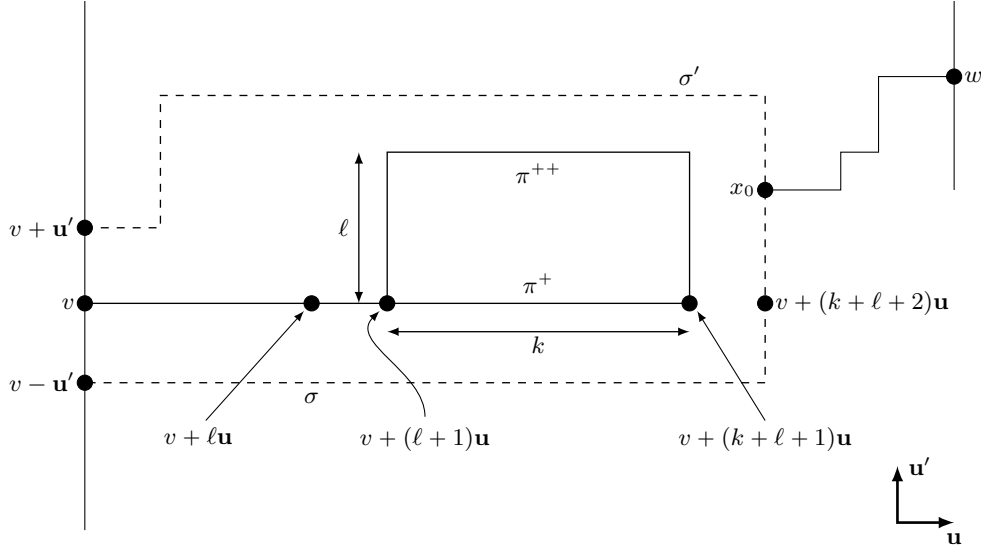

FIGURE 5.7. Illustration of Construction 5.13. The set A of (5.50) consists of the straight line from v to $v + (\ell + 1)\mathbf{u}$ and the $k \times \ell$ detour rectangle bounded by the union of the k -path π^+ and the $k + 2\ell$ -detour π^{++} . The figure shows case (ii) of the A -avoiding self-avoiding path from $v + (k + \ell + 2)\mathbf{u}$ to w via the point x_0 on $\sigma \cup \sigma'$.

- (ii) Suppose w lies on the plane through v spanned by $\{\mathbf{u}, \mathbf{u}'\}$. Then we move on this plane from $v + (k + \ell + 2)\mathbf{u}$ to w and take care to avoid A . First define the minimal A -avoiding path σ from $v + (k + \ell + 2)\mathbf{u}$ to $v - \mathbf{u}'$ in $k + \ell + 3$ steps, and a minimal A -avoiding path σ' from $v + (k + \ell + 2)\mathbf{u}$ to $v + \mathbf{u}'$ in $k + 3\ell + 3$ steps. (We may be forced to pick between $v \pm \mathbf{u}'$ depending on which side of A the point w lies.) Let x_0 be a closest point to w on $\sigma \cup \sigma'$ (possibly $x_0 = w$). The A -avoiding self-avoiding path from $v + (k + \ell + 2)\mathbf{u}$ to w then goes first to x_0 along σ or σ' and from there takes a minimal length path to w . The length of this path is at most $k + 3\ell + 4 + |w - v|_1$.

Using the construction above, fix a self-avoiding path π' in B from v to w that begins with $k + \ell + 2$ \mathbf{u} -steps from v to $v + (k + \ell + 2)\mathbf{u}$, avoids A after that, and has

$$(5.51) \quad |\pi'| \leq |w - v|_1 + 2k + 4\ell + 6.$$

Let $\pi^+ \subset \pi'$ be the \mathbf{u} -directed straight line segment of length k from $\pi_0^+ = \pi'_{\ell+1} = v + (\ell + 1)\mathbf{u}$ to $\pi_k^+ = \pi'_{k+\ell+1} = v + (k + \ell + 1)\mathbf{u}$. Let $\pi^{++} \subset A$ be the detour of length $k + 2\ell$ between the endpoints $\pi_0^{++} = \pi_0^+$ and $\pi_{k+2\ell}^{++} = \pi_k^+$ defined as in (5.21). The two endpoints of π^{++} lie on π' but π^{++} is edge-disjoint from π' . This completes the construction of the $k + 2\ell$ detour. \triangle

Let $b > 0$ be given. By assumption (5.10) we can choose $r < s$ in the support of $t(e)$ so that $b < r < s$. Choose k, ℓ, δ to satisfy (5.14).

Fix an element (B, v, w) for a while. Define the following event $\Gamma_{B, v, w}$ that depends only on the weights $t(e)$ in B . Constants s_0 and δ_0 are from definition (5.4)–(5.5) of a black N -box B .

$$(5.52) \quad \Gamma_{B, v, w} = \left\{ \begin{aligned} &t(e) \in [r_0, r_0 + \delta_0/2) \text{ for } e \in \pi' \setminus \pi^+, \\ &t(e) \in (s - \delta, s + \delta) \text{ for } e \in \pi^+, \\ &t(e) \in (r - \delta, r + \delta) \text{ for } e \in \pi^{++}, \text{ and} \\ &t(e) > s_0 \text{ for } e \in B \setminus (\pi' \cup \pi^{++}) \}. \end{aligned} \right.$$

By (5.14), on the event $\omega \in \Gamma_{B,v,w}$,

$$(5.53) \quad T(\pi^+) < T(\pi^{++}) < T(\pi^+) + (2\ell - 1)b.$$

Once N has been fixed, then up to translations and rotations there are only finitely many ways to choose the points v and w on the boundary of B and the paths π', π^+, π^{++} constructed above. Thus

$$(5.54) \quad \exists D_2 > 0 \text{ such that } \mathbb{P}(\Gamma_{B,v,w}) \geq D_2 \text{ for all triples } (B, v, w).$$

D_2 depends on N and the probabilities of the events on $t(e)$ that appear in $\Gamma_{B,v,w}$. In particular, D_2 does not depend on x .

On the event $\Lambda_{B,v,w,x}$ of (5.18), $\pi(x)$ crosses B , v is the point of first entry into B and w the point of last exit from B . Hence on this event we can define $\bar{\pi}$ as the self-avoiding path from $\mathbf{0}$ to x obtained by concatenating the segments $\pi_{\mathbf{0},v}(x)$, π' , and $\pi_{w,x}(x)$. For future reference at (5.57), note that $\bar{\pi}$ is edge-disjoint from π^{++} .

LEMMA 5.14. *Let ω and ω^* be two environments that agree outside B and satisfy $\omega \in \Lambda_{B,v,w,x}$ and $\omega^* \in \Gamma_{B,v,w}$. Then $\bar{\pi}$ is a geodesic for $T_{\mathbf{0},x}(\omega^*)$. Furthermore, if $\pi(x)$ was chosen to be a geodesic of maximal Euclidean length for $T_{\mathbf{0},x}(\omega)$, then $\bar{\pi}$ is a geodesic of maximal length for $T_{\mathbf{0},x}(\omega^*)$. The same works for minimal length.*

Proof. Since box B is black on the event $\Lambda_{B,v,w,x}$,

$$(5.55) \quad T(\pi_{v,w}(x)) > (r_0 + \delta_0)(|w - v|_1 \vee N).$$

The bound above comes from (5.5), on account of these observations: regardless of whether $\pi_{v,w}(x)$ exits \bar{B} , there is a segment inside \bar{B} of length $|w - v|_1$, and furthermore $\pi_{v,w}(x)$ contains a short crossing of B that has length at least N .

From $\omega^* \in \Gamma_{B,v,w}$,

$$\begin{aligned} T^*(\bar{\pi}_{v,w}) &= T^*(\pi') < k(s + \delta) + (|w - v|_1 + k + 4\ell + 6)(r_0 + \tfrac{1}{2}\delta_0) \\ &\leq |w - v|_1(r_0 + \tfrac{1}{2}\delta_0) + k(s + r_0 + \delta + \tfrac{1}{2}\delta_0) + (4\ell + 6)(r_0 + \tfrac{1}{2}\delta_0) \\ &\leq T(\pi_{v,w}(x)) - \tfrac{1}{2}(|w - v|_1 \vee N)\delta_0 + C_1\delta_0 + C_2 \\ &< T(\pi_{v,w}(x)). \end{aligned}$$

Before the last inequality above, $C_i = C_i(k, \ell, \delta, s, r_0)$ are constants determined by the quantities in parentheses. The last inequality is then guaranteed by fixing N large enough relative to δ_0 and these other constants. Observation (5.7) is used here.

Outside B the weights ω^* and ω agree, and the segments $\bar{\pi}_{\mathbf{0},v} = \pi_{\mathbf{0},v}(x)$ and $\bar{\pi}_{w,x} = \pi_{w,x}(x)$ agree and lie outside B . Hence the inequality above gives $T^*(\bar{\pi}) < T(\pi(x))$ and thereby, for any geodesic $\pi^*(x)$ from $\mathbf{0}$ to x in environment ω^* ,

$$(5.56) \quad T^*(\pi^*(x)) \leq T^*(\bar{\pi}) < T(\pi(x)).$$

This implies that every geodesic $\pi^*(x)$ must enter B since otherwise

$$T^*(\pi^*(x)) = T(\pi^*(x)) \geq T(\pi(x)) > T^*(\bar{\pi}),$$

contradicting the optimality of $\pi^*(x)$ under ω^* .

If $\pi_B^*(x) \not\subset \pi' \cup \pi^{++}$, then $\pi^*(x)$ must use an edge e in B with weight $> s_0$. Then by property (5.4) of a black box B , $T(\pi_B^*(x)) \leq s_0 < T^*(\pi_B^*(x))$. Since ω and ω^* agree on B^c , we get

$$\begin{aligned} T(\pi(x)) &\leq T(\pi^*(x)) = T(\pi_{B^c}^*(x)) + T(\pi_B^*(x)) \\ &< T^*(\pi_{B^c}^*(x)) + T^*(\pi_B^*(x)) = T^*(\pi^*(x)), \end{aligned}$$

contradicting (5.56). Consequently $\pi_B^*(x) \subset \pi' \cup \pi^{++}$. Part of event $\Lambda_{B,v,w,x}$ is that $\{\mathbf{0}, x\} \cap B = \emptyset$. Thus $\pi^*(x)$ must both enter and exit B . As a geodesic $\pi^*(x)$ does not backtrack on itself. Hence

it must traverse the route between v and w . By (5.53) π^+ is better under ω^* than π^{++} , and hence $\pi_B^*(x) = \pi' = \bar{\pi}_B$.

Outside B , under both ω and ω^* since they agree on B^c , $\bar{\pi}_{B^c}$ is an optimal union of two paths that connect the origin to one of v and w , and the other one of v and w to x . This concludes the proof that $\bar{\pi}$ is a geodesic for $T_{\mathbf{0},x}(\omega^*)$.

Suppose $\pi(x)$ is a geodesic of maximal Euclidean length under ω but under ω^* there is a geodesic π^* strictly longer than $\bar{\pi}$. The argument above showed $\pi_B^* = \bar{\pi}_B$. Hence outside B , $\pi_{B^c}^*$ must provide an ω^* -geodesic from $\mathbf{0}$ or x to one of v or w that is longer than that given by $\bar{\pi}_{B^c} = \pi_{B^c}(x)$. This contradicts the choice of $\pi(x)$ as a maximal length geodesic, again because ω and ω^* agree on B^c . Same works for minimal. This completes the proof of Lemma 5.14. \square

Stage 3 for both bounded and unbounded weights.

We choose a particular geodesic $\pi(x)$ for $T_{\mathbf{0},x}$. In the bounded weights case, let $\pi(x)$ be the geodesic specified in Lemma 5.7. In the unbounded weights case, let $\pi(x)$ be the unique lexicographically first geodesic among the geodesics of maximal Euclidean length. Let $b > 0$. For N -boxes $B \in \mathcal{B}_{j(x)}$ define the event

$$(5.57) \quad \begin{aligned} \Psi_{B,x} = \{ & \text{inside } B \exists \text{ edge-disjoint path segments } \pi^+ \text{ and } \pi^{++} \text{ that share both endpoints} \\ & \text{and satisfy } \pi^+ \subset \pi(x), (\pi(x) \setminus \pi^+) \cup \pi^{++} \text{ is a self-avoiding path,} \\ & |\pi^{++}| = |\pi^+| + 2\ell, \text{ and } T(\pi^+) < T(\pi^{++}) < T(\pi^+) + (2\ell - 1)b \}. \end{aligned}$$

Couple two i.i.d. edge weight configurations $\omega = \{t(e)\}_{e \in \mathcal{E}_d}$ and $\omega^* = \{t^*(e)\}_{e \in \mathcal{E}_d}$ so that $t^*(e) = t(e)$ for $e \notin B$ (that is, at least one endpoint of e lies outside B) and so that the weights $\{t(e)\}_{e \in \mathcal{E}_d}$ and $\{t^*(e)\}_{e \in B}$ are independent.

Lemma 5.12 for bounded weights (with $\Gamma_{B,v,w} = \Gamma_B$) and Lemma 5.14 for unbounded weights imply that

$$\{\omega \in \Lambda_{B,v,w,x}\} \cap \{\omega^* \in \Gamma_{B,v,w}\} \subset \{\omega^* \in \Psi_{B,x}\}.$$

In particular, by inequalities (5.41) and (5.53), $\omega^* \in \Gamma_{B,v,w}$ implies $T^*(\pi^+) < T^*(\pi^{++}) < T^*(\pi^+) + (2\ell - 1)b$ required for $\omega^* \in \Psi_{B,x}$, where T^* denotes passage time in the environment ω^* .

By the independence of $\{\omega \in \Lambda_{B,v,w,x}\}$ and $\{\omega^* \in \Gamma_{B,v,w}\}$, and then by (5.42) for bounded weights and by (5.54) for unbounded weights,

$$(5.58) \quad \mathbb{P}(\Psi_{B,x}) = \mathbb{P}\{\omega^* \in \Psi_{B,x}\} \geq \mathbb{P}\{\omega \in \Lambda_{B,v,w,x}\} \mathbb{P}\{\omega^* \in \Gamma_{B,v,w}\} \geq D_2 \mathbb{P}(\Lambda_{B,v,w,x}).$$

Let Y be the number of $(B, v, w) \in \mathcal{B}_{j(x)}$ for which $\Psi_{B,x}$ occurs. By the above and (5.20),

$$(5.59) \quad \begin{aligned} \mathbb{E}[Y] & \geq \sum_{(B,v,w) \in \mathcal{B}_{j(x)}} \mathbb{P}(\Psi_{B,x}) \\ & \geq \sum_{(B,v,w) \in \mathcal{B}_{j(x)}} D_2 \mathbb{P}(\Lambda_{B,v,w,x}) \geq D_2 D_1 |x|_1 \equiv D_3 |x|_1 \end{aligned}$$

for a new constant D_3 .

Since we have arranged the boxes in the elements $(B, v, w) \in \mathcal{B}_{j(x)}$ separated, we can define a self-avoiding path $\hat{\pi}$ from $\mathbf{0}$ to x by replacing each π^+ segment with the π^{++} segment in each box $B \in \mathcal{B}_{j(x)}$ for which event $\Psi_{B,x}$ happens.

Reduce the weights on each edge e from $t(e)$ to $t^{(-b)}(e) = t(e) - b$. By the definition of $\Psi_{B,x}$, the $t^{(-b)}$ -passage times of the segments π^+ and π^{++} obey this inequality:

$$T^{(-b)}(\pi^{++}) = T(\pi^{++}) - b|\pi^{++}| < T(\pi^+) + (2\ell - 1)b - b|\pi^{++}| = T^{(-b)}(\pi^+) - b.$$

Consequently, along the entire path $\pi(x)$, the replacements of π^+ with π^{++} reduce the $t^{(-b)}$ -passage time by at least bY . We get the following bound:

$$(5.60) \quad \begin{aligned} T_{\mathbf{0},x}^{(-b)} &\leq T^{(-b)}(\hat{\pi}) < T^{(-b)}(\pi(x)) - bY = T(\pi(x)) - b|\pi(x)| - bY \\ &\begin{cases} \leq T_{\mathbf{0},x} - b\underline{L}_{\mathbf{0},x} - bY & \text{in the bounded weights case,} \\ = T_{\mathbf{0},x} - b\overline{L}_{\mathbf{0},x} - bY & \text{in the unbounded weights case.} \end{cases} \end{aligned}$$

The case distinction above comes because in the unbounded case $|\pi(x)| = \overline{L}_{\mathbf{0},x}$ by our choice of $\pi(x)$, while in the bounded case our choice is different, but any geodesic satisfies $|\pi(x)| \geq \underline{L}_{\mathbf{0},x}$. Note that the inequality above does not require that $\hat{\pi}$ be a geodesic for $T_{\mathbf{0},x}^{(-b)}$, as long as $\hat{\pi}$ is self-avoiding.

In order to take expectations in (5.60) we restrict to $b \in (0, r_0 + \varepsilon_0)$ which guarantees that $\mathbb{E}[T_{\mathbf{0},x}^{(-b)}]$ is finite, even if $-b < -r_0$ so that weights $\omega^{(-b)}$ can be negative (Theorem A.1 in Appendix A). By Lemma 2.3 in [2], moment bound (2.7) with $p = 1$ is equivalent to the finite expectation $\mathbb{E}[T_{\mathbf{0},x}] < \infty$ for all x . The inequalities above then force $\underline{L}_{\mathbf{0},x}$ and $\overline{L}_{\mathbf{0},x}$ to have finite expectations. Apply (5.59): in the bounded weights case

$$\mathbb{E}[T_{\mathbf{0},x}^{(-b)}] \leq \mathbb{E}[T_{\mathbf{0},x}] - b\mathbb{E}(\underline{L}_{\mathbf{0},x}) - b\mathbb{E}(Y) \leq \mathbb{E}[T_{\mathbf{0},x}] - b\mathbb{E}(\underline{L}_{\mathbf{0},x}) - D_3b|x|_1,$$

while in the unbounded weights case $\mathbb{E}(\underline{L}_{\mathbf{0},x})$ is replaced by $\mathbb{E}(\overline{L}_{\mathbf{0},x})$. This completes the proof of Theorem 5.4. \square

6. MODIFICATION PROOFS FOR NONDIFFERENTIABILITY

In this section we consider three scenarios under which we prove that, with probability bounded away from zero, there are geodesics between two points whose lengths differ on the scale of the distance between the endpoints. The setting and modification proofs in this section borrow heavily from Section 5.

ASSUMPTION 6.1. *We assume one of these three situations for nonnegative weights.*

- (i) *Zero is an atom: $r_0 = 0$ and $0 < \mathbb{P}\{t(e) = 0\} < p_c$.*
- (ii) *The weights are unbounded ($M_0 = \infty$) and there exist strictly positive integers k and ℓ and atoms $r'_1, \dots, r'_{k+2\ell}, s'_1, \dots, s'_k$ (not necessarily all distinct) such that*

$$(6.1) \quad \sum_{i=1}^{k+2\ell} r'_i = \sum_{j=1}^k s'_j.$$

- (iii) *The weights are bounded ($M_0 < \infty$) and there exist strictly positive integers k and ℓ and atoms $r < s$ such that $(k + 2\ell)r = ks$.*

THEOREM 6.2. *Assume $r_0 \geq 0$, (2.6), and the moment bound (2.7) with $p > 1$. Furthermore, assume one of the three scenarios (i)–(iii) of Assumption 6.1. Then there exist constants $0 < D, \delta, M < \infty$ such that*

$$(6.2) \quad \mathbb{P}(\overline{L}_{\mathbf{0},x} - \underline{L}_{\mathbf{0},x} \geq D|x|_1) \geq \delta \quad \text{for } |x|_1 \geq M.$$

Before the proof some observations about the assumptions are in order.

Remark 6.3. Condition (6.1) of case (ii) is trivially true if zero is an atom for $t(e)$. Since this situation is taken care of by case (i) of Assumption 6.1, let us suppose zero is not an atom. Then a necessary condition for (6.1) is that $t(e)$ has at least two strictly positive atoms.

A sufficient condition for (6.1) is the existence of two atoms $r < s$ in $(0, \infty)$ such that s/r is rational. This is exactly the assumption on the atoms in case (iii) of Assumption 6.1. If $t(e)$ has exactly two atoms $r < s$ in $(0, \infty)$ and no others, then (6.1) holds if and only if s/r is rational.

With more than two atoms, rational ratios are not necessary for (6.1). For example, if $\theta > 0$ is irrational and $\{1, \theta, 1 + 2\theta\}$ are atoms, then (6.1) is satisfied and the ratios $\theta, 1 + 2\theta, \theta^{-1} + 2$ are irrational.

We can prove a more general result for unbounded weights because arbitrarily large weights can be used to force the geodesic to follow a specific path. With bounded weights the control of the geodesic is less precise. Hence the assumption in case (iii) is more restrictive on the atoms. \triangle

Proof of Theorem 6.2. We prove the theorem by considering each case of Assumption 6.1 in turn.

Proof of Theorem 6.2 in Case (i) of Assumption 6.1.

We assume that zero is an atom. In this case conditions (5.3) or (5.4) are not needed for a black box, so color a box B black if (5.5) holds. Fix N large enough and δ_0 small enough. Consider points x with $|x|_1$ large enough so that the Peierls estimate (5.9) is valid for $n = |x|_1$.

Let $\pi(x)$ be the unique geodesic for $T_{\mathbf{0},x}$ that is lexicographically first among the geodesics of minimal Euclidean length. For this purpose order $\mathcal{R} = \{\pm e_1, \dots, \pm e_d\}$ in some way, for example as in (5.39). The index $j(x)$ and the event $\Lambda_{B,v,w,x}$ are defined as before in (5.17) and (5.18), and estimate (5.20) holds. Let $\Gamma_B = \{\omega : t(e) = 0 \ \forall e \in B\}$ be the event that all edge weights in B are zero and $D_2 = \mathbb{P}(\Gamma_B) > 0$.

Given an N -box B , define edge weight configuration $\omega^* = \{t^*(e)\}_{e \in \mathcal{E}_d}$ by setting $t^*(e) = t(e)$ for $e \notin B$ (that is, at least one endpoint of e lies outside B) and by resampling $\{t^*(e)\}_{e \in B}$ independently. Then ω^* has the same i.i.d. distribution as the original weights $\omega = \{t(e)\}_{e \in \mathcal{E}_d}$.

LEMMA 6.4. *On the event $\{\omega \in \Lambda_{B,v,w,x}\} \cap \{\omega^* \in \Gamma_B\}$, every geodesic from $\mathbf{0}$ to x in the ω^* environment uses at least one edge in B .*

Proof. On the event $\{\omega \in \Lambda_{B,v,w,x}\}$, $\pi(x)$ goes through v and w . Let π' be an arbitrary path from v to w that remains inside B and define $\bar{\pi}$ as the path from $\mathbf{0}$ to x obtained by concatenating the segments $\pi_{\mathbf{0},v}(x)$, π' , and $\pi_{w,x}(x)$. Then on the event $\{\omega \in \Lambda_{B,v,w,x}\} \cap \{\omega^* \in \Gamma_B\}$,

$$T^*(\bar{\pi}_{v,w}) = T^*(\pi') = 0 < \delta_0(|w - v|_1 \vee N) < T(\pi_{v,w}(x)).$$

The justification for the last inequality was given below (5.55).

Outside B weights ω^* and ω agree, and the segments $\bar{\pi}_{\mathbf{0},v} = \pi_{\mathbf{0},v}(x)$ and $\bar{\pi}_{w,x} = \pi_{w,x}(x)$ agree and lie outside B . Hence the inequality above gives $T^*(\bar{\pi}) < T(\pi(x))$ and thereby, for any geodesic $\pi^*(x)$ from $\mathbf{0}$ to x in environment ω^* ,

$$(6.3) \quad T^*(\pi^*(x)) \leq T^*(\bar{\pi}) < T(\pi(x)).$$

This implies that every geodesic $\pi^*(x)$ must use at least one edge in B . For otherwise

$$T^*(\pi^*(x)) = T(\pi^*(x)) \geq T(\pi(x)) > T^*(\bar{\pi}),$$

contradicting the optimality of $\pi^*(x)$ for ω^* . \square

For N -boxes B such that $\mathbf{0}, x \notin B$ define the event

$$(6.4) \quad \Psi_{B,x} = \left\{ \begin{array}{l} \text{inside } B \ \exists \text{ path segments } \pi^+ \text{ and } \pi^{++} \text{ that share both endpoints} \\ \text{and satisfy } \pi^+ \subset \pi(x), (\pi(x) \setminus \pi^+) \cup \pi^{++} \text{ is a self-avoiding path,} \\ |\pi^{++}| \geq |\pi^+| + 2, \text{ and } T(\pi^+) = T(\pi^{++}) \end{array} \right\}.$$

In particular, on the event $\Psi_{B,x}$, replacing π^+ with π^{++} creates an alternative geodesic.

By Lemma 6.4, $\omega^* \in \Psi_{B,x}$ holds on the event $\{\omega \in \Lambda_{B,v,w,x}\} \cap \{\omega^* \in \Gamma_B\}$. This is seen as follows. Let $\pi^*(x)$ be the lexicographically first geodesic of minimal Euclidean length in environment ω^* . By

Lemma 6.4, $\pi^*(x)$ uses at least one edge in B . Let u_1 be the first and u_2 the last point of $\pi^*(x)$ in B . Since $\{\omega^* \in \Gamma_B\}$ ensures that all edges in B have zero weight and $\pi^*(x)$ is a minimal length geodesic, the segment $\pi_{u_1, u_2}^*(x)$ must be a path of length $|u_2 - u_1|_1$ from u_1 to u_2 inside B . Now take $\pi^+ = \pi_{u_1, u_2}^*(x)$ and let π^{++} be any other path inside B from u_1 to u_2 that takes more than the minimal number $|u_2 - u_1|_1$ of steps. By the choice of u_1 and u_2 , the other portions $\pi_{\mathbf{0}, u_1}^*(x)$ and $\pi_{u_2, x}^*(x)$ of the geodesic lie outside B , and consequently π^{++} does not touch these paths except at the points u_1 and u_2 .

By the independence of $\{\omega \in \Lambda_{B, v, w, x}\}$ and $\{\omega^* \in \Gamma_B\}$,

$$(6.5) \quad \begin{aligned} \mathbb{P}(\Psi_{B, x}) &= \mathbb{P}\{\Psi_{B, x} \text{ occurs for } \omega^*\} \geq \mathbb{P}(\{\omega \in \Lambda_{B, v, w, x}\} \cap \{\omega^* \in \Gamma_B\}) \\ &= \mathbb{P}\{\omega \in \Lambda_{B, v, w, x}\} \mathbb{P}\{\omega^* \in \Gamma_B\} \geq D_2 \mathbb{P}(\Lambda_{B, v, w, x}). \end{aligned}$$

Let Y be the number of $(B, v, w) \in \mathcal{B}_j(x)$ for which $\Psi_{B, x}$ occurs. By (5.20), for another constant $D_3 > 0$,

$$(6.6) \quad \mathbb{E}[Y] \geq \sum_{(B, v, w) \in \mathcal{B}_j(x)} D_2 \mathbb{P}(\Lambda_{B, v, w, x}) \geq D_3 |x|_1.$$

By Proposition 4.7(1) of [2], under the assumption $\mathbb{P}\{t(e) = 0\} < p_c$, for any $p > 0$ there exists a finite constant C_p such that for all $x \in \mathbb{Z}^d$,

$$(6.7) \quad \mathbb{E}[(\bar{L}_{\mathbf{0}, x}]^p] \leq C_p \mathbb{E}[(T_{\mathbf{0}, x}]^p].$$

By Lemma 2.3 in [2], under assumption (2.7) there exists a finite constant C' such that for all $x \in \mathbb{Z}^d$

$$(6.8) \quad \mathbb{E}[(T_{\mathbf{0}, x}]^p] \leq C' |x|_1^p.$$

An obvious upper bound on Y is the number of edges on the geodesic $\pi(x)$. Let $p > 1$ be the power for which (2.7) is assumed to hold and $q = \frac{p}{p-1}$ its conjugate exponent. Then, by a combination of (6.6), (6.7) and (6.8),

$$\begin{aligned} D_3 |x|_1 &\leq \mathbb{E}(Y) = \mathbb{E}(Y, Y < D_3 |x|_1/2) + \mathbb{E}(Y, Y \geq D_3 |x|_1/2) \\ &\leq D_3 |x|_1/2 + \mathbb{E}(|\pi(x)|, Y \geq D_3 |x|_1/2) \\ &\leq D_3 |x|_1/2 + (\mathbb{E}[|\pi(x)|^p])^{\frac{1}{p}} \mathbb{P}(Y \geq D_3 |x|_1/2)^{\frac{1}{q}} \\ &\leq D_3 |x|_1/2 + C |x|_1 \mathbb{P}(Y \geq D_3 |x|_1/2)^{\frac{1}{q}}. \end{aligned}$$

From this we get the bound

$$\mathbb{P}(Y \geq \frac{1}{2} D_3 |x|_1) \geq \delta_3 > 0 \quad \text{for large enough } |x|_1.$$

Since we have arranged the boxes B in the elements $(B, v, w) \in \mathcal{B}_j(x)$ separated, we can define a self-avoiding path $\hat{\pi}(x)$ from $\mathbf{0}$ to x by replacing each π^+ segment of $\pi(x)$ with the π^{++} segment in each box B for which event $\Psi_{B, x}$ happens. This path $\hat{\pi}(x)$ has the same passage time $T(\hat{\pi}(x)) = T(\pi(x))$ and hence both $\pi(x)$ and $\hat{\pi}(x)$ are geodesics. By the construction, the numbers of edges on these paths satisfy $|\hat{\pi}(x)| \geq |\pi(x)| + 2Y$. Thus we get these inequalities between the maximal and minimal geodesic length:

$$\bar{L}_{\mathbf{0}, x} \geq |\hat{\pi}(x)| \geq |\pi(x)| + 2Y \geq \underline{L}_{\mathbf{0}, x} + 2Y$$

and then

$$\mathbb{P}(\bar{L}_{\mathbf{0}, x} - \underline{L}_{\mathbf{0}, x} \geq D_3 |x|_1) \geq \mathbb{P}(Y \geq \frac{1}{2} D_3 |x|_1) \geq \delta_3.$$

(6.2) has been proved.

Proof of Theorem 6.2 in Case (ii) of Assumption 6.1.

By assumption (6.1) we can fix $s_1 < \infty$ large enough so that, for i.i.d. copies t_i, t'_j of the edge weight $t(e)$,

$$(6.9) \quad \mathbb{P} \left\{ t_i \leq s_1 \ \forall i \in [k + 2\ell], \ t'_j \leq s_1 \ \forall j \in [k], \ \text{and} \ \sum_{i=1}^{k+2\ell} t_i = \sum_{j=1}^k t'_j \right\} > 0.$$

Apply Construction 5.13 of the $k + 2\ell$ detour in an N -box B with given boundary points v and w , to define paths π', π^+ and π^{++} in B with $|\pi^+| = k$ and $|\pi^{++}| = k + 2\ell$. Define the event $\Gamma_{B,v,w}$ that depends only on the weights $t(e)$ in B :

$$(6.10) \quad \begin{aligned} \Gamma_{B,v,w} = & \left\{ t(e) \in [r_0, r_0 + \delta_0/2) \ \text{for} \ e \in \pi' \setminus \pi^+, \right. \\ & t(e) \leq s_1 \ \text{for} \ e \in \pi^+ \cup \pi^{++}, \\ & \sum_{e \in \pi^{++}} t(e) = \sum_{e' \in \pi^+} t(e') \quad \text{and} \\ & \left. t(e) > s_0 \ \text{for} \ e \in B \setminus (\pi' \cup \pi^{++}) \right\}. \end{aligned}$$

By (6.9), unbounded weights, and the detour construction, there exists a constant D_2 such that $\mathbb{P}(\Gamma_{B,v,w}) \geq D_2 > 0$ for all triples (B, v, w) .

The steps follow those of the proof of Theorem 5.4 and the proof of Case (i) of Theorem 6.2. First sample ω , and then define $\omega^* = \{t^*(e)\}_{e \in \mathcal{E}_d}$ by setting $t^*(e) = t(e)$ for $e \notin B$ and by resampling $\{t^*(e)\}_{e \in B}$ independently. Let $\pi(x)$ be a self-avoiding geodesic of minimal Euclidean length for $T_{\mathbf{0},x}(\omega)$. On the event $\{\omega \in \Lambda_{B,v,w,x}\} \cap \{\omega^* \in \Gamma_{B,v,w}\}$ define the path $\bar{\pi}$ from $\mathbf{0}$ to x by concatenating the segments $\pi_{\mathbf{0},v}(x)$, π' , and $\pi_{w,x}(x)$.

LEMMA 6.5. *When N is fixed large enough, on the event $\{\omega \in \Lambda_{B,v,w,x}\} \cap \{\omega^* \in \Gamma_{B,v,w}\}$ the path $\bar{\pi}$ is a self-avoiding geodesic of minimal Euclidean length for $T_{\mathbf{0},x}(\omega^*)$.*

Proof. As before, since box B is black on the event $\Lambda_{B,v,w,x}$,

$$T(\pi_{v,w}(x)) > (r_0 + \delta_0)(|w - v|_1 \vee N).$$

Then by $\omega^* \in \Gamma_{B,v,w}$,

$$\begin{aligned} T^*(\bar{\pi}_{v,w}) &= T^*(\pi') < ks_1 + (|w - v|_1 + k + 4\ell + 6)(r_0 + \frac{1}{2}\delta_0) \\ &\leq (|w - v|_1 \vee N)(r_0 + \frac{1}{2}\delta_0) + k(s_1 + r_0 + \frac{1}{2}\delta_0) + (4\ell + 6)(r_0 + \frac{1}{2}\delta_0) \\ &\leq T(\pi_{v,w}(x)) - \frac{1}{2}(|w - v|_1 \vee N)\delta_0 + C \\ &< T(\pi_{v,w}(x)). \end{aligned}$$

Before the last inequality above, $C = C(k, \ell, s_1, r_0, \delta_0)$ is a constant determined by the quantities fixed thus far in the proof. The last inequality is then guaranteed by fixing N large enough relative to these other constants. Outside B weights ω^* and ω agree, and the segments $\bar{\pi}_{\mathbf{0},v} = \pi_{\mathbf{0},v}(x)$ and $\bar{\pi}_{w,x} = \pi_{w,x}(x)$ agree and lie outside B . Hence the inequality above gives $T^*(\bar{\pi}) < T(\pi(x))$ and thereby, for any geodesic $\pi^*(x)$ from $\mathbf{0}$ to x in environment ω^* ,

$$(6.11) \quad T^*(\pi^*(x)) \leq T^*(\bar{\pi}) < T(\pi(x)).$$

As explained below (6.3), this implies that every ω^* geodesic $\pi^*(x)$ must enter B .

If $\pi_B^*(x) \not\subset \pi' \cup \pi^{++}$, then $\pi^*(x)$ must use an edge e in B with weight $> s_0$. Then by property (5.4) of a black box B , $T(\pi_B^*(x)) \leq s_0 < T^*(\pi_B^*(x))$. Since t and t^* agree on B^c , we get

$$\begin{aligned} T(\pi(x)) &\leq T(\pi^*(x)) = T(\pi_{B^c}^*(x)) + T(\pi_B^*(x)) \\ &= T^*(\pi_{B^c}^*(x)) + T(\pi_B^*(x)) < T^*(\pi_{B^c}^*(x)) + T^*(\pi_B^*(x)) = T^*(\pi^*(x)), \end{aligned}$$

contradicting (6.11). Consequently $\pi_B^*(x) \subset \pi' \cup \pi^{++}$. As a geodesic $\pi^*(x)$ does not backtrack on itself. Hence it must traverse the route between v to w , either via π' or via π' with π^+ replaced by π^{++} . By (6.10) $T^*(\pi^+) = T^*(\pi^{++})$ so there is no travel time distinction between the two routes between v and w .

Since ω and ω^* agree on B^c , $\bar{\pi}_{B^c}$ is an optimal union of two paths that connect $\mathbf{0}$ to one of v and w , and x to the other one of v and w . Thus $\bar{\pi}$ is a geodesic for $T_{\mathbf{0},x}(\omega^*)$.

The argument above showed that every geodesic of $T_{\mathbf{0},x}(\omega^*)$ goes from v to w utilizing edges in $\pi' \cup \pi^{++}$ and otherwise remains outside B . If there were a geodesic π^o strictly shorter than $\bar{\pi}$, π^o would have to use an alternative shorter geodesic path between $\mathbf{0}$ and v or between w and x . This contradicts the choice of $\pi(x)$ as the shortest geodesic. \square

Define $\Psi_{B,x}$ as in (6.4) above. By Lemma 6.5, $\omega^* \in \Psi_{B,x}$ holds on the event $\{\omega \in \Lambda_{B,v,w,x}\} \cap \{\omega^* \in \Gamma_{B,v,w}\}$. The proof of this case is completed exactly as was done in the previous case from equation (6.5) onwards.

Proof of Theorem 6.2 in Case (iii) of Assumption 6.1.

The weights are now assumed bounded. We work under assumption (6.1) until the last stage of the proof where we have to invoke the more stringent assumption of Case (iii) under which (6.1) is restricted to the case where all $r'_i = r$ and all $s'_j = s$. Since the case of a zero atom has been taken care of, we can assume that these atoms $\{r'_i, s'_j\}$ are strictly positive and that zero is not an atom. Since zero is not an atom, condition (5.11) holds.

As in the cases above, all that is needed for the conclusion is that the geodesic encounters (π^+, π^{++}) -pairs whose passage times coincide. This proof follows closely the bounded weight case of Stage 2 of the proof of Theorem 5.4, which required condition (5.11). Lemma 5.6 can be enhanced to include the additional conclusion

$$(6.12) \quad \max_{i,j} \{r'_i, s'_j\} \leq s_0(q).$$

The only change required in the proof of Lemma 5.6 is that induction begins with $s_0(0) = (r_0 + \delta_0) \vee \max_{i,j} \{r'_i, s'_j\}$, after the case $\mathbb{P}\{t(e) = M_0\} > 0$ has been taken care of.

The construction of $W_1, W_1^+, W_1', \bar{W}_1$ and W_2 in each black box B goes exactly as before around (5.38). Let $\{\pi_{B,j}^+, \pi_{B,j}^{++}\}_{1 \leq j \leq j_1(B)}$ be the π^+ and π^{++} boundary path segments of the detour rectangles $\{G_{B,j}\}_{1 \leq j \leq j_1(B)}$ constructed in the box B . In particular,

$$W_1^+ = \bigcup_j \pi_{B,j}^+ \subset W_1 \quad \text{and} \quad W_1' = \left(W_1 \cup \bigcup_j \pi_{B,j}^{++} \right) \subset \left(W_1 \cup \bigcup_j G_{B,j} \right) = \bar{W}_1.$$

Define the event

$$(6.13) \quad \Gamma_B = \left\{ \begin{aligned} &\omega : r_1 - \delta < t(e) < r_1 + \delta \quad \forall e \in W_1 \setminus W_1^+, \\ &\sum_{e \in \pi_{B,j}^{++}} t(e) = \sum_{e' \in \pi_{B,j}^+} t(e') \quad \forall j, \\ &0 < t(e) \leq s_0 \quad \forall e \in W_1', \\ &s_0 \leq t(e) \leq s_1 \quad \forall e \in \bar{W}_1 \setminus W_1', \\ &\text{and } s_1 \leq t(e) \leq M_0 \quad \forall e \in B \setminus \bar{W}_1 \end{aligned} \right\}.$$

The condition $t(e) \leq s_0 \forall e \in W_1'$ is implied by the conditions before it. It is stated explicitly merely for clarity. The condition $t(e) > 0 \forall e \in W_1'$ can be imposed because (i) for $e \in W_1 \setminus W_1^+$ it follows

from $t(e) > r_1 - \delta$ (recall from (5.27) that $r_1 - \delta > 0$), and (ii) for edges $e \in \bigcup_{1 \leq j \leq j_1(B)} (\pi_{B,j}^+ \cup \pi_{B,j}^{++})$ we can use the strictly positive atoms $\{r'_i, s'_j\}$. Again $\mathbb{P}(\Gamma_B) \geq D_2$ for a constant D_2 .

As before, given an N -box B we work with two environments ω and ω^* that agree outside B . Let $\pi^*(x)$ be the $T_{0,x}(\omega^*)$ geodesic specified in Lemma 5.7. Starting from inequality (5.43), Stage 2 for bounded weights in the proof of Theorem 5.4 can be followed down to inequality (5.49), to get the existence of an excursion $\bar{\pi}$ in $\pi^*(x)$ whose segment $\bar{\pi}^1$ in \bar{W}_1 satisfies (5.49). The previous Lemma 5.12 is then replaced by the next lemma.

LEMMA 6.6. *Assume $\omega \in \Lambda_{B,v,w,x}$ and $\omega^* \in \Gamma_B$. Then there exist three path segments $\hat{\pi}, \pi^+, \pi^{++}$ in B with the same endpoints and such that the following holds:*

- (i) *the pair (π^+, π^{++}) forms the boundaries of a detour rectangle,*
- (ii) *$\hat{\pi} \subset \pi^*(x)$, and*
- (iii) *replacing $\hat{\pi}$ in $\pi^*(x)$ with either π^+ or π^{++} produces two self-avoiding geodesics for $T_{0,x}(\omega^*)$.*

Proof. As in the proof of Lemma 5.12, $\bar{\pi}^1$ has a segment $\hat{\pi} = \bar{\pi}_{a,b}^1$ between the common endpoints a and b of the boundary paths π^+ and π^{++} of some detour rectangle G in B . We show that $\pi^*(x)$ can be redirected to take either π^+ or π^{++} , by showing that (i) $\hat{\pi}$ cannot be strictly better than π^+ or π^{++} and (ii) replacing $\hat{\pi}$ with π^+ or π^{++} does not violate the requirement that a geodesic be self-avoiding.

Suppose $T^*(\hat{\pi}) < T^*(\pi^+) = T^*(\pi^{++})$. Then there are points a' and b' on ∂G such that $\hat{\pi}$ visits a, a', b', b in this order and the edges of $\pi' = \hat{\pi}_{a',b'}$ lie in the interior $G \setminus \partial G$. Recall that on the event Γ_B , the weights on ∂G are at most s_0 while the weights in the interior $G \setminus \partial G$ are at least s_0 .

The points a' and b' cannot lie on the same or on adjacent sides of ∂G since the ℓ^1 -path from a' to b' along ∂G has no larger weight than π' .

Suppose a' and b' lie on opposite ℓ -sides of G . Then

$$T^*(\hat{\pi}) \geq T^*(\pi') \geq s_0 k \geq T^*(\pi^+) = T^*(\pi^{++}).$$

So we can do at least as well by picking π^+ or π^{++} .

The remaining option is that a' and b' lie on opposite k -sides of G . Let us suppose that a' is the first point at which $\hat{\pi}$ leaves ∂G and b' the first return to ∂G .

For this argument we use the most restrictive assumption that there are two atoms $r < s$ such that $(k + 2\ell)r = ks$, with weights $t(e) = s$ on edges $e \in \pi^+$ and $t(e) = r$ on edges $e \in \pi^{++}$.

Case 1. Suppose a' lies on the k -segment of π^{++} and $b' \in \pi^+$. (See again Figure 5.6.) We can assume that a is at the origin, $a' = a'_1 \mathbf{e}_1 + \ell \mathbf{e}_2$, and $b' = b'_1 \mathbf{e}_1$. Then,

$$\begin{aligned} T^*(\hat{\pi}_{a,b'}) &= T^*(\hat{\pi}_{a,a'}) + T^*(\hat{\pi}_{a',b'}) \\ &\geq |a - a'|_1 r + |a' - b'|_1 s_0 \\ &= (\ell + a'_1)r + (\ell + |b'_1 - a'_1|)s_0. \end{aligned}$$

From $a'_1 \leq k - 1$ and the assumptions $s_0 \geq s > r$ and $ks = (k + 2\ell)r$ we deduce:

$$\begin{aligned} \ell(r + s) &\geq 2\ell r = k(s - r) > a'_1(s - r) \geq (b'_1 - |b'_1 - a'_1|)s - a'_1 r \\ \implies (\ell + a'_1)r + (\ell + |b'_1 - a'_1|)s_0 &> b'_1 s \\ \implies T^*(\hat{\pi}_{a,b'}) &> T^*(\pi_{a,b'}^+). \end{aligned}$$

In other words, we can do better by taking π^+ from a to b' .

Case 2. Suppose $a' \in \pi^+$ and b' lies on the k -segment of π^{++} so that $a' = a'_1 \mathbf{e}_1$ and $b' = b'_1 \mathbf{e}_1 + \ell \mathbf{e}_2$. Then,

$$T^*(\hat{\pi}_{a,b'}) \geq a'_1 s + (\ell + |b'_1 - a'_1|)s_0 > (\ell + b'_1)r = T^*(\pi_{a,b'}^{++}).$$

This time it is better to take π^{++} from a to b' .

We have shown that the passage time is not made worse by forcing $\hat{\pi}$ to take π^+ or π^{++} . Suppose doing so violates self-avoidance of the overall path from $\mathbf{0}$ to x . Then we can cut out part of the path, and the removed piece includes at least one edge of either π^+ or π^{++} . The assumption $\omega^* \in \Gamma_B$ implies that $t^*(e) > 0$ for these edges. Consequently the original passage time could not have been optimal. \square

The event $\Psi_{B,x}$ earlier defined in (6.4) has to be reworded slightly for the present case. Let $\pi(x)$ be the $T_{\mathbf{0},x}(\omega)$ geodesic chosen in Lemma 5.7.

$$(6.14) \quad \begin{aligned} \Psi_{B,x} = \{ & \text{inside } B \exists \text{ path segments } \hat{\pi}, \pi^+ \text{ and } \pi^{++} \text{ that share both endpoints} \\ & \text{and satisfy } \hat{\pi} \subset \pi(x), \text{ both } (\pi(x) \setminus \hat{\pi}) \cup \pi^+ \text{ and } (\pi(x) \setminus \hat{\pi}) \cup \pi^{++} \\ & \text{are self-avoiding paths from } \mathbf{0} \text{ to } x, \\ & |\pi^{++}| \geq |\pi^+| + 2, \text{ and } T(\hat{\pi}) = T(\pi^+) = T(\pi^{++}) \}. \end{aligned}$$

It is of course possible that $\hat{\pi}$ agrees with either π^+ or π^{++} . By Lemma 6.6, $\omega^* \in \Psi_{B,x}$ holds on the event $\{\omega \in \Lambda_{B,v,w,x}\} \cap \{\omega^* \in \Gamma_{B,v,w}\}$.

Now follow the proof of the previous case from equation (6.5) onwards. Again, since the boxes B in the elements $(B, v, w) \in \mathcal{B}_{j(x)}$ are separated, we can define two self-avoiding paths $\pi^+(x)$ and $\pi^{++}(x)$ from $\mathbf{0}$ to x by replacing each $\hat{\pi}$ segment of $\pi(x)$ with the π^+ (respectively, π^{++}) segment in each box B that appears among $(B, v, w) \in \mathcal{B}_{j(x)}$ and for which event $\Psi_{B,x}$ happens. Then both $\pi^+(x)$ and $\pi^{++}(x)$ are self-avoiding geodesics for $T_{\mathbf{0},x}(\omega)$.

By the construction, the Euclidean lengths of these paths satisfy $|\pi^{++}(x)| \geq |\pi^+(x)| + 2Y$ where Y is again the number of $(B, v, w) \in \mathcal{B}_{j(x)}$ for which $\Psi_{B,x}$ occurs. Hence

$$\bar{L}_{\mathbf{0},x} \geq |\pi^{++}(x)| \geq |\pi^+(x)| + 2Y \geq \underline{L}_{\mathbf{0},x} + 2Y.$$

This completes the proof of the third case and thereby the proof of Theorem 6.2. \square

7. PROOFS OF THE MAIN THEOREMS

This section proves the remaining claims of Section 2 by appeal to the preparatory work of Section 4 and the modification results of Sections 5 and 6.

7.1. Strict concavity, derivatives, and geodesic length. The next theorem gives part (ii) of Theorem 2.2 and thereby completes the proof of Theorem 2.2. Recall that $r_0 = \text{ess inf } t(e)$ and $\varepsilon_0 > 0$ is the constant specified in Theorems 2.1 and A.1.

THEOREM 7.1. *Assume $r_0 \geq 0$, (2.6), and moment bound (2.7) with $p = d$. Then there exist strictly positive constants $D(a, h)$ such that the following holds for all $\xi \in \mathbb{R}^d \setminus \{\mathbf{0}\}$: whenever $a \geq -r_0$ and $-r_0 - \varepsilon_0 < a - h < a$,*

$$(7.1) \quad \mu_\xi(a - h) \leq \mu_\xi(a) - h\mu'_\xi(a+) - D(a, h)h|\xi|_1.$$

As a consequence, $\mu'_\xi(a_0+) > \mu'_\xi(a_1-)$ whenever $-r_0 \leq a_0 < a_1 < \infty$ and $\mu'_\xi(b\pm) > \mu'_\xi((-r_0)_+)$ for all $b \in (-r_0 - \varepsilon_0, -r_0)$.

Note that the theorem does not rule out a linear segment of μ_ξ immediately to the left of $-r_0$ which happens if $\mu'_\xi(b+) = \mu'_\xi((-r_0)-)$ for some $b \in (-r_0 - \varepsilon_0, -r_0)$. But this does force $\mu'_\xi((-r_0)-) > \mu'_\xi((-r_0)_+)$ and thereby a singularity at $-r_0$.

Proof. We start by deriving the last statement of strict concavity from (7.1). Suppose that $\mu'_\xi(a_0+) = \mu'_\xi(a_1-) = \tau$ for some $-r_0 \leq a_0 < a_1 < \infty$. Then by concavity μ_ξ must be affine on the open interval (a_0, a_1) : $\mu_\xi(a) = \mu_\xi(a_0) + \tau(a - a_0)$ and $\mu'_\xi(a) = \tau$ for $a \in (a_0, a_1)$. This violates (7.1). The second claim of the last statement follows similarly.

For this and a later proof, we check here the validity of the middle portion of (2.15). Let $b > -r_0 - \varepsilon_0$, $\xi \in \mathbb{R}^d \setminus \{\mathbf{0}\}$, $\omega \in \Omega_0 =$ the full measure event specified in Theorem A.1, and $x_n/n \rightarrow \xi$. Take limits (2.8) in the extremes of (2.13), limits $\underline{\lim} n^{-1} \underline{L}_{\mathbf{0}, x_n}^{(b)}(\omega)$ and $\overline{\lim} n^{-1} \overline{L}_{\mathbf{0}, x_n}^{(b)}(\omega)$ in the middle of (2.13), and then let $\delta, \eta \searrow 0$. This gives

$$(7.2) \quad \mu'_\xi(b+) \leq \underline{\lim}_{n \rightarrow \infty} \frac{\underline{L}_{\mathbf{0}, x_n}^{(b)}(\omega)}{n} \leq \overline{\lim}_{n \rightarrow \infty} \frac{\overline{L}_{\mathbf{0}, x_n}^{(b)}(\omega)}{n} \leq \mu'_\xi(b-).$$

To prove (7.1), consider first the case where $a > -r_0$ or $a = -r_0$ but $\mathbb{P}\{t(e) = r_0\} = 0$. The hypotheses of Theorem 5.4 are satisfied for the shifted weights $\omega^{(a)}$. In particular, the extra assumption (5.11) of the bounded weights case that requires the existence of a positive support point r_1 close enough to the lower bound is valid because either $\text{ess inf } t^{(a)}(e) > 0$ or $\text{ess inf } t^{(a)}(e) = 0$ but 0 is not an atom.

From Theorem 5.4 applied to the shifted weights $\omega^{(a)}$ we take the conclusion (5.13) which is valid in both cases of the theorem:

$$(7.3) \quad \mathbb{E}[T_{\mathbf{0}, x}^{(a-h)}] \leq \mathbb{E}[T_{\mathbf{0}, x}^{(a)}] - h \mathbb{E}[\underline{L}_{\mathbf{0}, x}^{(a)} - D(a, h)h|x]_1.$$

The constant $D(a, h)$ given by the theorem depends now also on a .

In (7.3) take $x = x_n$, divide through by n , and let $n \rightarrow \infty$ along a suitable subsequence. The expectations of normalized passage times converge by Theorem A.1. We obtain

$$(7.4) \quad \mu_\xi(a - h) \leq \mu_\xi(a) - h \overline{\lim}_{n \rightarrow \infty} n^{-1} \mathbb{E}[\underline{L}_{\mathbf{0}, x_n}^{(a)}] - D(a, h)h|\xi|_1.$$

By Fatou's lemma and (7.2),

$$(7.5) \quad \overline{\lim}_{n \rightarrow \infty} n^{-1} \mathbb{E}[\underline{L}_{\mathbf{0}, x_n}^{(a)}] \geq \underline{\lim}_{n \rightarrow \infty} n^{-1} \mathbb{E}[\underline{L}_{\mathbf{0}, x_n}^{(a)}] \geq \mathbb{E}[\underline{\lim}_{n \rightarrow \infty} n^{-1} \underline{L}_{\mathbf{0}, x_n}^{(a)}] \geq \mu'_\xi(a+).$$

This substituted into (7.4) gives (7.1).

Last we take up the case $a = -r_0$ and $0 < \mathbb{P}\{t(e) = r_0\} < p_c$. The shifted weights $\omega^{(-r_0)}$ satisfy $0 < \mathbb{P}\{t(e) = 0\} < p_c$. This puts us in case (i) of Theorem 6.2. Its conclusion (6.2) implies the existence of a constant $D > 0$ such that

$$\mathbb{P}(\overline{L}_{\mathbf{0}, x_n}^{(-r_0)} - \underline{L}_{\mathbf{0}, x_n}^{(-r_0)} \geq D|x_n|_1 \text{ for infinitely many } n) \geq \delta.$$

Hence (7.2) implies $\mu'_\xi((-r_0)-) - \mu'_\xi((-r_0)+) \geq D|\xi|_1$. Note that D does not depend on the sequence $\{x_n\}$ or ξ . (7.1) comes from concavity:

$$\mu_\xi(-r_0 - h) \leq \mu_\xi(-r_0) - \mu'_\xi((-r_0)-)h \leq \mu_\xi(-r_0) - \mu'_\xi((-r_0)+)h - Dh|\xi|_1. \quad \square$$

COROLLARY 7.2. *Assume $r_0 \geq 0$, (2.6), and moment bound (2.7) with $p = d$. There exists a constant $D > 0$ such that $\underline{\lambda}(\xi) \geq (1 + D)|\xi|_1$ for all $\xi \in \mathbb{R}^d \setminus \{\mathbf{0}\}$.*

Proof. Fix $0 < a - b < a$ and let $D = D(a, b)$ from (7.1). Then, for $\xi \neq \mathbf{0}$,

$$(7.6) \quad \underline{\lambda}(\xi) = \mu'_\xi(0+) \geq \frac{\mu_\xi(a) - \mu_\xi(a - b)}{b} \geq \mu'_\xi(a+) + D(a, b)|\xi|_1 \geq (1 + D)|\xi|_1.$$

The first equality is from the characterization of the superdifferential in (2.46) if $r_0 > 0$ and in (2.49) if $r_0 = 0$. The first inequality is concavity and the second one is (7.1). The last inequality is the easy bound from (2.14). \square

Proof of Theorem 2.3. We prove the first inequality of (2.15). For $b \geq -r_0$ the characterizations of the superdifferentials in (2.46) and (2.49) give $\mu'_\xi(b+) = \underline{\lambda}^{(b)}(\xi)$. Corollary 7.2 gives constants $D(b) > 0$ such that $\underline{\lambda}^{(b)}(\xi) \geq (1 + D(b))|\xi|_1$. By the monotonicity of the derivatives, $D(b) = D(-r_0)$ works for $b < -r_0$. To produce a nonincreasing function, replace $D(b)$ with $\inf_{-r_0 \leq a \leq b} D(a)$.

The three middle inequalities of (2.15) are in (7.2) above.

To prove the rightmost bound of (2.15), consider first $b \in (-r_0 - \varepsilon_0, -r_0]$. Take $a = (b - r_0 - \varepsilon_0)/2 \in (-r_0 - \varepsilon_0, b)$. Let $\omega \in \Omega_0$ and $x_n/n \rightarrow \xi$. Concavity, (7.2), and (A.2) give

$$\mu'_\xi(b-) \leq \mu'_\xi(a+) \leq \liminf_{n \rightarrow \infty} \frac{\underline{L}_{\mathbf{0}, x_n}^{(a)}(\omega)}{n} \leq \frac{c}{(a + r_0) \wedge 0 + \varepsilon_0} |\xi|_1 = \frac{2c}{(b + r_0) \wedge 0 + \varepsilon_0} |\xi|_1.$$

The rightmost bound of (2.15) extends to all $b \geq -r_0$ because $\mu'_\xi(b-)$ is nonincreasing in b . \square

Proof of Theorem 2.5. Using Proposition 4.4(i), the continuity of the shape functions μ and g° on $\text{int } \mathcal{U}$, and $\underline{\lambda}(\xi) \geq (1 + D)|\xi|_1$ from Corollary 7.2 above, choose constants $\eta, \delta > 0$ small enough so that for any $|\xi|_1 = 1$,

$$(7.7) \quad |\mu(\xi) - \tau g^\circ(\xi/\tau)| \leq \eta \implies \tau \geq 1 + \delta.$$

From (4.8) or (A.2) pick finite deterministic κ and random K such that

$$(7.8) \quad \bar{L}_{\mathbf{0}, x} \leq \kappa|x|_1 \quad \text{for all } |x|_1 \geq K.$$

Let $\alpha = \delta/4$. Increase κ if necessary so that $\kappa > 2 + \alpha$. Let $0 < \varepsilon < \eta/(1 + \kappa)$. Increase K if necessary so that (i) $K \geq 4/\delta$, (ii) K works in (B.1) for α, ε , and (iii) K satisfies the FPP shape theorem ([2, p. 11], also (A.3))

$$(7.9) \quad |T_{\mathbf{0}, x} - \mu(x)| \leq \varepsilon|x|_1 \quad \text{for } |x|_1 \geq K.$$

Let $|x|_1 \geq K$ and let π be a geodesic for $T_{\mathbf{0}, x}$. Let $k = |\pi| \vee [(1 + \alpha)|x|_1]$. Then

$$T_{\mathbf{0}, x} = G_{\mathbf{0}, (|\pi|), x}^\circ = G_{\mathbf{0}, (k), x}^\circ.$$

A combination of (B.1) and (7.9), the homogeneity of μ , and $k \leq \kappa|x|_1$ give

$$\begin{aligned} |\mu(x) - k g^\circ(x/k)| &\leq \varepsilon|x|_1 + \varepsilon k \leq \varepsilon(1 + \kappa)|x|_1 \\ \implies \left| \mu\left(\frac{x}{|x|_1}\right) - \frac{k}{|x|_1} g^\circ\left(\frac{x/|x|_1}{k/|x|_1}\right) \right| &\leq \varepsilon(1 + \kappa) < \eta. \end{aligned}$$

Now (7.7) implies $k \geq (1 + \delta)|x|_1$. On the other hand, $|x|_1 \geq K > 4/\delta$ implies that

$$k = |\pi| \vee [(1 + \alpha)|x|_1] \leq |\pi| \vee (1 + \delta/2)|x|_1.$$

Together these force $|\pi| \geq (1 + \delta)|x|_1$. \square

Proof of Theorem 2.11. Part (i). The statements about $\underline{\lambda}(\xi)$ come from Lemma 4.2. The statements about $\bar{\lambda}(\xi)$ come from the definition (4.16) and Proposition 4.4(ii). The semicontinuity claims are in Lemma 4.5. The finite-infinite dichotomy of $\bar{\lambda}(\xi)$ is in (4.17) and (4.18).

Part (ii). To derive (2.35), combine Corollary 7.2, (4.17), (4.18), (7.2), and the characterizations of the derivatives $\mu'_\xi(0\pm)$ from (2.46) when $r_0 > 0$ and from (2.49) when $r_0 = 0$. \square

Proof of Theorem 2.16. Part (i) was proved in Lemma 4.3. Part (ii) comes from Proposition 4.4.

Part (iii). Begin by noting that differentiability of $t \mapsto g^\circ(t\xi)$ is equivalent to differentiability of $\tau \mapsto \tau g^\circ(\xi/\tau)$ and on an open interval a differentiable convex function is continuously differentiable.

Since $\underline{\lambda}(\xi) > |\xi|_1$ and by the limit (2.48), the union of the superdifferentials on the right-hand sides of (2.46) and (2.47) is equal to the interval $(|\xi|_1, \infty)$. General convex analysis gives the equivalence

$$-b \in \partial_\tau[\tau g(\xi/\tau)] \iff \tau \in \partial \mu_\xi(b).$$

By the strict concavity of μ_ξ , a given τ lies in $\partial\mu_\xi(b)$ for a unique b , and hence the subdifferential $\partial_\tau[\tau g(\xi/\tau)]$ consists of a unique value $-b \in (-\infty, r_0]$. This implies that $\tau \mapsto \tau g(\xi/\tau)$ is differentiable at $\tau \in (|\xi|_1, \infty)$.

Continuous differentiability of $\tau \mapsto \tau g^\circ(\xi/\tau)$ for $\tau > |\xi|_1$ now follows from Proposition 4.4. Namely, $\tau g^\circ(\xi/\tau) = \tau g(\xi/\tau)$ for $\tau \in [|\xi|_1, \underline{\lambda}(\xi)]$, which we now know to be a nondegenerate interval, and their common left τ -derivative vanishes at the minimum $\tau = \underline{\lambda}(\xi)$. On $[\underline{\lambda}(\xi), \infty)$, $\tau g^\circ(\xi/\tau) = \mu(\xi)$ is constant and hence connects in a C^1 fashion to the part on $[|\xi|_1, \underline{\lambda}(\xi)]$.

If $g^\circ(\xi/|\xi|_1) = \infty$ then necessarily $\lim_{t \nearrow |\xi|_1^{-1}} (g^\circ)'(t\xi) = +\infty$.

The remaining claims follow if we assume $g^\circ(\xi/|\xi|_1) < \infty$ and show that

$$(7.10) \quad \lim_{t \nearrow |\xi|_1^{-1}} \frac{g^\circ(|\xi|_1^{-1}\xi) - g^\circ(t\xi)}{|\xi|_1^{-1} - t} = +\infty.$$

It suffices to treat g since $g^\circ = g$ close enough to the boundary of \mathcal{U} by part (ii).

Take $\alpha = 1/t > |\xi|_1$ and rewrite the ratio above as

$$|\xi|_1 g(|\xi|_1^{-1}\xi) + |\xi|_1 \frac{|\xi|_1 g(\xi/|\xi|_1) - \alpha g(\xi/\alpha)}{\alpha - |\xi|_1}.$$

Thus by the duality in Theorem 2.17, (7.10) is equivalent to

$$(7.11) \quad \lim_{\alpha \searrow |\xi|_1} \frac{\bar{\mu}_\xi^*(\alpha) - \bar{\mu}_\xi^*(|\xi|_1)}{\alpha - |\xi|_1} = \infty.$$

By concavity, the ratio in (7.11) above is a nonincreasing function of $\alpha > |\xi|_1$. Hence if (7.11) fails, there exists $b_0 < \infty$ such that, $\forall \alpha > |\xi|_1$ and $\forall b \geq b_0$,

$$|\xi|_1 b - \bar{\mu}_\xi^*(|\xi|_1) \leq \alpha b - \bar{\mu}_\xi^*(\alpha).$$

It then follows from the duality ((2.41) or (2.44)) that

$$\bar{\mu}_\xi(b) = |\xi|_1 b - \bar{\mu}_\xi^*(|\xi|_1) \quad \text{for } b \geq b_0.$$

This contradicts the strict concavity of $\bar{\mu}_\xi$. (7.10) has been verified. \square

7.2. Nondifferentiability.

Proof of Theorem 2.6. Bound (2.21) is contained in Theorem 6.2. (2.21) implies that, along any subsequence $\{n_i\}$,

$$\mathbb{P}(\bar{L}_{\mathbf{0}, x_{n_i}} - \underline{L}_{\mathbf{0}, x_{n_i}} \geq D|x_{n_i}|_1 \text{ for infinitely many } i) \geq \delta.$$

Now (7.2) implies $\mu'_\xi(0-) - \mu'_\xi(0+) \geq D|\xi|_1$. \square

Proof of Theorem 2.7. Let $r < s$ be two atoms of $t(e)$ in $[r_0, \infty)$. Fix an arbitrary $\ell \in \mathbb{N}$ and then pick $k \in \mathbb{N}$ so that

$$\frac{(k-1)(s-r)}{2\ell} \leq r - r_0 < \frac{k(s-r)}{2\ell}.$$

For $m \in \mathbb{Z}_+$ let

$$b_m = \frac{(k+m)(s-r)}{2\ell} - r \in (-r_0, \infty).$$

Then $b_m + r$ and $b_m + s$ are atoms of $t^{(b_m)}(e)$ such that

$$(k+m)(s+b_m) = (k+m+2\ell)(r+b_m) \quad \text{for all } m \in \mathbb{Z}_+.$$

The other hypotheses of Theorem 2.6 are inherited by $\omega^{(b_m)}$ and so the conclusions of Theorem 2.6 hold for all $\omega^{(b_m)}$. In particular, since $\mu_\xi^{(b_m)}(a) = \mu_\xi(a + b_m)$, $\mu_\xi^{(b_m)}$ has a corner at 0 if and only if μ_ξ has a corner at b_m .

No point of $[-r_0, \infty)$ is farther than $\frac{s-r}{2\ell}$ from the nearest b_m . We get the dense set B by combining the collections $\{b_m\}$ for all $\ell \in \mathbb{N}$. \square

APPENDIX A. FIRST-PASSAGE PERCOLATION WITH SLIGHTLY NEGATIVE WEIGHTS

This appendix extends the shape theorem of standard FPP to real-valued weights $\{t(e)\}$ under certain hypotheses. The setting is the same as in Section 2.1. As before, $\{t_i\}$ denotes i.i.d. copies of the edge weight $t(e)$. Assumption (2.7) is reformulated for positive parts as

$$(A.1) \quad \mathbb{E}[(\min\{t_1^+, \dots, t_{2d}^+\})^p] < \infty.$$

Passage times $T_{x,y}$ are defined as in (2.2) and now the restriction to self-avoiding paths is essential.

THEOREM A.1. *Assume $r_0 = \text{ess inf } t(e) \geq 0$, (2.6), and (A.1) (equivalently, (2.7)) with $p = d$. Then there exist*

- (a) a constant $\varepsilon_0 > 0$ determined by the distribution of the shifted weights $\omega^{(-r_0)}$,
- (b) for each real $b > -r_0 - \varepsilon_0$, a positively homogeneous continuous convex function $\mu^{(b)} : \mathbb{R}^d \rightarrow \mathbb{R}_+$, and
- (c) an event Ω_0 of full probability,

such that the properties listed below in points (i)–(iii) are satisfied.

- (i) For each $\omega \in \Omega_0$ and $b > -r_0 - \varepsilon_0$ the following pointwise statements hold. For each $x \in \mathbb{Z}^d$, $T_{\mathbf{0},x}^{(b)}$ is finite and has a geodesic, that is, a self-avoiding path π from $\mathbf{0}$ to x such that $T_{\mathbf{0},x}^{(b)} = T^{(b)}(\pi)$. There exist a deterministic finite constant c and an ω -dependent finite constant $K = K(\omega)$ such that

$$(A.2) \quad \overline{L}_{\mathbf{0},x}^{(b)} \leq \frac{c}{\varepsilon_0 + (r_0 + b) \wedge 0} |x|_1 \quad \text{whenever } |x|_1 \geq K.$$

The shape theorem holds, locally uniformly in the shift b : for any $a_0 < a_1$ in $(-r_0 - \varepsilon_0, \infty)$,

$$(A.3) \quad \lim_{n \rightarrow \infty} \sup_{|x|_1 \geq n} \sup_{b \in [a_0, a_1]} \frac{|T_{\mathbf{0},x}^{(b)} - \mu^{(b)}(x)|}{|x|_1} = 0.$$

- (ii) For each $b > -r_0 - \varepsilon_0$ the following statements hold. $T_{\mathbf{0},x}^{(b)} \in L^1(\mathbb{P})$ for all $x \in \mathbb{Z}^d$. For any sequence $x_n \in \mathbb{Z}^d$ with $x_n/n \rightarrow \xi \in \mathbb{R}^d$, the convergence $n^{-1}T_{\mathbf{0},x_n}^{(b)} \rightarrow \mu^{(b)}(\xi)$ holds almost surely and in $L^1(\mathbb{P})$.
- (iii) The shape function satisfies these Lipschitz bounds for shifts $b_2 > b_1 > -r_0 - \varepsilon_0$ and all $\xi \in \mathbb{R}^d$:

$$(A.4) \quad \mu^{(b_1)}(\xi) \leq \mu^{(b_2)}(\xi) \leq \mu^{(b_1)}(\xi) + \frac{c|\xi|_1}{\varepsilon_0 + (r_0 + b_1) \wedge 0} (b_2 - b_1).$$

For $b > -r_0 - \varepsilon_0$, $\mu^{(b)}(\mathbf{0}) = 0$ and $\mu^{(b)}(\xi) > 0$ for all $\xi \neq 0$.

We prove this theorem at the end of the section after proving a more general shape result in Theorem A.4 below.

LEMMA A.2. *Let \mathbb{P} be a probability measure invariant under a group $\{\theta_x\}_{x \in \mathbb{Z}^d}$ of measurable bijections. Let A be a nonnegative random variable such that $\mathbb{E}[A^d] < \infty$. Then*

$$(A.5) \quad \lim_{m \rightarrow \infty} m^{-1} \max_{|x|_1 \leq m} A \circ \theta_x = 0 \quad \text{with probability one.}$$

Proof. The conclusion is equivalent to $|x|_1^{-1}A \circ \theta_x \rightarrow 0$ as $|x|_1 \rightarrow \infty$. Apply Borel-Cantelli with the estimate below for $\varepsilon > 0$:

$$\begin{aligned} \sum_x \mathbb{P}\{A \circ \theta_x \geq \varepsilon |x|_1\} &= \sum_{k=0}^{\infty} \sum_{|x|_1=k} \mathbb{P}\{A \circ \theta_x \geq k\varepsilon\} \leq 1 + C(d) \sum_{k=1}^{\infty} k^{d-1} \mathbb{P}\{A \geq k\varepsilon\} \\ &\leq 1 + C(d, \varepsilon) \mathbb{E}[A^d] < \infty. \end{aligned} \quad \square$$

Because the inequalities in the proof can be reversed with different constants, an i.i.d. example shows that $p < d$ moments does not suffice for the conclusion.

Let $x^- = (-x) \vee 0$ denote the negative part of a real number. Following [18], define the random variable

$$(A.6) \quad A = 2 \sup_{x \in \mathbb{Z}^d} T_{\mathbf{0}, x}^-$$

We first prove a moment bound for the shifts of A that was used in the concavity result of Section 5.2.

LEMMA A.3. *Assume $r_0 \geq 0$ and the subcriticality assumption (2.6). Let $\delta > 0$ be the constant in the bound (4.10) for the shifted weights $\omega^{(-r_0)}$. Then there exists $s > 0$ such that $\mathbb{E}[e^{sA^{(b)}}] < \infty$ for all shifts $A^{(b)} = 2 \sup_{x \in \mathbb{Z}^d} (T_{\mathbf{0}, x}^{(b)})^-$ such that $b \geq -r_0 - \delta$.*

Proof. By monotonicity it is enough to consider the case $b = -r_0 - \delta$. The proof is the same as that of the corollary of Theorem 3 in [13]. $A^{(-r_0-\delta)} \geq a > 0$ implies the existence of a self-avoiding path γ from $\mathbf{0}$ such that $T^{(-r_0-\delta)}(\gamma) < -a/4$. Turn this into

$$-\delta|\gamma| \leq T^{(-r_0)}(\gamma) - \delta|\gamma| = T^{(-r_0-\delta)}(\gamma) < -a/4 < 0.$$

Then $|\gamma| > a/(4\delta)$ and (4.10) gives the bound

$$\begin{aligned} \mathbb{P}\{A^{(-r_0-\delta)} \geq a\} &\leq \mathbb{P}\{\exists \text{ self-avoiding path } \gamma \text{ from the origin} \\ &\text{such that } |\gamma| \geq a/(4\delta) \text{ and } T^{(-r_0)}(\gamma) \leq \delta|\gamma|\} \leq Ce^{-c_1 a/(4\delta)}. \end{aligned} \quad \square$$

The next item is a shape theorem whose hypotheses are stated in terms of the random variable A of (A.6).

THEOREM A.4. *Let $\omega = (t(e) : e \in \mathcal{E}_d)$ be i.i.d. real-valued weights.*

(i) *Assume (A.1) with $p = 1$ and that the random variable from (A.6) satisfies $A \in L^1$. Then $T_{x,y}$ is a finite integrable random variable for all $x, y \in \mathbb{Z}^d$. There exists a non-random positively homogeneous continuous convex function $\mu : \mathbb{R}^d \rightarrow \mathbb{R}_+$ such that for any sequence $\{x_n\} \subset \mathbb{Z}^d$ with $x_n/n \rightarrow \xi \in \mathbb{R}^d$,*

$$(A.7) \quad \lim_{n \rightarrow \infty} \mathbb{E}[|n^{-1}T_{\mathbf{0}, x_n} - \mu(\xi)|] = 0.$$

(ii) *Assume furthermore (A.1) with $p = d$ and $\mathbb{E}[A^d] < \infty$. Then the following hold with probability one:*

$$(A.8) \quad \lim_{n \rightarrow \infty} \sup_{|x|_1 \geq n} \frac{|T_{\mathbf{0}, x} - \mu(x)|}{|x|_1} = 0$$

and for all $\xi \in \mathbb{R}^d$ and any sequence $x_n \in \mathbb{Z}^d$ such that $x_n/n \rightarrow \xi$

$$(A.9) \quad \mu(\xi) = \lim_{n \rightarrow \infty} \frac{T_{\mathbf{0}, x_n}}{n}.$$

Proof. Let $A_x = A \circ \theta_x$. Consider two paths $\pi_{x,y} \in \Pi_{x,y}^{\text{sa}}$ and $\pi_{y,z} \in \Pi_{y,z}^{\text{sa}}$. Their concatenation may fail to be self-avoiding. Choose a point u belonging to both paths such that erasing the portion of $\pi_{x,y}$ from u to y (denoted by $\pi'_{u,y}$) and erasing the portion of $\pi_{y,z}$ from y to u (denoted by $\pi''_{y,u}$) leaves a self-avoiding path $\pi_{x,z}$ from x to z . (If the concatenation was self-avoiding to begin with, then $u = y$.) Note that $\pi'_{u,y}$ and $\pi''_{y,u}$ are self-avoiding paths. This implies that

$$\begin{aligned} T(\pi_{x,y}) + T(\pi_{y,z}) &= T(\pi_{x,z}) + T(\pi'_{u,y}) + T(\pi''_{y,u}) \geq T_{x,z} + T_{u,y} + T_{y,u} \\ &\geq T_{x,z} - T_{u,y}^- - T_{y,u}^- \geq T_{x,z} - A_y. \end{aligned}$$

Taking infimum over $\pi_{x,y}$ and $\pi_{y,z}$ gives $T_{x,y} + T_{y,z} \geq T_{x,z} - A_y$. Rearranging, we get

$$(A.10) \quad 0 \leq T_{x,z} + A_z \leq T_{x,y} + A_y + T_{y,z} + A_z.$$

To apply the subadditive ergodic theorem, we derive a moment bound.

Let $\omega^+ = (t(e)^+ : e \in \mathcal{E}_d)$. Take any ℓ^1 -path $x_{0:k}$ from $\mathbf{0}$ to x (where $k = |x|_1$) and use the subadditivity of the passage times in weights ω^+ to write

$$T_{\mathbf{0},x}(\omega^+) \leq \sum_{i=0}^{k-1} T_{x_i, x_{i+1}}(\omega^+).$$

Since $\mathbb{E}[T_{\mathbf{0}, \pm e_i}(\omega^+)]$ are all identical,

$$(A.11) \quad \mathbb{E}[T_{\mathbf{0},x}(\omega)] \leq \mathbb{E}[T_{\mathbf{0},x}(\omega^+)] \leq \mathbb{E}[T_{\mathbf{0},e_1}(\omega^+)] |x|_1.$$

Assumption (A.1) with $p = 1$ implies that $\mathbb{E}[T_{\mathbf{0},e_1}(\omega^+)] < \infty$ (Lemma 2.3 in [2]). By the assumption $A \in L^1$,

$$\mathbb{E}[T_{\mathbf{0},x} + A_x] \leq C|x|_1 + \mathbb{E}[A] < \infty.$$

Standard subadditivity arguments give the existence of a positively homogeneous convex function $\bar{\mu} : \mathbb{Q}^d \rightarrow \mathbb{R}_+$ such that for all $\zeta \in \mathbb{Q}^d$ and $\ell \in \mathbb{N}$ with $\ell\zeta \in \mathbb{Z}^d$, almost surely and in L^1 ,

$$(A.12) \quad \bar{\mu}(\zeta) = \lim_{n \rightarrow \infty} \frac{T_{\mathbf{0},n\ell\zeta} + A_{n\ell\zeta}}{n\ell} = \lim_{n \rightarrow \infty} \frac{T_{\mathbf{0},n\ell\zeta}}{n\ell} \in [0, C|\zeta|_1],$$

and $\bar{\mu}(\zeta)$ does not depend on the choice of ℓ . The assumption $A \in L^1$ allows us to drop the term $A_{n\ell\zeta}$ from above. The first inequality of (A.10) gives $\bar{\mu}(\zeta) \geq 0$.

Fix $x, y \in \mathbb{Z}^d$. Use subadditivity (A.10) to write

$$\begin{aligned} T_{\mathbf{0},x} - T_{\mathbf{0},y} &= T_{\mathbf{0},x} + A_x + T_{x,y} + A_y - T_{\mathbf{0},y} - A_y - T_{x,y} - A_x \\ &\geq -T_{x,y} - A_x \geq -T_{x,y}(\omega^+) - A_x. \end{aligned}$$

Switching x and y gives a complementary bound and so

$$(A.13) \quad |T_{\mathbf{0},x} - T_{\mathbf{0},y}| \leq T_{x,y}(\omega^+) + A_x + A_y.$$

By (A.11)

$$(A.14) \quad \mathbb{E}[|T_{\mathbf{0},x} - T_{\mathbf{0},y}|] \leq C|x - y|_1 + 2\mathbb{E}[A].$$

Now take $\zeta, \eta \in \mathbb{Q}^d$ and $\ell \in \mathbb{N}$ such that $\ell\zeta$ and $\ell\eta$ are both in \mathbb{Z}^d and apply the above to get

$$|\mathbb{E}[T_{\mathbf{0},n\ell\zeta}] - \mathbb{E}[T_{\mathbf{0},n\ell\eta}]| \leq Cn\ell|\zeta - \eta|_1 + 2\mathbb{E}[A].$$

Divide by $n\ell$ and take n to ∞ to get

$$(A.15) \quad |\bar{\mu}(\zeta) - \bar{\mu}(\eta)| \leq C|\zeta - \eta|_1.$$

As a Lipschitz function $\bar{\mu}$ extends uniquely to a continuous positively homogeneous convex function $\mu : \mathbb{R}^d \rightarrow \mathbb{R}$.

Fix $\xi \in \mathbb{R}^d \setminus \{\mathbf{0}\}$ and a sequence x_n in \mathbb{Z}^d such that $x_n/n \rightarrow \xi$. Fix $\zeta \in \mathbb{Q}^d$. Take $\ell \in \mathbb{N}$ such that $\ell\zeta \in \mathbb{Z}^d$. For $n \in \mathbb{N}$ let $m_n = \lfloor n/\ell \rfloor$. By (A.14),

$$\begin{aligned} \mathbb{E}[|n^{-1}T_{\mathbf{0},x_n} - \mu(\xi)|] &\leq n^{-1}\mathbb{E}[|T_{\mathbf{0},x_n} - T_{\mathbf{0},m_n\ell\zeta}|] + \mathbb{E}[|n^{-1}T_{\mathbf{0},m_n\ell\zeta} - \bar{\mu}(\zeta)|] + |\bar{\mu}(\zeta) - \mu(\xi)| \\ &\leq n^{-1}C|x_n - m_n\ell\zeta|_1 + 2n^{-1}\mathbb{E}[A] + \mathbb{E}[|n^{-1}T_{\mathbf{0},m_n\ell\zeta} - \bar{\mu}(\zeta)|] + |\bar{\mu}(\zeta) - \mu(\xi)|. \end{aligned}$$

Take $n \rightarrow \infty$ to get

$$\overline{\lim}_{n \rightarrow \infty} n^{-1}\mathbb{E}[|T_{\mathbf{0},x_n} - \mu(\xi)|] \leq C|\xi - \zeta|_1 + |\bar{\mu}(\zeta) - \mu(\xi)|.$$

Let $\zeta \rightarrow \xi$ to get (A.7). This completes the proof of part (i).

Now strengthen the assumptions to $\mathbb{E}[A^d] < \infty$ and (A.1) with $p = d$. For (A.8) we follow the proof of the Cox-Durrett shape theorem presented in [2, Section 2.3].

Let Ω_0 be the full probability event on which (A.12) holds for all $\zeta \in \mathbb{Q}^d$. By Lemma 2.22 and Claim 1 on p. 22 of [2], under (A.1) there exists a finite positive constant κ and a full probability event Ω_1 such that for any $\omega \in \Omega_1$ and $y \in \mathbb{Z}^d \setminus \{\mathbf{0}\}$, there exists a strictly increasing random sequence $m(n) \in \mathbb{N}$ such that $m(n+1)/m(n) \rightarrow 1$ as $n \rightarrow \infty$ and

$$(A.16) \quad T_{m(n)y,z}(1 + \omega^+) \leq \kappa|m(n)y - z|_1 \quad \text{for all } z \in \mathbb{Z}^d \text{ and } n \in \mathbb{N}.$$

Here, $T_{x,y}(1 + \omega^+)$ is the first-passage time from x to y under the weights $1 + \omega^+ = (1 + t(e)^+ : e \in \mathcal{E}_d)$. The results from [2] apply because these weights are strictly positive and satisfy (A.1) with $p = d$.

Let Ω_2 be the full probability event on which (A.5) holds for the random variable A of (A.6). We show that (A.8) holds for each fixed $\omega \in \Omega_0 \cap \Omega_1 \cap \Omega_2$. Let $x_k \in \mathbb{Z}^d$ be an ω -dependent sequence such that $|x_k|_1 \rightarrow \infty$ and

$$(A.17) \quad \lim_{k \rightarrow \infty} \frac{|T_{\mathbf{0},x_k} - \mu(x_k)|}{|x_k|_1} = \overline{\lim}_{n \rightarrow \infty} \sup_{|x|_1 \geq n} \frac{|T_{\mathbf{0},x} - \mu(x)|}{|x|_1}.$$

By passing to a subsequence we can assume $x_k/|x_k|_1 \rightarrow \xi \in \mathbb{R}^d$ with $|\xi|_1 = 1$. Let $\zeta \in \mathbb{Q}^d$ satisfy $|\zeta|_1 = 1$ and pick $\ell \in \mathbb{N}$ such that $\ell\zeta \in \mathbb{Z}^d$. Choose $m(n)$ in (A.16) for $y = \ell\zeta$. For each $k \in \mathbb{N}$ take $n_k \in \mathbb{N}$ such that

$$(A.18) \quad m(n_k)\ell \leq |x_k|_1 \leq m(n_k + 1)\ell.$$

Abbreviate $m_k = m(n_k)$. There exists ω -dependent k_0 such that for all $k \geq k_0$, $m(n_k + 1) \leq 2m_k$. Triangle inequality:

$$\begin{aligned} \left| \frac{T_{\mathbf{0},x_k}}{|x_k|_1} - \mu(\xi) \right| &\leq \frac{|T_{\mathbf{0},x_k} - T_{\mathbf{0},m_k\ell\zeta}|}{|x_k|_1} + \frac{m_k\ell}{|x_k|_1} \cdot \left| \frac{T_{\mathbf{0},m_k\ell\zeta}}{m_k\ell} - \mu(\zeta) \right| \\ &\quad + \left| \frac{m_k\ell}{|x_k|_1} - 1 \right| \cdot |\mu(\zeta)| + |\mu(\zeta) - \mu(\xi)|. \end{aligned}$$

Use (A.13), (A.16) applied to $y = \ell\zeta$, and take $k \geq k_0$:

$$\begin{aligned} \left| \frac{T_{\mathbf{0},x_k}}{|x_k|_1} - \mu(\xi) \right| &\leq \frac{T_{m_k\ell\zeta,x_k}(1 + \omega^+) + A_{m_k\ell\zeta} + A_{x_k}}{|x_k|_1} + \frac{m_k\ell}{|x_k|_1} \cdot \left| \frac{T_{\mathbf{0},m_k\ell\zeta}}{m_k\ell} - \mu(\zeta) \right| \\ &\quad + \left| \frac{m_k\ell}{|x_k|_1} - 1 \right| \cdot |\mu(\zeta)| + |\mu(\zeta) - \mu(\xi)| \\ &\leq \frac{\kappa|m_k\ell\zeta - x_k|_1}{|x_k|_1} + \frac{2 \max_{|x|_1 \leq 2m_k\ell} A_x}{m_k\ell} + \frac{m_k\ell}{|x_k|_1} \cdot \left| \frac{T_{\mathbf{0},m_k\ell\zeta}}{m_k\ell} - \mu(\zeta) \right| \\ &\quad + \left| \frac{m_k\ell}{|x_k|_1} - 1 \right| \cdot |\mu(\zeta)| + |\mu(\zeta) - \mu(\xi)|. \end{aligned}$$

As $k \rightarrow \infty$ the right-hand side converges to $\kappa|\zeta - \xi| + |\mu(\zeta) - \mu(\xi)|$. Letting $\zeta \rightarrow \xi$ then proves that $T_{\mathbf{0},x_k}/|x_k|_1 \rightarrow \mu(\xi)$ as $k \rightarrow \infty$. Since μ is continuous and homogeneous, we also have $\mu(x_k)/|x_k|_1 = \mu(x_k/|x_k|_1) \rightarrow \mu(\xi)$. Now (A.8) follows from (A.17).

(A.9) follows from (A.8) and the continuity and homogeneity of μ . \square

Remark A.5. In the last inequality of the proof above $(m_k \ell)^{-1} \max_{|x|_1 \leq 2m_k \ell} A_x$ can be replaced by a smaller term as follows. First, fix a rational $\varepsilon > 0$. Take k_0 to be large enough so that for all $k \geq k_0$, $m(n_k + 1) \leq 2m_k$, as before, but also

$$\left| \frac{m_k \ell}{|x_k|_1} - 1 \right| \leq \frac{\varepsilon}{3\ell} \quad \text{and} \quad \left| \frac{x_k}{|x_k|_1} - \xi \right|_1 \leq \frac{\varepsilon}{3\ell}.$$

Take $\zeta \in \mathbb{Q}^d$ (still with $|\zeta|_1 = 1$) so that $|\zeta - \xi|_1 \leq \varepsilon/(3\ell)$. Now we have

$$\frac{|x_k - m_k \ell \zeta|_1}{|x_k|_1} \leq \left| \frac{m_k \ell}{|x_k|_1} - 1 \right| + |\zeta - \xi|_1 + \left| \frac{x_k}{|x_k|_1} - \xi \right|_1 \leq \frac{\varepsilon}{\ell}.$$

Consequently,

$$|x_k - m_k \ell \zeta|_1 \leq \varepsilon \ell^{-1} |x_k|_1 \leq \varepsilon m(n_k + 1) \leq 2\varepsilon m_k.$$

Thus, instead of (A.5) one now needs the hypothesis that for any fixed $z \in \mathbb{Z}^d$,

$$\lim_{\varepsilon \searrow 0} \overline{\lim}_{m \rightarrow \infty} m^{-1} \max_{x: |x - mz|_1 \leq \varepsilon m} A \circ \theta_x = 0 \quad \text{almost surely.}$$

In our application to the proof of Theorem A.1 the random variable A has all moments, so we do not pursue sharper assumptions on A than those stated in Theorem A.4. \triangle

Proof of Theorem A.1. The constant in point (a) is taken to be $\varepsilon_0 = \delta =$ the constant in the bound (4.10) for the shifted weights $\omega^{(-r_0)}$. Then by Lemma A.3, $A^{(b)}$ has all moments for all $b > -r_0 - \varepsilon_0$. Hence we can apply Theorem A.4 to the shifted weights $\omega^{(b)}$ to define the shape functions $\mu^{(b)}$ whose existence is asserted in point (b). We specify the full-probability event Ω_0 for point (c) in the course of the proof.

Proof of part (i). Start with the obvious point that $T_{\mathbf{0},x}^{(b)} \leq T^{(b)}(\tilde{\gamma}) < \infty$ for any particular self-avoiding path $\tilde{\gamma}$ from $\mathbf{0}$ to x . By bound (4.10) there exists a full probability event Ω_0 and a finite random variable $K(\omega)$ such that on the event Ω_0 , every self-avoiding path γ from the origin such that $|\gamma| \geq K$ satisfies the bound $T^{(-r_0)}(\gamma) > \varepsilon_0 |\gamma|$. Then for any shift b these paths satisfy

$$(A.19) \quad T^{(b)}(\gamma) = T^{(-r_0)}(\gamma) + (r_0 + b)|\gamma| > (\varepsilon_0 + r_0 + b)|\gamma|.$$

From this we conclude that, for any $x \in \mathbb{Z}^d$, $b > -r_0 - \varepsilon_0$, and any path γ ,

$$(A.20) \quad |\gamma| \geq K \vee \frac{T_{\mathbf{0},x}^{(b)}}{\varepsilon_0 + r_0 + b} \quad \text{implies} \quad T^{(b)}(\gamma) > T_{\mathbf{0},x}^{(b)}.$$

Thus the infimum that defines $T_{\mathbf{0},x}^{(b)}$ in (2.2) cannot be taken outside a certain ω -dependent finite set of paths. Consequently on the event Ω_0 a minimizing path exists and both $T_{\mathbf{0},x}^{(b)}$ and $\overline{T}_{\mathbf{0},x}^{(b)}$ are finite for all $x \in \mathbb{Z}^d$ and $b > -r_0 - \varepsilon_0$.

Next, shrink the event Ω_0 (if needed) so that for $\omega \in \Omega_0$ the shape theorem (A.8) is valid for the weights $\omega^{(-r_0)}$. Then we can increase K and pick a deterministic positive constant c so that $T_{\mathbf{0},x}^{(-r_0)} \leq c|x|_1$ whenever $|x|_1 \geq K$. By monotonicity $T_{\mathbf{0},x}^{(b)} \leq c|x|_1$ for all $b \leq -r_0$ whenever $|x|_1 \geq K$. If necessary increase c so that $c \geq \varepsilon_0$. Then by (A.20), when $|x|_1 \geq K$ and $b \in (-r_0 - \varepsilon_0, -r_0]$, a self-avoiding path γ between $\mathbf{0}$ and x that satisfies

$$|\gamma| \geq \frac{c|x|_1}{\varepsilon_0 + r_0 + b}$$

cannot be a geodesic for $T_{\mathbf{0},x}^{(b)}$. We conclude that for $\omega \in \Omega_0$,

$$\bar{L}_{\mathbf{0},x}^{(b)} \leq \frac{c}{\varepsilon_0 + r_0 + b} |x|_1 \quad \text{whenever } b \in (-r_0 - \varepsilon_0, -r_0] \text{ and } |x|_1 \geq K.$$

Since $\bar{L}_{\mathbf{0},x}^{(b)}$ is nonincreasing in b (Remark 2.4(iii)), we can extend the bound above to all $b \geq -r_0$ in the form (A.2).

By taking advantage of (A.2) now proved, we get these Lipschitz bounds: for all $\omega \in \Omega_0$, $b_2 > b_1 > -r_0 - \varepsilon_0$ and $|x|_1 \geq K$, and with $\pi_{\mathbf{0},x}^{(b)}$ denoting a geodesic of $T_{\mathbf{0},x}^{(b)}$,

$$\begin{aligned} (A.21) \quad T_{\mathbf{0},x}^{(b_1)} &\leq T_{\mathbf{0},x}^{(b_2)} \leq T^{(b_2)}(\pi_{\mathbf{0},x}^{(b_1)}) = T^{(b_1)}(\pi_{\mathbf{0},x}^{(b_1)}) + (b_2 - b_1)|\pi_{\mathbf{0},x}^{(b_1)}| \\ &\leq T_{\mathbf{0},x}^{(b_1)} + \frac{c(b_2 - b_1)|x|_1}{\varepsilon_0 + (r_0 + b_1) \wedge 0} \equiv T_{\mathbf{0},x}^{(b_1)} + \kappa(b_1)(b_2 - b_1)|x|_1. \end{aligned}$$

The last equality defines the constant $\kappa(b)$ which is nonincreasing in b .

We establish the locally uniform shape theorem (A.3). Let B be a countable dense subset of $(-r_0 - \varepsilon_0, \infty)$. Shrink the event Ω_0 further so that for $\omega \in \Omega_0$ the shape theorem (A.8) holds for the shifted weights $\omega^{(b)}$ for all $b \in B$. By passing to the limit, (A.21) gives the macroscopic Lipschitz bounds (A.4) for shifts $b_1 < b_2$ in this countable dense set B .

Let $\omega \in \Omega_0$, $\varepsilon > 0$, and $a_0 < a_1$ in B . Pick a partition $a_0 = b_0 < b_1 < \dots < b_m = a_1$ so that each $b_i \in B$ and $\kappa(a_0)(b_i - b_{i-1}) < \varepsilon/2$. Fix a constant $K_0 = K_0^{b_0, b_1, \dots, b_m}(\omega)$ such that

$$|T_{\mathbf{0},x}^{(b_i)} - \mu^{(b_i)}(x)| \leq \varepsilon|x|_1/2 \quad \text{for } i = 0, 1, \dots, m \text{ whenever } |x|_1 \geq K_0.$$

Now for $i \in [m]$, $b \in [b_{i-1}, b_i]$, and $|x|_1 \geq K_0$, utilizing the monotonicity in b of $T_{\mathbf{0},x}^{(b)}$ and $\mu^{(b)}(x)$ and the Lipschitz bounds (A.21) and (A.4),

$$|T_{\mathbf{0},x}^{(b)} - \mu^{(b)}(x)| \leq |T_{\mathbf{0},x}^{(b_i)} - \mu^{(b_i)}(x)| + \kappa(a_0)(b_i - b_{i-1})|x|_1 \leq \varepsilon|x|_1.$$

The shape theorem (A.3) has been proved.

Proof of part (ii). The integrability and L^1 convergence follow from Theorem A.4(i). The almost sure convergence comes from the homogeneity and continuity of $\mu^{(b)}$ and the shape theorem (A.3).

Proof of part (iii). We already established (A.4) for a dense set of shifts $b_1 < b_2$. Monotonicity of $b \mapsto \mu^{(b)}(\xi)$ extends (A.4) to all shifts b .

That $\mu^{(b)}(\mathbf{0}) = 0$ follows from homogeneity. The final claim that $\mu^{(b)}(\xi) > 0$ for $b > -r_0 - \varepsilon_0$ and $\xi \neq \mathbf{0}$ follows from (A.19), which implies $T_{\mathbf{0},x}^{(b)} \geq (\varepsilon_0 + r_0 + b)|x|_1$ whenever $|x|_1 \geq K$. \square

APPENDIX B. RESTRICTED PATH LENGTH SHAPE THEOREM

This section proves the next shape theorem in the interior of \mathcal{U} for the restricted path length FPP processes defined in (2.24). As throughout, the edge weights $\{t(e) : e \in \mathcal{E}_d\}$ are independent and identically distributed (i.i.d.) real-valued random variables, $r_0 = \text{ess inf } t(e)$, the set $\mathcal{D}_\ell^\diamond$ of points reachable by ℓ -paths is defined by (2.23), and $\mathcal{U} = \{\xi \in \mathbb{R}^d : |\xi|_1 \leq 1\}$ is the ℓ^1 unit ball. We also write $\{t_i\}$ for i.i.d. copies of the edge weight $t(e)$.

THEOREM B.1. *Assume $r_0 > -\infty$ and moment assumption (A.1) with $p = d$. Fix $\diamond \in \{\langle \text{empty} \rangle, o\}$. There exists a deterministic, continuous, convex shape function $g^\diamond : \text{int } \mathcal{U} \rightarrow [r_0 \wedge 0, \infty)$ that satisfies the following: for each $\alpha, \varepsilon > 0$ there exists an almost-surely finite random constant $K(\alpha, \varepsilon)$ such that*

$$(B.1) \quad |G_{\mathbf{0},(k),x}^\diamond - k g^\diamond(x/k)| \leq \varepsilon k$$

whenever $k \geq K(\alpha, \varepsilon)$, $k \geq (1 + \alpha)|x|_1$, and $x \in \mathcal{D}_k^\diamond$.

The shape theorem can be proved all the way to the boundary of \mathcal{U} . This requires (i) stronger moment bounds that vary with the dimension of each boundary face and (ii) further technical constructions beyond what is done in the proof below, because there are fewer paths to the boundary than to interior points. We have no need for the shape theorem on all of \mathcal{U} in the present paper. Our purposes are met by extending the shape function from the interior to the boundary through radial limits (Theorem 2.10 and Lemma 4.1).

We begin with a basic tail bound on $G_{\mathbf{0},(\ell),x}^\diamond$.

LEMMA B.2. *Assume the weights are arbitrary real-valued i.i.d. random variables. Let $\ell \in \mathbb{N}$, $\diamond \in \{\langle \text{empty} \rangle, o\}$ and $x \in \mathcal{D}_\ell^\diamond$. Assume $\ell - |x|_1 \geq 8$. Then for any real $s \geq 0$,*

$$(B.2) \quad \mathbb{P}\{G_{\mathbf{0},(\ell),x}^\diamond \geq s\} \leq \ell^{2d} \mathbb{P}\{\min(t_1, \dots, t_{2d}) \geq s/\ell\}.$$

Proof. It is enough to prove the lemma for $\diamond = \langle \text{empty} \rangle$. Then we can assume that $\ell - |x|_1$ is an even integer because otherwise $\Pi_{\mathbf{0},(\ell),x} = \emptyset$. The reason that the case $\diamond = o$ is also covered is that $G_{\mathbf{0},(\ell),x}^o \leq G_{\mathbf{0},(\ell-1),x} \wedge G_{\mathbf{0},(\ell),x}$.

To prove (B.2) we construct a total of $2d$ edge-disjoint paths in $\Pi_{\mathbf{0},(\ell),x}$. Let $A = \{z \in \mathcal{R} : z \cdot x > 0\}$ and $B = \{z \in \mathcal{R} : z \cdot x = 0\}$ with cardinalities $\nu_1 \geq 0$ and $\nu_2 = 2d - 2\nu_1$, respectively. Enumerate these sets as $A = \{z_1, \dots, z_{\nu_1}\}$ and $B = \{z_{\nu_1+1}, \dots, z_{\nu_1+\nu_2}\}$.

Suppose $x \neq \mathbf{0}$, in which case $\nu_1 \geq 1$. For each $i \in [\nu_1]$ let $\pi'_i \in \Pi_{\mathbf{0},(|x|_1),x}$ be the ℓ^1 -path from $\mathbf{0}$ to x that takes the necessary steps in the order $z_i, z_{i+1}, \dots, z_{\nu_1}, z_1, \dots, z_{i-1}$. Then for each $i \in [\nu_1]$ let $\pi_i \in \Pi_{\mathbf{0},(\ell),x}$ be the path that starts with $(\ell - |x|_1)/2$ repetitions of the $(z_i, -z_i)$ pair and then follows π'_i . For $i \in [\nu_2]$ let $\pi_{\nu_1+i} \in \Pi_{\mathbf{0},(\ell),x}$ be the path that starts with a z_{ν_1+i} step, then repeats the $(z_1, -z_1)$ pair $(\ell - |x|_1 - 2)/2$ times, then follows the steps of π'_1 , and finishes with a $-z_{\nu_1+i}$ step. Thus far we have constructed $\nu_1 + \nu_2 = 2d - \nu_1$ paths. For the remaining ν_1 paths we distinguish two cases.

If $\nu_1 = 1$ we need only one more path $\pi_{2d} \in \Pi_{\mathbf{0},(\ell),x}$. Take this to be the path that starts with a $-z_1$ step, repeats the $(z_1, -z_1)$ pair $(\ell - |x|_1 - 8)/2$ times, takes two z_2 steps, one z_1 step, follows the steps of π'_1 , takes one z_1 step, two $-z_2$ steps, and finishes with a $-z_1$ step.

If $\nu_1 > 1$, then for $i \in [\nu_1 - 1]$, let $\pi_{\nu_1+\nu_2+i} \in \Pi_{\mathbf{0},(\ell),x}$ be the path that starts with a $-z_i$ step, repeats the $(z_i, -z_i)$ pair $(\ell - |x|_1 - 4)/2$ times, takes a z_{i+1} step, follows the steps of π'_{i+1} , and ends with a z_i step followed by a $-z_{i+1}$ step. For $i = \nu_1$ the path π_{2d} is defined similarly, except that z_{i+1} and π'_{i+1} are replaced by z_1 and π'_1 , respectively.

One can check that the paths $\pi_i \in \Pi_{\mathbf{0},(\ell),x}$, $i \in [2d]$, are edge-disjoint. From

$$(B.3) \quad G_{\mathbf{0},(\ell),x} \leq \min_{i \in [2d]} T(\pi_i)$$

follows

$$(B.4) \quad \begin{aligned} \mathbb{P}\{G_{\mathbf{0},(\ell),x} \geq s\} &\leq \prod_{i=1}^{2d} \mathbb{P}\{T(\pi_i) \geq s\} \leq (\ell \mathbb{P}\{t(e) \geq s/\ell\})^{2d} \\ &= \ell^{2d} \mathbb{P}\{\min(t_1, \dots, t_{2d}) \geq s/\ell\}. \end{aligned}$$

If $x = \mathbf{0}$ (and hence $\nu_1 = 0$ and $\nu_2 = 2d$) then redo the last computation with the edge-disjoint paths π_i , $i \in [2d]$, that just repeat the pair $(z_i, -z_i)$. \square

Below we use the condition that a rational point $\zeta \in \mathcal{U}$ satisfies $\ell\zeta \in \mathcal{D}_\ell^\diamond$ for a positive integer ℓ such that $\ell\zeta \in \mathbb{Z}^d$. When zero steps are admissible ($\diamond = o$) this is of course trivial, and without zero steps ($\diamond = \langle \text{empty} \rangle$) this can be achieved if $\ell(1 - |\zeta|_1)$ is even. Therefore, one can take for example

$\ell = 2\ell'$ for $\ell' \in \mathbb{N}$ such that $\ell'\zeta \in \mathbb{Z}^d$. Properties of convex sets used below can be found in Chapter 18 of [17].

The following theorem comes by a standard application of the subadditive ergodic theorem.

THEOREM B.3. *Assume $r_0 > -\infty$. Fix $\zeta \in \mathbb{Q}^d \cap \mathcal{U}$ and $\diamond \in \{\langle \text{empty} \rangle, o\}$. Let $\ell \in \mathbb{N}$ be such that $\ell\zeta \in \mathcal{D}_\ell^\diamond$. Assume $\mathbb{E}[G_{0,(\ell),\ell\zeta}^\diamond] < \infty$. Then the limit*

$$(B.5) \quad g^\diamond(\zeta) = \inf_{n \in \mathbb{N}} \frac{\mathbb{E}[G_{0,(n\ell),n\ell\zeta}^\diamond]}{n\ell} = \lim_{n \rightarrow \infty} \frac{G_{0,(n\ell),n\ell\zeta}^\diamond}{n\ell} \in [r_0 \wedge 0, \ell^{-1}\mathbb{E}[G_{0,(\ell),\ell\zeta}^\diamond]]$$

exists almost surely and in L^1 and does not depend on the choice of ℓ . As a function of $\zeta \in \mathbb{Q}^d \cap \mathcal{U}$, g^\diamond is convex. Precisely, if $\zeta, \eta \in \mathbb{Q}^d \cap \mathcal{U}$ are such that $\mathbb{E}[G_{0,(\ell),\ell\zeta}^\diamond] < \infty$ and $\mathbb{E}[G_{0,(\ell),\ell\eta}^\diamond] < \infty$ for some $\ell \in \mathbb{N}$, then for any $t \in (0, 1) \cap \mathbb{Q}$, $\mathbb{E}[G_{0,(\ell'),\ell'(t\zeta+(1-t)\eta)}^\diamond] < \infty$ for some $\ell' \in \mathbb{N}$ and

$$(B.6) \quad g^\diamond(t\zeta + (1-t)\eta) \leq tg^\diamond(\zeta) + (1-t)g^\diamond(\eta).$$

Remark B.4 (Conditions for finiteness). By Lemma B.2, assumption (A.1) with $p = 1$ implies that $\mathbb{E}[G_{0,(\ell),\ell\zeta}^\diamond] < \infty$ for any $\zeta \in \mathbb{Q}^d \cap \mathcal{U}$ and any large enough $\ell \in \mathbb{N}$ that satisfies $\ell\zeta \in \mathcal{D}_\ell^\diamond$.

Next, from convexity we deduce local boundedness and then a local Lipschitz property.

LEMMA B.5. *Assume $r_0 > -\infty$ and (A.1) with $p = 1$. Fix $\zeta \in \mathbb{Q}^d \cap \text{int}\mathcal{U}$ and $\diamond \in \{\langle \text{empty} \rangle, o\}$. There exist $\varepsilon > 0$ and a finite constant C such that*

$$(B.7) \quad g^\diamond(\eta) \leq C \quad \text{for all } \eta \in \mathbb{Q}^d \cap \mathcal{U} \text{ such that } |\eta - \zeta|_1 \leq \varepsilon.$$

Proof. Take $\varepsilon > 0$ rational and small enough so that $\mathcal{A} = \{\eta \in \mathcal{U} : |\eta - \zeta|_1 \leq \varepsilon\} \subset \text{int}\mathcal{U}$. Let $\{\eta_i : i \in [2d]\} \subset \mathbb{Q}^d \cap \text{int}\mathcal{U}$ be the extreme points of the convex set \mathcal{A} . For $\eta \in \mathbb{Q}^d \cap \mathcal{A}$ write $\eta = \sum_{i=1}^{2d} \alpha_i \eta_i$ with rational $\alpha_i \in [0, 1]$ such that $\sum_{i \in [2d]} \alpha_i = 1$. By bound (B.5) and Remark B.4, $g^\diamond(\eta_i) < \infty$ for $i \in [2d]$. Convexity (B.6) implies

$$g^\diamond(\eta) \leq \sum_{i \in [2d]} \alpha_i g^\diamond(\eta_i) \leq \max_{i \in [2d]} g^\diamond(\eta_i)$$

and Lemma B.5 is proved. \square

LEMMA B.6. *Assume $r_0 > -\infty$ and (A.1) with $p = 1$. Fix $\zeta \in \mathbb{Q}^d \cap \text{int}\mathcal{U}$. There exist $\varepsilon > 0$ and a finite positive constant $C = C(\zeta, \varepsilon, r_0)$ such that for both $\diamond \in \{\langle \text{empty} \rangle, o\}$*

$$|g^\diamond(\eta) - g^\diamond(\eta')| \leq C|\eta - \eta'|_1 \quad \forall \eta, \eta' \in \mathbb{Q}^d \cap \text{int}\mathcal{U} \text{ with } |\eta - \zeta|_1 \leq \varepsilon \text{ and } |\eta' - \zeta|_1 \leq \varepsilon.$$

Proof. The assumptions of Lemma B.5 are satisfied and therefore there exists a rational $\varepsilon > 0$ and a finite constant C such that (B.7) holds. By taking $\varepsilon > 0$ smaller, if necessary, we can also guarantee that for any $\eta \in \mathbb{R}^d$, $|\eta - \zeta|_1 \leq \varepsilon$ implies $\eta \in \text{int}\mathcal{U}$.

Take $\eta \neq \eta'$ in $\text{int}\mathcal{U}$ with $|\eta - \zeta|_1 \leq \varepsilon/2$ and $|\eta' - \zeta|_1 \leq \varepsilon/2$. Abbreviate $\delta = 2\varepsilon^{-1}|\eta - \eta'|_1$ and write

$$\eta = \frac{1}{1+\delta} \cdot \eta' + \frac{\delta}{1+\delta} \cdot (\eta + \delta^{-1}(\eta - \eta')).$$

Note that

$$|\eta + \delta^{-1}(\eta - \eta') - \zeta|_1 \leq \frac{\varepsilon}{2} + \delta^{-1}|\eta - \eta'|_1 = \varepsilon.$$

Therefore, $\eta + \delta^{-1}(\eta - \eta') \in \text{int}\mathcal{U}$. By convexity (B.6) and boundedness (B.7) we have

$$g^\diamond(\eta) \leq \frac{1}{1+\delta} \cdot g^\diamond(\eta') + \frac{\delta}{1+\delta} \cdot g^\diamond(\eta + \delta^{-1}(\eta - \eta')) \leq \frac{1}{1+\delta} \cdot g^\diamond(\eta') + \frac{C\delta}{1+\delta}.$$

From $C \geq g^\diamond(\eta') \geq r_0 \wedge 0$,

$$g^\diamond(\eta) - g^\diamond(\eta') \leq \frac{\delta}{1+\delta}(-g^\diamond(\eta') + C) \leq \delta(|r_0 \wedge 0| + C) = 2\varepsilon^{-1}(|r_0 \wedge 0| + C)|\eta - \eta'|_1.$$

The other bound comes by switching around η and η' . \square

The next lemma is an immediate consequence of the local Lipschitz property proved in the previous lemma.

LEMMA B.7. *Assume $r_0 > -\infty$ and (A.1) with $p = 1$. Then g and g° extend to locally Lipschitz, continuous, convex functions on $\text{int } \mathcal{U}$.*

Before we prove the shape theorem we need two more auxiliary lemmas.

LEMMA B.8. *Assume (A.1) with $p = d$. Then there exists a finite constant κ such that*

$$(B.8) \quad \mathbb{P} \left\{ \forall \text{ pair } \epsilon < \rho \text{ in } (0, 1) \exists \ell_0 = \ell_0(\epsilon, \rho, \omega) \text{ such that} \right. \\ \left. \forall \ell \geq \ell_0, \forall \diamond \in \{\langle \text{empty} \rangle, o\} : \sup_{\substack{y \in \mathcal{D}_\ell^\diamond \\ \epsilon \ell \leq |y|_1 \leq \rho \ell}} \ell^{-1} G_{\mathbf{0}, (\ell), y}^\diamond \leq \kappa \right\} = 1.$$

Proof. It is enough to work with $\diamond = \langle \text{empty} \rangle$ since $G_{\mathbf{0}, (\ell), y}^\circ \leq G_{\mathbf{0}, (\ell), y}$. It is also enough to work with fixed $\epsilon < \rho$ since the suprema in question increase as we increase ρ and decrease ϵ .

Fix an integer $r \geq 5$ such that

$$\rho(1 + 8/r) < 1.$$

The strategy of the proof will be to bound $G_{\mathbf{0}, (\ell), y}$ by constructing edge-disjoint paths on the coarse-grained lattice $r\mathbb{Z}^d$ to a point \underline{y} that approximates y . An approach to finding such paths was developed in the proof of Lemma B.2.

Take ℓ large enough so that

$$(B.9) \quad \ell \geq 2(d+8)r\epsilon^{-1} \quad \text{and} \quad \rho(1 + 8/r)\ell + (d+8)(r+8) + dr + 8 \leq \ell.$$

For each $y \in \mathcal{D}_\ell$ with $\epsilon \ell \leq |y|_1 \leq \rho \ell$ pick $\underline{y} \in r\mathbb{Z}^d$ so that $|y - \underline{y}|_1 \leq dr$. As in Lemma B.2, let ν_1 be the number of $z \in \mathcal{R}$ such that $\underline{y} \cdot z > 0$ and let $\nu_2 = 2d - 2\nu_1$. Following the construction in the proof of Lemma B.2 we can produce edge-disjoint nearest-neighbor paths π'_i , $i \in [2d]$, on the coarse-grained lattice $r\mathbb{Z}^d$ from $\mathbf{0}$ to \underline{y} such that, in terms of the number steps taken on $r\mathbb{Z}^d$, π'_i has length $\underline{\ell}_i = \underline{\ell} = \lfloor \underline{y} \rfloor_1 / r$ for $i \in [\nu_1]$, π'_i has length $\underline{\ell}_i = \underline{\ell} + 2$ for $i \in \{\nu_1 + 1, \dots, \nu_1 + \nu_2\}$, and for $i > \nu_1 + \nu_2$, π'_i has length $\underline{\ell}_i = \underline{\ell} + 8$ if $\nu_1 = 1$ and $\underline{\ell}_i = \underline{\ell} + 4$ if $\nu_1 > 1$.

From $|y|_1 \leq \rho \ell$ and $|y - \underline{y}|_1 \leq dr$ follows $\underline{\ell} = \lfloor \underline{y} \rfloor_1 / r \leq (\rho \ell + dr)/r$, and then from (B.9)

$$(\underline{\ell} + 8)(r + 8) + |y - \underline{y}|_1 + 8 \leq ((\rho \ell + dr)/r + 8)(r + 8) + dr + 8 \leq \ell.$$

Define

$$q = \left\lfloor \frac{1}{2} \left(\frac{\ell - 8(r+8) - |y - \underline{y}|_1 - 8}{\underline{\ell}} - r - 8 \right) \right\rfloor.$$

Then

$$0 \leq q \leq \frac{\ell}{2\underline{\ell}} \leq \frac{r\ell}{2(|y|_1 - dr)} \leq r\epsilon^{-1}.$$

Define

$$(B.10) \quad m = \left\lfloor \frac{\ell - 8(r+8) - |y - \underline{y}|_1 - 8 - \underline{\ell}(r+8+2q)}{2} \right\rfloor.$$

Then

$$0 \leq m \leq \underline{\ell}.$$

Let $\pi'_{i,s}$ denote the position (on the original lattice) of the path π'_i after s steps (of size r). Let

$$(B.11) \quad \ell_i = (r+8)\underline{\ell}_i + 2q\underline{\ell} + 2m.$$

For each $i \in [2d]$ we have this identity:

$$(r+10+2q)m + (r+8+2q)(\underline{\ell} - m) + (r+8)(\underline{\ell}_i - \underline{\ell}) + \ell - \ell_i = \ell.$$

This equation gives a way to decompose the ℓ steps from $\mathbf{0}$ to y so that we first go through the vertices $\{\pi'_{i,s}\}_{0 \leq s \leq \underline{\ell}_i}$ and then use the last $\ell - \ell_i$ steps to go from \underline{y} to y . We continue with this next bound:

$$(B.12) \quad G_{\mathbf{0},(\ell),y} \leq \min_{i \in [2d]} \left\{ \sum_{s=0}^{m-1} G_{\pi'_{i,s},(r+10+2q),\pi'_{i,s+1}} + \sum_{s=m}^{\underline{\ell}-1} G_{\pi'_{i,s},(r+8+2q),\pi'_{i,s+1}} \right. \\ \left. + \sum_{s=\underline{\ell}}^{\underline{\ell}_i-1} G_{\pi'_{i,s},(r+8),\pi'_{i,s+1}} + G_{\underline{y},(\ell-\ell_i),y} \right\}.$$

Bound m in (B.10) by dropping $\lfloor \cdot \rfloor$ to turn (B.11) into this inequality (note that terms $2q\underline{\ell}$ cancel):

$$\ell_i \leq (r+8)(\underline{\ell} + 8) + \ell - 8(r+8) - |y - \underline{y}|_1 - 8 - (r+8)\underline{\ell} = \ell - |y - \underline{y}|_1 - 8.$$

Similarly,

$$\ell_i \geq \ell - |y - \underline{y}|_1 - 10 \geq \ell - dr - 10.$$

Fix $\kappa > 0$. For $j = d+1, \dots, 2d$ let $\mathbf{e}_j = -\mathbf{e}_{j-d}$. Define the events

$$\begin{aligned} \mathcal{E}_\ell^1 &= \{\exists j \in [2d] : G_{\mathbf{0},(r+8+2q),re_j} \geq \kappa\ell/14 \text{ or } G_{\mathbf{0},(r+10+2q),re_j} \geq \kappa\ell/14\}, \\ \mathcal{E}_\ell^2 &= \{\exists j \in [2d] : G_{-re_j,(r+8),\mathbf{0}} \geq \kappa\ell/14 \text{ or } G_{-re_j,(r+8+2q),\mathbf{0}} \geq \kappa\ell/14 \text{ or } G_{-re_j,(r+10+2q),\mathbf{0}} \geq \kappa\ell/14\}, \\ \mathcal{E}_\ell^3 &= \{\exists k \in \mathbb{N}, z \in \mathcal{D}_k : |z|_1 \leq dr, |z|_1 + 8 \leq k \leq dr + 10, G_{z,(k),\mathbf{0}} \geq \kappa\ell/14\}, \end{aligned}$$

and the event $\mathcal{E}_{\ell,y}^4$ on which for all $i \in [2d]$

$$(B.13) \quad \sum_{s=1}^{m \wedge (\underline{\ell}-1)} G_{\pi'_{i,s},(r+10+2q),\pi'_{i,s+1}} + \sum_{s=m \vee 1}^{\underline{\ell}-2} G_{\pi'_{i,s},(r+8+2q),\pi'_{i,s+1}} \geq \kappa\ell/14.$$

Then for ℓ_0 large enough to satisfy (B.9) and $\kappa > 0$,

$$(B.14) \quad \left\{ \sup_{\ell \geq \ell_0} \sup_{\substack{y \in \mathcal{D}_\ell \\ \ell \leq |y|_1 \leq \rho\ell}} \ell^{-1} G_{\mathbf{0},(\ell),y} > \kappa \right\} \subset \left(\bigcup_{\ell \geq \ell_0} \mathcal{E}_\ell^1 \right) \cup \left(\bigcup_{\ell \geq \ell_0} \bigcup_{\substack{y \in r\mathbb{Z}^d \\ \ell/2 \leq |y|_1 \leq \ell}} \mathcal{E}_\ell^2 \circ \theta_{\underline{y}} \right) \\ \cup \left(\bigcup_{\ell \geq \ell_0} \bigcup_{\substack{y \in \mathbb{Z}^d \\ \ell \leq |y|_1 \leq \ell}} \mathcal{E}_\ell^3 \circ \theta_y \right) \cup \left(\bigcup_{\ell \geq \ell_0} \bigcup_{\substack{y \in \mathcal{D}_\ell \\ \ell \leq |y|_1 \leq \ell}} \mathcal{E}_{\ell,y}^4 \right).$$

Here is the explanation for the inclusion above.

- (i) Further down the proof we add auxiliary paths around the r -steps of the path π'_i . Because the first r -steps share their initial point $\mathbf{0}$, their auxiliary paths would intersect and independence would be lost. The same is true for the last r -steps that share the endpoint \underline{y} . Hence these special steps are handled separately.

The event \mathcal{E}_ℓ^1 takes care of the first step of the path π'_i which is either in the first sum on the right in (B.12), or in the second sum in case $m = 0$ and the first sum is empty.

The event \mathcal{E}_ℓ^2 takes care of the last step to \underline{y} which can come from any one of the three sums on the right in (B.12). We have to check that the possible endpoints fall within the range $\epsilon\ell/2 \leq |\pi'_{i,s}|_1 \leq \ell$ of the union of shifts of \mathcal{E}_ℓ^2 : for $i \in [2d]$ and $\underline{\ell} \leq s \leq \underline{\ell}_i$,

$$|\pi'_{i,s}|_1 \geq |y|_1 - (d+8)r \geq \epsilon\ell/2$$

and since $\pi'_{i,s}$ is on an admissible path of length ℓ from $\mathbf{0}$ to y , it must be that $|\pi'_{i,s}|_1 \leq \ell$.

(ii) The event \mathcal{E}_ℓ^3 takes care of the path segment from \underline{y} to y .

(iii) On the complement of the first three unions on the right-hand side of (B.14) we have for each $i \in [2d]$,

$$\begin{aligned} & G_{\pi'_{i,0},(r+10+2q),\pi'_{i,1}} \mathbb{1}\{m \geq 1\} + G_{\pi'_{i,0},(r+8+2q),\pi'_{i,1}} \mathbb{1}\{m = 0\} + G_{\pi'_{i,\underline{\ell}-1},(r+10+2q),\pi'_{i,\underline{\ell}}} \mathbb{1}\{m = \underline{\ell}\} \\ & + G_{\pi'_{i,\underline{\ell}-1},(r+8+2q),\pi'_{i,\underline{\ell}}} \mathbb{1}\{m < \underline{\ell}\} + \sum_{s=\underline{\ell}}^{\underline{\ell}_i-1} G_{\pi'_{i,s},(r+8),\pi'_{i,s+1}} + G_{\underline{y},(\underline{\ell}-\underline{\ell}_i),y} < 13\kappa\ell/14. \end{aligned}$$

Since $\underline{\ell}_i - \underline{\ell} \leq 8$, the left-hand side has at most 13 terms, which explains the bound on the right. Thus, if in addition $G_{\mathbf{0},(\ell),y} > \kappa\ell$, then event $\mathcal{E}_{\ell,y}^4$ must occur.

By bounding the probabilities of the unions on the right of (B.14), we show next that for some fixed κ that does not depend on $0 < \epsilon < \rho < 1$,

$$(B.15) \quad \lim_{\ell_0 \rightarrow \infty} \mathbb{P} \left\{ \sup_{\ell \geq \ell_0} \sup_{\substack{y \in \mathcal{D}_\ell \\ \epsilon\ell \leq |y|_1 \leq \rho\ell}} \ell^{-1} G_{\mathbf{0},(\ell),y} > \kappa \right\} = 0.$$

This will imply the conclusion (B.8) as we point out at the end of the proof.

By (B.2), $\mathbb{P}(\mathcal{E}_\ell^1)$ is summable if (A.1) is satisfied with $p = 1$. Then $\mathbb{P}(\bigcup_{\ell \geq \ell_0} \mathcal{E}_\ell^1) \rightarrow 0$ as $\ell_0 \rightarrow \infty$. Next, observe that

$$\bigcup_{\ell \geq \ell_0} \bigcup_{\substack{y \in \mathbb{Z}^d \\ \epsilon\ell \leq |y|_1 \leq \ell}} \mathcal{E}_\ell^3 \circ \theta_y \subset \bigcup_{\ell \geq \epsilon\ell_0} \bigcup_{\substack{y \in \mathbb{Z}^d \\ |y|_1 = \ell}} \mathcal{E}_\ell^3 \circ \theta_y$$

and hence

$$\mathbb{P} \left(\bigcup_{\ell \geq \ell_0} \bigcup_{\substack{y \in \mathbb{Z}^d \\ \epsilon\ell \leq |y|_1 \leq \ell}} \mathcal{E}_\ell^3 \circ \theta_y \right) \leq \sum_{\ell \geq \epsilon\ell_0} \mathbb{P} \left(\bigcup_{\substack{y \in \mathbb{Z}^d \\ |y|_1 = \ell}} \mathcal{E}_\ell^3 \circ \theta_y \right),$$

which goes to 0 when $\ell_0 \rightarrow \infty$ if $\ell^{d-1} \mathbb{P}(\mathcal{E}_\ell^3)$ is summable. This is the case if (A.1) is satisfied with $p = d$. The union over $\mathcal{E}_\ell^2 \circ \theta_y$ is controlled similarly.

It remains to control the probability of the union of the events $\mathcal{E}_{\ell,y}^4$ in (B.14). For $i \in [2d]$ and $s \in [\underline{\ell} - 2]$, for each segment $[\pi'_{i,s}, \pi'_{i,s+1}]$, bound both passage times $G_{\pi'_{i,s},(r+10+2q),\pi'_{i,s+1}}$ and $G_{\pi'_{i,s},(r+8+2q),\pi'_{i,s+1}}$ as was done in (B.3) by using $2d$ independent auxiliary paths of the appropriate lengths. For each segment $[\pi'_{i,s}, \pi'_{i,s+1}]$ add the two upper bounds and denote the result by $A_{\pi'_{i,s},\pi'_{i,s+1}}$.

The terms for $s = 0$ and $s \geq \underline{\ell} - 1$ were excluded from the events $\mathcal{E}_{\ell,y}^4$ so that for distinct indices $i \in [2d]$ the $2d$ auxiliary paths constructed around the segments $\{[\pi'_{i,s}, \pi'_{i,s+1}]\}_{s \in [\underline{\ell}-2]}$ stay separated. (We chose $r \geq 5$ at the outset to guarantee this separation.) Replace the edge weights $t(e)$ with $t^+(e) = \max(t(e), 0)$ to ensure that the upper bounds are nonnegative. After these steps, the left-hand side of (B.13) is bounded above by $\sum_{s=1}^{\underline{\ell}-2} A_{\pi'_{i,s},\pi'_{i,s+1}}$.

All the A -terms have the same distribution as $A_{\mathbf{0},re_1}$. As explained above, over distinct indices $i \in [2d]$ the random vectors $\{A_{\pi'_{i,s},\pi'_{i,s+1}} : s \in [\underline{\ell} - 2]\}$ are independent. For any particular $i \in [2d]$, $\{A_{\pi'_{i,s},\pi'_{i,s+1}} : s \in [\underline{\ell} - 2] \text{ even}\}$ are i.i.d. and $\{A_{\pi'_{i,s},\pi'_{i,s+1}} : s \in [\underline{\ell} - 2] \text{ odd}\}$ are i.i.d. because now we skip every other r -step. See Figure B.1.

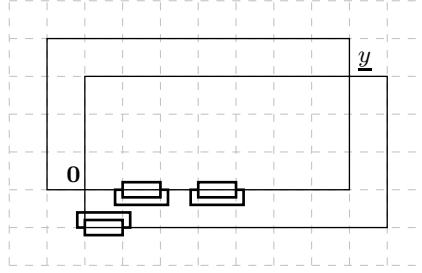

FIGURE B.1. The light dashed grid is the coarse-grained lattice $r\mathbb{Z}^d$. The thin lines along this grid represent four π'_i -paths from $\mathbf{0}$ to y . Three r -steps on two π'_i -paths are decorated with auxiliary paths represented by thick lines. The auxiliary paths are edge-disjoint as long as they associate (i) with different π'_i -paths, (ii) with non-consecutive r -steps on the same path π'_i , or (iii) with r -steps that are neither the first nor the last one of a π'_i -path.

We derive the concluding estimate. Recall that

$$\underline{\ell} \leq (\rho\ell + dr)/r \leq (\rho r^{-1} + 1)\ell.$$

Let $c = \lceil (\rho r^{-1} + 1)/2 \rceil$. Let S_n denote the sum of n independent copies of $A_{\mathbf{0}, r\mathbf{e}_1}$. Since the A -terms are nonnegative we have

$$\mathbb{P}\left(\sum_{s \in [\underline{\ell}-2] \text{ even}} A_{\pi'_{i,s}, \pi'_{i,s+1}} \geq \kappa\ell/28\right) \leq \mathbb{P}(S_{c\underline{\ell}} \geq \kappa\ell/28).$$

The same holds for the sum over odd s . Thus we have

$$\mathbb{P}(\mathcal{E}_{\ell,y}^4) \leq 2^{2d} \mathbb{P}(S_{c\underline{\ell}} \geq \kappa\ell/28)^{2d},$$

Take $\kappa > 28c\mathbb{E}[A_{\mathbf{0}, r\mathbf{e}_1}]$ and use the fact that there are no more than $(2\ell + 1)^d$ points $y \in \mathcal{D}_\ell$ to get

$$\begin{aligned} \mathbb{P}\left(\bigcup_{\ell \geq \ell_0} \bigcup_{\substack{y \in \mathcal{D}_\ell \\ c\ell \leq |y|_1 \leq \rho\ell}} \mathcal{E}_{\ell,y}^4\right) &\leq \sum_{\ell \geq \ell_0} (2\ell + 1)^d \mathbb{P}(\mathcal{E}_{\ell,y}^4) \leq \sum_{\ell \geq \ell_0} (8\ell + 4)^d \mathbb{P}(S_{c\underline{\ell}} \geq \kappa\ell/28)^{2d} \\ &\leq \sum_{\ell \geq \ell_0} \frac{(8\ell + 4)^d c^{2d} \text{Var}(A_{\mathbf{0}, r\mathbf{e}_1})^{2d}}{(\kappa/28 - c\mathbb{E}[A_{\mathbf{0}, r\mathbf{e}_1}])^{4d} \ell^{2d}}. \end{aligned}$$

The bound (B.4) can be utilized to show that each $G_{\mathbf{0},(\ell),x}$ and thereby $A_{\mathbf{0}, r\mathbf{e}_1}$ is square-integrable if (A.1) holds with $p = 2$. The above then converges to 0 as $\ell_0 \rightarrow \infty$. We have verified (B.15). The claim of the lemma follows:

$$\mathbb{P}\left\{\forall \ell_0 \exists \ell \geq \ell_0 : \sup_{\substack{y \in \mathcal{D}_\ell \\ c\ell \leq |y|_1 \leq \rho\ell}} \ell^{-1} G_{\mathbf{0},(\ell),y} > \kappa\right\} = \lim_{\ell_0 \rightarrow \infty} \mathbb{P}\left\{\exists \ell \geq \ell_0 : \sup_{\substack{y \in \mathcal{D}_\ell \\ c\ell \leq |y|_1 \leq \rho\ell}} \ell^{-1} G_{\mathbf{0},(\ell),y} > \kappa\right\} = 0. \quad \square$$

LEMMA B.9. Assume (A.1) with $p = d$. Then for any $0 < \epsilon < \rho < 1$ there exists a deterministic constant $\kappa \in (0, \infty)$ such that, with probability one for each $x \in \mathbb{Z}^d$, there exists a strictly increasing random sequence $\{m(n)\}_{n \in \mathbb{N}} \subset \mathbb{N}$ such that $m(n+1)/m(n) \rightarrow 1$ and for $\diamond \in \{\langle \mathbf{empty} \rangle, o\}$ and $\ell \in \mathbb{N}$

$$(B.16) \quad G_{m(n)x,(\ell),z}^\diamond \leq \kappa\ell \quad \forall z \in m(n)x + \mathcal{D}_\ell^\diamond \text{ such that } c\ell \leq |z - m(n)x|_1 \leq \rho\ell.$$

Proof. If $x = \mathbf{0}$ take $m(n) = \ell_0 + n$ from Lemma B.8. Next suppose $x \neq \mathbf{0}$. Fix $\epsilon < \rho$ in $(0, 1)$. Apply Lemma B.8 to choose a finite constant κ such that

$$\mathbb{P}(\mathcal{E}) \equiv \mathbb{P} \left\{ \forall \diamond \in \{\langle \mathbf{empty} \rangle, o\} : \sup_{\substack{\ell \in \mathbb{N}, y \in \mathcal{D}_\ell^\diamond \\ \epsilon \ell \leq |y|_1 \leq \rho \ell}} \ell^{-1} G_{\mathbf{0},(\ell),y}^\diamond \leq \kappa \right\} > 0.$$

The ergodic theorem implies that with probability one, for each $x \in \mathbb{Z}^d \setminus \{\mathbf{0}\}$ there exist infinitely many $m \in \mathbb{N}$ such that

$$\forall \diamond \in \{\langle \mathbf{empty} \rangle, o\} : \sup_{\substack{\ell \in \mathbb{N}, y \in mx + \mathcal{D}_\ell^\diamond \\ \epsilon \ell \leq |y - mx|_1 \leq \rho \ell}} \ell^{-1} G_{mx,(\ell),y}^\diamond \leq \kappa.$$

Enumerate these m 's as a strictly increasing sequence $\{m(n) : n \in \mathbb{N}\}$. Then for \mathbb{P} -almost every ω

$$\lim_{n \rightarrow \infty} \frac{n}{m(n)} = \lim_{n \rightarrow \infty} \frac{1}{m(n)} \sum_{k=1}^{m(n)} \mathbb{1}\{\theta_{kx}\omega \in \mathcal{E}\} = \mathbb{P}(\mathcal{E}) > 0.$$

Consequently, $m(n+1)/m(n)$ converges to 1. \square

We are ready for the shape theorem.

THEOREM B.10. *Assume $r_0 > -\infty$ and (A.1) with $p = d$. Fix $\diamond \in \{\langle \mathbf{empty} \rangle, o\}$. Let \mathcal{V} be a closed subset of $\text{int}\mathcal{U}$. The following holds with probability one:*

$$(B.17) \quad \lim_{\ell \rightarrow \infty} \max_{x \in \mathcal{D}_\ell^\diamond : x/\ell \in \mathcal{V}} \ell^{-1} |G_{\mathbf{0},(\ell),x}^\diamond - \ell g^\diamond(x/\ell)| = 0.$$

Proof. The proof follows steps similar to those of (A.3). We treat the case $\diamond = o$, the other case being a simpler version. Let Ω_0 be the full probability event that consists of intersecting the event on which (B.5) holds for all $\zeta \in \mathbb{Q}^d \cap \text{int}\mathcal{U}$ with the event in (B.8) and the events in Lemma B.9 for all rational $\epsilon < \rho$ in $(0, 1)$. Fix $\omega \in \Omega_0$. We show that for this ω

$$(B.18) \quad \underline{\lim}_{\ell \rightarrow \infty} \min_{x \in \mathcal{D}_\ell^\diamond : x/\ell \in \mathcal{V}} \ell^{-1} (G_{\mathbf{0},(\ell),x}^o - \ell g^o(x/\ell)) \geq 0 \quad \text{and}$$

$$(B.19) \quad \overline{\lim}_{\ell \rightarrow \infty} \max_{x \in \mathcal{D}_\ell^\diamond : x/\ell \in \mathcal{V}} \ell^{-1} (G_{\mathbf{0},(\ell),x}^o - \ell g^o(x/\ell)) \leq 0.$$

Proof of (B.18). Fix (ω -dependent) sequences $\ell_k \rightarrow \infty$ and $x_k \in \mathcal{D}_{\ell_k}^o$ that realize the lim on the left-hand side of (B.18). Since $x_k \in \mathcal{D}_{\ell_k}^o$ there are coefficients $a_{i,k}^\pm \in \mathbb{Z}_+$ such that

$$(B.20) \quad x_k = \sum_{i=1}^d (a_{i,k}^+ - a_{i,k}^-) \mathbf{e}_i \quad \text{and} \quad \sum_{i=1}^d (a_{i,k}^+ + a_{i,k}^-) \leq \ell_k.$$

Pass to subsequences, still denoted by ℓ_k and x_k , such that

$$(B.21) \quad a_{i,k}^\pm / \ell_k \xrightarrow[k \rightarrow \infty]{} \alpha_i^\pm \in [0, 1] \quad \text{with} \quad \sum_{i=1}^d (\alpha_i^+ + \alpha_i^-) \leq 1.$$

Let $\xi = \sum_{i=1}^d (\alpha_i^+ - \alpha_i^-) \mathbf{e}_i = \lim_{k \rightarrow \infty} x_k / \ell_k \in \mathcal{V} \subset \text{int}\mathcal{U}$. We approximate ξ with a rational point ζ to which we can apply (B.5). Bound (B.18) comes by building a path from x_k to a multiple of ζ and by the subadditivity of passage times. Here are the details.

First, we dispose of the case where there are infinitely many k for which $a_{i,k}^+ = a_{i,k}^- = 0$ for all $i \in [d]$. If this is the case, then going along a further subsequence we can assume that $x_k = \mathbf{0}$ for all k . Applying (B.5) with $\zeta = \mathbf{0}$ gives $\ell_k^{-1} G_{\mathbf{0},(\ell_k),x_k}^o \rightarrow g^o(\mathbf{0})$ and since $g^o(x_k/\ell_k) = g^o(\mathbf{0})$ for all k we see that the lim on the left-hand side of (B.18) is 0. We can therefore assume that for each k there

exists some $i \in [d]$ such that $a_{i,k}^+ \geq 1$ or $a_{i,k}^- \geq 1$. Consequently, if we let \mathcal{I} denote the set of indices $i \in [d]$ for which $a_{i,k}^+ \geq 1$ or $a_{i,k}^- \geq 1$ for infinitely many k , then $\mathcal{I} \neq \emptyset$.

Let

$$(B.22) \quad \gamma = \min\{\alpha_i^- : \alpha_i^- > 0, i \in [d]\} \wedge \min\{\alpha_i^+ : \alpha_i^+ > 0, i \in [d]\} > 0,$$

with the convention that $\min \emptyset = \infty$, which takes care of the case $\alpha_i^\pm = 0$ for all $i \in [d]$. Let δ be a rational in $(0, (\gamma \wedge 1)/(4d))$. For $i \in [d] \setminus \mathcal{I}$ let $\beta_i^+ = \beta_i^- = 0$ and note that we also have $\alpha_i^+ = \alpha_i^- = 0$. For $i \in \mathcal{I}$ take $\beta_i^\pm \in [\delta, 1] \cap \mathbb{Q}$ such that $|\alpha_i^\pm - \beta_i^\pm| \leq 2d\delta$,

$$\sum_{i=1}^d (\beta_i^+ + \beta_i^-) \leq 1, \quad \text{and} \quad \forall j \in \mathcal{I} : (1 + 5d\gamma^{-1})(\beta_j^+ - \beta_j^-) \neq \alpha_j^+ - \alpha_j^-.$$

Let $\zeta = \sum_{i=1}^d (\beta_i^+ - \beta_i^-) \mathbf{e}_i$ and take $\delta > 0$ small enough so that $\zeta \in \text{int} \mathcal{U}$. We will eventually take $\delta \rightarrow 0$, which sends $\zeta \rightarrow \xi$.

We have for all $i \in \mathcal{I}$

$$(B.23) \quad (1 + 5d\delta\gamma^{-1})\beta_i^+ - \alpha_i^+ \geq \delta \quad \text{and} \quad (1 + 5d\delta\gamma^{-1})\beta_i^- - \alpha_i^- \geq \delta.$$

To see this, note that when $\alpha_i^+ > 0$ we have

$$(1 + 5d\delta\gamma^{-1})\beta_i^+ - \alpha_i^+ \geq (1 + 5d\delta\gamma^{-1})(\alpha_i^+ - 2d\delta) - \alpha_i^+ \geq d\delta/2 \geq \delta$$

and when $\alpha_i^+ = 0$ (but $i \in \mathcal{I}$) we have

$$(1 + 5d\delta\gamma^{-1})\beta_i^+ - \alpha_i^+ = (1 + 5d\delta\gamma^{-1})\beta_i^+ \geq \beta_i^+ \geq \delta.$$

The same holds with superscript $-$.

Let

$$\zeta' = \frac{\sum_{i \in \mathcal{I}} \left((1 + 5d\delta\gamma^{-1})(\beta_i^+ - \beta_i^-) - (\alpha_i^+ - \alpha_i^-) \right) \mathbf{e}_i}{\sum_{i \in \mathcal{I}} \left((1 + 5d\delta\gamma^{-1})(\beta_i^+ + \beta_i^-) - (\alpha_i^+ + \alpha_i^-) \right)}.$$

The choice of β_i^\pm guarantees that $\zeta' \neq \mathbf{0}$. Furthermore, (B.23) shows that ζ' is a convex combination of the vectors $\{\pm \mathbf{e}_i : i \in \mathcal{I}\}$ with all strictly positive coefficients. Consequently, $\zeta' \in \text{int} \mathcal{U}$.

Take rational $\epsilon < \rho$ in $(0, 1)$ such that $\epsilon < |\zeta'|_1 < \rho$. Let $\ell \in \mathbb{N}$ be such that $\ell\beta_i^+, \ell\beta_i^- \in \mathbb{N}$ for $i \in \mathcal{I}$ and take \bar{n}_k such that

$$m(\bar{n}_k - 1) \leq (1 + 5d\delta\gamma^{-1})\ell_k/\ell \leq m(\bar{n}_k),$$

for the sequence $m(n)$ in Lemma B.9 corresponding to the above choice of ϵ and ρ and to $x = \ell\zeta$. Abbreviate $\bar{m}_k = m(\bar{n}_k)$. Using (B.23) we have for $i \in \mathcal{I}$

$$(B.24) \quad \lim_{k \rightarrow \infty} \ell_k^{-1} (\bar{m}_k \ell \beta_i^+ - a_{i,k}^+) = (1 + 5d\delta\gamma^{-1})\beta_i^+ - \alpha_i^+ \geq \delta.$$

The same holds with superscript $-$. Thus, for all $i \in \mathcal{I}$ and for large k

$$(B.25) \quad \bar{m}_k \ell \beta_i^\pm \geq a_{i,k}^\pm + \delta \ell_k / 2.$$

This implies that when k is large, $\bar{m}_k \ell \zeta$ (which belongs to \mathbb{Z}^d) is accessible from x_k by an \mathcal{R} -admissible path of length

$$(B.26) \quad \bar{j}_k = \sum_{i=1}^d (\bar{m}_k \ell \beta_i^+ - a_{i,k}^+) + \sum_{i=1}^d (\bar{m}_k \ell \beta_i^- - a_{i,k}^-).$$

Note that

$$(B.27) \quad \lim_{k \rightarrow \infty} \bar{j}_k / \ell_k = \sum_{i=1}^d ((1 + 5d\delta\gamma^{-1})\beta_i^+ - \alpha_i^+) + \sum_{i=1}^d ((1 + 5d\delta\gamma^{-1})\beta_i^- - \alpha_i^-) \leq (4d + 5\gamma^{-1})d\delta.$$

The first equality and (B.24) imply that

$$\lim_{k \rightarrow \infty} \frac{\overline{m}_k \ell \zeta - x_k}{j_k} = \zeta'$$

and therefore $\epsilon \overline{j}_k \leq |\overline{m}_k \ell \zeta - x_k|_1 \leq \rho \overline{j}_k$ for k large enough. This will allow us to apply (B.16).

Since x_k is accessible from $\mathbf{0}$ by an \mathcal{R} -admissible path of length $\sum_{i=1}^d (a_{i,k}^+ + a_{i,k}^-) \leq \ell_k$, concatenating this path and the one from x_k to $\overline{m}_k \ell \zeta$ gives an \mathcal{R} -admissible path from $\mathbf{0}$ to $\overline{m}_k \ell \zeta$ of length

$$\sum_{i=1}^d \overline{m}_k \ell (\beta_i^+ + \beta_i^-) \leq \overline{m}_k \ell.$$

Hence $\overline{m}_k \ell \zeta \in \mathcal{D}_{\overline{m}_k \ell}^o$. Subadditivity now gives

$$G_{\mathbf{0}, (\overline{m}_k \ell), \overline{m}_k \ell \zeta}^o \leq G_{\mathbf{0}, (\ell_k), x_k}^o + G_{x_k, (\overline{j}_k), \overline{m}_k \ell \zeta}^o.$$

Using this, (B.16), and (B.27), we get

$$(1 + 5d\delta\gamma^{-1})g^o(\zeta) = \lim_{k \rightarrow \infty} G_{\mathbf{0}, (\overline{m}_k \ell), \overline{m}_k \ell \zeta}^o \leq \varliminf_{k \rightarrow \infty} \frac{G_{\mathbf{0}, (\ell_k), x_k}^o}{\ell_k} + \kappa(4d + 5\gamma^{-1})d\delta.$$

Taking $\delta \rightarrow 0$ and the continuity of g^o on $\text{int } \mathcal{U}$ gives

$$g^o(\xi) \leq \varliminf_{k \rightarrow \infty} \frac{G_{\mathbf{0}, (\ell_k), x_k}^o}{\ell_k}.$$

Since $x_k/\ell_k \in \mathcal{V} \subset \text{int } \mathcal{U}$ and $x_k/\ell_k \rightarrow \xi$, using again the continuity of g^o on $\text{int } \mathcal{U}$ completes the proof of (B.18):

$$\varliminf_{k \rightarrow \infty} \ell_k^{-1} (G_{\mathbf{0}, (\ell_k), x_k}^o - \ell_k g^o(x_k/\ell_k)) \geq 0.$$

Proof of (B.19). Proceed similarly to the proof of (B.18), but with the sequences $\ell_k \rightarrow \infty$ and $x_k \in \mathcal{D}_{\ell_k}^o$ realizing the $\overline{\lim}$ on the left-hand side of (B.19). Again, we have the representation (B.20), the limits (B.21), and $\xi = \sum_{i \in [d]} (\alpha_i^+ - \alpha_i^-) \mathbf{e}_i \in \mathcal{V}$.

We start by treating the case when $\xi = \mathbf{0}$. In this case let $j_k = 2|x_k|_1$ or $j_k = 2|x_k|_1 + 1$, so that $\ell_k - j_k$ is even. Observe that $j_k/\ell_k \rightarrow 0$ and hence $\ell_k \geq j_k$ for k large. Thus, one can make an admissible loop of length $\ell_k - j_k$ from $\mathbf{0}$ back to $\mathbf{0}$ and then take a path of length j_k from $\mathbf{0}$ to x_k . From (B.5) we have $\ell_k^{-1} G_{\mathbf{0}, (\ell_k - j_k), \mathbf{0}}^o \rightarrow g^o(\mathbf{0})$. If j_k is bounded then so is $|x_k|_1$ and we have $\ell_k^{-1} G_{\mathbf{0}, (j_k), x_k}^o \rightarrow 0$. On the other hand, if $j_k \rightarrow \infty$ along some subsequence, then along this subsequence, and for k large, we have $j_k/3 \leq |x_k|_1 \leq 2j_k/3$ and, applying (B.8), we then get

$$G_{\mathbf{0}, (\ell_k), x_k}^o \leq G_{\mathbf{0}, (\ell_k - j_k), \mathbf{0}}^o + G_{\mathbf{0}, (j_k), x_k}^o \leq G_{\mathbf{0}, (\ell_k - j_k), \mathbf{0}}^o + \kappa j_k,$$

for k large enough. Dividing by ℓ_k and taking $k \rightarrow \infty$ we deduce that

$$\overline{\lim}_{k \rightarrow \infty} \ell_k^{-1} G_{\mathbf{0}, (\ell_k), x_k}^o \leq g^o(\mathbf{0}).$$

The continuity of g^o at $\mathbf{0}$ implies then that the $\overline{\lim}$ on the left-hand side of (B.19) is 0. For the rest of the proof we can and will assume that $\xi \neq \mathbf{0}$.

Define $\gamma \in (0, \infty)$ as in (B.22). Let δ be a rational in $(0, \gamma/2)$. Choose β_i^\pm , $i \in [d]$, so that for $\square \in \{-, +\}$, when $\alpha_i^\square = 0$ we have $\beta_i^\square = 0$ and when $\alpha_i^\square > 0$ we have $\beta_i^\square \in [\delta, 1] \cap \mathbb{Q}$ such that $|\alpha_i^\square - \beta_i^\square| \leq \delta$ and overall we have

$$\sum_{i=1}^d (\beta_i^+ + \beta_i^-) \leq 1 \quad \text{and} \quad (1 - 2\delta\gamma^{-1}) \sum_{i \in [d]} (\beta_i^+ - \beta_i^-) \mathbf{e}_i \neq \sum_{i \in [d]} (\alpha_i^+ - \alpha_i^-) \mathbf{e}_i.$$

This is possible since $\xi \neq \mathbf{0}$ and therefore $\alpha_i^\square > 0$ for some $i \in [d]$ and $\square \in \{-, +\}$. Let $\zeta = \sum_{i=1}^d (\beta_i^+ - \beta_i^-) \mathbf{e}_i$ and choose δ small enough so that $\zeta \in \text{int } \mathcal{U}$. Note that

$$\alpha_i^\square - (1 - 2\delta\gamma^{-1})\beta_i^\square \geq 0 \quad \text{for all } i \in [d] \text{ and } \square \in \{-, +\}.$$

Indeed, this clearly holds when $\alpha_i^\square = 0$ and when $\alpha_i^\square > 0$ we have

$$\alpha_i^\square - (1 - 2\delta\gamma^{-1})\beta_i^\square \geq \alpha_i^\square - (1 - 2\delta\gamma^{-1})(\alpha_i^\square + \delta) \geq \delta.$$

The above two observations imply that

$$\zeta' = \frac{\sum_{i \in [d]} \left((\alpha_i^+ - \alpha_i^-) - (1 - 2\delta\gamma^{-1})(\beta_i^+ - \beta_i^-) \right) \mathbf{e}_i}{\delta + \sum_{i \in [d]} \left((\alpha_i^+ + \alpha_i^-) - (1 - 2\delta\gamma^{-1})(\beta_i^+ + \beta_i^-) \right)} \in \text{int } \mathcal{U} \setminus \{\mathbf{0}\}.$$

We can then find rational $\epsilon < \rho$ in $(0, 1)$ such that $\epsilon < |\zeta'|_1 < \rho$.

Let $\ell \in \mathbb{N}$ be such that $\ell\beta_i^+, \ell\beta_i^- \in \mathbb{Z}_+$ for $i \in [d]$ and take \underline{n}_k such that

$$m(\underline{n}_k) \leq (1 - 2\delta\gamma^{-1})\ell_k/\ell \leq m(\underline{n}_k + 1),$$

for the sequence $m(n)$ in Lemma B.9 corresponding to $x = \ell\zeta$ and to the above choice of ϵ and ρ . Abbreviate $\underline{m}_k = m(\underline{n}_k)$ and observe that if $\alpha_i^+ > 0$ then

$$(B.28) \quad \lim_{k \rightarrow \infty} \ell_k^{-1} (a_{i,k}^+ - \underline{m}_k \ell \beta_i^+) = \alpha_i^+ - (1 - 2\delta\gamma^{-1})\beta_i^+ \geq \delta.$$

Then for large k

$$(B.29) \quad a_{i,k}^+ - \underline{m}_k \ell \beta_i^+ \geq 0$$

This inequality is trivial if $\alpha_i^+ = \beta_i^+ = 0$. The same computation works with minus sign superscripts. This implies that x_k is accessible from $\underline{m}_k \ell \zeta$ in

$$\underline{j}_k = \sum_{i=1}^d (a_{i,k}^+ - \underline{m}_k \ell \beta_i^+) + \sum_{i=1}^d (a_{i,k}^- - \underline{m}_k \ell \beta_i^-)$$

\mathcal{R} -steps and $[\delta\ell_k]$ $\mathbf{0}$ -steps. Note that

$$\lim_{k \rightarrow \infty} \underline{j}_k / \ell_k = \sum_{i=1}^d (\alpha_i^+ - (1 - 2\delta\gamma^{-1})\beta_i^+) + \sum_{i=1}^d (\alpha_i^- - (1 - 2\delta\gamma^{-1})\beta_i^-) \leq (2d + 2\gamma^{-1})\delta.$$

As a consequence,

$$\lim_{k \rightarrow \infty} \frac{x_k - \underline{m}_k \ell \zeta}{[\delta\ell_k] + \underline{j}_k} = \zeta'$$

and one can then apply (B.16). Then, as in the proof of (B.18), using subadditivity then taking $k \rightarrow \infty$ and then $\delta \rightarrow 0$ and using the continuity of g^o on $\text{int } \mathcal{U}$ gives

$$\overline{\lim}_{k \rightarrow \infty} \frac{G_{\mathbf{0}, (\ell_k), x_k}^o}{\ell_k} \leq g^o(\xi).$$

Another use of the continuity of g^o completes the proof of (B.19). □

Proof of Theorem B.1. Apply Theorem B.10 with $\mathcal{V} = \{\xi \in \mathcal{U} : |\xi|_1 \leq 1/(1 + \alpha)\}$. □

APPENDIX C. PEIERLS ARGUMENT

This appendix follows the ideas of [11, 20]. First we prove a general estimate and then specialize it to prove Lemma 5.3. Let $d \in \mathbb{N}$. Tile \mathbb{Z}^d by N -cubes $S(\mathbf{k}) = N\mathbf{k} + [0, N]^d$ indexed by $\mathbf{k} \in \mathbb{Z}^d$. Each N -cube $S(\mathbf{k})$ is colored randomly black or white in a shift-stationary manner. Let $p = p(N)$ be the marginal probability that a particular cube is black and assume that

$$(C.1) \quad p(N) \rightarrow 1 \quad \text{as } N \rightarrow \infty.$$

Assume finite range dependence: there is a strictly positive integer constant a_0 such that

$$(C.2) \quad \forall \mathbf{u} \in \mathbb{Z}^d, \text{ the colors of the cubes } \{S(\mathbf{k}) : \mathbf{k} \in \mathbf{u} + a_0\mathbb{Z}^d\} \text{ are i.i.d.}$$

There are $K_0 = a_0^d$ distinct i.i.d. collections, indexed by $\mathbf{u} \in \{0, 1, \dots, a_0 - 1\}^d$.

It may be desirable to let the separation of the cubes be a parameter. For a positive integer a_1 and $\mathbf{u} \in \{0, 1, \dots, a_1 - 1\}^d$, define the collection $\mathcal{S}_{a_1, \mathbf{u}} = \{S(\mathbf{k}) : \mathbf{k} \in \mathbf{u} + a_1\mathbb{Z}^d\}$ of cubes with lower left corners on the grid $\mathbf{u} + a_1\mathbb{Z}^d$. For a given a_1 , $K_1 = a_1^d$ is the number of distinct collections $\mathcal{S}_{a_1, \mathbf{u}}$ indexed by $\mathbf{u} \in \{0, 1, \dots, a_1 - 1\}^d$. We always consider $a_1 \geq a_0$ where a_0 is the fixed constant of the independence assumption (C.2).

Let $\mathbb{B}(0, r) = \{x \in \mathbb{Z}^d : |x|_1 \leq r\}$ denote the ℓ^1 -ball (diamond) of radius $[r]$ in \mathbb{Z}^d , with (inner) boundary $\partial\mathbb{B}(0, r) = \{x \in \mathbb{Z}^d : |x|_1 = [r]\}$.

LEMMA C.1. *Assume (C.1) and (C.2). Let $a_1 \in \mathbb{Z}_{\geq a_0}$ and $K_1 = a_1^d$. Then there exists a constant $N_0 = N_0(d)$ such that for $N \geq N_0$ and $n \geq 2(d+1)N$,*

$$(C.3) \quad \mathbb{P}\left\{ \forall \text{ lattice path } \pi \text{ from the origin to } \partial\mathbb{B}(0, n) \exists \mathbf{u} \in ([0, a_1 - 1] \cap \mathbb{Z})^d \text{ such that } \right. \\ \left. \pi \text{ intersects at least } \frac{n}{4NK_1} \text{ black cubes from } \mathcal{S}_{a_1, \mathbf{u}} \right\} \geq 1 - \exp\left(-\frac{n}{2N}\right).$$

To prove Lemma C.1 we record a Bernoulli large deviation bound.

LEMMA C.2. *Assume (C.2) and let $p \in (0, 1)$ be the marginal probability of a black cube. Then there exist constants $A(p, K, \delta) > 0$ such that, for all integers $a_1 \geq a_0$, $m \in \mathbb{N}$, and $\delta \in (0, p/K_1)$, with $K_1 = a_1^d$, and for any particular sequence $S(\mathbf{k}_1), \dots, S(\mathbf{k}_m)$ of distinct N -cubes, the following estimate holds for some \mathbf{u} determined by $\{S(\mathbf{k}_i)\}_{i=1}^m$:*

$$\mathbb{P}\{S(\mathbf{k}_1), \dots, S(\mathbf{k}_m) \text{ contains at least } m\delta \text{ black cubes from } \mathcal{S}_{a_1, \mathbf{u}}\} \geq 1 - e^{-A(p, K_1, \delta)m}.$$

Furthermore, $\lim_{p \nearrow 1} A(p, K, \delta) = \infty$ for all $K \in \mathbb{N}$ and $\delta \in (0, p/K)$.

Proof. Pick \mathbf{u} so that $\mathcal{S}_{a_1, \mathbf{u}}$ contains at least $[m/K_1]$ of the cubes $S(\mathbf{k}_1), \dots, S(\mathbf{k}_m)$. Since these are colored independently and $\delta < p/K_1$, basic large deviations gives

$$\begin{aligned} & \mathbb{P}(\text{at most } m\delta \text{ cubes among } \{S(\mathbf{k}_i)\}_{i=1}^m \cap \mathcal{S}_{a_1, \mathbf{u}} \text{ are black}) \\ & \leq \mathbb{P}(\text{at most } m\delta \text{ cubes among } [m/K_1] \text{ independently colored cubes are black}) \\ & \leq \exp\left\{-\frac{m}{K_1} I_p(K_1\delta)\right\} = e^{-A(p, K_1, \delta)m} \end{aligned}$$

where the last equality defines A and the well-known Cramér rate function [16] of the Bernoulli(p) distribution is

$$I_p(s) = s \log \frac{s}{p} + (1-s) \log \frac{1-s}{1-p} \quad \text{for } s \in [0, 1].$$

To complete the proof, observe that

$$\lim_{p \nearrow 1} A(p, K, \delta) = \lim_{p \nearrow 1} \frac{1}{K} I_p(K\delta) = \lim_{p \nearrow 1} \left(\delta \log \frac{K\delta}{p} + \frac{1-K\delta}{K} \log \frac{1-K\delta}{1-p} \right) = \infty. \quad \square$$

Proof of Lemma C.1. Consider for the moment a fixed path π from 0 to a point y such that $|y|_1 = n$. Assume $n > dN$ so that $y \notin S(\mathbf{0})$.

For $j \in \mathbb{Z}_+$ let *level j* of N -cubes refer to the collection $\mathcal{L}_j = \{S(\mathbf{k}) : |\mathbf{k}|_1 = j\}$. Since points $x = (x_1, \dots, x_d) \in S(\mathbf{k})$ satisfy

$$k_i N \leq x_i \leq k_i N + N - 1 \quad \text{for } i \in [d],$$

level j cubes are subsets of $\{x : Nj - d(N-1) \leq |x|_1 \leq Nj + d(N-1)\}$.

To reach the point y , path π must have entered and exited at least one N -cube at levels $0, 1, \dots, m_0$ where m_0 satisfies

$$Nm_0 + d(N-1) < |y|_1 \leq N(m_0 + 1) + d(N-1).$$

This calculation excludes the cube that contains the endpoint y . From this

$$(C.4) \quad m_0 \geq \frac{|y|_1 - d(N-1)}{N} - 1 \geq \frac{n}{N} - (d+1).$$

Consider the sequence of N -cubes that path π intersects: $S(\mathbf{0}) = S(\mathbf{k}_0), S(\mathbf{k}_1), \dots, S(\mathbf{k}_{m_1})$, with the initial point $0 \in S(\mathbf{0}) = S(\mathbf{k}_0)$ and the final point $y \in S(\mathbf{k}_{m_1})$. Remove loops from this sequence (if any), for example by the following procedure:

- (1) Let i_0 be the minimal index such that $\mathbf{k}_{i_0} = \mathbf{k}_j$ for some $j > i_0$. Let j_0 be the maximal j for i_0 . Then remove $S(\mathbf{k}_{i_0+1}), \dots, S(\mathbf{k}_{j_0})$.
- (2) Repeat the same step on the remaining sequence $S(\mathbf{k}_0), \dots, S(\mathbf{k}_{i_0}), S(\mathbf{k}_{j_0+1}), \dots, S(\mathbf{k}_{m_1})$, as long as loops remain.

After loop removal relabel the sequence of remaining cubes consecutively to arrive at a new sequence $S(\mathbf{k}_0), S(\mathbf{k}_1), \dots, S(\mathbf{k}_{m_2})$ of distinct N -cubes with $m_2 \leq m_1$ and still $0 \in S(\mathbf{0}) = S(\mathbf{k}_0)$ and $y \in S(\mathbf{k}_{m_2})$. This sequence takes nearest-neighbor steps on the coarse-grained lattice of N -cubes, in the sense that $|\mathbf{k}_i - \mathbf{k}_{i-1}|_1 = 1$, because this property is preserved by the loop removal. Since π enters and leaves behind at least one N -cube on each level $0, \dots, m_0$, we have the bound $m_2 - 1 \geq m_0$.

We have now associated to each path π a sequence of m_0 distinct N -cubes that π both enters from the outside and exits again. We apply Lemma C.2 to these sequences of cubes.

Take $a_1 \geq a_0 \geq 1$ and $K_1 = a_1^d$ as in the statement of Lemma C.1. Let $\delta_0 = (2K_1)^{-1}$. Fix N large enough so that $p = p(N) > \frac{1}{2} = \delta_0 K_1$ and the constant given by Lemma C.1 satisfies

$$A(p, K_1, \delta_0) > \log 2d + 1.$$

Consider $n \geq 2(d+1)N$ to guarantee that the rightmost expression in (C.4) and thereby also m_0 is larger than $n/(2N)$. Then also $m_0 \delta_0 \geq n/(4NK_1)$. By Lemma C.2,

$$\begin{aligned} & \mathbb{P}\{\forall \text{ path } \pi : 0 \rightarrow \partial\mathbb{B}(0, n) \exists \mathbf{u} \text{ such that } \pi \text{ enters and exits} \\ & \quad \text{at least } \frac{n}{4NK_1} \text{ distinct black cubes from } \mathcal{S}_{a_1, \mathbf{u}}\} \\ & \geq \mathbb{P}\{\text{every nearest-neighbor sequence of } m_0 \text{ } N\text{-cubes starting at } S(\mathbf{0}) \\ & \quad \text{contains at least } m_0 \delta_0 \text{ black cubes from some } \mathcal{S}_{a_1, \mathbf{u}}\} \\ & \geq 1 - (2d)^{m_0} e^{-A(p, K_1, \delta_0)m_0} \geq 1 - e^{-m_0} \geq 1 - e^{-n/(2N)}. \end{aligned}$$

This completes the proof of Lemma C.1. □

Proof of Lemma 5.3. Surround each N -cube $S(\mathbf{k})$ with $2d$ N -boxes so that each $d-1$ dimensional face of $S(\mathbf{k})$ is directly opposite a large face of one of the N -boxes. Precisely, first put $S(\mathbf{k})$ at the center of the $3N$ -cube $T(\mathbf{k}) = N\mathbf{k} + [-N, 2N]^d$ on \mathbb{Z}^d , and then define $2d$ N -boxes $B^{\pm j}(\mathbf{k}) = T(\mathbf{k}) \cap T(\mathbf{k} \pm 2\mathbf{e}_j)$ for $j \in [d]$. Any lattice path that enters $S(\mathbf{k})$ and exits $T(\mathbf{k})$ must cross in the sense of (5.8) one of the N -boxes that surround $S(\mathbf{k})$.

Color $S(\mathbf{k})$ black if all $2d$ N -boxes surrounding it are black. The probability that $S(\mathbf{k})$ is black can be made arbitrarily close to 1 by choosing s_0 and N large enough and $\delta_0 > 0$ small enough in the definition (5.4)–(5.5) of a black N -box. The color of $S(\mathbf{k})$ depends only on the edge variables in the union $\overline{T}(\mathbf{k})$ of the $2d$ boxes $\overline{B}^{\pm j}(\mathbf{k})$ enlarged as in (5.2). The separation of a_0 in (C.2) can be fixed large enough to guarantee that over $\mathbf{k} \in \mathbf{u} + a_0\mathbb{Z}^d$ the cubes $\overline{T}(\mathbf{k})$ are pairwise disjoint.

Apply Lemma C.1 with $K_1 = a_1^d = a_0^d$. Tighten the requirement $n \geq 2(d+1)N$ of Lemma C.1 to $n \geq 4dN$ to guarantee that if a path π intersects $S(\mathbf{k})$ then it also intersects the complement of $T(\mathbf{k})$. (If π remains inside $T(\mathbf{k})$ then the ℓ^1 -distance between the endpoints of π is at most $3dN$ and π cannot connect the origin to $\partial\mathbb{B}(0, n)$.) Thus for every $S(\mathbf{k})$ intersected by π , at least one of the N -boxes surrounding $S(\mathbf{k})$ is crossed by π in the sense of (5.8). In conclusion, on the event in (C.3) each path from the origin to $\partial\mathbb{B}(0, n)$ crosses at least $\lceil n/(4NK_1) \rceil = \lceil na_0^{-d}/(4N) \rceil$ disjoint N -boxes. Of these, at least $\lceil na_0^{-d}/(4N) \rceil / K$ must come from some particular collection \mathcal{B}_j . Thus in Lemma 5.3 we can take $\delta_1 = 1/(4a_0^d NK)$, $n_1 = 4dN$ and $D_1 = 1/(2N)$. \square

APPENDIX D. CONVEX ANALYSIS

LEMMA D.1. *Let f be a proper convex function on \mathbb{R}^d ($-\infty < f \leq \infty$ and f is not identically ∞) and $\xi \in \text{ri}(\text{dom } f)$. Then the following statements are equivalent.*

- (a) *For some $b \in \mathbb{R}$, $\partial f(\xi) \subset \{h \in \mathbb{R}^d : h \cdot \xi = b\}$.*
- (b) *f^* is constant over $\partial f(\xi)$.*
- (c) *$t \mapsto f(t\xi)$ is differentiable at $t = 1$.*

Proof. (a) \implies (b). For all $h \in \partial f(\xi)$, $f^*(h) = h \cdot \xi - f(\xi) = b - f(\xi)$.

(b) \implies (a). Suppose $f^*(h) = s$ for all $h \in \partial f(\xi)$. Then for all $h \in \partial f(\xi)$, $h \cdot \xi = f^*(h) + f(\xi) = s + f(\xi)$.

(c) \implies (a). Let $b = (d/dt)f(t\xi)|_{t=1}$ and $h \in \partial f(\xi)$. Then for all $|s| \leq \varepsilon$, by convexity, $f(\xi + s\xi) - f(\xi) \geq sh \cdot \xi$. This says that $h \cdot \xi$ lies in the subdifferential of the function $t \mapsto f(t\xi)$ at $t = 1$, but by assumption this latter equals the singleton $\{b\}$.

(a) \implies (c). The directional derivatives satisfy the following, where in both equations the second equality comes from [17, Thm. 23.4].

$$f'(\xi; \xi) = \lim_{s \searrow 0} \frac{f(\xi + s\xi) - f(\xi)}{s} = \sup\{\xi \cdot h : h \in \partial f(\xi)\} = b$$

and

$$f'(\xi; -\xi) = \lim_{s \searrow 0} \frac{f(\xi - s\xi) - f(\xi)}{s} = \sup\{-\xi \cdot h : h \in \partial f(\xi)\} = -b.$$

From this we see the equality of the left and right derivatives of $\varphi(t) = f(t\xi)$ at $t = 1$:

$$\varphi'(t-) = \lim_{t \nearrow 0} \frac{f(\xi + t\xi) - f(\xi)}{t} = -f'(\xi; -\xi) = b$$

and

$$\varphi'(t+) = \lim_{t \searrow 0} \frac{f(\xi + t\xi) - f(\xi)}{t} = f'(\xi; \xi) = b. \quad \square$$

REFERENCES

- [1] Antonio Auffinger and Michael Damron. Differentiability at the edge of the percolation cone and related results in first-passage percolation. Probab. Theory Related Fields, 156(1-2):193–227, 2013.
- [2] Antonio Auffinger, Jack Hanson, and Michael Damron. 50 years of first passage percolation, volume 68 of University Lecture Series. American Mathematical Society, Providence, RI, 2017.
- [3] Erik Bates. Empirical distributions, geodesic lengths, and a variational formula in first-passage percolation. 2020. Preprint ([arXiv:2006.12580](https://arxiv.org/abs/2006.12580)).
- [4] Ivan Corwin. Kardar-Parisi-Zhang universality. Notices Amer. Math. Soc., 63(3):230–239, 2016.
- [5] J. Theodore Cox and Richard Durrett. Some limit theorems for percolation processes with necessary and sufficient conditions. Ann. Probab., 9(4):583–603, 1981.
- [6] Michael Damron, Firas Rassoul-Agha, and Timo Seppäläinen. Random growth models. Notices Amer. Math. Soc., 63(9):1004–1008, 2016.
- [7] Michael Damron and Pengfei Tang. Superlinearity of geodesic length in 2d critical first-passage percolation. In Sojourns in Probability Theory and Statistical Physics - II, pages 101–122. Springer Singapore, 2019.
- [8] Duncan Dauvergne, Janosch Ortmann, and Bálint Virág. The directed landscape. Acta Math., 2022. To appear ([arXiv 1812.00309](https://arxiv.org/abs/1812.00309)).
- [9] Duncan Dauvergne and Bálint Virág. The scaling limit of the longest increasing subsequence. 04 2021. Preprint ([arXiv 2104.08210](https://arxiv.org/abs/2104.08210)).
- [10] Richard Durrett and Thomas M. Liggett. The shape of the limit set in Richardson’s growth model. Ann. Probab., 9(2):186–193, 1981.
- [11] Geoffrey Grimmett and Harry Kesten. First-passage percolation, network flows and electrical resistances. Z. Wahrsch. Verw. Gebiete, 66(3):335–366, 1984.
- [12] John M. Hammersley and J. A. Dominic Welsh. First-passage percolation, subadditive processes, stochastic networks, and generalized renewal theory. In Proc. Internat. Res. Semin., Statist. Lab., Univ. California, Berkeley, Calif., pages 61–110. Springer-Verlag, New York, 1965.
- [13] Harry Kesten. On the time constant and path length of first-passage percolation. Adv. in Appl. Probab., 12(4):848–863, 1980.
- [14] Harry Kesten. Aspects of first passage percolation. In École d’été de probabilités de Saint-Flour, XIV—1984, volume 1180 of Lecture Notes in Math., pages 125–264. Springer, Berlin, 1986.
- [15] R. Marchand. Strict inequalities for the time constant in first passage percolation. Ann. Appl. Probab., 12(3):1001–1038, 2002.
- [16] Firas Rassoul-Agha and Timo Seppäläinen. A course on large deviations with an introduction to Gibbs measures, volume 162 of Graduate Studies in Mathematics. American Mathematical Society, Providence, RI, 2015.
- [17] R. Tyrrell Rockafellar. Convex analysis. Princeton Mathematical Series, No. 28. Princeton University Press, Princeton, N.J., 1970.
- [18] R. T. Smythe and John C. Wierman. First-passage percolation on the square lattice, volume 671 of Lecture Notes in Mathematics. Springer, Berlin, 1978.
- [19] J. Michael Steele and Yu Zhang. Nondifferentiability of the time constants of first-passage percolation. Ann. Probab., 31(2):1028–1051, 2003.
- [20] J. van den Berg and H. Kesten. Inequalities for the time constant in first-passage percolation. Ann. Appl. Probab., 3(1):56–80, 1993.
- [21] Yu Zhang. Supercritical behaviors in first-passage percolation. Stochastic Process. Appl., 59(2):251–266, 1995.

ARJUN KRISHNAN, UNIVERSITY OF ROCHESTER, MATHEMATICS DEPARTMENT, HYLAN 817, ROCHESTER, NY 14627, USA.

Email address: arjun@shirleyarjun.net

URL: <https://people.math.rochester.edu/faculty/akrish11/>

FIRAS RASSOUL-AGHA, UNIVERSITY OF UTAH, MATHEMATICS DEPARTMENT, 155S 1400E, SALT LAKE CITY, UT 84112, USA.

Email address: firas@math.utah.edu

URL: <https://www.math.utah.edu/~firas>

TIMO SEPPÄLÄINEN, UNIVERSITY OF WISCONSIN-MADISON, MATHEMATICS DEPARTMENT, VAN VLECK HALL, 480 LINCOLN DR., MADISON WI 53706-1388, USA.

Email address: seppalai@math.wisc.edu

URL: <https://people.math.wisc.edu/~seppalai/>