

Deep learning via LSTM models for COVID-19 infection forecasting in India

Rohitash Chandra^a, Ayush Jain^b, Divyanshu Singh Chauhan^c

^a*School of Mathematics and Statistics, UNSW Sydney, NSW 2006, Australia*

^b*Department of Electronics and Electrical, Indian Institute of Technology Guwahati, Assam, India*

^c*Department of Mechanical, Indian Institute of Technology Guwahati, Assam, India*

Abstract

We have entered an era of a pandemic that has shaken the world with major impact to medical systems, economics and agriculture. Prominent computational and mathematical models have been unreliable due to the complexity of the spread of infections. Moreover, lack of data collection and reporting makes any such modelling attempts unreliable. Hence we need to re-look at the situation with the latest data sources and most comprehensive forecasting models. Deep learning models such as recurrent neural networks are well suited for modelling spatio-temporal sequences. In this paper, prominent recurrent neural networks, in particular *long short term memory* (LSTMs) networks, bidirectional LSTM, and encoder-decoder LSTM models for multi-step (short-term) forecasting the spread of COVID-infections among selected states in India. We select states with COVID-19 hotspots in terms of the rate of infections and compare with states where infections have been contained or reached their peak and provide two months ahead forecast that shows that cases will slowly decline. Our results show that long-term forecasts are promising which motivates the application of the method in other countries or areas. We note that although we made some progress in forecasting, the challenges in modelling remain due to data and difficulty in capturing factors such as population density, logistics, and social aspects such culture and lifestyle.

Keywords: Recurrent neural networks, LSTM, COVID-19, India, forecasting

1. Introduction

The *coronavirus disease 2019* (COVID-19) is an infectious disease caused by *severe acute respiratory syndrome coronavirus 2* (SARS-CoV-2) [1, 2, 3] which became a global pandemic [4]. COVID-19 was first identified in December 2019 in Wuhan, Hubei, China with the first confirmed or index case was traced back to 17th November 2019 [5]. Currently (1st December, 2020) ¹, more than 18 million cases have been reported across the world which resulted in more than 1.6 million deaths [6, 7]. The COVID-19 pandemic forced many countries to close their borders and enforce a partial or full lock down which had a devastating impact on the world economy which will continue in years to follow [8, 9, 10]. Other major impact has been on agriculture [11, 12] which is a major source of income for population in rural areas, especially in the developing world. The sudden lock-down in some countries created huge wave of problems in terms of transportation, especially for low income migrant communities [13, 14], even within a country such as state-wise migrant workers such as those in India [15].

The case of India has been unique when it comes to management of COVID-19 pandemic [15]. The first COVID-19 case in India was reported on 30 January 2020. India entered a lock-down quite earlier and has managed well in terms of number of deaths and infections per million population. India currently (1st December, 2020) has 9,462,809 confirmed cases

with 137,621 (1.45 %) deaths which makes the largest in Asia the second highest in the world after the United States. The fatality rate of COVID-19 in India is among the lowest in the world % and steadily declining. India also has one of the fastest recovery rates in the world with 429,753 (4.54 %) active cases, and ranks 8th in the world although 2nd in total cases ².

In terms of COVID-19 forecasting, prominent computational and statistical models have been unreliable due to the complexity of the spread of infections [16, 17, 18], since they did not take into account active or novel cases without that depend on population density, logistics and travel, and qualitative social aspects such culture and lifestyle [19]. While some of these aspects can be broken down to get quantitative measurement that can help models for forecasting, other have qualitative nature and lack of data collection and reporting makes any such modelling attempts unreliable. Hence we need to re-look at the situation with latest data sources and most comprehensive forecasting models [20, 21, 22]. Moreover, a number of other limitations exists, such as noisy or unreliable data of active cases [23], mortality rate, and asymptotic carriers [24, 25]. There have been reports that the models lack a number of limitations and failed in several situations [26]. Despite these challenges, it has been shown that country based mitigation factors in terms of different levels of lock downs and monitoring has a major impact on the rate of infection [27]. We note that none of the

Email address: rohitash.chandra@unsw.edu.au (Rohitash Chandra)

¹<https://www.worldometers.info/coronavirus/>

²<https://www.worldometers.info/coronavirus/country/india/>

forecasting models have considered COVID-19 forecasting in India. There is a need to evaluate latest deep learning models for forecasting COVID-19 in India.

Deep learning models such as recurrent neural networks (RNNs) are well suited for modelling spatio-temporal sequences [28, 29, 30, 31, 32]. RNNs are also suitable for modeling dynamical systems when compared to feedforward networks [33, 34, 35]. The limitations in learning by RNNs for long-term dependencies in sequences that span hundreds or thousands of time-steps [36] were addressed by *long short-term memory* networks (LSTMs) [30]. LSTMs have been used for COVID-19 forecasting in China [37] with good performance results when compared to epidemic models. LSTMs have also been used for COVID-19 forecasting in Canada [38]. Other deep learning models such as convolutional neural networks (CNNs) have recently shown promising performance for time series forecasting [39, 40]. They would also be suited in capturing spatio-temporal relationship of COVID-19 transmission with neighbouring states in India.

In this paper, we employ three LSTM models for short-term forecasting the spread of COVID-infections among selected states in India. We select Indian states with COVID-19 hotspots in terms of the rate of infections and compare with states where infections have been contained or reached their peak. We provide both univariate and multivariate time series prediction approaches and compare their performance for short-term (4 days ahead) forecasting, with a two months ahead forecast using selected LSTM models. We present visualisation and analysis of the COVID-19 infections and provide open source software that can be used as more data gets available and also applied to different countries and regions.

The rest of the paper is organised as follows. Section 2 presents a background and literature review of related work. Section 3 presents the proposed methodology with data analysis and Section 4 presents experiments and results. Section 5 provides a discussion and Section 6 concludes the paper with discussion of future work.

2. Related Work

COVID-19 lock down, infection and management has also raised concerns about prejudices against minorities and people of colour in developed countries such as the United States [41]. Furthermore there has been a significant impact on mental health across the globe [42, 43]. COVID-19 forced lock downs and restrictions of movement has given rise to e-learning [44, 45, 46] and telemedicine [47], and created opportunities in applications for geographical information systems [48]. The lock-down showed positive impact on the environment [49, 50], especially for highly populated and industrial nations with high air pollution rate [51]; however the way medical pollutants and domestic waste are discarded during lock downs also of concern [52]. Moreover, Zambrano-Monserrate et. al highlighted the positive indirect effects revolve around the reduction air pollutants in China, France, Germany, Spain, and Italy [52].

It has been shown that in some countries, comprehensive identification and isolation policies have effectively suppressed

the spread of COVID-19. Huang et. al [53] presented an evaluation of identification and isolation policies that effectively suppressed the spread of COVID-19 which further contributed to reduce casualties during the phase of a dramatic increase in diagnosed cases in Wuhan, China. The authors recommended that governments should swiftly execute the forceful public health interventions in the initial stage of the pandemic. However, such policies have not been that effective for other countries with similar population, such as India, but still have been better than spread of COVID-19 in USA and Brazil [20].

2.1. Modelling and forecasting COVID-19

A number of machine learning and statistical models have been used for modelling and forecasting COVID-19 in different parts of the world. Saba and Elsheikh presented simple autoregressive neural networks for forecasting the prevalence of COVID-19 outbreak in Egypt which showed relatively good performance when compared to officially reported cases [18]. Yousaf et. al used *auto-regressive integrated moving average* (ARIMA) model for forecasting COVID-19 for Pakistan [17]. The model predicted that the number of confirmed cases would increase by factor of 2.7 giving 95 % prediction interval by the end of May 2020, to 5681 - 33079 cases. However, Pakistan reported around 70,000 cases³ end of May and hence the model was poor in prediction. Velásquez and Lara used Gaussian process regression model for forecasting COVID-19 infection in the United States [16]. The authors show that COVID-19 would peak in United States around July 14th 2020, with a peak number of 132,074 death with infected individuals of about 1,157,796. However, the actual cases by July 14th reached more than 3.5 million with more than 139 thousand deaths⁴ which shows that the model was close in forecasting deaths but forecast of total cases was poor.

Chimmula and Zhand used LSTM neural networks for time series forecasting of COVID-19 transmission in Canada [38]. The authors predicted the possible ending point of the outbreak around June 2020 and compared transmission rates of Canada with Italy and the United States. Canada reached the daily new cases peak by 2nd May⁵ and since then new cases has been drastically reducing. Therefore we can say that the approach by the authors was somewhat close in reporting the peak for COVID-19 in Canada. Chakraborty and Ghosh [21] used hybrid ARIMA and wavelet-based forecasting model for short-term (ten days ahead) forecasts of daily confirmed cases for Canada, France, India, South Korea, and the United Kingdom. The authors also applied an optimal regression tree algorithm to find essential causal variables that significantly affect the case fatality rates for different countries. Maleki et. al [22] used autoregressive time series models based on two-piece scale mixture normal distributions time series data of confirmed and recovered COVID-19 cases worldwide.

³<https://www.worldometers.info/coronavirus/country/pakistan/>

⁴<https://www.worldometers.info/coronavirus/country/us/>

⁵<https://www.worldometers.info/coronavirus/country/canada/>

Ren et al [19] analysed spatiotemporal variations of the epidemics before utilizing the ecological niche models with nine socioeconomic variables for identifying the potential risk zones for megacities such as Beijing, Guangzhou and Shenzhen. The results demonstrate that the method was capable of being employed as an early forecasting tool for identifying the potential COVID-19 infection risk zones. Alzahrani et al [54] used auto-regressive and ARIMA models for COVID-19 in Saudi Arabia with data till 20th April 2020 and predicted 7668 daily new cases by 21st May 2020 given stringent precautionary control measures not implemented. However, actual data of 21st May 2020 shows 2532 cases⁶, hence, the model has shown poor performance. Singh et al [55] presented a hybrid of discrete wavelet decomposition and ARIMA models in application to one month forecast the casualties cases of COVID-19 in most affected countries back then which included France, Italy, Spain, United Kingdom and United States. The authors found that the hybrid model is better than standalone ones. Dasilva et. al [20] employed machine learning methods such as Bayesian regression neural network, cubist regression, k-nearest neighbors, quantile random forest, and support vector regression with pre-processing based on variational mode decomposition for forecasting one, three, and six-days-ahead the cumulative COVID-19 cases in five Brazilian and American states up to April 28th, 2020. Yang et al [37] epidemiological model that incorporated the domestic migration data and most recent COVID-19 epidemiological data to predict the epidemic progression. The authors also used LSTM neural network model where they reported peak by late February, showing gradual decline by end of April. This was one of the few successful attempts in useful prediction of COVID-19 given the trend in China⁷; however, the actual peak was in early February and the spread of infections ended by middle of March.

In terms of COVID-19 forecasting in India with deep learning methods, some of the key investigations are highlighted as follows. Anand et al. [56] focused on forecasting of COVID-19 cases in India using recurrent neural networks such as LSTM and gated-recurrent units (GRU) with the dataset from 30th January 2020 to 21st July 2020. Bhimala et al. [57] incorporated the weather conditions of different states to make more accurate forecasting of the COVID-19 cases in different states of India. The authors made assumption that different humidity levels in different states will lead to varying transmission of infection within the population. They demonstrated that LSTM model performed better in the medium and long range forecasting scale when integrated with the weather data. Shetty [58] presented a real time forecasting based model using a feed forward neural network model for the COVID-19 cases in Karnataka in India where parameter selection for the model was based on Cuckoo search algorithm. The mean-absolute percentage error (MAPE) was reduced from 20.73 % to 7.03 %. The proposed model was further tested on the Hungary COVID-19 dataset

⁶<https://www.worldometers.info/coronavirus/country/saudi-arabia/>

⁷<https://www.worldometers.info/coronavirus/country/china/>

and produced promising results. Tomar and Gupta [59] developed LSTM model for 30-day ahead prediction of COVID-19 positive cases in India where they also studied the effect of preventive measures on the spread of COVID-19. They showed that with preventive measures and lower transmission rate, the spread can be reduced significantly.

Moving to other parts of the world, we see a number of machine learning methods used in conjunction with deep learning for COVID-19 forecasting. Battineni et al. [60] forecasted COVID-19 cases using a machine learning method known as prophet logistic growth model which estimated that by late September 2020, the outbreak can reach 7.56, 4.65, 3.01 and 1.22 million cases in the USA, Brazil, India and Russia, respectively. Nadler et al. [61] used a model embedded in a Bayesian framework coupled with a LSTM network to forecast cases of COVID-19 in developed and developing countries.

Silva et al. [62] analyzed and forecasted the cumulative COVID-19 cases in four selected cities of Brazil using stacked ensemble forecasting model. Gupta et al. [63] forecasted COVID-19 cases of India using support vector machines, prophet, and linear regression models. Similarly, Bodapati et al. [64] forecasted the COVID-19 daily cases, deaths caused and recovered cases with the help of LSTM networks for whole world. Chaurasia and Pal [65] used several forecasting models such as simple average, single exponential smoothing, Holt winter method, auto-regressive integrated moving average (ARIMA) models for time series analysis of COVID-19 pandemic. Istaiteh et al. [66] compared the performance of ARIMA, LSTM, multi-layer perceptron and convolutional neural network (CNN) models for prediction of COVID-19 cases all over the world. They reported that deep learning models outperformed ARIMA model, and furthermore CNN outperformed LSTM networks and multi-layer perceptron. Pinter et al. [67] used hybrid machine learning methods of adaptive network-based fuzzy inference systems (ANFIS) and multilayer perceptron for COVID-19 infections and mortality rate in Hungary.

3. Methodology: Forecasting with deep learning models

We need to reconstruct the original time series for multi-step-ahead prediction using deep learning methods. Taken's theorem expresses that the reconstruction can reproduce important features of the original time series [68]. Hence, an embedded phase space $Y(t) = [(x(t), x(t - T), \dots, x(t - (D - 1)T)]$ can be generated given an observed time series $x(t)$; where T is the time delay, D is the embedding dimension (window span) $t = 0, 1, 2, \dots, N - DT - 1$, and N is the length of the original time series. The values for D and T are user defined and typically experimentally determined in order to efficiently apply Taken's theorem [69]. Taken's proved that if the original attractor is of dimension d , then $D = 2d + 1$ would be sufficient [68].

3.1. LSTM network models

Simple recurrent neural networks (RNN) feature a context layer to act as memory in order to incorporate current state and

inputs for propagating information into future states, and eventually output. Although number of different simple RNN architectures exist, the Elman RNN [28, 70] is one of the earliest which has been prominent for modelling temporal sequences and dynamical systems [71, 34, 72].

We note that backpropagation through time (BPTT) is an extension of the backpropagation algorithm has been a prominent method for training simple RNNs [29]. BPTT features gradient descent where the error is backpropagated for a deeper network architecture that features states defined by time as opposed to multilayer perceptron that feature one or few hidden layers only. Initially, training RNNs with BPTT was very challenging due to problem of learning long-term dependencies given vanishing and exploding gradients [73]. LSTM networks were developed [30] to address vanishing gradient problem of simple RNNs. LSTMs provided better capabilities in remembering the long-term dependencies using memory cells and gates.

LSTMs employ using memory cells and gates for much better capabilities in remembering the long-term dependencies in temporal sequences as shown in Figure 1

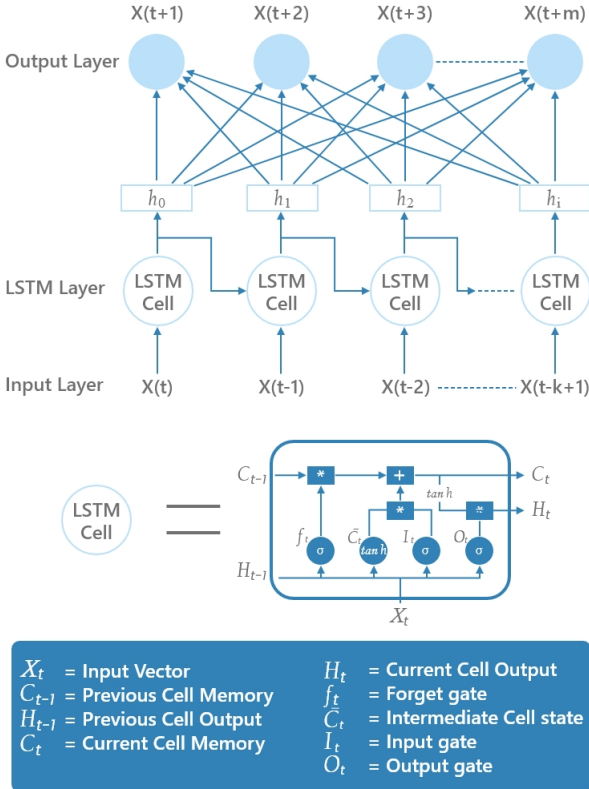

Figure 1: Long Short-Term Memory (LSTM) neural networks

The LSTM network model calculates a hidden state h_t as

$$\begin{aligned}
 i_t &= \sigma(x_t U^i + h_{t-1} W^i) \\
 f_t &= \sigma(x_t U^f + h_{t-1} W^f) \\
 o_t &= \sigma(x_t U^o + h_{t-1} W^o) \\
 \tilde{C}_t &= \tanh(x_t U^s + h_{t-1} W^s) \\
 C_t &= \sigma(f_t * C_{t-1} + i_t * \tilde{C}_t) \\
 h_t &= \tanh(C_t) * o_t
 \end{aligned} \tag{1}$$

where, i_t , f_t and o_t refer to the input, forget and output gates, at time t , respectively. x_t and h_t refer to the number of input features and number of hidden units, respectively. W and U is the weight matrices adjusted during learning along with b which is the bias. The initial values are $c_0 = 0$ and $h_0 = 0$. Note that all the gates have the same dimensions d_h , the size of your hidden state. \tilde{C}_t is a ‘‘candidate’’ hidden state, and C_t is the internal memory of the unit as shown in Figure 1. Note that we denote $(*)$ as element-wise multiplication.

3.2. Bi-directional LSTM networks

Conventional RNNs (including LSTMs) only make use of previous context state for determining future states. Bidirectional RNNs (BD-RNNs) [74] on the other hand, process information in both directions with two separate hidden layers which are then propagated forward to the same output layer. Hence, two independent RNNs are placed together to allow both backward and forward information about the sequence at every time step. The forward hidden sequence h_f , the backward hidden sequence h_b , and the output sequence y are computed in BD-RNN by iterating the backward layer from $t = T$ to $t = 1$, the forward layer from $t = 1$ to $t = T$.

Bi-directional LSTM networks (BD-LSTM) [75] can access longer-range context or state in both directions similar to BD-RNNs. BD-LSTM networks were originally proposed for world-embedding in natural language processing[75] and have been used in several real-world sequence processing problems such as phoneme classification [75], continuous speech recognition [76] and speech synthesis [77].

BD-LSTM networks intake inputs in two ways; one from past to future, and another from future to past by running information backwards so that state information from the future is preserved. Given two hidden states combined in any point in time, the network can preserve information from both past and future as shown in Figure 2.

3.3. Encoder-Decoder LSTM networks

The encoder-decoder LSTM network (ED-LSTM) [78] was introduced as a sequence to sequence model for mapping a fixed-length input to a fixed-length output. The length of the input and output may differ which makes them applicable in automatic language translation tasks (English to French for example) which can be extended to multi-step series prediction where both the input and outputs are of variable lengths. A latent vector representation is used to handle variable-length input and outputs by first encoding the input sequences, one at a time

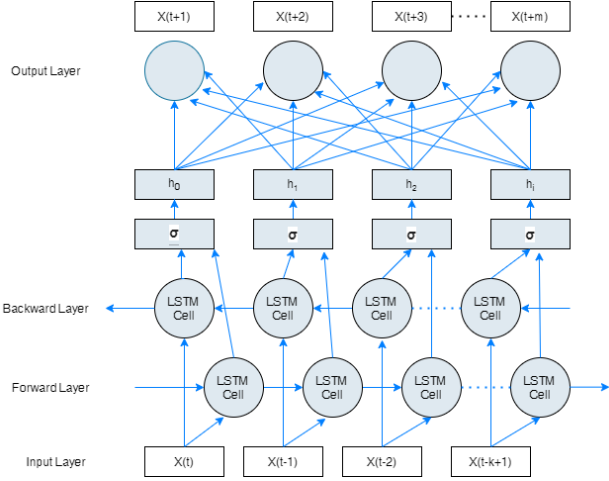

Figure 2: Bi-directional LSTM

and then decoding from that representation. We consider the input sequence (x_1, \dots, x_n) with corresponding output sequence (y_1, \dots, y_m) , and estimate the conditional probability of the output sequence given an input sequence, i.e. $p(y_1, \dots, y_m | x_1, \dots, x_n)$. In the encoding phase, given an input sequence, the ED-LSTM network computes a sequence of hidden states. In decoding phase, it defines a distribution over the output sequence given the input sequence as shown in Figure 3.

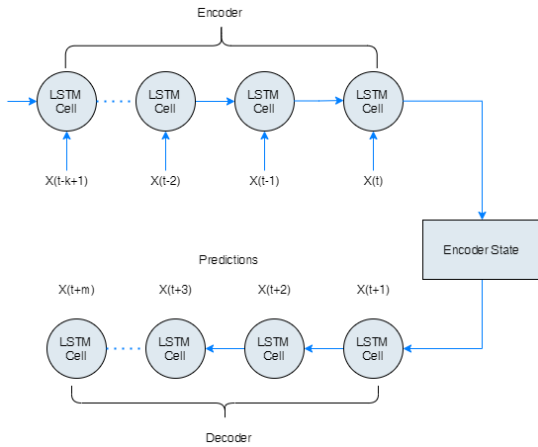

Figure 3: Encoder-Decoder LSTM

4. India: Situation Report: 1st December, 2020

We provide a visual representation of the total number of COVID-19 infections for different states and union territories in India.

Tables 1 and 2 provide a rank of top ten Indian states with total cases 1st of every month. We see that largely populated states such as Maharashtra (estimate population of 123 million [79]) has been leading India in number of total cases throughout the year. We note that state of Uttar Pradesh has estimate

population of 238 million seems to have managed better (no. 6 in August and no. 5 in September). Delhi has relatively a smaller population (estimated 19 million [79]), but high population density and has been one of the leading states with COVID-19 (in top 6 throughout the year).

Figure 4 presents the total number of new weekly cases for different groups of Indian states and union territories. We notice that the number of cases significantly increased after May 2020 and certain number of states had most number of new weekly cases as shown in Figure 4. Moreover, Figure 4 (Panel a) show that Delhi reached a major peak in weekly new cases in 3rd week of June and Tamil Nadu began slowing down in increase of new weekly cases around then, however Maharashtra continued increasing in terms of new cases. Maharashtra began slowing down towards end of July. In Panel (b), we find that new cases in West Bengal drastically increasing from 30th June and somewhat reaching a plateau post 25th August. Similar to West Bengal, the new cases in Bihar increased drastically from 30th June and slowly reached peak by 22nd September and declined afterwards.

Figure 5 presents daily active cases and cumulative (total) deaths for key Indian states which remains in top 10 states with most number of cases, as shown in Table 1 and Table 2. We notice that the active cases began declining in most states post 1st October, except for Delhi and Karnataka. Delhi has 3 major peaks of active cases and the third peak began declining post mid-November while Karnataka reached a plateau and began declining mid-October in terms of active cases. In terms of deaths, we do not see a sharp increase post October in most of states, except for Delhi which can be explained by multiple peaks and high number of active cases post October when compared to rest of the states. Note that we chose not to show daily deaths in the same graphs since the scales between active cases and deaths are quite different.

Figure 6 shows a comparison of India with other countries (USA, France, Brazil, Russian, and Spain) which are considered to have major active cases for COVID-19. We notice that India has a steady decline in active cases from October without a major rise in cumulative deaths whereas Spain, Russia, US, and France have steady increase in active cases. Brazil seems to have reached a plateau in active cases from July to September with major spike in active cases from mid-October with gradual increase in cumulative deaths.

5. Results

In this section, we present results of prediction of COVID-19 daily cases in India using prominent LSTM neural network models that includes, BD-LSTM and ED-LSTM with architectural details given in methodology (Section 3).

5.1. Experimental Design

Our experiments consider the prediction task independently by taking both univariate and multivariate approach. We provide a general overview of our investigations by taking the following steps.

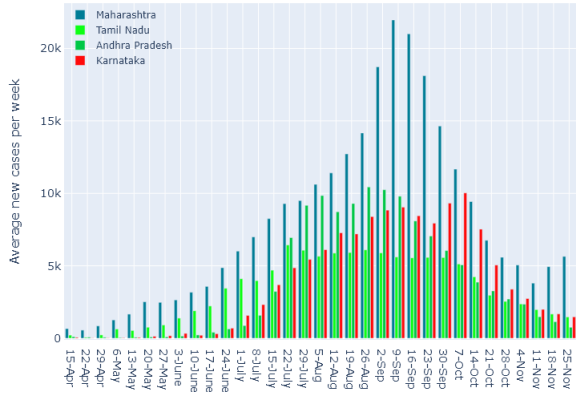

(a) Major affected states

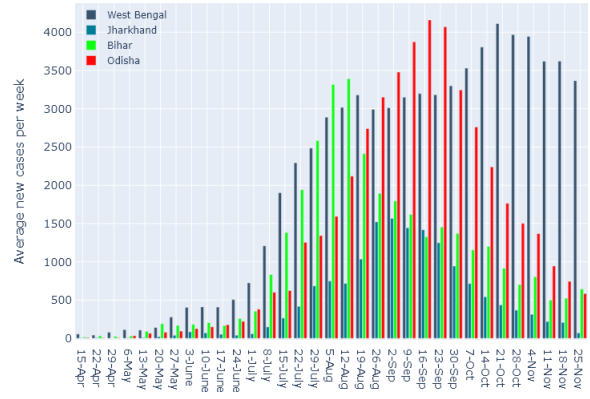

(b) Eastern states

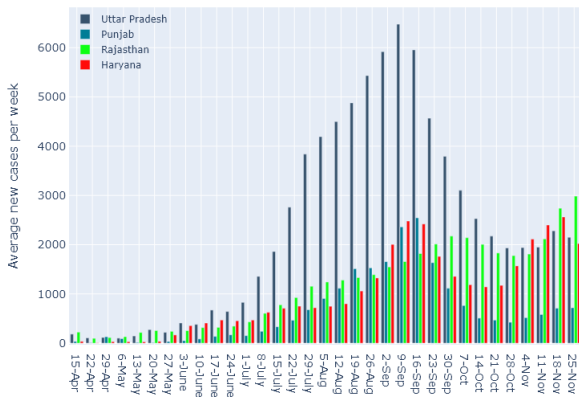

(c) Northern states

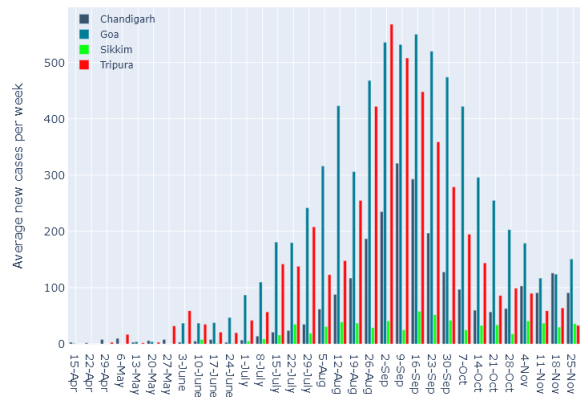

(d) Small states

Figure 4: Weekly average of new cases for groups of Indian states and union territories.

Rank	April	May	June	July	August
1	Maharashtra (302)	Maharashtra (10498)	Maharashtra (67655)	Maharashtra (174761)	Maharashtra (422118)
2	Kerala (241)	Gujarat (4395)	Tamil Nadu (22333)	Tamil Nadu (90167)	Tamil Nadu (245859)
3	Tamil Nadu (234)	Delhi (3515)	Delhi (19844)	Delhi (87360)	Andhra Pradesh (140933)
4	Delhi (152)	Madhya Pradesh (2719)	Gujarat (16779)	Gujarat (32557)	Delhi (135598)
5	Uttar Pradesh (103)	Rajasthan (2584)	Rajasthan (8831)	Uttar Pradesh (23492)	Karnataka (124115)
6	Karnataka (101)	Tamil Nadu (2323)	Madhya Pradesh (8089)	West Bengal (18559)	Uttar Pradesh (85461)
7	Telangana (96)	Uttar Pradesh (2281)	Uttar Pradesh (7823)	Rajasthan (18014)	West Bengal (70188)
8	Rajasthan (93)	Andhra Pradesh (1463)	West Bengal (5501)	Telangana (16339)	Telangana (62703)
9	Andhra Pradesh (83)	Telangana (1039)	Bihar (3815)	Karnataka (15242)	Gujarat (61438)
10	Gujarat (82)	West Bengal (795)	Andhra Pradesh (3679)	Andhra Pradesh (14595)	Bihar (51233)

Table 1: Rank of states by number of total cases in brackets (April to August 2020)

Rank	September	October	November	December
1	Maharashtra (792541)	Maharashtra (1384446)	Maharashtra (1678406)	Maharashtra (1823896)
2	Andhra Pradesh (434771)	Andhra Pradesh (693484)	Karnataka (823412)	Karnataka (884897)
3	Tamil Nadu (428041)	Karnataka (601767)	Andhra Pradesh (823348)	Andhra Pradesh (868064)
4	Karnataka (342423)	Tamil Nadu (597602)	Tamil Nadu (724522)	Tamil Nadu (781915)
5	Uttar Pradesh (230414)	Uttar Pradesh (399082)	Uttar Pradesh (481863)	Kerala (602982)
6	Delhi (174748)	Delhi (279715)	Kerala (43310)	Delhi (570374)
7	West Bengal (162778)	West Bengal (257049)	Delhi (386706)	Uttar Pradesh (543888)
8	Bihar (136457)	Odisha (219119)	West Bengal (373664)	West Bengal (483484)
9	Telangana (127697)	Kerala (196106)	Odisha (290116)	Odisha (318725)
10	Assam (109040)	Telangana (193600)	Telangana (240048)	Telangana (270318)

Table 2: Rank of states by number of total cases in brackets (September to December 2020)

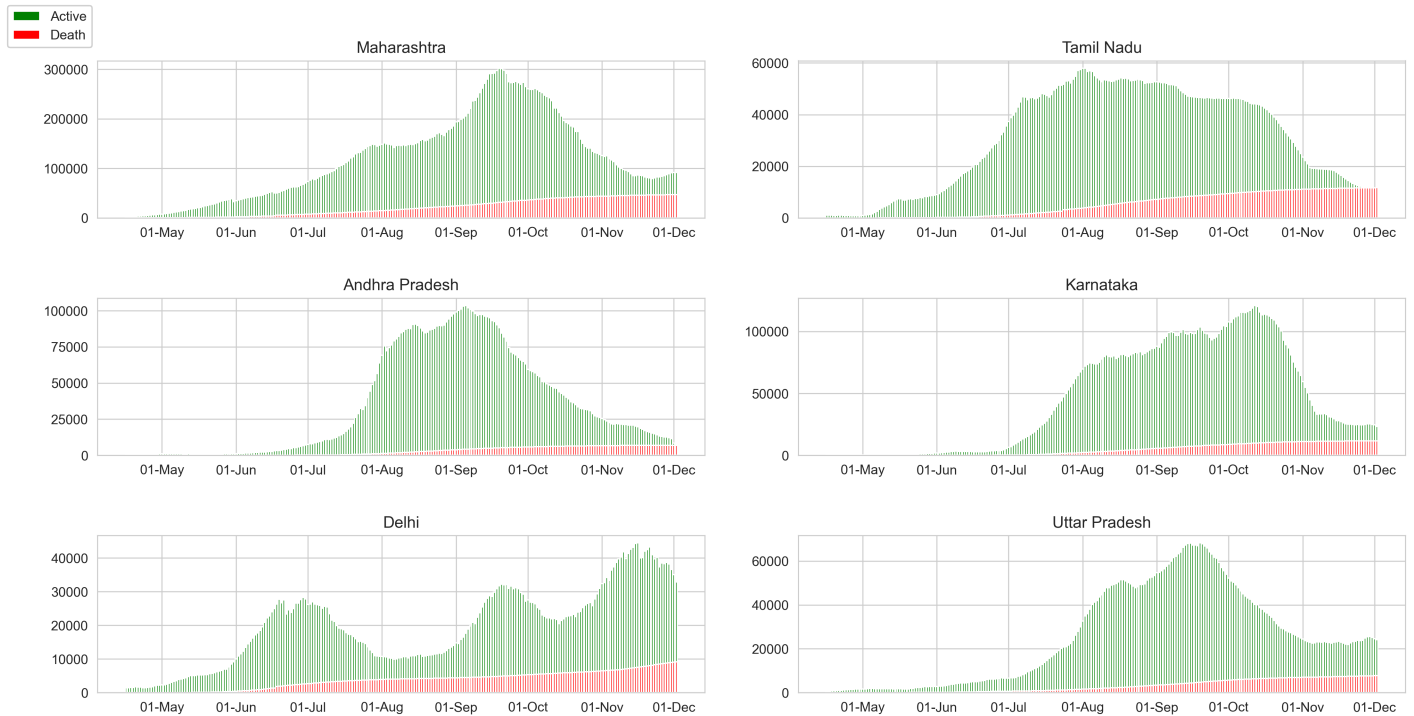

Figure 5: Daily active cases and cumulative death in key states of India.



Active Cases and Deaths in Hotspot Countries



Figure 6: Daily active cases and cumulative death in hot-spot countries.

- Evaluate what is best way to split training and testing datasets using two methods as follows. We use static split of training samples from beginning of COVID-19 until 30th September 2020, and then use the remaining for test dataset. In random split, we use data where the train and test set are created by randomly shuffling the dataset.
- Evaluate if univariate or multivariate approach of prediction provides better results.
- Show results for entire case of India, and then two leading states for COVID-19 infections, i.e. Maharashtra and Delhi.
- Evaluate the accuracy of the three models, (LSTM, BD-LSTM, ED-LSTM)
- Using best LSTM models, provide a two month outlook for new daily cases by feeding back predictions into the trained models.

The data used in the entire analysis is taken from Indian Institute of Statistical Science, Bangalore [80]. They have compiled the data from Ministry of Health and Family Welfare Government of India website [81].

The univariate and multivariate time series were pre-processed into a state-space vector using Taken's theorem [68] with embedding dimension window ($D = 5$) and time-lag ($T = 2$) for multi-step ahead prediction. Note that each problem (given by dataset) featured $MSA = 4$ and $MSA = 10$. The data

has been averaged with a rolling mean of 3 days. To remove outliers, we started our analysis from 15th April. The entire dataset is based on new cases per day which is normalised taking the maximum number of daily cases into account.

Adam optimizer was used for training the respective LSTM models with mean squared error (MSE) loss function. Table 3 and Table 4 describe the topology for the respective LSTM models for univariate and multivariate cases, respectively. In case of univariate model, the input contains one feature window size of six time steps backwards that is used to predict four steps ahead. In case of multivariate model, the input contain four features which represents the adjacent states in relation to the state taken into account; i.e. in the case of Maharashtra (Maharashtra, Gujarat, Madhya Pradesh, Uttar Pradesh) and in the case of Delhi (Delhi, Rajasthan, Uttar Pradesh, Haryana). In multivariate model of India, all the states are taken as features. We note that similar to univariate model, the multivariate model considers data from steps backwards (window) for four step-ahead prediction. We note that we use two hidden layers in the LSTM univariate models (hidden layer 1 and 2) and one hidden layer for LSTM multivariate models based on trial experiment runs. In multivariate case, we do not have additional hidden layers. In case of random shuffling, the training dataset had 165 instances, whereas test dataset had 55 instances. In case of static split, the training dataset had 158 samples whereas test dataset had 53 instances. The processed datasets and open source code for the respective models have been provided online ⁸.

⁸<https://github.com/sydney-machine-learning/>

Method	Input	Hidden layer 1	Hidden layer 2	Output
LSTM	(6,1)	32	32	(1,4)
BD-LSTM	(6,1)	32	16	(1,4)
ED-LSTM	(6,1)	32	-	(1,4)

Table 3: Respective LSTM model topologies for univariate case.

Method	Input	Hidden-layer	Output
LSTM	(6,4)	32	(1,4)
BD-LSTM	(6,4)	32	(1,4)
ED-LSTM	(6,4)	32	(1,4)

Table 4: Respective LSTM model topologies for Multivariate case.

We review the performance of the respective methods in terms of scalability and robustness which refers to the ability to maintain consistent prediction performance as the prediction horizon increases. The RMSE in Equation 2 is used as the main performance measure for prediction accuracy

$$RMSE = \sqrt{\frac{1}{N} \sum_{i=1}^N (y_i - \hat{y}_i)^2} \quad (2)$$

where y_i, \hat{y}_i are the observed data, predicted data, respectively. N is the length of the observed data. We use RMSE for each prediction horizon and for each problem, we report the mean error for the respective prediction horizons (time-steps ahead).

In all experiments, we present the mean and 95 % confidence interval for 30 experiment runs where the respective LSTM models are initialised with different set of initial weights, but from uniform distribution in same range [-0.5, 0.5]. We are using dropout rate of 0.2 for all LSTM models in the respective experiments.

5.2. Prediction performance

Figure 7 shows univariate LSTM, BD-LSTM and ED-LSTM models with a static split of train/test dataset. Figure 8 shows univariate random splitting of train/test datasets using the same models. We observe that the prediction for India cases has a unique trend where the model was improving with increase in the prediction horizon (steps) when compared to Maharashtra and Delhi cases (Panels d and f). The corresponding cases in random-split case shows a different trend and better accuracy with lower RMSE (Panels b and f) for India and Delhi cases, with exception of Maharashtra (Panel d) of Figure 8.

Figure 9 shows results for the multivariate approach, where the same methods used in univariate case was used (LSTM, ED-LSTM, BD-LSTM). We find that ED-LSTM model gives best performance for India and Maharashtra cases in test dataset, but deteriorates in the Delhi case. Figure 10 shows results for the case of random shuffling of train/test dataset using the respective methods.

Table 5 and Table 6 provide a summary from Figures 7, 8, 9 and 10 of test performance by the respective models for random and static split. We notice that LSTM model has generally performed much better than ED-LSTM and BD-LSTM for most of the cases. There are some outliers, where ED-LSTM showed better results for univariate case of India in Table 5. In multivariate cases, we find that BD-LSTM does best for case of Maharashtra and Delhi in Table 6 whereas, LSTM has given the best results in most of the cases. One of the issues of ED-LSTM and BD-LSTM is over-training. Moreover, when we compare random split to shuffle split, for univariate and multivariate models, we see that in case of India and Maharashtra, static split gives better performance than random split. In case of Delhi, we see that random split gives better results than static split. We note that as shown in previous analysis (Figures 5 and 6), the trend of India and Maharashtra is similar with a major peak of cases while Delhi has a different trend where there are three peaks. This is the major reason why India and Maharashtra has static split with better performance. It is difficult to rule out which type of model (univariate vs multivariate) is better for the different datasets. Looking at static and random split, in some cases the multivariate model improves while in some cases, it deteriorates the performance.

Next, we select two univariate LSTM models for the three datasets to provide a two months outlook for COVID-19 in India using random split. We note that the predictions are for December 2020, and January 2021 using LSTM models trained on 75% data from 15 April up to 1st December, which was splitted randomly. Figure 11 presents results for univariate LSTM and BD-LSTM models predicting next 60 days where the 4 steps-ahead predictions are used as feedback to the respective LSTM models. The uncertainty of prediction is shown for 30 experiment runs with different weight initialisation in the LSTM models which is shown as the shaded green region representing the 95th and 5th percentile and mean prediction is shown as solid line. We notice that in all cases, there is a trend of general decline in cases and we also find that the LSTM models well capture the spike and fall in cases every few days. We notice that there is less uncertainty (highlighted in green) in case of Delhi when compared to Maharashtra and rest of India. We note that in case of Delhi, there were three major peaks as shown in Figure 5. The trend of Maharashtra in Figure 5 is similar to trend of India in Figure 6 in terms of daily new cases. Therefore, we see similar trend for them when looking at the uncertainty in Figure 11.

6. Discussion

Our research incorporated some of the latest and most prominent forecasting tools via deep learning, and highlighted the challenges given limited data and the spread of infections. Generally, our results show that LSTM model gives the best performance for most cases when compared to ED-LSTM and BD-LSTM. Moreover, we found that India and Maharashtra datasets have similar trend in new cases and model performance give static split of train/test data gives better results. However, it

Model	India				Delhi				Maharashtra			
	Random Split		Static Split		Random Split		Static Split		Random Split		Static Split	
	RMSE	Std. Dev.	RMSE	Std. Dev.	RMSE	Std. Dev.	RMSE	Std. Dev.	RMSE	Std. Dev.	RMSE	Std. Dev.
LSTM	22723	811	10636	268	1403	67	3441	506	5017	243	2698	210
BD-LSTM	22610	873	10665	395	1455	65	3516	875	5205	296	2845	287
ED-LSTM	7732	272	12125	1663	1690	79	3488	234	5361	276	2503	266

Table 5: Univariate Model Results on Test dataset.

Model	India				Delhi				Maharashtra			
	Random Split		Static Split		Random Split		Static Split		Random Split		Static Split	
	RMSE	Std. Dev.	RMSE	Std. Dev.	RMSE	Std. Dev.	RMSE	Std. Dev.	RMSE	Std. Dev.	RMSE	Std. Dev.
LSTM	15144	1404	13102	2279	1322	28	4395	292	4572	274	4954	516
BD-LSTM	16490	769	24398	6172	1186	36	5065	236	4930	260	4444	786
ED-LSTM	21918	3233	15245	4657	1406	225	5238	530	6456	529	5731	583

Table 6: Multivariate Model Results on Test dataset.

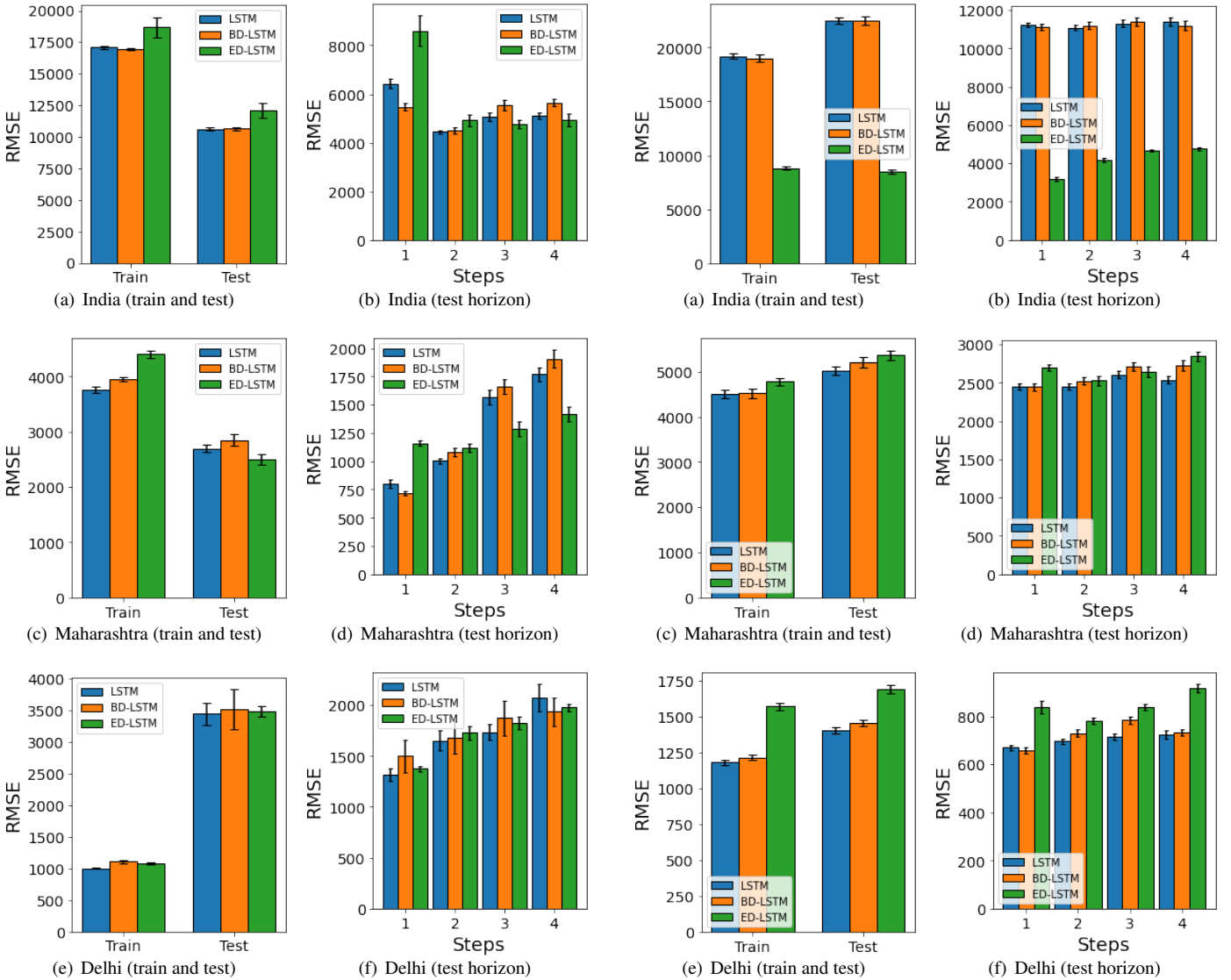

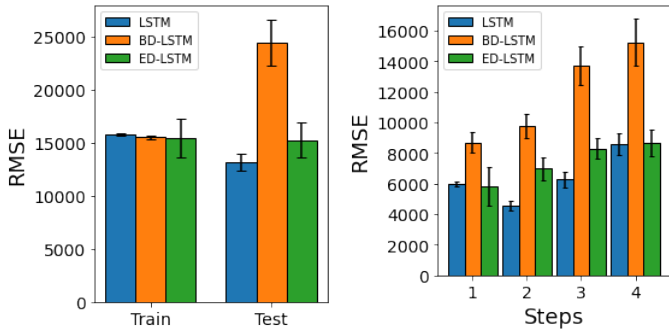

(a) India (train and test)

(b) India (test horizon)

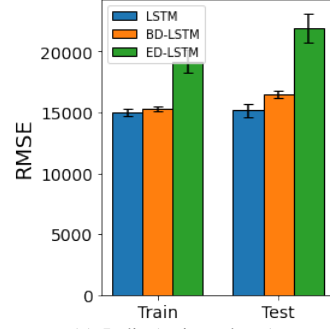

(a) India (train and test)

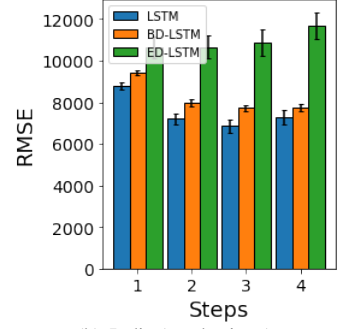

(b) India (test horizon)

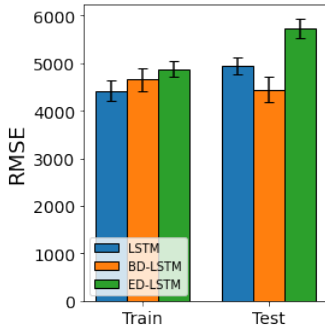

(c) Maharashtra (train and test)

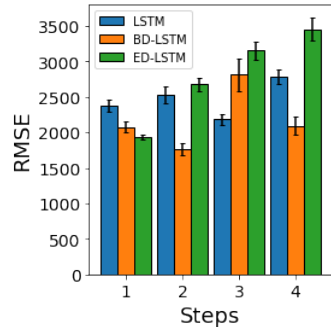

(d) Maharashtra (test horizon)

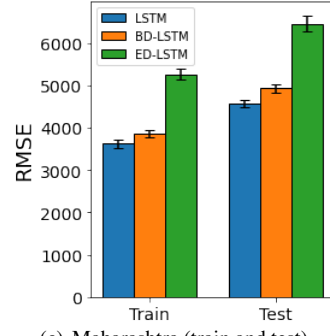

(c) Maharashtra (train and test)

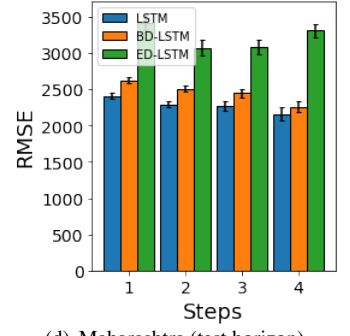

(d) Maharashtra (test horizon)

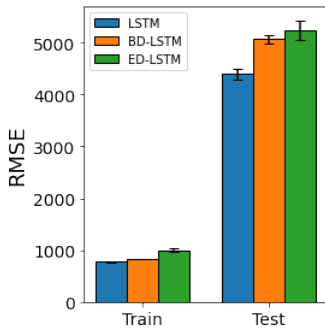

(e) Delhi (train and test)

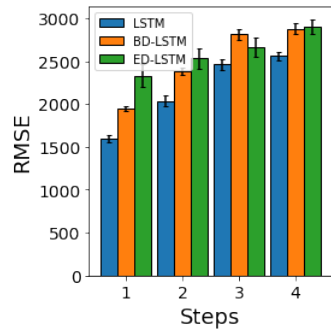

(f) Delhi (test horizon)

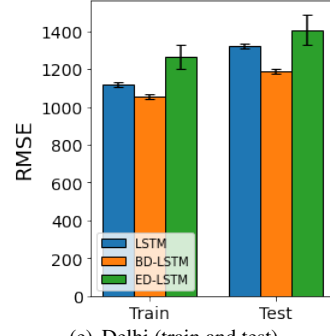

(e) Delhi (train and test)

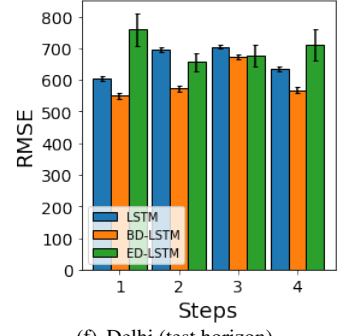

(f) Delhi (test horizon)

Figure 9: Multivariate model using LSTM, BD-LSTM and ED-LSTM with a static split of train/test datasets. The mean and 95 % confidence interval for 30 experiment runs are shown as error bars are shown with bar plots for train and test dataset and test horizon showing respective step-ahead predictions.

Figure 10: Multivariate model using LSTM, BD-LSTM and ED-LSTM with a random shuffle split of train/test datasets. The mean and 95 % confidence interval for 30 experiment runs are shown as error bars are shown with bar plots for train and test dataset and test horizon showing respective step-ahead predictions.

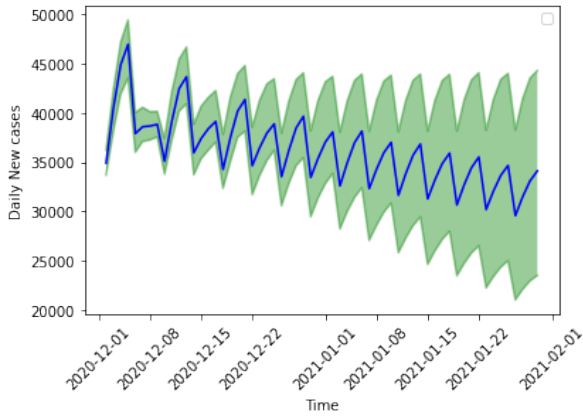

(a) India LSTM

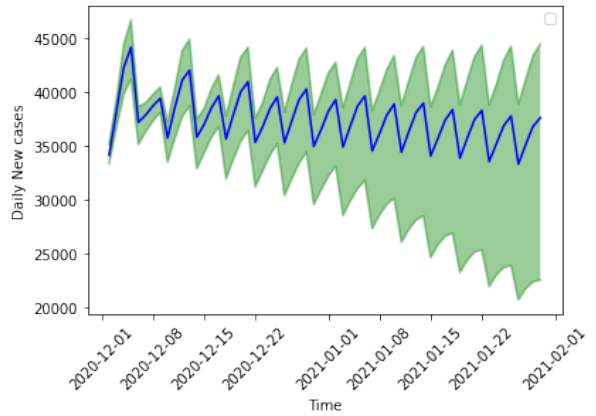

(b) India BD-LSTM



(c) Maharashtra LSTM

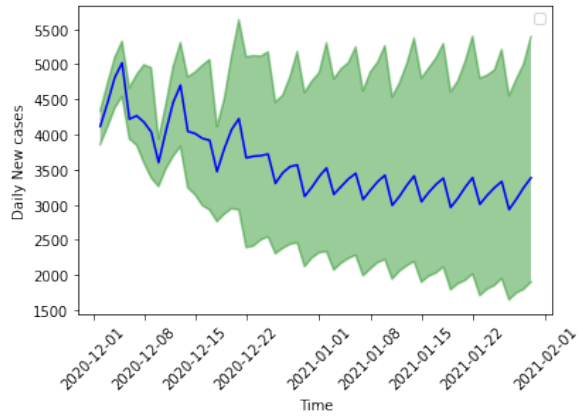

(d) Maharashtra BD-LSTM

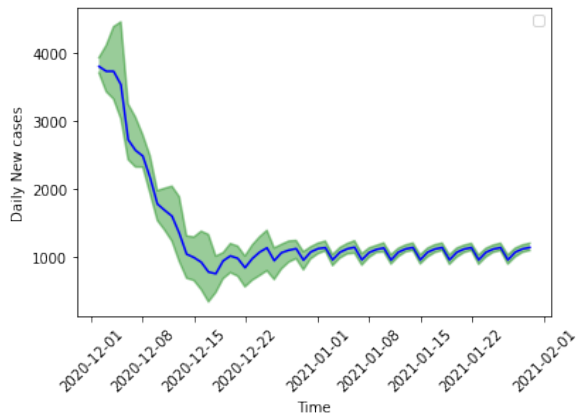

(e) Delhi LSTM

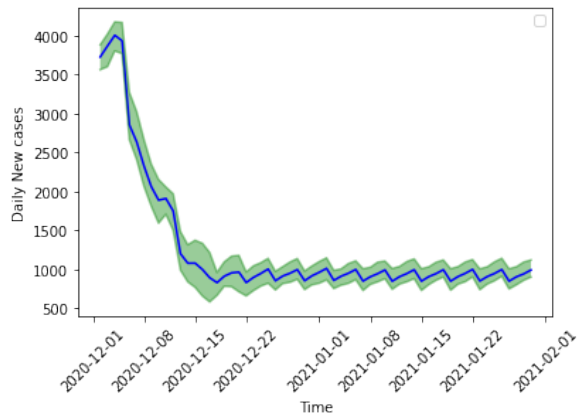

(f) Delhi BD-LSTM

Figure 11: Univariate LSTM and BD-LSTM models predicting next 60 days where the uncertainty of prediction is shaded in green and mean prediction is shown in solid blue line

is not clear to establish the winner when it comes to univariate vs multivariate performance since it depends on the dataset and models. Hence, it is difficult to determine the effect of the adjacent states in the multivariate model.

In order to improve forecasting results, our models should have more data for training. In general, the random splitting of data set improves model predictions, thus the maximum number of peaks our model can learn from, the better it should predict. The univariate models will work well under above conditions. We presented analysis of COVID-19 infections in India and provided a general comparison with some of the other hot-spot countries (such as US and Russia as shown in Figure 6) and found a trend of decline of new cases for the case of India. Surprisingly, the Indian peak in new cases was reached around the time when the government began lifting nationwide lockdown and focused more on state-level and hot-spot based lock downs [82, 83]; however, there has been strict regulations in terms of maintaining social distance and use of face-masks [84].

There are number of challenges in COVID-19 forecasting due to the nature of the infections, reporting of cases, and effect of lock downs. Nevertheless, despite the challenges and given limited dataset, we have been successful in developing LSTM models for forecasting trend of daily new cases. Our long-term forecasts for two months (December 2020, and January 2021) shows that there will be steady decline in new cases in India and the respective states. We find that Delhi's two monthly forecasts provided (Figure 11) less uncertainty when compared to Maharashtra and India cases. We also noticed that there is similar level of uncertainty by LSTM and BD-LSTM models. Our model uncertainty increases due to the limitations in the dataset and models. Our framework has been limited in capturing social-cultural aspects, population density, and level of lock-downs due to missing information and data. Moreover, inter-state travels and the chaotic nature of spread of COVID-19 infections makes it increasingly harder to provide reliable long-term forecasts.

We take into account the population density as five Indian cities make the top 50 mostly densely populated cities in the world [85], where Mumbai ranks 5th and Delhi the 40th. India so far (1st December, 2020) has conducted 140 million tests with around 100 thousand tests per million population [7]. The impact of COVID-19 on Indian gross domestic product (GDP) is significant, but not as bad when compared to developed western nations [86, 87]. One of the most crucial aspect of management of spread of COVID-19 infections is the role the government played in timely closing their international borders and enforcing lock-downs to various degrees. We need to note that different countries have different geographical and population dynamics, such as population density and social aspects. It is not a good idea to compare cities that are highly densely populated with lowly density populated cities although the overall population may be similar. Overall, it is also important to look at cultural factors such as rituals [88], and role of nuclear and extended families [89]. In countries such as India, there is large portion of inter-state migrant workers [90] and also a large portion of the population is in rural areas [91] that also have extended families. These factors made further challenges

in containing the spread of COVID-19 infections and are hard to be captured by computational and mathematical models.

In future work, it is important to incorporate robust uncertainty quantification in collection and sampling data model training and model parameters; hence, Bayesian inference framework for deep learning for COVID-19 forecasts would be needed [92, 93, 94, 95]. We could also develop similar models for death rate and other trends related to COVID-19. Moreover, deep learning and LSTM models could be used to model the rise and fall of cases and the effect it has on economy of a country.

7. Conclusions

We presented the use of LSTM models for COVID-19 forecasting for India. Our results show the challenges of forecasting given limited data which is highly biased given that we have a single major peak when considering entire India cases. We experimented with different ways of creating training and test data and models which all showed strengths and limitations that made it difficult to choose a single model. Our two months ahead forecast shows general decline in new cases; however, this has a number of limitations and assumptions and does not feature robust uncertainty quantification.

In future work, it is important to further enhance the respective models and also provide robust uncertainty quantification, both in data and model parameters and hence Bayesian inference would be very useful. Moreover, it is important to incorporate more features in the model for reducing uncertainty in model predictions.

Software and Data

Data and open source code in Python is available for further analysis⁹.

References

- [1] A. E. Gorbalenya, S. C. Baker, R. S. Baric, R. J. de Groot, C. Drosten, A. A. Gulyaeva, B. L. Haagmans, C. Lauber, A. M. Leontovich, B. W. Neuman, D. Penzar, L. L. M. P. Stanley Perlman, D. V. Samborskiy, I. A. Sidorov, I. Sola, and J. Ziebuhr, "The species severe acute respiratory syndrome-related coronavirus: classifying 2019-ncov and naming it sars-cov-2," *Nature Microbiology*, vol. 5, no. 4, p. 536, 2020.
- [2] V. Monteil, H. Kwon, P. Prado, A. Hagelkrüys, R. A. Wimmer, M. Stahl, A. Leopoldi, E. Garreta, C. H. Del Pozo, F. Prosper *et al.*, "Inhibition of sars-cov-2 infections in engineered human tissues using clinical-grade soluble human ace2," *Cell*, 2020.
- [3] W. H. Organization *et al.*, "Coronavirus disease 2019 (COVID-19): situation report, 72," 2020.
- [4] D. Cucinotta and M. Vanelli, "WHO declares COVID-19 a pandemic." *Acta bio-medica: Atenei Parmensis*, vol. 91, no. 1, pp. 157–160, 2020.
- [5] K. G. Andersen, A. Rambaut, W. I. Lipkin, E. C. Holmes, and R. F. Garry, "The proximal origin of sars-cov-2," *Nature medicine*, vol. 26, no. 4, pp. 450–452, 2020.

⁹<https://github.com/sydney-machine-learning/LSTM-COVID-19-India>

- [6] E. Dong, H. Du, and L. Gardner, "An interactive web-based dashboard to track COVID-19 in real time," *The Lancet infectious diseases*, vol. 20, no. 5, pp. 533–534, 2020.
- [7] "COVID-19 Dashboard, Center for Systems Science and Engineering (CSSE), Johns Hopkins University, url=https://coronavirus.jhu.edu/map.html."
- [8] A. Atkeson, "What will be the economic impact of COVID-19 in the us? rough estimates of disease scenarios," National Bureau of Economic Research, Tech. Rep., 2020.
- [9] N. Fernandes, "Economic effects of coronavirus outbreak (COVID-19) on the world economy," Available at SSRN 3557504, 2020.
- [10] M. Maliszewska, A. Mattoo, and D. Van Der Mensbrugge, "The potential impact of COVID-19 on gdp and trade: A preliminary assessment," 2020.
- [11] C. E. Hart, D. J. Hayes, K. L. Jacobs, L. L. Schulz, and J. M. Crespi, "The impact of COVID-19 on iowa's corn, soybean, ethanol, pork, and beef sectors," *Center for Agricultural and Rural Development, Iowa State University. CARD Policy Brief*, 2020.
- [12] R. Siche, "What is the impact of COVID-19 disease on agriculture?" *Scientia Agropecuaria*, vol. 11, no. 1, pp. 3–6, 2020.
- [13] A. Liem, C. Wang, Y. Wariyanti, C. A. Latkin, and B. J. Hall, "The neglected health of international migrant workers in the COVID-19 epidemic," *The Lancet Psychiatry*, vol. 7, no. 4, p. e20, 2020.
- [14] H. H. P. Kluge, Z. Jakab, J. Bartovic, V. D'Anna, and S. Severoni, "Refugee and migrant health in the COVID-19 response," *The Lancet*, vol. 395, no. 10232, pp. 1237–1239, 2020.
- [15] T. Lancet, "India under COVID-19 lockdown," *Lancet (London, England)*, vol. 395, no. 10233, p. 1315, 2020.
- [16] R. M. Arias Velásquez and J. V. Mejía Lara, "Forecast and evaluation of COVID-19 spreading in USA with reduced-space gaussian process regression," *Chaos, Solitons & Fractals*, vol. 136, p. 109924, 2020.
- [17] M. Yousaf, S. Zahir, M. Riaz, S. M. Hussain, and K. Shah, "Statistical analysis of forecasting COVID-19 for upcoming month in pakistan," *Chaos, Solitons & Fractals*, vol. 138, p. 109926, 2020.
- [18] A. I. Saba and A. H. Elsheikh, "Forecasting the prevalence of COVID-19 outbreak in egypt using nonlinear autoregressive artificial neural networks," *Process Safety and Environmental Protection*, vol. 141, pp. 1–8, 2020.
- [19] H. Ren, L. Zhao, A. Zhang, L. Song, Y. Liao, W. Lu, and C. Cui, "Early forecasting of the potential risk zones of COVID-19 in china's megacities," *Science of The Total Environment*, vol. 729, p. 138995, 2020.
- [20] R. G. [da Silva], M. H. D. M. Ribeiro, V. C. Mariani, and L. dos Santos Coelho, "Forecasting brazilian and american covid-19 cases based on artificial intelligence coupled with climatic exogenous variables," *Chaos, Solitons & Fractals*, vol. 139, p. 110027, 2020.
- [21] T. Chakraborty and I. Ghosh, "Real-time forecasts and risk assessment of novel coronavirus COVID-19 cases: A data-driven analysis," *Chaos, Solitons & Fractals*, vol. 135, p. 109850, 2020.
- [22] M. Maleki, M. R. Mahmoudi, D. Wraith, and K.-H. Pho, "Time series modelling to forecast the confirmed and recovered cases of COVID-19," *Travel Medicine and Infectious Disease*, p. 101742, 2020.
- [23] A. S. Fauci, H. C. Lane, and R. R. Redfield, "COVID-19 - navigating the uncharted," 2020.
- [24] F. Ye, S. Xu, Z. Rong, R. Xu, X. Liu, P. Deng, H. Liu, and X. Xu, "Delivery of infection from asymptomatic carriers of COVID-19 in a familial cluster," *International Journal of Infectious Diseases*, 2020.
- [25] Y. Bai, L. Yao, T. Wei, F. Tian, D.-Y. Jin, L. Chen, and M. Wang, "Presumed asymptomatic carrier transmission of COVID-19," *Jama*, vol. 323, no. 14, pp. 1406–1407, 2020.
- [26] V. Chin, N. I. Samia, R. Marchant, O. Rosen, J. Ioannidis, M. A. Tanner, and S. Cripps, "A case study in model failure? COVID-19 daily deaths and icu bed utilisation predictions in new york state," *arXiv preprint arXiv:2006.15997*, 2020.
- [27] R. M. Anderson, H. Heesterbeek, D. Klinkenberg, and T. D. Hollingsworth, "How will country-based mitigation measures influence the course of the COVID-19 epidemic?" *The Lancet*, vol. 395, no. 10228, pp. 931–934, 2020.
- [28] J. L. Elman and D. Zipser, "Learning the hidden structure of speech," *The Journal of the Acoustical Society of America*, vol. 83, no. 4, pp. 1615–1626, 1988. [Online]. Available: <http://link.aip.org/link/?JAS/83/1615/1>
- [29] P. J. Werbos, "Backpropagation through time: what it does and how to do it," *Proceedings of the IEEE*, vol. 78, no. 10, pp. 1550–1560, 1990.
- [30] S. Hochreiter and J. Schmidhuber, "Long short-term memory," *Neural computation*, vol. 9, no. 8, pp. 1735–1780, 1997.
- [31] J. Schmidhuber, "Deep learning in neural networks: An overview," *Neural networks*, vol. 61, pp. 85–117, 2015.
- [32] J. T. Connor, R. D. Martin, and L. E. Atlas, "Recurrent neural networks and robust time series prediction," *IEEE transactions on neural networks*, vol. 5, no. 2, pp. 240–254, 1994.
- [33] C. W. Omlin, K. K. Thornber, and C. L. Giles, "Fuzzy finite state automata can be deterministically encoded into recurrent neural networks," *IEEE Trans. Fuzzy Syst.*, vol. 6, pp. 76–89, 1998.
- [34] C. W. Omlin and C. L. Giles, "Training second-order recurrent neural networks using hints," in *Proceedings of the Ninth International Conference on Machine Learning*. Morgan Kaufmann, 1992, pp. 363–368.
- [35] C. L. Giles, C. Omlin, and K. K. Thornber, "Equivalence in knowledge representation: Automata, recurrent neural networks, and dynamical fuzzy systems," *Proceedings of the IEEE*, vol. 87, no. 9, pp. 1623–1640, 1999.
- [36] Y. Bengio, P. Simard, and P. Frasconi, "Learning long-term dependencies on gradient descent is difficult," *Neural Networks, IEEE Transactions on*, vol. 5, no. 2, pp. 157–166, 1994.
- [37] Z. Yang, Z. Zeng, K. Wang, S.-S. Wong, W. Liang, M. Zanin, P. Liu, X. Cao, Z. Gao, Z. Mai *et al.*, "Modified seir and ai prediction of the epidemics trend of COVID-19 in china under public health interventions," *Journal of Thoracic Disease*, vol. 12, no. 3, p. 165, 2020.
- [38] V. K. R. Chimmula and L. Zhang, "Time series forecasting of COVID-19 transmission in canada using lstm networks," *Chaos, Solitons & Fractals*, vol. 135, p. 109864, 2020.
- [39] S. Xingjian, Z. Chen, H. Wang, D.-Y. Yeung, W.-K. Wong, and W.-c. Woo, "Convolutional lstm network: A machine learning approach for precipitation nowcasting," in *Advances in neural information processing systems*, 2015, pp. 802–810.
- [40] H.-z. Wang, G.-q. Li, G.-b. Wang, J.-c. Peng, H. Jiang, and Y.-t. Liu, "Deep learning based ensemble approach for probabilistic wind power forecasting," *Applied energy*, vol. 188, pp. 56–70, 2017.
- [41] G. A. Millett, A. T. Jones, D. Benkeser, S. Baral, L. Mercer, C. Beyrer, B. Honeremann, E. Lankiewicz, L. Mena, J. S. Crowley *et al.*, "Assessing differential impacts of COVID-19 on black communities," *Annals of Epidemiology*, 2020.
- [42] R. P. Rajkumar, "COVID-19 and mental health: A review of the existing literature," *Asian journal of psychiatry*, p. 102066, 2020.
- [43] J. Gao, P. Zheng, Y. Jia, H. Chen, Y. Mao, S. Chen, Y. Wang, H. Fu, and J. Dai, "Mental health problems and social media exposure during COVID-19 outbreak," *Plos one*, vol. 15, no. 4, p. e0231924, 2020.
- [44] C. Owusu-Fordjour, C. Koomson, and D. Hanson, "The impact of COVID-19 on learning-the perspective of the ghanaiian student," *European Journal of Education Studies*, 2020.
- [45] D. S. W. Ting, L. Carin, V. Dzau, and T. Y. Wong, "Digital technology and COVID-19," *Nature medicine*, vol. 26, no. 4, pp. 459–461, 2020.
- [46] N. G. Biavardi, "Being an italian medical student during the COVID-19 outbreak," *International Journal of Medical Students*, vol. 8, no. 1, pp. 49–50, 2020.
- [47] H. Leite, I. R. Hodgkinson, and T. Gruber, "New development: 'healing at a distance'—telemedicine and COVID-19," *Public Money & Management*, pp. 1–3, 2020.
- [48] C. Zhou, F. Su, T. Pei, A. Zhang, Y. Du, B. Luo, Z. Cao, J. Wang, W. Yuan, Y. Zhu *et al.*, "COVID-19: Challenges to gis with big data," *Geography and Sustainability*, 2020.
- [49] M. A. Zambrano-Monserrate, M. A. Ruano, and L. Sanchez-Alcalde, "Indirect effects of COVID-19 on the environment," *Science of the Total Environment*, p. 138813, 2020.
- [50] S. Muhammad, X. Long, and M. Salman, "COVID-19 pandemic and environmental pollution: a blessing in disguise?" *Science of The Total Environment*, p. 138820, 2020.
- [51] A. Kerimray, N. Baimatova, O. P. Ibragimova, B. Bukenov, B. Kenessov, P. Plotitsyn, and F. Karaca, "Assessing air quality changes in large cities during COVID-19 lockdowns: The impacts of traffic-free urban conditions in almaty, kazakhstan," *Science of The Total Environment*, vol. 730, p. 139179, 2020. [Online]. Available: <http://www.sciencedirect.com/science/article/pii/S0048969720326966>
- [52] M. A. Zambrano-Monserrate, M. A. Ruano, and L. Sanchez-Alcalde,

- “Indirect effects of COVID-19 on the environment,” *Science of The Total Environment*, vol. 728, p. 138813, 2020. [Online]. Available: <http://www.sciencedirect.com/science/article/pii/S0048969720323305>
- [53] Y. Huang, Y. Wu, and W. Zhang, “Comprehensive identification and isolation policies have effectively suppressed the spread of COVID-19,” *Chaos, Solitons and Fractals*, vol. 139, p. 110041, 2020. [Online]. Available: <http://www.sciencedirect.com/science/article/pii/S0960077920304392>
- [54] S. I. Alzahrani, I. A. Aljamaan, and E. A. Al-Fakih, “Forecasting the spread of the COVID-19 pandemic in Saudi Arabia using ARIMA prediction model under current public health interventions,” *Journal of Infection and Public Health*, vol. 13, no. 7, pp. 914–919, 2020.
- [55] S. Singh, K. S. Parmar, J. Kumar, and S. J. S. Makkhan, “Development of new hybrid model of discrete wavelet decomposition and autoregressive integrated moving average (ARIMA) models in application to one month forecast the casualties cases of COVID-19,” *Chaos, Solitons & Fractals*, vol. 135, p. 109866, 2020.
- [56] A. Anand, Y. Lamba, and A. Roy, “Forecasting COVID-19 transmission in India using deep learning models.”
- [57] K. R. Bhimala, G. K. PATRA, R. Mopuri, and S. R. Mutheni, “A deep learning approach for prediction of SARS-CoV-2 cases using the weather factors in India,” *Authorea Preprints*, 2020.
- [58] R. P. Shetty *et al.*, “Realtime forecasting of COVID-19 cases in Karnataka state using artificial neural network (ANN),” 2020.
- [59] A. Tomar and N. Gupta, “Prediction for the spread of COVID-19 in India and effectiveness of preventive measures,” *Science of The Total Environment*, vol. 728, p. 138762, 2020. [Online]. Available: <http://www.sciencedirect.com/science/article/pii/S0048969720322798>
- [60] G. Battineni, N. Chintalapudi, and F. Amenta, “Forecasting of COVID-19 epidemic size in four high hitting nations (USA, Brazil, India and Russia) by FB-Prophet machine learning model,” *Applied Computing and Informatics*, 2020.
- [61] P. Nadler, R. Arcucci, and Y. Guo, “A neural SIR model for global forecasting,” in *Machine Learning for Health*. PMLR, 2020, pp. 254–266.
- [62] R. G. da Silva, M. H. D. M. Ribeiro, J. H. Kleinübing, V. C. M. Larcher, and L. dos Santos Coelho, “Forecasting the cumulative cases of COVID-19 in Brazil using machine learning approaches.”
- [63] A. K. Gupta, V. Singh, P. Mathur, and C. M. Travieso-Gonzalez, “Prediction of COVID-19 pandemic measuring criteria using support vector machine, prophet and linear regression models in Indian scenario,” *Journal of Interdisciplinary Mathematics*, pp. 1–20, 2020.
- [64] S. Bodapati, H. Bandarupally, and M. Trupthi, “COVID-19 time series forecasting of daily cases, deaths caused and recovered cases using long short term memory networks,” in *2020 IEEE 5th International Conference on Computing Communication and Automation (ICCCA)*. IEEE, 2020, pp. 525–530.
- [65] V. Chaurasia and S. Pal, “Application of machine learning time series analysis for prediction COVID-19 pandemic,” *Research on Biomedical Engineering*, pp. 1–13, 2020.
- [66] O. Istaïth, T. Owais, N. Al-Madi, and S. Abu-Soud, “Machine learning approaches for COVID-19 forecasting,” in *2020 International Conference on Intelligent Data Science Technologies and Applications (IDSTA)*. IEEE, 2020, pp. 50–57.
- [67] A. Mosavi, “COVID-19 pandemic prediction for Hungary; a hybrid machine learning approach,” 2020.
- [68] F. Takens, “Detecting strange attractors in turbulence,” in *Dynamical Systems and Turbulence, Warwick 1980*, ser. Lecture Notes in Mathematics, 1981, pp. 366–381.
- [69] C. Frazier and K. Kockelman, “Chaos theory and transportation systems: Instructive example,” *Transportation Research Record: Journal of the Transportation Research Board*, vol. 20, pp. 9–17, 2004.
- [70] J. L. Elman, “Finding structure in time,” *Cognitive Science*, vol. 14, pp. 179–211, 1990.
- [71] C. W. Omlin and C. L. Giles, “Constructing deterministic finite-state automata in recurrent neural networks,” *J. ACM*, vol. 43, no. 6, pp. 937–972, 1996.
- [72] R. Chandra, “Competition and collaboration in cooperative coevolution of Elman recurrent neural networks for time-series prediction,” *IEEE Trans. Neural Netw. Learning Syst.*, vol. 26, no. 12, pp. 3123–3136, 2015. [Online]. Available: <http://dx.doi.org/10.1109/TNNLS.2015.2404823>
- [73] S. Hochreiter, “The vanishing gradient problem during learning recurrent neural nets and problem solutions,” *Int. J. Uncertain. Fuzziness Knowl.-Based Syst.*, vol. 6, no. 2, pp. 107–116, 1998.
- [74] M. Schuster and K. Paliwal, “Bidirectional recurrent neural networks,” *Signal Processing, IEEE Transactions on*, vol. 45, pp. 2673–2681, 12 1997.
- [75] A. Graves and J. Schmidhuber, “Framewise phoneme classification with bidirectional LSTM and other neural network architectures,” *Neural networks: the official journal of the International Neural Network Society*, vol. 18, pp. 602–10, 07 2005.
- [76] Y. Fan, Y. Qian, F.-L. Xie, and F. K. Soong, “TTS synthesis with bidirectional LSTM based recurrent neural networks,” in *INTERSPEECH*, 2014.
- [77] A. Graves, N. Jaitly, and A.-r. Mohamed, “Hybrid speech recognition with deep bidirectional LSTM,” in *2013 IEEE workshop on automatic speech recognition and understanding*. IEEE, 2013, pp. 273–278.
- [78] I. Sutskever, O. Vinyals, and Q. V. Le, “Sequence to sequence learning with neural networks,” in *Advances in Neural Information Processing Systems 27*, Z. Ghahramani, M. Welling, C. Cortes, N. D. Lawrence, and K. Q. Weinberger, Eds. Curran Associates, Inc., 2014, pp. 3104–3112. [Online]. Available: <http://papers.nips.cc/paper/5346-sequence-to-sequence-learning-with-neural-networks.pdf>
- [79] “Unique identification authority of India,” May 2020, [Online; accessed 16-July-2020]. [Online]. Available: <https://uidai.gov.in/images/state-wise-aadhaar-saturation.pdf>
- [80] N. G. Siva Athreya and A. Mishra, “COVID-19 India-timeline an understanding across states and union territories,” 2020, ongoing Study at <http://www.isibang.ac.in/~athreya/incovid19>.
- [81] “COVID-19 India data,” 2020, government Website at <https://www.mohfw.gov.in/>.
- [82] R. Debnath and R. Bardhan, “India nudges to contain COVID-19 pandemic: A reactive public policy analysis using machine-learning based topic modelling,” *PLOS ONE*, vol. 15, no. 9, pp. 1–25, 09 2020. [Online]. Available: <https://doi.org/10.1371/journal.pone.0238972>
- [83] B. Rai, A. Shukla, and L. K. Dwivedi, “Dynamics of COVID-19 in India: A review of different phases of lockdown,” *Population Medicine*, vol. 2, no. July, 2020. [Online]. Available: <http://dx.doi.org/10.18332/popmed/125064>
- [84] S. Rab, M. Javaid, A. Haleem, and R. Vaishya, “Face masks are new normal after COVID-19 pandemic,” *Diabetes & Metabolic Syndrome: Clinical Research & Reviews*, vol. 14, no. 6, pp. 1617–1619, 2020.
- [85] Wikipedia contributors, “List of cities proper by population density, Wikipedia,” 2020, [Online; accessed 16-July-2020]. [Online]. Available: https://en.wikipedia.org/wiki/List_of_cities_proper_by_population_density
- [86] S. M. Dev, R. Sengupta *et al.*, “COVID-19: impact on the Indian economy,” *Indira Gandhi Institute of Development Research, Mumbai Working Papers, April*, 2020. [Online]. Available: <https://ideas.repec.org/p/ind/igiwpp/2020-013.html>
- [87] “The World Economic Outlook April 2020: The Great Lockdown, International Monetary Fund,” April 2020, [Online; accessed 16-July-2020]. [Online]. Available: <https://www.imf.org/en/Publications/WEO/Issues/2020/04/14/weo-april-2020>
- [88] E. Imber-Black, “Rituals in the time of COVID-19: Imagination, responsiveness, and the human spirit,” *Family process*, vol. 59, no. 3, pp. 912–921, 2020.
- [89] J. L. Lebow, “Family in the age of COVID-19,” *Family process*, vol. 59, no. 2, p. 309–312, June 2020. [Online]. Available: <https://europemc.org/articles/PMC7273068>
- [90] A. Dandekar and R. Ghai, “Migration and reverse migration in the age of COVID-19,” *Economic and Political Weekly*, vol. 55, no. 19, pp. 28–31, 2020.
- [91] A. Kumar, K. R. Nayar, and S. F. Koya, “COVID-19: Challenges and its consequences for rural health care in India,” *Public Health in Practice*, p. 100009, 2020.
- [92] R. M. Neal, “Bayesian learning via stochastic dynamics,” in *Advances in Neural Information Processing Systems 5*. Morgan-Kaufmann, 1993, pp. 475–482.
- [93] J. Pall, R. Chandra, D. Azam, T. Salles, J. M. Webster, R. Scalzo, and S. Cripps, “BayesReef: A Bayesian inference framework for modelling reef growth in response to environmental change and biological dynamics,” *Environmental Modelling & Software*, p. 104610, 2020.
- [94] R. Chandra, K. Jain, R. V. Deo, and S. Cripps, “Langevin-gradient parallel

tempering for bayesian neural learning,” *Neurocomputing*, 2019.

- [95] R. Chandra and A. Kapoor, “Bayesian neural multi-source transfer learning,” *Neurocomputing*, vol. 378, pp. 54 – 64, 2020. [Online]. Available: <http://www.sciencedirect.com/science/article/pii/S0925231219314213>