

# Efficient Video Summarization Framework using EEG and Eye-tracking Signals

Sai Sukruth Bezugam\*, *Student Member, IEEE*, Swatilekha Majumdar\*, Chetan Ralekar\*  
and Tapan Kumar Gandhi<sup>+</sup>, *Senior Member, IEEE*

**Abstract**—This paper proposes an efficient video summarization framework that will give a gist of the entire video in a few key-frames or video skims. Existing video summarization frameworks are based on algorithms that utilize computer vision low-level feature extraction or high-level domain level extraction. However, being the ultimate user of the summarized video, humans remain the most neglected aspect. Therefore, the proposed paper considers human’s role in summarization and introduces human visual attention-based summarization techniques. To understand human attention behavior, we have designed and performed experiments with human participants using electroencephalogram (EEG) and eye-tracking technology. The EEG and eye-tracking data obtained from the experimentation are processed simultaneously and used to segment frames containing useful information from a considerable video volume. Thus, the frame segmentation primarily relies on the cognitive judgments of human beings. Using our approach, a video is summarized by  $\sim 96.5\%$  while maintaining higher precision ( $\sim 0.98$ ) and high recall factors ( $\sim 0.97$ ). The comparison with the state-of-the-art techniques demonstrates that the proposed approach yields ceiling-level performance with reduced computational cost in summarising the videos.

**Index Terms**—EEG, Eye-tracking, Video Summarization framework

## I. INTRODUCTION

RECENT advances in storage and digital media technology have made recording and aggregating massive volumes of videos facile [1]. An enormous amount of videos are uploaded to video-sharing websites every minute. Moreover, a large volume of the surveillance videos is recorded to ensure security, and analyzing such videos is tedious. It is very challenging to retrieve relevant information from vast video content in an efficient manner. Addressing these hurdles, efforts are being made to devise a video summary, which gives the essence of the entire video in a short time. This technique is known as video summarization [2]–[4]. Video summarization is a method that expedites faster browsing of extensive video collections and facilitates dynamic content indexing and access. Thus, video summarization is getting more importance in the multimedia industry [5]–[8], especially in the field of surveillance. This summarization is achieved by an efficient selection of key-frames that are representative of

the whole video. The extraction of key-frames is performed by detecting change points, low-level features based on clustering, or clustering depending on objects. The key-frames are helpful for indexing videos; however, they are void of motion data. This, in turn, restricts their use in information retrieval tasks. In video skimming, short segments of the video are selected for summarization. Such segments should be properly chosen in order to convey maximum information.

It is very well known that humans are the end-users of these summarization tasks who want to get the gist of an hourly long video in a couple of minutes. Hence, it is of utmost importance that inputs are taken from humans for designing a video summarization framework [9], [10]. However, the state of the art deep learning-based methods hardly consider humans’ role in proposing such architectures. It is imperative to consider how humans perceive the video and extract critical information. Thus, the present paper attempts to extract the key segments from the video by understanding perceptual processes and visual attention. This paper takes into account human perception while extracting key-frames.

The major contributions of the paper can be summarized as:

- We proposed a video summarization technique using cues from perceptual and visual attentive behavior of humans.
- We have designed, and performed experiments using both EEG and eye-tracking technology and used the respective signals to extract the key-frames.
- We have compared the proposed technique with state-of-the-art video summarization techniques.

The paper’s organization is as follows: Section II highlights some related works in video summarization that have been proposed in the literature. The experimental details and setup description for the proposed methodology has been discussed in section III. The proposed video summarization framework is described in section IV. Section V discusses the performance of the proposed framework and establishes performance benchmarks compared to some recent works proposed in the literature. The section also elaborates on the advantage of using both EEG and eye-tracking in video summarization. Section V gives concluding remarks with possible future extensions.

## II. RELATED WORKS

Video summarization is a technique which aids faster browsing of extensive video collections leading to more efficient content indexing and access. The summary is generated by

S. S. Bezugam, S. Majumdar, C. Ralekar, T. K. Gandhi is affiliated to the Department of Electrical Engineering, Indian Institute of Technology, Delhi, India. E-mail : saisukruthbezugam@ieee.org, swatilekha.phd@gmail.com, chetan.ralekar@gmail.com, tgandhi@iitd.ac.in

\*Authors have contributed equally to the paper.

<sup>+</sup>(Corresponding Author: T. K. Gandhi).

Manuscript received XXXX, XXXX; revised XXXX.

extracting key-frames that best portray the video. While selecting the segments, care should be taken to embody the whole video and segregate important information to the user. Traditional video summarization techniques can be roughly classified into three categories: (i) Summarization based on hand-crafted features, (ii) Summarization frameworks based on deep learning architecture, (iii) Summarization based on human perception.

#### A. Summarization based on on hand-crafted features

A large part of video summarization research has focused on the development of two major techniques – (i) low-level video summarization techniques, where videos are summarised by examining the low-level features such as the shape, color, motion, and speech present in the video [11], and (ii) high-level or domain-specific video summarization, where domain-specific information is used to recognize quintessential shots of a video. Ejaz et al. [12] used an aggregation mechanism to combine visual features, where correlations between RGB color channels, color histogram, and moments of inertia lead to extraction of keyframes from a video sequence. Similarly, Zhou et al. [13] extracted audio, color, and motion features, which were fused using an adaptive weighting mechanism. The video sequence is then clustered by using a fuzzy c-means scheme along with an optimally determined cluster number. A summarization technique based on color feature extraction was presented by De et al. [14]. Similarly, a summarization system for producing on-the-fly video storyboards was presented in [15]. This method creates still and moving storyboards with additional features of advanced customization by users. A segmentation-based clustering algorithm was presented by Almeida et al. in [16]. In this case, the video was broken down into a set of essential shots by decomposing the image stream’s color histogram. Next, in each video shot, a Zero-mean Normalized Cross-correlation metric [17] is employed to eliminate redundant frames. The chosen frames are then refined to bypass any insignificant frames in the video summary. Joho et al. [18] followed a summarization process based on the viewer’s facial expression. A video summarization based on pupillary dilation and eye gaze was proposed by Katti et al. [19]. Mehmood et al., in their paper [9], used EEG signals obtained from visual, auditory, and data from beta ( $\beta$ ) frequency band to extract keyframes from the video.

From the above description, we can see that while low-level video summarization methods mostly rely on the contents of the frame to summarize the video. Recently, some papers have also used EEG and fMRI signals to do the same. Eliciting the informative contents using the high-frequency components of EEG signals, Salehin et al. [20] proposed a method for video summarization. In this, the Empirical Mode Decomposition (EMD) technique was employed to disintegrate EEG signals into high to low-frequency components known as Intrinsic Mode Function (IMF). Video frames tagged and summarized as per emotions, as recognized from EEG was proposed in [21]. The authors further used a crowd-sourcing model to develop the condition and evaluation of video summarization. Han et al. [22] employed fMRI signals from the brain to guide

the extraction of visually informative segments from videos. These techniques relied on handcrafted features, which may or may not fetch the best summary from the video. Therefore, deep learning-based approaches were introduced.

#### B. Summarization frameworks based on on deep learning architecture

AI-based summarization tackles the problem of summarizing a video mostly based on clustering techniques. These solutions have a two-step approach: (a) distinguishing video shots from the video, and (b) choosing key-frames based on some criterion from each video shot. Zhuang et al. [23] and Hanjalic et al. [24] used color histogram features in the HSV color space to proposed an unsupervised clustering approach. In [24], the key-frames are chosen by considering the frame closest to the cluster centroid. Gong and Liu [25] proposed a video summarization where the input video to be summarized was clustered to form sets. Although it was expected that the key-frames in the same cluster should be visually the same, the sets obtained in this case were visually different from each other. All the above methods act on a rule-based approach and hardly consider how humans perceive things. The deep learning based video summarization frameworks like VSUMM [26] uses highly complex architectures which are hardly explainable. Thus, these frameworks are used as black boxes. Recently, explainable architectures [27], [28] are proposed to understand the black box. However, such architecture generates heat maps, which highlights the important image regions; humans remains the most neglected aspect in those architectures.

#### C. Summarization based on human perception

Most of the video summarization methodologies that are presented in literature either focus on visual, auditory, or facial expression data of the user. However, some researchers have started using EEG signals along with the above methodologies to summarize the video to obtain useful frames. Mehmood et al. [29] proposed a summing scheme that combined EEG signals with audio-visual features for comprehension of videos. Salehin and Paul [20] introduced an amalgamation of Empirical Mode Decomposition (EMD) and EEG to summarize video events. In EMD, different frequency components (high to low) was derived from EEG signals to obtain key-frames from the digital video. EEG seemed to be a choice for some researchers [20], [30]–[32] while extracting key-frames for video summarization. However, the proposed framework was driven by ‘how humans perceive what they see and observe’. This can not be addressed without using the eye-tracking technique because eye-movements can provide moment-to-moment information processing [33] by the brain. Moreover, it is assumed that humans fixate on the object of interest to them. Thus, the eye-tracking technology has been widely used to identify essential image regions for the task of image recognition [34], [35], memorability detection [36], along with understanding the perceptual process. Therefore along with the EEG, it is vital to consider the eye-tracking events to get an overall picture of which key-frames are necessary for us.

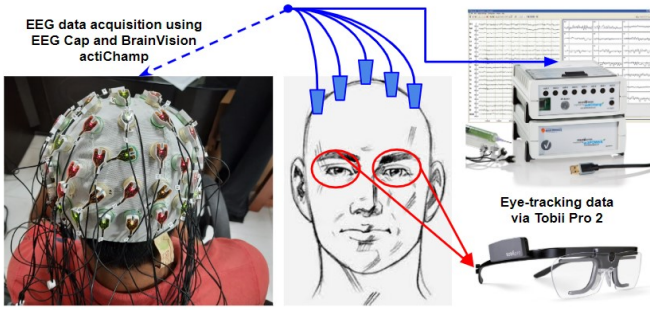

Fig. 1. Participants wearing EEG cap before the experiment. ActiCHamp [37] has been used in this work to record the EEG. Tobii eye-tracking glasses are used for capturing eye-movements

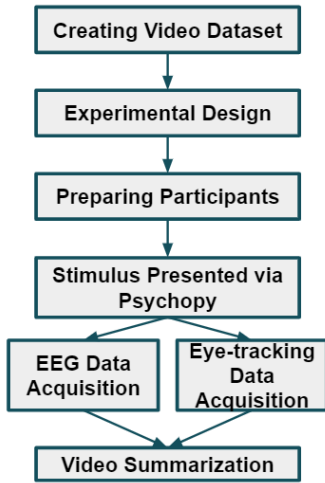

Fig. 2. Methodology followed for data acquisition and pre-processing the work presented in the paper.

### III. EXPERIMENTAL DETAILS

The overall experimental details are given in Fig. 2. The methodology involves creating a video dataset, experimental design, participant screening, stimulus preparation for data acquisition, acquiring data. In this section, we describe the experimental protocol and the proposed framework used for our work.

#### A. Dataset Preparation

To create the database for surveillance video, we recorded a 60-minute video of the student activities in a room at the Indian Institute of Technology, Delhi, with due permission from the students and the concerned authorities.

#### B. Participant Screening

Total 15 participants, with normal or corrected to normal vision actively participated in the experiment. All the participants were healthy with an average age of 25 years ( $\pm 2.5$  years). Each participant was assigned a different identification number for maintaining data confidentiality.

#### C. Eye-tracking and EEG Equipment

For our work, we want to acquire both the brain signals (EEG) and eye-tracking data from the participants when presented with stimuli. We have used BrainVision actiChamp with 64 channels for EEG signal acquisition. The electrodes were placed according to the international 10–20 system [39]. Brain Vision actiChamp [37] amplified the collected signals and EEG data was collected at a sampling frequency of 2500 Hz. The eye-tracking data was collected using Tobii Pro-Glasses-2 having sampling frequency of 100 Hz.

#### D. Stimulus Design and presentation sequence

From the acquired video, short snippets of 2-minute videos were created, and an experiment was designed. Fig. 3 depicts the experimental protocol used for data collection. As observed from the Fig. 3, we have presented the video snippet (2 min) from our database interleaved by a fixation screen. The fixation screen was essentially a grey screen with a fixation cross at the center displayed for 1s. The stimulus i.e. 2 min video snippet was presented on a monitor via Psychopy software tool [40], which is an application to create experiments in behavioral science.

#### E. Experimental Protocol

Before the start of the experiment, we described the experimental procedure to each participant. After getting the consent from the participant, he/she was asked to sit comfortably in front of a monitor screen which was fixed at a distance of 60–80 cm. The EEG cap was put on the head of the participant. We placed the electrodes on the cap. The contact between the scalp and electrode was made through the insertion of gel. The impedance limit in the actiChamp i.e. EEG amplifier, was kept at 10 k $\Omega$  to minimize the noise and better quality EEG signals. Fig. 1 shows participants prepared before the experiment wearing EEG caps. Once, all electrodes showed the impedance level below 10k $\Omega$ ; we made the participant wear the eye-tracking glasses. The calibration process was performed before the start of the experiment for all the participants to ensure useful eye-tracking data. We have used the 9-point calibration to ensure good quality data. We piloted the experiment on a couple of participants by showing them the whole 60-minute recording. However, it was creating fatigue and was affecting the recording. Therefore, we have decided to cut the whole video in short snippets of 2 min, and the snippets were selected from the entire 60 min video judiciously. The video stimulus that composed of several snippets formed as a complete video of 6 min without losing any consistency was finally presented to each participant separately following the experimental protocol shown in Fig. 3. The stimulus presentation time was about 10–15 min, and the experimentation, including EEG and eye-tracking setup time, took around 45–60 min. The video snippets consisted of both activity and non-activity frames, which are generally observed in the surveillance videos. The stimulus presentation was controlled using custom Python Script created for this work. The stimulus, which is essentially 2-minute short snippets from surveillance video of a 60-minute

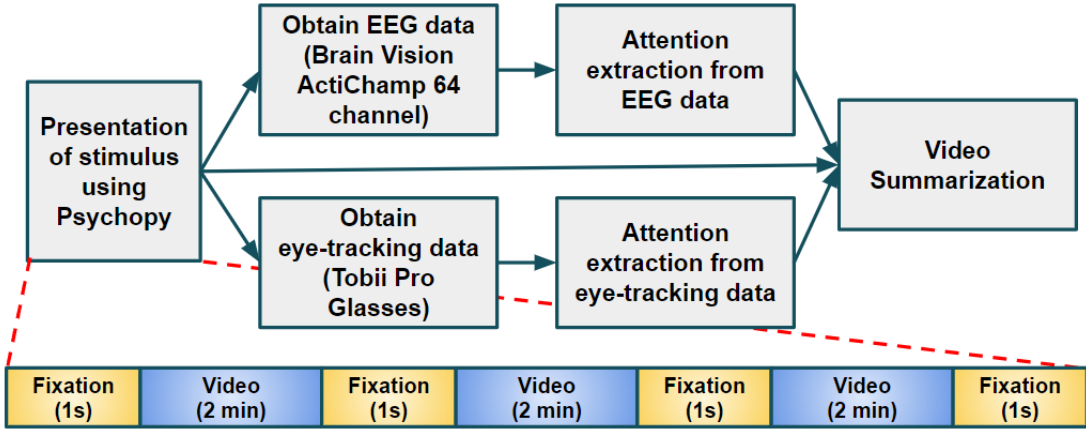

Fig. 3. Experimental design for stimulus to be presented to the participants.

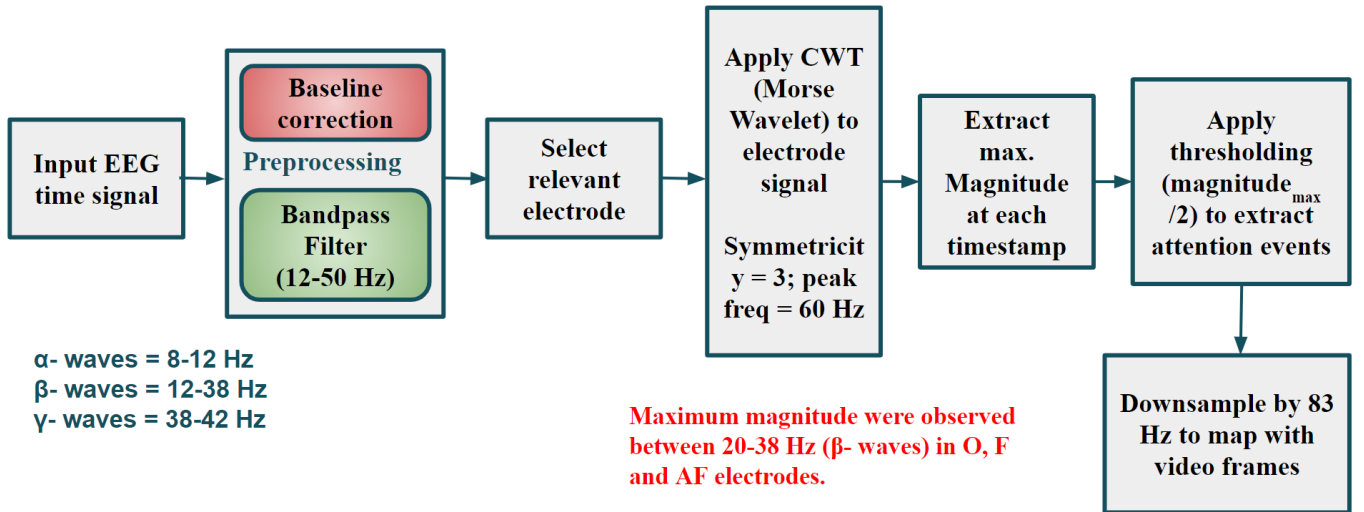

Fig. 4. Attention extraction pipeline for the acquired EEG data. The bandpass filter is determined to extract EEG signals corresponding to frequency ranges covering  $\alpha$ ,  $\beta$  and  $\gamma$  brain waves, the range of which is given in the figure [38]. The frequency of sampling for the EEG signal is 2500 Hz.

video database, is presented on the monitor via Psychopy. We have shown at least 3 2-minute video snippets to a participant. The participant was asked to carefully analyze the activities happening in the video, such as detecting suspicious persons or activities.

#### IV. PROPOSED VIDEO SUMMARIZATION FRAMEWORK

In this section, we will discuss the extraction of important frames from EEG and eye-tracking data, followed by a summarization based on these frames.

##### A. Key-frame extraction pipeline from EEG signals

Among 15 participants (9 males, 6 females), 2 participants moved a lot while observing the stimulus. This has affected the data and hence we have only considered the data of remaining 13 participants. We are more interested in knowing where do the participants focus or attend in the video (important frames according to them). Therefore, we have extracted the attention-based brain signals through a pre-processing pipeline from

the collected EEG data, as shown in Fig. 4. All the steps mentioned in the attention extraction pipeline are executed in MATLAB. The EEG data (signal from AF7 is shown in Fig. 5(a)) acquired is first pre-processed using a baseline correction to remove noise from the data and then passing the signal through a bandpass filter with a bandwidth of 12-50 Hz. The baseline correction is done via EEGLab [41]. EEGLab is an interactive MATLAB toolbox that combines independent component analysis (ICA), time/frequency analysis, artifact rejection, and event-related statistics to analyze continuous and event-related EEG, MEG, and other electrophysiological data [41]. The bandwidth is selected, such that the resulting filtered signal captures  $\alpha$ ,  $\beta$ , and  $\gamma$  waves. A continuous-wavelet-transform (CWT) is then applied to the signal from each electrode. Continuous wavelet transform provides a scheme for the interpretation of a signal,  $x(t)$  while working with a single, possibly complex-valued wavelet function,  $\psi(t)$ . The time-scale decomposition of a signal is given by:

$$S(a, b) = \frac{1}{|a|} \left| \int_{-\infty}^{\infty} x(t) \psi^* \left( \frac{t-b}{a} \right) dt \right|^2 \quad (1)$$

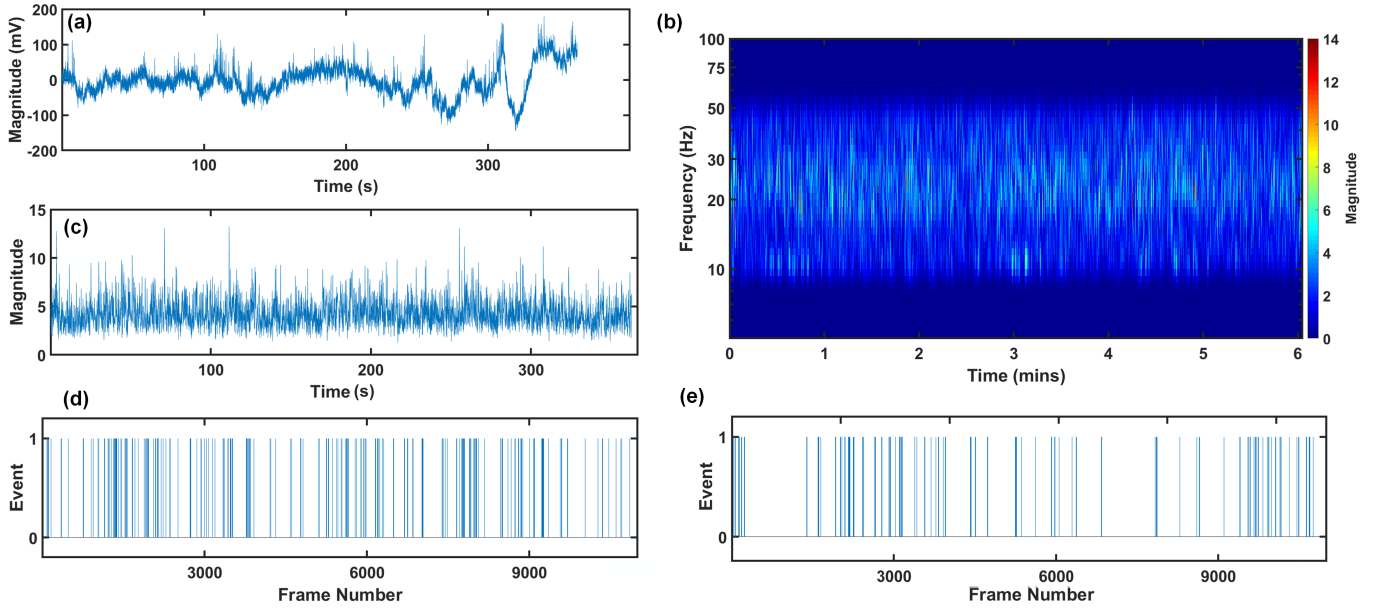

Fig. 5. (a) EEG signal data from AF7 electrode before any pre-processing is done. EEG data is acquired at sampling rate of 2500 Hz (b) CWT applied to the band passed signal after baseline correction. (c) Maximum magnitude corresponding to each time stamp in the EEG signal. (d) Extracted attention events from the EEG signal (e) Extracted attention events from the EEG signal O1. The attention events obtained here give an estimate where the anterior frontal lobe identifies important events. Other electrodes showing some significant activity includes OZ, O1 and O2 (from occipital lobe); F1–F7 (frontal lobe); Fp1 and Fp2 (Pre-frontal lobe); and, AF3, AF4 and AF8 (from anterior frontal lobe).

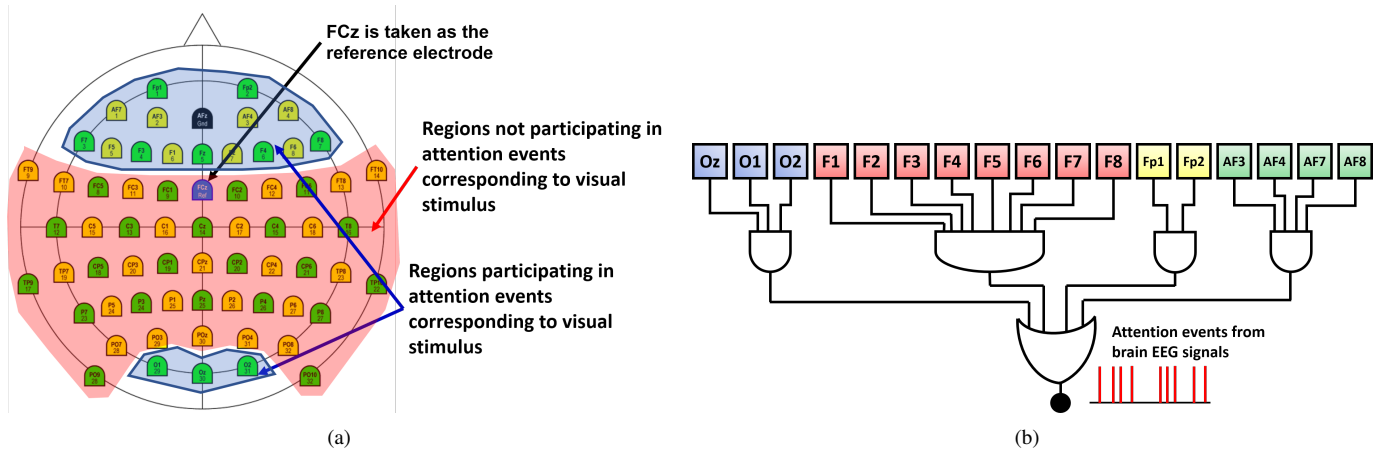

Fig. 6. (a) EEG electrodes which exhibit activities corresponding to the visual stimulus. The region shaded in blue shows the area of the brain from which attention events are extracted. The region in red did not show significant activity. (b) Overall event extraction pipeline for EEG signal analysis. Electrodes color coded in same color are clustered together as they approximately belong to one region of the brain.

which expresses the energy of the signal at any scale and time. Here,  $\psi^*(\cdot)$  denotes the complex conjugate of  $\psi(\cdot)$ . Fig. 5(b) shows CWT performed on band pass filtered signal of AF7 electrode, over the entire frequency range. For this work, we only need CWT of the signal after band pass filtering (BPF). Using CWT, we break down the signal into smaller time stamps and perform frequency transform (FT) to each timestamp. Thus, each time stamp will give the frequency and the magnitude corresponding to each frequency in that timestamp (Fig. 5(c)). After obtaining the maximum magnitude, a threshold value is selected. For our work, we have kept the threshold value to be half of the maximum magnitude in that timestamp. Now, those time stamps having magnitude more than the threshold value are considered to be

important and signifying the frames where human attention is observed. Thus, we are naming these time stamps as attention events. Now, our video is recorded at 83 fps. Therefore, the attention events are then down-sampled to 83 to map the events corresponding to the video frames. Fig. 5(d) shows the extracted attention events corresponding to the signal from AF electrode and the corresponding frames. Similarly, attention events extracted for O1 electrode as shown in Fig. 5(e). This process is followed for the electrodes from occipital and frontal regions of the brain.

After processing the EEG signals with the attention extraction pipeline, we could observe that there is some significant activities in the frontal and occipital lobe, when the participants were presented to the stimulus. Frontal lobe of

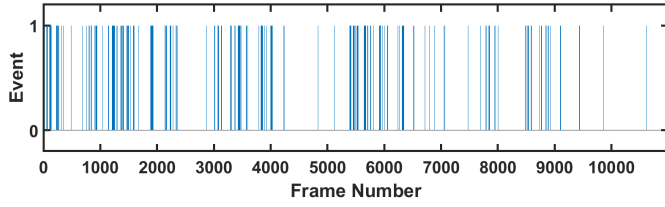

Fig. 7. The key-frames extracted from the EEG signal of a single participant obtained from the overall event extraction pipeline (as shown in Fig. 6 (b)).

the brain is often associated with decision making, reasoning and complex calculation [42]–[44]. The electrodes, which showed some activity corresponding to the visual stimulus, are highlighted in Fig. 6 (a). We consider the electrodes showing activity in these regions and cluster them based on the region to which the electrodes belong to. The illustration of the clustering of electrodes from the region of interest can be observed in 6 (b). In this illustration, we show how the overall extraction pipeline is able to come up with an cumulative attention event corresponding to the visual stimulus. We propose to use the logical AND operation on the electrodes coming from the same regions to reduce noise. However, the electrodes which are away from each other and lying in different regions also contribute to attention. Therefore, to have the combined effect of it, logical OR operation is performed between the electrode clusters from different regions of the brain (which show some activity during stimulus) to give us a overall attention event from the brain. This logical combination fetches us the final attention events. The pipeline is shown in Fig. 6 (b). The procedure of event extraction is repeated for all the participants.

Fig. 7 shows one example of extraction of attention events from the EEG signal of a single participant. Each spike in the plot shows the activation events in the brain when the video was being played for the participants. The spikes therefore corresponds to important events from the video as judged by the brain.

### B. Key-frame extraction pipeline from eye-tracking data

The eye-tracker provides the raw eye gaze information. From the eye-gazes, we need to extract eye-tracking features. There are two basic eye-tracking features viz. fixation and saccade (Fig. 8). Fast and simultaneous movement of eyes is called a saccade. It is the rapid eye movement between fixations to move the eye-gaze from one point to another. On the other hand, fixations are the points where the eyes are relatively stationary. A fixation comprises of slower and minute movements that stimulate the eye to align with the target and avoid perceptual fading. Fixations provide us an idea about the location's information processing where the eyes are relatively stable [33]. Thus, while extracting key-frames, fixations are relatively crucial as compared to the saccade. We have used the velocity threshold identification (I-VT) algorithm to obtain the eye-tracking features from the raw eye-tracking data [45].

The data is acquired from the eye-tracker at the sampling rate of 100 Hz (Fig. 10 (a)). Therefore, each timestamp (1s)

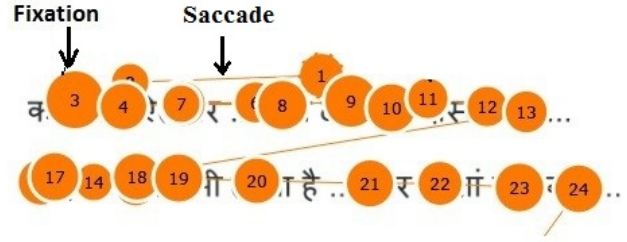

Fig. 8. The circles are Fixations and the distance between two consecutive fixations are saccades. Each fixation is numbered based on the order it was captured. The radius of the circle increases as a function of fixation duration. [34].

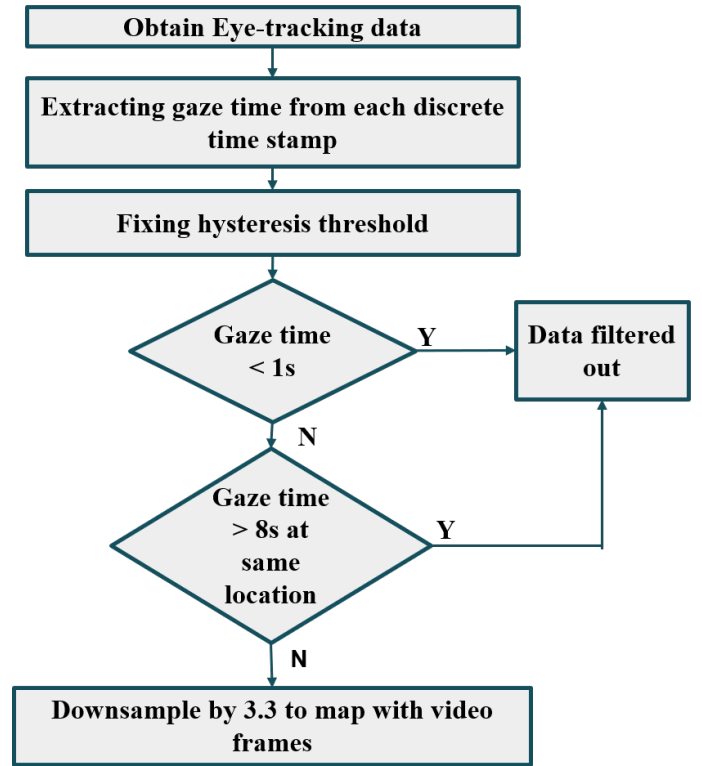

Fig. 9. Attention event extracting pipeline for data obtained from eye-tracking. The sampling time for the Tobii Pro 2 is 100 Hz.

corresponds to 100 points in the raw data obtained from the instrument. The data is then down-sampled by 3.3 to map to the video frames ((Fig. 10 (b))). A hysteresis threshold is fixed where gaze time ( $t_{gaze}$ ) less than 1000 ms (1 s) is considered as a saccade, and  $t_{gaze}$  more than 8000 ms (8 s) is considered as boredom, and the corresponding data is discarded. We have included the condition for boredom since surveillance videos tend to be sporadic in terms of events, and the subject might get bored while observing the video. Gaze time between 1s to 8s is the fixation data from which the attention events are extracted. Fig. 10 (c) shows the attention extracted output from the eye-tracking data. If we look at the attention events extracted from EEG and eye-tracking data, we can see that the events obtained are more or less the same. It is essential to understand that eye-tracking gives us more

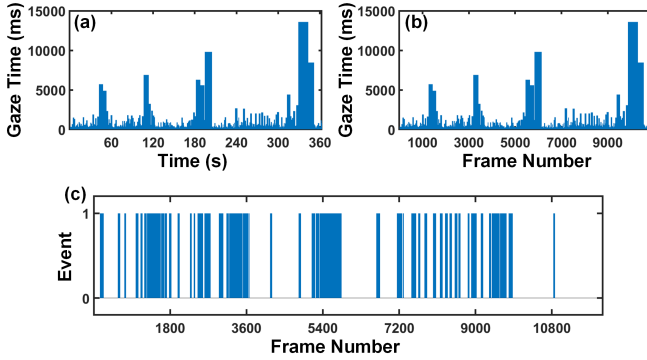

Fig. 10. (a) Eye-tracking data obtained from Tobii Pro 2. The sampling frequency is 100 Hz which is down-sampled by 3.3 Hz to map with the video frame. (b) Down-sampled data which can be mapped with the video frame. (c) Resulting attention events extracted by removing saccade and boredom data from the down-sampled data.



Fig. 11. Extracted key-frames from the 6 minute long video showing how from EEG and eye-tracking attention data we are able to summarize the video. The first frame is captured since the participant gets familiarized with the video environment in the first few seconds and thus concentrates more.

key-frames, and there might be redundant frames. The more informative frame might also trigger brain activity. Hence, if we select the frames which are commonly extracted from both EEG and eye-tracking attention pipeline, we can discard unwanted or redundant frames. Therefore, to obtain the overall attention events corresponding to both the brain and the eyes, we decided to perform a logical AND operation on the event extracted data. The resulting key-frames are shown in Fig. 11 are used for video summarization.

### C. Video Summarization

We are collecting both EEG and eye-tracking data which is acquired at a sampling frequency of 2500Hz and 100Hz respectively. Therefore, it is important to synchronized the data from both technologies to video frame rate. Thus, in this step, attention events at each timestamp are extracted from EEG and eye-tracking data processing over the entire presented video. The EEG and eye-tracking data are synchronized to video frame rate. The frames, where we observe high attention (i.e through EEG and eye-tracking data processing), are marked as key-frames (frame of interest). The collection of key-frames would furnish a refined raw video form without losing

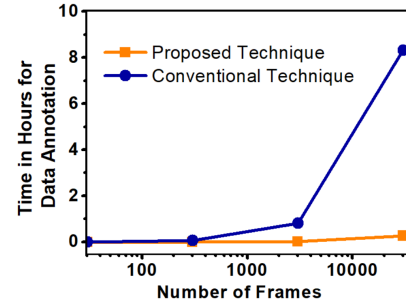

Fig. 12. Qualitative representation of merit of proposed method over conventional method, where horizontal axis represents number of frames and vertical axis time required to annotate in hours.

much information. In general, the ground truth for any task is generated by intervention of human experts. In our case, we have taken the help of expert to identify valid and invalid key-frame for summarization task. The total video is broken down into different frames and shown to the expert to classify those frames into valid and invalid.

## V. RESULTS AND DISCUSSION

### A. Advantage of using both EEG and Eye-tracking

It might be argued that why do we need to consider both the EEG and eye-tracking data. In this context, we performed an analysis where we extracted the key frames using only EEG signals, only eye-tracking signals and the proposed scheme where both EEG and eye-tracking data has been considered for video summarization. Precision and recall are two important model evaluation metrics when performing information retrieval and classification in pattern recognition processes. In principle, a high precision essentially means that the framework can extract relevant information from the given dataset. On the other hand, a high recall factor correlates the matched key-frames with the actual ground truth. In other words, how efficient it is to obtain the ground-truth (actual required key-frame). Therefore, the comparison is quantified using the following two equations:

$$Precision = \frac{N_{matched}}{N_{extracted}} \quad (2)$$

$$Recall = \frac{N_{matched}}{N_{ground-truth}} \quad (3)$$

where,  $N_{matched}$  = number of frames extracted are matching with ground-truth,  $N_{extracted}$  = number of video frames extracted by the framework under study and  $N_{groundtruth}$  = number of frames corresponding to the ground truth. As our dataset and ground truth are made by us, we have tried to compare precision where algorithm had given highest recall. The performance metrics is given in Table I. From the table we can observe that while the methodology using only EEG gives a better compression factor as compared to methodology using only eye-tracking, the ratio between the number of key-frames extracted and the number of matched key-frames is higher as compared to the proposed algorithm. Moreover, if we look at the precision, recall and F-value parameters for

the methodologies, we can observe that using only EEG for video summarization has 31% less precision and 1% less recall as compared to the proposed methodology. Although using only eye-tracking has a very high recall value, the precision is 83% less than methodology which uses both EEG and eye-tracking data for video summarization. This analysis shows that using both EEG and eye-tracking for video summarization not only yields higher precision and recall values, but also higher compression factors and better accuracy.

### B. Reduced manual efforts in ground truth generation

The conventional way of generating the ground truth is to break the total video into different frames and show those frames to the expert. The expert will use the domain knowledge and the label each frame as valid or invalid. This method of ground truth generation is applied for any task. If we assume a human expert annotate video at 1 FPS (or lower), he will take around 2 hours to annotate 1200 frames and 7-8 hours for 10000 frames. A huge amount of time is invested in labeling the video frames. Most of the videos are recorded at higher sampling rate (i.e. temporal resolution) which in turn increases the amount of frames to be labeled. To avoid the manual efforts, most of the Video summarization frameworks work on low temporal resolution i.e. the original video is downsampled by using a downsampler as a pre-processing block. When we use downsampling, the number of frames which are fed to the summarization framework will be less as compared to the original video. However, such downsampling of the data may result in the loss of key-frames and it be interpreted as loss of data [14]. Indeed, the limitation in such a case is high temporal resolution data (all video frames), which is computationally very expensive for a deep learning architecture to work on. In such scenario, the proposed approach has a distinct edge over other summarization models. In proposed framework, we show complete video to the participant and we extract the key-frames from the whole video, instead of downsampled video. One can annotate data at very high resolution with the capabilities of EEG and Eye tracking easily. There is no need of breaking the video into several frames and subsequent investigation of each frame to classify it as valid and invalid. Using our approach, expert will only see the complete video and annotation will be done using EEG and Eye-tracking signals. This approach will significantly reduce the manual efforts in annotating every video frame. The Fig. 12 qualitatively shows the merit of video annotation with our proposed method and conventional Method.

### C. Comparative Analysis

We have compared our proposed scheme with two low-level feature frameworks, Histogram [16] and Kmeans [46], and two object detection based AI (artificial intelligence) frameworks, Yolo3 and MoileNetV1 [47]. Proposed framework results shown are data received by the best of 13 participants data. For low-level feature frameworks, we have selected parameters with the highest recall. Table II shows the performance benchmarks for different frameworks considered in our paper. The compression factor mentioned in the table indicates how

TABLE I  
ABLATION STUDY DATA SHOWING THE ADVANTAGE OF USING BOTH EEG AND EYE-TRACKING IN VIDEO SUMMARIZATION

Methodology	Compression Factor	Detection Percentage
EEG	0.95	68.7
Eye-tracking (ET)	0.77	15.27
EEG + ET	0.96	98.15

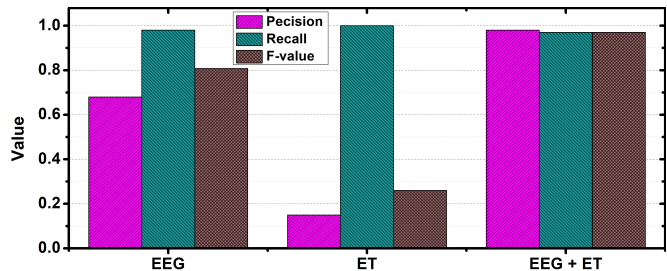

Fig. 13. Keyframe extraction benchmarks highlighting performance when considering video summarization using only EEG, only eye-tracking (ET), ground truth (GT) and using the proposed scheme where both EEG and eye-tracking is used.

much the total video dataset is compressed. From the table, we can observe that the proposed framework has the highest precision, which denotes that the algorithm returned more relevant results than irrelevant ones. We also observe that the proposed framework's recall factor is  $\sim 0.97$ , which indicates that the algorithm returned most of the relevant results. It is to be noted here that the proposed results are limited to our dataset. Since there is a balance obtained between the precision and the recall, we measure the performance of the proposed method using the F-scale values. From Fig. 14 it can be clearly observed that F-value is highest for the proposed methodology thereby signifying that it is able to extract the key-frames with better accuracy. Similarly, we also observe that the detection percentage (portion of correctly extracted key-frames) is also better for our proposed system as compared to other frameworks.

### D. Discussion

When it comes to achieve best possible performance in computer vision task, more often deep learning architectures form the first choice among researchers. However, such architectures needs more parameters resulting in increased computational complexity. Moreover, the internal functioning is very hard to understand. Humans are hardly able to understand how a system is achieving best possible performance. The proposed framework is not a deep learning-based approach; hence it requires very few parameters. Furthermore, the proposed summarization framework is easy to implement and reasoning can be easily understood as inputs from humans are involved in the design of the framework. Humans being the ultimate analyzer of the videos, input in the form of perceptually driven cues make the system explain its decision to humans and makes the system self explainable. The proposed work is one of its own kind which tries to get some cues through EEG and eye-tracking experimentation which can help in key-frame extraction. Perhaps, the proposed architecture can be looked



TABLE II  
COMPRESSION FACTOR AND DETECTION PERCENTAGE (DF)  
COMPARISON WITH OTHER FRAME WORKS.

Methodology	Compression Factor	Detection Percentage
Histogram [16]	0.2	4.40
Kmeans [46]	0.38	5.66
Tiny Yolo [47]	0.13	3.47
MobilenetV1 [47]	0.28	4.44
Proposed Method	0.96	98.15

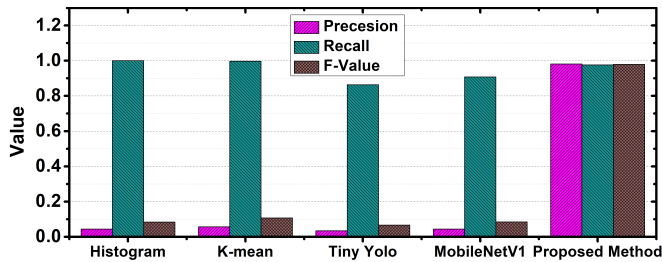

Fig. 14. Keyframe extraction benchmarks highlighting the performance of different keyframe extraction frameworks.

as a proof of concept where the cues from perceptual and attentive behavior of humans can be utilized to enhance the system’s performance. However, looking at the recent trends and volume of data, we plan to extend this idea to more deeper architectures wherein we can utilize these cues as an auxiliary input to enhance the system’s performance. Thus, artificial systems can be made more intelligent when augmented with inputs from humans.

## VI. CONCLUSION

In this work, we have proposed a video summarization framework which is inspired by visual attention and perception. The use of EEG and eye-tracking technology give us some insights about how do humans perceive, analyze and interact with the environment. We have used these technology to extract attention events which has ultimately fetched key-video frames. Using these extracted key-frames, a video is summarized by  $\sim 96.5\%$  while maintaining higher precision ( $\sim 0.98$ ) and high recall factors ( $\sim 0.97$ ). Moreover, we have analysed the effectiveness of the use of both EEG and eye-tracking for video summarization and concluded that using the proposed mechanism, we obtain high compression factor and accurate results. This work can be extended to augment the deep net based video summarization framework where the key-frames extracted using our approach can be used as supervisory input. This will not only enhance the performance but also make these architectures perceptually driven. In this way we could achieve, a human-machine collaborative video summarization framework to provide a holistic model to compress a large volume of video datasets, which is otherwise a very complicated process.

## ACKNOWLEDGEMENTS

The authors would like to thank all the participants who took part in the experiment.

## REFERENCES

- [1] B. Xu, Y. Fu, Y.-G. Jiang, B. Li, and L. Sigal, “Heterogeneous knowledge transfer in video emotion recognition, attribution and summarization,” *IEEE Transactions on Affective Computing*, vol. 9, no. 2, pp. 255–270, 2016.
- [2] M. Nasir, K. Muhammad, J. Lloret, A. K. Sangaiah, and M. Sajjad, “Fog computing enabled cost-effective distributed summarization of surveillance videos for smart cities,” *Journal of Parallel and Distributed Computing*, vol. 126, pp. 161–170, 2019.
- [3] P. K. Lai, M. Décombas, K. Moutet, and R. Laganière, “Video summarization of surveillance cameras,” in *2016 13th IEEE International Conference on Advanced Video and Signal Based Surveillance (AVSS)*. IEEE, 2016, pp. 286–294.
- [4] S. Zhang, Y. Zhu, and A. K. Roy-Chowdhury, “Context-aware surveillance video summarization,” *IEEE Transactions on Image Processing*, vol. 25, no. 11, pp. 5469–5478, 2016.
- [5] D. Potapov, M. Douze, Z. Harchaoui, and C. Schmid, “Category-specific video summarization,” in *European conference on computer vision*. Springer, 2014, pp. 540–555.
- [6] P. Mundur, Y. Rao, and Y. Yesha, “Keyframe-based video summarization using delaunay clustering,” *International Journal on Digital Libraries*, vol. 6, no. 2, pp. 219–232, 2006.
- [7] Y.-F. Ma, L. Lu, H.-J. Zhang, and M. Li, “A user attention model for video summarization,” in *Proceedings of the tenth ACM international conference on Multimedia*, 2002, pp. 533–542.
- [8] Z. Ji, K. Xiong, Y. Pang, and X. Li, “Video summarization with attention-based encoder-decoder networks,” *IEEE Transactions on Circuits and Systems for Video Technology*, 2019.
- [9] I. Mehmood, M. Sajjad, S. Rho, and S. W. Baik, “Divide-and-conquer based summarization framework for extracting affective video content,” *Neurocomputing*, vol. 174, pp. 393–403, 2016.
- [10] S. Wang, Y. Zhu, G. Wu, and Q. Ji, “Hybrid video emotional tagging using users’ eeg and video content,” *Multimedia tools and applications*, vol. 72, no. 2, pp. 1257–1283, 2014.
- [11] A. G. Money and H. Agius, “Elvis: Entertainment-led video summaries,” *ACM Transactions on Multimedia Computing, Communications, and Applications (TOMM)*, vol. 6, no. 3, p. 17, 2010.
- [12] N. Ejaz, T. B. Tariq, and S. W. Baik, “Adaptive key frame extraction for video summarization using an aggregation mechanism,” *Journal of Visual Communication and Image Representation*, vol. 23, no. 7, pp. 1031–1040, 2012.
- [13] H. Zhou, A. H. Sadka, M. R. Swash, J. Azizi, and U. A. Sadiq, “Feature extraction and clustering for dynamic video summarisation,” *Neurocomputing*, vol. 73, no. 10–12, pp. 1718–1729, 2010.
- [14] S. E. F. De Avila, A. P. B. Lopes, A. da Luz Jr, and A. de Albuquerque Araújo, “Vsumm: A mechanism designed to produce static video summaries and a novel evaluation method,” *Pattern Recognition Letters*, vol. 32, no. 1, pp. 56–68, 2011.
- [15] M. Furini, F. Geraci, M. Montanero, and M. Pellegrini, “Stimo: Still and moving video storyboard for the web scenario,” *Multimedia Tools and Applications*, vol. 46, no. 1, p. 47, 2010.
- [16] J. Almeida, N. J. Leite, and R. d. S. Torres, “Vison: Video summarization for online applications,” *Pattern Recognition Letters*, vol. 33, no. 4, pp. 397–409, 2012.
- [17] J. Martin and J. L. Crowley, “Comparison of correlation techniques,” in *Intelligent Autonomous Systems*, 1995, pp. 86–93.
- [18] H. Joho, J. M. Jose, R. Valenti, and N. Sebe, “Exploiting facial expressions for affective video summarisation,” in *Proceedings of the ACM international conference on image and video retrieval*. ACM, 2009, p. 31.
- [19] H. Katti, K. Yadati, M. Kankanhalli, and C. Tat-Seng, “Affective video summarization and story board generation using pupillary dilation and eye gaze,” in *2011 IEEE International Symposium on Multimedia*. IEEE, 2011, pp. 319–326.
- [20] M. M. Salehin and M. Paul, “Affective video events summarization using emd decomposed eeg signals (edes),” in *2017 International Conference on Digital Image Computing: Techniques and Applications (DICTA)*. IEEE, 2017, pp. 1–6.
- [21] A. Singhal, P. Kumar, R. Saini, P. P. Roy, D. P. Dogra, and B.-G. Kim, “Summarization of videos by analyzing affective state of the user through crowdsourcing,” *Cognitive Systems Research*, vol. 52, pp. 917–930, 2018.
- [22] J. Han, K. Li, L. Shao, X. Hu, S. He, L. Guo, J. Han, and T. Liu, “Video abstraction based on fmri-driven visual attention model,” *Information sciences*, vol. 281, pp. 781–796, 2014.

- [23] Y. Zhuang, Y. Rui, T. S. Huang, and S. Mehrotra, "Adaptive key frame extraction using unsupervised clustering," in *Proceedings 1998 International Conference on Image Processing. ICIP98 (Cat. No. 98CB36269)*, vol. 1. IEEE, 1998, pp. 866–870.
- [24] A. Hanjalic, R. L. Lagendijk, and J. Biemond, "A new method for key frame based video content representation," in *Image Databases and Multi-Media Search*. World Scientific, 1997, pp. 97–107.
- [25] Y. Gong and X. Liu, "Video summarization with minimal visual content redundancies," in *Proceedings 2001 International Conference on Image Processing (Cat. No. 01CH37205)*, vol. 3. IEEE, 2001, pp. 362–365.
- [26] S. E. de Avila, A. da Luz Jr, A. d. A. Araújo, and M. Cord, "Vsumm: An approach for automatic video summarization and quantitative evaluation," in *2008 XXI Brazilian Symposium on Computer Graphics and Image Processing*. IEEE, 2008, pp. 103–110.
- [27] R. R. Selvaraju, M. Cogswell, A. Das, R. Vedantam, D. Parikh, and D. Batra, "Grad-cam: Visual explanations from deep networks via gradient-based localization," in *Proceedings of the IEEE international conference on computer vision*, 2017, pp. 618–626.
- [28] A. Chattopadhyay, A. Sarkar, P. Howlader, and V. N. Balasubramanian, "Grad-cam++: Generalized gradient-based visual explanations for deep convolutional networks," in *2018 IEEE Winter Conference on Applications of Computer Vision (WACV)*. IEEE, 2018, pp. 839–847.
- [29] I. Mehmood, M. Sajjad, S. W. Baik, and S. Rho, "Audio-visual and eeg-based attention modeling for extraction of affective video content," in *2015 International Conference on Platform Technology and Service*. IEEE, 2015, pp. 17–18.
- [30] H. H. Kim and Y. H. Kim, "Video summarization using event-related potential responses to shot boundaries in real-time video watching," *Journal of the Association for Information Science and Technology*, vol. 70, no. 2, pp. 164–175, 2019.
- [31] —, "Toward a conceptual framework of key-frame extraction and storyboard display for video summarization," *Journal of the American Society for Information Science and Technology*, vol. 61, no. 5, pp. 927–939, 2010. [Online]. Available: <https://onlinelibrary.wiley.com/doi/abs/10.1002/asi.21317>
- [32] Y. H. Kim and H. H. Kim, "A video summarization study on selecting-out topic-irrelevant shots using n400 erp components in the real-time video watching," *Journal of Korea Multimedia Society*, vol. 20, no. 8, pp. 1258–1270, 2017.
- [33] K. Rayner, "Eye movements in reading and information processing: 20 years of research." *Psychological bulletin*, vol. 124, no. 3, p. 372, 1998.
- [34] C. Ralekar, T. K. Gandhi, and S. Chaudhury, "Unlocking the mechanism of devanagari letter identification using eye tracking," in *International Conference on Pattern Recognition and Machine Intelligence*. Springer, 2017, pp. 219–226.
- [35] C. Ralekar, S. Choudhary, T. K. Gandhi, and S. Chaudhury, "Intelligent identification of ornamental devanagari characters inspired by visual fixations," in *2019 International Conference on Document Analysis and Recognition Workshops (ICDARW)*, vol. 5. IEEE, 2019, pp. 14–19.
- [36] M. T. Khanna, C. Ralekar, A. Goel, S. Chaudhury, and B. Lall, "Memorability-based image compression," *IET Image Processing*, vol. 13, no. 9, pp. 1490–1501, 2019.
- [37] *EASYCAP GmbH Herrsching, Germany*. [Online]. Available: <https://www.easycap.de/>
- [38] R. Miller, "Theory of the normal waking eeg: from single neurones to waveforms in the alpha, beta and gamma frequency ranges," *International journal of psychophysiology*, vol. 64, no. 1, pp. 18–23, 2007.
- [39] R. W. Homan, J. Herman, and P. Purdy, "Cerebral location of international 10–20 system electrode placement," *Electroencephalography and clinical neurophysiology*, vol. 66, no. 4, pp. 376–382, 1987.
- [40] J. Peirce, J. R. Gray, S. Simpson, M. MacAskill, R. Höchenberger, H. Sogo, E. Kastman, and J. K. Lindeløv, "Psychopy2: Experiments in behavior made easy," *Behavior research methods*, vol. 51, no. 1, pp. 195–203, 2019.
- [41] R. of the University of California, "What is EEGLAB?" <https://scn.ucsd.edu/eeglab/index.php>, 2019, [Online; accessed 10-Aug-2019].
- [42] Y. Gil, S. Seo, and J. Lee, "Eeg analysis of frontal lobe activities by decision stimuli," in *2008 Second International Conference on Future Generation Communication and Networking*, vol. 3. IEEE, 2008, pp. 30–34.
- [43] S. P. Kyathanahally, A. Franco-Watkins, X. Zhang, V. D. Calhoun, and G. Deshpande, "A realistic framework for investigating decision making in the brain with high spatiotemporal resolution using simultaneous eeg/fmri and joint ica," *IEEE journal of biomedical and health informatics*, vol. 21, no. 3, pp. 814–825, 2016.
- [44] S. M. Alarcao and M. J. Fonseca, "Emotions recognition using eeg signals: A survey," *IEEE Transactions on Affective Computing*, vol. 10, no. 3, pp. 374–393, 2017.
- [45] D. D. Salvucci and J. H. Goldberg, "Identifying fixations and saccades in eye-tracking protocols," in *Proceedings of the 2000 symposium on Eye tracking research & applications*, 2000, pp. 71–78.
- [46] S. Jadon and M. Jasim, "Unsupervised video summarization framework using keyframe extraction and video skimming," *arXiv e-prints*, p. arXiv:1910.04792, Oct. 2019.
- [47] K. Muhammad, T. Hussain, and S. Baik, "Efficient cnn based summarization of surveillance videos for resource-constrained devices," *Pattern Recognition Letters*, 08 2018.



**Sai Sukruth Bezugam** received B.Tech degree in Electronics and Communication from Keshav Memorial Institute of Technology, Hyderabad, India in 2018. He is currently enrolled as a MS (Research) student in the Department of Electrical Engineering, Indian Institute of Technology (IIT) Delhi, India. His research interests include neuromorphic engineering and computational neuroscience applications.



**Swatilekha Majumdar** received the B.Tech degree in Electronics and Communication Engineering, the M.Tech degree in VLSI and Embedded Sytem from Indraprastha Institute of Information Technology (IIIT) Delhi, India, and the PhD degree in electronics from the Department of Electrical Engineering, Indian Institute of Technology (IIT) Delhi, India, in 2020. She is currently working as a Postdoctoral Researcher at IMEC, Belgium. Her research interests include exploiting emerging memory devices for digital, in-memory, machine learning, neuromorphic computing and computational neuroscience applications.



**Chetan Ralekar** received B.Tech in Electronics and Telecommunication Engineering and M.Tech in Electronics Engineering. He is currently enrolled as a PhD student in the Department of Electrical Engineering, Indian Institute of Technology, Delhi, India. His research interests include artificial intelligence, pattern recognition, computational perception and cognition, neuroscience.



**Tapan Kumar Gandhi** received the B.Sc. degree in physics, the M.Sc. degree in electronics, the M.Tech. degree in bioelectronics, and the Ph.D. degree in biomedical engineering from IIT Delhi, in 2001, 2003, 2006, and 2011, respectively. He is currently an Associate Professor with the Department of Electrical Engineering, IIT Delhi. Prior to joining IIT Delhi, as a Faculty Member, he was a Postdoctoral Fellow with the Massachusetts Institute of Technology (MIT), Cambridge, USA, for three years. His research interests include cognitive computation, artificial intelligence, medical instrumentation, biomedical signal and image processing, and assistive technology.