

Efficient Mining of Frequent Subgraphs with Two-Vertex Exploration

Peng Jiang
The University of Iowa
peng-jiang@uiowa.edu

Rujia Wang
Illinois Institute of Technology
rwang67@iit.edu

Bo Wu
Colorado School of Mines
bwu@mines.edu

Abstract

Frequent Subgraph Mining (FSM) is the key task in many graph mining and machine learning applications. Numerous systems have been proposed for FSM in the past decade. Although these systems show good performance for small patterns (with no more than four vertices), we found that they have difficulty in mining larger patterns. In this work, we propose a novel *two-vertex exploration* strategy to accelerate the mining process. Compared with the single-vertex exploration adopted by previous systems, our two-vertex exploration avoids the large memory consumption issue and significantly reduces the memory access overhead. We further enhance the performance through an *index-based quick pattern* technique that reduces the overhead of isomorphism checks, and a *subgraph sampling* technique that mitigates the issue of subgraph explosion. The experimental results show that our system achieves significant speedups against the state-of-the-art graph pattern mining systems and supports larger pattern mining tasks that none of the existing systems can handle.

1 Introduction

Frequent Subgraph Mining (FSM) is an important operation on graphs and is widely used in various application domains, including bioinformatics [22, 29], computer vision [11], and social network analysis [28]. The task is to discover frequently occurring subgraph patterns from an input graph. Different from graph pattern matching problems where a query pattern is given, FSM needs to find the important patterns based on a support measure and thus has a much larger exploration space.

Since the patterns of interest are unknown, most systems for FSM take an *explore-aggregate-filter* approach [10, 12, 27, 30]. The principle is to explore all the subgraphs, aggregate the subgraphs according to their patterns, and filter out the subgraphs that are redundant or are not of interest. The exploration happens in a vertex-by-vertex manner where smaller subgraphs are iteratively extended based on the connections in the graph. There are mainly two ways for exploration: breadth-first and depth-first. Starting from all vertices in the graph, breadth-first exploration stores all subgraphs of size l and extends them with one more vertex to find subgraphs of size $l + 1$. The main problem of breadth-first exploration is that the intermediate data can easily exceed the memory capacity as the subgraph size

grows. With depth-first exploration, a subgraph of size l is immediately extended to a subgraph of size $l + 1$ without seeing other subgraphs of size l . It needs not save the intermediate subgraphs and thus can explore larger patterns. However, depth-first exploration cannot exploit the *anti-monotone* property to prune the search space [12], resulting in a lot of unnecessary computation.

Some recent graph mining systems take a *pattern-based* approach [15, 17]. The idea is to enumerate the (unlabeled) subgraph patterns and then perform pattern matching on the graph. Because the pre-generated patterns guide the exploration, these systems need not store any intermediate data, and the aggregation overhead can be reduced as the topology of the subgraphs is given. However, this approach only works well for small patterns because when the pattern is larger (more than 6), listing all subgraph patterns itself becomes a hard problem [2, 19, 20]. It is also difficult for the pattern-based systems to exploit the *anti-monotone* property to prune the search space. Peregrine [15] maintains a list of frequent patterns, extend the patterns with one vertex or edge, and then re-match the extended patterns on the graph. It prunes the search space without storing the intermediate subgraphs, but the re-matching incurs a lot of redundant computation. These issues have impeded the existing graph mining systems from supporting FSM for large patterns. In fact, most of the prior work only reports experimental results for FSM with no more than 4 vertices.

To enable large pattern mining, we propose a novel *two-vertex exploration* method in this work. Our key observation is that vertex-by-vertex exploration is not necessary for pattern mining. Instead, we can perform two-vertex exploration that joins size- $(n - 2)$ subgraphs with size-3 subgraphs on a common vertex to obtain subgraphs of size- n . The new exploration method significantly accelerates the exploration process and reduces the memory access overhead in the join operation. It also allows us to exploit the anti-monotone property to prune the exploration space without storing the intermediate subgraphs or re-matching the patterns.

To further accelerate the mining process, we propose two new techniques to overcome the performance bottlenecks. One performance bottleneck is due to the expensive isomorphism checks in the aggregation step. To aggregate the subgraphs based on their patterns, we need to generate a *canonical form* for each subgraph such that the subgraphs with the same canonical form are isomorphic. Unfortunately,

the best known algorithms for generating such canonical forms have exponential complexity [7, 25, 31]. Therefore, we want to perform isomorphism check for as few subgraphs as possible. Previous work has employed a *quick pattern* technique to reduce the number of isomorphism checks [27, 30]. The main is to first group the subgraphs based on an easily computed pattern (e.g., a list of all edges). Since subgraphs in the same group must be isomorphic, only one isomorphism check is needed for each group. We improve on this idea by proposing an *index-based quick pattern* technique. It assigns an index to each pattern and uses the indices to compute a quick pattern for the joined subgraph. Compared with the quick pattern technique used in prior work, our quick pattern encodes the information of sub-patterns and achieves more accurate grouping of the subgraphs, leading to a significant reduction of isomorphism checks.

Another more fundamental challenge of mining large patterns on graphs is due to the exponential growth of the exploration space. For example, in a median size graph, MiCo [13], which has 9×10^4 vertices and 10^6 edges, there are more than 10^{12} size-5 subgraphs. When the pattern size increases to 7, the estimated number of subgraphs is in the order of 10^{17} for which exhaustive enumeration becomes infeasible. To mitigate this issue, we propose a *subgraph sampling* technique. The idea is that we sample a small subset of size-3 subgraphs for exploring larger subgraphs during the joining and/or the matching phase. Since the subgraphs of frequent patterns are more likely to be sampled, we are able to discover frequent patterns with only a small number of sampled subgraphs. Compared with previous works that apply edge or neighbor sampling to FSM [14, 18], we can discover more frequent patterns with the same or less computation. This is because subgraph samples preserve more structural information of the graph than edge samples.

We perform extensive evaluation of our system and compare with three state-of-the-art graph mining systems: AutoMine [17], Peregrine [15], and Pangolin [10]. The results show that without using sampling our system achieves 1.8x to 8.4x speedups on tasks for which the compared systems can return. By using sampling, our system can discover larger patterns that none of the existing systems can handle.

2 Background

This section introduces the graph related concepts that are important to our discussion and formally defines the frequent subgraph mining problem.

2.1 Graph Basics

A *graph* G is defined as $G = (V, E, L)$ consisting of a set of vertices V , a set of edges E and a labeling function L that assigns labels to the vertices and edges. A graph $G' = (V', E', L')$ is a *subgraph* of graph $G = (V, E, L)$ if $V' \subseteq V$, $E' \subseteq E$ and

$L'(v) = L(v), \forall v \in V'$. A subgraph $G' = (V', E', L')$ is *vertex-induced* if all the edges in E that connect the vertices in V' are included E' . A subgraph is *edge-induced* if it is connected and is not vertex-induced.

Definition 1 (Isomorphism). Two graphs $G_a = (V_a, E_a, L_a)$ and $G_b = (V_b, E_b, L_b)$ are isomorphic if there is a bijective function $f : V_a \Rightarrow V_b$ such that $(v_i, v_j) \in E_a$ if and only if $(f(v_i), f(v_j)) \in E_b$.

We say two (sub)graphs have the same *pattern* if they are isomorphic. The pattern is a template for the isomorphic subgraphs, and a subgraph is an instance (also called *embedding*) of its pattern. To determine the pattern of a subgraph, a canonical form for each subgraph can be computed, and the subgraphs with the same canonical form are isomorphic. There are various tools and algorithms available for graph isomorphism check [16, 20, 31]. All of these algorithms have exponential complexity. We use bliss [16] for isomorphism check in our system as it is fast in practice and is widely used in graph mining systems [15, 27, 30]. A related concept is *automorphism check* which checks if two subgraphs are identical, even though they might have different orderings of vertices and edges.

2.2 Frequent Subgraph Mining

The task of Frequent Subgraph Mining (FSM) is to obtain all frequent subgraph patterns from a labeled input graph. A pattern is considered frequent if it has a *support* above a threshold. While the definition of the support measure can vary across applications, the support usually needs to satisfy an *anti-monotone* property, i.e., the support of a pattern should be no greater than the support of its sub-patterns [21].

Definition 2 (MNI Support). Given a pattern $P = (V_p, E_p, L_p)$ and an input graph $G = (V, E, L)$, if P has m embeddings $\{f_1, f_2, \dots, f_m\}$ in G , the minimum image based (MNI) support of P in G is defined as

$$\sigma_{MNI}(P, G) = \min_{v \in V_p} |\{f_i(v) : i = 1, 2, \dots, m\}|.$$

Other support measures include maximum independent set based (MIS) support, minimum instance based (MI) support, and maximum vertex cover based (MVC) support. All these support measures are anti-monotone. MNI support is the most commonly used one because it has linear computation complexity while achieving a good accuracy in measuring the ‘frequency’ of patterns in a graph. The readers are referred to [21] for detailed descriptions and computation complexity of different support measures. We adopt the MNI support for our experiments, although our proposed techniques are applicable to any support measure with the anti-monotone property.

With a support measure σ , the frequent subgraph mining problem is defined as finding all patterns $\{P_i = (V_i, E_i, L_i)\}$ in a graph G such that $|V_i| = s$ and $\sigma(P_i, G) \geq t$ where s is the

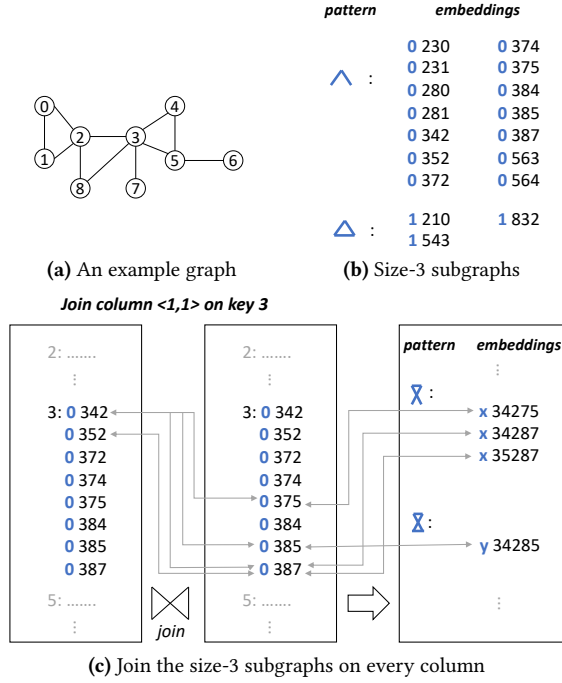

Figure 1. An example of finding size-5 subgraphs by joining size-3 subgraphs.

given pattern size and t is the given support threshold. The support can be calculated with either vertex-induced subgraphs or edge-induced subgraphs. Our proposed techniques work for both cases. We use edge-induced subgraphs for experiments, as it is the common setting in prior work [12, 15, 30].

3 Illustration of the Idea

Before getting into technical details, we describe our idea of two-vertex exploration with an example. We use an unlabeled graph for simple illustration.

Suppose our task is to discover size-5 patterns in an input graph (as shown in Figure 1a). We can first find all size-3 subgraphs and join them on a common vertex to obtain size-5 subgraphs. In this example, we first apply a matching algorithm to obtain all the embeddings of size-3 patterns (i.e., wedge and triangle) as listed in Figure 1b. Each pattern is assigned an index (0 for wedge and 1 for triangle in this example), and the index is stored with each embedding during the pattern matching.

Next, we calculate the MNI support for each size-3 pattern and prune the patterns with support less than the threshold. In this example, the supports for both wedge and triangle is 3. Suppose we set the support threshold to 3. Neither of the patterns will be pruned. After we obtain the pruned size-3 subgraphs, we perform binary join on every pair of the columns (i.e., $\langle 1, 1 \rangle$, $\langle 1, 2 \rangle$, $\langle 1, 3 \rangle$, $\langle 2, 1 \rangle$, $\langle 2, 2 \rangle$, $\langle 2, 3 \rangle$, $\langle 3, 1 \rangle$, $\langle 3, 2 \rangle$, $\langle 3, 3 \rangle$) to explore size-5 subgraphs. Figure 1c shows how we can obtain

four size-5 subgraphs by joining column $\langle 1, 1 \rangle$ on key 3. Every pair of subgraphs with key 3 are tested (i.e., $\langle '342', '342' \rangle$, $\langle '342', '352' \rangle$, ..., $\langle '387', '385' \rangle$, $\langle '387', '387' \rangle$). If two subgraphs have one and only one common vertex, they compose a valid size-5 subgraph. In this example, '342' and '375' make up a valid size-5 subgraph '34275'; '342' and '387' make up '34287'; '352' and '387' make up '35287'; and '342' and '385' make up '34285'. These valid joins are marked with connected arrows in Figure 1c. We can see that, through the join operation, we grow the pattern size from 3 to 5 in one exploration step. We will show that such two-vertex exploration is exhaustive for subgraph exploration in §4.1.

One may notice that the result of joining '374' with '385' ('37485') is not included in Figure 1c. This is because our system performs an automorphism check when generating the join results to remove redundancy. We propose a *smallest-vertex first* dissection method that ensures only the results that are obtained by joining the subgraph of the smallest spanning vertex indices are saved. In this case, the '37485' subgraph will be generated when we join the third column of '543' and the first column of '387'. More details on the automorphism check and redundancy removal are explained in §4.3.

The above procedure can be extended to explore larger subgraphs by joining multiple subgraph lists. For example, a 3-way join of two size-3 subgraphs and one size-2 subgraphs (i.e. edges) will explore all size-6 subgraphs. A 3-way join of size-3 subgraphs will explore all size-7 subgraphs. Given an input graph G , a pattern size s , and a support threshold t , the workflow of our frequent subgraph mining algorithm is summarized as follows:

Step1: Obtain all size-3 subgraphs by matching.

Step2: Calculate the support for each size-3 and size-2 pattern, and remove patterns with support smaller than t along with their subgraphs.

Step3: Perform multi-way join of size-3 subgraphs and/or edges to obtain subgraphs of size s : if $s == 2n + 1$, join n size-3 subgraph lists; if $s == 2n$, join the edge list with $n - 1$ size-3 subgraph lists.

Step4: Calculate support for each size- s patterns and remove patterns with support smaller than t .

For Step1, any matching algorithm will work; we use AutoMine [17] in our implementation. Step2 and Step4 are straightforward based on the definition of the support measure. Step3 is the most important step in the algorithm. We will detail this step in the next section.

4 Subgraph Exploration Process

All the current graph mining systems based on the explore-aggregate-filter approach use single-vertex exploration because it ensures that all the size- n subgraphs can be found by extending the size- $(n - 1)$ subgraphs with an edge. We find

that limiting the step size to 1 is not a must to find all patterns. This section describes our two-vertex exploration idea and explains its advantage over single-vertex exploration.

4.1 Two-Vertex Exploration

We propose to explore the size- n subgraphs by joining the size- $(n - 2)$ subgraphs with the size-3 subgraphs (i.e., wedges and triangles). The completeness of this two-vertex exploration method is summarized as follows.

Theorem 1. *All of the size- n subgraphs can be discovered by joining the size- $(n - 2)$ subgraphs with the size-3 subgraphs on a common vertex.*

Proof. Our goal is to show that any size- n subgraph can be dissected into a connected size- $(n - 2)$ subgraph and a connected size-3 subgraph on one vertex. Because we join all size- $(n - 2)$ and size-3 subgraphs in all possible ways, if a dissection exists for a size- n subgraph, it will be discovered by the join operation. Suppose any size- n subgraph can be dissected into a size- $(n - 2)$ and a size-3 subgraph. There are only two way a size- $(n + 1)$ subgraph can be constructed from a size- n subgraph: 1) the new vertex is connected with the size- $(n - 2)$ subgraph, and in this case, the size- $(n + 1)$ subgraph can be dissected in the same way as the size- n subgraph; 2) if the new vertex is only connected with the size-3 subgraph, it is easy to verify that for either of the two cases (wedge or triangle), we can always pick three connected vertices as the new dissection. As the base case, all the six size-4 patterns can be dissected into a size-3 subgraph and an edge. The proof finishes by induction. \square

Note that multi-vertex exploration is not complete with more than two vertices. For example, a seven-vertex three-pronged star graph with two vertices in each prong cannot be obtained by joining any two size-4 subgraphs. Therefore, we cannot explore more than two vertices in each step.

Two-vertex exploration can be either vertex-induced or edges induced. For vertex-induced exploration, we add all the connecting edges between the two joining subgraphs to the resulting subgraph. For edge-induced exploration, we enumerate all possible combinations of the connecting edges between the joining subgraphs and generate a resulting subgraph for each combination.

4.2 Depth-First Multi-Way Join of Subgraphs

To avoid the large memory consumption, we implement the exploration process as a depth-first multi-way join. Suppose we want to join t subgraph lists SL_1, SL_2, \dots, SL_t and the subgraph in SL_i has l_i vertices. For each subgraph list SL_i , we group the subgraphs by each of its l_i columns, create l_i hash tables and store the hash tables in H_i . For example, the size-3 subgraphs in Figure 1c are grouped by the vertex indices in the first column. Once the hash tables are created, the

```

// iterating over all hash tables of each subgraph list
for  $h_1 \in H_1$ 
  for  $h_2 \in H_2$ 
    for  $h_3 \in H_3$ 
      :
      // iterating over all keys in the first joining hash table
      for  $k_1 \in h_1$ 
        // iterating over all subgraphs with the key
        for  $s_1 \in h_1[k_1]$ 
          // iterating over all subgraphs with the same key in the
          // second joining hash table
          for  $t_2 \in h_2[k_1]$ 
            // combine the two subgraphs on vertex  $k_1$ 
             $s_2 = combine(s_1, t_2, k_1)$ 
            // if  $s_2$  is a valid subgraph, iterating over all its vertices
            for  $k_2 \in s_2$ 
              for  $t_3 \in h_3[k_2]$ 
                 $s_3 = combine(s_2, t_3, k_2)$ 
                :

```

Figure 2. Code of multi-way join.

multi-way join operation is simply a nested loop that iterates over all possible combinations of subgraphs in different hash tables, as shown in Figure 2. We first enumerate all possible combinations of columns in different subgraph lists by iterating over all hash tables of each subgraph list. Then, we identify the matching keys k_1 in the first two hash tables and try to combine the subgraphs (s_1 and t_2) on the key. If the two subgraphs make up a valid larger subgraph s_2 , we iterate over all the vertices of s_2 and look up each vertex k_2 in the third hash table. For every subgraph t_3 with key k_2 in the third hash table, we combine s_2 with t_3 to obtain a larger subgraph. For joining more subgraph lists, the code simply repeats the for loop.

Depth-first join is also used in Fractal [12] for single-vertex exploration. The main issue is that it incurs a huge amount of redundant memory accesses. Our two-vertex exploration mitigates this issue as it requires fewer join steps to enumerate subgraphs of a certain size. To see this, let us consider the exploration of size-5 subgraphs. With single-vertex exploration, it requires a 4-way join of the edges in the graph. The first join operation of the edge list does not incur any redundant memory accesses as each neighbor list is accessed only once in the two hash tables. However, when we join the intermediate size-3 subgraphs with the edge list, we need to query the edge list for each intermediate subgraph. For non-consecutive size-3 subgraphs of the same key, each neighbor list will be accessed multiple times during the join process. The same problem exists when joining size-4 subgraphs with the edge list. In contrast, two-vertex exploration obtains size-5 subgraphs by performing a binary join of size-3 subgraphs which incurs no redundant memory accesses. Our experimental results also validate this point.

4.3 Redundancy Removal through Smallest-Vertex-First Dissection

Combing small subgraphs in different ways can lead to identical results. As we briefly mentioned in Figure 1c, joining subgraph ‘342’ and ‘375’ generates the same subgraph as

Algorithm 1: Combine two subgraphs and check for automorphism.

Input : subgraph s ; subgraph t ; joining key k
Output: combined subgraph s'

```

1 func dissect( $s', n$ ):
2   foreach  $v$  in  $s'$  in ascending order do
3      $l$  = the first  $n$  vertices visited by starting from  $v$ 
        and spanning to the smallest vertex at each step;
4      $r'$  = the unvisited vertices in  $s'$ ;
5     foreach  $v'$  in  $l$  in ascending order do
6        $r = r' \cup v'$ ;
7       if  $r$  is connected then return  $l, r$ ;
8 if  $s$  and  $t$  have identical vertices other than  $k$  then return  $\emptyset$ ;
   //  $s'$  is a valid subgraph joined by  $s$  and  $t$ 
9  $s' = s \cup t$ ;
   // find the smallest dissection of  $s'$ 
10  $l, r = \text{dissect}(s', t.size)$ ;
   // if the two joining subgraphs correspond to the smallest
   dissection, return  $s'$ 
11 if  $l == t$  and  $r == s$  then return  $s'$ ;
12 else return  $\emptyset$ ;
```

joining ‘352’ and ‘274’. These redundant subgraphs incur redundant computation, and the redundancy can accumulate over the exploration steps. To eliminate the redundant subgraphs, we perform an automorphism check when a subgraph is generated. The previous automorphism check technique for single-vertex exploration is based on the concept of the *canonicity* of the subgraphs [27]. This canonicity check does not work for multi-vertex exploration because the small subgraphs are generated by a matching algorithm and may not have the canonicity property. We propose a *smallest-vertex-first* dissection method that enables the redundancy removal for multi-vertex exploration.

Our method is based on the following observation: for any subgraph, there is only one way to divide it into two smaller subgraphs with both subgraphs being connected and one of them having the smallest spanning vertex indices. Thus, we can eliminate redundancy by producing a subgraph s' only if the two joining subgraphs correspond to this unique dissection of s' .

The automorphism check is performed each time we combine two subgraphs (i.e., in the *combine* function in Figure 2). Algorithm 1 shows the procedure of the *combine* function. For a pair of input subgraphs s and t (t is usually a size-3 subgraph), we first check if there are any other identical vertices except for the joining vertex k . If yes, s and t cannot form a valid subgraph, and the function return an empty set. If no, we give the combined subgraph to a dissection procedure that divides the subgraph into two small subgraphs l and r . From the vertex with the smallest index, the dissection procedure finds the smallest n vertices and store them in l

where n is the size of t . Next, the algorithm checks if the remaining vertices can constitute a connected subgraph r with any of the vertices in l . If yes, the dissection procedure stops and returns l and r . The algorithm returns as soon as the first dissection is found, and it will always return because of Theorem 1. Once we have the smallest dissection l and r , we check if they are the same as t and s . If yes, the *combine* function returns the combined subgraph; otherwise, it returns an empty set.

Example: The smallest-vertex-first dissection of the subgraph ‘34257’ in Figure 1a can be obtained by spanning from vertex 2. The two adjacent vertices of 2 are 3 and 8. Because 3 is smaller, we take 3 in the first step, and the visited set contains vertex 2 and 3. The vertices that are adjacent to the two visited vertices are 4, 5, 7, 8. Because 4 is the smallest, we take 4 in the next step, and we have three vertices 2, 3, 4 in l . The unvisited vertices are 5 and 7. We check if any of 2, 3, 4 can form a connected graph with 5, 7, and we find 3 is the smallest vertex that connects 5 and 7. The algorithm stops and returns $l = \{2, 3, 4\}$ and $r = \{3, 5, 7\}$. When joining the two subgraph lists in Figure 1c, our system generates ‘34275’ (by combining ‘342’ and ‘375’) instead of ‘35274’ (by combining ‘352’ and ‘274’). For the same reason, ‘37485’ is not generated by combining ‘374’ and ‘385’ as the smallest dissection of ‘37485’ is ‘345’ and ‘387’.

The worst cases complexity of the algorithm is $O(|s'|^3)$. Although it is higher than the linear complexity of the automorphism check for single-vertex exploration [27, 30], the actual number of instructions does not increase much because s' is small and the algorithm usually returns early at line 7.

4.4 Pattern Aggregation with Index-based Quick Pattern

Next, we need to aggregate the subgraphs according to their patterns. This is done by computing the canonical form of each subgraph. The subgraphs with the same canonical form are isomorphic and will be put in the same group. As pointed out in §2, computing the canonical form is expensive, especially for large patterns. Previous work has used a quick pattern technique to reduce the canonical form computation. However, their quick patterns encode little topological information of the subgraphs, resulting in a lot of quick pattern groups of isomorphic subgraphs.

We propose an *index-based quick pattern* technique that can achieve more accurate grouping of subgraphs and reduce the overhead of canonical form computation. The idea is to assign an index to each pattern in a subgraph list and use the indices for computing the quick pattern of the combined subgraph. If a subgraph list is generated by the matching algorithm, we simply index the input patterns and store the indices with each subgraph. As shown in Figure 1b, the size-3 subgraphs are obtained by matching the two size-3

patterns. We store the *pattern_idx* with each of its embeddings. When two subgraphs are combined, we construct a 4-tuple as the quick pattern for the combined subgraph. The first two elements in the 4-tuple are the pattern indices of the two joining subgraphs. The third element represents the position of the joining vertex in the two subgraphs. Suppose the two joining subgraphs s_1 and s_2 are of size n_1 and n_2 . If the joining vertex is the i th vertex in s_1 and the j th vertex in s_2 , then the value of the third element is $(i \times n_2 + j)$. The last element is a bitarray representing connections between the two subgraphs. If the i th vertex in s_1 is connected with the j th vertex in s_2 , then the $(i \times n_2 + j)$ th bit in the bitarray is set.

Example: In Figure 1c, the resulting subgraph ‘34275’ is obtained by joining $s_1 = \text{‘342’}$ and $s_2 = \text{‘375’}$, and its quick pattern is $\langle 0, 0, 0, 32 \rangle$. The first two elements are the pattern index of ‘342’ and ‘375’. The third element is 0 because the joining vertex is at position 0 in both subgraphs. The last element is 32 because the $s_1[1] = 4$ is connected with $s_2[2] = 5$ in the graph and the $(1 \times 3 + 2)$ th bit is set in the bitarray. Similarly, the quick pattern of both ‘34287’ and ‘35287’ is $\langle 0, 0, 0, 128 \rangle$, and the quick pattern of ‘34285’ is $\langle 0, 0, 0, 272 \rangle$.

By encoding the sub-pattern information, our quick pattern achieves more accurate grouping of the subgraphs and thus reduces the canonical form computation. The computation is further reduced by multi-vertex exploration as larger subgraphs contains more accurate sub-pattern information. To see this point, let us consider the number of possible size-4 unlabeled patterns. We have known that any size-4 subgraph can be obtained by joining a size-3 subgraph and an edge. The total number of possible 4-tuples with our index-based quick pattern is $48 (= 2 \times 1 \times 6 \times 4)$ where 2 represents there are two types of size-3 subgraphs (i.e., triangle and wedge), 6 is the number of possible joining positions, and 4 is the number of possible values of the last element in the 4-tuple. In comparison, if we use the edge list as the quick pattern as in previous work [27, 30], the fully-connected size-4 graph alone has $624 (= 6! - 4 \times 4!)$ possible quick patterns where $6!$ represents all possible permutations of the six edges and $4 \times 4!$ represents the permutations that do not have adjacent edges. This indicates that our index-based technique has much fewer possible patterns compared with the technique used in previous work, leading to fewer groups for isomorphism check.

The quick pattern is computed after every *combine* function in Figure 2. If the *combine* function returns a valid subgraph, we compute its quick pattern and look for the quick pattern in a global dictionary. The dictionary keeps a mapping from quick patterns to their indices. If the quick pattern exists, we store its index with the subgraph. If a quick pattern is not found in the dictionary, we increase the global index number and insert a new pair of quick pattern and its index. In our implementation, we parallelize the for-loop that iterates over all keys in the first joining hash table. To avoid

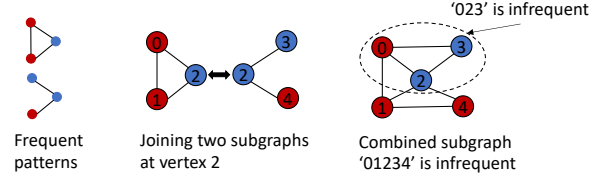

Figure 3. An example of exploration space pruning.

synchronization among threads, we store a quick pattern dictionary for each thread.

4.5 Exploration Space Pruning

An optimization that most graph mining systems adopt for frequent subgraph mining is to filter out the subgraphs of infrequent patterns so as to reduce the subgraph exploration space [10, 15, 27, 30]. All of the existing systems achieve this optimization with breadth-first exploration. They either store all intermediate subgraphs (e.g., RStream [30], Pangolin [10]) or maintain a list of frequent patterns and re-match these pattern (e.g., Peregrine [15]) in each exploration step. The problem with the first approach is that it takes a lot memory and needs to aggregate the subgraphs in each step. The problem with the second approach is that it needs to perform redundant matching in each step, and it only works for support measures that can be computed without storing all the embeddings (e.g., MNI). If the user wants to use more accurate support measures (e.g., MIS, MVC [21]), the second approach will not work. An advantage of two-vertex exploration is that it enables exploration space pruning without storing intermediate results or re-matching.

Our main idea is that, instead of checking the support of the combined pattern, we check whether the vertices around the joining point form any subgraphs of smaller infrequent patterns. If an infrequent subgraph is found, then the combined subgraph must be infrequent and should be discarded. Figure 3 shows an example of this method. When the system tries to join two subgraph ‘012’ and ‘234’ at vertex 2, it finds that there is an edge connecting vertex 0 and 3 and an edge connecting vertex 1 and 4. This forms two triangles ‘023’ and ‘124’. While triangle ‘124’ is frequent, triangle ‘023’ is not, according to the list of frequent size-3 patterns. Due to the anti-monotone property of the support measure, a frequent pattern cannot contain infrequent subpatterns. Thus, the combined subgraph ‘01234’ must be infrequent and should not be used for further exploration.

The above pruning procedure is done in the *combine* function (line 9 in Algorithm 1) when we check the connectivity among vertices of the two joining subgraphs. For any size-3 subgraph ‘abc’ with ‘a’ being the joining vertex and ‘b’, ‘c’ from different subgraphs, if the subgraph is not in the list of frequent size-3 patterns, the *combine* function returns an empty set immediately.

5 Subgraph Sampling for Faster Exploration

In real applications, we may not need to find all frequent patterns, and exhaustive exploration is unnecessary [14]. Thus, we propose a *subgraph sampling* technique to accelerate the exploration process.

Sampling during Joining: The idea is to add a sampling operation each time we iterate over the joining subgraphs, i.e., before each for-loop in the dotted boxes in Figure 2. Because the MNI support measures the frequency of a pattern as the number of distinct matching vertices, we sample a fixed number of iterations in each of the boxed for-loops in Figure 2, in order to achieve a more even distribution of subgraphs over all vertices. If a loop has fewer iterations than the sampling threshold, we execute all of them; if a loop has more iterations than the threshold, we sample the iterations uniformly to the threshold number. This subgraph sampling during the joining phase can be considered as a generalization of the *neighbor sampling* technique in ASAP [14]. ASAP samples a subset of the edges when it extends the matched subgraph from one vertex to its neighbors. We sample the neighboring size-3 subgraphs instead. Intuitively, our subgraph sampling is more accurate than neighbor sampling because size-3 subgraphs preserve more graph structures than edges.

Sampling during Matching: For very large graphs, we may not be able to store all size-3 subgraphs in memory or even on disk. To achieve fast mining, we can sample the subgraphs during the matching phase and only store the sampled subgraphs. Similar to the sampling in the joining phase, we sample a fixed number of subgraphs around each vertex in order to have subgraphs evenly distributed over all vertices. More specifically, we permute the vertex list at each inner loop of the nested for-loop generated by AutoMine [17]. The execution continues to the next iteration of the outermost loop if t subgraphs have been matched in the current iteration. This will give us t subgraphs sampled from each vertex. We set t to a number such that all the sampled subgraphs can be stored in memory. These sampled size-3 subgraphs are then given to the join procedure to explore larger subgraphs. This subgraph sampling during the matching phase can be considered as a generalization of the *edge sampling* technique for approximate graph processing [5, 33]. Previous work has shown that edge sampling does not work well for graph mining tasks [14]. Our subgraph sampling is much more robust than edge sampling for graph pattern mining as it preserves more structures of the graph. Our experiments also validate this point.

6 Experimental Results

This section presents our experimental setup and performance comparison with the existing graph mining systems and methods.

Table 1. Graph datasets

Graphs	#vertices	#edges	Description
CiteSeer (CI) [13]	3264	4536	Publication citation
MiCo (MI) [13]	100K	1.1M	Co-authorship
Orkut (OK) [3]	3.1M	117.2M	Social network
UK-2005 (UK) [1]	39M	936M	Social network
Friendster (FR) [32]	65M	1.8B	Social network

6.1 Experimental Setup

Platform: We run all the experiments on a workstation with an Intel Xeon W-3225 CPU containing 8 physical cores (16 logical cores with hyper-threading), 196GB memory, and a 4TB SSD. We use GCC 7.3.1 for compilation with optimization level O2 enabled. All the systems are configured to run with 16 threads. We use OpenMP to parallelize the for-loop that iterates over all keys in the first joining hash table.

Datasets: We test on five graphs as listed in Table 1. These graphs are commonly used for evaluating performance of graph mining systems. CiteSeer and MiCo are labeled, and the other four are unlabeled. For the unlabeled graphs, we randomly assign 30 labels to the vertices.

Settings: We compare our system with three state-of-the-art graph mining systems: Peregrine [15] and AutoMine [17] which represent the pattern-based systems, and Pangolin [10] which represents the explore-aggregate-filter systems. We run edge-induced FSM since it is more commonly evaluated by the existing graph mining systems [12, 15, 30]. The original code of AutoMine only supports vertex-induced FSM (which has much less computation than edge-induced FSM) and uses number of embeddings as the support measure (which is not anti-monotone). We adapt the code to support edge-induced FSM with MNI support, and we use it to find all size-3 subgraphs for our two-vertex exploration.

For most graphs, we set the MNI support threshold $t = 0.001n, 0.005n, 0.01n$ and $0.05n$ where n is the number of nodes in the graph. The reason we use proportional thresholds is that the MNI support measures frequency as the number of distinct vertices [21]. The threshold means that if every vertex in a pattern maps to at least t different vertices in the graph, we consider the pattern frequent. For UK and FR, because n is large, there are few patterns that can meet threshold $0.001n$. Therefore, we test with $0.0001n$ and $0.0005n$ on UK and FR.

6.2 Performance without Sampling

Since none of the compared systems supports sampling, we first run our algorithm without sampling to compare the performance. Table 2 summarizes the execution time of FSM for which at least one of the compared systems can return result within 24 hours. The execution time of our system reported here is the time of Step 2,3,4 as described in Section 3. We do not include the time for Step1 because 1) it is negligible on these two graphs (0.08 seconds on CI and 102 seconds

Table 2. Execution times in seconds. Systems: Two-Vertex exploration (TV), Peregrine (PR), AutoMine (AM) and Pangolin (PG). ‘T’ represents timeout after 24 hours of execution. ‘F’ execution failure due to insufficient memory or disk space.

Size	Support	Gr.	TV	PR	AM	PG
4-FSM	0.001	CI	0.99	5.4	5.1	5.5
	0.005		0.89	4.8		4.8
	0.01		0.81	3.4		3.7
	0.05		0.61	1.1		2.8
4-FSM	0.001	MI	41645	F	78244	F
	0.005		32763			
	0.01		29698			
	0.05		25682			
5-FSM	0.001	CI	25.2	F	68.2	F
	0.005		22.1			
	0.01		21.5			
	0.05		16.9			
6-FSM	0.001	CI	615	F	1924	F
	0.005		597			
	0.01		564			
	0.05		416			
7-FSM	0.001	CI	26760	F	63362	F
	0.005		24644			
	0.01		23697			
	0.05		16257			

on MI) compared with the joining time, and 2) Step1 can be considered as preprocessing. We find that Peregrine and Pangolin abort for most tasks. In fact, Peregrine paper [15] only reports results of 3-FSM. Pangolin [10] reports results mostly for 3-FSM. It reports 4-FSM for only one graph using large support thresholds, but it fails to give result for MI. For the only one testcase (4-FSM on CI) that Peregrine and Pangolin do return, our system is 1.8x to 5.6x faster. AutoMine is able to return results for these tasks. However, because it matches the patterns in a depth-first order, it cannot benefit from the anti-monotone property (i.e., it does not run faster for larger support thresholds). Our system is 1.9x to 8.4x faster than AutoMine for these tasks.

Advantage over Single-Vertex Exploration: As discussed in Section 4.2, one advantage of two-vertex exploration over single-vertex exploration is that it reduces the memory access overhead in depth-first multi-way join. To show the advantage, we configure our system to run single-vertex exploration. The single-vertex version still uses our index-based quick patterns, but it does not support exploration space pruning since the size-3 subgraphs are not computed. The execution times of single-vertex exploration are shown in Figure 4. We can see that single-vertex exploration is 1.02x to 1.52x slower than two-vertex exploration. We also collect the total memory access sizes to the hash tables with two-vertex exploration and single-vertex exploration (assuming every query to the hash tables is a cache miss). As shown in Figure 5, two-vertex exploration reduces the memory access overhead by 5x to 189x. The results are collected with

support threshold $0.001n$. Other support thresholds show a similar pattern.

Benefit of Index-Based Quick Pattern: To show the benefit of our index-based quick pattern technique, we disable our index-based quick pattern and use the quick pattern technique in previous work instead (i.e., a list of edges with labels of adjacent nodes). Figure 4 shows the execution times of two-vertex exploration without our index-based quick pattern. We can see that it leads to 1.75x to 2.78x slowdown. To further verify the advantage, we collect the number of invocations to the bliss function [16] for computing the canonical forms of subgraphs. As shown in Figure 6, our index-based quick pattern reduces the number of isomorphism checks by 31x to 564x for different tasks, which explains the speedups.

6.3 Performance with Sampling

Next, we evaluate the effectiveness of our sampling methods. Since all the size-3 subgraphs of CI and MI can be stored in memory, we only perform sampling during the joining phase for these two graphs.

Figure 7 shows the number of size-4 frequent patterns we can find on MI graph with different support thresholds and different sampling thresholds. The execution time of different runs are labeled on top of the bars. When the support threshold is set to $0.001n$, there are 215025 frequent patterns in total, and to discover all these patterns precisely our system needs to run for 41645 seconds (as shown in Table 2). If we sample 10 edges and 100 size-3 subgraphs in each key group when we join the edge list and the size-3 subgraphs (ST10 in the figure), our two-vertex exploration returns 49% of the frequent patterns in 671 seconds. The execution time is reduced by 62x. When the support threshold is set to $0.005n$, we can find 41% of the total frequent patterns within 524 seconds, which is 1/63 of the total execution time. When the support threshold is set to $0.05n$, there are only 8 frequent patterns, and our two-vertex exploration with ST6 sampling can find 7 of them in 58 seconds, which leads to a 443x speedup compared with the accurate execution. The figure also shows that the larger sampling thresholds we use the more frequent patterns we can find.

Figure 8 shows the number of size-7 frequent patterns found on CI graph with different support thresholds and different sampling thresholds. When the support threshold is $0.001n$, our two-vertex exploration can find 86% of the frequent patterns in 1284 seconds with ST10 sampling. Compared with the time of accurate execution in Table 2, sampling achieves a 21x speedup. When the support threshold is set to $0.005n$ and $0.01n$, there are fewer frequent patterns, and our two-vertex exploration with ST10 sampling can find more than 90% of the frequent patterns with less than 1/21 of the total execution time. When the support threshold is $0.05n$, there are only 22 frequent patterns, and our two-vertex exploration with ST6 sampling can find all of them within 170 seconds, which is 1/96 of the accurate execution time.

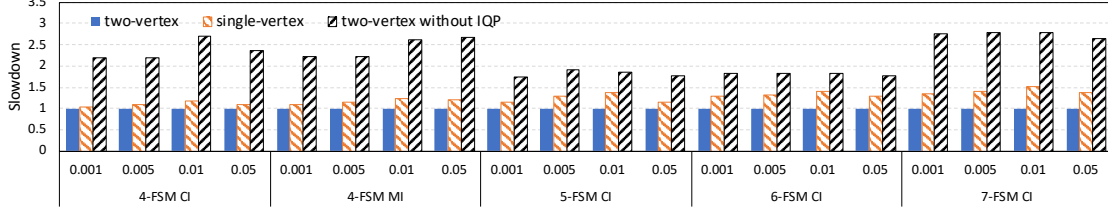

Figure 4. Performance of two-vertex exploration, single-vertex exploration, and two-vertex exploration without our index-based quick pattern. The Execution times are normalized for each task with the execution time of two-vertex exploration in Table 2.

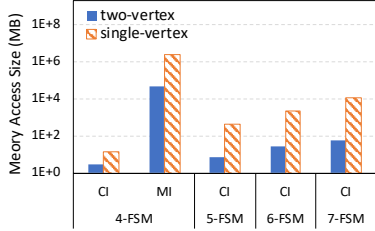

Figure 5. Total memory access size in multi-way join with two-vertex and single-vertex exploration for different FSM tasks (MNI support threshold $0.001n$).

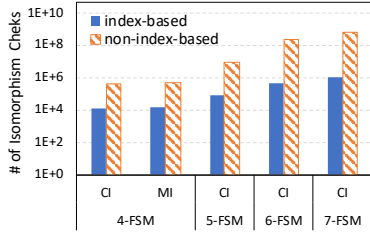

Figure 6. Number of isomorphism checks for different FSM tasks (MNI support threshold $0.001n$) with and without our index-based quick pattern technique.

Advantage over Single-Vertex Exploration: As discussed in Section 5, another advantage of two-vertex exploration over single-vertex exploration is that it leads to more accurate sampling. To verify this, we configure our system to run sampled single-vertex exploration. Since single-vertex exploration needs twice join steps as two-vertex exploration, we set its sampling threshold to the square root of the threshold for two-vertex exploration in order to achieve a similar size of overall exploration space. As shown in Figure 7 and 8, if we do not include the matching time, two-vertex exploration has a slightly shorter execution time than single-vertex exploration when they use the corresponding sampling thresholds. Even if we add the time for matching size-3 subgraphs (102 seconds on MI and 0.08 seconds on CI), the total execution time is close to that of single-vertex exploration. For 4-FSM on MI, two-vertex exploration finds 6% to 57% more frequent patterns than single-vertex exploration. For 7-FSM on CI, the number of frequent patterns found by two-vertex exploration is 1.18x to 4x that of single-vertex exploration.

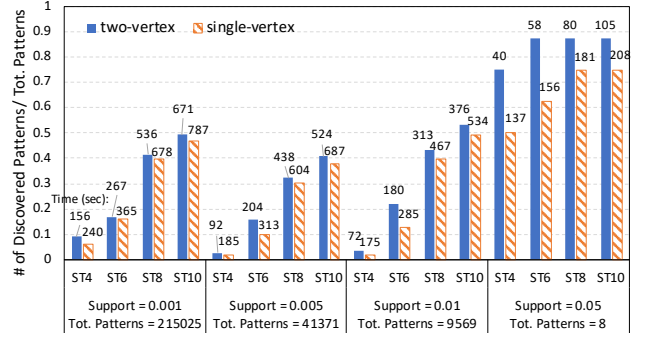

Figure 7. Number of discovered size-4 frequent patterns on MI graph with different support thresholds and different sampling thresholds. For single-vertex exploration, ST_x means in every join step only x edges are sampled in each neighbor list. For two-vertex exploration, it means that x edges and x^2 size-3 subgraphs are sampled in each key group when we join the edge list with the size-3 subgraphs.

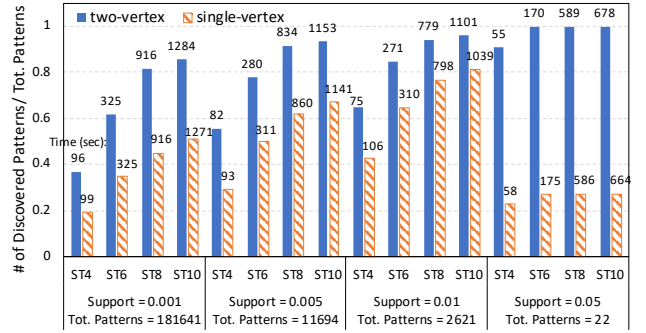

Figure 8. Number of discovered size-7 frequent patterns on CI graph with different support thresholds and different sampling thresholds. For single-vertex exploration, ST_x means in every join step only x edges are sampled in each neighbor list. For two-vertex exploration, it means that in every join step only x^2 size-3 subgraphs are sampled in each key group.

Table 3 shows the number of size-9 frequent patterns found on CI graph with different support thresholds. We can see that with a similar execution time two-vertex exploration discovers much more frequent patterns than single-vertex

Table 3. Results of 9-FSM on CI graph with sampling threshold 4 for two-vertex exploration (TV) and sampling threshold 2 for single-vertex exploration (SV).

(a) Number of discovered patterns					(b) Execution time (sec)			
Support	0.001	0.005	0.01	0.05	0.001	0.005	0.01	0.05
TV	63941	6050	1770	16	73	71	54	45
SV	402	0	0	0	75	75	63	46

Table 4. Results of 5-FSM on OK graph with support threshold $0.001n$ and different sampling thresholds. ‘M. ST’ stands for Matching Sampling Threshold, ‘M. Time’ stands for Matching Time, ‘J. ST’ stands for Joining Sampling Threshold, ‘J. Time’ stands for Joining Time.

(a) Two-vertex exploration				
M. ST	M. Time (sec)	J. ST	J. Time (sec)	# of Patterns
2	119	4	157	18
		16	168	18
4	119	4	207	20
		16	216	20
8	120	4	268	20
		16	269	20
16	122	4	299	20
		16	318	20

(b) Single-vertex exploration

J. ST	J. Time	# of Patterns
1	1184	15
2	6780	18

exploration. It is worth noting that none of the previous systems can return results for 9-FSM even on a small graph like CI. AutoMine cannot even enumerate all the size-9 unlabeled patterns in 24 hours.

Results on Large Graphs: Since the size-3 subgraphs of OK, UK and FR cannot be entirely stored in memory, we perform sampling during the matching phase and only store the sampled size-3 subgraphs. Table 4a shows the number of size-5 frequent patterns with support larger than $0.001n$ found on OK graph. In the table, a matching sampling threshold x means that x subgraphs are sampled from each vertex during the matching phase. A larger matching sampling threshold results in longer matching time, although they are not proportional – the matching time is mainly determined by the number of subgraph groups that need isomorphism checks. We find that the number of discovered patterns does not increase much with larger sampling thresholds. This is because $0.001n$ is a relatively large support threshold for this graph, and there are not many frequent patterns. To show the advantage of two-vertex exploration, we run single-vertex exploration for the same task. Since single-vertex exploration needs not match the size-3 subgraphs, we only perform sampling during the joining phase with threshold 1 and 2. The results are shown in Table 4b. We can see that single-vertex exploration takes a longer time and finds fewer patterns.

Table 5. Results of 5-FSM on UK and FR graph with different sampling thresholds and support thresholds. ‘M. ST’ stands for Matching Sampling Threshold, ‘M. Time’ stands for Matching Time, ‘J. ST’ stands for Joining Sampling Threshold, ‘J. Time’ stands for Joining Time.

(a) Two-vertex exploration on UK					
Support	M. ST	M. Time (sec)	J. ST	J. Time (sec)	# of Patterns
0.0001	2	2254	4	140	76
			16	288	143
	4	2530	4	185	105
			16	505	188
0.0005	2	2254	4	105	1
			16	235	3
	4	2530	4	138	8
			16	421	14

(b) Two-vertex exploration on FR

Support	M. ST	M. Time (sec)	J. ST	J. Time (sec)	# of Patterns
0.0001	2	6010	4	499	1
			16	7620	1
	4	6657	4	547	4
			16	9955	8
0.0005	2	6010	4	315	1
			16	4637	1
	4	6657	4	377	1
			16	5417	1

The results of 5-FSM on UK and FR graph are shown in Table 5. We can see that matching takes a large proportion of the total execution time. This is because there are a lot of size-3 subgraphs and patterns in these two large graphs. However, if we consider matching as preprocessing and store the sampled size-3 subgraphs in memory, the joining procedure is fast. As shown in Table 5a, our system can find frequent patterns on UK within a few minutes, and more patterns can be found by using larger joining sampling thresholds. Table 5b shows the results of 5-FSM on FR graph. Again, the matching procedure is expensive. Once the size-3 subgraph are sampled, we can find size-5 frequent patterns in a relatively short time with sampled join. For comparison, we also run single-vertex exploration with sampling threshold 2 on these two graphs. It cannot finish execution within 24 hours, so we print out the found patterns after 24 hours of execution. For UK, it returns 5 frequent patterns when support threshold is set to $0.0001n$, and 0 frequent pattern when support threshold is $0.0005n$. For FR, single-vertex exploration with sampling threshold 2 cannot return any frequent pattern within 24 hours.

7 Related Work

This section summarizes the graph pattern mining systems that are most related to our work.

Exploration-based Systems: Arabesque [27] is a distributed graph pattern mining system. It enumerates all possible embeddings in multiple rounds and uses a filter-process model to generate the results. It first propose the quick pattern technique for reducing isomorphism checks. RStream [30] is

the first single-machine, out-of-core graph mining system. It supports a rich programming model that exposes relational algebra for developers to express various mining tasks and a runtime engine that can efficiently compute the relational operations. Pangolin [10] also targets single-machine but provides GPU programming interface for acceleration. DistGraph [26], ScaleMine [4] and G-miner [8] are all distributed graph mining systems that adopt breadth-first exploration. DistGraph focuses on reducing the communication of distributed computing when each node can only have a portion of the graph. ScaleMine proposes a two-phase mining approach to achieve good load balance and reduce communication in distributed computing. G-miner proposes a block-based graph partitioning technique and uses work stealing to achieve good load balance. Because these systems use breadth-first exploration and need to store all intermediate results, they are not able to mine large patterns on large graphs. Fractal [12] is also exploration-based, but it supports depth-first exploration to reduce the memory consumption. All of the existing systems adopt single-vertex exploration. Our system is the first to adopt multi-vertex exploration for mining larger pattern in graphs.

Pattern-based Systems: AutoMine [17] is a single-machine graph mining system that features compiler-based optimizations. Their main idea is to enumerate all the unlabeled patterns of a particular size and match them one-by-one on a graph. Because the patterns are given, AutoMine is able to search an optimal matching strategy and combine the matching procedures of multiple patterns. Because of its depth-first matching order, AutoMine is hard to benefit from the anti-monotone property of FSM. Also, when the pattern size is more than 7, enumerating the patterns becomes difficult. Peregrine [15] is another pattern-based system. Instead of enumerating all the patterns before matching, it discovers patterns based on the subgraphs it has explored and maintains a list of the patterns. The main issue with Peregrine is that it needs to rematch the frequent patterns in each step, which leads to redundant computation. DwavesGraph [9] is a recently proposed pattern-based graph mining system. It is based on the idea that the task of matching a large pattern can be divided into smaller tasks of matching the subpatterns. Similar to AutoMine, it needs to know all the unlabeled patterns in advance. Thus, it cannot discover large patterns. In fact, DwavesGraph paper only reports result for 3-FSM.

Approximate Pattern Mining: Sampling has been proposed by earlier works [6, 24] to accelerate FSM in a database of graphs. In this setting, a pattern is considered frequent if it exists in more than a certain amount of graphs. The main idea of these works is to perform random walk in the space of all patterns. Every time it walks from one pattern to another, it calculates a probability distribution of all candidate patterns. By carefully setting the sampling probability at each step, they ensure that patterns of higher supports are more likely to be sampled [6]. More recent works consider FSM on

a single graph since it is more commonly used in real applications and is more general (a list of graphs can be considered as a single graph with disconnected components) [13]. Sampling has also proposed to accelerate pattern-based graph mining in this setting [14, 18, 23]. The main idea is to sample edges in the graph based on the given patterns and estimate the actual results with the sampled results. These methods need to know the patterns in advance. It is not obvious how they can be applied to the exploration-based systems. We fill this gap and show that FSM can be accelerated by sampling the subgraphs in each key group of the join operation.

8 Conclusion

In this work, we propose a novel two-vertex exploration method to accelerate frequent subgraph mining. Based on two-vertex exploration, we further improve the performance through an index-based quick pattern technique and subgraph sampling. The experiments show that our method outperforms other state-of-the-art graph mining systems for FSM on various input graphs and pattern sizes.

References

- [1] [n.d.]. Dataset for "Statistics and Social Network of YouTube Videos" . <http://netsg.cs.sfu.ca/youtubedata/>.
- [2] [n.d.]. Number of Graphs on n unlabelled vertices. <http://garsia.math.yorku.ca/~zabrocki/math3260w03/nall.html>.
- [3] [n.d.]. Orkut social network. <http://snap.stanford.edu/data/com-Orkut.html>.
- [4] Ehab Abdelhamid, Ibrahim Abdelaziz, Panos Kalnis, Zuhair Khayyat, and Fuad Jamour. 2016. Scalemine: Scalable parallel frequent subgraph mining in a single large graph. In *SC'16: Proceedings of the International Conference for High Performance Computing, Networking, Storage and Analysis*. IEEE, 716–727.
- [5] Sameer Agarwal, Barzan Mozafari, Aurojit Panda, Henry Milner, Samuel Madden, and Ion Stoica. 2013. BlinkDB: queries with bounded errors and bounded response times on very large data. In *Proceedings of the 8th ACM European Conference on Computer Systems*. 29–42.
- [6] Mohammad Al Hasan and Mohammed J Zaki. 2009. Output space sampling for graph patterns. *Proceedings of the VLDB Endowment* 2, 1 (2009), 730–741.
- [7] László Babai, William M Kantor, and Eugene M Luks. 1983. Computational complexity and the classification of finite simple groups. In *24th Annual Symposium on Foundations of Computer Science (Sfcs 1983)*. IEEE, 162–171.
- [8] Hongzhi Chen, Miao Liu, Yunjian Zhao, Xiao Yan, Da Yan, and James Cheng. 2018. G-Miner: an efficient task-oriented graph mining system. In *Proceedings of the Thirteenth EuroSys Conference*. 1–12.
- [9] Jingji Chen and Xuehai Qian. 2020. DwarvesGraph: A High-Performance Graph Mining System with Pattern Decomposition. arXiv:2008.09682 [cs.DC]
- [10] Xuhao Chen, Roshan Dathathri, Gurbinder Gill, and Keshav Pingali. 2020. Pangolin: An Efficient and Flexible Graph Mining System on CPU and GPU. *Proc. VLDB Endow.* 13, 8 (April 2020), 1190–1205. <https://doi.org/10.14778/3389133.3389137>
- [11] Wei-Ta Chu and Ming-Hung Tsai. 2012. Visual Pattern Discovery for Architecture Image Classification and Product Image Search. In *Proceedings of the 2nd ACM International Conference on Multimedia Retrieval (Hong Kong, China) (ICMR '12)*. Association for Computing Machinery, New York, NY, USA, Article 27, 8 pages. <https://doi.org/10.1145/2324796.2324831>

- [12] Vinicius Dias, Carlos H. C. Teixeira, Dorgival Guedes, Wagner Meira, and Srinivasan Parthasarathy. 2019. Fractal: A General-Purpose Graph Pattern Mining System. In *Proceedings of the 2019 International Conference on Management of Data (Amsterdam, Netherlands) (SIGMOD '19)*. Association for Computing Machinery, New York, NY, USA, 1357–1374. <https://doi.org/10.1145/3299869.3319875>
- [13] Mohammed Elseidy, Ehab Abdelhamid, Spiros Skiadopoulos, and Panos Kalnis. 2014. GraMi: Frequent Subgraph and Pattern Mining in a Single Large Graph. *Proc. VLDB Endow.* 7, 7 (March 2014), 517–528. <https://doi.org/10.14778/2732286.2732289>
- [14] Anand Padmanabha Iyer, Zaoxing Liu, Xin Jin, Shivaram Venkataraman, Vladimir Braverman, and Ion Stoica. 2018. ASAP: Fast, Approximate Graph Pattern Mining at Scale. In *13th USENIX Symposium on Operating Systems Design and Implementation (OSDI 18)*. USENIX Association, Carlsbad, CA, 745–761. <https://www.usenix.org/conference/osdi18/presentation/iyer>
- [15] Kasra Jamshidi, Rakesh Mahadasa, and Keval Vora. 2020. Peregrine: A Pattern-Aware Graph Mining System. In *Proceedings of the Fifteenth European Conference on Computer Systems (Heraklion, Greece) (EuroSys '20)*. Association for Computing Machinery, New York, NY, USA, Article 13, 16 pages. <https://doi.org/10.1145/3342195.3387548>
- [16] Tommi Junttila and Petteri Kaski. 2007. Engineering an efficient canonical labeling tool for large and sparse graphs. In *Proceedings of the Ninth Workshop on Algorithm Engineering and Experiments and the Fourth Workshop on Analytic Algorithms and Combinatorics*, David Applegate, Gerth Støltting Brodal, Daniel Panario, and Robert Sedgewick (Eds.). SIAM, 135–149.
- [17] Daniel Mawhirter and Bo Wu. 2019. AutoMine: Harmonizing High-Level Abstraction and High Performance for Graph Mining. In *Proceedings of the 27th ACM Symposium on Operating Systems Principles (Huntsville, Ontario, Canada) (SOSP '19)*. Association for Computing Machinery, New York, NY, USA, 509–523. <https://doi.org/10.1145/3341301.3359633>
- [18] Daniel Mawhirter, Bo Wu, Dinesh Mehta, and Chao Ai. 2018. Approxg: Fast approximate parallel graphlet counting through accuracy control. In *2018 18th IEEE/ACM International Symposium on Cluster, Cloud and Grid Computing (CCGRID)*. IEEE, 533–542.
- [19] Brendan McKay and Adolfo Piperno. [n.d.]. nauty and Traces. <http://users.cecs.anu.edu.au/~bdm/nauty/>.
- [20] Brendan D McKay et al. 1981. *Practical graph isomorphism*. Department of Computer Science, Vanderbilt University Tennessee, USA.
- [21] Jinghan Meng and Yi-cheng Tu. 2017. Flexible and Feasible Support Measures for Mining Frequent Patterns in Large Labeled Graphs. In *Proceedings of the 2017 ACM International Conference on Management of Data (Chicago, Illinois, USA) (SIGMOD '17)*. Association for Computing Machinery, New York, NY, USA, 391–402. <https://doi.org/10.1145/3035918.3035936>
- [22] Ron Milo, Shai Shen-Orr, Shalev Itzkovitz, Nadav Kashtan, Dmitri Chklovskii, and Uri Alon. 2002. Network motifs: simple building blocks of complex networks. *Science* 298, 5594 (2002), 824–827.
- [23] Aduri Pavan, Srikanta Tirthapura, et al. 2013. Counting and sampling triangles from a graph stream. (2013).
- [24] Tanay Kumar Saha and Mohammad Al Hasan. 2015. FS3: A sampling based method for top-k frequent subgraph mining. *Statistical Analysis and Data Mining: The ASA Data Science Journal* 8, 4 (2015), 245–261.
- [25] Haichuan Shang, Ying Zhang, Xuemin Lin, and Jeffrey Xu Yu. 2008. Taming Verification Hardness: An Efficient Algorithm for Testing Subgraph Isomorphism. *Proc. VLDB Endow.* 1, 1 (Aug. 2008), 364–375. <https://doi.org/10.14778/1453856.1453899>
- [26] Nilothpal Talukder and Mohammed J Zaki. 2016. A distributed approach for graph mining in massive networks. *Data Mining and Knowledge Discovery* 30, 5 (2016), 1024–1052.
- [27] Carlos HC Teixeira, Alexandre J Fonseca, Marco Serafini, Georgos Siganos, Mohammed J Zaki, and Ashraf Aboulnaga. 2015. Arabesque: a system for distributed graph mining. In *Proceedings of the 25th Symposium on Operating Systems Principles*. 425–440.
- [28] Johan Ugander, Lars Backstrom, and Jon Kleinberg. 2013. Subgraph Frequencies: Mapping the Empirical and Extremal Geography of Large Graph Collections. In *Proceedings of the 22nd International Conference on World Wide Web (Rio de Janeiro, Brazil) (WWW '13)*. Association for Computing Machinery, New York, NY, USA, 1307–1318. <https://doi.org/10.1145/2488388.2488502>
- [29] A Vazquez, R Dobrin, D Sergi, J-P Eckmann, Zoltan N Oltvai, and A-L Barabási. 2004. The topological relationship between the large-scale attributes and local interaction patterns of complex networks. *Proceedings of the National Academy of Sciences* 101, 52 (2004), 17940–17945.
- [30] Kai Wang, Zhiqiang Zuo, John Thorpe, Tien Quang Nguyen, and Guoqing Harry Xu. 2018. Rstream: Marrying relational algebra with streaming for efficient graph mining on a single machine. In *13th USENIX Symposium on Operating Systems Design and Implementation (OSDI 18)*. 763–782.
- [31] Xifeng Yan and Jiawei Han. 2002. gSpan: graph-based substructure pattern mining. In *2002 IEEE International Conference on Data Mining, 2002. Proceedings.* 721–724.
- [32] Jaewon Yang and Jure Leskovec. 2015. Defining and evaluating network communities based on ground-truth. *Knowledge and Information Systems* 42, 1 (2015), 181–213.
- [33] Ruoyu Zou and Lawrence B Holder. 2010. Frequent subgraph mining on a single large graph using sampling techniques. In *Proceedings of the eighth workshop on mining and learning with graphs*. 171–178.