

---

# Meta Learning Backpropagation And Improving It

---

Louis Kirsch<sup>1</sup>, Jürgen Schmidhuber<sup>1,2</sup>

<sup>1</sup>The Swiss AI Lab IDSIA, University of Lugano (USI) & SUPSI, Lugano, Switzerland

<sup>2</sup>King Abdullah University of Science and Technology (KAUST), Thuwal, Saudi Arabia  
{louis, juergen}@idsia.ch

## Abstract

Many concepts have been proposed for meta learning with neural networks (NNs), e.g., NNs that learn to reprogram fast weights, Hebbian plasticity, learned learning rules, and meta recurrent NNs. Our *Variable Shared Meta Learning (VSML)* unifies the above and demonstrates that simple weight-sharing and sparsity in an NN is sufficient to express powerful learning algorithms (LAs) in a reusable fashion. A simple implementation of VSML where the weights of a neural network are replaced by tiny LSTMs allows for implementing the backpropagation LA solely by running in forward-mode. It can even meta learn new LAs that differ from online backpropagation and generalize to datasets outside of the meta training distribution without explicit gradient calculation. Introspection reveals that our meta learned LAs learn through fast association in a way that is qualitatively different from gradient descent.

## 1 Introduction

The shift from standard machine learning to meta learning involves learning the learning algorithm (LA) itself, reducing the burden on the human designer to craft useful learning algorithms [43]. Recent meta learning has primarily focused on generalization from training tasks to similar test tasks, e.g., few-shot learning [11], or from training environments to similar test environments [17]. This contrasts human-engineered LAs that generalize across a wide range of datasets or environments. Without such generalization, meta learned LAs can not entirely replace human-engineered variants. Recent work demonstrated that meta learning can also successfully generate more general LAs that generalize across wide spectra of environments [20, 1, 31], e.g., from toy environments to Mujoco and Atari. Unfortunately, however, many recent approaches still rely on a large number of human-designed and unmodifiable inner-loop components such as backpropagation.

Is it possible to implement modifiable versions of backpropagation or related algorithms as part of the end-to-end differentiable activation dynamics of a neural net (NN), instead of inserting them as separate fixed routines? Here we propose the Variable Shared Meta Learning (VSML) principle for this purpose. It introduces a novel way of using sparsity and weight-sharing in NNs for meta learning. We build on the arguably simplest neural meta learner, the meta recurrent neural network (Meta RNN) [16, 10, 56], by replacing the weights of a neural network with tiny LSTMs. The resulting system can be viewed as many RNNs passing messages to each other, or as one big RNN with a sparse shared weight matrix, or as a system learning each neuron's functionality and its LA. VSML generalizes the principle behind end-to-end differentiable fast weight programmers [45, 46, 3, 41], hyper networks [14], learned learning rules [4, 13, 33], and hebbian-like synaptic plasticity [44, 46, 25, 26, 30]. Our mechanism, VSML, can implement backpropagation solely in the forward-dynamics of an RNN. Consequently, it enables meta-optimization of backprop-like algorithms. We envision a future where novel methods of credit assignment can be meta learned while still generalizing across vastly different tasks. This may lead to improvements in sample

efficiency, memory efficiency, continual learning, and others. As a first step, our system meta learns online LAs from scratch that frequently learn faster than gradient descent and generalize to datasets outside of the meta training distribution (e.g., from MNIST to Fashion MNIST). VSML is the first neural meta learner without hard-coded backpropagation that shows such strong generalization.

## 2 Background

Deep learning-based meta learning that does not rely on fixed gradient descent in the inner loop has historically fallen into two categories, 1) Learnable weight update mechanisms that allow for changing the parameters of an NN to implement a learning rule (FWPs / LLRs), and 2) Learning algorithms implemented in black-box models such as recurrent neural networks (Meta RNNs).

**Fast weight programmers & Learned learning rules (FWPs / LLRs)** In a standard NN, the weights are updated by a fixed LA. This framework can be extended to meta learning by defining an explicit architecture that allows for modifying these weights. This weight-update architecture augments a standard NN architecture. NNs that generate or change the weights of another or the same NN are known as fast weight programmers (FWPs) [44, 45, 46, 3, 41], hypernetworks [14], NNs with synaptic plasticity [25, 26, 30] or learned learning rules [4, 13, 33]. Often these architectures make use of local Hebbian-like update rules or outer-products, and we summarize this category as FWPs / LLRs. In FWPs / LLRs the variables  $V_L$  that are subject to learning are the weights of the network, whereas the meta-variables  $V_M$  that implement the LA are defined by the weight-update architecture. Note that the dimensionality of  $V_L$  and  $V_M$  can be defined independently of each other and often  $V_M$  are reused in a coordinate-wise fashion for  $V_L$  resulting in  $|V_L| \gg |V_M|$ , where  $|\cdot|$  is the number of elements.

**Black-box learning in activations (Meta RNNs)** It was shown that an RNN such as LSTM can learn to implement an LA [16] when the reward or error is given as an input [47]. After meta training, the LA is encoded in the weights of this RNN and determines learning during meta testing. The activations serve as the memory used for the LA solution. We refer to this as Meta RNNs [16, 10, 56] (Also sometimes referred to as memory-based meta learning.). They are conceptually simpler than FWPs / LLRs as no additional weight-update rules with many degrees of freedom need to be defined. In Meta RNNs  $V_L$  are the RNN activations and  $V_M$  are the parameters for the RNN. Note that an RNN with  $N$  neurons will yield  $|V_L| = O(N)$  and  $|V_M| = O(N^2)$  [46]. This means that the LA is largely overparameterized whereas the available memory for learning is very small, making this approach prone to overfitting [20]. As a result, the RNN parameters often encode task-specific solutions instead of generic LAs. Meta learning a simple and generalizing LA would benefit from  $|V_L| \gg |V_M|$ . Previous approaches have tried to mend this issue by adding architectural complexity through additional memory mechanisms [53, 29, 40, 27, 42].

## 3 Variable Shared Meta Learning (VSML)

In VSML we build on the simplicity of Meta RNNs while retaining  $|V_L| \gg |V_M|$  from FWPs / LLRs. We do this by reusing the same few parameters  $V_M$  many times in an RNN (via variable sharing) and introducing sparsity in the connectivity. This yields several interpretations for VSML:

- Ⓐ **VSML as a single Meta RNN with a sparse shared weight matrix (Figure 1a).** The most general description.
- Ⓑ **VSML as message passing between RNNs (Figure 1b).** We choose a simple sharing and sparsity scheme for the weight matrix such that it corresponds to multiple RNNs with shared parameters that exchange information.
- Ⓒ **VSML as complex neurons with learned updates (Figure 1c).** When choosing a specific connectivity between RNNs, states / activations  $V_L$  of these RNNs can be interpreted as the weights of a conventional NN, consequently blurring the distinction between a weight and an activation.

**Introducing variable sharing to Meta RNNs** We begin by formalizing Meta RNNs which often use multiplicative gates such as the LSTM [12, 15] or its variant GRU [6]. For notational simplicity,

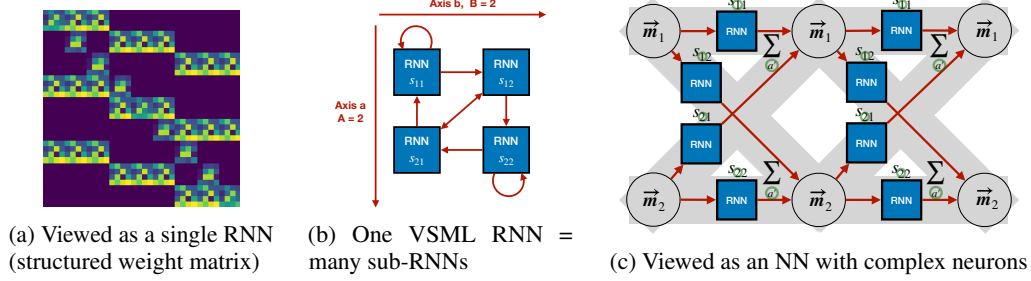

Figure 1: Different perspectives on VSML: (a) A single Meta RNN [16] where entries in the weight matrix are shared or zero. (b) VSML consists of many sub-RNNs with shared parameters  $V_M$  passing messages between each other. (c) VSML implements an NN with complex neurons (here 2 neurons).  $V_M$  determines the nature of weights, how these are used in the neural computation, and the LA by which those are updated. Each weight  $w_{ab} \in \mathbb{R}$  is represented by the multi-dimensional RNN state  $s_{ab} \in \mathbb{R}^N$ . Neuron activations correspond to messages  $\vec{m}$  passed between sub-RNNs.

we consider a vanilla RNN. Let  $s \in \mathbb{R}^N$  be the hidden state of an RNN. The update for an element  $j \in \{1, \dots, N\}$  is given by

$$s_j \leftarrow f_{\text{RNN}}(s)_j = \sigma\left(\sum_i s_i W_{ij}\right), \quad (1)$$

where  $\sigma$  is a non-linear activation function,  $W \in \mathbb{R}^{N \times N}$ , and the bias is omitted for simplicity. We also omit inputs by assuming a subset of  $s$  to be externally provided. Each application of Equation 1 reflects a single time tick in the RNN.

We now introduce variable sharing (reusing  $W$ ) into the RNN by duplicating the computation along two axes of size  $A, B$  (here  $A = B$ , which will later be relaxed) giving  $s \in \mathbb{R}^{A \times B \times N}$ . For  $a \in \{1, \dots, A\}, b \in \{1, \dots, B\}$  we have

$$s_{abj} \leftarrow f_{\text{RNN}}(s_{ab})_j = \sigma\left(\sum_i s_{abi} W_{ij}\right). \quad (2)$$

This can be viewed as multiple RNNs arranged on a 2-dimensional grid, with shared parameters that update independent states. Here, we chose a particular arrangement (two axes) that will facilitate the interpretation   of RNNs as weights.

**VSML as message passing between RNNs** The computation so far describes  $A \cdot B$  independent RNNs. We connect those by passing messages (interpretation  )

$$s_{ab} \leftarrow f_{\text{RNN}}(s_{ab}, \vec{m}_a), \quad (3)$$

where the message  $\vec{m}_b = \sum_{a'} f_{\vec{m}}(s_{a'b})$  with  $b \in \{1, \dots, A = B\}$ ,  $f_{\vec{m}} : \mathbb{R}^N \rightarrow \mathbb{R}^{N'}$  is fed as an additional input to each RNN. This is related to Graph Neural Networks [51, 58]. Summing over the axis  $A$  (elements  $a'$ ) corresponds to an RNN connectivity mimicking those of weights in an NN (to facilitate interpretation  ). We emphasise that other schemes based on different kinds of message passing and graph connectivity are possible. For a simple  $f_{\vec{m}}$  defined by the matrix  $C \in \mathbb{R}^{N \times N}$ , we may equivalently write

$$s_{abj} \leftarrow \sigma\left(\sum_i s_{abi} W_{ij} + \sum_{a'} f_{\vec{m}}(s_{a'a})_j\right) = \sigma\left(\sum_i s_{abi} W_{ij} + \sum_{a', i} s_{a'ai} C_{ij}\right). \quad (4)$$

This constitutes the minimal version of VSML with  $V_M := (W, C)$  and is visualized in Figure 1b.

**VSML as a Meta RNN with a sparse shared weight matrix** It is trivial to see that with  $A = 1$  and  $B = 1$  we obtain a single RNN and Equation 4 recovers the original Meta RNN Equation 1. In the general case, we can derive an equivalent formulation that corresponds to a single standard RNN with a single matrix  $\tilde{W}$  that has entries of zero and shared entries

$$s_{abj} \leftarrow \sigma\left(\sum_{c,d,i} s_{cdi} \tilde{W}_{cdiabj}\right), \quad (5)$$

where the six axes can be flattened to obtain the two axes. For Equation 4 and Equation 5 to be equivalent,  $\tilde{W}$  must satisfy (derivation in Appendix A)

$$\tilde{W}_{cdiabj} = \begin{cases} C_{ij}, & \text{if } d = a \wedge (d \neq b \vee c \neq a). \\ W_{ij}, & \text{if } d \neq a \wedge d = b \wedge c = a. \\ C_{ij} + W_{ij}, & \text{if } d = a \wedge d = b \wedge c = a. \\ 0, & \text{otherwise.} \end{cases} \quad (6)$$

This corresponds to interpretation (A) with the weight matrix visualized in Figure 1a. To distinguish between the single sparse shared RNN and the connected RNNs, we now call the latter *sub-RNNs*.

**VSML as complex neurons with learned updates** The arrangement and connectivity of the sub-RNNs as described in the previous paragraphs corresponds to that of weights in a standard NN. Thus, in interpretation (C), VSML can be viewed as defining complex neurons where each sub-RNN corresponds to a weight in a standard NN as visualized in Figure 1c. All these sub-RNNs share the same parameters but have distinct states. The current formulation corresponds to a single NN layer that is run recurrently. We will generalize this to other architectures in the next section.  $A$  corresponds to the dimensionality of the inputs and  $B$  to that of the outputs in that layer.

The role of weights in a standard neural network is now assigned to the states of RNNs. This allows these RNNs to define both the neural forward computation as well as the learning algorithm that determines how the network is updated (where the mechanism is shared across the network). In the case of backpropagation, this would correspond to the forward and backward passes being implemented purely in the recurrent dynamics. We will demonstrate the practical feasibility of this in Section 3.2. The emergence of RNN states as weights quickly leads to confusing terminology when RNNs have ‘meta weights’. Instead, we simply refer to meta variables  $V_M$  and learned variables  $V_L$ .

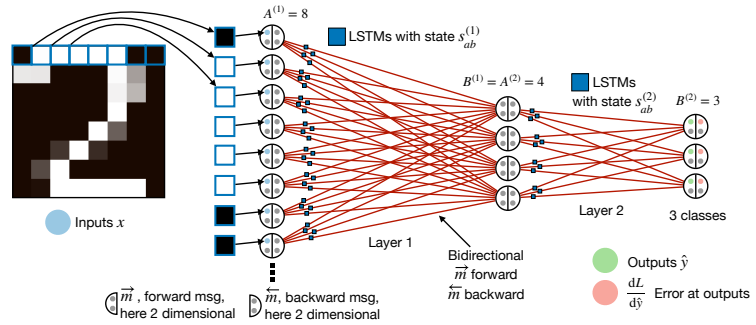

Figure 2: The neural interpretation of VSML replaces all weights of a standard NN with tiny LSTMs using shared parameters (resembling complex neurons). This allows these LSTMs to define both the neural forward computation as well as the learning algorithm that determines how the network is updated. Information flows forward and backward in the network through multi-dimensional messages  $\vec{m}$  and  $\overleftarrow{m}$ , generalizing the dynamics of an NN trained using backpropagation.

With this interpretation, VSML can be seen as a generalization of learned learning rules [4, 13, 33] and Hebbian-like differentiable mechanisms or fast weights more generally [44, 46, 25, 26] where RNNs replace explicit weight updates. In standard NNs, weights and activations have multiplicative interactions. For VSML RNNs to mimic such computation we require multiplicative interactions between parts of the state  $s$ . Fortunately, LSTMs already incorporate this through gating and can be directly used in place of RNNs.

**Stacking VSML RNNs and feeding inputs** To get a structure similar to one of the non-recurrent deep feed-forward architectures (FNNs), we stack multiple VSML RNNs where their states are untied and their parameters are tied.<sup>1</sup> This is visualized with two layers in Figure 2 where the states  $s^{(2)}$  of the second column of sub-RNNs are distinct from the first column  $s^{(1)}$ . The parameters  $A^{(k)}$  and  $B^{(k)}$  describing layer sizes can then be varied for each layer  $k \in \{1, \dots, K\}$  constrained by  $A^{(k)} = B^{(k-1)}$ . The updated Equation 3 with distinct layers  $k$  is given by  $s_{ab}^{(k)} \leftarrow f_{\text{RNN}}(s_{ab}^{(k)}, \vec{m}_a^{(k)})$  where  $\vec{m}_b^{(k+1)} := \sum_{a'} f_{\vec{m}}(s_{a'b}^{(k)})$  with  $b \in \{1, \dots, B^{(k)} = A^{(k+1)}\}$ .

<sup>1</sup>The resultant architecture as a whole is still recurrent. Note that even standard FNNs are recurrent if the LA (backpropagation) is taken into account.

To prevent information from flowing only forward in the network, we use an additional backward message

$$s_{ab}^{(k)} \leftarrow f_{RNN}(s_{ab}^{(k)}, \vec{m}_a^{(k)}, \overleftarrow{m}_b^{(k)}), \quad (7)$$

where  $\overleftarrow{m}_a^{(k-1)} := \sum_{b'} f_{\overleftarrow{m}}(s_{ab'})^{(k)}$  with  $a \in \{1, \dots, A^{(k)} = B^{(k-1)}\}$  (visualized in Figure 3). The backward transformation is given by  $f_{\overleftarrow{m}}: \mathbb{R}^N \rightarrow \mathbb{R}^{N''}$ .

Similarly, other neural architectures can be explicitly constructed (e.g. convolutional NNs, Section B.2). Some architectures may be learned implicitly if positional information is fed into each sub-RNN (Appendix C). We then update all states  $s^{(k)}$  in sequence  $1, \dots, K$  to mimic sequential layer execution. We may also apply multiple RNN ticks for each layer  $k$ .

To provide the VSML RNN with data, each time we execute the operations of the first layer, a single new datum  $x \in \mathbb{R}^{A(1)}$  (e.g. one flattened image) is distributed across all sub-RNNs. In our present experiments, we match the axis  $A(1)$  to the input datum dimensionality such that each dimension (e.g., pixel) is fed to different RNNs. This corresponds to initializing the forward message  $\vec{m}_{a1}^{(1)} := x_a$  (padding  $\vec{m}$  with zeros if necessary). Similarly, we read the output  $\hat{y} \in \mathbb{R}^{B(K)}$  from  $\hat{y}_a := \vec{m}_{a1}^{(K+1)}$ . Finally, we feed the error  $e \in \mathbb{R}^{B(K)}$  at the output such that  $\overleftarrow{m}_{b1}^{(K)} := e_b$ . See Figure 2 for a visualization. Alternatively, multiple input or output dimensions could be patched together and fed into fewer sub-RNNs.

### 3.1 Meta learning general-purpose learning algorithms from scratch

Having formalized VSML, we can now use end-to-end meta learning to create LAs from scratch in Algorithm 1. We simply optimize the LSTM parameters  $V_M$  to minimize the sum of prediction losses over many time steps starting with random states  $V_L := \{s_{ab}^{(k)}\}$ . We focus on meta learning online LAs where one example is fed at a time as done in Meta RNNs [16, 56, 10]. Meta training may be performed using end-to-end gradient descent or gradient-free optimization such as evolutionary strategies [57, 38]. The latter is significantly more efficient on VSML compared to standard NNs due to the small parameter space  $V_M$ . Crucially, during meta testing, no explicit gradient descent is used.

---

#### Algorithm 1 VSML: Meta Training

---

**Require:** Dataset(s)  $D = \{(x_i, y_i)\}$

$V_M \leftarrow$  initialize LSTM parameters

**while** meta loss has not converged **do**

$V_L = \{s_{ab}^{(k)}\} \leftarrow$  initialize LSTM states  $\forall a, b, k$

**for**  $(x, y) \in \{(x_1, y_1), \dots, (x_T, y_T)\} \subset D$  **do**

$\vec{m}_{a1}^{(1)} := x_a \quad \forall a$

**for**  $k \in \{1, \dots, K\}$  **do**

$s_{ab}^{(k)} \leftarrow f_{RNN}(s_{ab}^{(k)}, \vec{m}_a^{(k)}, \overleftarrow{m}_b^{(k)}) \quad \forall a, b$

$\vec{m}_b^{(k+1)} := \sum_{a'} f_{\vec{m}}(s_{a'b})^{(k)} \quad \forall b$

$\overleftarrow{m}_a^{(k-1)} := \sum_{b'} f_{\overleftarrow{m}}(s_{ab'})^{(k)} \quad \forall a$

$\hat{y}_a := \vec{m}_{a1}^{(K+1)} \quad \forall a$

$e := \nabla_{\hat{y}} L(\hat{y}, y)$

$\overleftarrow{m}_{b1}^{(K)} := e_b \quad \forall b$

$V_M \leftarrow V_M - \alpha \nabla_{V_M} \sum_{t=1}^T L(\hat{y}(t), y(t))$ , obtaining  $\nabla_{V_M}$  either by

- back-propagation through the inner loop
  - evolution strategies, using a search distribution  $p(V_M)$
- 

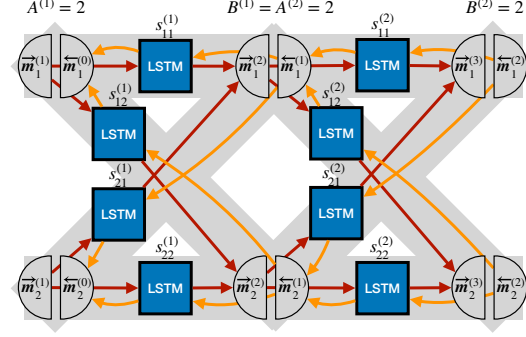

Figure 3: VSML with forward messages  $\vec{m}$  and backward messages  $\overleftarrow{m}$  to form a two-layer NN with shared LSTM parameters but distinct states.

### 3.2 Learning to implement backpropagation in RNNs

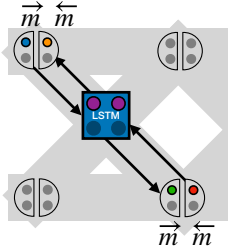

Figure 4: To implement backpropagation we optimize the VSML RNN to use and update weights  $w$  and biases  $b$  as part of the state  $s_{ab}$  in each sub-RNN. Inputs are pre-synaptic  $x$  and error  $e$ . Outputs are post-synaptic  $\hat{y}$  and error  $\hat{e}'$ .

An alternative to end-to-end meta learning is to first investigate whether the VSML RNN can implement backpropagation. Due to the algorithm’s ubiquitous use, it seems desirable to be able to meta learn backpropagation-like algorithms. Here we investigate how VSML RNNs can learn to implement backpropagation purely in their recurrent dynamics. We do this by optimizing  $V_M$  to (1) store a weight  $w$  and bias  $b$  as a subset of each state  $s_{ab}$ , (2) compute  $y = \tanh(x)w + b$  to implement neural forward computation, and (3) update  $w$  and  $b$  according to the backpropagation algorithm [23]. We call this process *learning algorithm cloning* and it is visualized in Figure 4.

We designate an element of each message  $\vec{m}_a^{(k)}$ ,  $\overleftarrow{m}_b^{(k)}$ ,  $f_{\vec{m}}(s_{ab}^{(k)})$ ,  $f_{\overleftarrow{m}}(s_{ab}^{(k)})$  as the input  $x$ , error  $e$ , and output  $\hat{y}$  and error  $\hat{e}'$ . Similarly, we set  $w := s_{ab1}$  and  $b := s_{ab2}$ . We then optimize  $V_M$  via gradient descent to regress  $\hat{y}$ ,  $\Delta w$ ,  $\Delta b$ , and  $\hat{e}'$  toward their respective targets. We can either generate the training dataset  $D := \{(x, w, b, y, e, e')_i\}$  randomly or run a ‘shadow’ NN on some supervised problem and fit the VSML RNN to its activations and parameter updates. Multiple iterations in the VSML RNN would then correspond to evaluating the network and updating it via backpropagation. The activations from the forward pass necessary for credit assignment could be memorized as part of the state  $s$  or be explicitly stored and fed back. For simplicity, we chose the latter to clone backpropagation. We continuously run the VSML RNN forward, alternately running the layers in order  $1, \dots, K$  and in reverse order  $K, \dots, 1$ .<sup>2</sup>

## 4 Experiments

First, we demonstrate the capabilities of the VSML RNN by showing that it can implement neural forward computation and backpropagation in its recurrent dynamics on the *MNIST* [21] and *Fashion MNIST* [59] dataset. Then, we show how we can meta learn an LA from scratch on one set of datasets and then successfully apply it to another (out of distribution). Such generalization is enabled by extensive variable sharing where we have very few meta variables  $|V_M| \approx 2,400$  and many learned variables  $|V_L| \approx 257,200$ . We also investigate the robustness of the discovered LA. Finally, we introspect the meta learned LA and compare it to gradient descent.

Our implementation uses LSTMs and the message interpretation from Equation 7. Hyperparameters, training details, and additional experiments can be found in the appendix.

### 4.1 VSML RNNs can implement backpropagation

As described in Section 3.2, we optimize the VSML RNN to implement backpropagation. We structure the sub-RNNs to mimic a feed-forward NN with either one hidden layer or no hidden layers. To obtain training targets, we instantiate a standard NN, the shadow network, and feed it MNIST data. After cloning, we then run the LA encoded in the VSML RNN on the MNIST and Fashion MNIST dataset and observe that it performs learning purely in its recurrent dynamics, making explicit gradient calculations unnecessary. Figure 5 shows the learning curve on these two datasets. Notably,

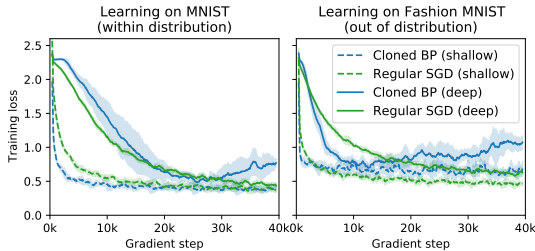

Figure 5: The VSML RNN is optimized to implement backpropagation in its recurrent dynamics on MNIST, then tested both on MNIST and Fashion MNIST where it performs learning purely by unrolling the LSTM. We test on shallow and deep architectures (single hidden layer of 32 units). Standard deviations are over 6 seeds.

<sup>2</sup>Executing layers in reverse order is not strictly necessary as information always also flows backwards through  $\overleftarrow{m}$  but makes LA cloning easier.

learning works both on MNIST (within distribution) and on Fashion MNIST (out of distribution). We observe that the loss is decently minimized, albeit regular gradient descent still outperforms our cloned backpropagation. This may be due to non-zero errors during learning algorithm cloning, in particular when these errors accumulate in the deeper architecture. It is also possible that the VSML states (‘weights’) deviate too far from ranges seen during cloning, in particular in the deep case when the loss starts increasing. We obtain 87% (deep) and 90% (shallow) test accuracy on MNIST and 76% (deep) and 80% (shallow) on Fashion MNIST (focusing on successful cloning over performance).

## 4.2 Meta learning supervised learning from scratch

In the previous experiments, we have established that VSML is expressive enough to meta-optimize backpropagation-like algorithms. Instead of cloning an LA, we now meta learn from scratch as described in Section 3.1. Here, we use a single layer ( $K = 1$ ) from input to output dimension and run it for two ticks per image with  $N = 16$  and  $N' = N'' = 8$ . First, the VSML RNN is meta trained end-to-end using evolutionary strategies (ES) [38] on MNIST to minimize the sum of cross-entropies over 500 data points starting from random state initializations. As each image is unique and  $V_M$  can not memorize the data, we are implicitly optimizing the VSML RNN to generalize to future inputs given all inputs it has seen so far. We do not pre-train  $V_M$  with a human-engineered LA.

During meta testing on MNIST (Figure 6) we plot the cumulative accuracy on all previous inputs on the y axis ( $\frac{1}{T} \sum_{t=1}^T c_t$  after example  $T$  with binary  $c_t$  indicating prediction correctness). For each example, the prediction when this example was fed to the RNN is used, thus measuring sample efficient learning. This evaluation protocol is similar to the one used in Meta RNNs [56, 10]. We observe that learning is considerably faster compared to the baseline of online gradient descent (no mini batching, the learning rate appropriately tuned). One possibility is that VSML simply overfits to the training distribution. We reject this possibility by meta testing the same unmodified RNN on a different dataset, here Fashion MNIST. Learning still works well, meaning we have meta learned a fairly general LA (although performance at convergence still lacks behind a little). This generalization is achieved without using any hardcoded gradients during meta testing purely by running the RNN forward. In comparison to VSML, a Meta RNN heavily overfits.

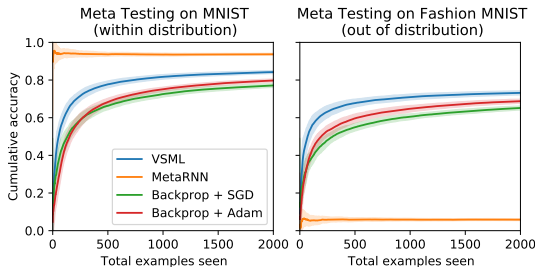

Figure 6: The VSML RNN can be directly meta trained on MNIST to minimize the sum of errors when classifying online starting from a random state initialization. This allows for faster learning during meta testing compared to online gradient descent with Adam on the same dataset and even generalizes to a different dataset (Fashion MNIST). In comparison, a standard Meta RNN [16] strongly overfits in the same setting. Standard deviations are over 128 seeds.

## 4.3 Robustness to varying inputs and outputs

A defining property of VSML is that the same parameters  $V_M$  can be used to learn on varying input and output sizes. Further, the architecture and thus the meta learned LA is invariant to the order of inputs and outputs. In this experiment, we investigate how robust we are to such changes. We meta train across MNIST with 3, 4, 6, and 7 classes. Likewise, we train across rescaled versions with 14x14, 28x28, and 32x32 pixels. We also randomly project all inputs using a linear transformation, with the transformation fixed for all inner learning steps. In Figure 7 we meta test on 6 configurations that were not seen

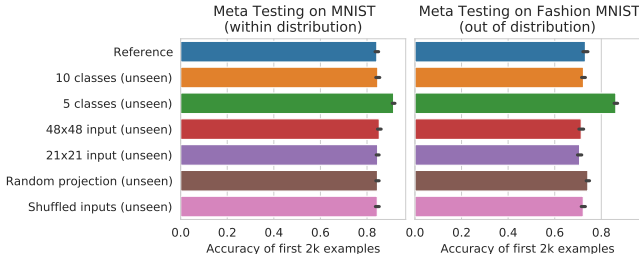

Figure 7: The meta learned learning algorithm is robust to permutations and size changes in the inputs and outputs. All six configurations have not been seen during training and perform comparable to the unchanged reference. Standard deviations are over 32 seeds.

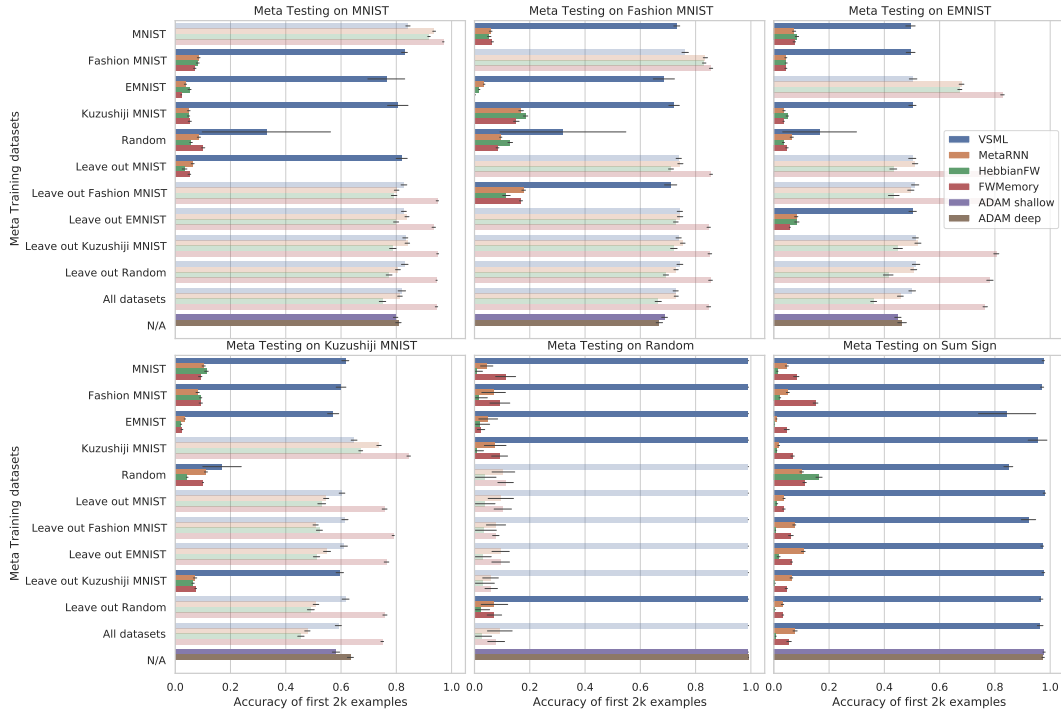

Figure 8: Online learning on various datasets. Cumulative accuracy in % after having seen 2k training examples evaluated after each prediction starting with random states (VSML, Meta RNN, HebbianFW, FWMemory) or random parameters (SGD). Standard deviations are over 32 meta test training runs. Meta testing is done on the official test set of each dataset. Meta training is on subsets of datasets excluding the Sum Sign dataset. Unseen tasks, most relevant from a general-purpose LA perspective, are opaque.

during meta training. Performance on all of these configurations is comparable to the unchanged reference from the previous section. In particular, the invariance to random projections suggests that we have meta learned a learning algorithm beyond transferring learned representations [compare 11, 54, 55].

#### 4.4 Varying datasets

To better understand how different meta training distributions and meta test datasets affect VSML RNNs and our baselines, we present several different combinations in Figure 8. The opaque bars represent tasks that were not seen during meta training and are thus most relevant for this analysis. This includes four additional datasets: (1) *Kuzushiji MNIST* [7] with 10 classes, (2) *EMNIST* [9] with 62 classes, (3) A randomly generated classification dataset (*Random*) with 20 data points that changes with each step in the outer loop, and (4) *Sum Sign* which generates random inputs and requires classifying the sign of the sum of all inputs. Meta training is done over 500 randomly drawn samples per outer iteration. Each algorithm is meta trained for 10k outer iterations. Inputs are randomly projected as in Section 4.3 (for VSML; the baselines did not benefit from these augmentations). We again report the cumulative accuracy on all data seen since the beginning of meta test training. We compare to SGD with a single layer, matching the architecture of VSML, and a hidden layer, matching the number of weights to the size of  $V_L$  in VSML. We also have included a Hebbian fast weight baseline [25] and an external (fast weight) memory approach [42].

We observe that VSML generalizes much better than Meta RNNs, Hebbian fast weights, and the external memory. These baselines overfit to the training environments. Notably, VSML even generalizes to the unseen tasks *Random* and *Sum Sign* which have no shared structure with the other datasets. In many cases VSML’s performance is similar to SGD but a little more sample efficient in the beginning of training (learning curves in Appendix B). This suggests that our meta learned LAs are good at quickly associating new inputs with their labels. We further investigate this in the next Section 5.



## 5 Analysis

Given that VSML seems to learn faster than online gradient descent in many cases we would like to qualitatively investigate how learning differs. We first meta train on the full MNIST dataset as before. During meta testing, we plot the output probabilities for each digit against the number of samples seen in Figure 9. We highlight the ground truth input class  $\square$  as well as the predicted class  $\circ$ . In this case, our meta test dataset consists of MNIST digits with two examples of each type. The same digit is always repeated twice. This allows us to observe and visualize the effect with only a few examples. We have done the same introspection with the full dataset in Appendix B.

We observe that in VSML almost all failed predictions are followed by the correct prediction with high certainty. In contrast, SGD

makes many incorrect predictions and fails to adapt correctly in only 20 steps. It seems that SGD learns qualitatively different from VSML. The VSML RNN meta learns to quickly associate new inputs with their class whereas SGD fails to do so. We tried several different SGD learning rates and considered multiple steps on the same input. In both cases, SGD does not behave similar to VSML, either learning much slower or forgetting previous examples. As evident from high accuracies in Figure 8, VSML does not only memorize inputs using this strategy of fast association, but the associations generalize to future unseen inputs.

## 6 Related Work

**Memory based meta learning (Meta RNNs)** Memory-based meta learning in RNNs [16, 10, 56] is a simple neural meta learner (see Section 2). Unfortunately, the LA encoded in the RNN parameters is largely overparameterized which leads to overfitting. VSML demonstrates that weight sharing can address this issue resulting in more general-purpose LAs.

**Learned Learning Rules / Fast Weights** NNs that generate or change the weights of another or the same NN are known as fast weight programmers [44], hypernetworks [14], NNs with synaptic plasticity [25] or learned learning rules [4] (see Section 2). In VSML we do not require explicit architectures for weight updates as weights are emergent from RNN state updates. In addition to the learning rule, we implicitly learn how the neural forward computation is defined. Concurrent to this work, fast weights have also been used to meta learn more general LAs [39].

**Learned gradient-based optimizers** Meta learning has been used to find optimizers that update the parameters of a model by taking the loss and gradient with respect to these parameters as an input [34, 2, 22, 24]. In this work, we are interested in meta learning that does not rely on fixed gradient calculation in the inner loop.

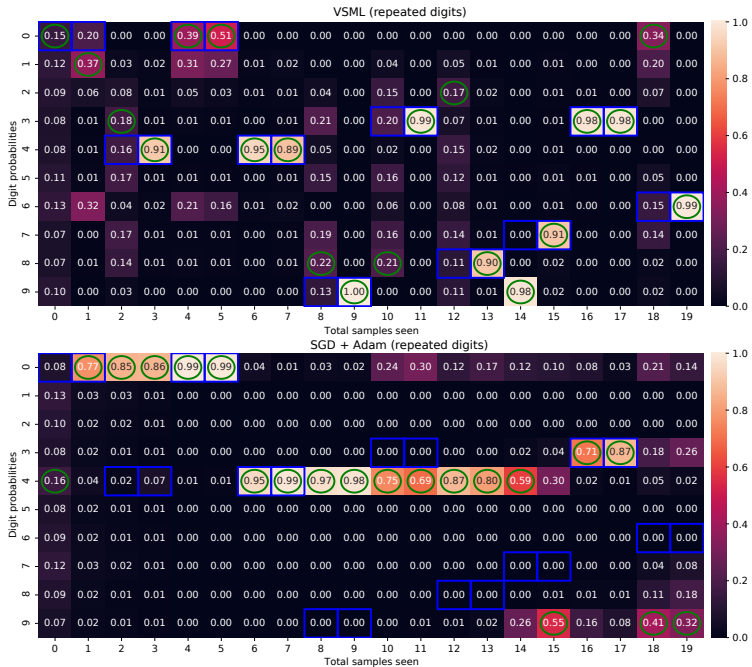

Figure 9: Introspection of how output probabilities change after observing an input and the prediction error when meta testing on MNIST with two examples for each type. We highlight the ground truth class  $\square$  as well as the predicted class  $\circ$ . The top plot shows VSML quickly associating the input images with the right label, almost always making the right prediction the second time with high confidence. The bottom plot shows the same dataset processed by SGD with Adam which fails to learn quickly.

**Discrete program search** An interesting alternative to distributed variable updates in VSML is meta learning via discrete program search [48, 35]. In this paradigm, a separate programming language needs to be defined that gives rise to neural computation when its instructions are combined. This led to the automated rediscovery of backpropagation [35]. In VSML we demonstrate that a symbolic programming language is not required and general-purpose LAs can be discovered and encoded in variable-shared RNNs. Search over neural network parameters is usually easier compared to symbolic program search due to smoothness in the loss landscape.

**Multi-agent systems** In the reinforcement learning setting multiple agents can be modeled with shared parameters [50, 32, 18], also in the context of meta learning [36]. This is related to the variable sharing in VSML depending on how the agent-environment boundary is drawn. Unlike these works, we demonstrate the advantage of variable sharing in meta learning more general-purpose LAs and present a weight update interpretation.

## 7 Discussion and Limitations

The research community has perfected the art of leveraging backpropagation for learning for a long time. At the same time, there are open questions such as how to minimize memory requirements, effectively learn online and continually, learn sample efficiently, learn without separate backward phases, and others. VSML suggests that instead of building on top of backpropagation as a fixed routine, meta learning offers an alternative to discover general-purpose LAs. Nevertheless, this paper is only a proof of concept—until now we have only investigated small-scale problems and performance does not yet quite match the mini-batched setting with large quantities of data. In particular, we observed premature convergence of the solution at meta test time which calls for further investigations. Scaling our system to harder problems and larger meta task distributions will be important future work.

The computational cost of the current VSML variant is also larger than the one of standard backpropagation. If we run a sub-RNN for each weight in a standard NN with  $W$  weights, the cost is in  $O(WN^2)$ , where  $N$  is the state size of a sub-RNN. If  $N$  is small enough, and our experiments suggest small  $N$  may be feasible, this may be an acceptable cost. However, VSML is not bound to the interpretation of a sub-RNN as one weight. Future work may relax this particular choice.

Meta optimization is also prone to local minima. In particular, when the number of ticks between input and feedback increases (e.g. deeper architectures), credit assignment becomes harder. Early experiments suggest that diverse meta task distributions can help mitigate these issues. Additionally, learning horizons are limited when using backprop-based meta optimization. Using ES allowed for training across longer horizons and more stable optimization.

VSML can also be viewed as regularizing the NN weights that encode the LA through a representational bottleneck. It is conceivable that LA generalization as obtained by VSML can also be achieved through other regularization techniques. Unlike most regularizers, VSML also introduces substantial reuse of the same learning principle and permutation invariance through variable sharing.

## 8 Conclusion

We introduced Variable Shared Meta Learning (VSML), a simple principle of weight sharing and sparsity for meta learning powerful learning algorithms (LAs). Our implementation replaces the weights of a neural network with tiny LSTMs that share parameters. We discuss connections to meta recurrent neural networks, fast weight generators (hyper networks), and learned learning rules.

Using *learning algorithm cloning*, VSML RNNs can learn to implement the backpropagation algorithm and its parameter updates encoded implicitly in the recurrent dynamics. On MNIST it learns to predict well without any human-designed explicit computational graph for gradient calculation.

VSML can meta learn from scratch supervised LAs that do not explicitly rely on gradient computation and that *generalize to unseen datasets*. Introspection reveals that VSML LAs learn by fast association in a way that is qualitatively different from stochastic gradient descent. This leads to gains in sample efficiency. Future work will focus on reinforcement learning settings, improvements of meta learning, larger task distributions, and learning over longer horizons.

## Acknowledgements

We thank Sjoerd van Steenkiste, Imanol Schlag, Kazuki Irie, and the anonymous reviewers for their comments and feedback. This work was supported by the ERC Advanced Grant (no: 742870) and computational resources by the Swiss National Supercomputing Centre (CSCS, projects s978 and s1041). We also thank NVIDIA Corporation for donating several DGX machines as part of the Pioneers of AI Research Award, IBM for donating a Minsky machine, and weights & biases [5] for their great experiment tracking software and support.

## References

- [1] F. Alet, M. F. Schneider, T. Lozano-Perez, and L. P. Kaelbling. Meta-learning curiosity algorithms. In *International Conference on Learning Representations*, 2020.
- [2] M. Andrychowicz, M. Denil, S. G. Colmenarejo, M. W. Hoffman, D. Pfau, T. Schaul, B. Shillingford, and N. De Freitas. Learning to learn by gradient descent by gradient descent. In *Advances in Neural Information Processing Systems*, pages 3988–3996, 6 2016.
- [3] J. Ba, G. Hinton, V. Mnih, J. Z. Leibo, and C. Ionescu. Using Fast Weights to Attend to the Recent Past. In *Advances in Neural Information Processing Systems*, pages 4331–4339, 2016.
- [4] S. Bengio, Y. Bengio, J. Cloutier, and J. Gecsei. On the optimization of a synaptic learning rule. In *Preprints Conf. Optimality in Artificial and Biological Neural Networks*, pages 6–8, 1992.
- [5] L. Biewald. Experiment Tracking with Weights and Biases, 2020. URL <https://www.wandb.com/>.
- [6] K. Cho, B. van Merriënboer, C. Gulcehre, D. Bahdanau, F. Bougares, H. Schwenk, and Y. Bengio. Learning Phrase Representations using RNN Encoder-Decoder for Statistical Machine Translation. *Proceedings of the 2014 Conference on Empirical Methods in Natural Language Processing (EMNLP)*, pages 1724–1734, 6 2014.
- [7] T. Clanuwat, M. Bober-Irizar, A. Kitamoto, A. Lamb, K. Yamamoto, and D. Ha. Deep Learning for Classical Japanese Literature, 2018.
- [8] E. F. Codd. *Cellular automata*. Academic press, 2014.
- [9] G. Cohen, S. Afshar, J. Tapson, and A. V. Schaik. EMNIST: Extending MNIST to handwritten letters. *2017 International Joint Conference on Neural Networks (IJCNN)*, 2017. doi: 10.1109/ijcnn.2017.7966217.
- [10] Y. Duan, J. Schulman, X. Chen, P. L. Bartlett, I. Sutskever, and P. Abbeel. RL<sup>2</sup>: Fast Reinforcement Learning via Slow Reinforcement Learning. *arXiv preprint arXiv:1611.02779*, 2016.
- [11] C. Finn, P. Abbeel, and S. Levine. Model-agnostic meta-learning for fast adaptation of deep networks. In *Proceedings of the 34th International Conference on Machine Learning-Volume 70*, pages 1126–1135, 2017.
- [12] F. A. Gers, J. Schmidhuber, and F. Cummins. Learning to Forget: Continual Prediction with LSTM. *Neural Computation*, 12(10):2451–2471, 2000.
- [13] K. Gregor. Finding online neural update rules by learning to remember. *arXiv preprint arXiv:2003.03124*, 3 2020.
- [14] D. Ha, A. Dai, and Q. V. Le. HyperNetworks. In *International Conference on Learning Representations*, 2016.
- [15] S. Hochreiter and J. Schmidhuber. Long Short-Term Memory. *Neural Computation*, 9(8): 1735–1780, 1997.
- [16] S. Hochreiter, A. S. Younger, and P. R. Conwell. Learning to learn using gradient descent. In *International Conference on Artificial Neural Networks*, 2001.
- [17] R. Houthoofd, R. Y. Chen, P. Isola, B. C. Stadie, F. Wolski, J. Ho, and P. Abbeel. Evolved Policy Gradients. In *Advances in Neural Information Processing Systems*, pages 5400–5409, 2018.
- [18] W. Huang, I. Mordatch, and D. Pathak. One Policy to Control Them All: Shared Modular Policies for Agent-Agnostic Control. In *International Conference on Machine Learning*, 2020.

- [19] L. Kirsch, J. Kunze, and D. Barber. Modular Networks: Learning to Decompose Neural Computation. *Advances in Neural Information Processing Systems*, 2018.
- [20] L. Kirsch, S. van Steenkiste, and J. Schmidhuber. Improving Generalization in Meta Reinforcement Learning using Learned Objectives. In *International Conference on Learning Representations*, 2020.
- [21] Y. LeCun, C. Cortes, and C. J. Burges. MNIST handwritten digit database. *ATT Labs [Online]*. Available: <http://yann.lecun.com/exdb/mnist>, 2, 2010.
- [22] K. Li and J. Malik. Learning to Optimize. *arXiv preprint arXiv:1606.01885*, 2016.
- [23] S. Linnainmaa. *The representation of the cumulative rounding error of an algorithm as a Taylor expansion of the local rounding errors*. PhD thesis, Univ. Helsinki, 1970.
- [24] L. Metz, N. Maheswaranathan, C. D. Freeman, B. Poole, and J. Sohl-Dickstein. Tasks, stability, architecture, and compute: Training more effective learned optimizers, and using them to train themselves. *arXiv preprint arXiv:2009.11243*, 9 2020.
- [25] T. Miconi, J. Clune, and K. O. Stanley. Differentiable plasticity: training plastic neural networks with backpropagation. In *International Conference on Machine Learning*, 2018.
- [26] T. Miconi, A. Rawal, J. Clune, and K. O. Stanley. Backpropamine: training self-modifying neural networks with differentiable neuromodulated plasticity. In *International Conference on Learning Representations*, 2019.
- [27] N. Mishra, M. Rohaninejad, and X. U. Chen Pieter Abbeel Berkeley. A Simple Neural Attentive Meta-Learner. In *International Conference on Learning Representations*, 2018.
- [28] A. Mordvintsev, E. Randazzo, E. Niklasson, and M. Levin. Growing neural cellular automata. *Distill*, 5(2):e23, 2020.
- [29] M. C. Mozer and S. Das. A connectionist symbol manipulator that discovers the structure of context-free languages. In *Advances in neural information processing systems*, pages 863–870, 1993.
- [30] E. Najarro and S. Risi. Meta-Learning through Hebbian Plasticity in Random Networks. *Advances in Neural Information Processing Systems*, 2020.
- [31] J. Oh, M. Hessel, W. M. Czarnecki, Z. Xu, H. van Hasselt, S. Singh, and D. Silver. Discovering Reinforcement Learning Algorithms. *arXiv preprint arXiv:2007.08794*, 2020.
- [32] D. Pathak, C. Lu, T. Darrell, P. Isola, and A. A. Efros. Learning to Control Self-Assembling Morphologies: A Study of Generalization via Modularity. In *Advances in Neural Information Processing Systems*, 2019.
- [33] E. Randazzo, E. Niklasson, and A. Mordvintsev. MPLP: Learning a Message Passing Learning Protocol. *arXiv preprint arXiv:2007.00970*, 2020.
- [34] S. Ravi and H. Larochelle. Optimization as a model for few-shot learning. In *International Conference on Learning Representations*, 2016.
- [35] E. Real, C. Liang, D. R. So, and Q. V. Le. AutoML-Zero: Evolving Machine Learning Algorithms From Scratch. In *International Conference on Machine Learning*, pages 8007–8019, 2020.
- [36] M. Rosa, O. Afanasjeva, S. Andersson, J. Davidson, N. Guttenberg, P. Hlubuček, M. Poliak, J. Vítku, and J. Feyereisl. BADGER: Learning to (Learn [Learning Algorithms] through Multi-Agent Communication). *arXiv preprint arXiv:1912.01513*, 2019.
- [37] C. Rosenbaum, T. Klinger, and M. Riemer. Routing Networks: Adaptive Selection of Non-Linear Functions for Multi-Task Learning. In *International Conference on Learning Representations*, 2018.
- [38] T. Salimans, J. Ho, X. Chen, S. Sidor, and I. Sutskever. Evolution Strategies as a Scalable Alternative to Reinforcement Learning. *arXiv preprint arXiv:1703.03864*, 3 2017. ISSN ISSN 0302-9743. doi: 10.1.1.51.6328.
- [39] M. Sandler, M. Vladymyrov, A. Zhmoginov, N. Miller, A. Jackson, T. Madams, and others. Meta-Learning Bidirectional Update Rules. *arXiv preprint arXiv:2104.04657*, 2021.

- [40] A. Santoro, S. Bartunov, M. Botvinick, D. Wierstra, and T. Lillicrap. Meta-Learning with Memory-Augmented Neural Networks. In *International conference on machine learning*, pages 1842–1850, 2016.
- [41] I. Schlag and J. Schmidhuber. Gated Fast Weights for On-The-Fly Neural Program Generation. In *NIPS Metalearning Workshop*, 2017.
- [42] I. Schlag, T. Munkhdalai, and J. Schmidhuber. Learning Associative Inference Using Fast Weight Memory. In *International Conference on Learning Representations*, 2021.
- [43] J. Schmidhuber. Evolutionary principles in self-referential learning. Diploma thesis, Institut für Informatik, Technische Universität München, 1987.
- [44] J. Schmidhuber. Learning to Control Fast-Weight Memories: An Alternative to Recurrent Nets. Technical Report FKI-147-91, Institut für Informatik, Technische Universität München, 3 1991.
- [45] J. Schmidhuber. Learning to Control Fast-Weight Memories: An Alternative to Dynamic Recurrent Networks. *Neural Computation*, 4(1):131–139, 1992. ISSN 0899-7667. doi: 10.1162/neco.1992.4.1.131.
- [46] J. Schmidhuber. Reducing the ratio between learning complexity and number of time varying variables in fully recurrent nets. In *International Conference on Artificial Neural Networks*, pages 460–463. Springer, 1993.
- [47] J. Schmidhuber. A self-referential weight matrix. In *Proceedings of the International Conference on Artificial Neural Networks, Amsterdam*, pages 446–451. Springer, 1993.
- [48] J. Schmidhuber. Discovering Problem Solutions with Low Kolmogorov Complexity and High Generalization Capability. Technical Report FKI-194-94, Fakultät für Informatik, Technische Universität München, 1994.
- [49] N. Shazeer, A. Mirhoseini, K. Maziarz, A. Davis, Q. Le, G. Hinton, and J. Dean. Outrageously Large Neural Networks: The Sparsely-Gated Mixture-of-Experts Layer. *arXiv preprint arXiv:1701.06538*, 2017.
- [50] Sims, Karl. *Evolving Virtual Creatures*. ACM SIGGRAPH, 1994.
- [51] A. Sperduti. Encoding labeled graphs by labeling raam. *Advances in Neural Information Processing Systems*, pages 1125–1125, 1994.
- [52] S. Sudhakaran, D. Grbic, S. Li, A. Katona, E. Najarro, C. Glanois, and S. Risi. Growing 3d artefacts and functional machines with neural cellular automata. *arXiv preprint arXiv:2103.08737*, 2021.
- [53] G. Z. Sun. Neural networks with external memory stack that learn context-free grammars from examples. In *Proceedings of the Conference on Information Science and Systems, 1991*, pages 649–653. Princeton University, 1991.
- [54] E. Triantafillou, T. Zhu, V. Dumoulin, P. Lamblin, U. Evci, K. Xu, R. Goroshin, C. Gelada, K. Swersky, P.-A. Manzagol, and H. Larochelle. Meta-Dataset: A Dataset of Datasets for Learning to Learn from Few Examples. 3 2019.
- [55] H.-Y. Tseng, H.-Y. Lee, J.-B. Huang, and M.-H. Yang. Cross-domain few-shot classification via learned feature-wise transformation. *arXiv preprint arXiv:2001.08735*, 2020.
- [56] J. X. Wang, Z. Kurth-Nelson, D. Tirumala, H. Soyer, J. Z. Leibo, R. Munos, C. Blundell, D. Kumaran, and M. Botvinick. Learning to reinforcement learn. *arXiv preprint arXiv:1611.05763*, 2016.
- [57] D. Wierstra, T. Schaul, J. Peters, and J. Schmidhuber. Natural Evolution Strategies. In *2008 IEEE Congress on Evolutionary Computation (IEEE World Congress on Computational Intelligence)*, pages 3381–3387, 2008.
- [58] Z. Wu, S. Pan, F. Chen, G. Long, C. Zhang, and S. Y. Philip. A comprehensive survey on graph neural networks. *IEEE Transactions on Neural Networks and Learning Systems*, 2020.
- [59] H. Xiao, K. Rasul, and R. Vollgraf. Fashion-MNIST: a Novel Image Dataset for Benchmarking Machine Learning Algorithms. *CoRR*, abs/1708.0, 2017.

## A Derivations

**Theorem 1.** *The weight matrices  $W$  and  $C$  used to compute VSML RNNs from Equation 4 can be expressed as a standard RNN with weight matrix  $\tilde{W}$  (Equation 5) such that*

$$s_{abj} \leftarrow \sigma\left(\sum_i s_{abi}W_{ij} + \sum_{c,i} s_{cai}C_{ij}\right) \quad (8)$$

$$= \sigma\left(\sum_{c,d,i} s_{cdi}\tilde{W}_{cdiabj}\right). \quad (9)$$

The weight matrix  $\tilde{W}$  has entries of zero and shared entries given by Equation 6.

$$\tilde{W}_{cdiabj} = \begin{cases} C_{ij}, & \text{if } d = a \wedge (d \neq b \vee c \neq a). \\ W_{ij}, & \text{if } d \neq a \wedge d = b \wedge c = a. \\ C_{ij} + W_{ij}, & \text{if } d = a \wedge d = b \wedge c = a. \\ 0, & \text{otherwise.} \end{cases} \quad (6 \text{ revisited})$$

*Proof.* We rearrange  $\tilde{W}$  into two separate weight matrices

$$\sum_{c,d,i} s_{cdi}\tilde{W}_{cdiabj} \quad (10)$$

$$= \sum_{c,d,i} s_{cdi}A_{cdiabj} + \sum_{c,d,i} s_{cdi}(\tilde{W} - A)_{cdiabj}. \quad (11)$$

Then assuming  $A_{cdiabj} = (d \equiv b)(c \equiv a)W_{ij}$ , where  $x \equiv y$  equals 1 iff  $x$  and  $y$  are equal and 0 otherwise, it holds that

$$\sum_{c,d,i} s_{cdi}A_{cdiabj} = \sum_i s_{abi}W_{ij}. \quad (12)$$

Further, assuming  $(\tilde{W} - A)_{cdiabj} = (d \equiv a)C_{ij}$  we obtain

$$\sum_{c,d,i} s_{cdi}(\tilde{W} - A)_{cdiabj} = \sum_{c,i} s_{cai}C_{ij}. \quad (13)$$

Finally, solving both conditions for  $\tilde{W}$  gives

$$\tilde{W}_{cdiabj} = (d \equiv a)C_{ij} + (d \equiv b)(c \equiv a)W_{ij}, \quad (14)$$

which we rewrite in tabular notation:

$$\tilde{W}_{cdiabj} = \begin{cases} C_{ij}, & \text{if } d = a \wedge (d \neq b \vee c \neq a). \\ W_{ij}, & \text{if } d \neq a \wedge d = b \wedge c = a. \\ C_{ij} + W_{ij}, & \text{if } d = a \wedge d = b \wedge c = a. \\ 0, & \text{otherwise.} \end{cases} \quad (15)$$

Thus, Equation 8 holds and any weight matrices  $W$  and  $C$  can be expressed by a single weight matrix  $\tilde{W}$ .  $\square$

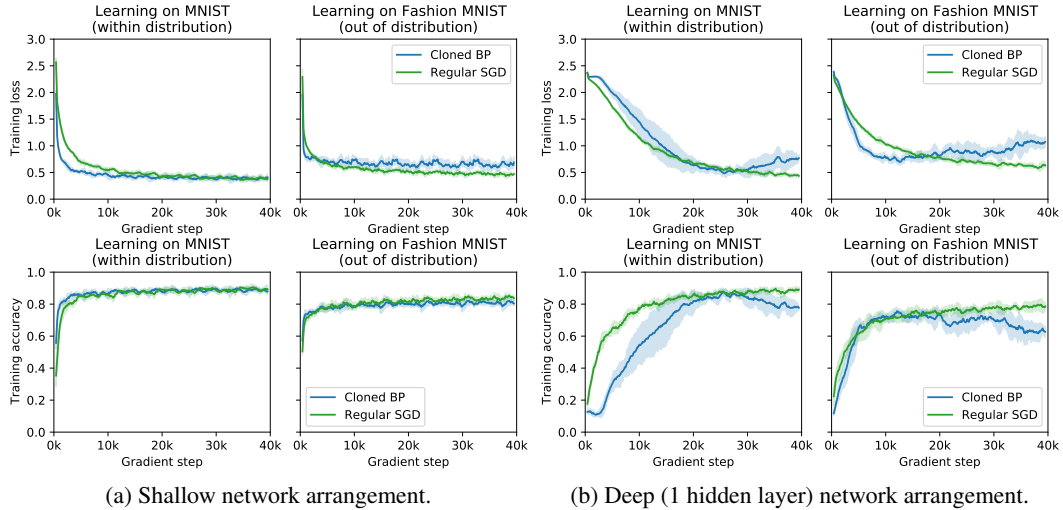

Figure 11: Additional experiments with VSML RNNs implementing backpropagation. Standard deviations are over 6 seeds.

## B Additional Experiments

### B.1 Learning algorithm cloning

**VSML RNNs can implement neural forward computation** In this experiment, we optimize the VSML RNN to compute  $y = \tanh(x)w$ . Figure 10 (left) shows how for different inputs  $x$  and weights  $w$  the LSTM produces the correct target value, including the multiplicative interaction. The heat-map (right) shows that low prediction errors are produced but the target dynamics are not perfectly matched. We repeat these LSTMs in line with Equation 7 to obtain an ‘emergent’ neural network.

#### Learning Algorithm Cloning Curriculum

In principle, backpropagation can be simply cloned on random data such that forward computation implements multiplicative activation-weight interaction and backward computation passes an error signal back given previous forward activations. If the previous forward activations are fed as an input one could stack VSML RNNs that implement these two operations to mimic arbitrarily deep NNs. By purely training on random data and unrolling for one step, we can successfully learn on MNIST and Fashion MNIST in the shallow setting. For deeper models, in practice, cloning errors accumulate and input and state distributions shift. To achieve learning in deeper networks we have used a curriculum on random and MNIST data. We first match the forward activations, backward errors, and weight updates for a shallow network. Next, we use a deep network and provide intermediate errors by a ground truth network. Finally, we remove intermediate errors and use the RNN’s intermediate predictions that are now close to the ground truth. The final VSML RNN can be used to train both shallow (Figure 11a) and deep configurations (Figure 11b).

### B.2 Meta learning from scratch

**Meta testing learning curves & sample efficiency** In Figure 8 we only showed accuracies after 2k steps. Figure 12 provides the entire meta test training trajectories for a subset of all configurations. Furthermore, in Figure 13 we show the cumulative accuracy on the first 100 examples. From both

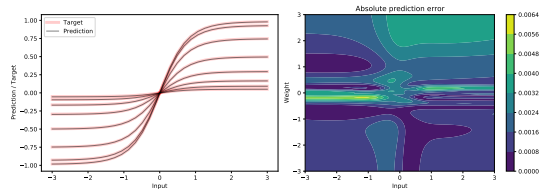

Figure 10: We are optimizing VSML RNNs to implement neural forward computation such that for different inputs and weights a tanh-activated multiplicative interaction is produced (left), with different lines for different  $w$ . These neural dynamics are not exactly matched everywhere (right), but the error is relatively small.

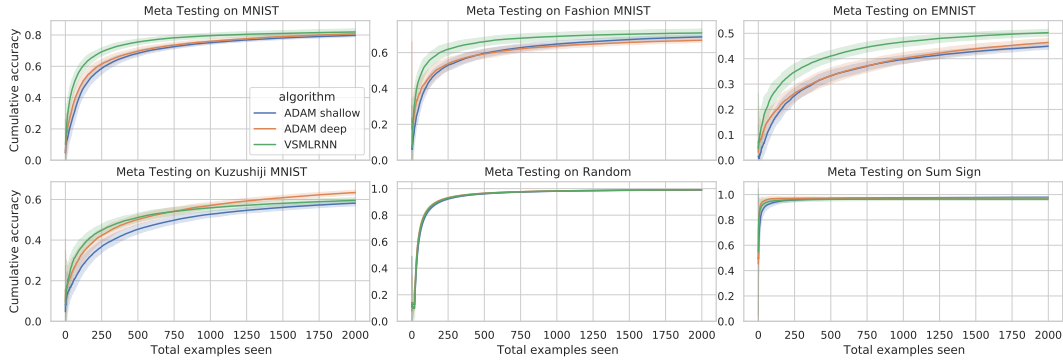

Figure 12: Meta testing learning curves. All 6 meta test tasks are unseen. VSML RNN has been meta trained on MNIST, Fashion MNIST, EMNIST, KMNIST, and Random, excluding the respective dataset that is being meta tested on. Standard deviations are over 32 seeds.

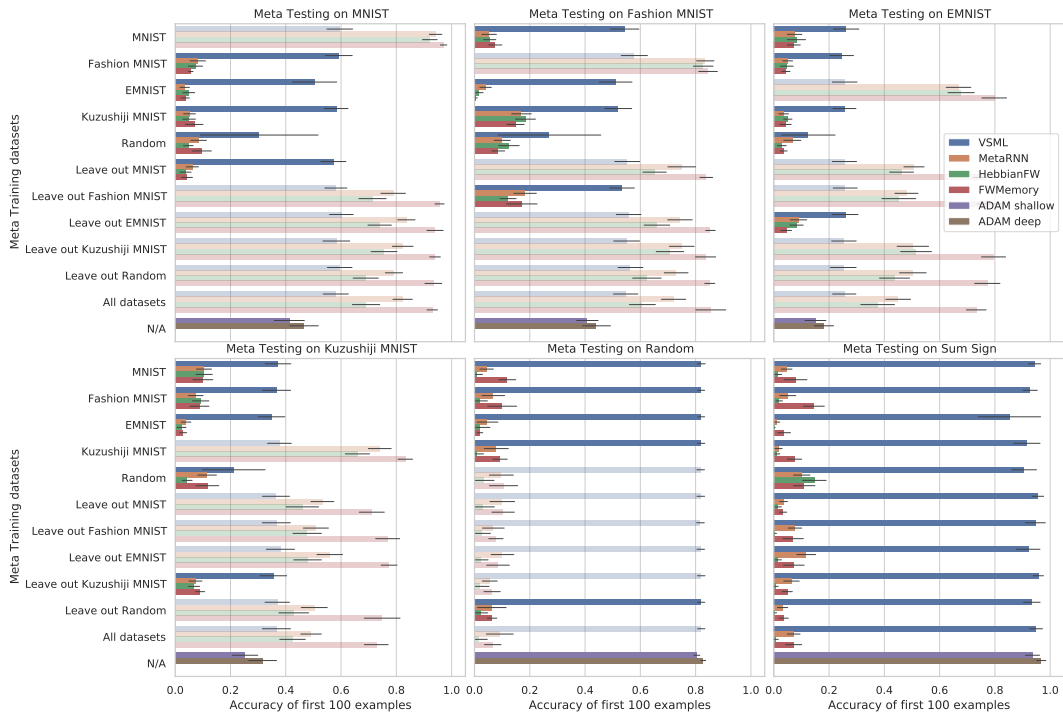

Figure 13: Online learning on various datasets. Cumulative accuracy in % after having seen **100 training examples** evaluated after each prediction starting with random states (VSML, Meta RNN, HebbianFW, FWMemory) or random parameters (SGD). Standard deviations are over 32 meta test training runs. Meta testing is done on the official test set of each dataset. Meta training is on subsets of datasets excluding the Sum Sign dataset. Unseen tasks, most relevant from a general-purpose LA perspective, are opaque.

figures, it is evident that learning at the beginning is accelerated compared to SGD with Adam. Also compare with our introspection from Section 5.

**Ablation: Projection augmentations** In the main text (Figure 8) we have randomly projected inputs during VSML meta training. When not randomly projecting inputs (Figure 14), generalization of VSML is slightly reduced. In Figure 15 we have enabled these augmentations for all methods, including the baselines. While VSML benefits from the augmentations, the Meta RNN, Hebbian fast weights, and external memory baselines do not increase their generalization significantly with



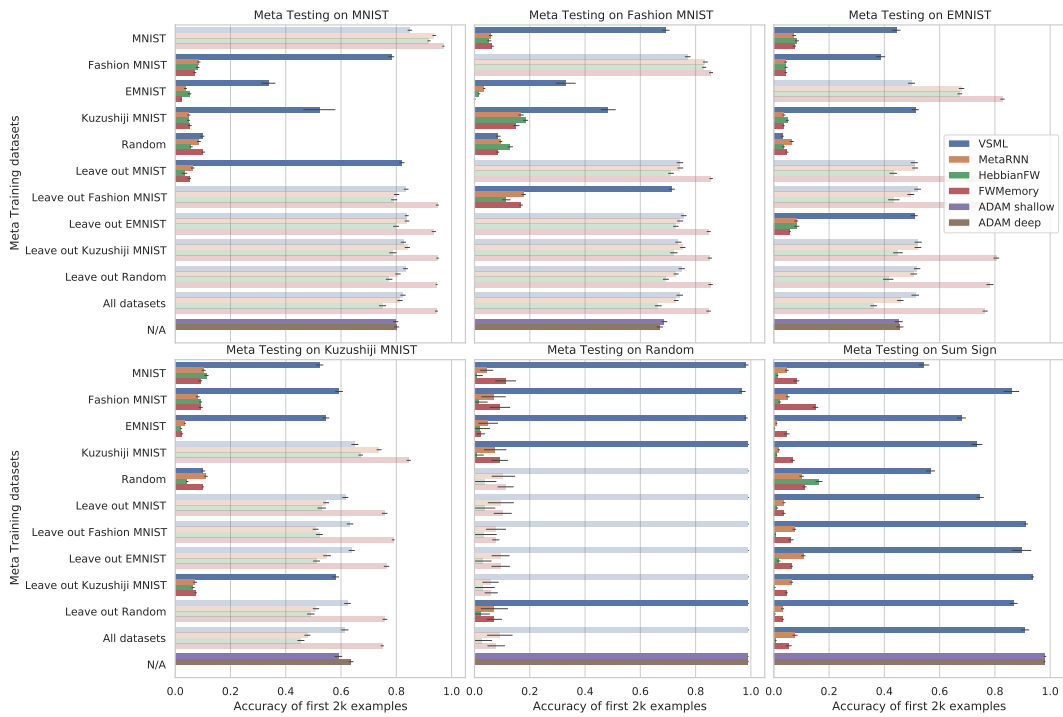

Figure 14: Same as figure Figure 8 and Figure 13 but with accuracies after having seen 2k training examples and **no random projections for all methods** during meta training.

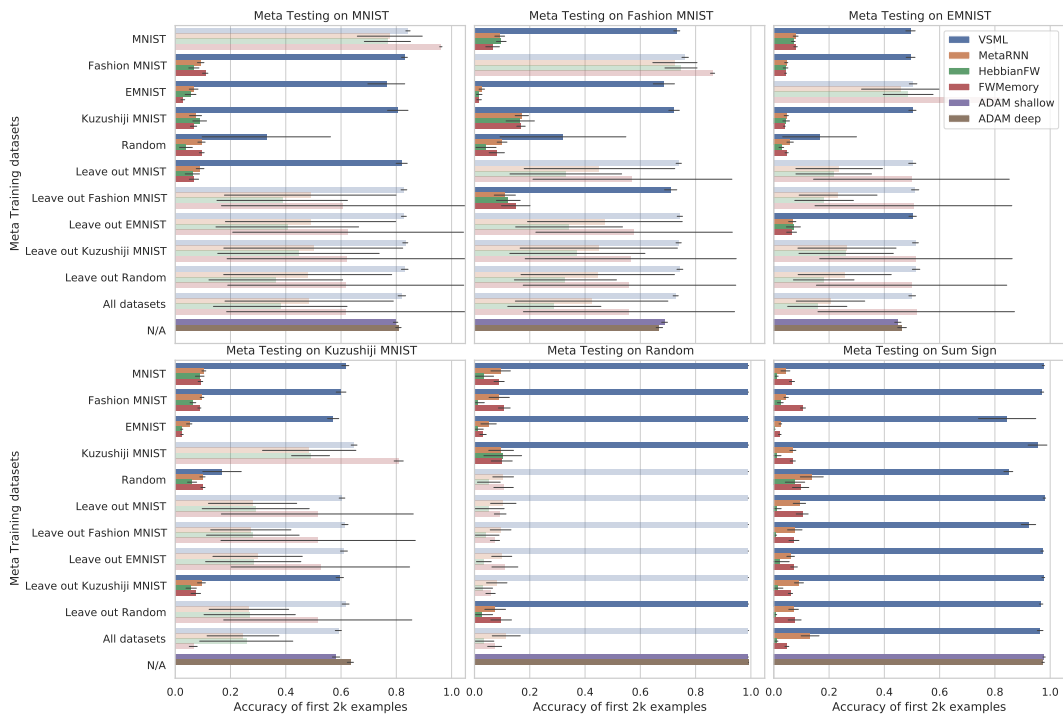

Figure 15: Same as figure Figure 8 and Figure 13 but with accuracies after having seen 2k training examples and **random projections for all methods including baselines** during meta training.

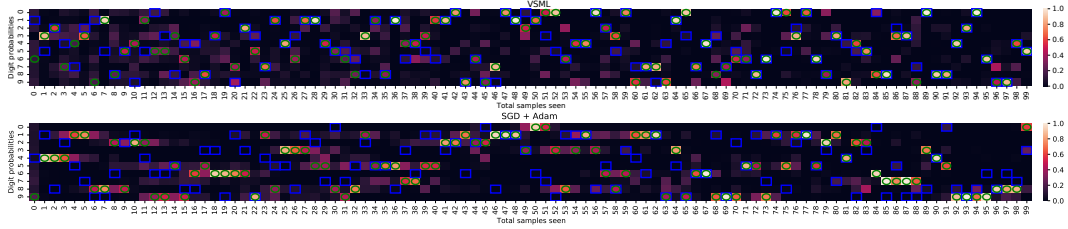

Figure 17: Introspection of how output probabilities change after observing an input and its error at the output units when meta testing **on the full MNIST dataset**. We highlight the input class  $\square$  as well as the predicted class  $\circ$  for 100 examples in sequence. The top plot shows the VSML RNN quickly associating the input images with the right label, generalizing to future inputs. The bottom plot shows the same dataset processed by SGD with Adam which learns significantly slower by following the gradient.

those enabled. In Figure 16 we show meta test training curves for both the augmented as well as non-augmented case.

### Introspect longer meta test training run

Similar to Figure 9 we introspect how VSML RNNs learned to learn after meta training on the MNIST dataset. In this case, we meta test for 100 steps by sampling from the full MNIST dataset in Figure 17 without repeating digits. Compared to the previous setup, learning is slower as there is a larger variety of possible inputs. Nevertheless, we observe that VSML RNNs still associate inputs with their label rather quickly compared to SGD.

**Omniglot** In this paper, we have focused on the objective of meta learning a general-purpose learning algorithm. Different from most contemporary meta learning approaches we tested the discovered learning algorithm on significantly different datasets to assess its generalization capabilities. These generalization capabilities may affect the performance on standard few-shot benchmarks such as Omniglot. In this section, we assess how VSML performs on those datasets where the tasks at meta test time are similar to those during meta training.

On Omniglot, our experimental setting corresponds to the common 5-way, 1-shot setting [25]: In each episode, we select 5 random classes, sample 1 instance each, and show it to the network with the label and prediction error. Then, we sample a new random test instance from one of the 5 classes and meta train to minimize the cross-entropy on that example. At meta test time we use unseen alphabets (classes) from the test set and report the accuracy of the test instance across 100 episodes.

The results (Figure 18) nicely demonstrate how common baselines such as the Meta RNN [16, 10, 56] or a Meta RNN with external memory [42] work well in an Omniglot setting, yet fail when the gap increases between meta train and meta test, thus requiring stronger generalization (Figure 6, Figure 8). In contrast, VSML generalizes well to unseen datasets, e.g. Fashion MNIST, although it does learn more slowly on Omniglot. Finally, these new results demonstrate how VSML learns significantly faster on Omniglot compared to SGD with Adam, thus highlighting the benefits of the meta learning approach adopted in this work.

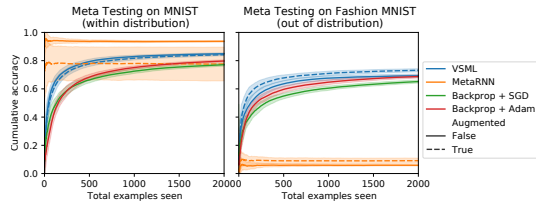

Figure 16: On the MNIST meta training example from Figure 6 we plot the effect of adding the random projection augmentation to VSML and the Meta RNN. The Fashion MNIST performance (out of distribution) is slightly improved for VSML while the effect on the Meta RNN is limited.

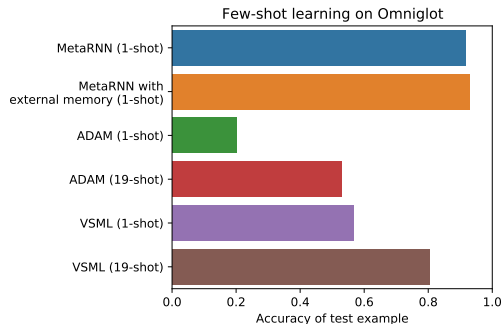

Figure 18: VSML on the Omniglot dataset.

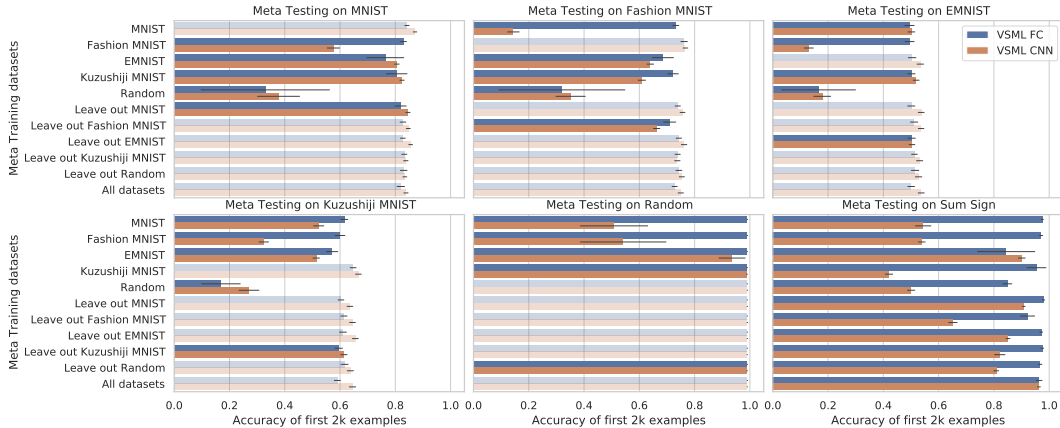

Figure 20: Convolutions are competitive to the standard fully connected setup.

**Short horizon bias** In this paper, we have observed that VSML can be significantly more sample efficient compared to backpropagation with gradient descent, in particular for the first few examples. The longer we unroll the VSML RNNs, the smaller this gap becomes. In Figure 19 we run VSML for 12,000 examples (24,000 RNN ticks). From this plot, it is evident that at some point gradient descent overtakes VSML in terms of learning progress. We call this phenomenon the *short horizon bias*, where meta test training is fast in the beginning but flattens out at some horizon. In the current version of VSML we only meta optimize the RNN for 500 examples (marked by the vertical dashed line) starting with a random initialization, not explicitly optimizing learning beyond that point, resulting in this bias. In future work, we will investigate methods to circumvent this bias, for example by resuming from previous states (learning progress) similar to a persistent population in previous meta learning work [20].

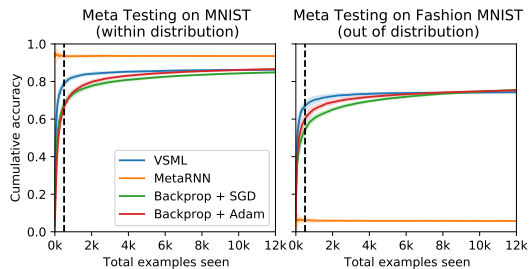

Figure 19: Short horizon bias.

**Convolutional Neural Networks** VSML’s sub-RNNs can not only be arranged to fully connected layers, but also convolutions. For this experiment, we have implemented a convolutional neural network (CNN) version of VSML. This is done by replacing each weight in the kernel with a multi-dimensional RNN state and replacing the kernel multiplications with VSML sub-RNNs. We use a convolutional layer with kernel size 3, stride 2, and 8 channels, followed by a dense layer. On our existing datasets, it performs similar to the fully connected architecture, as can be seen in Figure 20.

We also applied our CNN variant to CIFAR10. Note that in this paper we are interested in the online learning setting (similar to the one of Meta RNNs). This is a challenging problem on which gradient descent with back-propagation also struggles. Many consecutive examples ( $> 10^5$  steps) are required for learning. On-line performance is generally lower than in the batched setting which we do not explore here. When meta training on CIFAR10 (Figure 21) we observe that meta test-time learning on CIFAR is initially faster compared to SGD while still generalizing to Fashion MNIST. On the other hand, with a sufficiently large meta training distribution, we would hope to see a similar generalization to CIFAR10 when CIFAR10 is unseen. As visible in both plots, learning speed decreases at some point. This is probably due to the current

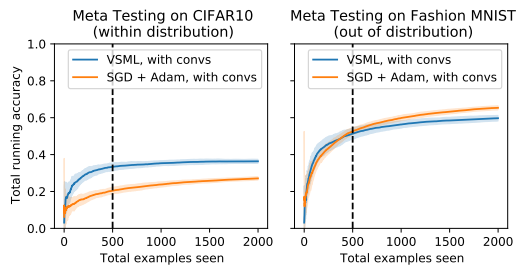

Figure 21: Meta Training on CIFAR10 with a CNN version of VSML.

short-horizon bias as discussed in the previous paragraph. Future improvements are necessary to further scale VSML to harder learning problems.

## C Other Training Details

**LSTM implementation** We implement the VSML RNN using  $A \cdot B$  LSTMs with forward and backward messages as described in Equation 7. Each LSTM  $ab$  at layer  $k$  is updated by

$$z_{ab}^{(k)}, h_{ab}^{(k)} \leftarrow f_{\text{LSTM}}(z_{ab}^{(k)}, h_{ab}^{(k)}, \vec{m}_a^{(k)}, \overleftarrow{m}_b^{(k)}). \quad (16)$$

The functions  $f_{\vec{m}}$  and  $f_{\overleftarrow{m}}$  are a linear projection to outputs of size  $N' = 8$  and  $N'' = 8$  respectively. The state size is given by  $N = 64$  for LA cloning and  $N = 16$  for meta learning from scratch.  $A^{(1)}$  and  $B^{(K)}$  are fixed according to the dataset input/output size and others are chosen freely as described in the respective experiment. We found that averaging messages instead of summing them,  $\vec{m}_b^{(k)} := \frac{1}{A^{(k-1)}} \sum_{a'} f_{\vec{m}}(s_{a'b}^{(k-1)})$  and  $\overleftarrow{m}_a^{(k)} := \frac{1}{B^{(k+1)}} \sum_{b'} f_{\overleftarrow{m}}(s_{ab'}^{(k+1)})$ , improves meta training stability.

**Source code** is available at <http://louiskirsch.com/code/vsml>.

### C.1 Learning algorithm cloning

**General training remarks** During the forward evaluation of layers  $1, \dots, K$  we freeze the LSTM state. During the backward pass, we only retain two state dimensions that correspond to the weight and the bias. We also zero all other LSTM input dimensions in  $\vec{m}$  and  $\overleftarrow{m}$  except the ones that encode the input  $x$  and error  $e$ . We maintain a buffer of VSML RNN states from which we sample a batch during LA cloning and append one of the new states to the buffer. This ensures diversity across possible VSML RNN states during LA cloning.

**Batching for VSML RNNs** In Section 3.2 we optimize a VSML RNN to implement backpropagation. To stabilize learning at meta test time we run the RNN on multiple data points (batch size 64) and then average their states corresponding to  $w$  and  $b$  as an analogue to batching in standard gradient descent.

**Stability during meta testing** To prevent exploding states during meta testing we also clip the LSTM state between  $-4$  and  $4$ .

**Bounded states in LSTMs** In LSTMs the hidden state is bounded between  $(-1, 1)$ . For learning algorithm cloning, we'd like to support weights and biases beyond this range. This can be circumvented by choosing a constant, here 4, by which we scale  $w$  and  $b$  down to store them in the context state. This is only relevant during learning algorithm cloning.

### C.2 Meta learning from scratch

**Hyperparameter search strategy** The VSML hyper-parameters were searched using wandb's [5] Bayesian search during development. Parameters that lead to stable meta learning on MNIST were chosen. The final parameters were not further tuned and doing so may lead to additional performance gains. For the Meta RNN we picked parameters that matched VSML RNN as much as possible. For our SGD and SGD with Adam baselines, we performed a grid search over the learning rate on MNIST to find the best learning rates.

**Meta Training** Meta training is done across 128 GPUs using ES as proposed by OpenAI [38] for a total of 10k steps. We use a population size of 1024, each population member is evaluated on one trajectory of 500 online examples. We use noise with a fixed standard deviation of 0.05. To apply the estimated gradient, we use Adam with a learning rate of 0.025 and betas set to 0.9 and 0.999. We have run similar experiments (where GPU memory is sufficient) with distributed gradient descent on 8 GPUs which led to less stable training but qualitatively similar results with appropriate early stopping and gradient clipping.

**VSML RNN architecture** Each sub-RNN has a state size of  $N = 16$  and messages are sized  $N' = N'' = 8$ . We only use a single layer between the input and prediction, thus  $A$  equals the flattened input image dimension and  $B = 10$  for the predicted logits. The outputs are squashed between  $\pm 100$  using  $\tanh$ . We run this layer two ticks per input. States are initialized randomly from independent standard normals.

**SGD baseline architecture and learning rate** The deep SGD baseline uses a hidden layer of size 160, resulting in approximately  $125k$  parameters on MNIST to match the number of state dimensions of the VSML RNN. We use a  $\tanh$  activation function to match the LSTM setup. The tuned learning rate used for vanilla SGD is  $10^{-2}$  and  $10^{-3}$  for Adam.

**Meta RNN baseline** We use an LSTM hidden size of 16 and an input size of  $|\text{image}| + |\text{error}|$  where  $|\text{error}|$  corresponds to the output size. Inputs are padded to be equal size across all meta training datasets. This results in about  $100k$  to  $150k$  parameters.

**Hebbian fast weight baseline** We compare to a Hebbian fast weight baseline as described in Miconi et al. [25] where a single layer is adapted using learned synaptic plasticity. A single layer is adapted using Oja’s rule by feeding the prediction errors and label as additional inputs.

**Specialization through RNN coordinates** In addition to the recurrent inputs and inputs from the interaction term, each sub-RNN can be fed its coordinates  $a, b$ , position in time, or position in the layer stack. This may allow for (1) specialization, akin to the specialization of biological neurons, and (2) for implicitly meta learning neural architectures by suppressing outputs of sub-RNNs based on positional information. In our experiments, we have not yet observed any benefits of this approach and leave this to future work.

**Meta learning batched LAs** In our meta learning from scratch experiments, we discovered online learning algorithms (similar to Meta RNNs [16, 56, 10]). We demonstrated high sample efficiency but the final performance trails the one of batched SGD training. In future experiments, we also want to investigate a batched variant. Every tick we could average a subset of each state  $s_{ab}$  across multiple parallel running VSML RNNs. This would allow for meta learning batched LAs from scratch.

**Optimizing final prediction error vs sum of all errors** In our experiments we are interested in sample efficient learning, i.e., the model making good predictions as early as possible in training. This is encouraged by minimizing the sum of all prediction errors throughout training. If only good final performance is desired, optimizing solely final prediction error or a weighting of prediction errors is an interesting alternative to be investigated in the future.

**Recursive replacement of weights** Variable sharing in NNs by replacing each weight with an LSTM introduces new meta variables  $V_M$ . Those variables themselves may be replaced again by LSTMs, yielding a multi-level hierarchy with arbitrary depth. We leave the exploration of such hierarchies to future work.

**Alternative sparse shared weight matrices** In this paper, we have focused on a version of VSML where the sparse shared weight matrix is defined by many RNNs that pass messages. Alternative ways of structuring variable sharing and sparsity may lead to different kinds of learning algorithms. Investigating these alternatives or even searching the space of variable sharing and sparsity patterns are interesting directions for future research.

**Meta Testing algorithm** Meta testing corresponds to unrolling the VSML RNNs. The learning algorithm is encoded purely in the recurrent dynamics. See Algorithm 2 for pseudo-code.

---

**Algorithm 2** VSML: Meta Testing

---

**Require:** Dataset  $D = \{(x_i, y_i)\}$ , LSTM parameters  $V_M$

$V_L = \{s_{ab}^{(k)}\} \leftarrow$  initialize LSTM states  $\forall a, b, k$   
**for**  $(x, y) \in \{(x_1, y_1), \dots, (x_T, y_T)\} \subset D$  **do** ▷ Inner loop over  $T$  examples  
     $\vec{m}_{a1}^{(1)} := x_a \quad \forall a$  ▷ Initialize from input image  $x$   
    **for**  $k \in \{1, \dots, K\}$  **do** ▷ Iterating over  $K$  layers  
         $s_{ab}^{(k)} \leftarrow f_{RNN}(s_{ab}^{(k)}, \vec{m}_a^{(k)}, \overleftarrow{m}_b^{(k)}) \quad \forall a, b$  ▷ Equation 7  
         $\vec{m}_b^{(k+1)} := \sum_{a'} f_{\vec{m}}(s_{a'b}^{(k)}) \quad \forall b$  ▷ Create forward message  
         $\overleftarrow{m}_a^{(k-1)} := \sum_{b'} f_{\overleftarrow{m}}(s_{ab'}^{(k)}) \quad \forall a$  ▷ Create backward message  
     $\hat{y}_a := \vec{m}_{a1}^{(K+1)} \quad \forall a$  ▷ Read output  
     $e := \nabla_{\hat{y}} L(\hat{y}, y)$  ▷ Compute error at outputs using loss  $L$   
     $\overleftarrow{m}_{b1}^{(K)} := e_b \quad \forall b$  ▷ Input errors

---

## D Other relationships to previous work

### D.1 VSML as distributed memory

Compared to other works with additional external memory mechanisms [53, 29, 40, 27, 42], VSML can also be viewed as having memory distributed across the network. The memory writing and reading mechanism implemented in the meta variables  $V_M$  is shared across the network.

### D.2 Connection to modular learning

Our sub-LSTMs can also be framed as *modules* that have some shared meta variables  $V_M$  and distinct learned variables  $V_L$ . Previous works in modular learning [49, 37, 19] were motivated by learning experts with unique parameters that are conditionally selected to suit the current task or context. In contrast, VSML has recurrent modules that share the same parameters  $V_M$  to resemble a learning algorithm. There is no explicit conditional selection of modules, although it could emerge based on activations or be facilitated via additional attention mechanisms.

### D.3 Connection to self-organization and complex systems

In self-organizing systems, global behavior emerges from the behavior of many local systems such as cellular automata [8] and their recent neural variants [28, 52]. VSML can be seen as such a self-organizing system where many sub-RNNs induce the emergence of a global learning algorithm.