

Interactive Speech and Noise Modeling for Speech Enhancement

Chengyu Zheng^{1*}, Xiulian Peng², Yuan Zhang¹, Sriram Srinivasan³, Yan Lu²

¹ Communication University of China

² Microsoft Research Asia

³ Microsoft Corporation

zhengchengyu@cuc.edu.cn, xipe@microsoft.com, yzhang@cuc.edu.cn, Sriram.Srinivasan@microsoft.com, yanlu@microsoft.com

Abstract

Speech enhancement is challenging because of the diversity of background noise types. Most of the existing methods are focused on modelling the speech rather than the noise. In this paper, we propose a novel idea to model speech and noise simultaneously in a two-branch convolutional neural network, namely SN-Net. In SN-Net, the two branches predict speech and noise, respectively. Instead of information fusion only at the final output layer, interaction modules are introduced at several intermediate feature domains between the two branches to benefit each other. Such an interaction can leverage features learned from one branch to counteract the undesired part and restore the missing component of the other and thus enhance their discrimination capabilities. We also design a feature extraction module, namely residual-convolution-and-attention (RA), to capture the correlations along temporal and frequency dimensions for both the speech and the noises. Evaluations on public datasets show that the interaction module plays a key role in simultaneous modeling and the SN-Net outperforms the state-of-the-art by a large margin on various evaluation metrics. The proposed SN-Net also shows superior performance for speaker separation.

1 Introduction

Speech enhancement aims at separating speech from background interference signals. Mainstream deep learning-based methods learn to predict the speech signal in a supervised manner, as shown in Figure 1 (a). Most prior works operate in the time-frequency (T-F) domain by predicting a mask between noisy and clean spectra (Wang, Narayanan, and Wang 2014; Williamson, Wang, and Wang 2015) or directly predicting the clean spectrum (Xu et al. 2013; Tan and Wang 2018). Some methods operate in the time domain by estimating speech signals from raw-waveform noisy signals in an end-to-end way (Fu et al. 2017; Pascual, Bonafonte, and Serra 2017; Pandey and Wang 2019). These methods have considerably improved the quality of enhanced speech compared with traditional signal processing based schemes. However, speech distortion or residual noise can often be observed in the enhanced speech, showing that there are still correlations between predicted speech and the residual signal by subtracting enhanced speech from noisy signal.

*The work was done at Microsoft Research Asia.

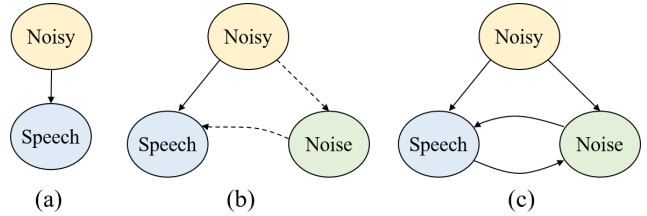

Figure 1: Illustration of different methods. (a) Most existing deep-learning-based methods directly model speech. (b) Most traditional methods predict speech with noise estimate. (c) Our method simultaneously models speech and noise with information interaction.

Instead of only predicting speech and ignoring the characteristics of background noises, traditional signal processing and modeling based methods mostly take the other way (see Figure 1 (b)), i.e. estimating noise or building noise models for speech enhancement (Boll 1979; Hendriks, Heusdens, and Jensen 2010; Wang and Brookes 2017; Wilson et al. 2008; Mohammadiha, Smaragdis, and Leijon 2013). Some model-based methods instead model both speech and noise (Srinivasan, Samuelsson, and Kleijn 2005b,a), possibly with alternate model update. However, they typically cannot generalize well when prior noise assumption cannot be met or the interference signal is not structured. In deep-learning-based methods, two recent attempts (Odelowo and Anderson 2017, 2018) focus on directly predicting noise considering that noise is dominant in low-SNR conditions. However, the benefit is limited.

The remaining correlation between predicted speech and noise motivates us to explore the information flow between speech and noise estimations, as shown in Figure 1 (c). Since speech-related information exists in predicted noise, and vice versa, adding information communication between them may help to recover some missing components and remove undesired information from each other. In this paper, we propose a two-branch convolutional neural network, namely SN-Net, to simultaneously predict speech and noise signals. Between them are information interaction modules, by which noise or speech related information are extracted from the noise branch and added back to speech features to counteract the undesired noise part or recover the

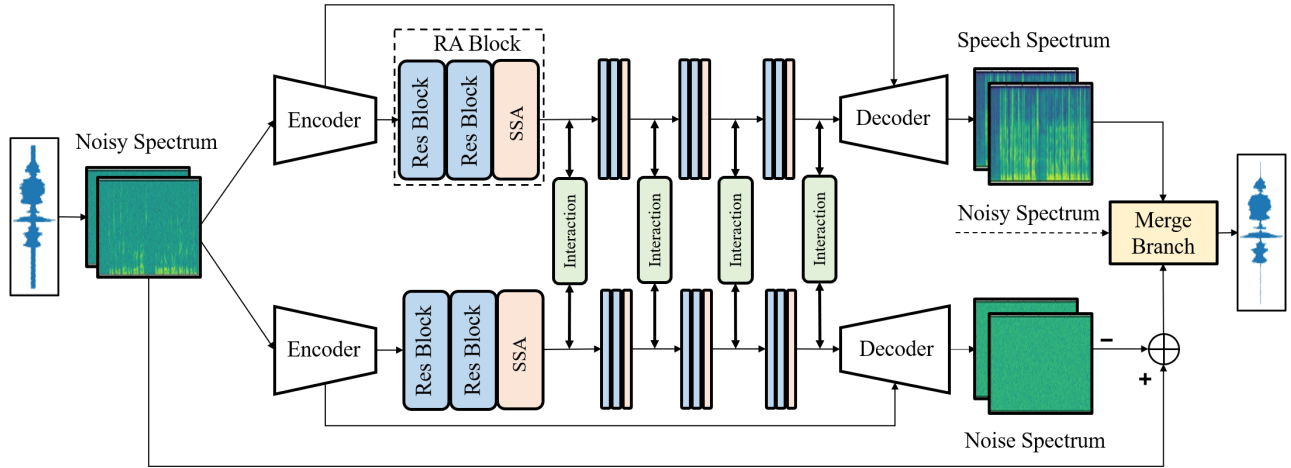

Figure 2: Overall network structure of SN-Net.

missing speech, and vice versa. In this way, the discrimination capability is largely enhanced. The two branches share the same network structure, which is an encoder-decoder-based model with several residual-convolution-and-attention (RA) blocks in between for separation. Motivated by the success of self-attention technique in machine translation and computer vision tasks (Vaswani et al. 2017; Wang et al. 2018), we propose to combine temporal self-attention and frequency-wise self-attention parallelly inside each RA block for capturing global dependency along temporal and frequency dimensions in a separable way.

Our main contributions are summarized as follows.

- We propose to simultaneously model speech and noise in a two-branch deep neural network and introduce information flow between them. In this way, speech part is enhanced while residual noise is suppressed for speech estimation, and vice versa.
- We propose a RA block for feature extraction. Separable self-attention is utilized in this block to globally capture the temporal and frequency dependencies.
- We validate the superiority of proposed scheme in an ablation study and comparison with state-of-the-art algorithms on two public datasets. Moreover, we extend our method to speaker separation, which also shows great performance. These results demonstrate the superiority and potential of the proposed method.

2 Related Work

2.1 Deep Learning-based Speech Enhancement

Deep learning-based methods mainly study how to build a speech model. According to the adopted signal domain, these methods can be classified into two categories. Time-Frequency (T-F) domain methods take T-F representation, either complex or log power spectrum of the magnitude, as input. They typically estimate a real or complex ratio mask for each T-F bin to map noisy spectra to speech spectra (Williamson, Wang, and Wang 2015; Wang, Narayanan, and Wang 2014; Choi et al. 2019) or directly predict the speech

representation (Xu et al. 2013; Tan and Wang 2018). Time-domain methods take waveform as input and typically extract a hidden representation of the raw waveform through an encoder and reconstruct an enhanced version from that (Fu et al. 2017; Pascual, Bonafonte, and Serra 2017; Pandey and Wang 2019). Although these methods have shown great improvements over traditional methods, they only focus on modeling speech and neglect the importance of understanding noise characteristics.

2.2 Noise-Aware Speech Enhancement

Noise information is often considered in traditional signal processing based methods (Boll 1979; Hendriks, Heusdens, and Jensen 2010; Wang and Brookes 2017) with prior distribution assumptions for speech and noise. However, it is a challenging task to estimate the noise power spectral density for non-stationary noises and thus mostly stationary noise is assumed. They are unsuitable in generalization to low SNR and non-stationary noise conditions. Instead, some model-based methods build models for speech and noise and show more promising results, e.g., codebook (Srinivasan, Samuelsson, and Kleijn 2005b,a) and nonnegative matrix factorization (NMF) (Wilson et al. 2008; Mohammadiha, Smaragdis, and Leijon 2013) based methods. However, they either need prior knowledge of the noise type (Srinivasan, Samuelsson, and Kleijn 2005b,a) or are only effective for structured noise (Wilson et al. 2008; Mohammadiha, Smaragdis, and Leijon 2013); therefore their generalization capability is limited.

Deep learning-based methods can better generalize to various noise conditions. There are also some attempts on incorporating noise information, for example, by adding constraints to loss functions (Fan et al. 2019; Xu, Elshamy, and Fingscheidt 2020; Xia et al. 2020) or by directly predicting noise instead of speech (Odelowo and Anderson 2017, 2018). The former does not model noise at all and the characteristics of noise are not exploited. The latter loses the speech information and show even worse quality than corresponding speech prediction method in low SNR and unseen

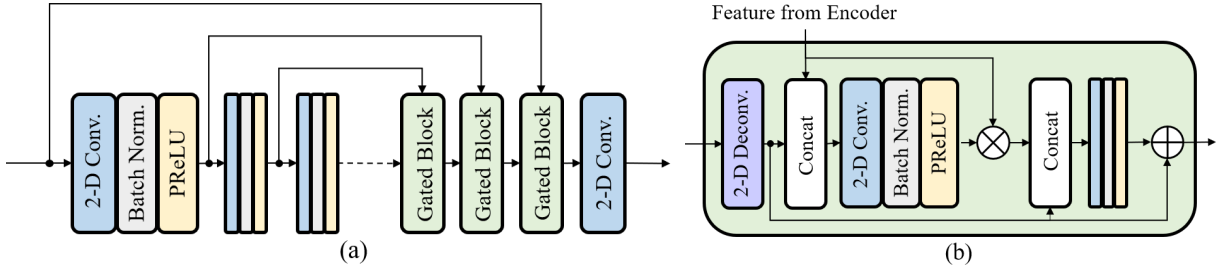

Figure 3: (a) Encoder-decoder structure. The dashed arrow denotes the separation module using RA blocks. (b) Detailed structure of the gated block inside the decoder.

noise conditions. A more relevant work utilizes two deep auto encoders (DAEs) to estimate speech and noise (Sun et al. 2015). It first trains a DAE for speech spectrum reconstruction and then introduces another DAE to model noise with the constraint that the sum of outputs of the two DAEs is equal to the noisy spectrum.

Different from aforementioned approaches, we proposed a two-branch CNN to predict speech and noise simultaneously and introduce interaction modules at several intermediate layers to make them benefit from each other. Such a paradigm makes it suitable for speaker separation as well.

2.3 Two-Branch Neural Networks

Two-branch neural networks have been explored in various tasks for capturing cross-modality information (Nam, Ha, and Kim 2017; Wang et al. 2019) or different levels of information (Simonyan and Zisserman 2014; Wang et al. 2020). For speech enhancement, a two-branch modeling is proposed to predict the amplitude and phase of the enhanced signal, respectively (Yin et al. 2020). In this paper, we aim to exploit the two correlated tasks, i.e. speech and noise estimations and explicitly modeling them in an interactive two-branch framework for better discrimination.

2.4 Self-Attention Model

Self-attention mechanism has been widely used in many tasks, e.g., machine translation (Vaswani et al. 2017), image generation (Zhang et al. 2019) and video question answering (Li et al. 2019). For video, spatio-temporal attention is also considered to exploit long-term dependency along both spatial and temporal dimensions (Wu et al. 2019). Recently, speech-related tasks have also benefited from self-attention, e.g., speech recognition (Salazar, Kirchhoff, and Huang 2019) and speech enhancement (Kim, El-Khomy, and Lee 2020; Koizumi et al. 2020). In these works, self-attention is applied along the temporal dimension only, neglecting the global dependency inside each frame. Motivated by the spatio-temporal attention in video-related tasks, we propose to employ both frequency-wise and temporal self-attention to better capture dependencies along different dimensions. Such an attention is employed in both speech and noise branches for simultaneous modeling the two signals.

3 Proposed Method

3.1 Overview

Figure 2 shows the overall network structure of SN-Net. The input is the complex T-F spectrum computed by short-time Fourier transform (STFT), denoted as $X^T \in \mathbb{R}^{T \times F \times 2}$, where T is the number of frames and F is the number of frequency bins. There are two branches in SN-Net, one of which predicts speech and the other predicts noise. They share the same network structure but have separate network parameters. Each branch is an encoder-decoder based structure, with several RA blocks inserted inbetween them. In this way, it is capable of simultaneously mining the potential of different components of the noisy signal. Between the two branches are interaction modules designed to transform and share information. After each branch gets its output, a merge branch is employed to adaptively combine the two outputs to generate the final enhanced speech.

3.2 Encoder and Decoder

As shown in Figure 3 (a), the encoder has three 2-D convolutional layers, each with a kernel size of (3, 5). The stride is (1, 1) for the first layer and (1, 2) for the following two. The channel numbers are 16, 32, 64, respectively. As a result, the output feature of the encoder is $\mathcal{F}_k^E \in \mathbb{R}^{T \times F' \times C}$, where $F' = \frac{F}{4}$, $C = 64$ and $k \in \{S, N\}$. S and N denote speech and noise branches, respectively. For simplicity, the subscript k will be ignored in the following.

The decoder consists of three gated blocks followed by one 2-D convolutional layer, which reconstructs the output $\mathcal{F}^D \in \mathbb{R}^{T \times F \times 2}$. As shown in Figure 3 (b), the gated block learns a multiplicative mask on corresponding feature from the encoder, aiming to suppress its undesired part. The masked encoder feature is then concatenated with the deconvolutional feature and fed into another 2-D convolutional layer to generate the residual representation. After three gated blocks, the final convolutional layer learns the amplitude gain and the phase for reconstruction, similar to that in (Choi et al. 2019). The kernel size for all 2-D deconvolutional layers is (3,5). The stride is (1,2) for the first two gated blocks and (1,1) for the last one. The channel numbers are 64, 32, 16, respectively. All the 2-D convolutional layers in the decoder have a kernel size of (1,1), a stride of (1,1) and a channel number the same as that of their inputs.

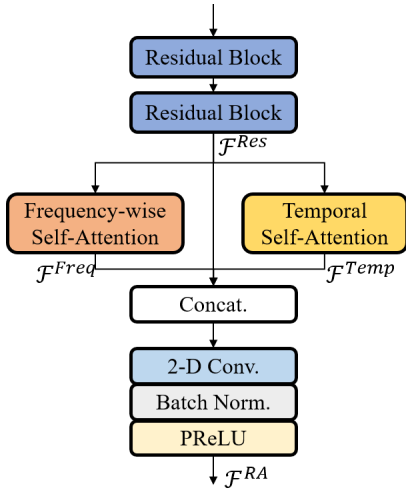

Figure 4: Structure of the RA block.

All the convolutional layers in the encoder and the decoder are followed by a batch normalization (BN) and a parametric ReLU (PReLU). No down-sampling is performed along the temporal dimension to preserve the temporal resolution.

3.3 RA Block

The RA block is designed to extract features and perform separation for both speech and noise branches. It is challenging because of the diversities of noise types and the difference between speech and noises. We employ the separable self-attention (SSA) technique to capture the global dependencies along temporal and frequency dimensions, respectively. It is intuitive to use attention for these two dimensions as humans tend to put more attention to some parts of an audio signal (e.g., speech) while less to the surrounding part (e.g., noise) and they perceive differently on different frequencies. When it comes to the speech-noise network in SN-Net, the SSA modules in speech and noise branches perceive signals differently, which will be demonstrated in the ablation study section afterwards.

In SN-Net, there are four RA blocks between the encoder and the decoder. Each block consists of two residual blocks and a SSA module, as shown in Figure 4, capturing both local and global dependencies inside the signal. Each residual block has two 2-D convolutional layers with a kernel size of (5,7), a stride of (1,1) and the same number of channels as their inputs. The output feature of two residual blocks $\mathcal{F}_i^{Res} \in \mathbb{R}^{T \times F' \times C}$ ($i \in \{1, 2, 3, 4\}$ represents the i^{th} RA block and will be ignored in the following) is fed parallelly into temporal self-attention and frequency-wise self-attention blocks. These two attention blocks produce the outputs $\mathcal{F}^{Temp} \in \mathbb{R}^{T \times F' \times C}$ and $\mathcal{F}^{Freq} \in \mathbb{R}^{T \times F' \times C}$. The three features \mathcal{F}^{Res} , \mathcal{F}^{Temp} and \mathcal{F}^{Freq} are then concatenated and fed into a 2-D convolutional layer to generate the block output $\mathcal{F}^{RA} \in \mathbb{R}^{T \times F' \times C}$, used in the interaction module.

For self-attention, we employ the scaled dot-product self-

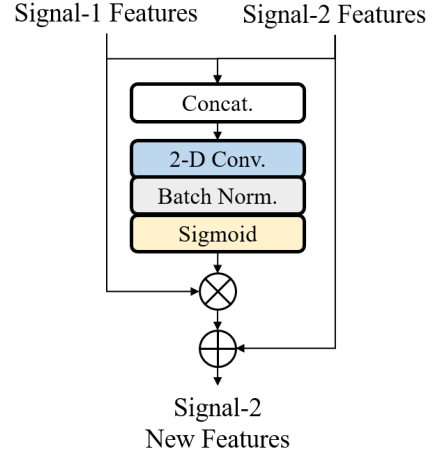

Figure 5: Structure of the interaction module.

attention here. Considering the computational complexity, channels are reduced by half inside SSA. The temporal self-attention can be represented as

$$\mathcal{F}_t^k = \text{Reshape}^t(\text{Conv}(\mathcal{F}^{Res})), k \in \{K, Q, V\},$$

$$SA^t = \text{Softmax}(\mathcal{F}_t^Q \cdot (\mathcal{F}_t^K)^T / \sqrt{\frac{C}{2} \times F'}) \cdot \mathcal{F}_t^V, \quad (1)$$

$$\mathcal{F}^{Temp} = \mathcal{F}^{Res} + \text{Conv}(\text{Reshape}^{t*}(SA^t)),$$

where $\mathcal{F}_t^k \in \mathbb{R}^{T \times (\frac{C}{2} \times F')}$, $SA^t \in \mathbb{R}^{T \times (\frac{C}{2} \times F')}$ and $\mathcal{F}^{Temp} \in \mathbb{R}^{T \times F' \times C}$, respectively. (\cdot) denotes matrix multiplication. $\text{Reshape}^t(\cdot)$ denotes a tensor reshape from $\mathbb{R}^{T \times F' \times \frac{C}{2}}$ to $\mathbb{R}^{T \times (\frac{C}{2} \times F')}$ and $\text{Reshape}^{t*}(\cdot)$ is the opposite. The frequency-wise self-attention is given by

$$\mathcal{F}_f^k = \text{Reshape}^f(\text{Conv}(\mathcal{F}^{Res})), k \in \{K, Q, V\},$$

$$SA^f = \text{Softmax}(\mathcal{F}_f^Q \cdot (\mathcal{F}_f^K)^T / \sqrt{\frac{C}{2} \times T}) \cdot \mathcal{F}_f^V, \quad (2)$$

$$\mathcal{F}^{Freq} = \mathcal{F}^{Res} + \text{Conv}(\text{Reshape}^{f*}(SA^f)),$$

where $\mathcal{F}_f^k \in \mathbb{R}^{F' \times (\frac{C}{2} \times T)}$, $SA^f \in \mathbb{R}^{F' \times (\frac{C}{2} \times T)}$ and $\mathcal{F}^{Freq} \in \mathbb{R}^{T \times F' \times C}$, respectively. $\text{Reshape}^f(\cdot)$ reshapes a tensor from $\mathbb{R}^{T \times F' \times \frac{C}{2}}$ to $\mathbb{R}^{F' \times (\frac{C}{2} \times T)}$.

In the above equations, Conv denotes a convolutional layer followed by BN and PReLU. All the convolutional layers have a kernel size of (1,1) and a stride of (1,1).

3.4 Interaction Module

In SN-Net, the speech and noise branches share the same input signal, which suggests that the internal features of two branches are correlated. In light of this, we propose an interaction module to exchange information between the branches. With this block, information transformed from the noise branch is expected to enhance the speech part and counteract the noise features inside the speech branch, and vice versa. We will show in ablation study afterwards that

this module plays a key role in simultaneously modeling the speech and noises.

The structure of the interaction module is shown in Figure 5. Taking speech branch as an example, feature from the noise branch \mathcal{F}_N^{RA} is first concatenated with that from the speech branch \mathcal{F}_S^{RA} . They are then fed into a 2-D convolutional layer to generate a multiplicative mask \mathcal{M}^N , predicting the suppressed and preserved areas of \mathcal{F}_N^{RA} . A residual representation \mathcal{H}^{N2S} is then obtained by multiplying \mathcal{M}^N with \mathcal{F}_N^{RA} elementally. Finally, the block adds \mathcal{F}_S^{RA} and \mathcal{H}^{N2S} to get a “filtered” version of the speech feature, which will be fed into the next RA block. The process is given by

$$\begin{aligned}\mathcal{F}_{S_{out}}^{RA} &= \mathcal{F}_S^{RA} + \mathcal{F}_N^{RA} * \text{Mask}(\mathcal{F}_N^{RA}, \mathcal{F}_S^{RA}), \\ \mathcal{F}_{N_{out}}^{RA} &= \mathcal{F}_N^{RA} + \mathcal{F}_S^{RA} * \text{Mask}(\mathcal{F}_S^{RA}, \mathcal{F}_N^{RA}),\end{aligned}\quad (3)$$

where $\text{Mask}(\cdot)$ is short for concatenation, convolution and sigmoid operations. $(*)$ denotes element-wise multiplication.

3.5 Merge Branch

After reconstructing the speech and noise signals in two branches, a merge module is further employed to combine the two outputs. This is done in the time domain to achieve the cross-domain benefit (Kim et al. 2018). The two decoder outputs are transformed to time-domain and overlapped framed representation using the same window length as the STFT we use, resulting in $\tilde{s} \in \mathbb{R}^{T \times K}$ and $\tilde{n} \in \mathbb{R}^{T \times K}$, where K is the frame size. These two representations are stacked with the noisy waveform x and fed into the merge branch. The merge network uses a 2-D convolutional layer, followed by a temporal self-attention block to capture global temporal dependency and two other convolutional layers to learn an element-wise mask $m \in \mathbb{R}^{T \times K}$. The kernel size of all three convolutional layers is (3,7) and the channel number is 3, 3, 1, respectively. BN and PReLU are used after each convolutional layer except the last one. Sigmoid activation is used in the last layer. Finally, the 2D enhanced signal is obtained by

$$\hat{s} = m \times \tilde{s} + (1 - m) \times (x - \tilde{n}). \quad (4)$$

The 1D signal is reconstructed from \hat{s} after overlap and add.

4 Experiments

4.1 Datasets

Three public datasets are used in our experiments.

DNS Challenge The DNS challenge (Reddy et al. 2020) at Interspeech 2020 provides a large dataset for training. It includes 500 hours clean speech across 2150 speakers collected from LibriVox and 60000 noise clips from Audioset (Gemmeke et al. 2017) and Freesound with 150 classes. For training, we synthesized 500 hours noisy samples with SNR levels of -5dB, 0dB, 5dB, 10dB and 15dB. For evaluation, we use 150 synthetic noisy samples without reverberation inside the test set, whose SNR levels are randomly distributed between 0 dB and 20 dB.

Voice Bank + DEMAND This is a small dataset created by Valentini-Botinhao et al. (Valentini-Botinhao et al. 2016).

Table 1: Ablation study on DNS Challenge dataset

Models	SDR(dB)	PESQ
Noisy	9.09	1.58
Speech branch w/o SSA (baseline)	18.06	3.05
Speech branch	18.75	3.28
SN-Net w/o interaction	19.04	3.29
SN-Net	19.52	3.39

Clean speech clips are collected from the Voice Bank corpus (Veaux, Yamagishi, and King 2013) with 28 speakers for training and another 2 unseen speakers for test. Ten noise types with two artificially generated and eight real recordings from DEMAND (Thiemann, Ito, and Vincent 2013) are used for training. Five other noise types from DEMAND are chosen for the test, without overlapping with the training set. The SNR values are 0dB, 5dB, 15dB and 20dB for training and 2.5dB, 7.5dB, 12.5dB and 17.5dB for test.

TIMIT Corpus This dataset is used for our speaker separation experiment. It contains recordings of 630 speakers, each reading 10 sentences and there are 462 speakers in the training set and 168 speakers in the test set. Two sentences from different speakers are mixed with random SNRs to generate mixture utterances. Shorter sentences are zero padded to match the size of longer ones. In total, the training set includes 4620 sentences and the test set 1680 sentences.

4.2 Evaluation Metrics

To evaluate the quality of the enhanced speech, the following objective measures are used. Higher scores indicate better quality.

- SSNR: Segmental SNR.
- SDR (Vincent, Gribonval, and Févotte 2006): Signal-to-distortion ratio.
- PESQ (Rec 2005): Perceptual evaluation of speech quality, using the wide-band version recommended in ITU-T P.862.2 (from -0.5 to 4.5).
- CSIG (Hu and Loizou 2007): Mean opinion score (MOS) prediction of the signal distortion (from 1 to 5).
- CBAK (Hu and Loizou 2007): MOS prediction of the intrusiveness of background noises (from 1 to 5).
- COVL (Hu and Loizou 2007): MOS prediction of the overall effect (from 1 to 5).

4.3 Implementation Details

Input All signals are resampled to 16kHz and clipped to 2 seconds long. We take the STFT complex spectrum as input, with a Hann window of length 20ms, a hop length of 10ms and a DFT length of 320.

Loss Function The loss function includes three terms, i.e. $\mathcal{L} = \mathcal{L}_{Speech} + \alpha \mathcal{L}_{Noise} + \beta \mathcal{L}_{Merge}$, where \mathcal{L}_{Speech} , \mathcal{L}_{Noise} and \mathcal{L}_{Merge} represent the loss of three branches, respectively. α and β are weighting factors balancing among the three. All terms use a mean-square-error (MSE) loss on the power-law compressed STFT spectrum (Ephrat et al.

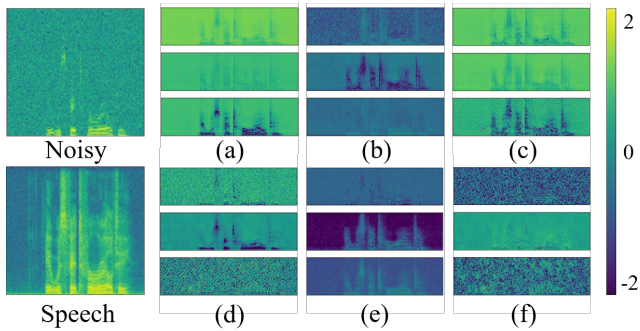

Figure 6: Log-scale feature visualization for the fourth interaction module. (a) Input feature of speech branch. (b) Transformed feature from noise to speech branch. (c) Output feature of speech branch. (d) Input feature of noise branch. (e) Transformed feature from speech to noise branch. (f) Output feature of noise branch. Three channels with the highest activities are visualized here.

2018). An inverse STFT and forward STFT are conducted on speech and noise branches before calculating the loss to ensure STFT consistency as that in (Wisdom et al. 2019).

Training The proposed algorithm is implemented in TensorFlow. We use adam optimizer with a learning rate of 0.0002. All the layers are initialized with Xavier initialization. The training is conducted in two stages. The speech and noise branches are jointly trained first with the loss weight $\alpha = 1$ and $\beta = 0$. Then the merge branch is trained with the parameters of previous two fixed, using only the loss \mathcal{L}_{Merge} . We train both stages for 60 epochs for DNS Challenge and 400 epochs for Voice Bank + DEMAND dataset. The batch size for all experiments is set to 32, unless otherwise specified.

4.4 Ablation Study

Objective Quality We first evaluate the effectiveness of different parts of the proposed SN-Net based on the DNS Challenge dataset. As shown in Table 1, we take the speech branch without SSA as the baseline. After adding SSA to the single-branch model, we observe a 0.69 dB gain on SDR and 0.23 on PESQ. By comparing “Speech branch” with “SN-Net w/o interaction”, we can see that when no interaction is employed, adding another branch with merge module at the output only marginally improves the SDR by 0.29 dB and no improvement on PESQ. After introducing the information flow, it evidently improves the SDR by 0.77 dB and PESQ by 0.11 compared to single branch. These results verify the effectiveness of the proposed RA and interaction modules for simultaneously modeling speech and noises.

Visualization of Information Flow In order to further understand how the interaction module works, we visualize the input feature, the output and the feature transformed from the other branch of this module in Figure 6. An audio signal corrupted by white noises is used for illustration, whose spectrum is shown in the first column.

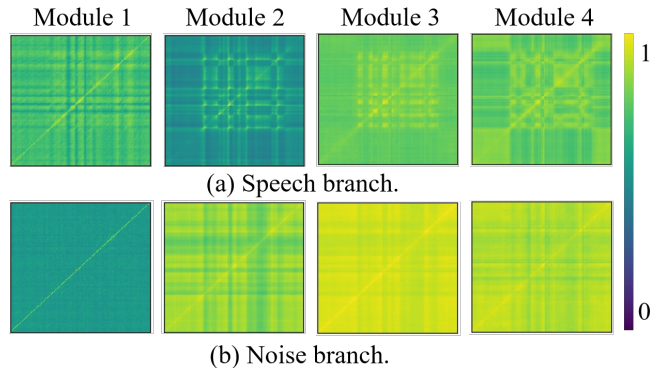

Figure 7: Visualization of temporal self-attention matrices from different RA blocks. (a) Speech branch. (b) Noise branch. Each matrix is linearly scaled to $[0, 1]$.

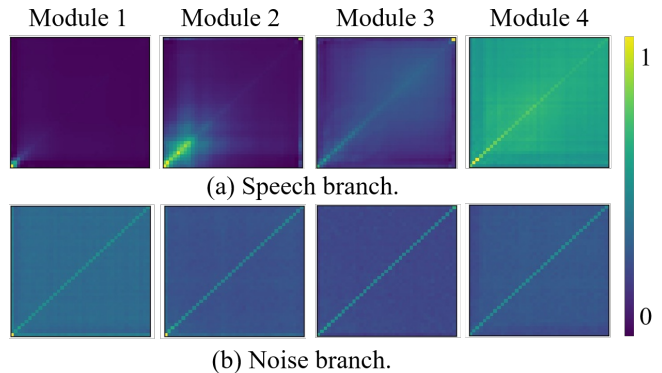

Figure 8: Visualization of frequency-wise self-attention matrices from different RA blocks. (a) Speech branch. (b) Noise branch. Each matrix is linearly scaled to $[0, 1]$.

The transformed feature shown in Figure 6 (b) is learned from the feature in (d) and added to the feature in (a), resulting in the output feature of speech branch in (c) and vice versa. Comparing (a) and (c), we can see that the speech area is better separated with noise after interaction. For noise branch, the speech part is mostly removed in (f) compared with (d). These results show that the interaction module indeed helps the simultaneous speech and noise modeling with better separation capabilities. In terms of interchanged information, the undesired speech part in (d) is counteracted by features learned from the speech branch (e.g., the second channel of the noise branch) and the undesired noise part in (a) is suppressed by features learned from the noise branch (e.g., the third channel of the speech branch). These observations comply with our previous analysis.

Visualization of Separable Self-Attention We further visualize the attention matrix to explore what it has learned. Figure 7 shows the temporal self-attention matrix inside different RA blocks for the same audio signal as that in Figure 6. From (a) and (b), we can see that besides the diagonal

Table 2: Quality comparisons on Voice Bank + DEMAND

Methods	SSNR	PESQ	CSIG	CBAK	COVL
Noisy	1.68	1.97	3.35	2.44	2.63
SEGAN	7.73	2.16	3.48	2.94	2.80
MMSE-GAN	-	2.53	3.80	3.12	3.14
PHASEN	10.18	2.99	4.21	3.55	3.62
Koizumi et al.	-	2.99	4.15	3.42	3.57
Ours	9.83	3.12	4.39	3.60	3.77

Table 3: Quality comparisons on DNS Challenge

Methods	SDR(dB)	PESQ
Noisy	9.09	1.58
TCNN	16.86	2.34
TCNN-L	16.58	2.78
Conv-TasNet-SNR	-	2.73
DTLN	16.54	2.34
MultiScale+	-	2.71
PoCoNet	-	2.75
Ours	19.52	3.39

line, each frame shows strong attentiveness to other frames and speech and noise branches behave differently for each RA module. This is reasonable as the two branches model different signals and their focus differs. For noise branch, the attention goes from local to global as the network goes deeper. The noise branch shows wider attentiveness than the speech branch as white noises spread in all frames while speech signal occurs only at some time.

Figure 8 shows the frequency-wise self-attention matrix for the same audio signal. For speech branch, the focus goes from low-frequency area to full frequencies and from local to global, showing that as the network goes deeper, the frequency-wise self-attention tends to capture global dependency along the frequency dimension. For noise branch, all four RA blocks show a local attention as white noises have a constant power spectral density.

4.5 Comparison with the State-of-the-Art

Speech Enhancement Table 2 shows the comparisons with state-of-the-art methods on Voice Bank + DEMAND. SEGAN (Pascual, Bonafonte, and Serra 2017) and MMSE-GAN (Soni, Shah, and Patil 2018) are two GAN-based methods. PHASEN (Yin et al. 2020) is a two-branch T-F domain approach where one branch predicts the amplitude and the other predicts the phase. Koizumi et al. (Koizumi et al. 2020) is a multi-head self-attention based method. Our method outperforms all of them in almost all metrics. The large improvements on PESQ, CSIG and COVL indicate that our method preserves better speech quality.

Table 3 shows the comparison with state-of-the-art methods on DNS Challenge dataset. TCNN (Pandey and Wang 2019) is a time-domain low-latency approach. We implemented two versions of it. ‘‘TCNN’’ is exactly the same as described in the paper and ‘‘TCNN-L’’ is the long-latency version using the same T-F domain loss function as ours. Conv-TasNet-SNR (Koyama et al. 2020) and DTLN (West-

Table 4: Two-speaker speech separation on TIMIT

Methods	SDRi(dB)	PESQ ²
Conv-TasNet	7.57	2.14
Ours	8.39	2.50

hausen and Meyer 2020) are real-time approaches. Multi-Scale+ (Choi et al. 2020) and PoCoNet (Isik et al. 2020) are non-real-time methods, among which the PoCoNet took 1st place in the 2020 DNS challenge’s Non-Real-Time track. Since narrow-band PESQ number was reported in the DTLN paper, we used the released model¹ to generate the enhanced speech and compute the metrics. For other methods, we use the numbers reported in their papers. Our method outperforms all of them by a large margin.

Extension to Speaker Separation As SN-Net can simultaneously model two signals, it is natural to extend it for speaker separation task. The merge branch is removed as two outputs are needed. Permutation invariant training (Yu et al. 2017) is employed during training to avoid the permutation problem. We conduct the two-speaker separation experiment based on the TIMIT corpus. The batch size is set to 16. For comparison, we train a non-causal version of Conv-TasNet (Luo and Mesgarani 2019), the state-of-the-art method, using the released code³.

The results are shown in Table 4. We use SDR improvement (SDRi) and PESQ for evaluation. Our method achieves a considerable gain on PESQ by 0.36 and SDRi by 0.82 dB, compared with Conv-TasNet. This suggests that our method is not limited to specific tasks and has the potential to extract different additive parts from a mixture signal.

5 Conclusion

We propose a novel two-branch convolutional neural network to interactively modeling speech and noises for speech enhancement. Particularly, an interaction between two branches is proposed to leverage information learned from the other branch to enhance the target signal modeling. This interaction makes the simultaneous modeling of two signals feasible and effective. Moreover, we design a sophisticated RA block for feature extraction of both branches, which can accommodate the diversities across speech and various noise signals. Evaluations verify the effectiveness of these modules and our method significantly outperforms the state-of-the-art. The two-signal simultaneous modeling paradigm makes it applicable to speaker separation as well.

References

Boll, S. 1979. Suppression of acoustic noise in speech using spectral subtraction. *IEEE Transactions on acoustics, speech, and signal processing* 27(2): 113–120.

¹<https://github.com/breizhn/DTLN>

²Note that Conv-TasNet outputs 8khz audios. We use narrow-band PESQ here instead of wide-band. Accordingly, we downsample audios to 8khz for our method to match this evaluation.

³<https://github.com/kaituoxu/Conv-TasNet>

- Choi, H.-S.; Heo, H.; Lee, J. H.; and Lee, K. 2020. Phase-aware Single-stage Speech Denoising and Dereverberation with U-Net. *arXiv preprint arXiv:2006.00687* .
- Choi, H. S.; Kim, J. H.; Huh, J.; and Kim, A. 2019. Phase-aware speech enhancement with deep complex U-Net .
- Ephrat, A.; Mosseri, I.; Lang, O.; Dekel, T.; Wilson, K.; Hassidim, A.; Freeman, W. T.; and Rubinstein, M. 2018. Looking to listen at the cocktail party: A speaker-independent audio-visual model for speech separation. *arXiv preprint arXiv:1804.03619* .
- Fan, C.; Liu, B.; Tao, J.; Yi, J.; Wen, Z.; and Bai, Y. 2019. Noise prior knowledge learning for speech enhancement via gated convolutional generative adversarial network. In *2019 Asia-Pacific Signal and Information Processing Association Annual Summit and Conference (APSIPA ASC)*, 662–666. IEEE.
- Fu, S.-W.; Tsao, Y.; Lu, X.; and Kawai, H. 2017. Raw waveform-based speech enhancement by fully convolutional networks. In *2017 Asia-Pacific Signal and Information Processing Association Annual Summit and Conference (APSIPA ASC)*, 006–012. IEEE.
- Gemmeke, J. F.; Ellis, D. P.; Freedman, D.; Jansen, A.; Lawrence, W.; Moore, R. C.; Plakal, M.; and Ritter, M. 2017. Audio set: An ontology and human-labeled dataset for audio events. In *2017 IEEE International Conference on Acoustics, Speech and Signal Processing (ICASSP)*, 776–780. IEEE.
- Hendriks, R.; Heusdens, R.; and Jensen, J. 2010. MMSE based noise PSD tracking with low complexity. In *2010 IEEE International Conference on Acoustics, Speech and Signal Processing (ICASSP)*, 4266–4269. IEEE.
- Hu, Y.; and Loizou, P. C. 2007. Evaluation of objective quality measures for speech enhancement. *IEEE Transactions on audio, speech, and language processing* 16(1): 229–238.
- Isik, U.; Giri, R.; Phansalkar, N.; Valin, J.-M.; Helwani, K.; and Krishnaswamy, A. 2020. PoCoNet: Better Speech Enhancement with Frequency-Positional Embeddings, Semi-Supervised Conversational Data, and Biased Loss. *arXiv preprint arXiv:2008.04470* .
- Kim, J.; El-Khamy, M.; and Lee, J. 2020. T-GSA: Transformer with Gaussian-Weighted Self-Attention for Speech Enhancement. In *ICASSP 2020-2020 IEEE International Conference on Acoustics, Speech and Signal Processing (ICASSP)*, 6649–6653. IEEE.
- Kim, J. H.; Yoo, J.; Chun, S.; Kim, A.; and Ha, J. W. 2018. Multi-domain processing via hybrid denoising networks for speech enhancement. *arXiv preprint arXiv:1812.08914* .
- Koizumi, Y.; Yaiabe, K.; Delcroix, M.; Maxuxama, Y.; and Takeuchi, D. 2020. Speech enhancement using self-adaptation and multi-head self-attention. In *ICASSP 2020-2020 IEEE International Conference on Acoustics, Speech and Signal Processing (ICASSP)*, 181–185. IEEE.
- Koyama, Y.; Vuong, T.; Uhlich, S.; and Raj, B. 2020. Exploring the Best Loss Function for DNN-Based Low-latency Speech Enhancement with Temporal Convolutional Networks. *arXiv preprint arXiv:2005.11611* .
- Li, X.; Song, J.; Gao, L.; Liu, X.; Huang, W.; He, X.; and Gan, C. 2019. Beyond rnns: Positional self-attention with co-attention for video question answering. In *Proceedings of the AAAI Conference on Artificial Intelligence*, volume 33, 8658–8665.
- Luo, Y.; and Mesgarani, N. 2019. Conv-tasnet: Surpassing ideal time–frequency magnitude masking for speech separation. *IEEE/ACM transactions on audio, speech, and language processing* 27(8): 1256–1266.
- Mohammadiha, N.; Smaragdis, P.; and Leijon, A. 2013. Supervised and unsupervised speech enhancement using nonnegative matrix factorization. *IEEE Transactions on audio, speech, and language processing* 21(10): 2140–2151.
- Nam, H.; Ha, J.-W.; and Kim, J. 2017. Dual attention networks for multimodal reasoning and matching. In *Proceedings of the IEEE Conference on Computer Vision and Pattern Recognition*, 299–307.
- Odelowo, B. O.; and Anderson, D. V. 2017. A noise prediction and time-domain subtraction approach to deep neural network based speech enhancement. In *2017 16th IEEE International Conference on Machine Learning and Applications (ICMLA)*, 372–377. IEEE.
- Odelowo, B. O.; and Anderson, D. V. 2018. A study of training targets for deep neural network-based speech enhancement using noise prediction. In *2018 IEEE International Conference on Acoustics, Speech and Signal Processing (ICASSP)*, 5409–5413. IEEE.
- Pandey, A.; and Wang, D. 2019. TCNN: Temporal convolutional neural network for real-time speech enhancement in the time domain. In *ICASSP 2019-2019 IEEE International Conference on Acoustics, Speech and Signal Processing (ICASSP)*, 6875–6879. IEEE.
- Pascual, S.; Bonafonte, A.; and Serra, J. 2017. SEGAN: Speech enhancement generative adversarial network. *arXiv preprint arXiv:1703.09452* .
- Rec, I. 2005. P. 862.2: Wideband extension to recommendation P. 862 for the assessment of wideband telephone networks and speech codecs. *International Telecommunication Union, CH–Geneva* .
- Reddy, C. K.; Gopal, V.; Cutler, R.; Beyrami, E.; Cheng, R.; Dubey, H.; Matushevych, S.; Aichner, R.; Aazami, A.; Braun, S.; et al. 2020. The INTERSPEECH 2020 Deep Noise Suppression Challenge: Datasets, Subjective Testing Framework, and Challenge Results. *arXiv preprint arXiv:2005.13981* .
- Salazar, J.; Kirchhoff, K.; and Huang, Z. 2019. Self-attention networks for connectionist temporal classification in speech recognition. In *ICASSP 2019-2019 IEEE International Conference on Acoustics, Speech and Signal Processing (ICASSP)*, 7115–7119. IEEE.
- Simonyan, K.; and Zisserman, A. 2014. Two-stream convolutional networks for action recognition in videos. *Advances in neural information processing systems* 27: 568–576.
- Soni, M. H.; Shah, N.; and Patil, H. A. 2018. Time-frequency masking-based speech enhancement using generative adversarial network. In *2018 IEEE International Conference on Acoustics, Speech and Signal Processing (ICASSP)*, 5039–5043. IEEE.
- Srinivasan, S.; Samuelsson, J.; and Kleijn, W. B. 2005a .
- Srinivasan, S.; Samuelsson, J.; and Kleijn, W. B. 2005b. Codebook driven short-term predictor parameter estimation for speech enhancement. *IEEE Transactions on audio, speech, and language processing* 14(1): 163–176.
- Sun, M.; Zhang, X.; Zheng, T. F.; et al. 2015. Unseen noise estimation using separable deep auto encoder for speech enhancement. *IEEE/ACM Transactions on Audio, Speech, and Language Processing* 24(1): 93–104.
- Tan, K.; and Wang, D. 2018. A Convolutional Recurrent Neural Network for Real-Time Speech Enhancement. In *Interspeech*, 3229–3233.

- Thiemann, J.; Ito, N.; and Vincent, E. 2013. The diverse environments multi-channel acoustic noise database: A database of multi-channel environmental noise recordings. *The Journal of the Acoustical Society of America* 133(5): 3591–3591.
- Valentini-Botinhao, C.; Wang, X.; Takaki, S.; and Yamagishi, J. 2016. Investigating RNN-based speech enhancement methods for noise-robust Text-to-Speech. In *SSW*, 146–152.
- Vaswani, A.; Shazeer, N.; Parmar, N.; Uszkoreit, J.; Jones, L.; Gomez, A. N.; Kaiser, Ł.; and Polosukhin, I. 2017. Attention is all you need. In *Advances in neural information processing systems*, 5998–6008.
- Veaux, C.; Yamagishi, J.; and King, S. 2013. The voice bank corpus: Design, collection and data analysis of a large regional accent speech database. In *2013 International Conference Oriental COCODA held jointly with 2013 Conference on Asian Spoken Language Research and Evaluation (O-COCODAS/CASLRE)*, 1–4. IEEE.
- Vincent, E.; Gribonval, R.; and Févotte, C. 2006. Performance measurement in blind audio source separation. *IEEE transactions on audio, speech, and language processing* 14(4): 1462–1469.
- Wang, H.; Zha, Z.-J.; Chen, X.; Xiong, Z.; and Luo, J. 2020. Dual Path Interaction Network for Video Moment Localization. In *Proceedings of the 28th ACM International Conference on Multimedia*, 4116–4124.
- Wang, L.; Li, Y.; Huang, J.; and Lazebnik, S. 2019. Learning two-branch neural networks for image-text matching tasks. *IEEE transactions on pattern analysis and machine intelligence* 41(2): 394–407.
- Wang, X.; Girshick, R.; Gupta, A.; and He, K. 2018. Non-local neural networks. In *Proceedings of the IEEE conference on computer vision and pattern recognition*, 7794–7803.
- Wang, Y.; and Brookes, M. 2017. Model-based speech enhancement in the modulation domain. *IEEE/ACM Transactions on Audio, Speech, and Language Processing* 26(3): 580–594.
- Wang, Y.; Narayanan, A.; and Wang, D. 2014. On training targets for supervised speech separation. *IEEE/ACM Transactions on Audio, Speech, and Language Processing* 22(12): 1849–1858.
- Westhausen, N. L.; and Meyer, B. T. 2020. Dual-Signal Transformation LSTM Network for Real-Time Noise Suppression. *arXiv preprint arXiv:2005.07551*.
- Williamson, D. S.; Wang, Y.; and Wang, D. 2015. Complex ratio masking for monaural speech separation. *IEEE/ACM transactions on audio, speech, and language processing* 24(3): 483–492.
- Wilson, K. W.; Raj, B.; Smaragdis, P.; and Divakaran, A. 2008. Speech denoising using nonnegative matrix factorization with priors. In *2008 IEEE International Conference on Acoustics, Speech and Signal Processing (ICASSP)*, 4029–4032. IEEE.
- Wisdom, S.; Hershey, J. R.; Wilson, K.; Thorpe, J.; Chinen, M.; Patton, B.; and Saurous, R. A. 2019. Differentiable consistency constraints for improved deep speech enhancement. In *ICASSP 2019-2019 IEEE International Conference on Acoustics, Speech and Signal Processing (ICASSP)*, 900–904. IEEE.
- Wu, Q.; Wang, W.; Chen, X.; and Li, W. 2019. Video prediction with temporal-spatial attention mechanism and deep perceptual similarity branch. In *2019 IEEE International Conference on Multimedia and Expo (ICME)*, 1594–1599. IEEE.
- Xia, Y.; Braun, S.; Reddy, C. K.; Dubey, H.; Cutler, R.; and Tashev, I. 2020. Weighted Speech Distortion Losses for Neural-Network-Based Real-Time Speech Enhancement. In *ICASSP 2020-2020 IEEE International Conference on Acoustics, Speech and Signal Processing (ICASSP)*, 871–875. IEEE.
- Xu, Y.; Du, J.; Dai, L.-R.; and Lee, C.-H. 2013. An experimental study on speech enhancement based on deep neural networks. *IEEE Signal processing letters* 21(1): 65–68.
- Xu, Z.; Elshamy, S.; and Fingscheidt, T. 2020. Using Separate Losses for Speech and Noise in Mask-Based Speech Enhancement. In *ICASSP 2020-2020 IEEE International Conference on Acoustics, Speech and Signal Processing (ICASSP)*, 7519–7523. IEEE.
- Yin, D.; Luo, C.; Xiong, Z.; and Zeng, W. 2020. PHASEN: A Phase-and-Harmonics-Aware Speech Enhancement Network. In *AAAI*, 9458–9465.
- Yu, D.; Kolbæk, M.; Tan, Z.-H.; and Jensen, J. 2017. Permutation invariant training of deep models for speaker-independent multi-talker speech separation. In *2017 IEEE International Conference on Acoustics, Speech and Signal Processing (ICASSP)*, 241–245. IEEE.
- Zhang, H.; Goodfellow, I.; Metaxas, D.; and Odena, A. 2019. Self-attention generative adversarial networks. In *International Conference on Machine Learning*, 7354–7363.