

# Detecting Video Game Player Burnout with the Use of Sensor Data and Machine Learning

<sup>1</sup>Anton Smerdov, <sup>1</sup>Andrey Somov, <sup>1</sup>Evgeny Burnaev, <sup>2</sup>Bo Zhou, <sup>2</sup>Paul Lukowicz

<sup>1</sup>Skolkovo Institute of Science and Technology, CDISE, Moscow, Russia

<sup>2</sup>German Research Centre for Artificial Intelligence, Kaiserslautern, Germany

**Abstract**—Current research in eSports lacks the tools for proper game practising and performance analytics. The majority of prior work relied only on in-game data for advising the players on how to perform better. However, in-game mechanics and trends are frequently changed by new patches limiting the lifespan of the models trained exclusively on the in-game logs. In this article, we propose the methods based on the sensor data analysis for predicting whether a player will win the future encounter. The sensor data were collected from 10 participants in 22 matches in League of Legends video game. We have trained machine learning models including Transformer and Gated Recurrent Unit to predict whether the player wins the encounter taking place after some fixed time in the future. For 10 seconds forecasting horizon Transformer neural network architecture achieves ROC AUC score 0.706. This model is further developed into the detector capable of predicting that a player will lose the encounter occurring in 10 seconds in 88.3% of cases with 73.5% accuracy. This might be used as a players' burnout or fatigue detector, advising players to retreat. We have also investigated which physiological features affect the chance to win or lose the next in-game encounter.

**Index Terms**—eSports, dataset, machine learning, psychophysiological assessment, sensing, video games

## I. INTRODUCTION

In the last several years, eSports has progressed from casual entertainment to a fully-recognizable competitive discipline. In 2019 its global audience achieved 443 million and with total revenue of 958 million dollars [1]. Prize pools for top-tier eSports tournaments achieve tens of millions of US dollars, thus making competition between professional teams very high. This creates a demand for tools aimed at training and analytics in eSports.

However, despite the recognition as a sport in many countries, eSports is still in the infancy period. There are no many training methodologies or widely accepted methods for analytics. From the players' point of view, it is unclear how to improve skills in a particular game except for regular training, watching how professional players perform, and communicating with the eSports community. These methods are pretty straightforward, and there is a lack of tools providing feedback about the player performance and instructing how to play better.

Current methods usually rely on the analysis of in-game data obtained from game logs, such as kills/deaths/assists events, abilities learned, players' positioning, and other in-game statistics. This information can be helpful in player skill assessment, performance evaluation, match outcome prediction, and post-match analysis. However, current methods usually rely on

the analysis of in-game data only and do not consider data from the physical world. Physiological data may provide new insights into players' behavior. Sometimes these data may be more suitable for the eSports domain since models trained on in-game data only quickly become obsolete when a new patch is released. Sensor data can supplement logs obtained from in-game data to provide additional information for predictive models and potentially improve their performance.

A major flaw of the models trained on in-game data only is their short lifespan. These models capture tight dependencies between in-game parameters and targets, but when rules or game mechanics change, previous connections might not be preserved. Since patches and updates in eSports are systematic, models trained on in-game data should be constantly updated, which is not convenient in practice. In contrast, the models trained on real-world sensor data do not depend on the game updates much; thus, they are more robust, long-lasting, and production-friendly.

Although the usage of sensor data in eSports has been previously explored, prior research usually focuses on the data from one sensor only [2]. It significantly limits the insights explored since the multi-sensor dependencies are not captured. Also, using a single sensor it is not possible to figure out which sensors are more important.

In this paper, we present an analysis of sensor data collected from 10 participants playing League of Legends. Data collected include chair movements, hand, and head movements, pulse, saccades, muscle activity, galvanic skin response, mouse and keyboard activity, facial skin temperature, EEG, environmental temperature and relative humidity,  $CO_2$  level, and pulse oximeter data. We utilize this data to predict outcomes of encounters extracted from in-game logs using machine learning algorithms. The best models achieve a 0.706 ROC AUC score in forecasting whether a player will win the encounter taking place 10 seconds later in the game. It also achieves precision of 73.5% with a recall of 88.3% in detecting that a player will lose the next encounter. In other words, the model can detect if the player will lose the fight occurring in 10 seconds in 88.3% of cases with 73.5% accuracy.

A contribution of this paper is the collection of eSports related physiological data, their processing, and consequent analysis for both professional and amateur players. We describe the whole pipeline from the data collection to the interpretation of predictions made by machine learning and deep learning models. In particular, we propose a sensor network architecture for data collection in the eSports domain,

a methodology for the experiment organization, techniques to extract relevant features from the data, automatic methods for encounters extraction and annotation from in-game logs, and models for encounter outcome prediction.

The novelty is the experimentation with the professional eSports athletes and amateur players specializing in League of Legends discipline; predicting player performance relying solely on sensor data.

This paper is organized as follows: in Section II we overview current methods utilizing sensor data for eSports analytics; in Section III we present a sensing platform for data collection and methodology; in Section IV we describe data preprocessing and a method for automatic encounter annotation; in Section V we overview machine learning algorithms and their results; in Section VI we discuss the results and provide concluding remarks.

## II. RELATED WORK

Current research in eSports is mainly formed by a wide group of studies concentrated on in-game data analysis and small scope of work focused on the analysis of psychophysiological data in eSports. In this section, we cover both types of studies with a primary focus on research involving sensor data.

### A. Sensor Data in eSports Research

Despite the growing popularity of eSports research involving psychophysiological data in the last several years, there isn't much prior work in this field. The main challenges are the difficulty and expensiveness of data collection and annotation, lack of professionals involved, and sensor data processing.

Authors in [3] propose to use data from eye tracker to describe traits of professional players in terms of visual fixations, or saccades. They argue that pros have more variable fixation durations than amateur players. The authors also identified that the difference between ambient and focal fixations are more expressed for high-skilled players. A similar idea is explored in [4], where authors managed to classify players into professionals and amateurs using reaction time extracted from eye tracker data. They estimate the total reaction time as a sum of saccadic latency, the time between saccade and fixation, and the time for aiming and shooting. Research in [2], [5] also supports that Pro-players eye-movement patterns are more diverse and swifter.

Another idea is to use EEG data to understand how players react to game events. In [6] authors demonstrated that negative game events decrease EEG alpha rhythms power spectra frequencies, while positive game events increase it. The authors also showed the opposite relation to the theta rhythm. Work by Meneses-Claudio et al. [7] identified that a professional player has fewer variations in the EEG signal than an amateur player.

Activity on a chair can also be used to separate experienced and amateur players. Work by Smerdov et al. [8] showed that features obtained from accelerometer and gyroscope integrated into a game chair provide a valuable signal about player skill in Counter-Strike: Global Offensive. This work is extended in

[9], where authors additionally investigated how players react to game events in terms of chair movements. It turned out that professionals don't react to game events as much as newbie players. Also, the authors showed that the Pro-players moves in a chair less frequently, but their movements are swifter.

An abundant and natural source of data for eSports is mouse and keyboard activity. Authors in [10] investigated the connection between players' skill in Counter-Strike: Global Offensive and data from mouse, keyboard, and eye tracker. They identified the frequency and duration of keyboard strokes as the most important features. In [11] authors presented a dataset with mouse, keyboard, and galvanic skin response data for League of Legends players but didn't draw any conclusions. Kaminsky et al. [12] showed that mouse activity might be used for player re-identification.

### B. In-game Data in eSports Research

In-game activity is a common source of data for eSports research. It is utilized in many research directions, including skill assessment, match outcome prediction, toxic behavior detection, etc.

A straightforward usage of in-game data is match outcome prediction. Several studies showed that the information about hero draft could be used to predict the match outcome in the MOBA genre [13]–[16]. Such models have a direct practical application as draft recommendation systems.

Another possibility to predict the match outcome is to use in-game statistics like kills, deaths, gold, abilities learned, etc. This approach showed that, to some extent, match outcome could be predicted in the MOBA genre [17]–[20] and first-person shooter (FPS) genre [21]. More complex models also try to interpret model results [22], [23], or calibrate confidence of a prediction [24].

A popular subfield of eSports research is toxic behavior detection. Studies in this area cover automatic toxicity detection with natural language processing techniques [25], investigation of how participants interact with toxic players [26].

### C. Sensor Data in Skill Assessment

Sensor data is already used for skill assessment in other domains.

A popular domain for skill assessment by sensor data is surgery. Surgeon expertise is shown to be connected with data from eye tracker [27], pressure sensors [28], and IMUs [29], [30].

Physiological data is a natural source of information in sports. Players' movements captured by accelerometer and gyroscope located on different body parts might help to estimate player skill in tennis [31], [32]. Similar techniques utilizing data from IMU have been employed for skill estimation in soccer [33], golf [34], climbing [35], volleyball [36], and gym exercising [37], [38].

Sensor data have also been used for estimating a skill level in other activities such as dancing [39], clay kneading [40], and mold polishing [41].

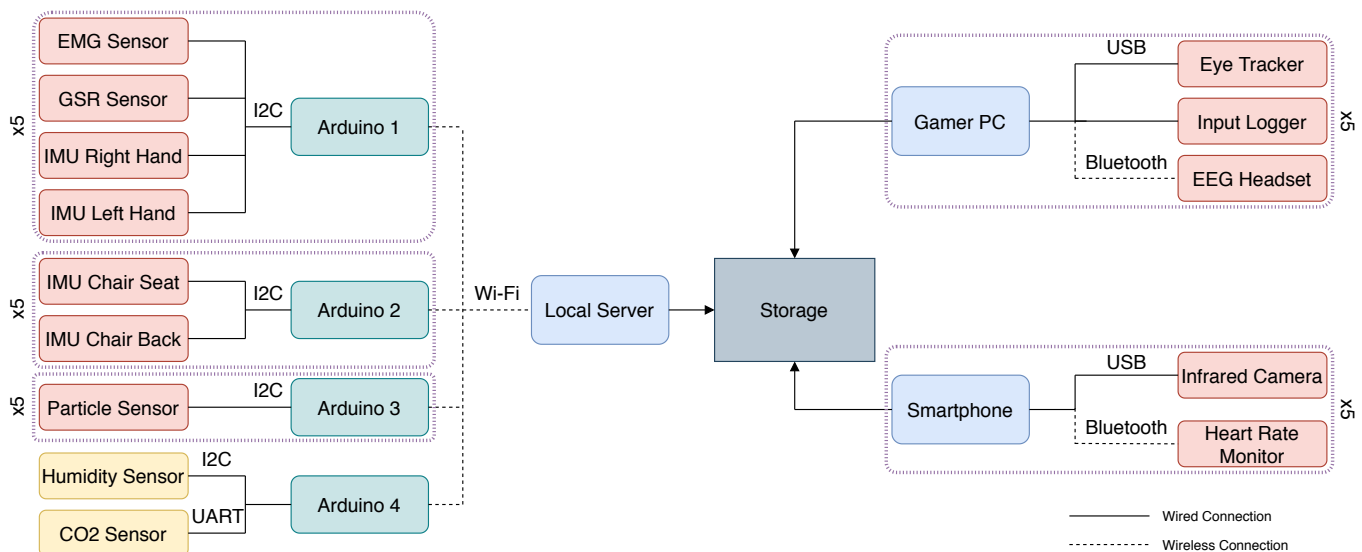

Fig. 1: Sensor network architecture.

TABLE I: Sampling rates for sensor data collected.

Sensor name	Sensor model	Primary device	Interface	Sampling rate, Hz
EMG sensor, right hand	Grove EMG Sensor v1.1 <sup>1</sup>	Arduino 1	Analog	36
EMG sensor, left hand				
GSR sensor	Grove GSR Sensor v1.2 <sup>2</sup>	Arduino 2	I2C	65
IMU, right hand	Bosch BNO055 <sup>3</sup>			
IMU, left hand				
IMU, chair seat IMU, chair back				
Pulse-oximeter sensor	Maxim MAX30102 <sup>4</sup>	Arduino 3		16-25
CO <sub>2</sub> sensor	MH-Z19B <sup>5</sup>	Arduino 4	UART	1
Environmental sensor	Bosch BME280 <sup>6</sup>		I2C	
Eye tracker	Tobii 4C	Gamers' PC	USB	90
EEG Headset	Emotiv Insight <sup>7</sup>	PC	Bluetooth	8
Thermal camera	Flir One <sup>8</sup>	Smartphone	USB	0.2
Heart rate monitor	Polar OH1 <sup>9</sup>		Bluetooth	1

### III. DATA COLLECTION

#### A. Sensing Platform

To ensure proper data collection in an active gaming scenario, we developed a wearable sensing system comprising of several sensors. The sensor network architecture for data collection is shown in Fig. 1. Specific sensor models, connection interfaces, and sampling rates are shown in Table I.

Each sensing device was controlled by a primary device, such as a PC or Arduino. The first group of sensors consisting of two electromyography (EMG) sensors, two IMU's and a galvanic skin response (GSR) sensor was connected to

Arduino 1. IMUs located under the chair seat and on the chair back were managed by Arduino 2. The particle sensor was operated by Arduino 3. Environmental and CO<sub>2</sub> sensors were connected to Arduino 4. Gaming PCs logged data from the eye tracker, keyboard, and mouse. Smartphones collected data obtained by thermal cameras and heart rate monitors.

We synchronized all logging devices using an NTP server. Considering the network delay and time desynchronization during the experiment, we estimate the maximum time divergence as 500 ms.

We constructed five copies of a sensing system for simultaneous data collection for five players. To ensure the synchronization of sensor data, we developed a control panel, which allowed us to start and end measurements simultaneously, synchronize time using NTP server, and monitor the status of measurements. The interface of the control panel is shown in Fig. 4. Devices were communicated via UDP protocol over the local Wi-Fi network.

A wide range of sensors allowed us to capture various indicators of players physiology, including:

- Lower arm muscle activity as a signal from EMG sensors. It corresponds to intensities of mouse clicks, keystrokes, and general hand movements. EMG data are also corre-

<sup>1</sup>[https://wiki.seeedstudio.com/Grove-EMG\\_Detector/](https://wiki.seeedstudio.com/Grove-EMG_Detector/)

<sup>2</sup>[https://wiki.seeedstudio.com/Grove-GSR\\_Sensor/](https://wiki.seeedstudio.com/Grove-GSR_Sensor/)

<sup>3</sup><https://www.bosch-sensortec.com/products/smart-sensors/bno055.html>

<sup>4</sup><https://www.maximintegrated.com/en/products/interface/sensor-interface/MAX30102.html>

<sup>5</sup>[https://www.winsen-sensor.com/d/files/infrared-gas-sensor/mh-z19b-co2-ver1\\_0.pdf](https://www.winsen-sensor.com/d/files/infrared-gas-sensor/mh-z19b-co2-ver1_0.pdf)

<sup>6</sup><https://www.bosch-sensortec.com/products/environmental-sensors/humidity-sensors-bme280/>

<sup>7</sup><https://www.emotiv.com/insight/>

<sup>8</sup><https://www.flir.eu/flir-one/>

<sup>9</sup><https://www.polar.com/en/products/accessories/oh1-optical-heart-rate-sensor>

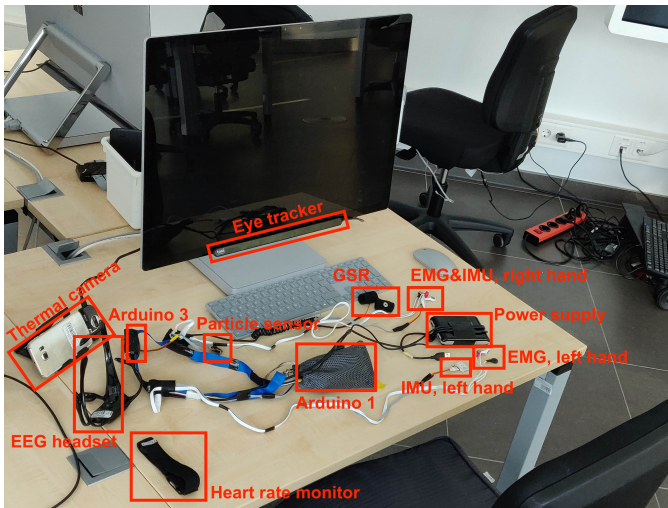

Fig. 2: Experimental testbed.



Fig. 3: Sensors integrated into a chair.

spond to physical tension of players [42].

- Additional data about hand movements obtained from IMUs located on both hands.
- Person arousal as a skin resistance captured by the GSR sensor [43].
- Pulse data collected by heart rate monitor on the upper arm. High pulse implies mental stress and arousal [44].
- Saccades and eye movement activity recorded by the eye tracker. That provides evidence on how players process visual information in the game, such as a minimap, players positioning, etc.
- Players' activity on a chair as data from IMU sensors located under the chair seat and back. Too intense or frequent movement might be related to high levels of stress [45].
- Facial skin temperature captured by the infrared camera as an indicator of mental load and concentration [46].
- EEG signal as a descriptor of brain activity. EEG headsets also include an IMU providing information about players' head movements.

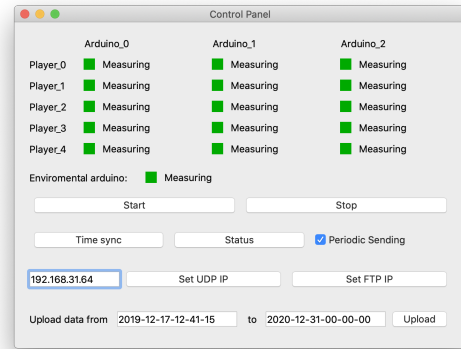

Fig. 4: A control panel used for sensors' time synchronization.

- Environmental conditions as relative humidity, CO<sub>2</sub> level, and temperature. Uncomfortable environmental conditions were shown to affect human cognitive abilities [47]–[49].

The implementation of the sensing system is shown in Fig. 2 and Fig. 3.

### B. Data Collection Methodology

We invited a professional and an amateur team to participate in the experiments. Each team played 11 matches in League of Legends over 3 experimental days. A process of data collection is shown in Fig. 5. Participants were located in the same room and played up to 4 matches on each experimental day with short breaks.

Game client versions varied from 9.22.296.5720 to 9.24.300.6382 since matches were played on several experimental days. A typical game interface is presented in Fig. 6.

After each match, participants reported if sensing system disturbed them during the game. In 17.5% of responses, players weren't concerned about the sensing system; 69.7% reports indicate a slight discomfort, 12.8% of records indicate a considerable disturbance caused by the sensing system.



Fig. 5: Data collection process.



Fig. 6: Game interface.

### C. In-game Data Collection

To obtain information about game events, we used API provided by Riot<sup>10</sup> (League of Legends developer). For each match, we obtained a sequence of in-game events. Typical events parsed are CHAMPION\_KILL, BUILDING\_KILL, SKILL\_LEVEL\_UP, WARD\_PLACED, ITEM\_PURCHASED, etc. The main event we used is CHAMPION\_KILL, which indicates a character being killed, killing and assisting characters, a timestamp, and a location.

## IV. DATA ANALYSIS

To extract a meaningful signal from the data, we preprocessed both sensor data and in-game data.

### A. Sensor Data Preprocessing

Some sensors don't provide a signal as a time series (e.g. mouse, keyboard) or provide uninterpretable raw data (e.g. EMG, GSR). To convert these data into a meaningful signal, we used signal preprocessing described in Table II. Raw signals from some sensors (e.g. heart rate, CO<sub>2</sub> level, EEG band power) are directly interpretable, so we didn't modify it at this point.

After all sensor data were converted to time series, we resampled the data to a common *time step*  $\Delta t$ . All values inside  $\Delta t$  intervals were averaged; if there aren't any values in

<sup>10</sup><https://developer.riotgames.com/>

the interval we used the last available value.  $\Delta t$  is an important hyperparameter determining the fidelity of data representation and indicating how often new data are available to predictive models. In our work we used  $\Delta t = 1$  second.

Sensor data include a lot of noise, which can destabilize machine learning algorithms. To reduce the impact of noise in our models, we got rid of outliers by clipping a signal between 0.05 and 0.995 quantiles. We also smoothed data from all sensors with an exponential moving average [50] using 5 seconds as a half-life interval.

The resulting signal obtained is shown in Fig. 7. Vertical lines correspond to positive and negative player's impact in encounters, which are described in Subsection IV-B.

After preprocessing, we get a sequence of 72-dimensional feature vectors  $\mathbf{x}(t) \in \mathbb{R}^{72}$ .

### B. In-game Data Preprocessing

An encounter is an event when two or more heroes from opposite teams are fighting with each other. The key idea is that players may perform well in the encounter even if their characters die and don't make any direct kills. Instead, players may successfully assist allied heroes in the fight by contributing healing or damage and don't kill any enemy. To deal with this problem, we propose to calculate a player's impact on the encounter as a cumulative sum of positive and negative in-game events normalized by the number of players participating in the encounter. That metric should properly score players with supportive roles since they aren't making many kills in the game.

From parsed in-game logs, we have a sorted sequence of game event  $\{e(t_j)\}$  for each player, where  $t \in \mathbb{R}_+$  is a timestamp. An event  $e(t)$  corresponds to either kill, death or assist. For an event occurring at moment  $t$ , we denote  $N(t) \in \mathbb{N}$  the number of players participating in the event as killers or assistants, and  $i(t) \in \mathbb{R}$  player's impact in the event. It is reasonable to assume that player's impact is positive in kill/assist events and negative in death events. Also, it's rational to normalize player's impact in the event by the number of participating players, so we used the following formula to calculate the player's impact:

$$i(t) = \begin{cases} \frac{+1}{N(t)} & , \text{ if event } e(t) \text{ is kill or assist} \\ -1 & , \text{ if event } e(t) \text{ is death} \end{cases} \quad (1)$$

TABLE II: Sensor data preprocessing.

Sensor	Raw Data	Processed Data
EMG	Voltage measured by electrodes.	We calculated muscle activities for both hands as absolute deviations from the reference levels. Reference levels were calculated as median values.
IMU (right&left hand, chair seat&back, head)	Linear acceleration, angular velocity, etc.	The sensors are not calibrated perfectly, so we subtracted the reference level calculated as a median value for linear acceleration and angular velocity and used absolute values of the signal as an indicator of movement activity.
Mouse	Click events, mouse position events.	The number of mouse clicks in the last 5 seconds, the total distance traveled in the last 5 seconds.
Keyboard	Key pressed/released events.	The number of buttons pressed in the last 5 seconds.
Eye tracker	Gaze position in $(x, y)$ coordinates.	The total distance passed by gaze in the last 5 seconds and pupil diameter.
Facial skin temperature	48x64 heatmap.	95-th percentile of values in the heatmap as an estimation of facial skin temperature.
Particle sensor	The intensity of infrared and red lights passed through the earlobe.	Oxygen saturation (SpO <sub>2</sub> ).

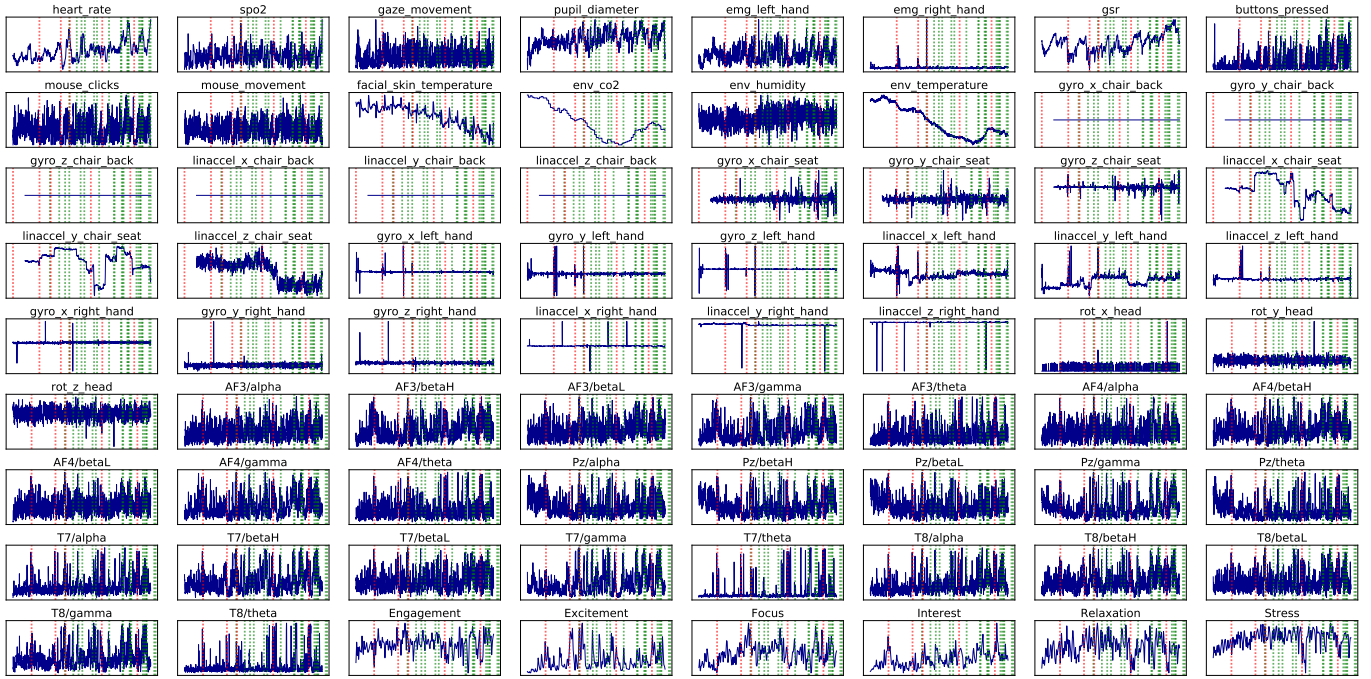

Fig. 7: Sensor data collected for one player in one match. Green and red vertical lines correspond to encounters with positive and negative outcomes, respectively.

Equation 1 ensures that the total impact of all players sums up to zero.

Normalization by a number of participating heroes ensures that a player's impact is not overestimated when she makes a frag as a part of a team. However, it's incorrect to estimate player performance by a single event only. We propose to aggregate player impact over a sequence of adjacent events, or encounter, to estimate her performance more precisely.

In League of Legends, an encounter typically consists of several events (kill, death, assist) occurring in a short period of time, while the interval between encounters is much longer. We propose to group events into encounters such that the interval between any events from different encounters exceeds some minimum interval  $T$ .

That defines a sequence of encounters  $\{E(t_j)\}$ , where each encounter  $E(t_j) = \{e(t_j), e(t_{j+1}), \dots, e(t_{j+k_j})\}$  consists of  $k_j$  events, such that  $0 \leq t_{i+1} - t_i \leq T \forall i \in \{j+1, \dots, j+k_j-1\}$ , and also the interval between events from different encounters are more than  $T$ . We denote the timestamp of the encounter as a timestamp of the first event in it. We used  $T = 10$  seconds as a reasonable minimum interval between two encounters.

To calculate a player's impact in each encounter, we summarized all impacts for the events in the encounter:

$$I(t) = \sum_{i(t') \in E(t)} i(t'), \quad (2)$$

where  $I(t)$  is the player's impact for the encounter started at moment  $t$ . The impact  $I(t)$  is positive when the player performs well and is negative when the player plays poorly.

$I(t)$  is a proper metric for performance evaluation: positive values mean that player contributed to kills or assists events

and probably didn't die. In opposite, negative values mean that played died in the encounter and didn't contribute much to the fight. If  $I(t)$  equals 0, we reassign it to the sign of the first event in the encounter.

However, it's more convenient to work with it as a binary value for better interpretability. We binarized the target value:

$$\tilde{y}(t) = \text{sign}(I(t)), \quad (3)$$

where  $\tilde{y}(t)$  equals 1 if player performed well in the encounter at timestep  $t$ , and equals  $-1$  otherwise.

Encounter outcome suppose to estimate players performance better than classical metrics like Kill Death Ratio [51], since these metrics underestimate players in supportive roles and don't utilize the encounter-like nature of game events.

A natural idea is to predict whether player will perform good in the next encounter by sensor data. We use *forecasting horizon* hyperparameter  $\tau$  to define how much time before the encounter we are trying to predict how player will perform. That leads us to the final target value:

$$y_\tau(t) = \tilde{y}(t + \tau), \quad (4)$$

where  $y_\tau(t)$  is a target indicating if the player will have a good impact in the fight occurring  $\tau$  seconds later.

### C. Dataset and Evaluation

Since both teams participated in 3 experimental days, we used data from the first two experimental days for training and data from the third experimental day for testing.

As input data for machine learning algorithms, we used sequences of 72-dimensional feature vectors (see Subsection IV-A) for each match and player. As a target, we utilized

$y_\tau(t)$ , indicating whether a player will have a positive or negative impact in the encounter  $\tau$  seconds later (see Subsection IV-B).

To ensure proper scaling of data for machine learning methods, we standardized data for each player, match, and feature to zero mean and unit variance. Missed values were filled using linear interpolation or median values.

The total number of encounters in the dataset is 888. 56.1% of them belong to the positive class; 43.9% belong to the negative class. We used ROC AUC [52] as an evaluation metric as it properly suits a balanced binary classification task. It ranges from 0 to 1 and achieves a 0.5 score for random guess (even for unbalanced data). Higher values are better. At first, we calculated scores for each player and then averaged them for all participants. That ensures that models are evaluated on how they estimate players' performances instead of separating newbies and experienced players.

## V. MACHINE LEARNING

### A. Methods Overview

We utilized several models for prediction of encounter outcomes. Some of them (GRU, transformer) are designed for Seq2Seq problems like ours, while others (Logistic regression, KNN) don't take the sequential nature of data into account. All these models use sensor data as input. To check if sensor data is helpful for prediction, we compared above mentioned methods with baseline model, which didn't utilize sensor data.

- 1) **Baseline model.** This model uses the last observed target value as a prediction. For example, it predicts  $\hat{y}_\tau(t) = 1$  if at the moment  $t$  the latest observed target was positive, and  $\hat{y}_\tau(t) = 0$  if at the moment  $t$  the latest observed target was negative. In other words, the model predicts the last seen target value for the encounter occurring  $\tau$  seconds later.

The baseline model doesn't utilize sensor data, and this allows us to check how access to sensor data could improve the quality of predictions. Also, this model is the only model utilizing target values during the inference.

- 2) **Logistic Regression.** A simple linear method for data classification [53]. It outputs a probability that a feature vector  $\mathbf{x}(t) \in \mathbb{R}^n$  belongs to the positive class:

$$P(y_\tau(t) = 1 | \mathbf{x}(t)) = \frac{1}{1 + \exp(-\langle \mathbf{w}, \mathbf{x}(t) \rangle + b)}, \quad (5)$$

- 3) **KNN**, or k-nearest neighbors algorithm for data classification [54]. It makes a prediction based on a similarity in a feature space. We found  $k = 96$  to be the optimal hyperparameter in our experiments.
- 4) **Gated recurrent unit (GRU) neural network** [55]. This is a type of recurrent neural network utilizing gating mechanism for better information flow. More specifically, GRU incorporates update gate  $\mathbf{z}(t)$  and reset gate  $\mathbf{r}(t)$ . The update gate controls how new input changes the network hidden state  $\mathbf{h}(t)$ , while the reset gate is responsible for keeping or resetting the previous value of the hidden state. Formally:

$$\mathbf{h}(t) = (1 - \mathbf{z}(t)) \odot \mathbf{h}(t - \Delta t) + \mathbf{z}(t) \odot \tilde{\mathbf{h}}(t), \quad (6)$$

$$\tilde{\mathbf{h}}(t) = \tanh(\mathbf{W}_h \mathbf{x}(t) + \mathbf{U}_h (\mathbf{r}(t) \odot \mathbf{h}(t - \Delta t)) + \mathbf{b}_h), \quad (7)$$

$$\mathbf{z}(t) = \sigma(\mathbf{W}_z \mathbf{x}(t) + \mathbf{U}_z \mathbf{h}(t - \Delta t) + \mathbf{b}_z), \quad (8)$$

$$\mathbf{r}(t) = \sigma(\mathbf{W}_r \mathbf{x}(t) + \mathbf{U}_r \mathbf{h}(t - \Delta t) + \mathbf{b}_r), \quad (9)$$

where  $\mathbf{W}_h, \mathbf{W}_z, \mathbf{W}_r, \mathbf{U}_h, \mathbf{U}_z, \mathbf{U}_r, \mathbf{b}_h, \mathbf{b}_z, \mathbf{b}_r$  are the learnable parameters,  $\sigma$  is the sigmoid function,  $\odot$  is Hadamard product.

GRU is similar to LSTM, but it benefits from a fewer number of parameters. In our experiments, GRU performed better than LSTM. In our experiments the best GRU network had one recurrent layer with hidden size 64 and two subsequent linear layers. The GRU architecture is shown in Fig. 8. We used ReLU activation for linear layers [56] and sigmoid activation for the network output.

- 5) **Transformer neural network.** It was proposed in [57] to better deal with problems in natural language processing, but it was found to work well in time series forecasting [58]. The transformer architecture eschews recurrence and instead relies entirely on an attention mechanism to draw global dependencies between input

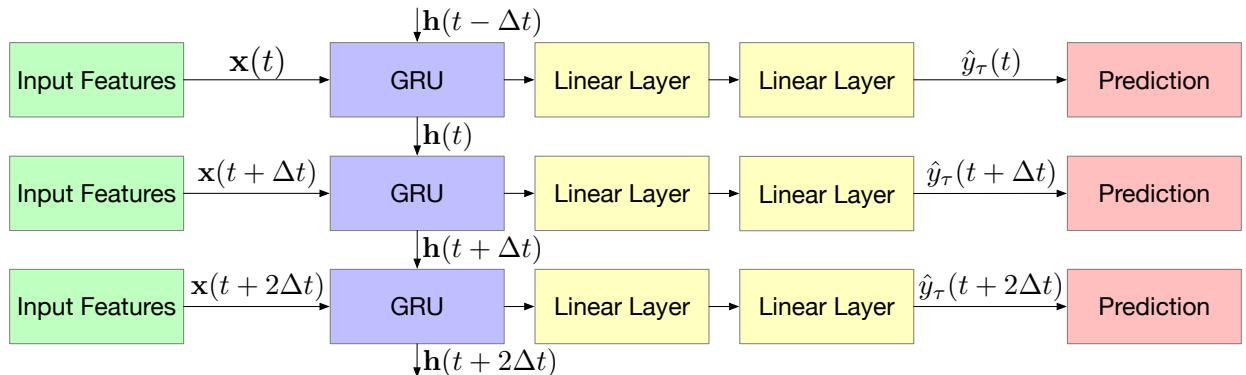

Fig. 8: Gated recurrent unit network architecture.

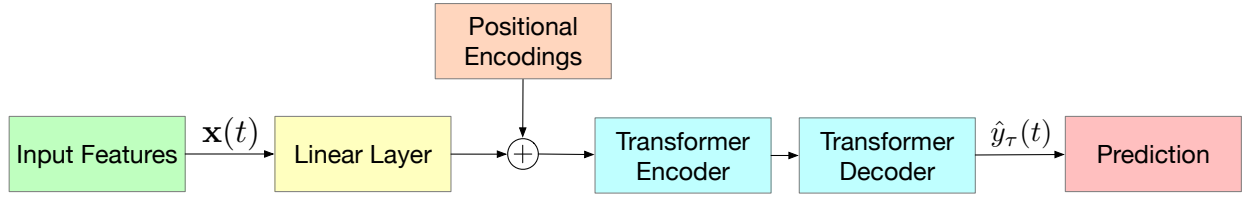

Fig. 9: Transformer network architecture.

and output. To utilize the sequential nature of data, transformer architecture utilized positional encoding:

$$PE_{(pos,2i)} = \sin(pos/10000^{2i/d}), \quad (10)$$

$$PE_{(pos,2i+1)} = \cos(pos/10000^{2i/d}), \quad (11)$$

where  $pos$  is the position,  $i$  is the dimension,  $d$  is the number of embedding dimensions (we used  $d = 64$ ). Positional encodings are added to embeddings of sensor data to represent the current timestamp.

The transformer also incorporates stacked encoder-decoder architecture for high-level feature representation, position encoding for capturing the spatial location of inputs, and multi-head attention blocks for focusing on the most important features. In our experiments, we used a transformer model with 1 layer for encoder and decoder, 8 heads for multi-head attention, size of fully-connected layer equals 512, and dropout equals 0.5. To convert sensor data into proper embeddings, we added a 64-dimensional linear layer before the trans-

former encoder. Outputs of the transformer decoder were normalized to  $[0,1]$  interval with sigmoid function to represent probability.

We used `scikit-learn`<sup>11</sup> python library for logistic regression and KNN implementations. For GRU and transformer networks, we utilized `pytorch`<sup>12</sup>. Networks were optimized by Adam optimizer [59] with standard parameters ( $\alpha = 0.001, \beta_1 = 0.9, \beta_2 = 0.999, \epsilon = 10^{-8}$ ).

### B. Results

We have trained the above-mentioned machine learning models on the dataset described in Subsection IV-C for varying forecasting horizons  $\tau$ . The results are illustrated in Fig. 10. We averaged results of 5 reruns for each algorithm.

Short forecasting horizons like 5 or 10 seconds ensure higher scores because models need to predict encounter outcomes in the nearest future. Scores are naturally decreasing when the forecasting horizon increases; however, there is a

<sup>11</sup><https://scikit-learn.org/>

<sup>12</sup><https://pytorch.org/>

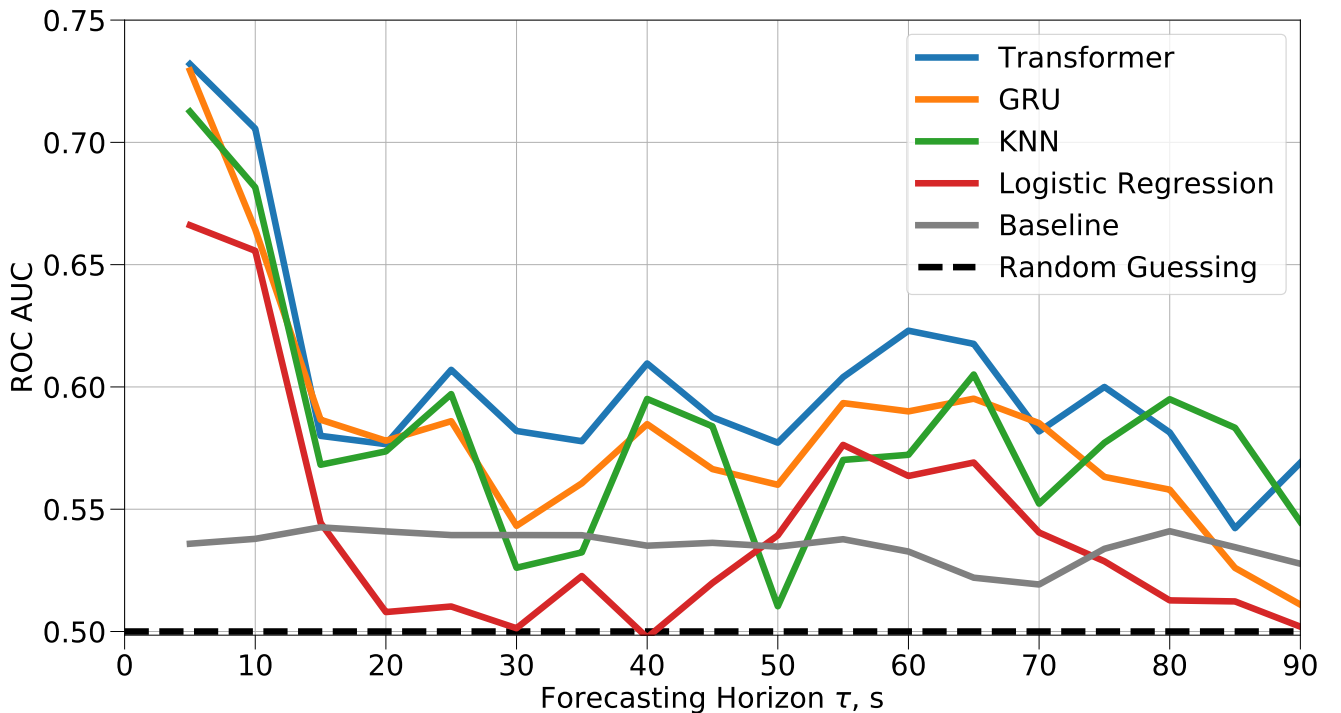

Fig. 10: Comparison of different algorithms w.r.t. forecasting horizon.

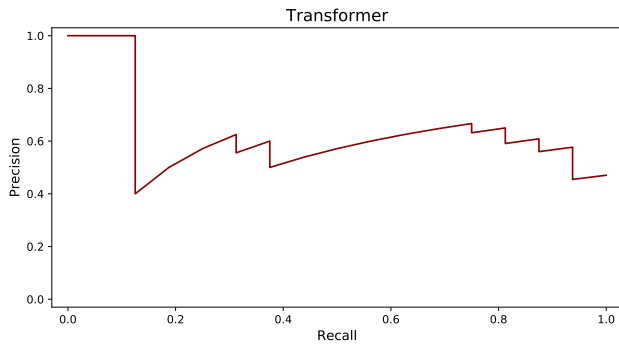

Fig. 11: A sample of precision-recall curve for a transformer model for one player and forecasting horizon  $\tau = 10$  seconds. Here we used encounter loss as a positive class.

slight increase in scores near 50-70 seconds. The possible explanation is that the result of the fight occurring after 50-70 seconds might be the same as the fight occurring after 5-10 seconds because a typical champion respawn time in League of Legends is 20-40 seconds, so the next encounter has a high chance to occur in 20-30 seconds after the respawn.

Interestingly, one of the worst-performing models is a baseline model, which doesn't utilize sensor data at all, but uses a history of encounter outcomes instead. This might imply that sensor data can provide more insights about the player condition rather than in-game records.

We suppose that  $\tau = 10$  seconds forecasting horizon is a sweet spot in terms of predictive power and potential usage. We further focus on the analysis of the transformer model, which is the best for this forecasting horizon.

One of the potential applications of trained models is a player's state assessment. If a model predicts that a player is likely to lose the next encounter (i.e., because of burnout, fatigue), it might suggest the player to retreat or to stick to a more defensive strategy. In opposite, if the algorithm predicts that the player is in good form, she might make riskier in-game decisions.

To check the possibility of creating a player's burnout detection system, we checked the precision and recall of the best models. For a transformer and forecasting horizon  $\tau = 10$  seconds, a typical precision-recall curve is shown in Fig. 11.

For each player, we selected a probability threshold value on training data, such that a recall for encounter losses is less or equals 50%. Then we binarized predictions according to the thresholds estimated for each player. The mean precision of such predictions for all players was 73.5%, and the mean recall is 88.3%. In other words, the model managed to detect that a player will lose the next fight 10 seconds in advance in 88.3% of cases with 73.5% accuracy. A potential system's user can adjust thresholds to increase recall at the expense of precision, or vice versa.

### C. Feature Importance

To understand attributes influencing player performance and to evaluate the contribution of each individual sensor into the resulting model, we calculated feature importances as

coefficients in logistic regression. High positive coefficients for features imply that these features are generally higher before the encounter win and lower before the encounter loss. In opposite, lesser negative coefficients mean that corresponding features are usually lower before the encounter win and higher before the encounter loss. More important sensors have more features with high absolute values for coefficients.

We have calculated feature importances for all 72 features and presented the top-25 highest and the top-30 lowest in Fig. 12. The features are colored corresponding to the sensor which obtained this feature.

The feature indicating good in-game activity the most is the intensity of gamma waves for the T7 electrode located near the left temple. The higher intensity of gamma waves is connected with better cognition performance, selective attention, and conscious perception of visual objects [60]. Prior research in [6] also showed the increased intensity of theta-waves for positive game events.

Another activity indicating that a player has a higher chance of winning the next encounter is mouse activity: the number of mouse clicks in the last 5 seconds `mouse_clicks` and distance traveled `mouse_movement` in the last 5 seconds. Higher heart rate, and eye activity (feature `gaze_movement`) also increase the player's performance. A possible explanation is that higher heart rate mobilizes players, and higher eye activity demonstrates better awareness of the game screen.

The most important indicator that the player is prone to lose the next fight is a vertical movement of the chair (feature `linaccel_z_chair_seat`). This probably corresponds to events when the player changes the posture on the chair or adjusts the chair's height, and then got an unexpected fight. This feature has also been reported by [8] as the most intrinsic for low-skilled players. Many other activities captured by IMUs are also negatively impacting player performance.

Higher environmental temperature, humidity, and CO<sub>2</sub> level decrease the player's performance. Higher values of facial skin temperature, GSR, and pupil diameter, which are connected with a lower concentration, higher mental load, and stress, lower the probability of winning the future fight.

Interestingly, higher activity of the left hand (feature `emg_left_hand`) increases the chance to win the encounter, while the higher activity of the right hand (feature `emg_right_hand`) decrease this chance. A possible explanation is that more intensive keystrokes made by the left hand might correspond to shorter reaction time and more abilities used, while more intensive clicks by the right hand don't change much because one regular click is enough.

## VI. CONCLUSIONS AND FUTURE WORK

In this paper, we have proposed a sensor network architecture for data collection in the eSports domain. We have collected a dataset from professional and amateur players, including sensor data and in-game logs. To extract meaningful data from in-game events, we have proposed a method for automatic extraction and annotation of in-game encounters. We have trained several machine learning algorithms, including Gated Recurrent Unit and Transformer, to predict encounters'

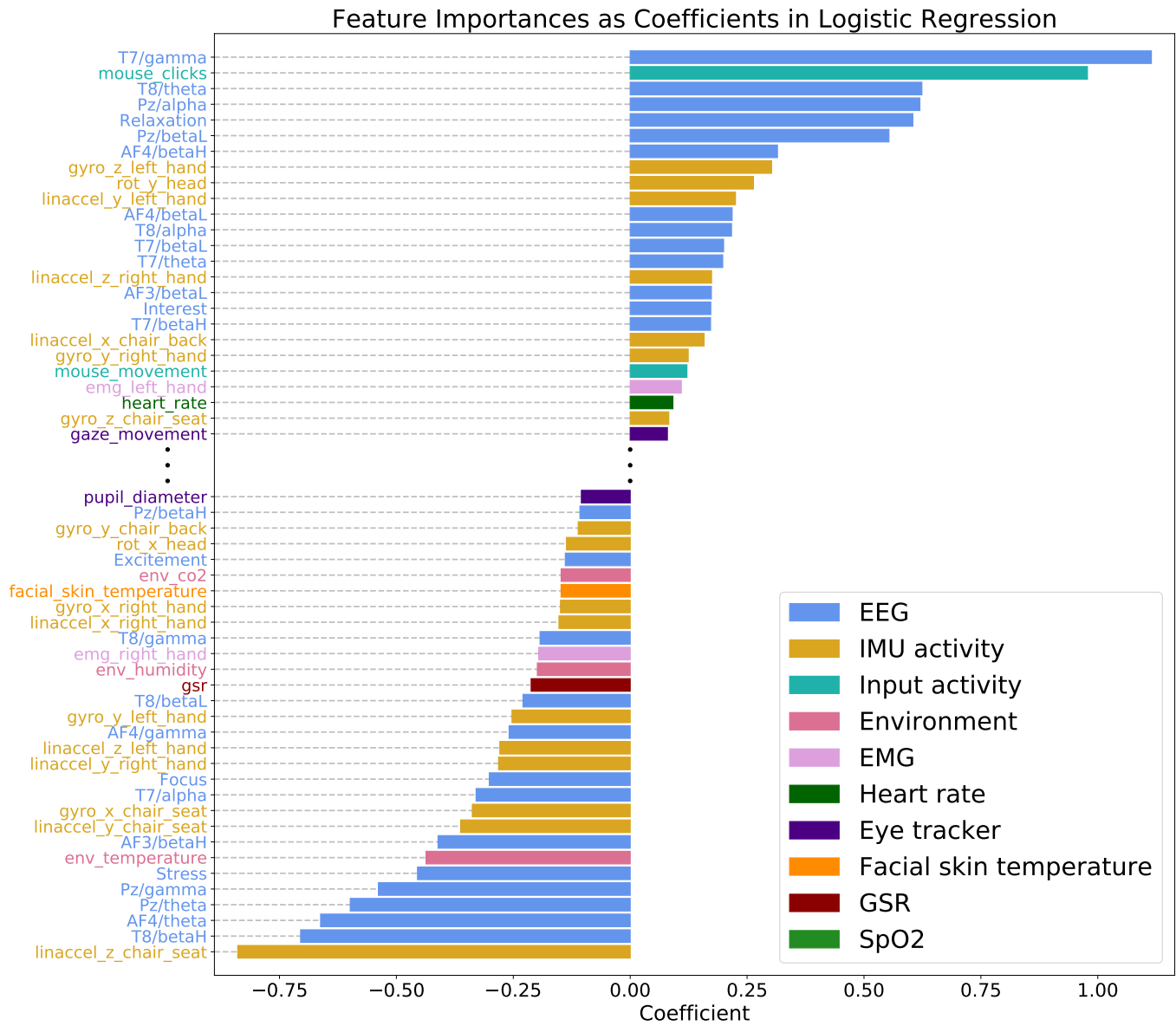

Fig. 12: Feature importances as coefficients in logistic regression model. Positive coefficients correspond to features having higher values 10 seconds before the successful fight; the opposite holds for negative coefficients. Features are colored with respect to sensors. The figure demonstrates the top-25 most positive and the top-30 most negative coefficients out of 72 features.

outcomes solely by sensor data. The best model achieves ROC AUC 0.706 in predicting if the player will win the encounter occurring 10 seconds later. We have also converted this model into a players’ burnout detection system, which can predict for each player a chance to lose the next encounter with 73.5% precision and 88.3% recall. The results have been interpreted by feature importance techniques, which allow us to identify physiological features affecting players’ performance.

The limitations of this study is a small number of participants involved and a lack of human-labeled annotation for in-game replays. Future work includes more extensive data collection with more subjects recorded, proper data annotation with professional players and coaches, and a diverse set of games analyzed. These would allow researchers to utilize more complex machine learning models and better understand

players’ physiological behavior.

ACKNOWLEDGMENT

The reported study was partially funded by RFBR (Russian Foundation for Basic Research) according to the research project No. 18-29-22077\19.

The research reported in this paper has been partially supported by the BMBF (German Federal Ministry of Education and Research) in the project HeadSense (project number 01IW18001). The support is gratefully acknowledged.

Also, the authors would like to thank the eSports club<sup>13</sup> at the University of Kaiserslautern for their contribution to methodology development and participation in data collection.

<sup>13</sup><https://www.esports-kl.de/>

## REFERENCES

- [1] Newzoo, "Global esports market report," 2020. [Online]. Available: <https://newzoo.com/insights/trend-reports/newzoo-global-esports-market-report-2020-light-version/>
- [2] G. Choi and M. Kim, "Eye-movement pattern by playing experience in combat system of fps game," pp. 52–56, 2015.
- [3] B. B. Velichkovsky, N. Khromov, A. Korotin, E. Burnaev, and A. Somov, "Visual fixations duration as an indicator of skill level in esports," in *IFIP Conference on Human-Computer Interaction*. Springer, 2019, pp. 397–405.
- [4] D. Kuposov, M. Semenova, A. Somov, A. Lange, A. Stepanov, and E. Burnaev, "Analysis of the reaction time of esports players through the gaze tracking and personality trait," in *2020 IEEE 29th International Symposium on Industrial Electronics (ISIE)*, 2020, pp. 1560–1565.
- [5] G. Choi and M. Kim, "Eye gaze information and game level design according to fps gameplay beats," *Journal of information and communication convergence engineering*, vol. 16, pp. 189–196, 2018.
- [6] Z. Minchev, G. Dukov, and S. Georgiev, "Eeg spectral analysis in serious gaming: An ad hoc experimental application," *Bio Automation*, vol. 13, no. 4, pp. 79–88, 2009.
- [7] B. Meneses-Claudio and A. Roman-Gonzalez, "Study of the brain waves for the differentiation of gamers category between a newbie and a hardcore in the game dota 1," in *2018 Congreso Argentino de Ciencias de la Informática y Desarrollos de Investigación (CACIDI)*, 2018, pp. 1–4.
- [8] A. Smerdov, A. Kiskun, R. Shaniiazov, A. Somov, and E. Burnaev, "Understanding cyber athletes behaviour through a smart chair: Cs:go and monolith team scenario," in *2019 IEEE 5th World Forum on Internet of Things (WF-IoT)*, 2019, pp. 973–978.
- [9] A. Smerdov, E. Burnaev, and A. Somov, "esports pro-players behavior during the game events: Statistical analysis of data obtained using the smart chair," in *2019 IEEE SmartWorld, Ubiquitous Intelligence Computing, Advanced Trusted Computing, Scalable Computing Communications, Cloud Big Data Computing, Internet of People and Smart City Innovation (SmartWorld/SCALCOM/UIC/ATC/CBDCOM/IOP/SCI)*, 2019, pp. 1768–1775.
- [10] N. Khromov, A. Korotin, A. Lange, A. Stepanov, E. Burnaev, and A. Somov, "Esports athletes and players: a comparative study," *IEEE Pervasive Computing*, vol. 18, no. 3, pp. 31–39, 2019.
- [11] P. M. Blom, S. Bakkes, and P. Spronck, "Towards multi-modal stress response modelling in competitive league of legends," in *2019 IEEE Conference on Games (CoG)*, 2019, pp. 1–4.
- [12] R. Kaminsky, M. Enev, and E. Andersen, "Identifying game players with mouse biometrics," *University of Washington. Technical Report*, 2008.
- [13] Z. Chen, T.-H. D. Nguyen, Y. Xu, C. Amato, S. Cooper, Y. Sun, and M. S. El-Nasr, "The art of drafting: a team-oriented hero recommendation system for multiplayer online battle arena games," in *Proceedings of the 12th ACM Conference on Recommender Systems*, 2018, pp. 200–208.
- [14] N. Kinkade, L. Jolla, and K. Lim, "Dota 2 win prediction," *Univ Calif*, vol. 1, pp. 1–13, 2015.
- [15] N. Wang, L. Li, L. Xiao, G. Yang, and Y. Zhou, "Outcome prediction of dota2 using machine learning methods," in *Proceedings of 2018 International Conference on Mathematics and Artificial Intelligence*, 2018, pp. 61–67.
- [16] A. Semenov, P. Romov, S. Korolev, D. Yashkov, and K. Neklyudov, "Performance of machine learning algorithms in predicting game outcome from drafts in dota 2," in *International Conference on Analysis of Images, Social Networks and Texts*. Springer, 2016, pp. 26–37.
- [17] L. Lin, "League of legends match outcome prediction."
- [18] A. L. C. Silva, G. L. Pappa, and L. Chaimowicz, "Continuous outcome prediction of league of legends competitive matches using recurrent neural networks," in *SBC-Proceedings of SBCGames*, 2018, pp. 2179–2259.
- [19] V. Hodge, S. Devlin, N. Sephton, F. Block, A. Drachen, and P. Cowling, "Win prediction in esports: Mixed-rank match prediction in multi-player online battle arena games," *arXiv preprint arXiv:1711.06498*, 2017.
- [20] Y. Yang, T. Qin, and Y.-H. Lei, "Real-time esports match result prediction," *arXiv preprint arXiv:1701.03162*, 2016.
- [21] K. J. Shim, K.-W. Hsu, S. Damania, C. DeLong, and J. Srivastava, "An exploratory study of player and team performance in multiplayer first-person-shooter games," in *2011 IEEE Third International Conference on Privacy, Security, Risk and Trust and 2011 IEEE Third International Conference on Social Computing*. IEEE, 2011, pp. 617–620.
- [22] Z. Yang, Z. Pan, Y. Wang, D. Cai, S. Shi, S.-L. Huang, and X. Liu, "Interpretable real-time win prediction for honor of kings, a popular mobile moba sport," *arXiv preprint arXiv:2008.06313*, 2020.
- [23] L. C. Kho, M. S. M. Kasihmuddin, M. Mansor, S. Sathasivam *et al.*, "Logic mining in league of legends," *Pertanika Journal of Science & Technology*, vol. 28, no. 1, 2020.
- [24] D.-H. Kim, C. Lee, and K.-S. Chung, "A confidence-calibrated moba game winner predictor," *arXiv preprint arXiv:2006.15521*, 2020.
- [25] M. Märtens, S. Shen, A. Iosup, and F. Kuipers, "Toxicity detection in multiplayer online games," in *2015 International Workshop on Network and Systems Support for Games (NetGames)*, 2015, pp. 1–6.
- [26] S. Adinolf and S. Turkyay, "Toxic behaviors in esports games: player perceptions and coping strategies," in *Proceedings of the 2018 Annual Symposium on Computer-Human Interaction in Play Companion Extended Abstracts*, 2018, pp. 365–372.
- [27] N. Ahmadi, G. D. Hager, L. Ishii, G. Fichtinger, G. L. Gallia, and M. Ishii, "Surgical task and skill classification from eye tracking and tool motion in minimally invasive surgery," in *International Conference on Medical Image Computing and Computer-Assisted Intervention*. Springer, 2010, pp. 295–302.
- [28] H. Yamanaka, K. Makiyama, K. Osaka, M. Nagasaka, M. Ogata, T. Yamada, and Y. Kubota, "Measurement of the physical properties during laparoscopic surgery performed on pigs by using forceps with pressure sensors," *Advances in urology*, vol. 2015, 2015.
- [29] A. Khan, S. Mellor, E. Berlin, R. Thompson, R. McNaney, P. Olivier, and T. Plötz, "Beyond activity recognition: skill assessment from accelerometer data," in *Proceedings of the 2015 ACM International Joint Conference on Pervasive and Ubiquitous Computing*. ACM, 2015, pp. 1155–1166.
- [30] M. Ershad, R. Rege, and A. M. Fey, "Automatic surgical skill rating using stylistic behavior components," in *2018 40th Annual International Conference of the IEEE Engineering in Medicine and Biology Society (EMBC)*. IEEE, 2018, pp. 1829–1832.
- [31] A. Ahmadi, D. Rowlands, and D. A. James, "Towards a wearable device for skill assessment and skill acquisition of a tennis player during the first serve," *Sports Technology*, vol. 2, no. 3-4, pp. 129–136, 2009.
- [32] A. Ahmadi, D. D. Rowlands, and D. A. James, "Investigating the translational and rotational motion of the swing using accelerometers for athlete skill assessment," in *SENSORS, 2006 IEEE*. IEEE, 2006, pp. 980–983.
- [33] J. Haladjian, D. Schlabbers, S. Taheri, M. Tharr, and B. Bruegge, "Sensor-based detection and classification of soccer goalkeeper training exercises," *ACM Transactions on Internet of Things*, vol. 1, no. 2, pp. 1–20, 2020.
- [34] O. Yuji, "Mems sensor application for the motion analysis in sports science," *Memory*, vol. 32, p. 128Mbit, 2005.
- [35] C. Ladha, N. Y. Hammerla, P. Olivier, and T. Plötz, "Climbax: skill assessment for climbing enthusiasts," in *Proceedings of the 2013 ACM international joint conference on Pervasive and ubiquitous computing*. ACM, 2013, pp. 235–244.
- [36] Y. Wang, Y. Zhao, R. H. Chan, and W. J. Li, "Volleyball skill assessment using a single wearable micro inertial measurement unit at wrist," *IEEE Access*, vol. 6, pp. 13 758–13 765, 2018.
- [37] A. Möller, J. Scherr, L. Roalter, S. Diewald, N. Hammerla, T. Plötz, P. Olivier, and M. Kranz, "Gymskill: Mobile exercise skill assessment to support personal health and fitness," in *9th Intl. Conf. on Pervasive Computing (Pervasive 2011), Video, San Francisco, CA, USA*. Citeseer, 2011.
- [38] M. Kranz, A. Möller, N. Hammerla, S. Diewald, T. Plötz, P. Olivier, and L. Roalter, "The mobile fitness coach: Towards individualized skill assessment using personalized mobile devices," *Pervasive and Mobile Computing*, vol. 9, no. 2, pp. 203–215, 2013.
- [39] M. Xochicale, C. Baber, and M. Oussalah, "Analysis of the movement variability in dance activities using wearable sensors," in *Wearable Robotics: Challenges and Trends*. Springer, 2017, pp. 149–154.
- [40] T. Yamamoto and T. Fujinami, "Hierarchical organization of the coordinative structure of the skill of clay kneading," *Human movement science*, vol. 27, no. 5, pp. 812–822, 2008.
- [41] K. Kodama, K. Ioi, and Y. Ohtsubo, "Development of a new skill acquisition tool and evaluation of mold-polishing skills," in *Proc. of the 34th Chinese Control Conference and Sice Annual Conference*, 2015, pp. 139–142.
- [42] P. M. Lehrer, D. M. Batey, R. L. Woolfolk, A. Remde, and T. Garlick, "The effect of repeated tense-release sequences on emg and self-report of muscle tension: An evaluation of jacobsonian and post-jacobsonian assumptions about progressive relaxation," *Psychophysiology*, vol. 25, no. 5, pp. 562–569, 1988.

- [43] D. C. Fowles, "The three arousal model: Implications of gray's two-factor learning theory for heart rate, electrodermal activity, and psychopathy," *Psychophysiology*, vol. 17, no. 2, pp. 87–104, 1980.
- [44] J. Taelman, S. Vandeput, A. Spaepen, and S. Van Huffel, "Influence of mental stress on heart rate and heart rate variability," in *4th European conference of the international federation for medical and biological engineering*. Springer, 2009, pp. 1366–1369.
- [45] B. Arnrich, C. Setz, R. La Marca, G. Tröster, and U. Ehlert, "What does your chair know about your stress level?" *IEEE Transactions on Information Technology in Biomedicine*, vol. 14, no. 2, pp. 207–214, 2009.
- [46] T. Mizuno, T. Sakai, S. Kawazura, H. Asano, K. Akehi, S. Matsuno, K. Mito, Y. Kume, and N. Itakura, "Measuring facial skin temperature changes caused by mental work-load with infrared thermography," *IEEE Transactions on Electronics, Information and Systems*, vol. 136, no. 11, pp. 1581–1585, 2016.
- [47] J. G. Allen, P. MacNaughton, U. Satish, S. Santanam, J. Vallarino, and J. D. Spengler, "Associations of cognitive function scores with carbon dioxide, ventilation, and volatile organic compound exposures in office workers: a controlled exposure study of green and conventional office environments," *Environmental health perspectives*, vol. 124, no. 6, pp. 805–812, 2016.
- [48] L. Lan, P. Wargocki, D. P. Wyon, and Z. Lian, "Effects of thermal discomfort in an office on perceived air quality, sbs symptoms, physiological responses, and human performance," *Indoor air*, vol. 21, no. 5, pp. 376–390, 2011.
- [49] M. Zhu, W. Liu, and P. Wargocki, "Changes in eeg signals during the cognitive activity at varying air temperature and relative humidity," *Journal of Exposure Science & Environmental Epidemiology*, vol. 30, no. 2, pp. 285–298, 2020.
- [50] F. E. Benth and C. M. I. C. Taib, "On the speed towards the mean for continuous time autoregressive moving average processes with applications to energy markets," *Energy economics*, vol. 40, pp. 259–268, 2013.
- [51] K. J. Shim, K.-W. Hsu, S. Damania, C. DeLong, and J. Srivastava, "An exploratory study of player and team performance in multiplayer first-person-shooter games," in *2011 IEEE Third International Conference on Privacy, Security, Risk and Trust and 2011 IEEE Third International Conference on Social Computing*. IEEE, 2011, pp. 617–620.
- [52] S. Narkhede, "Understanding auc-roc curve," *Towards Data Science*, vol. 26, 2018.
- [53] D. G. Kleinbaum, K. Dietz, M. Gail, M. Klein, and M. Klein, *Logistic regression*. Springer, 2002.
- [54] T. Cover and P. Hart, "Nearest neighbor pattern classification," *IEEE transactions on information theory*, vol. 13, no. 1, pp. 21–27, 1967.
- [55] K. Cho, B. Van Merriënboer, C. Gulcehre, D. Bahdanau, F. Bougares, H. Schwenk, and Y. Bengio, "Learning phrase representations using rnn encoder-decoder for statistical machine translation," *arXiv preprint arXiv:1406.1078*, 2014.
- [56] Y. Li and Y. Yuan, "Convergence analysis of two-layer neural networks with relu activation," in *Advances in neural information processing systems*, 2017, pp. 597–607.
- [57] A. Vaswani, N. Shazeer, N. Parmar, J. Uszkoreit, L. Jones, A. N. Gomez, E. Kaiser, and I. Polosukhin, "Attention is all you need," in *Advances in neural information processing systems*, 2017, pp. 5998–6008.
- [58] S. Li, X. Jin, Y. Xuan, X. Zhou, W. Chen, Y.-X. Wang, and X. Yan, "Enhancing the locality and breaking the memory bottleneck of transformer on time series forecasting," in *Advances in Neural Information Processing Systems*, 2019, pp. 5243–5253.
- [59] D. P. Kingma and J. Ba, "Adam: A method for stochastic optimization," *arXiv preprint arXiv:1412.6980*, 2014.
- [60] J. R. Hughes, "Gamma, fast, and ultrafast waves of the brain: their relationships with epilepsy and behavior," *Epilepsy & Behavior*, vol. 13, no. 1, pp. 25–31, 2008.